

Stellarators and Stellarator Physics

Dr. Timo Kiviniemi and Prof. Dr. Mathias Groth
Aalto University
School of Science, Department of Applied Physics

Outline

- **What is a stellarator?**
 - **Twisted magnetic fields and different types of stellarators**
- **(Performance-limiting) plasma transport in stellarators**
- **Advantages and disadvantages of stellarators over tokamaks ⇒ is one concept going to win the race?**
- **Field-optimized stellarators and the Wendelstein 7-X project**
- **Cost of fusion electricity**

A stellarator is magnetic confinement system based on currents solely driven by external coils

- **Conceptual advantages:**
 - Inherently steady-state
 - No current disruptions (or current-driven instabilities)
- **Drawbacks/opportunity:**
 - No guaranteed flux surfaces
 - Due to 3-D geometry, additional losses, complexity, localized heating of wall

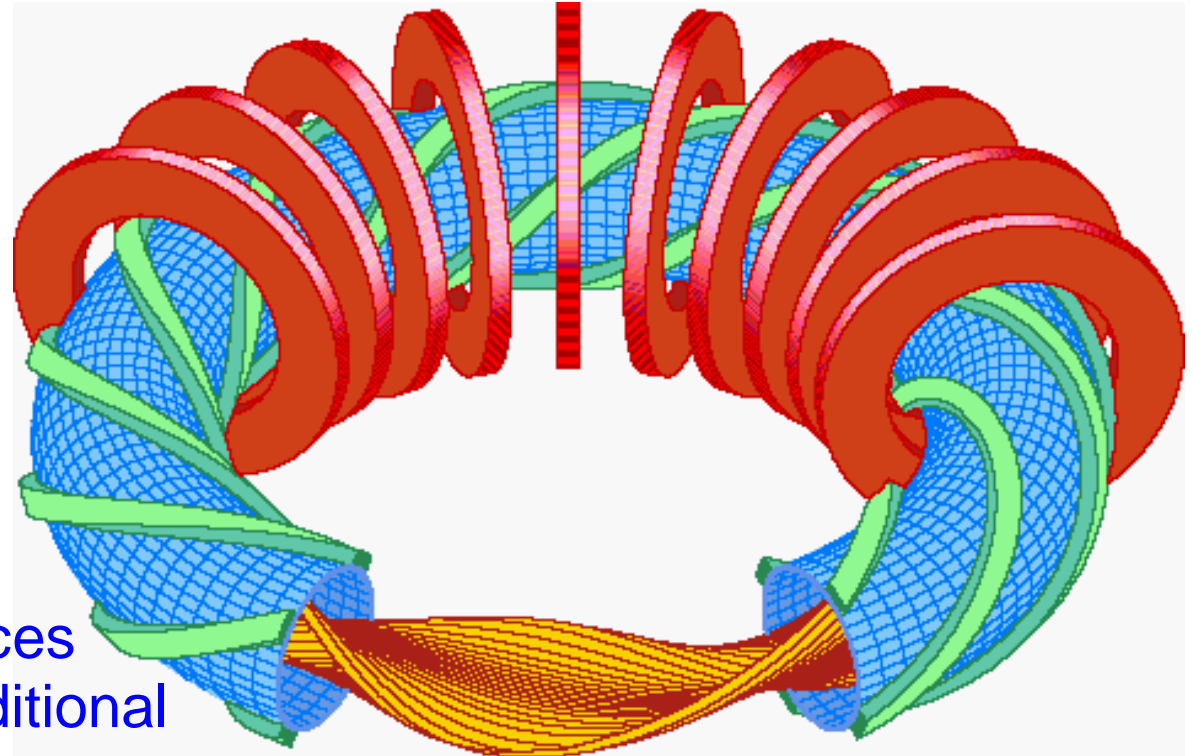

Having to deal with a full 3-D magnetic field configuration allows dedicated design of it

- **Magnetic confinement requires:**
 - Nested flux surfaces
 - Finite toroidal transform

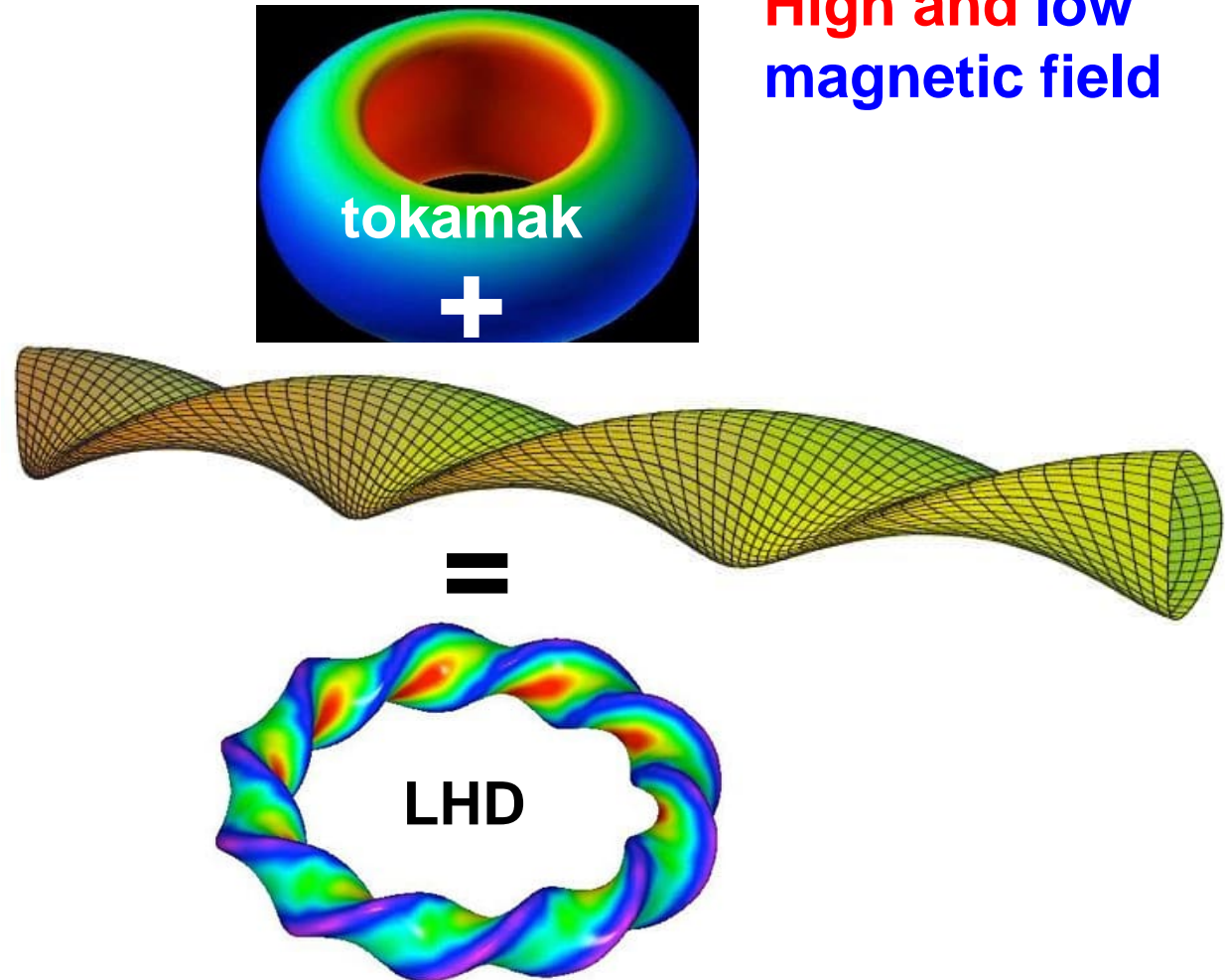

In a tokamak toroidal symmetry is preserved, in stellarators imposed

Tokamak

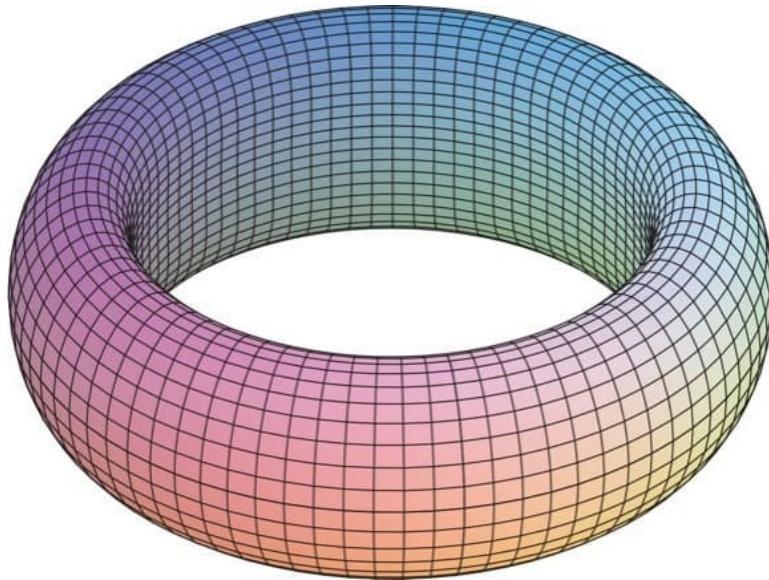

- **Axisymmetry**

Stellarator

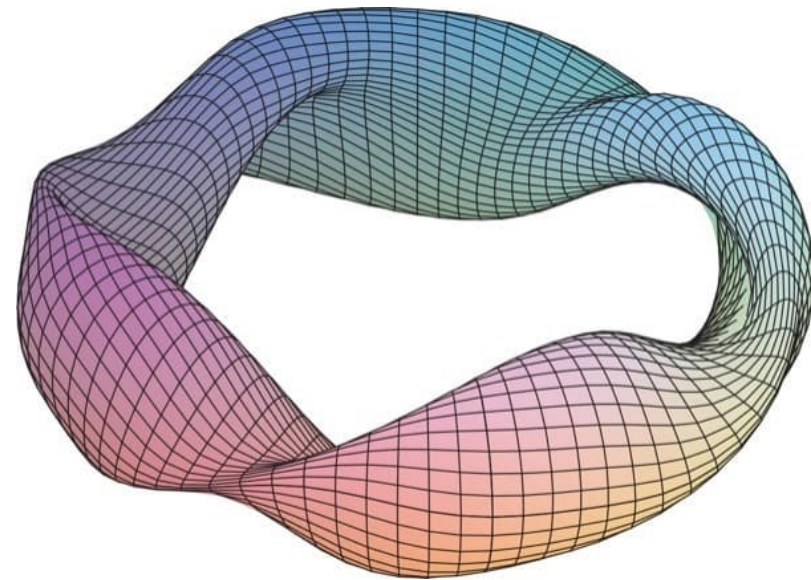

- **Periodicity $\varphi \rightarrow \varphi + 2\pi/P$**
(P: number of field periods)
- **Stellarator (flipping) symmetry: $(\varphi, \theta) \rightarrow (-\varphi, -\theta)$**

Tokamaks and stellarators produce two different types of rotational transforms

Tokamak

- transform produced by plasma current
- transform **decreases with radius** (safety factor increases)
- **Axisymmetric**

plasma current

- **2-D configuration**
- Current-driven instabilities and disruptions
- Pulsed

Stellarator

- transform produced by external coils
- transform **increases with radius**

no externally driven TOTAL toroidal current

- **3-D configuration by definition \Rightarrow complex, prone to higher radial transport losses**
- **No disruptions**
- **Steady-state**

Magnetic confinement in a stellarator is toroidally asymmetric

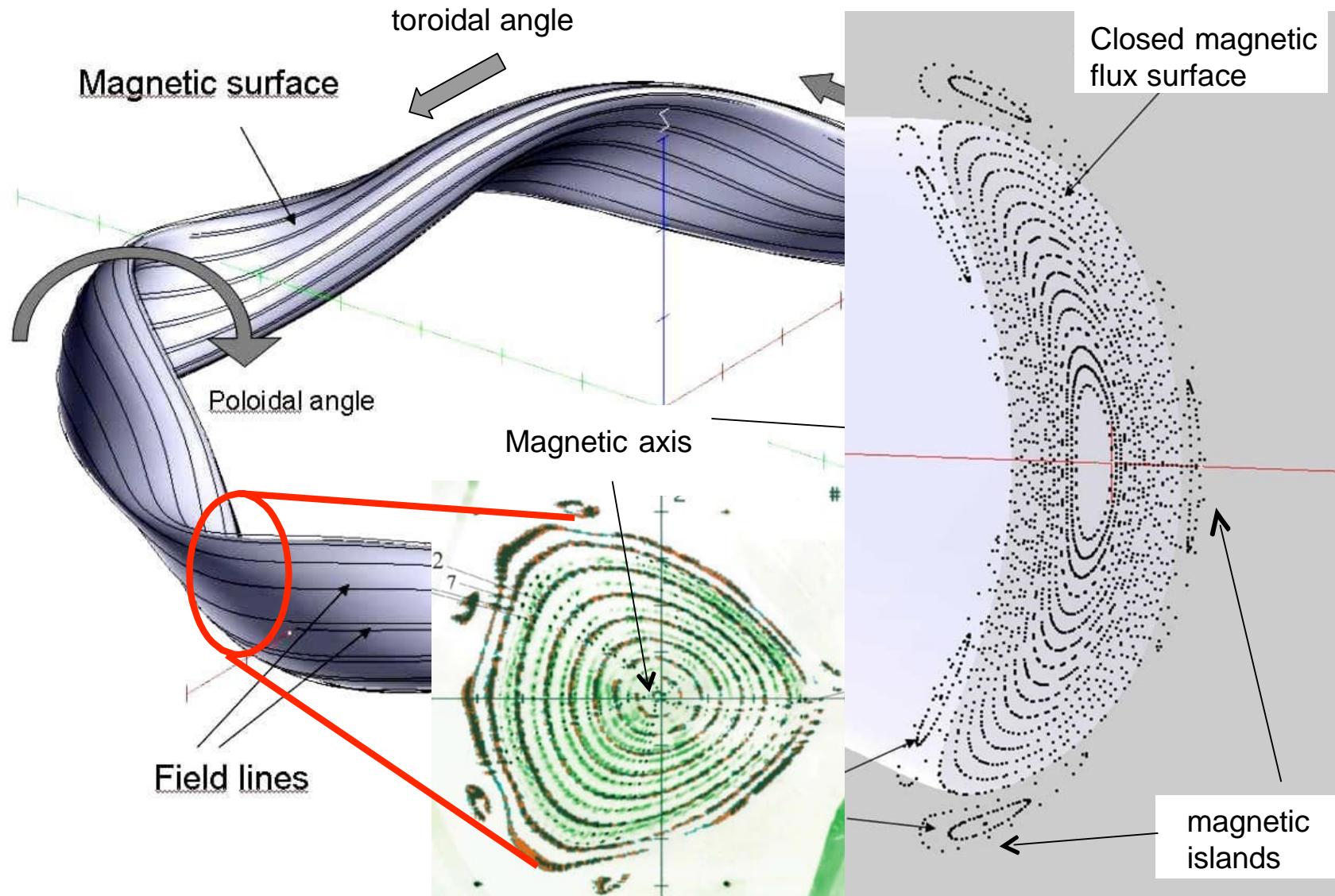

Closed field lines exist at rational values of m toroidal and n poloidal transit $i/2\pi = m/n$

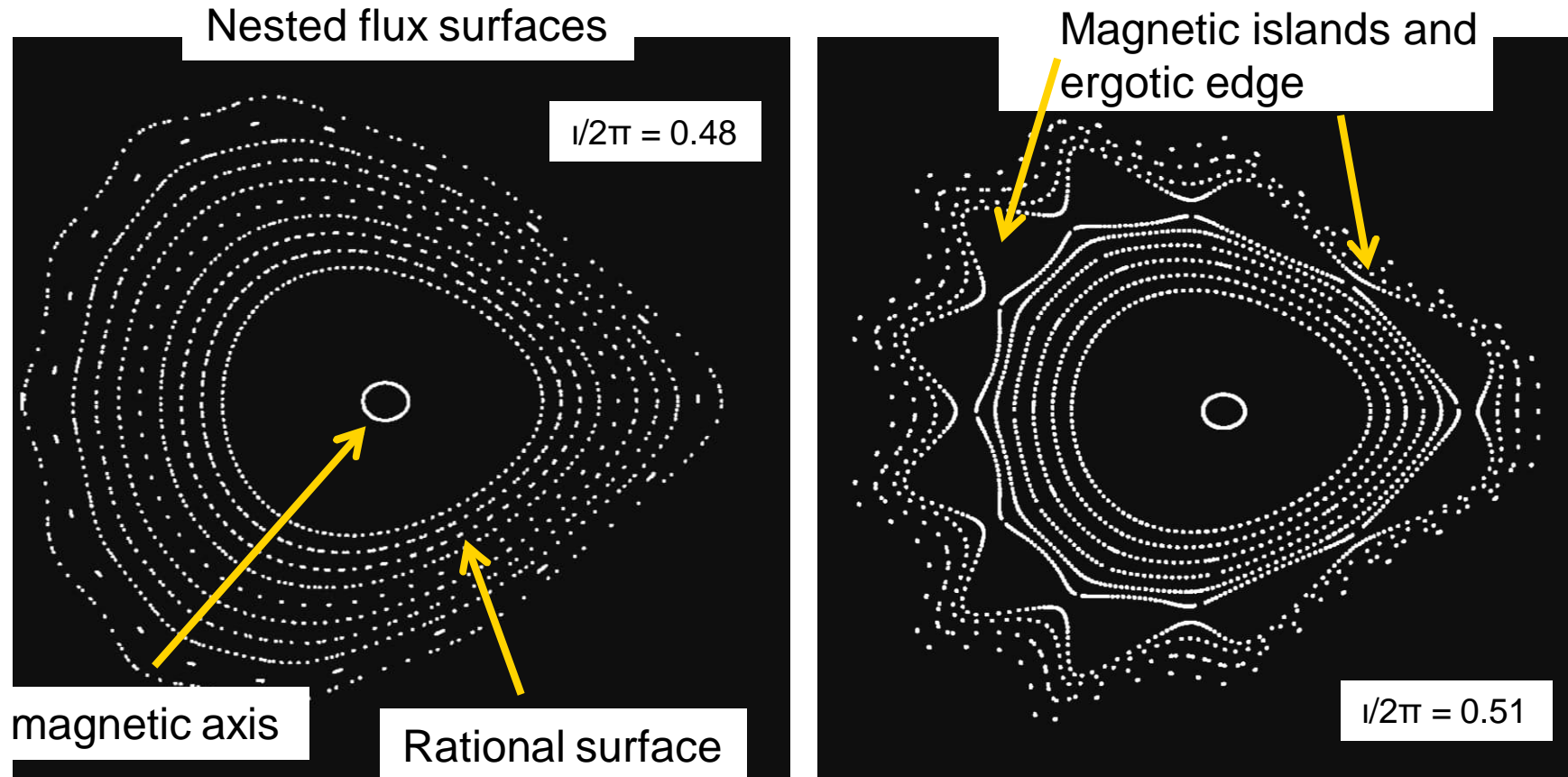

- **Rotational transform:** $R \langle B_\theta \rangle / r_{\text{eff}} \langle B_\phi \rangle$
 - Local pitch angle may vary strongly on flux surface

The stellarator equilibrium can be derived from the standard MHD equations

- **Equations**
(as for tokamaks):

$$\begin{aligned}\mathbf{j} \times \mathbf{B} &= \nabla p \\ \nabla \times \mathbf{B} &= \mu_0 \mathbf{j} \\ \nabla \cdot \mathbf{B} &= 0\end{aligned}$$

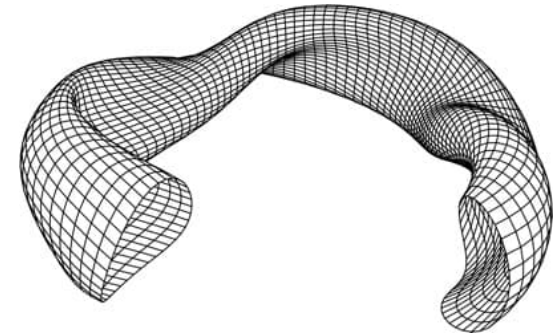

- **Equilibrium determined by:**
 - Radial profiles (e.g., pressure, total toroidal current $J=0$)
⇒ Outer flux surface can be parameterized (in cylindrical coordinates (R, Z, Φ) with periodic conditions
- **Boundary conditions: \mathbf{B} tangential to surface**
⇒ **Solution of MHD equations inside surface**

Field lines can be visualized using an electron beam in a hydrogen gas

IPP



Wendelstein 7-AS

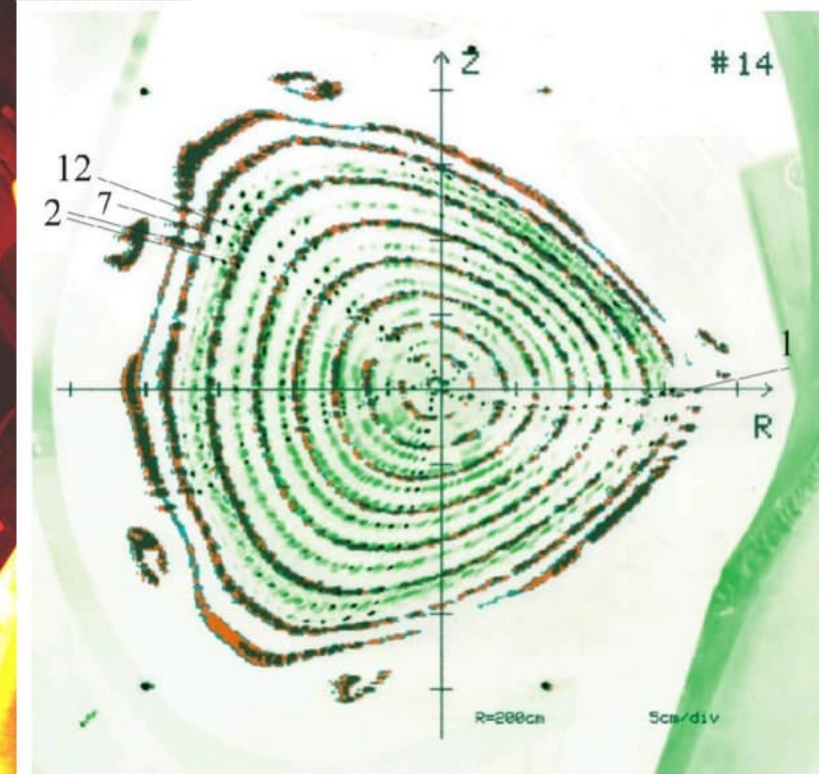

- Structures of magnetic field: shear, island, ergodic regions \Rightarrow **shortcuts of transport to wall**

There is generally no analytic proof of existence of flux surfaces in helical devices \Rightarrow field line tracing

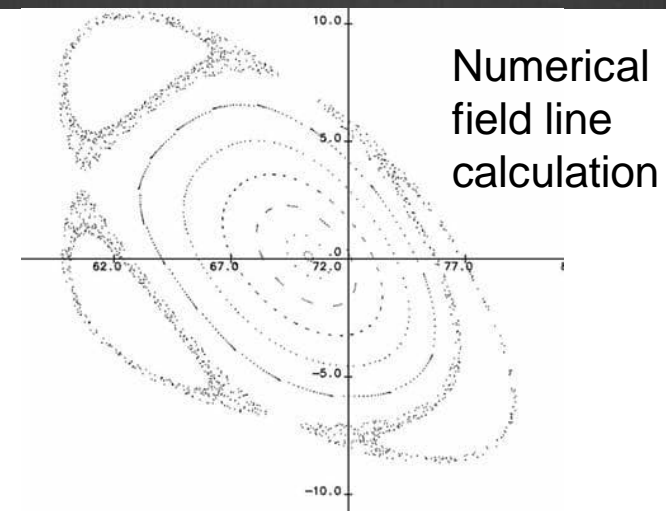
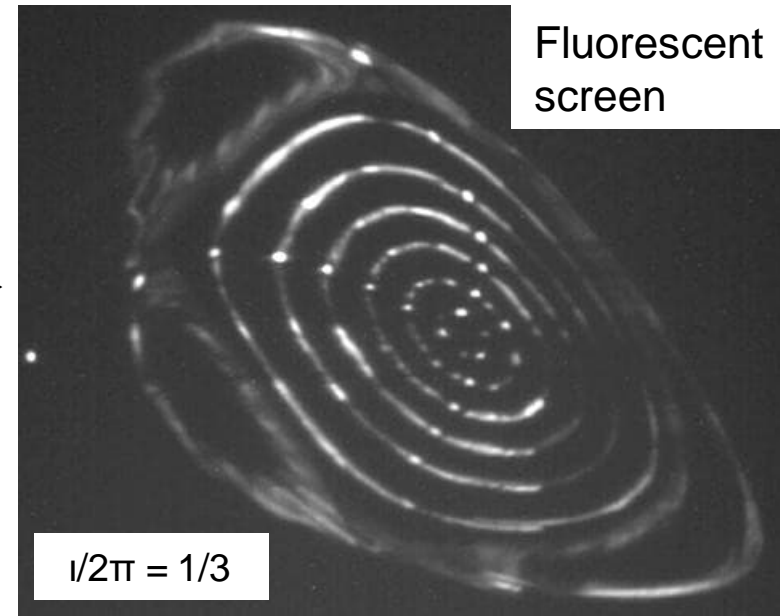
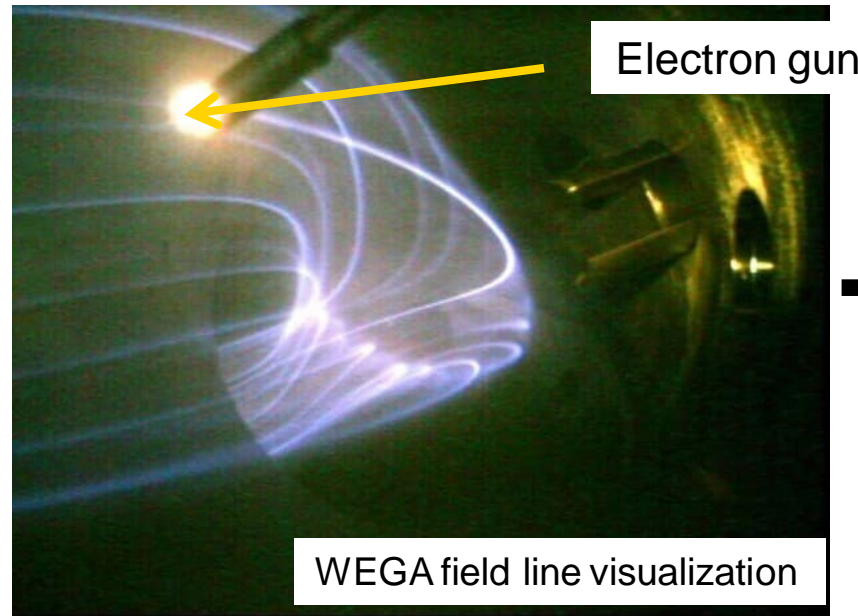

- **Electrons emitted parallel to B in vacuum field without plasma \Rightarrow fluorescent projector and interaction with (Ar) background gas**

Three basic types of stellarators

All helical confinement concepts revolve around the question of how to build 3D toroidal flux surfaces

- **Three basic types of systems**
 - Heliotrons, “classical” stellarators, heliacs
 - **Principle research questions are very similar**
 - Design vacuum field (and coils) w/ good flux surfaces
 - Reduce particle losses (drifts) in 3D geometry (fast particles, neoclassical transport, trapped particles) ⇒ similar to tokamaks
 - Operation at maximum density (and pressure)
- ⇒ **For steady-state, additional issues, such as power exhaust and impurity control exist**
- ⇒ **Second-generation stellarators include modular coils**

Twisting the torus and hence magnetic field produced helicity (Princeton Figure-8 stellarator)

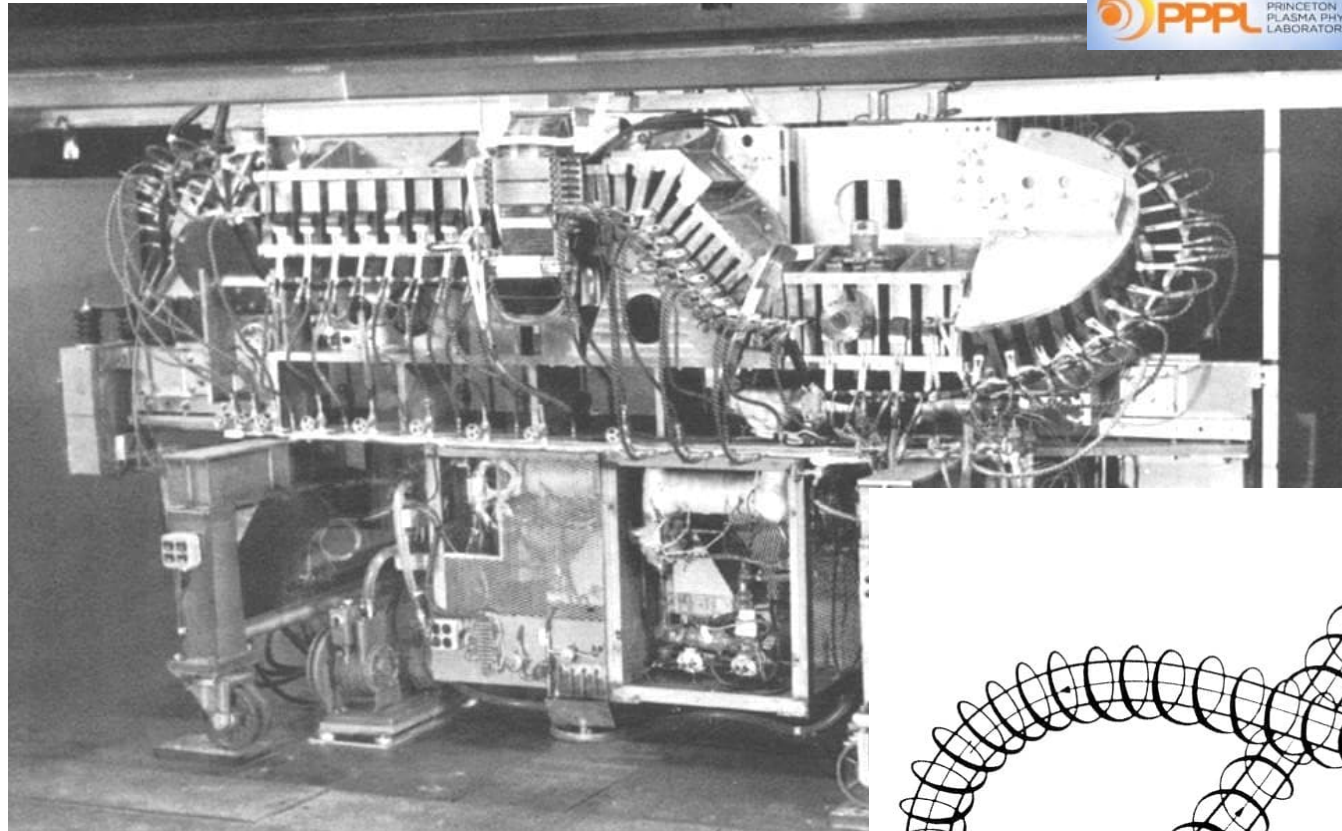

- **Proposed by Lyman Spitzer in 1951 ⇒ poor confinement**

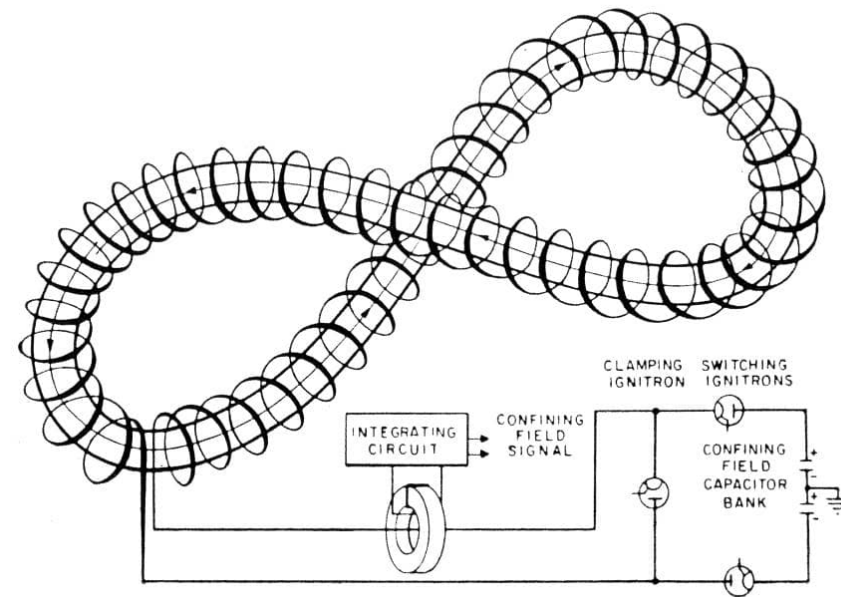

A heliotron, or torsatron, is a stellarator with a circular axis and helically twisted coils

$l=2$: LHD-type

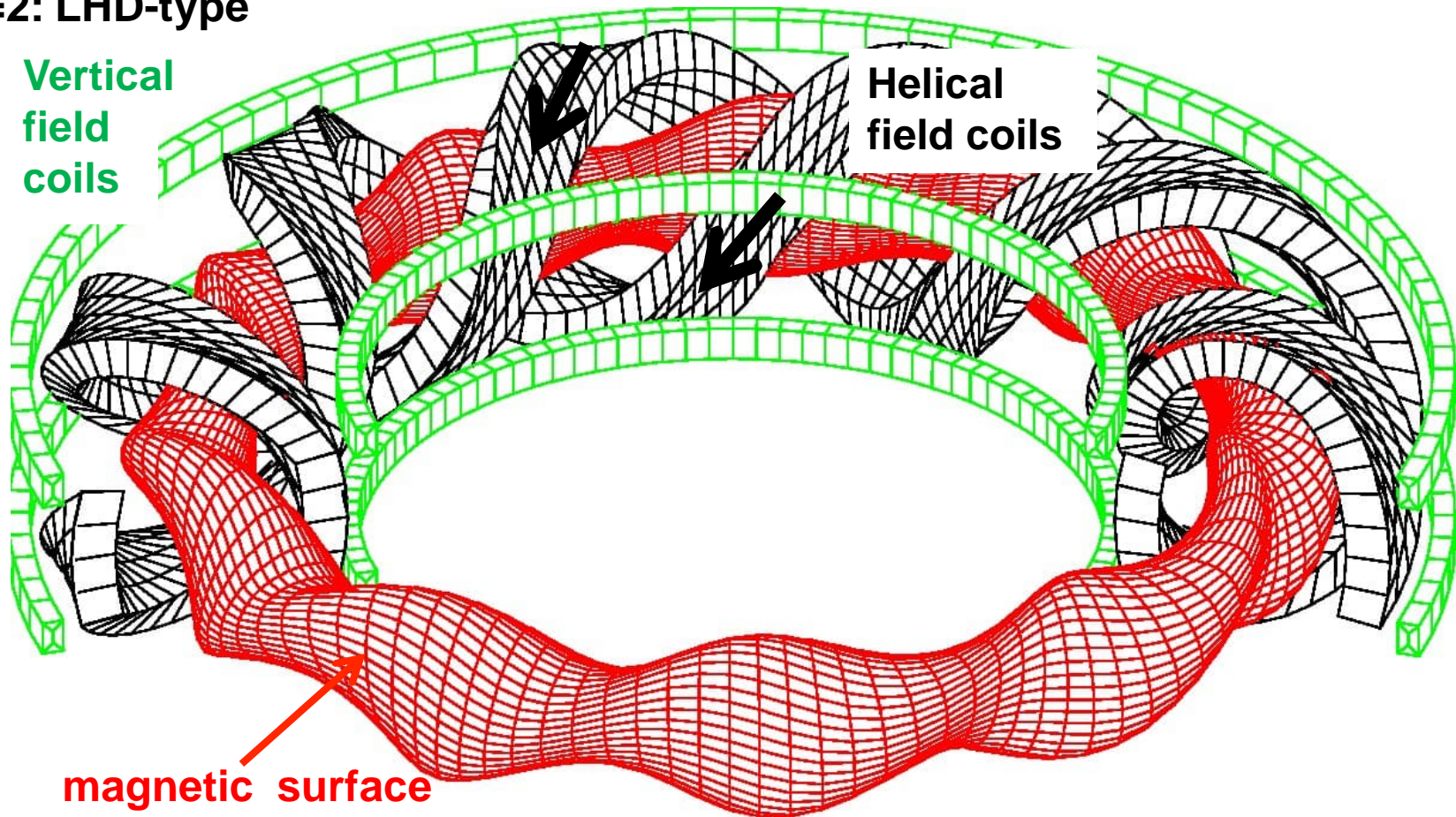

Vertical field is needed to counteract the helical field

The Large Helical Device (LHD) is an example of an heliotron

- **LHD dimensions: $R=3.5$ to 4.1 m, volume= 28 m³**
- **Primary device and line of stellarator research in Japan**

Helical coils, superconducting

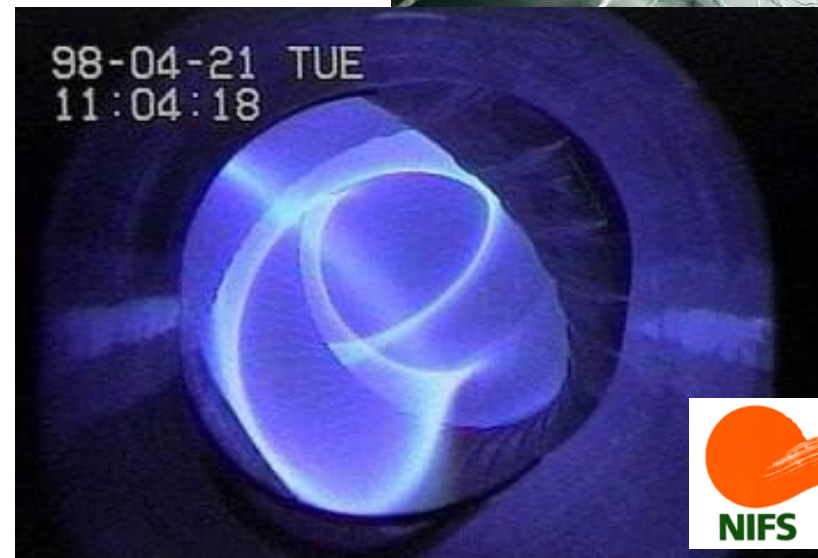
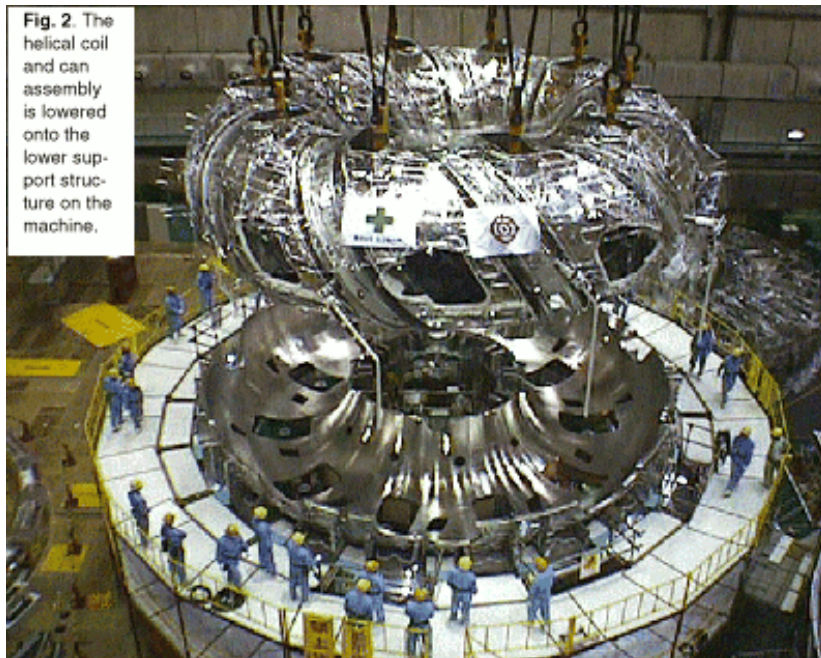

The previous Wendelstein 7-A stellarator used both helical and toroidal coils (classic stellarator)

- Wendelstein 7-A dimensions: $R=2$ m, $a=10$ cm, $I=2$, $m=5$, volume $\ll 1$ m³
- [Wendelstein family: WEGA, W7-A, W7-AS, W7-X]

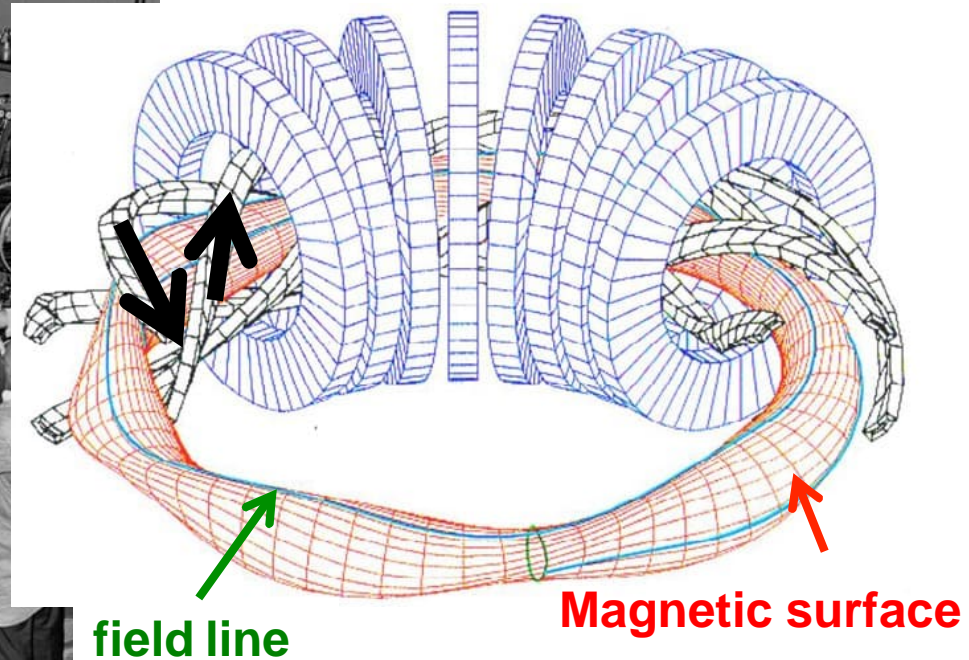
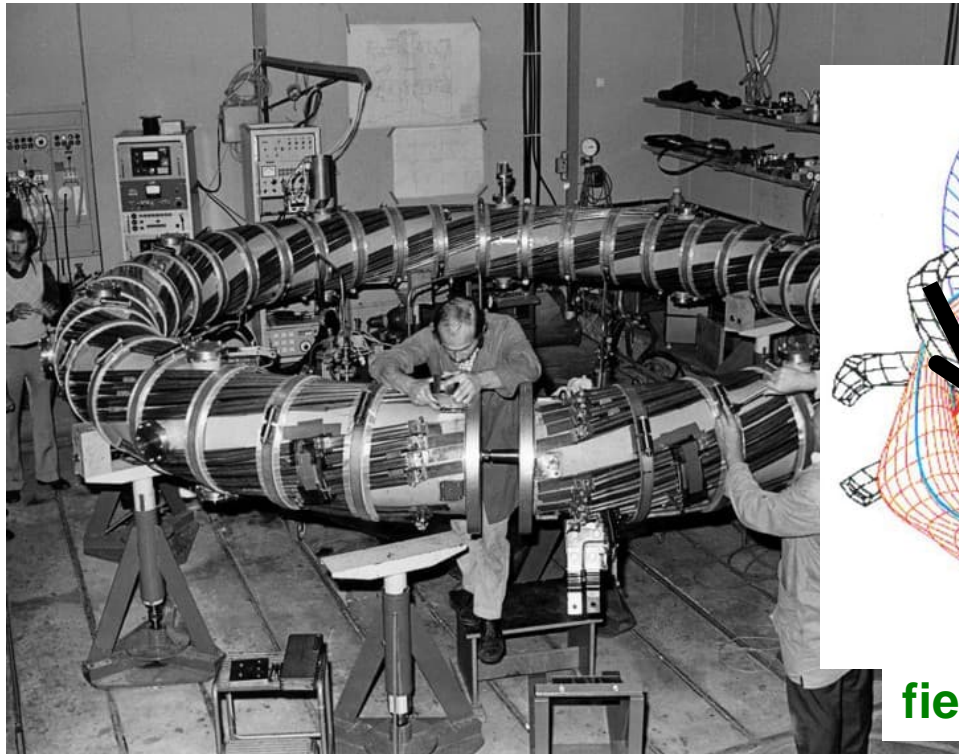

In a heliac (TJ-II, CIEMAT, Spain) the plasma is wound around a single central conductor

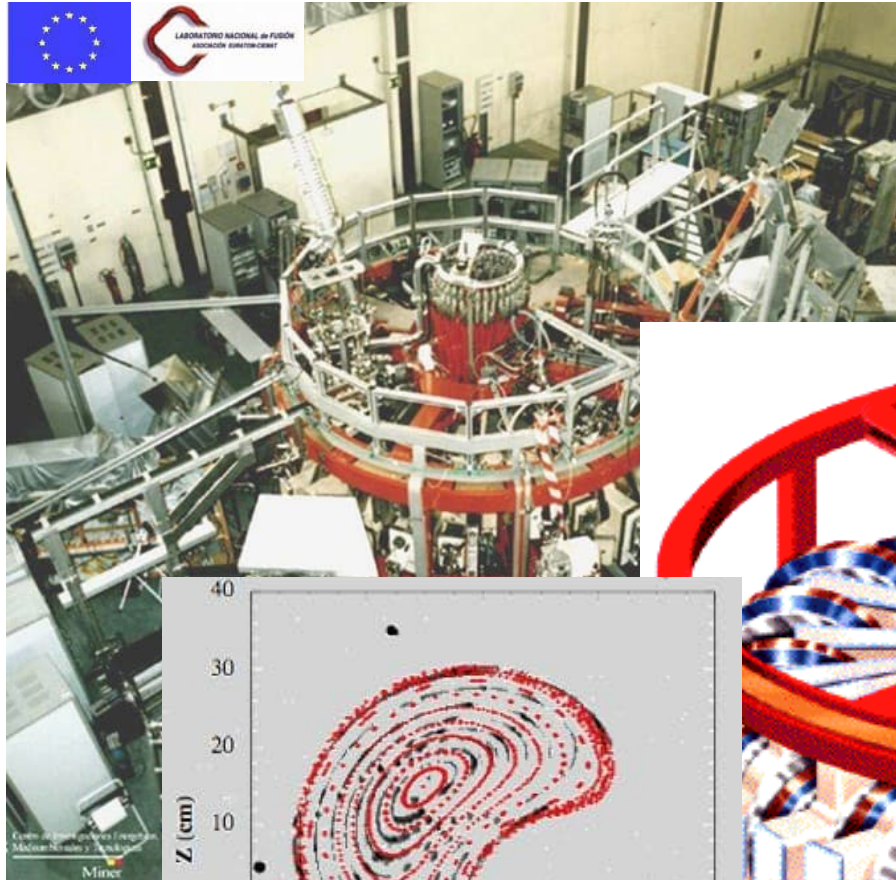

- Resulting field almost helical (like a straight stellarator)

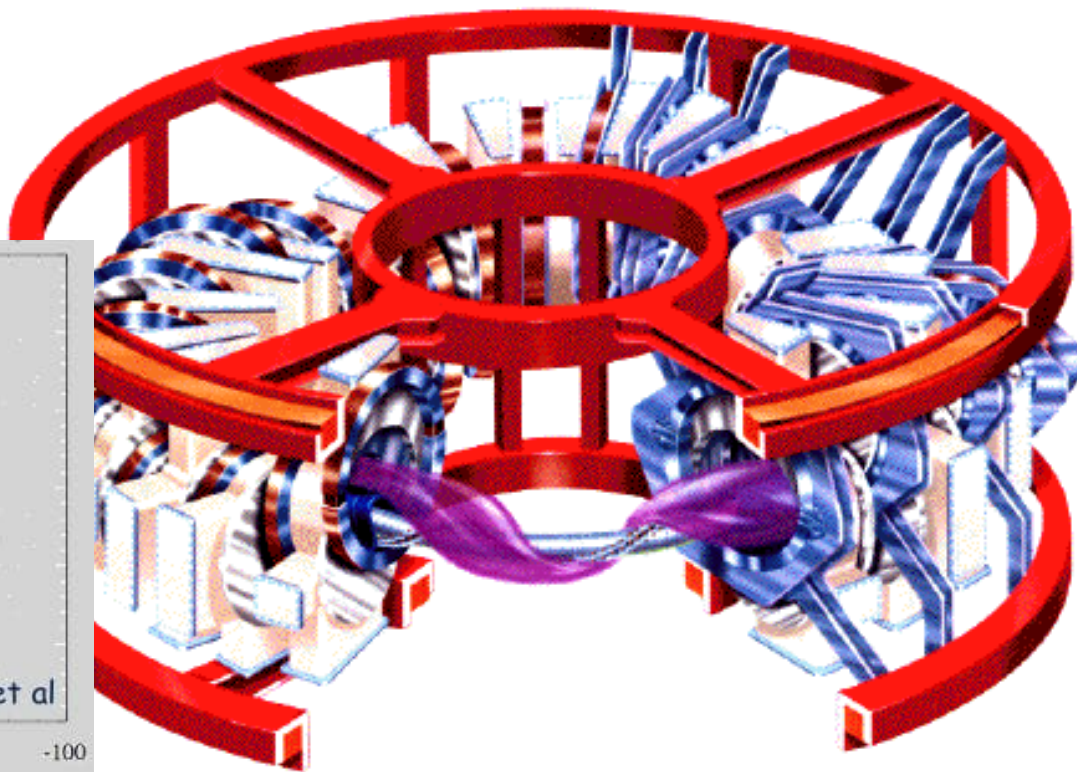
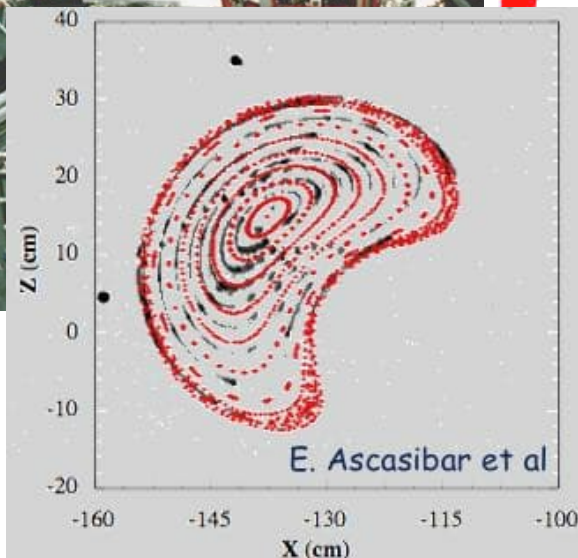

Islands in the edge can be used for energy and particle exhaust

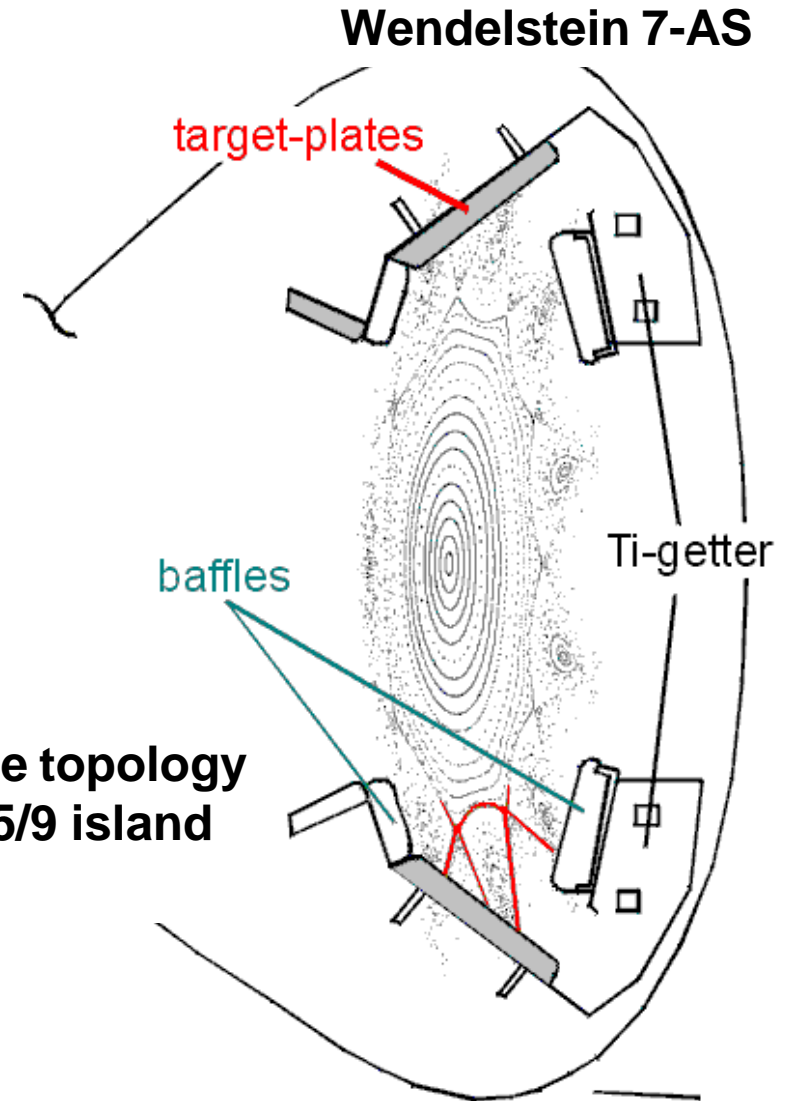
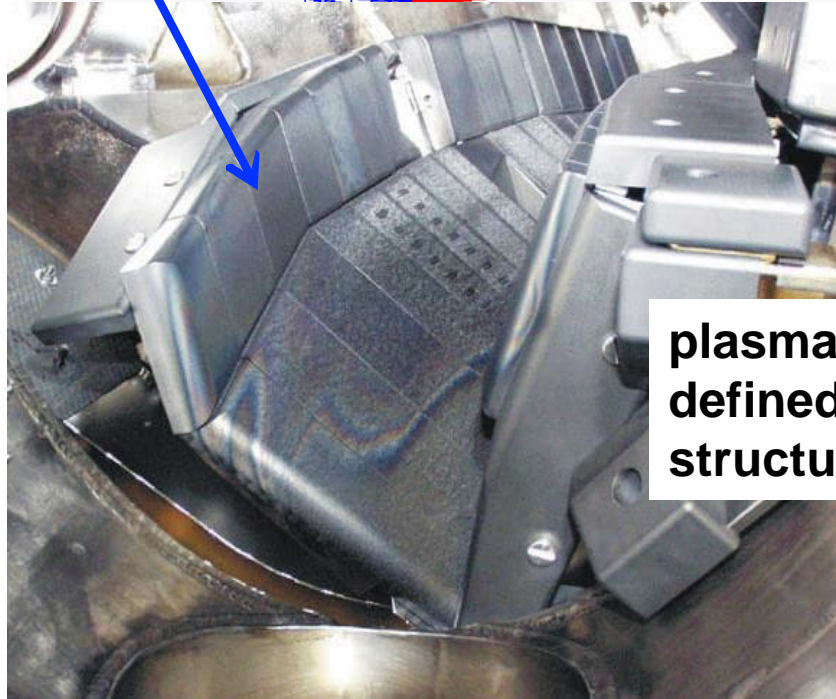
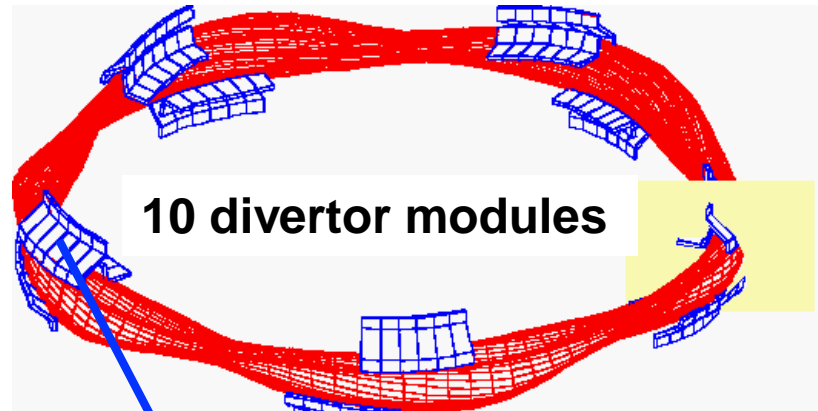

The island structure was observed with a toroidally viewing camera system

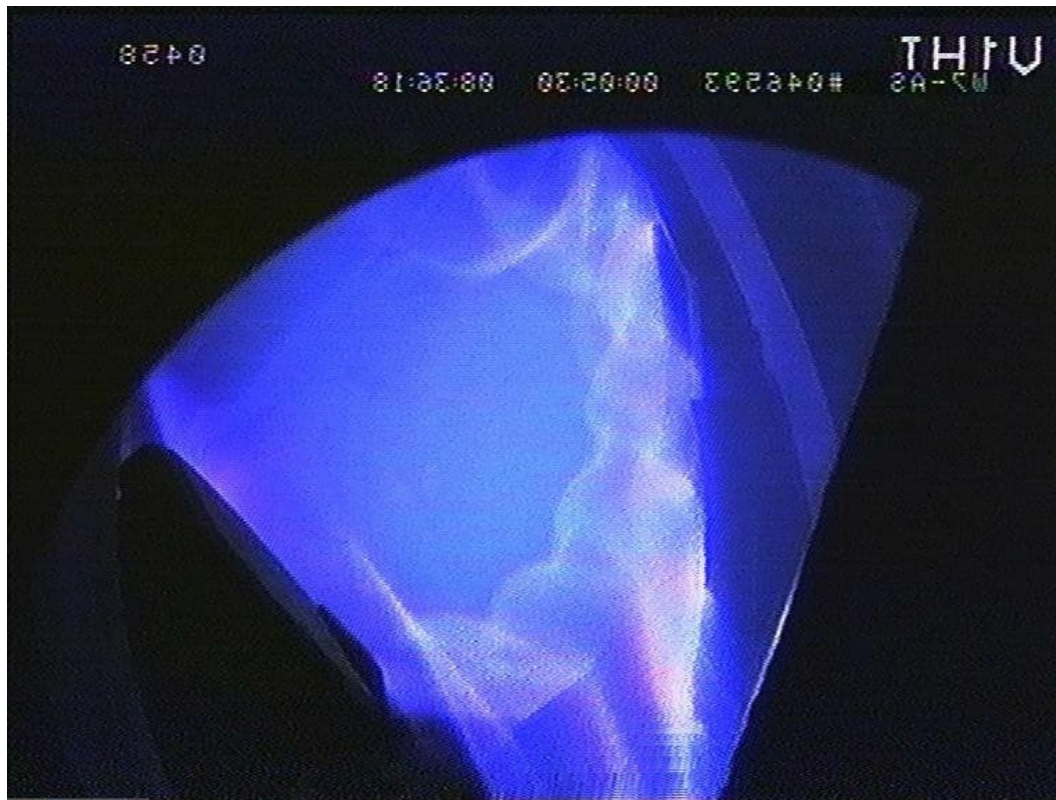

Wendelstein 7-AS

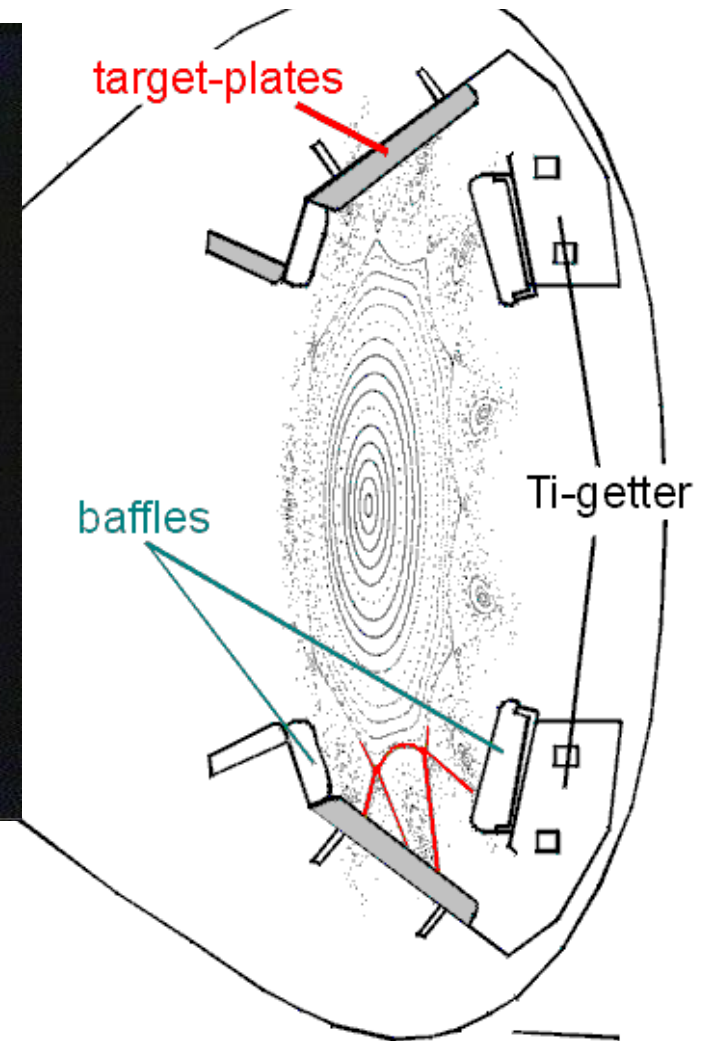

Plasma edge topology defined by 5/9 island structures

Transport processes in stellarators

Orbit drifts (in an inhomogeneous magnetic field) lead to losses of particles and energy

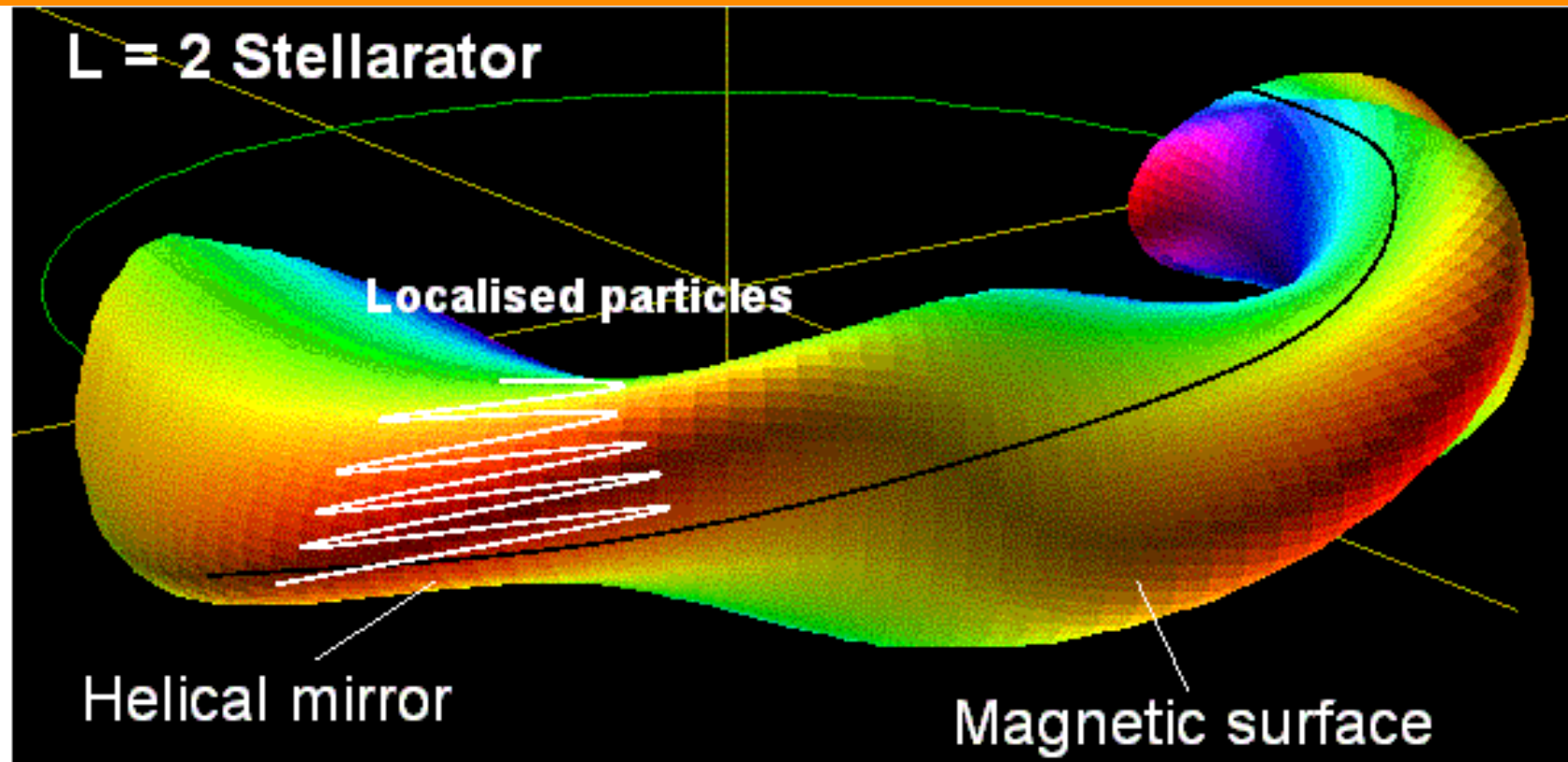

- **Stellarators have more classes of trapped particles than tokamaks**
⇒ **(Diffusive) neoclassical transport of particles = losses**

Stellarators require a strong reduction of radial convective transport to be high-performing

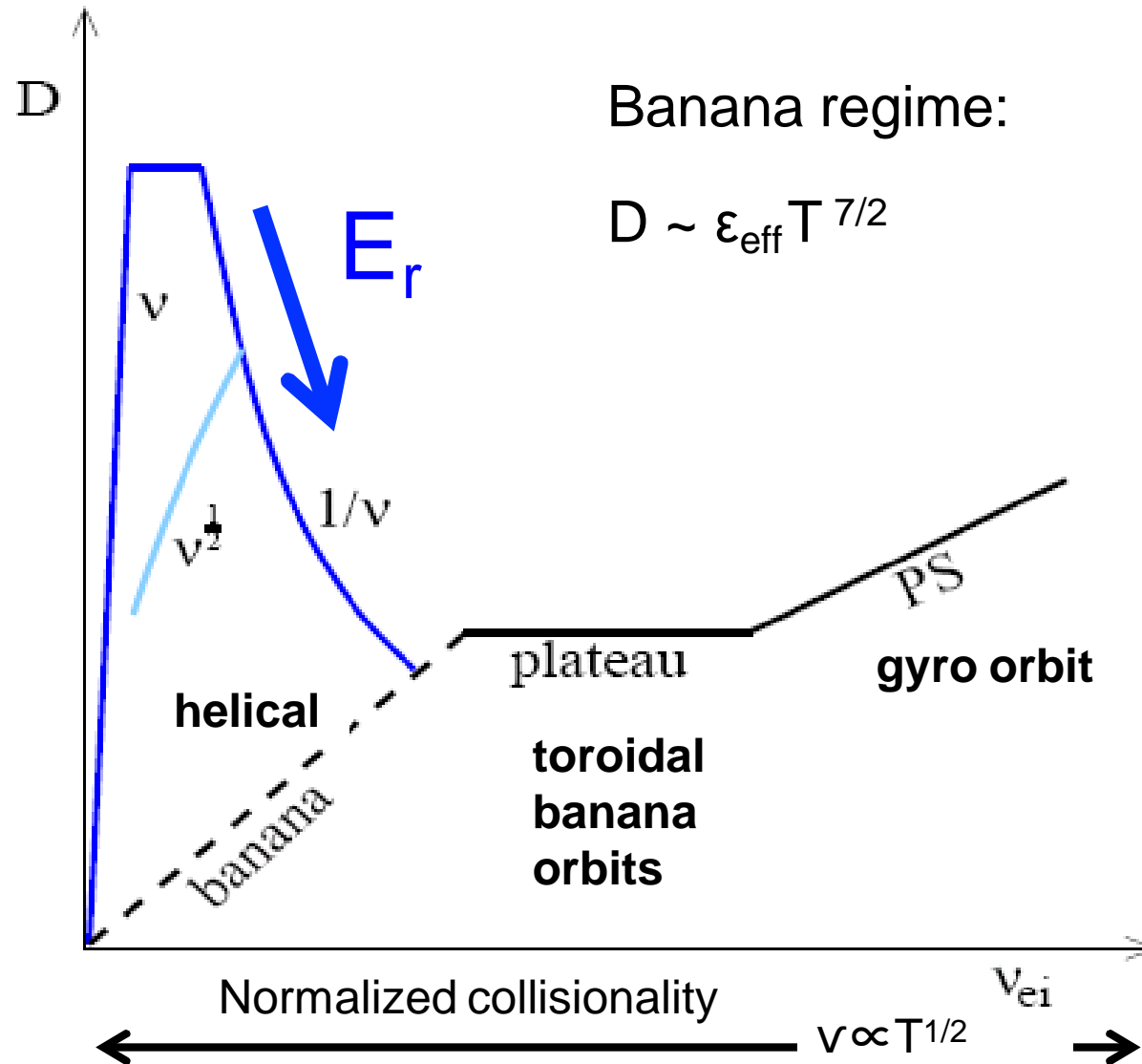

Banana regime:

$$D \sim \epsilon_{\text{eff}} T^{7/2}$$

- Diffusion in low collisionality regime is large (ripple trapped particles)
- Radial electric field leads to de-trapping of via ExB drifts

⇒ Optimization of B-field (ϵ_{eff}) ⇒ linked mirror concept)

With increasing radial electric field (de-trapping), cross-field transport can be reduced at low collisionality

W7-AS $t = 0.35$ Configuration

Normalized D to equiv. tokamak

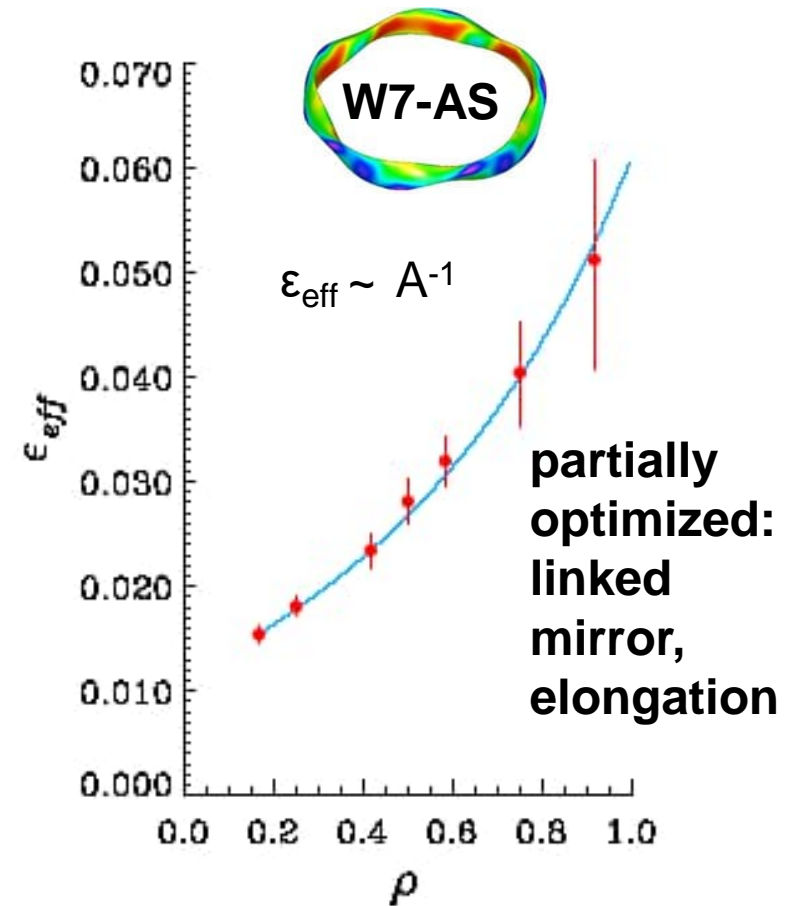
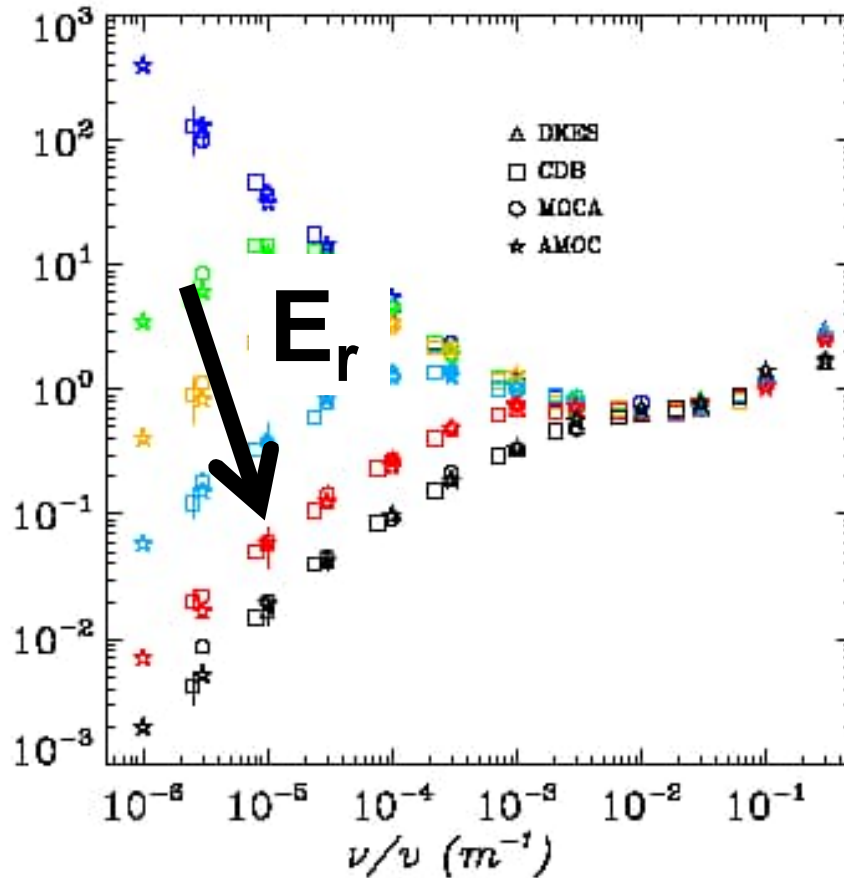

$$|E|/vB_0 = 3 \times 10^{-3} \quad 1 \times 10^{-3} \quad 3 \times 10^{-4} \quad 1 \times 10^{-4} \quad 3 \times 10^{-5} \quad \text{zero}$$

In a drift-optimized stellarator (Wendelstein 7-X), neoclassical diffusion is significantly reduced

W7-X Standard Configuration

Normalized D to equiv. tokamak

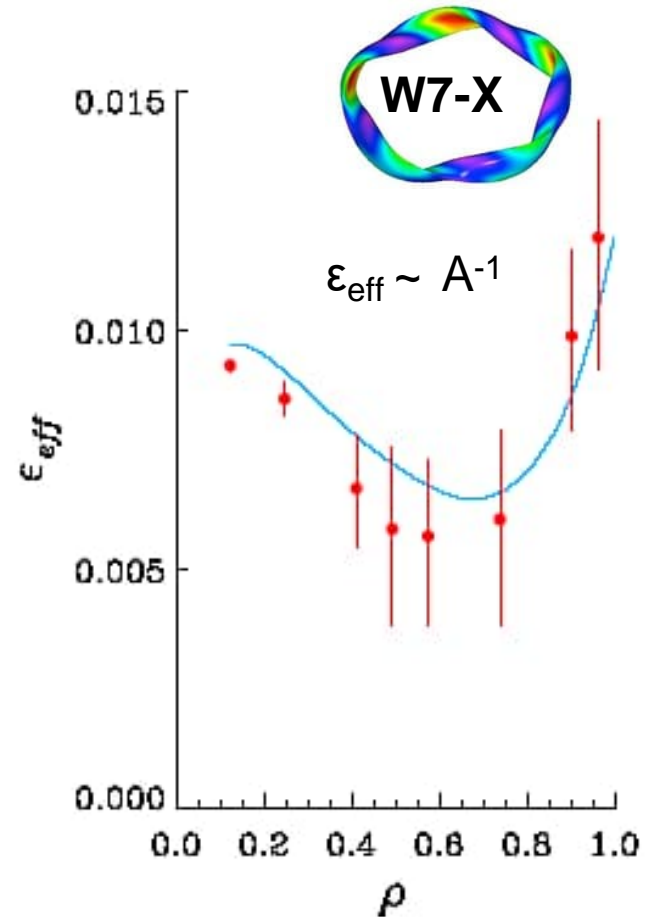
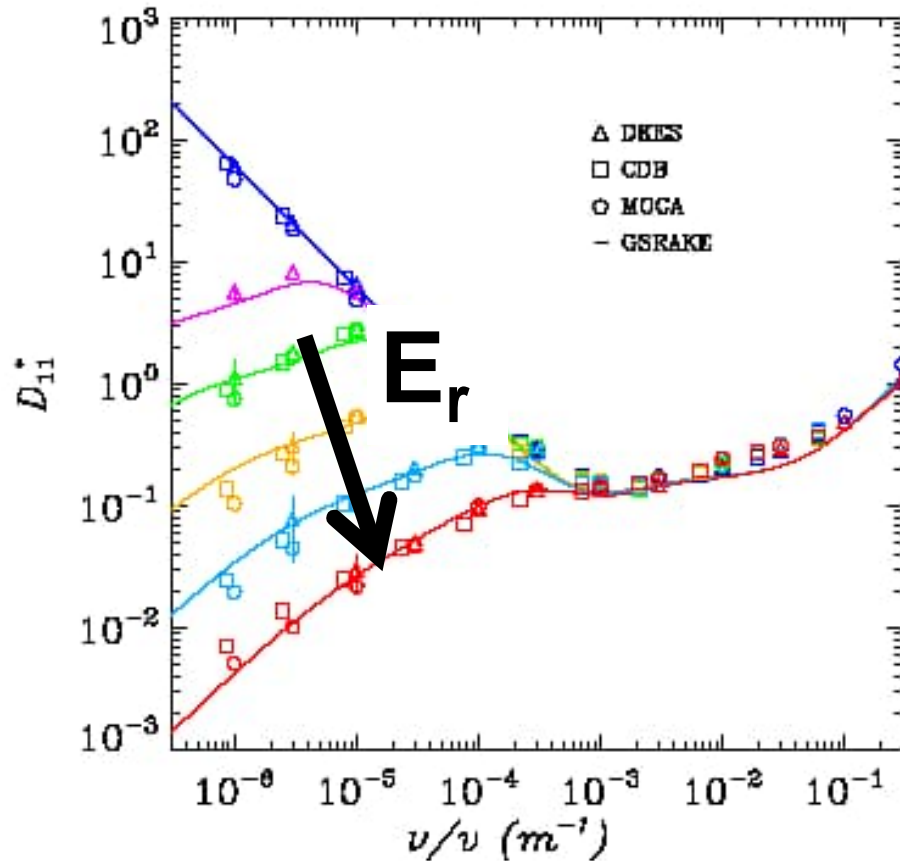

$$|E|/vB_0 = 1 \times 10^{-3} \quad 3 \times 10^{-4} \quad 1 \times 10^{-4} \quad 3 \times 10^{-5} \quad 1 \times 10^{-5} \quad \text{zero}$$

Superdense core plasmas have been obtained in the LHD stellarator

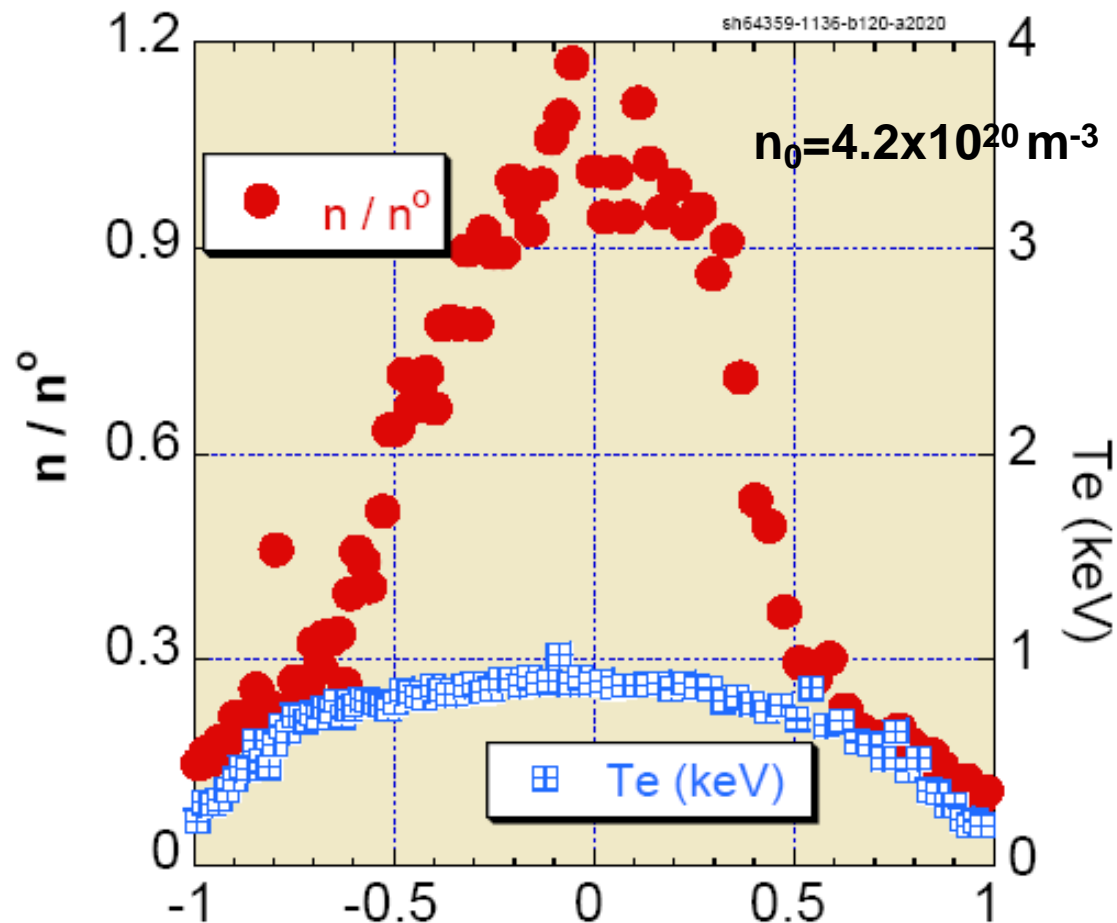

- **High-density operation is preferable also in stellarators:** fusion yield, confinement, low edge temperatures
 - **Stellarators have no disruptive density limit**
- ⇒ **Yet, operation still require density and impurity control**

H-mode confinement and edge localized modes were also observed in stellarators (W7-AS)

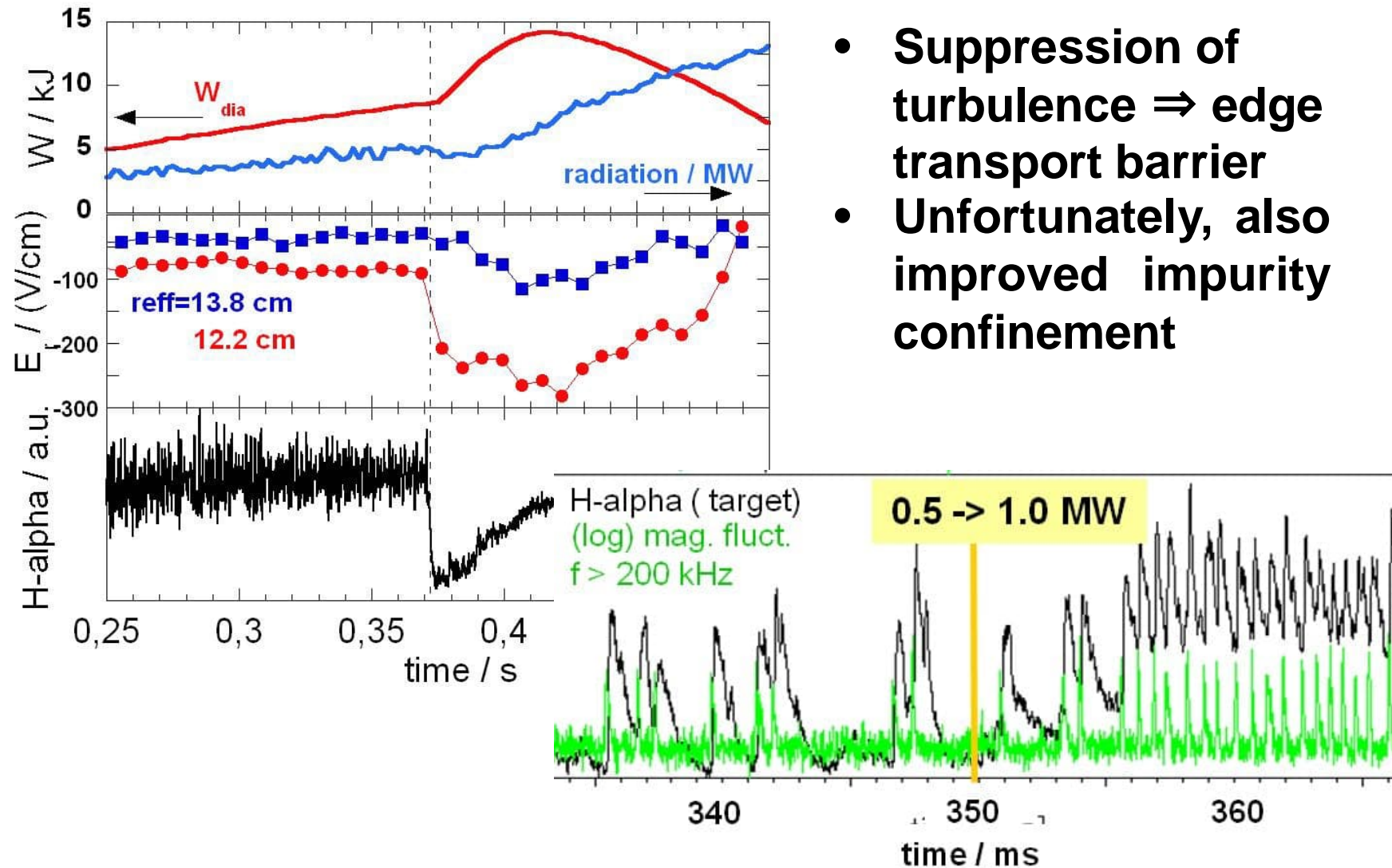

- **Suppression of turbulence \Rightarrow edge transport barrier**
- **Unfortunately, also improved impurity confinement**

Presemo quiz #1

<https://presemo.aalto.fi/fet/>

Toward future stellarator reactors

To make stellarators successful, one needs to minimize transport losses

- **Steady-state capability** without need for current drive
⇒ no current disruption
- **Maintain confining field and divertor island structures** even at high pressure
- **High-density operation:** no density limit like in tokamaks
- **Collisional losses:** fast particles, neoclassical transport, turbulence and flows

⇒ **Option: design an optimized magnetic configuration**

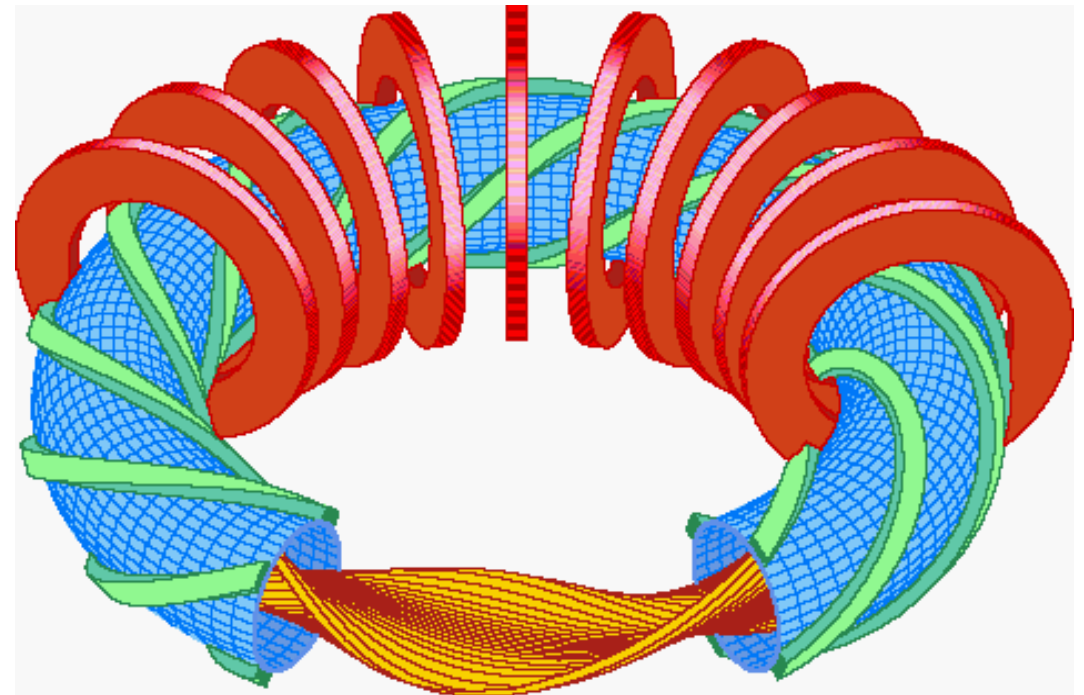

Modular coils give wider accessible Fourier distribution of currents, and 3-D shaping of axis

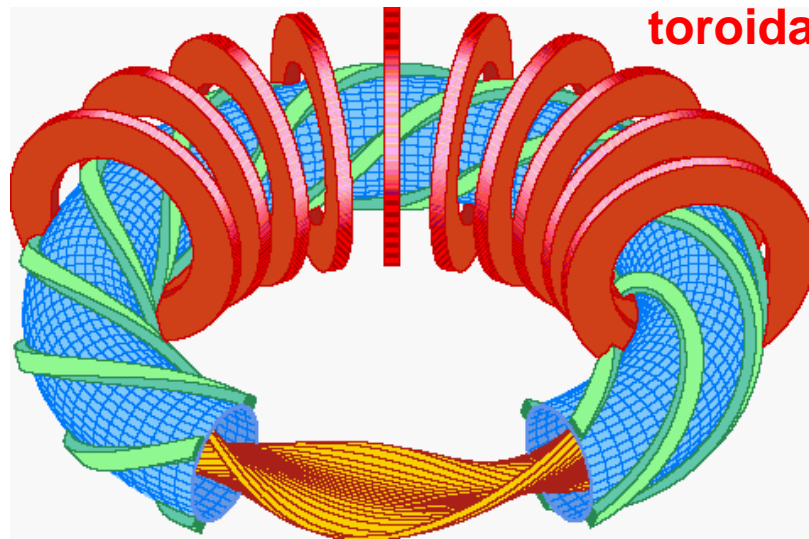

toroidal field coils

helical field coils

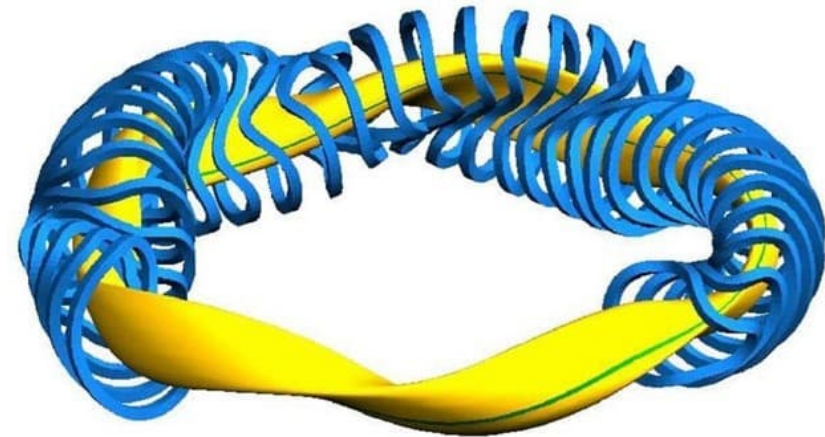

modular coils

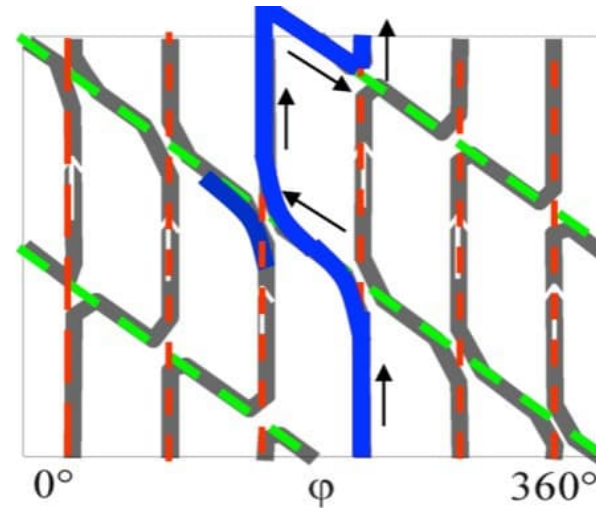
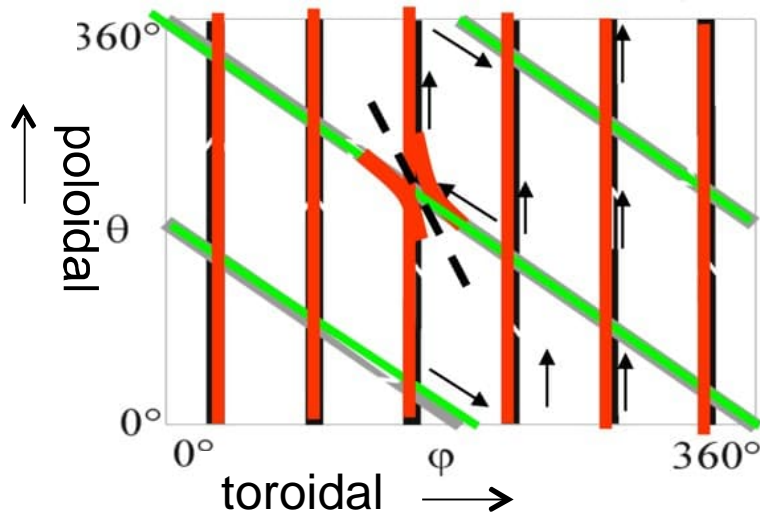

The Wendelstein 7-X is the first optimized superconducting stellarator

- HELIAS (“pure stellarator”) ⇒ drift-optimized

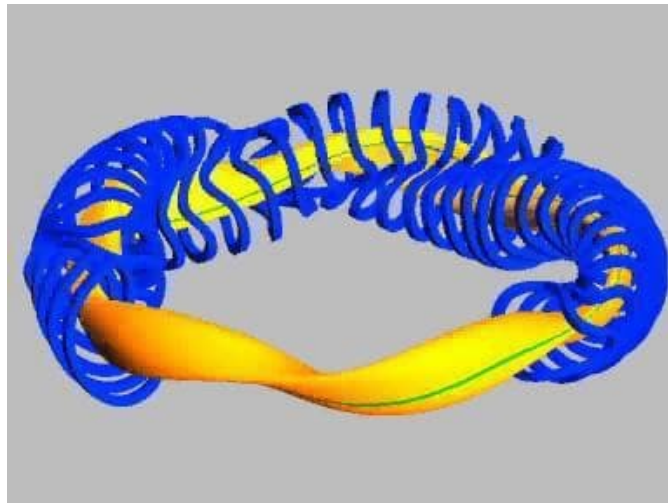

- $R=5.5$ m, $a=0.52$ m,
 $V_{\text{plasma}} \sim 30$ m³
(vs JET 3/1/100 and ITER 6/2/840)

- Fully cooled in-vessel components and island divertor

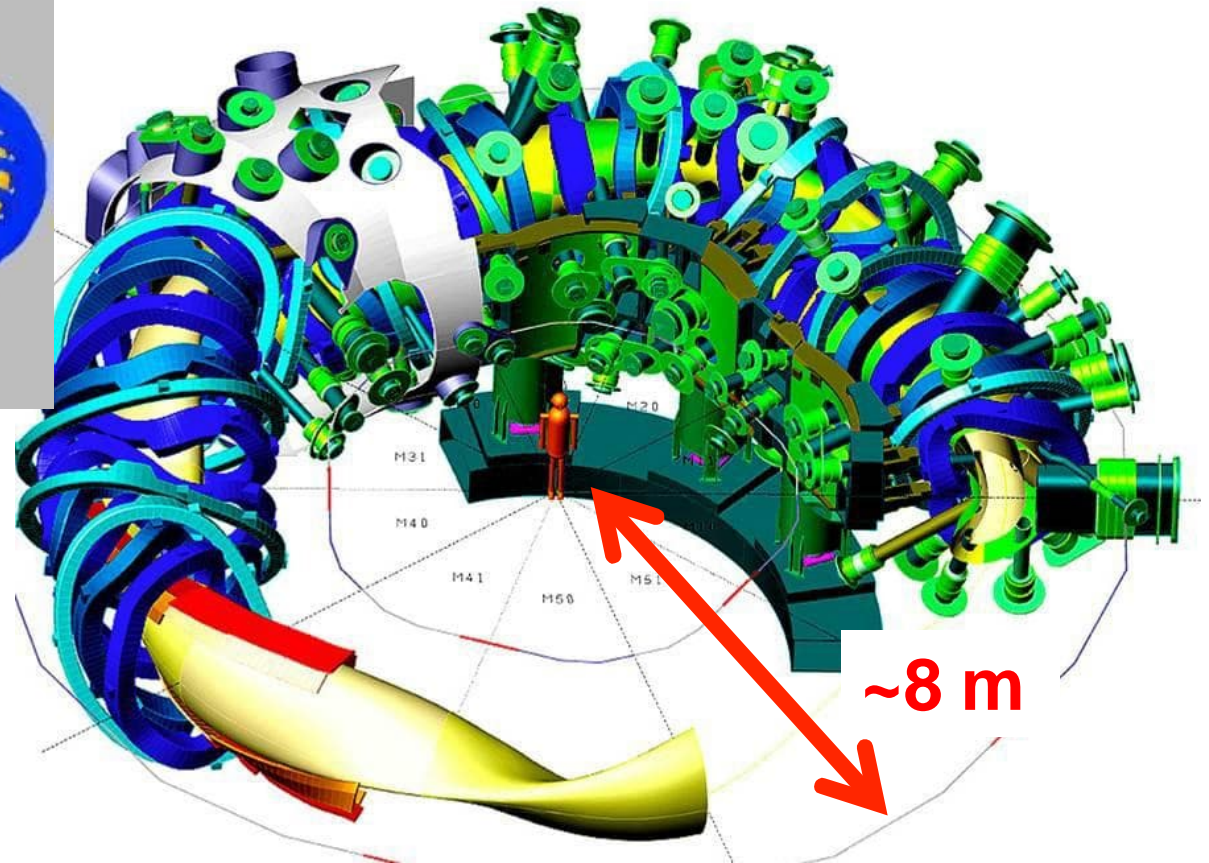

The Wendelstein 7-X is the first optimized superconducting stellarator

- HELIAS (“the pure stellarator”)
⇒ drift-optimized

$R=5.5$ m, $a=0.52$ m,
 $V_{\text{plasma}} \sim 30$ m⁻³

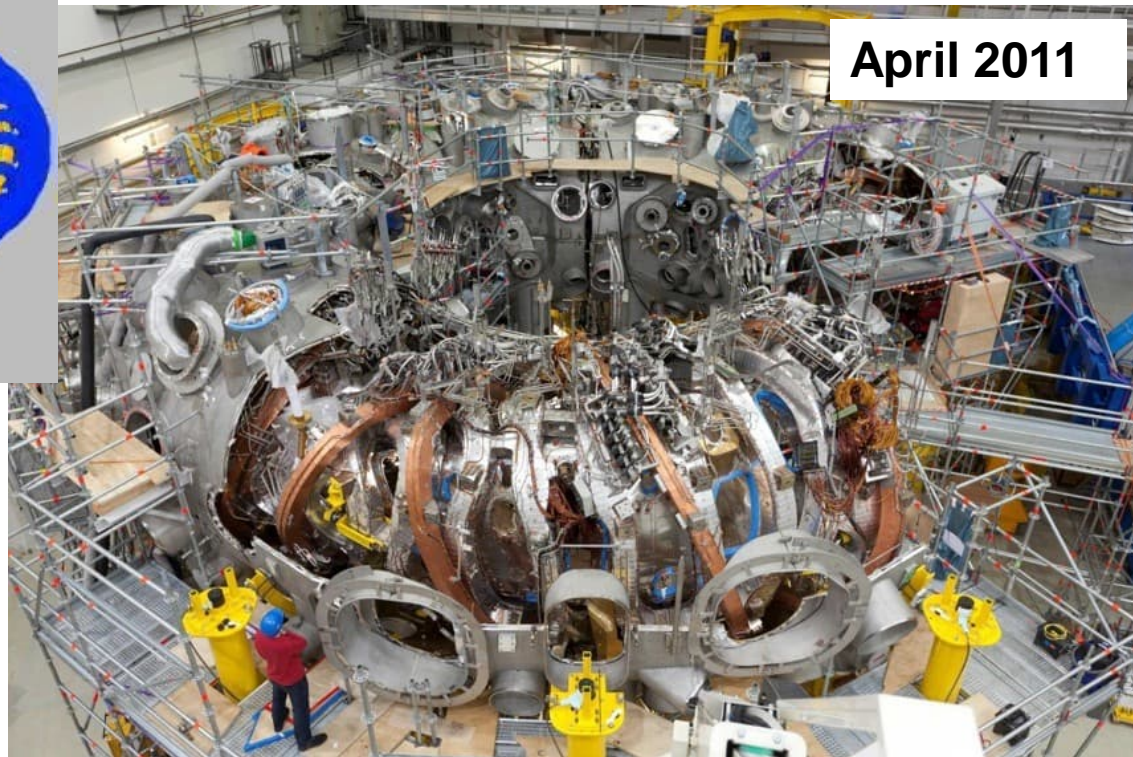
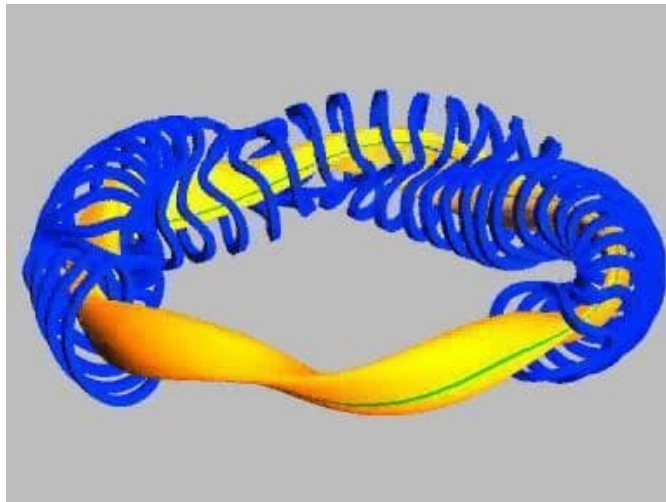

- Fully cooled in-vessel components and island divertor

The projected performance (D-T equivalent) of W/-X is an order of magnitude lower than that of ITER

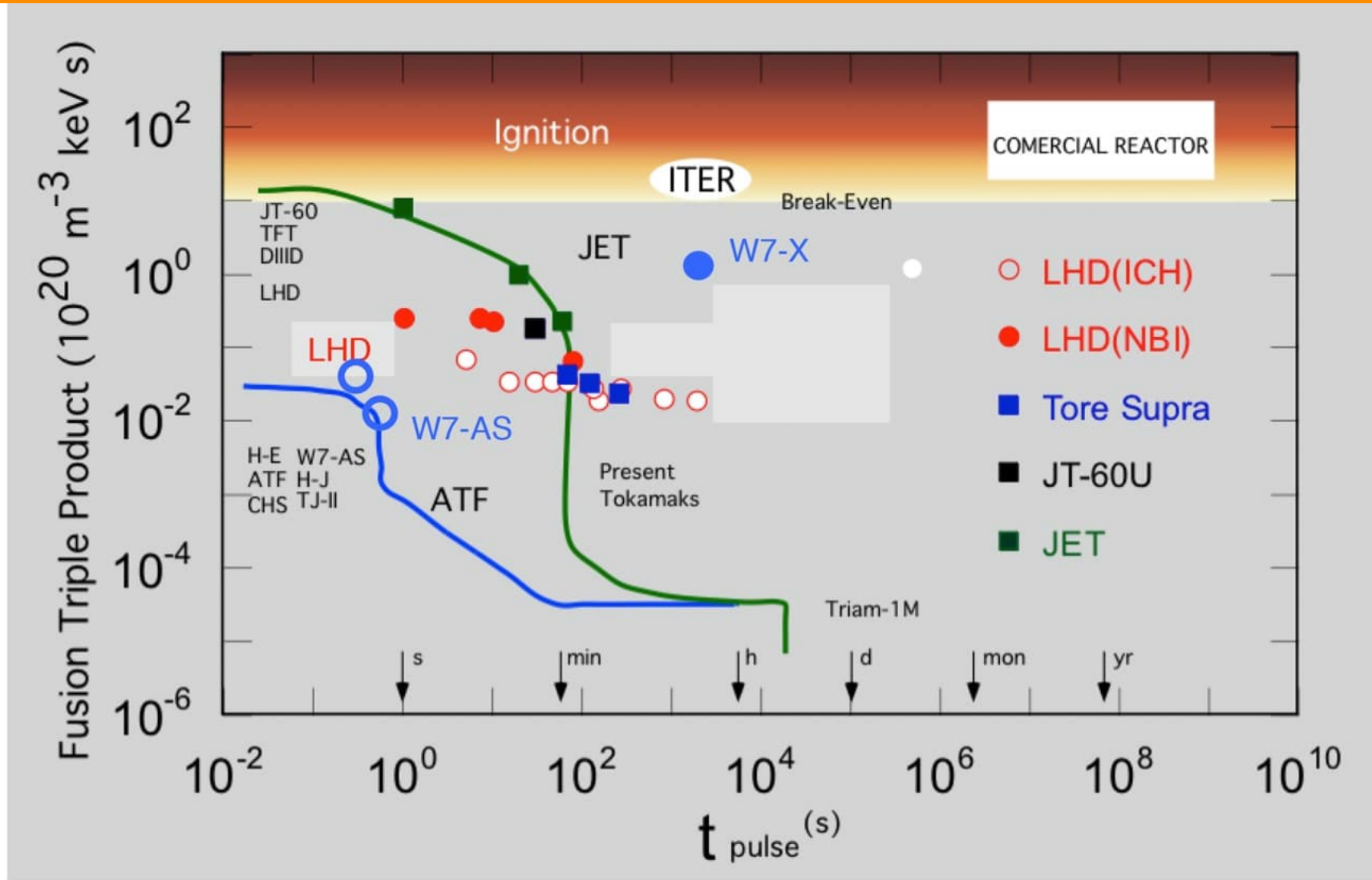

Conceptually, scientists have already been planning for future stellarator reactors

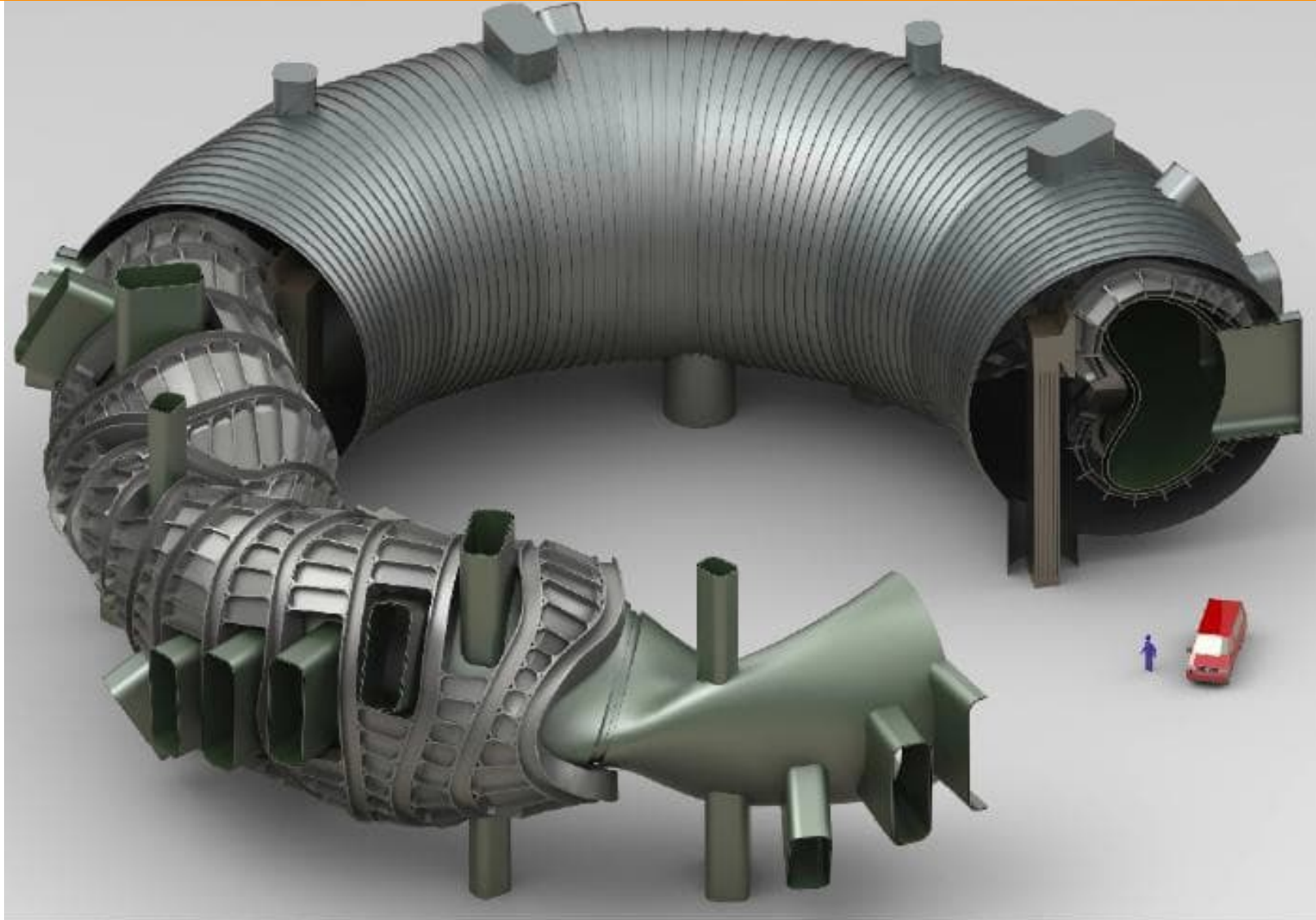

Various extensions of helical devices toward reactors exist

FFHR: $R=20$ m, $P_{th}=3$ GW

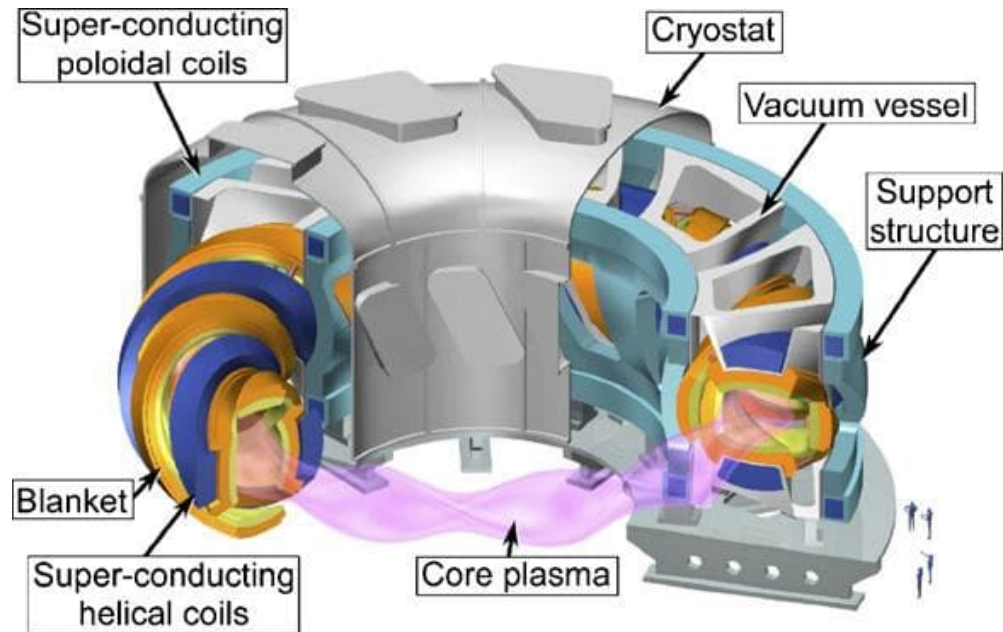

ARIES-CS: $R=8$ m, $P_{th}=4$ GW

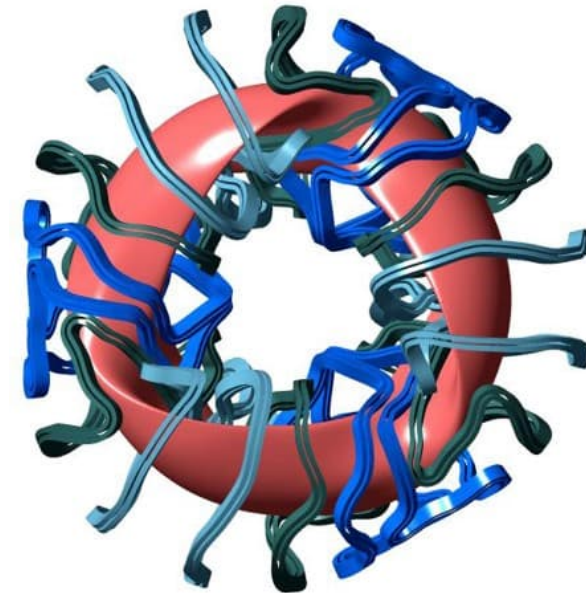

- FFHR = force free helical reactor (heliotron), based on LHD [Fus. Eng. Design 1995]
- HSR4/18: Helias reactor with four field periods, based on W7-X [Nucl Fusion 2001]
- ARIES-CS: compact stellarator [Fus. Sci and Tech. 2008]

HSR4: $R=18$ m,
 $P_{th}=3$ GW

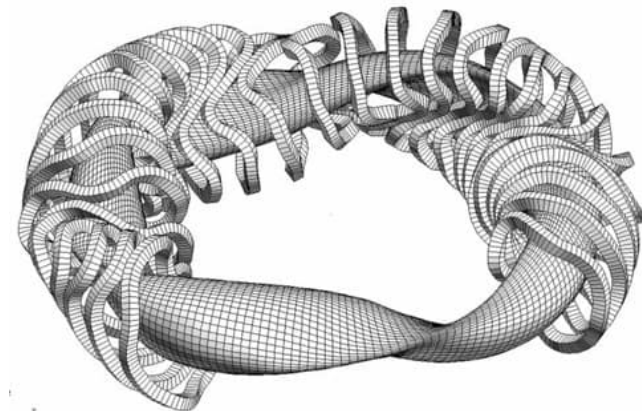

Stellarator specific reactor issues

- + **Steady-state** \Rightarrow reduced fatigue effects
 - + **No current drive** \Rightarrow low recirculating power (CD, SC, pulse length, beta \rightarrow net electricity)
 - **Mechanical forces between coils requiring heavy support structure**
 - **Limited space between plasma edge and coil in certain locations for blanket and shielding**
- \Rightarrow **Going to larger R usually helps**

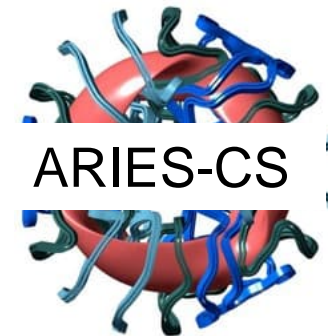
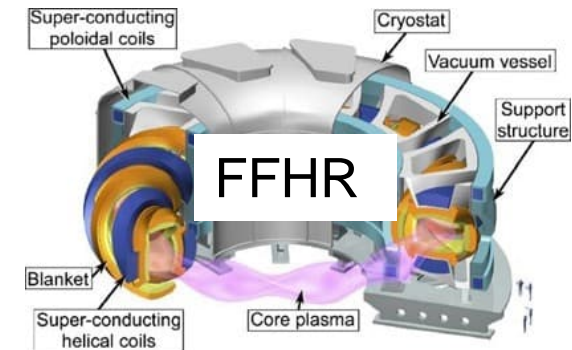

Is a stellarator reactor better than a tokamak reactor? In other words, who's winning the race?

- **Costs are significant – why paying twice?**
 - ⇒ Total investment into W7-X (1997-2014) = 1.1 bn €, EU for ITER until 2022 = 8 bn €
 - ⇒ EU fusion strategy for W7-X is not considered relevant for ITER, **but for DEMO**
- **Will there be more than one DEMO?**
 - ⇒ ITER + JT60-SA + (Chinese study) are steps toward DEMO tokamak
 - ⇒ Korea, Japan and China have built superconducting tokamaks

Is a stellarator reactor better than a tokamak reactor? In other words, who's winning the race?

- ⇒ US government stopped National Compact Stellarator Experiment (NCSX), a quasi toroidal LN2 cooled device, but also terminated Alcator C-mod ⇒ **focus on ITER**
- ⇒ In Japan, there is not yet a decision on a follow-up device to LHD
- **Can we gain from the synergy between tokamaks and stellarators?**
 - ⇒ Tokamak research is better organized, focus on ITER
 - ⇒ Stellarator research need more devices to cover the many concepts
 - ⇒ **Will failure of ITER make way for stellarator?**



Cost of fusion power plant and electricity

W7-X staff and funding profile

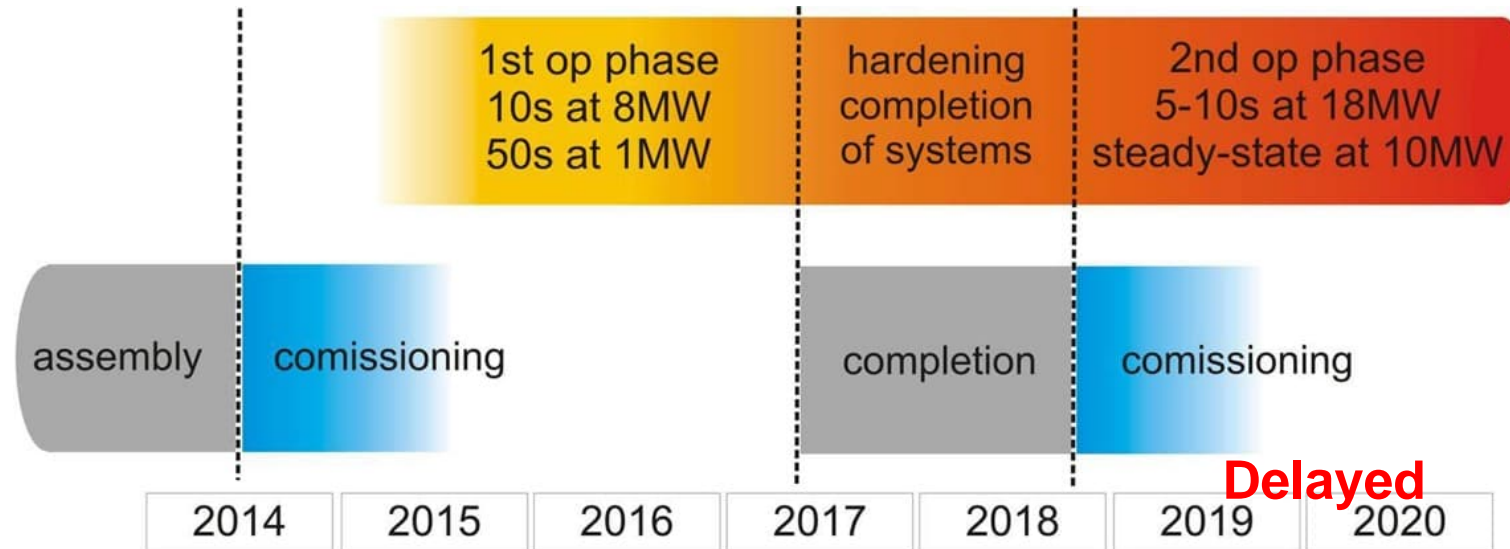

- **W7-X team ~380 people, not including visitors and support personnel**
- **Total investment between 1997-2014 ~1.1 bn € (370 m€ device, 100 m€ buildings, 310 m€ staff)**
- **25% funding from EU, 75% German and regional government**
- **2nd operational phase now ongoing (delay due to Covid-19)**

Project costs: ITER and W7-X vs. Olkiluoto and Länsimetro

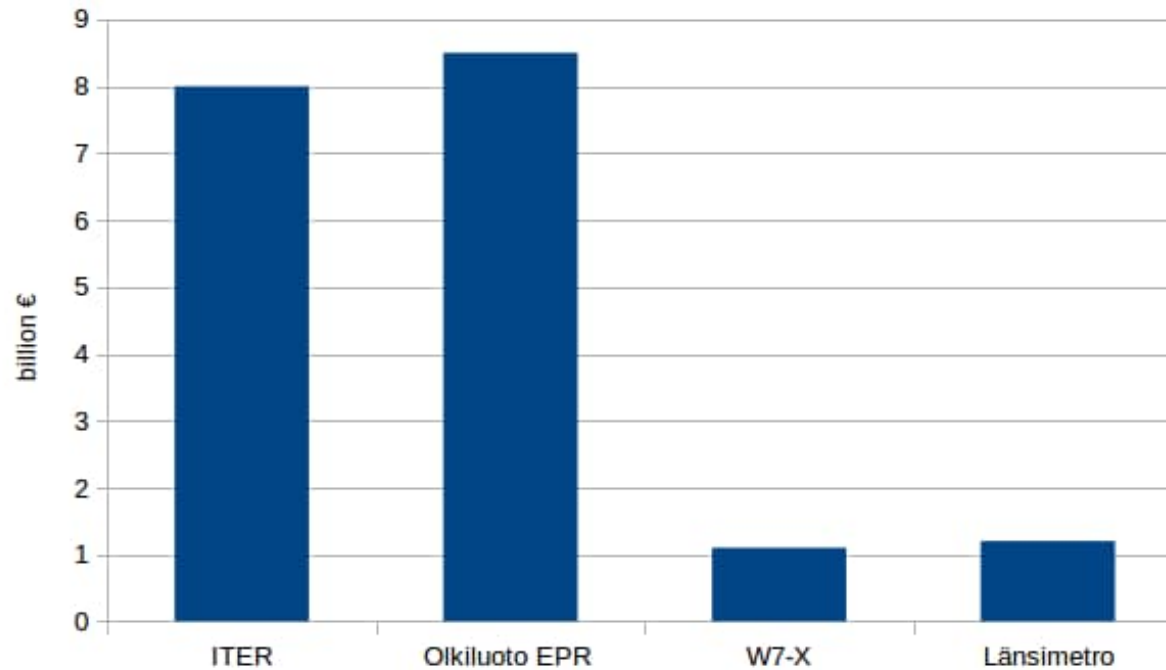

- a) EU for ITER until 2022 = 8 bn € (or: total construction costs 20 bn\$ compared to original estimate 5 bn\$ and full power 2027 compared to original estimate 2016)
- b) Finland: Olkiluoto EPR fission power plant, "first of a kind": 8.5 billion €, starts 2020 (compare to original estimate 3.2 billion €, starts 2009)
- c) Total investment into W7-X (1997-2014) = 1.1 bn€ (0.37 bn€ device, 0.1 bn€ buildings, 0.31 bn€ staff; started 2015, not e.g. 2004)
- d) Finland: Länsimetro underground (via Otaniemi): first phase costed 1.2 bn€ (2008 accepted budget 0.7 bn€)

Cost of fusion electricity depends on...

- Investment cost depends on machine size especially for large reactors
- for $\langle r \rangle \approx$ **plasma coil spacing** further reduce of size does not help much (for a given P_{output})
 - a) higher loads on components
 - b) tighter spaces for maintenance
 - c) other engineering constraints
 - \rightarrow a larger extrapolation from current technology required
- Cost of electricity also depends on the availability of power plant (\rightarrow replacement of components), learning factor, cost of materials and technological development

Cost of fusion electricity depends on...

$$LCOE = p_{elc} = \frac{\sum_t (I_t + O \& M_t + F_t + C_t + D_t)(1-r)^{-t}}{\sum_t (E_t)(1-r)^{-t}}$$

Investment cost (points to I_t)
 Operation and maintenance (points to $O \& M_t$)
 Fuel (points to F_t)
 Carbon Emission allowance (points to C_t)
 Decommissioning (points to D_t)
 Discount rate (points to $(1-r)^{-t}$)
 = interest rate to determine the present value of future cash flows
 Electricity produced (points to E_t)

In fusion ~ 70 % cost of capital, 3% O&M, 25% blanket and divertor replacement, ~ 1% Fuel, < 1% Decommissioning

Bustreo, ETSAP meeting 2013

Example: ARIES-CS Power-Plant Investment Cost

TABLE II
ARIES-CS Power Plant Economic Parameters (2004 \$)*

Account Number	Account Title	Million Dollars
20	Land and land rights	12.9
21	Structures and site facilities	336.1
22	Reactor plant equipment	1538.9
22.1.1	First wall/blanket/reflector	59.4
22.1.2	Shield	228.6
22.1.3	Magnets	222.9 ^a
22.1.4	Supplemental heating/current drive systems	66.4
22.1.5	Primary structure and support	73.1
22.1.6	Reactor vacuum systems(unless integral elsewhere)	137.1
22.1.7	Power supply, switching, and energy storage	70.6
22.1.8	Impurity control	6.6
22.1.9	Direct energy conversion system	0.0
22.1.10	Electron cyclotron resonance heating breakdown system	0.0
22.1	Reactor equipment	864.7
22.2	Main heat transfer and transport systems	474.8
23	Turbine plant equipment	314.6
24	Electric plant equipment	138.8
25	Miscellaneous plant equipment	71.0
26	Heat rejection system	56.1
27	Special materials	151.3
90	Direct cost (not including contingency)	2620.0
	Total COE ($\text{¢}/\text{kW}\cdot\text{h}$)	7.76 ^b

*No cost penalty has been assumed for manufacturing of complex components. For example, applying a 25% cost penalty to major components (blanket, shield, and coils) increases the COE by 0.37 $\text{¢}/\text{kW}\cdot\text{h}$.

^aAssumes coil support structure is fabricated by advanced manufacturing techniques.

^bAssumes an 85% availability (similar to ARIES-AT).

Najmapadi et al, Fusion Science and Technology /
Volume 54 / Number 3 / October 2008 / Pages 655-672

The Wendelstein 7-X project

The Wendelstein 7-X project at the Institute for Plasma Physics in Greifswald, Germany

Video of construction work for those who are interested (same information is in following slides):
[Construction W7-X \(1.21 s\)](#)

Longer (5min) video will be shown later in this lecture

The Wendelstein 7-X project at the Institute for Plasma Physics in Greifswald, Germany

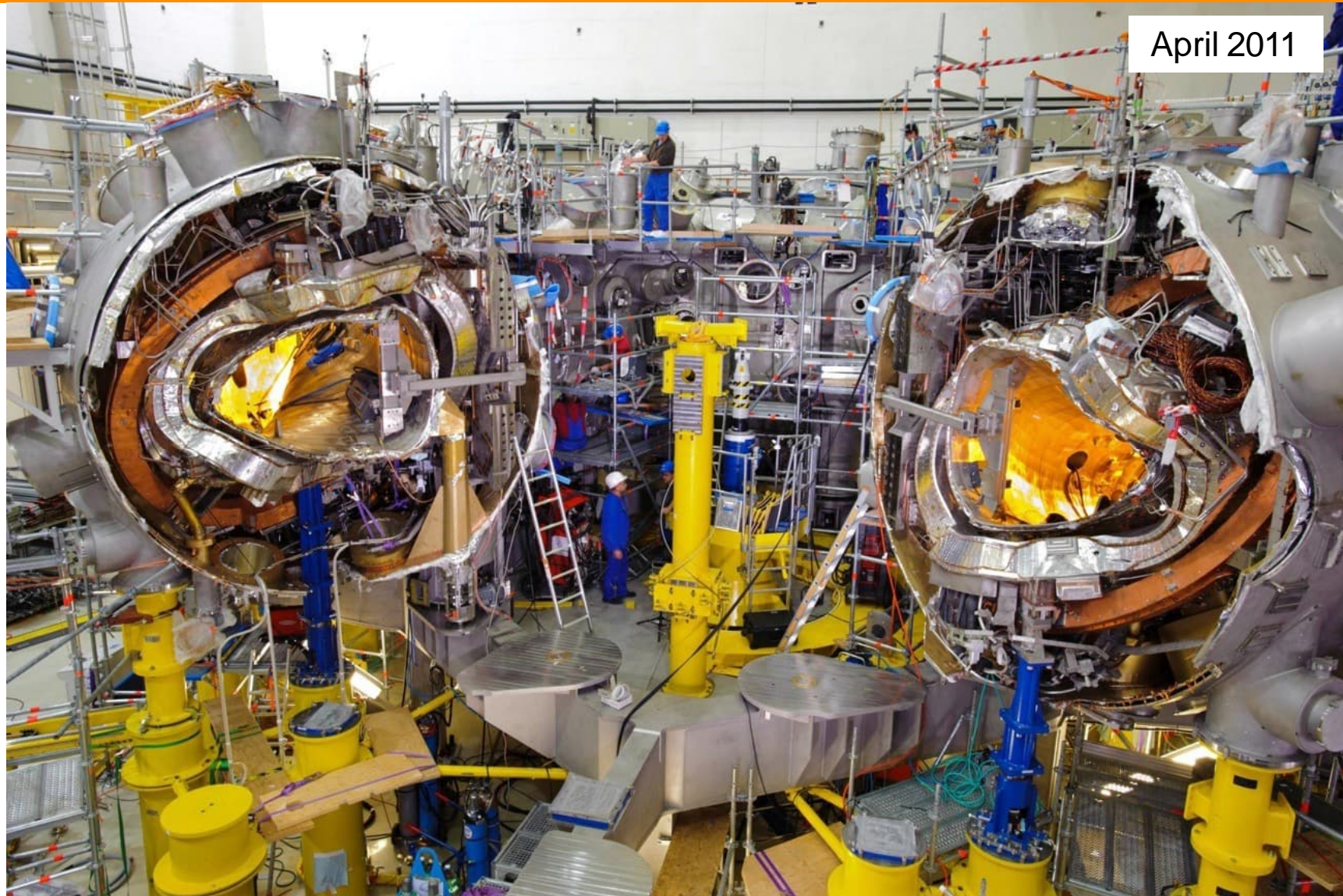

Long-pulse operation requires actively cooled wall elements in the divertor

Mirnov magnetic coil exposed to microwave

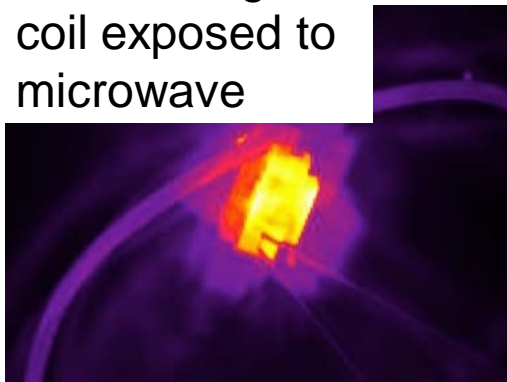

microwave launcher



1 MW gyrotron



divertor element

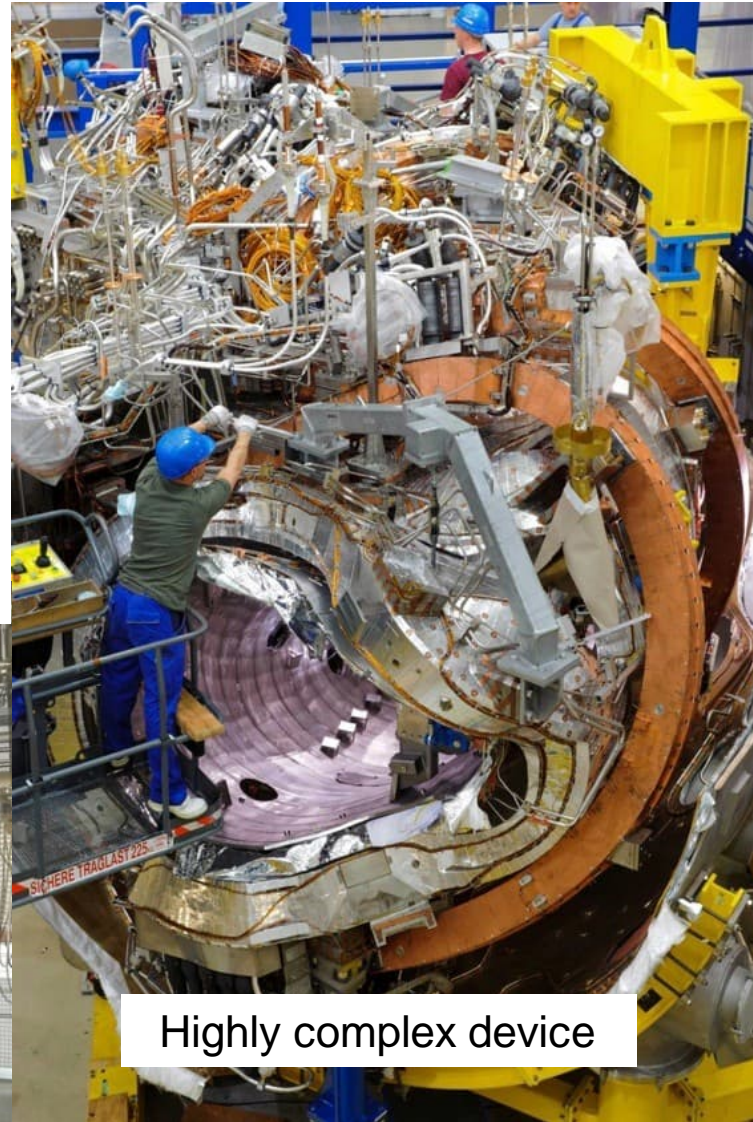
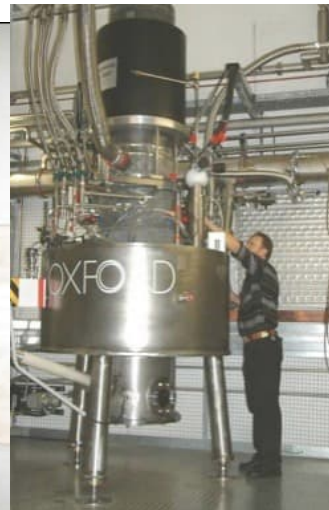

Highly complex device

The vacuum vessel follows the twist of the desired plasma



Design, fabrication and testing of modular superconducting coils was a major challenge



Integration of the coil / vessel system into a cryostat is a significant engineering challenge

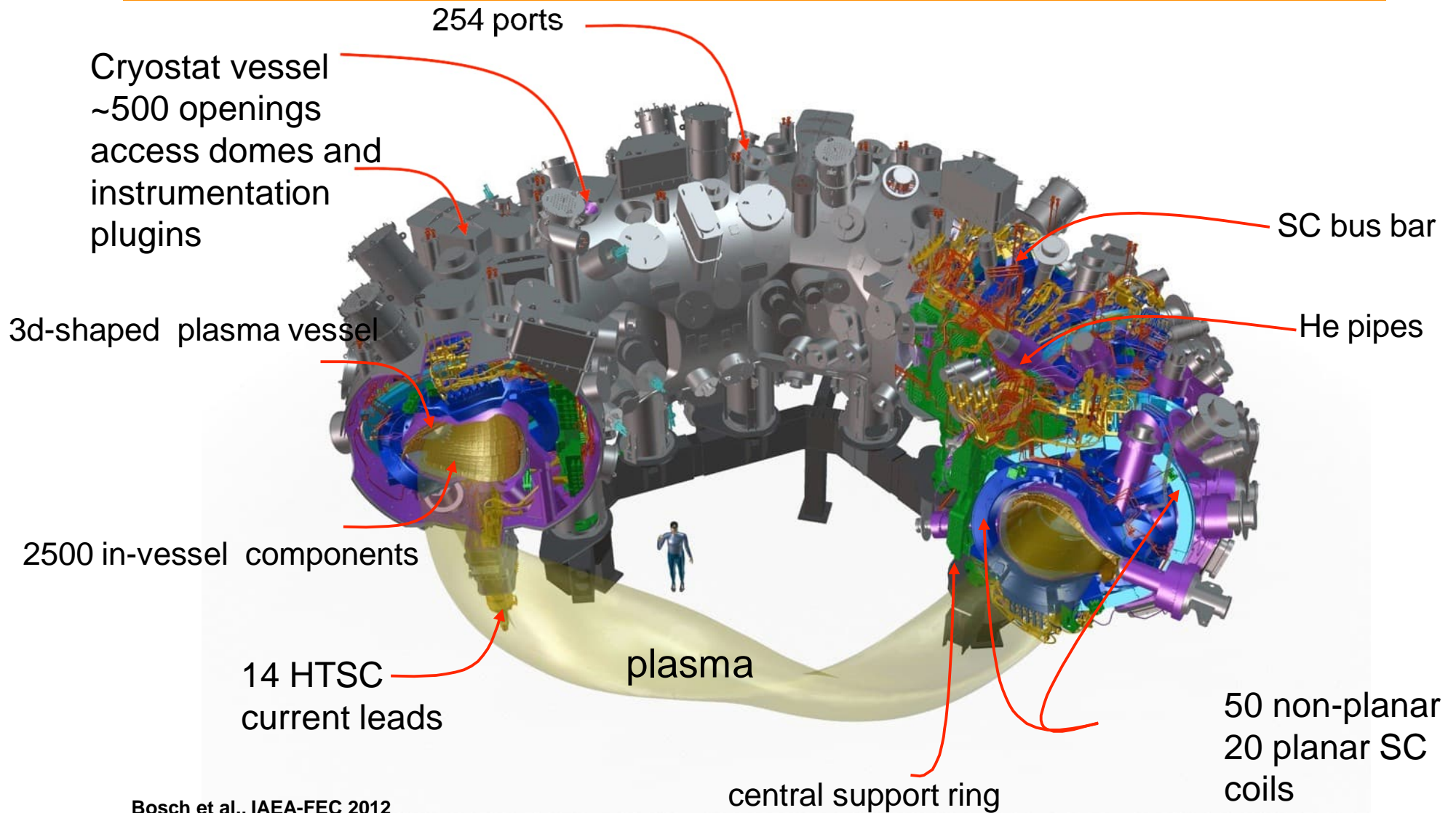

Bosch et al., IAEA-FEC 2012

The Wendelstein 7-X hall in 2006



First magnetic assembly in cryostat of the W7-X stellarator started in October 2009

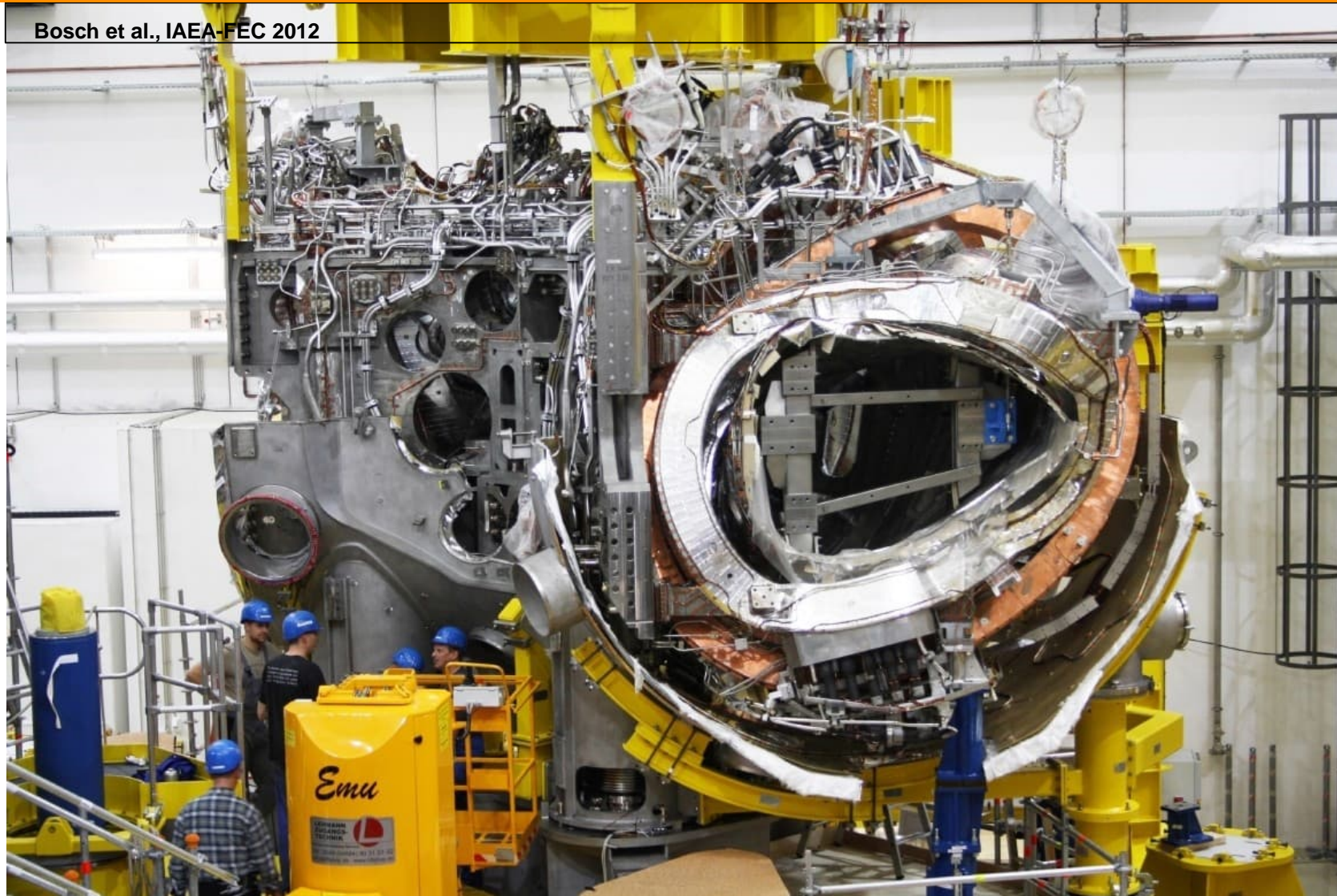

The Wendelstein 7-X hall in early 2013

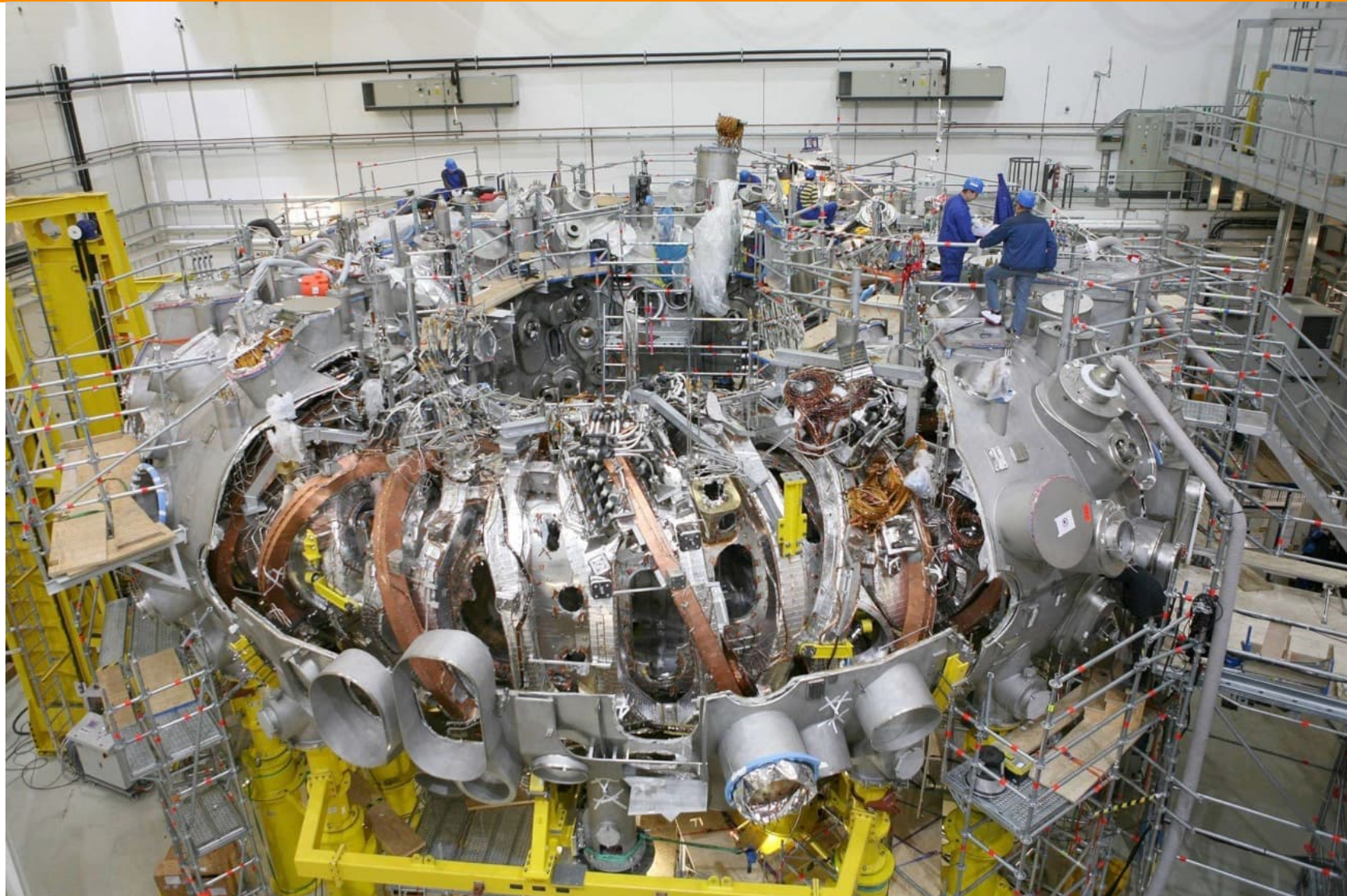

The Wendelstein 7-X hall in August 2013

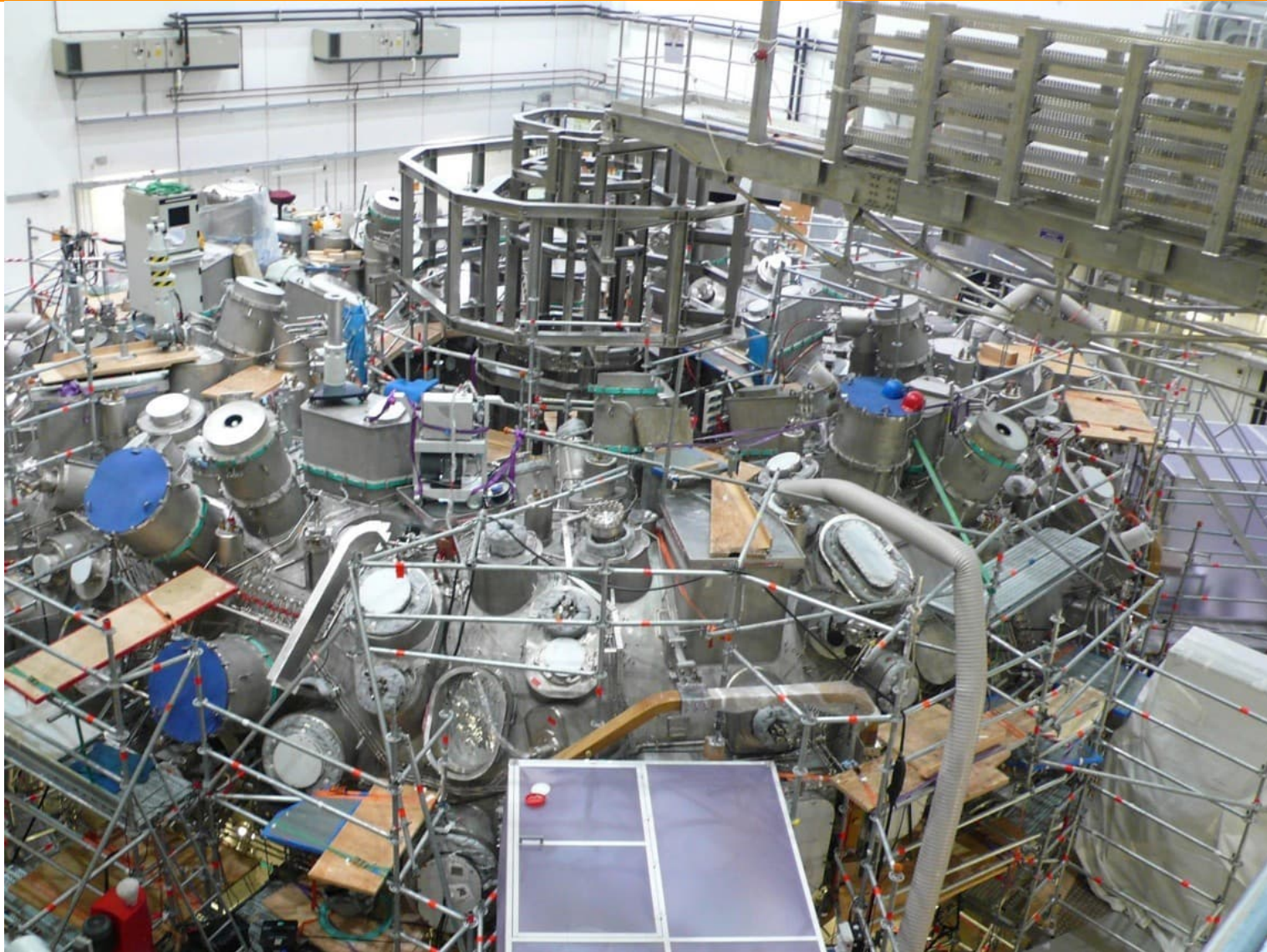

Assembly of Wendelstein 7-X completed in June 2014 → start of extensive commissioning



The first (He) plasma in Wendelstein 7-X was obtained on December 10, 2015 (100 ms long)

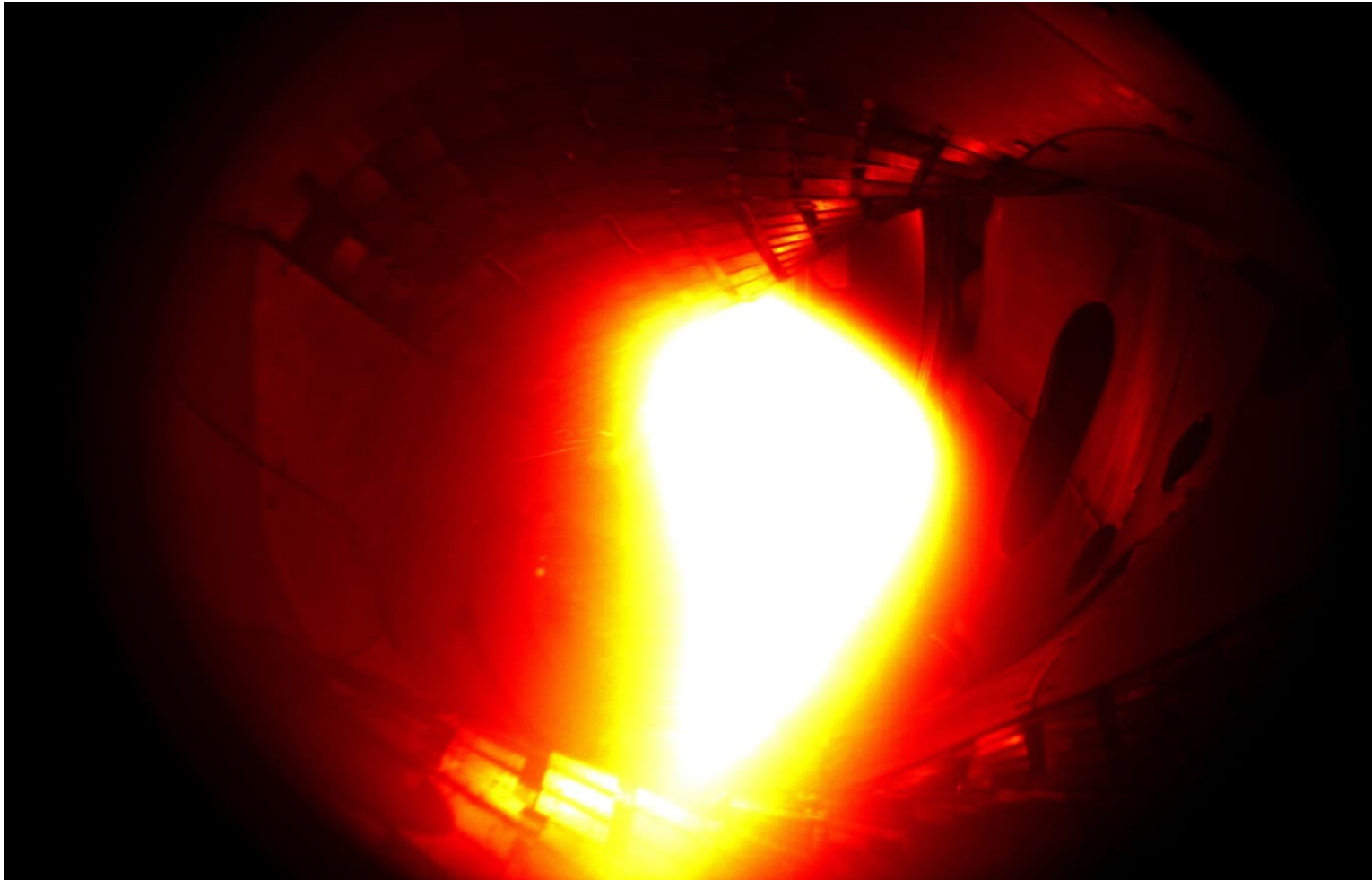

Angela Merkel switches on Wendelstein 7-X fusion device (first hydrogen plasma in Feb 2016)



W7-X is hosted by the Institute for Plasma Physics in Greifswald, Germany (project since 1994)

W7-X hall

ECRH

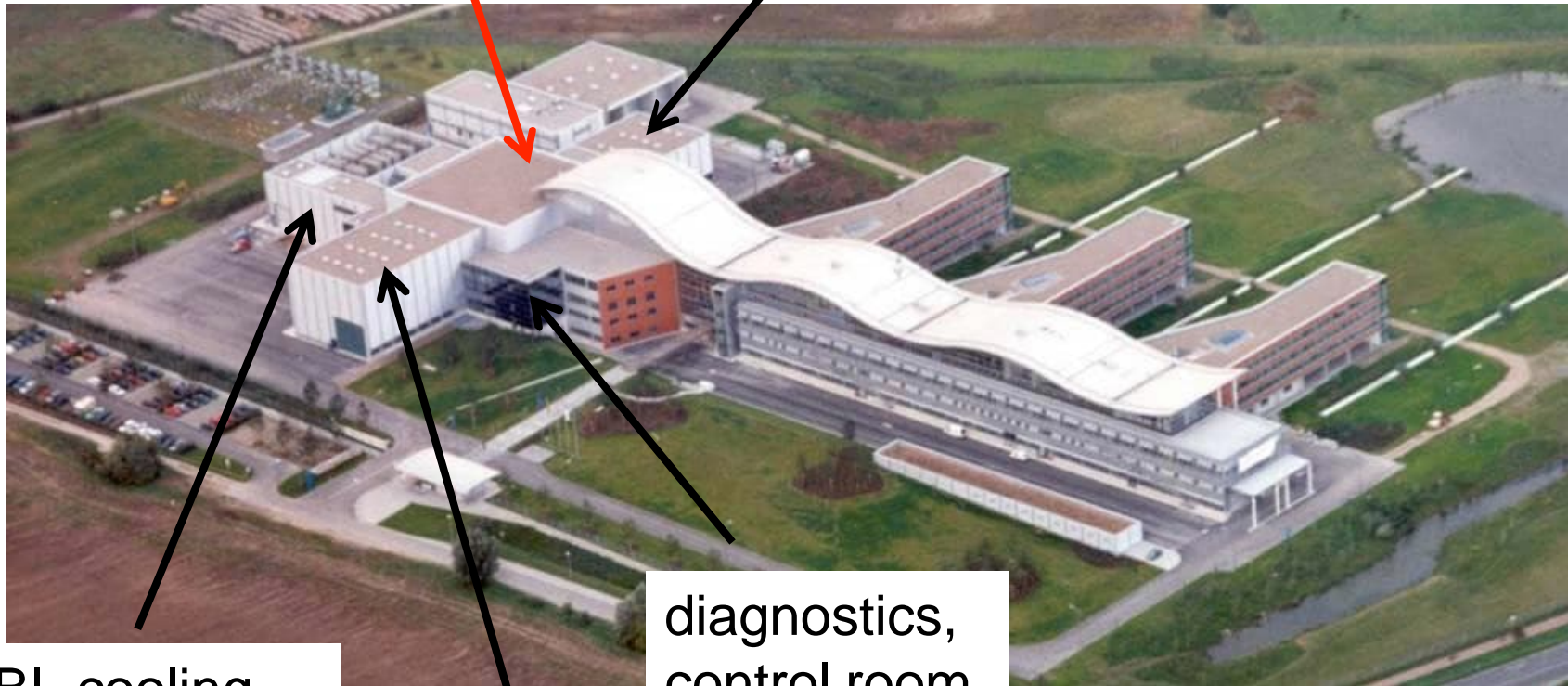

NBI, cooling plant, He plant

assembly hall, ICRF

The 1st operation phase of W7-X is to verify the stellarator optimization and develop integrated high-density scenario

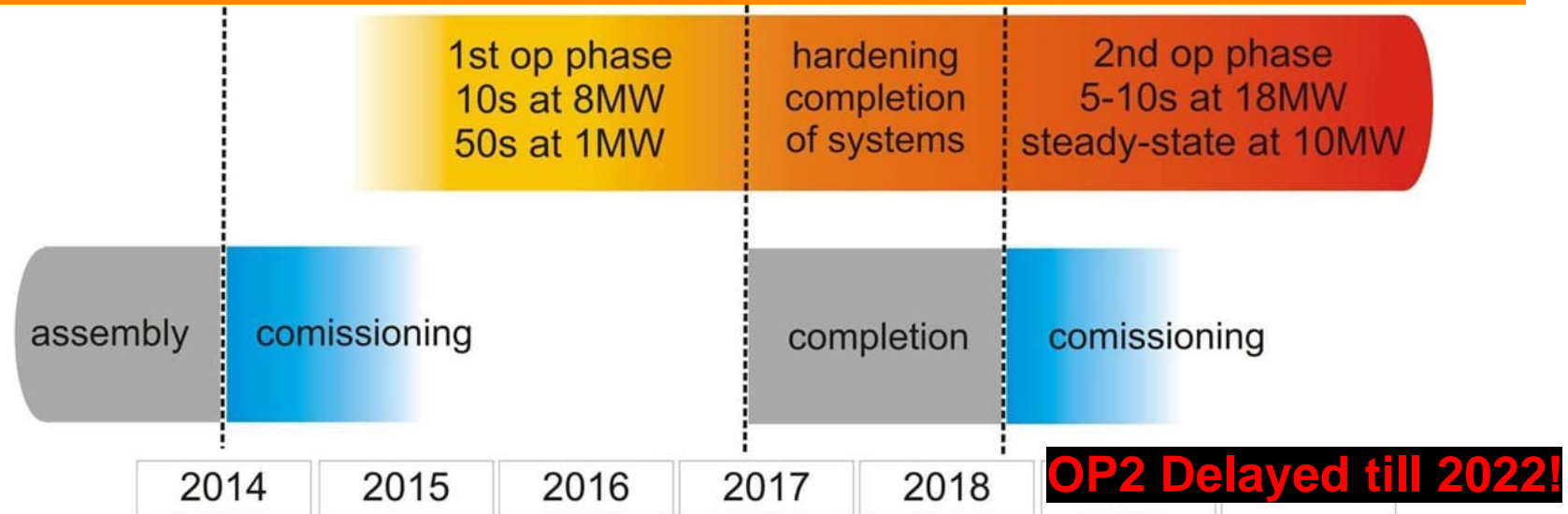

- **Commissioning of vacuum vessel, magnetic field, field line tracing, plasma startup ⇒ first plasma Dec-2015**
- **1st operation phase with inertially cooled divertor, some in-vessel components cooled**
- **No provision for D-T operation**
- **Last divertor plates installed June 2021**

New world record in stellarator fusion product in W7-X (press release 25.6.2018)

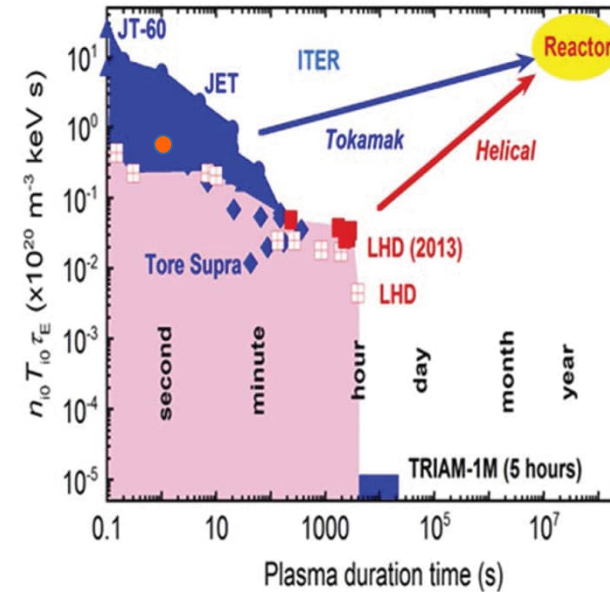
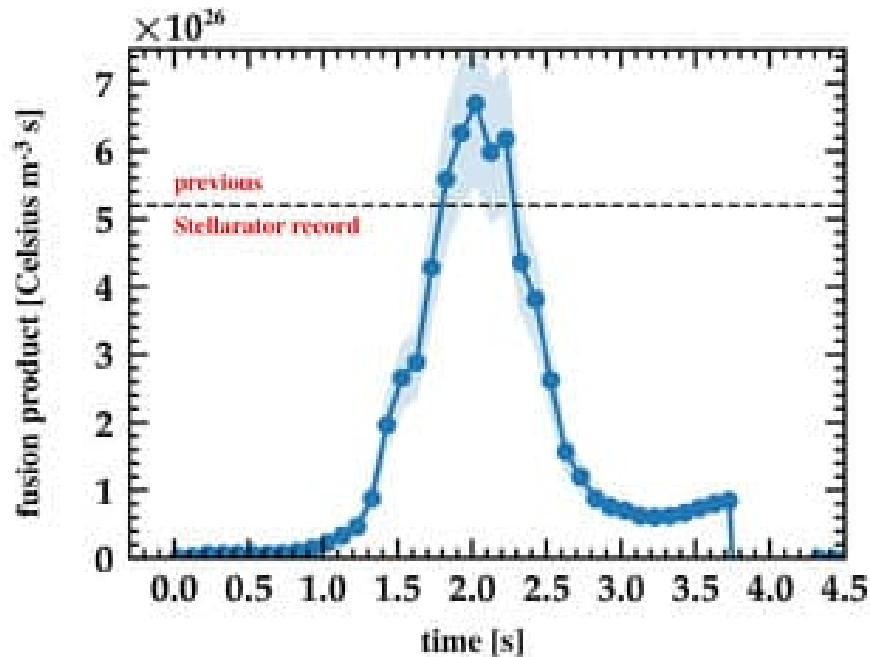

Compare to LHD result (Takeiri, IEEE Trans. Plasma Science, 2018)

- Fusion product 6×10^{26} Celsius $m^{-3} s \approx 0.5 \times 10^{20}$ keV $m^{-3} s$ was received with at $T_i = 40000000$ K (> 3 keV) and $n_i = 0.8 \times 10^{20} m^{-3}$

Ongoing campaign OP.2 (press release 14.9.2022)

- **120 new divertor modules with a cooling system**
→ operation at significantly higher plasma energies possible
- **New or upgraded heating systems more than doubling output power:**
 - the new ICRH system (up to $P=1.5$ MW)
 - NBI system with doubled heating power up to $P=7$ MW
 - ECRH system upgraded to 10 MW
- **Injected energy (power \times duration): so far max 75MJ, present OP.2 goal ≈ 1 GJ, long term goal 18GJ (30 min discharge)**

Video + Presemo quiz #2

Video: [W7-X fusion device \(5min 42s\)](#)

<https://presemo.aalto.fi/fet/>

Quiz questions are mainly about the video so you can do quiz during or after the video

Summary

- **The equilibrium in a stellarator is established by external coils only (3D) ⇒ can naturally be operated in steady-state and no current-driven disruptions**
- **Good nested flux surfaces with small islands can be obtained, even at high plasma pressure ⇒ island divertor for heat exhaust**
- **Loss of axisymmetry results in additional loss mechanism for particles and energy (fast particles, alphas)**
⇒ **potentially be reduced by field optimization**
- **Stellarators can be operated at high-density without impurity accumulation**
- **Wendelstein-7X started plasma operation in Dec-2015**



Reserve material

Rotational transform defines closed field lines (rational iota) and ergodic regions (irrational iota)

Tokamak

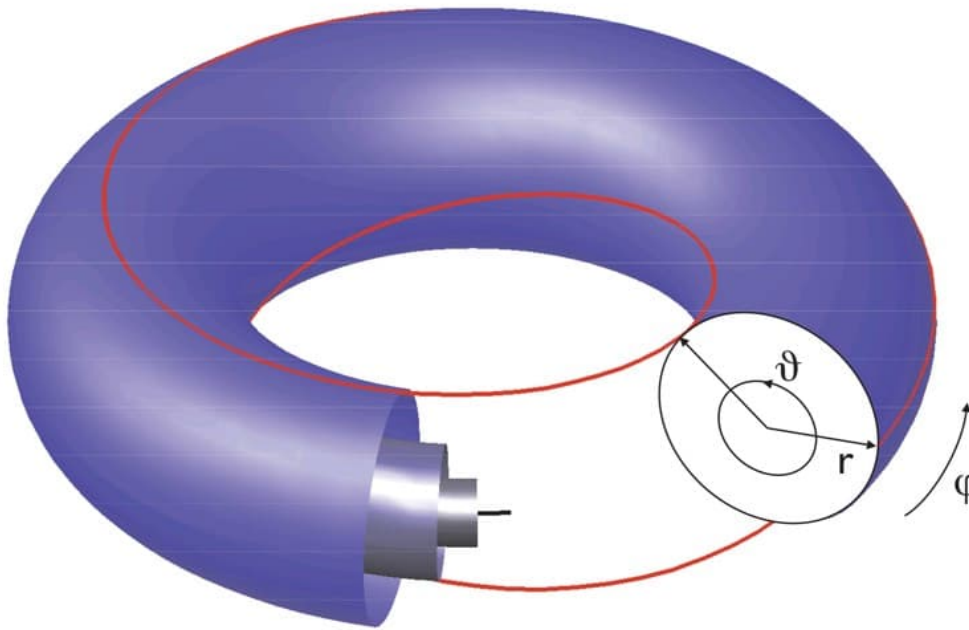

$$q(r) = \frac{r BT(r)}{R Bp(r)}$$

Inverse



Stellarator (Poincare plot)

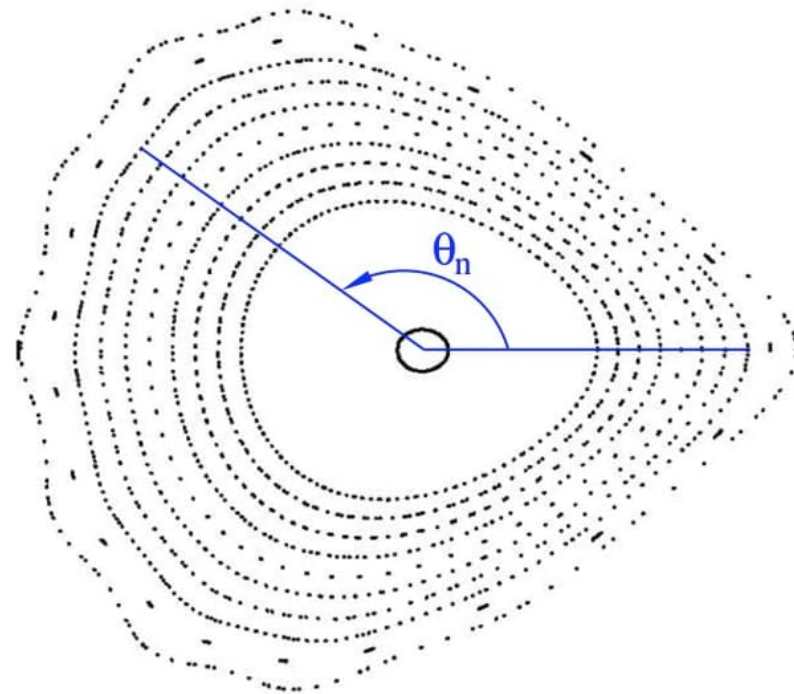

$$I \equiv \lim_{n \rightarrow \infty} \frac{\theta_n}{2\pi n}$$

Parameterize magnetic geometry in a straightenout stellarator of pitch k

- **Assume helical symmetry:** $B = B(r, \vartheta - kz)$

- **Vacuum field only:** $\Phi = B_0 z + \frac{1}{k} \sum_{l=1}^{\infty} b_l I_l(lkr) \sin [l(\vartheta - kz)]$
(pressure = 0) *Mod. Bessel
function $I_l(lkr)$*

⇒ **Flux surfaces:** $\Psi = B_0 \frac{kr^2}{2} - r \sum_{l=1}^{\infty} b_l I_l(lkr) \cos [l(\vartheta - kz)]$
= const

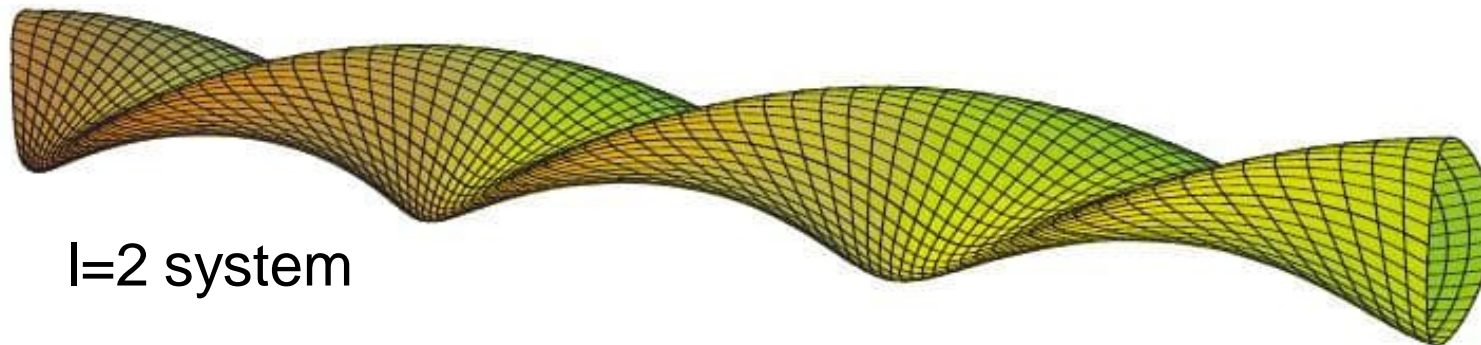

l=2 system

The Bessel function parameter l determines the dominant helical harmonic

$l=1$

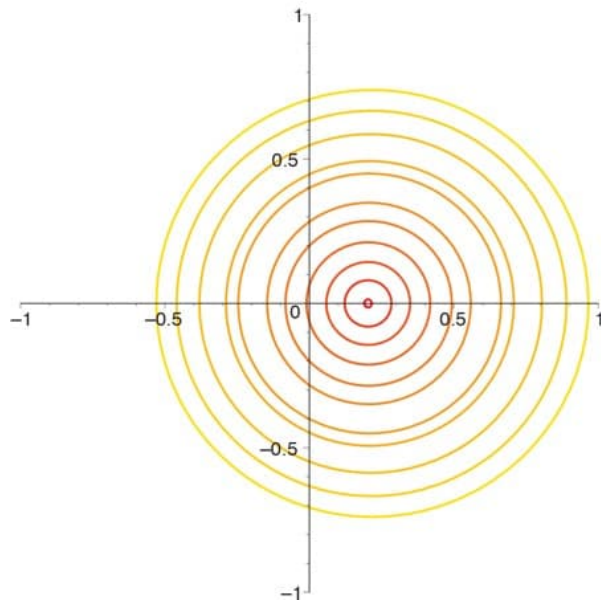

$l=2$

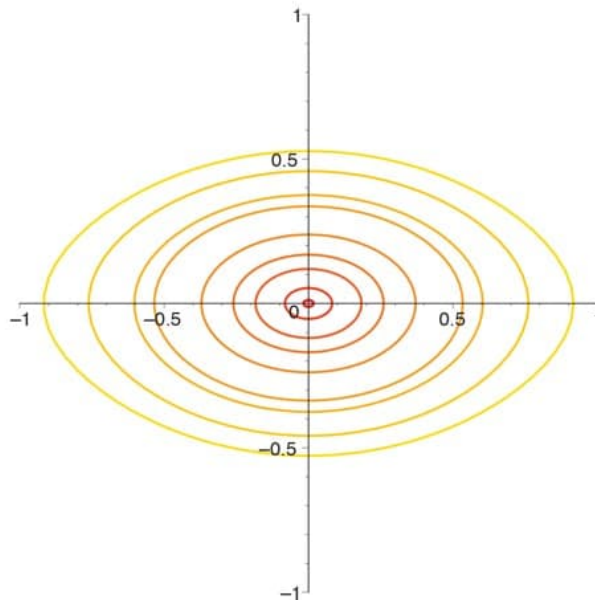

$l=3$

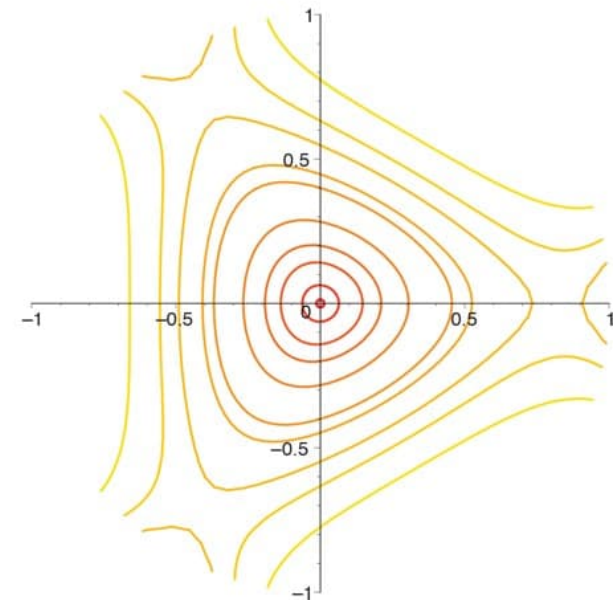

- $l=1$ systems: shifted circles
- $l=2$ systems: elliptical with the center on-axis
- $l=3$ systems: triangular shape