

SCHEDULE

	Date	Topic
1.	Wed 01.03.	Lec-1: Introduction
2.	Mon 06.03.	Lec-2: Crystal Chemistry & Tolerance parameter
3.	Mon 06.03.	EXERCISE 1
4.	Wed 08.03.	Lec-3: Crystal Chemistry & BVS
5.	Fri 10.03.	Lec-4: Symmetry & Point Groups
6.	Mon 13.03.	EXERCISE 2
7.	Wed 15.03.	Lec-5: Crystallography & Space Groups (Linda)
8.	Fri 17.03.	Lec-6: XRD & Reciprocal lattice (Linda)
9.	Mon 20.03.	EXERCISE 3 (Linda)
10.	Fri 31.03.	Lec-7: Rietveld (Linda)
11.	Mon 03.04	EXERCISE 4: Rietveld (Linda)
12.	Wed 12.04.	Lec-8: ND & GI-XRD
13.	Fri 14.04.	Lec-9: XRR (Topias)
14.	Mon 17.04.	EXERCISE 5: XRR (Topias)
15.	Wed 19.04.	Lec-10: Synchrotron radiation & XAS & EXAFS
16.	Fri 21.04.	Mössbauer
17.	Fri 21.04.	EXERCISE 6
18.	Thu 27.04.	Seminars: XPS, FTIR, Raman
19.	Fri 28.04.	Seminars: ED, HRTEM, SEM, AFM

EXAM

LECTURE 8:

GRAZING-INCIDENCE XRD

- **GI-XRD: thin-film XRD**
- **Crystal structure, phase composition, orientation**

NEUTRON DIFFRACTION

- **Production of neutrons: fission and spallation**
- **ND versus XRD: many similarities but several important differences!**
- **Very useful for example for oxide materials**
- **Magnetic structure determination**

Grazing Incidence X-ray Diffraction (GI-XRD)

- **Surface sensitive XRD: small incident angle for the incoming X-ray beam**
- **Thin films typically: 1~1000 nm**
- **Penetration depth of X-rays: 10~100 μm (depending on elemental composition)**
- **Conventional XRD with symmetric $\theta/2\theta$ configuration: diffracted radiation mostly due to the substrate**
- **Small incident angle (α) lowers the penetration depth \rightarrow information mostly from a thin surface layer**
- **Measure at a fixed α**
- **Depth profiling is also possible: control of α**

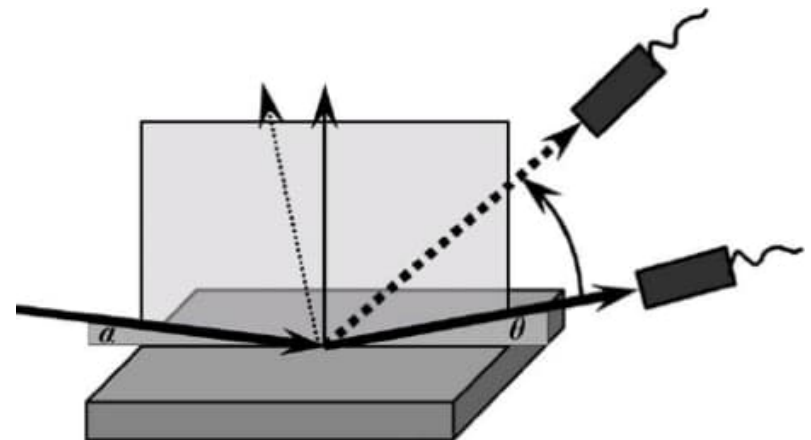
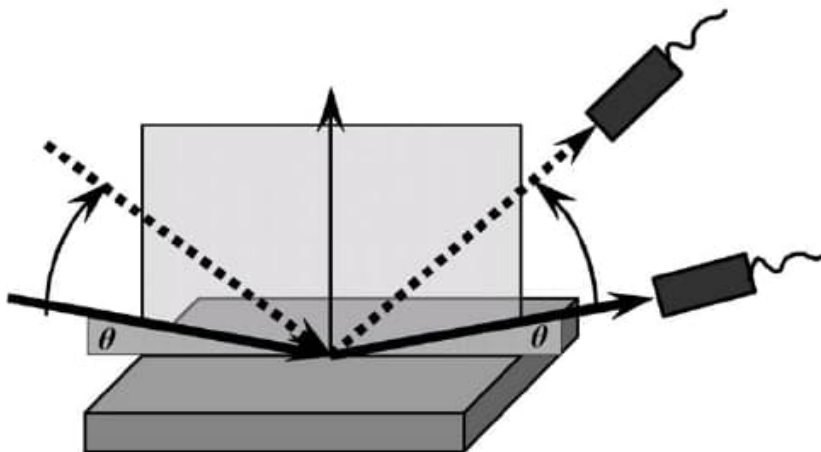

Diffused reflections specularly reflected

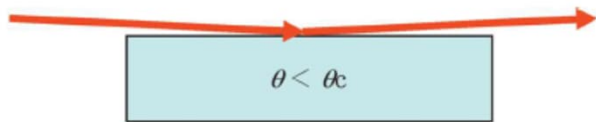
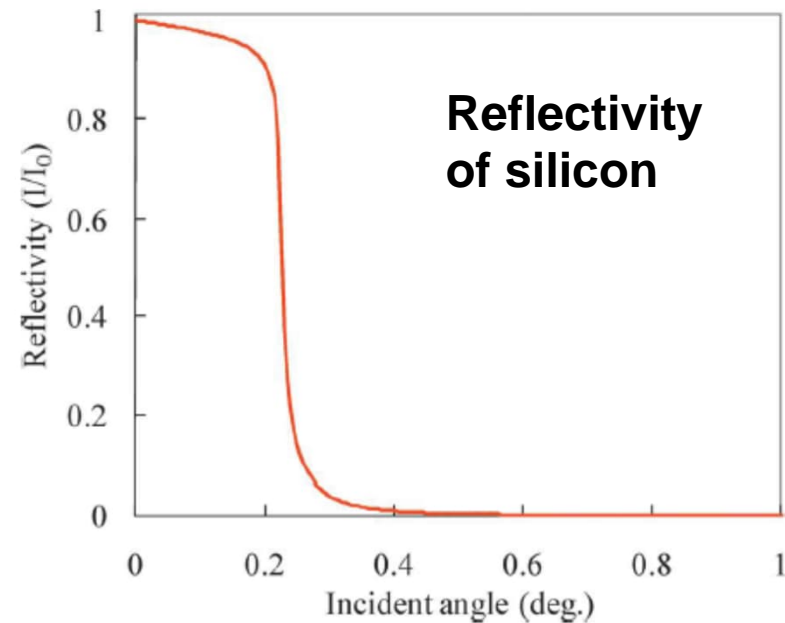

$$\theta < \theta_c$$

- A) Incident angle < Total reflection critical angle
All incident X-rays are reflected.

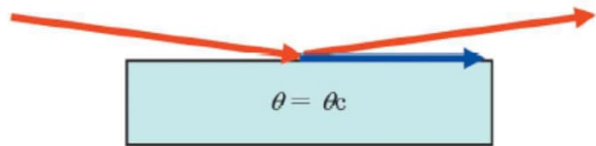

$$\theta = \theta_c$$

- B) Incident angle = Total reflection critical angle
Incident X-rays propagate along the sample surface.

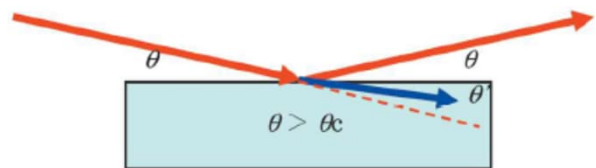

$$\theta > \theta_c$$

- C) Incident angle > Total reflection critical angle
Incident X-rays penetrate into the material by refraction

CRITICAL ANGLE

- With very tiny incident angles X-rays only reflect from the sample surface (no refraction)
- At the critical angle (α_c), X-rays begin to penetrate (= refract) the material
- Above α_c the reflectivity rapidly drops
- α_c is material property \rightarrow proportional to the square root of electronic density

- ❖ Similar (same) device as in ordinary powder XRD, but slightly different configuration
- ❖ **Fixed incident angle (α)**
- ❖ Value of α ($0.5 - 4^\circ$) selected to be little larger than the material-dependent “critical angle” (= total reflection limit)

GI-XRD

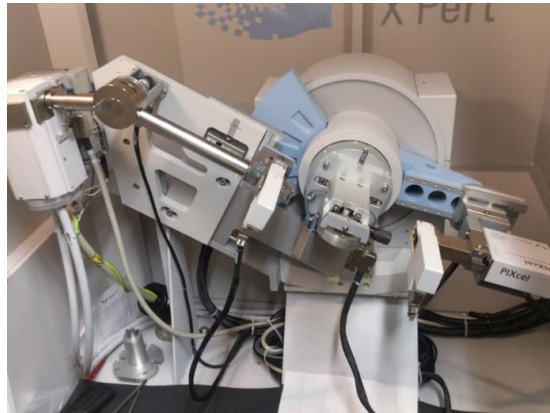
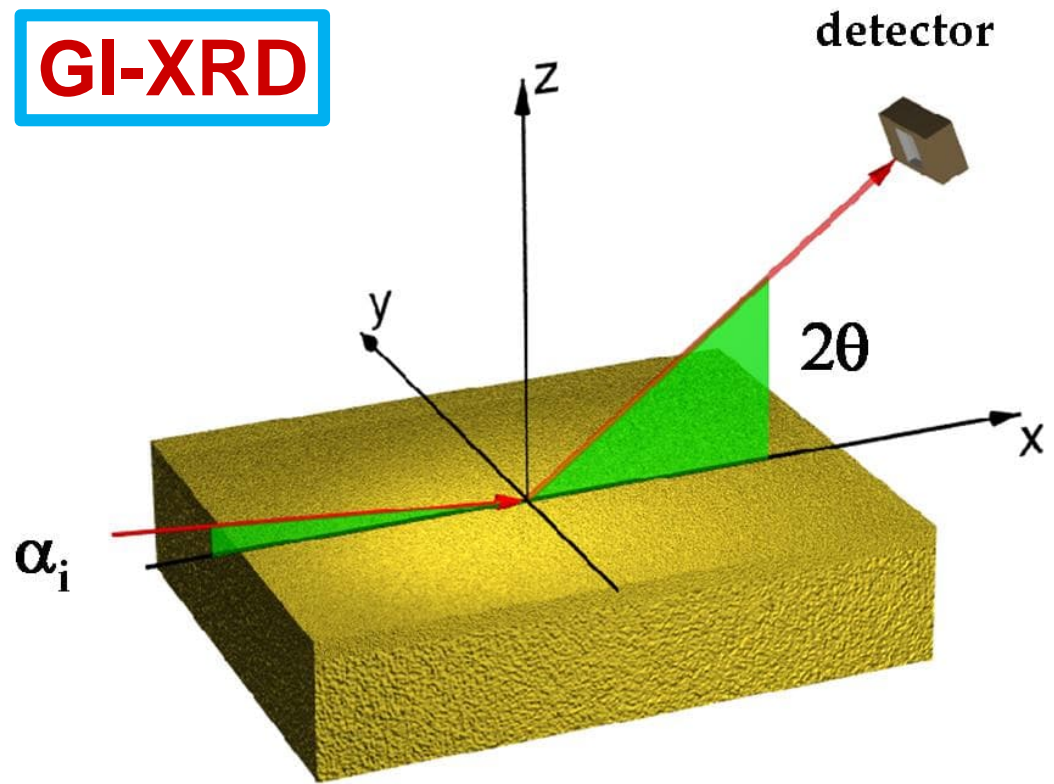

XRD



GI-XRD

Critical angle: Si (= 0.223°) and W

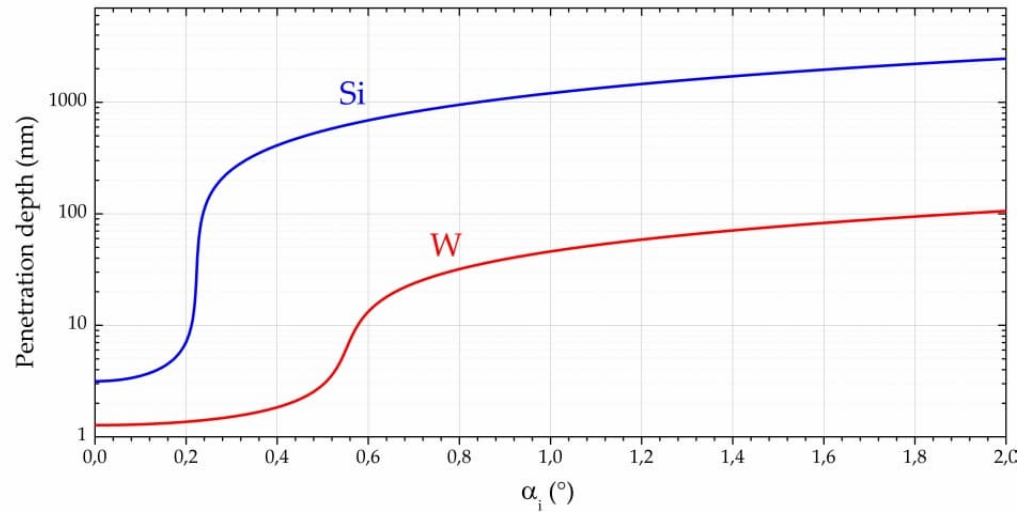

XRD

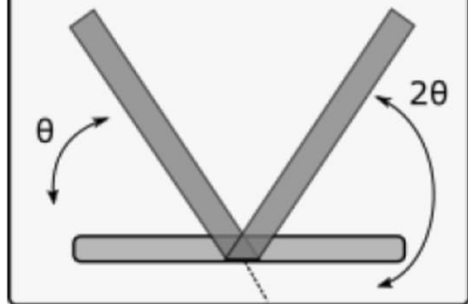

GIXRD

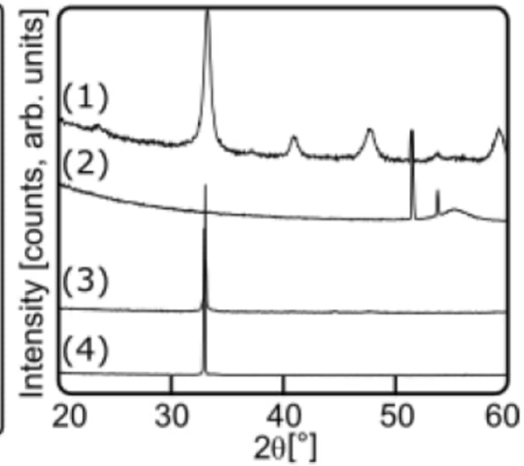
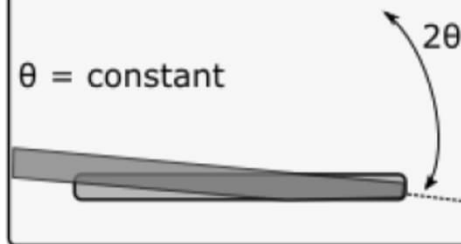

GI-XRD

- (1) Thin film + subs.
- (2) Substrate

XRD

- (3) Thin film + subs.
- (4) Substrate

**EXAMPLE: Eu_2O_3 thin film on top of a brass substrate;
conventional XRD shows only the substrate diffraction peaks,
while in GI-XRD also a number of new peaks appear due to the Eu_2O_3 film**

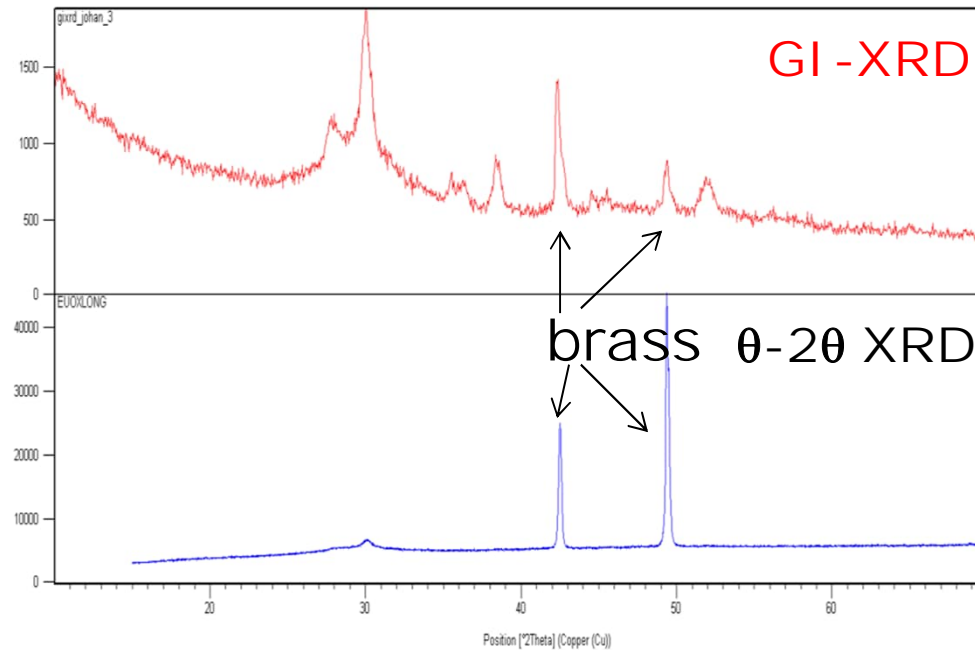

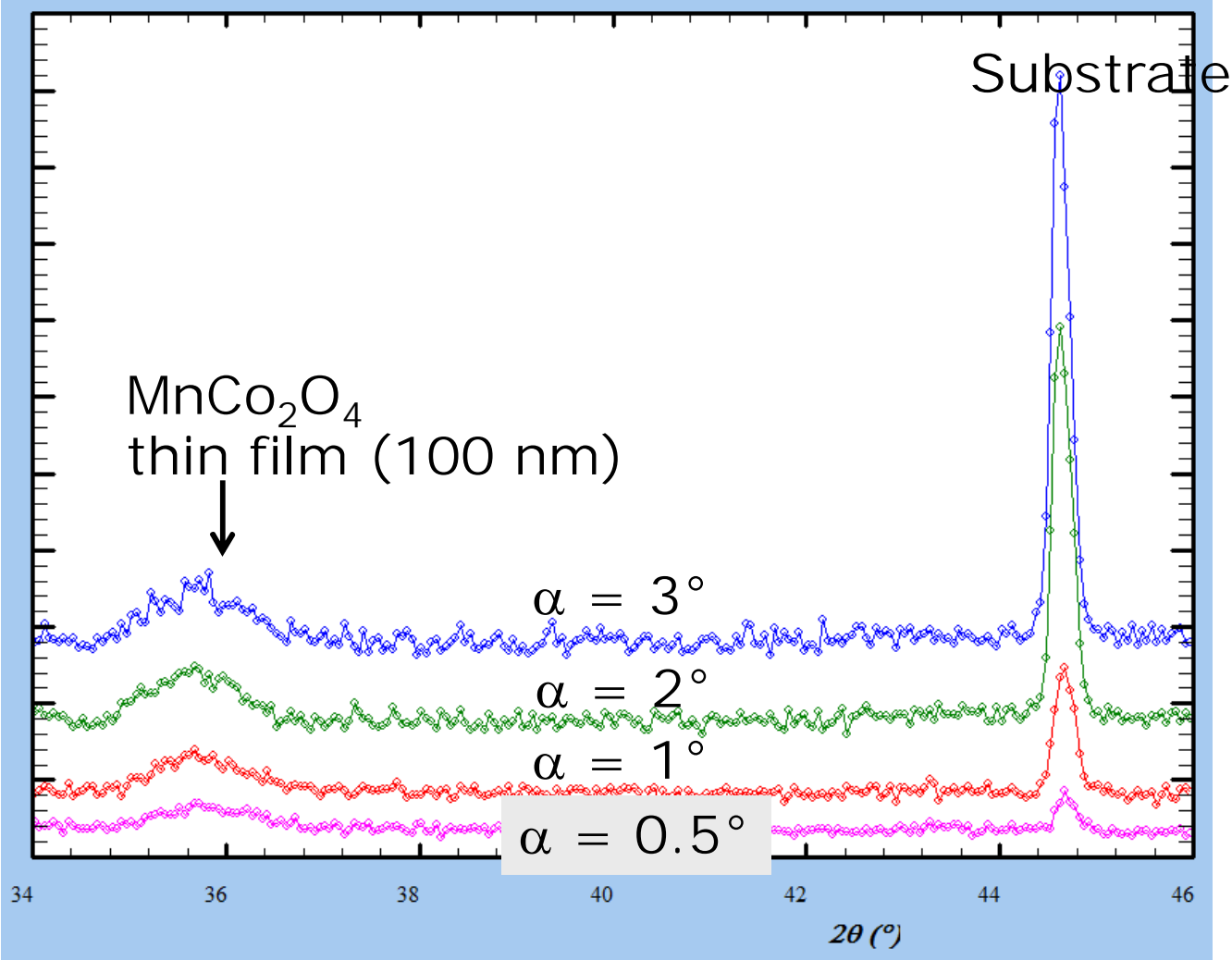

- With increasing incident angle (α), X-rays penetrate deeper
- Peaks due to the thin film increase in intensity
- Also the substrate peaks (may) get enhanced
- NOTE the different peak widths for substrate and thin film (different crystallite sizes)

GI-XRD: Depth profile analysis

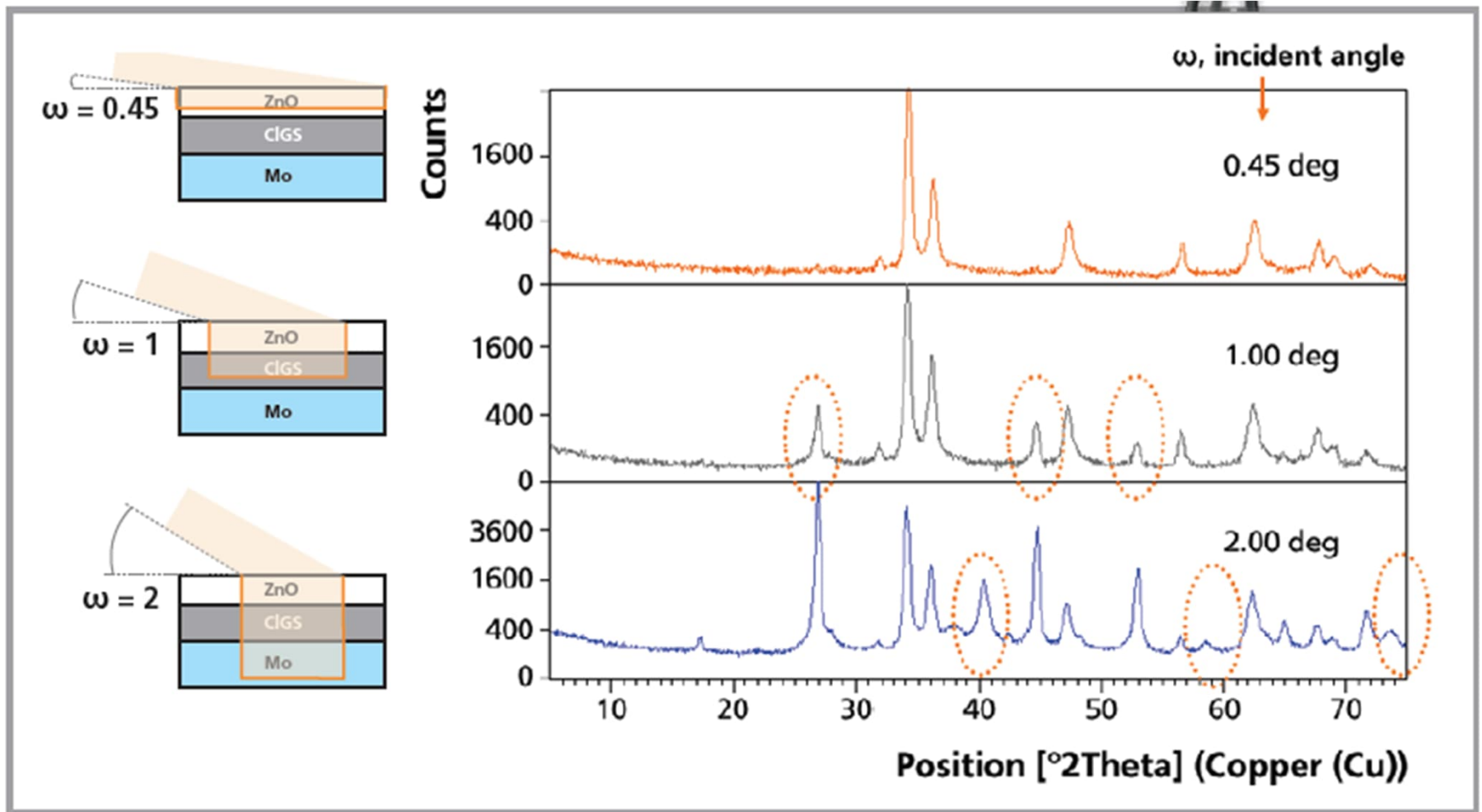

An example of depth probing on a CIGS solar structure, showing the different layers exposed to the parallel X-ray beam in a sequential mode by varying the incident angle. Top pattern is from the conductive oxide layer only, with CIGS coming in (middle, highlighted) and next the Mo metal contact layer appearing (bottom diagram, Mo peaks highlighted).

EXERCISE

Here are "ordinary" θ - 2θ XRD (blue) and GI-XRD (red) patterns for a 200-nm ZnO thin film grown by ALD on a p-type (100) silicon wafer substrate. Explain the differences (and reasons) seen in the patterns.

In the blue pattern there are two sharper peaks seen around 33° and 69° ; can you imagine any reason why they are sharper than the other peaks, i.e. what could be the origin of these peaks?

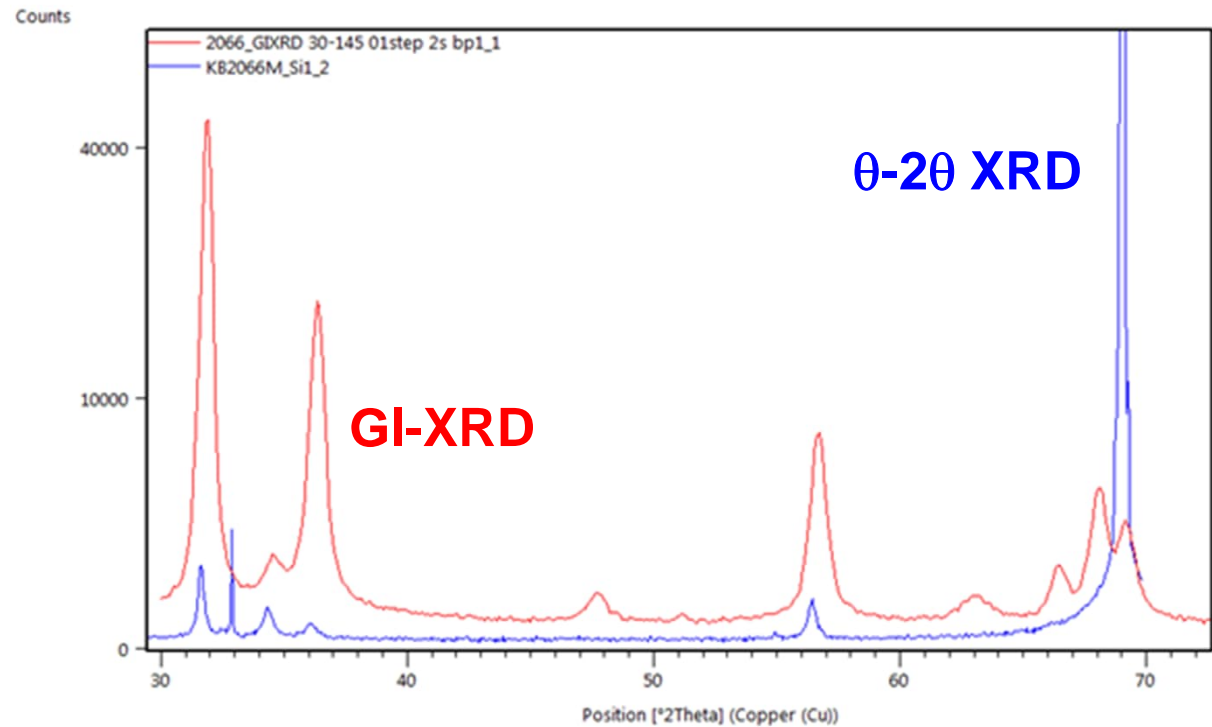

Neutron research facilities worldwide



NEUTRON FACILITIES **WE HAVE BEEN USING**

EUROPE

- Neutron Research Laboratory (NFL), Studsvik, SWEDEN (shut down)
- Petersburg Nuclear Physics Institute, Gatchina, RUSSIA
- Joint Institute for Nuclear Research (FLNP/JINR), Dubna, RUSSIA
- Institute for Energy Technology (IFE), Kjeller, NORWAY
- Institut Laue-Langevin (ILL), Grenoble, FRANCE
- **Pulsed Neutron Source (ISIS), Oxford, UK (today's example)**

USA

- Argonne National Laboratory (IPNS), USA (temporarily closed)
- **Oak Ridge National Laboratory, Spallation Neutron Source (SNS), USA (today's example)**

JAPAN

- Japan Atomic Energy Research Institute (JAERI), Tokai, JAPAN

AUSTRALIA

- Bragg Institute (ANSTO), Sydney, AUSTRALIA **(today's example)**

The ESRF* & ILL* With Grenoble & the Beldonne Mountains



*ESRF = European Synchrotron Radiation Facility; ILL = Institut Laue-Langevin

Some historical steps

- 1932 Chadwick: neutrons
- 1936 Diffraction of neutrons
- 1944 Fission nuclear reactors → progress in ND methods (Brockhouse & Shull, **Nobel 1994**)

The Neutron has Both Particle-Like and Wave-Like Properties

- Mass: $m_n = 1.675 \times 10^{-27}$ kg
- Charge = 0; Spin = $\frac{1}{2}$
- **Magnetic dipole moment:** $\mu_n = -1.913 \mu_N$
- Nuclear magneton: $\mu_N = eh/4\pi m_p = 5.051 \times 10^{-27}$ J T⁻¹
- Velocity (v), kinetic energy (E), wavevector (k), wavelength (λ), temperature (T).
- $E = m_n v^2/2 = k_B T = (hk/2\pi)^2/2m_n$; $k = 2\pi/\lambda = m_n v/(h/2\pi)$

“Thermal” neutrons have the proper energy & wavelength for crystal structure determination through diffraction →

	<u>Energy (meV)</u>	<u>Temp (K)</u>	<u>Wavelength (nm)</u>
Cold	0.1 – 10	1 – 120	0.4 – 3
Thermal	5 – 100	60 – 1000	0.1 – 0.4
Hot	100 – 500	1000 – 6000	0.04 – 0.1

1 – 4 Å

$$\lambda \text{ (nm)} = 395.6 / v \text{ (m/s)}$$

$$E \text{ (meV)} = 0.02072 k^2 \text{ (k in nm}^{-1}\text{)}$$

PRODUCTION OF NEUTRONS: Nuclear reaction

- Typical fission reaction: $^{235}\text{U} + n_{\text{therm}} \rightarrow A + B + 2.3 n$
- These produced neutrons are slowed/moderated (e.g. with H_2O), after which they continue the fission reaction → **chain reaction**
- Typical research reactors: 10 - 100 MW (e.g. Grenoble 57 MW)
- Research reactors can not be used for energy production and *vice versa*

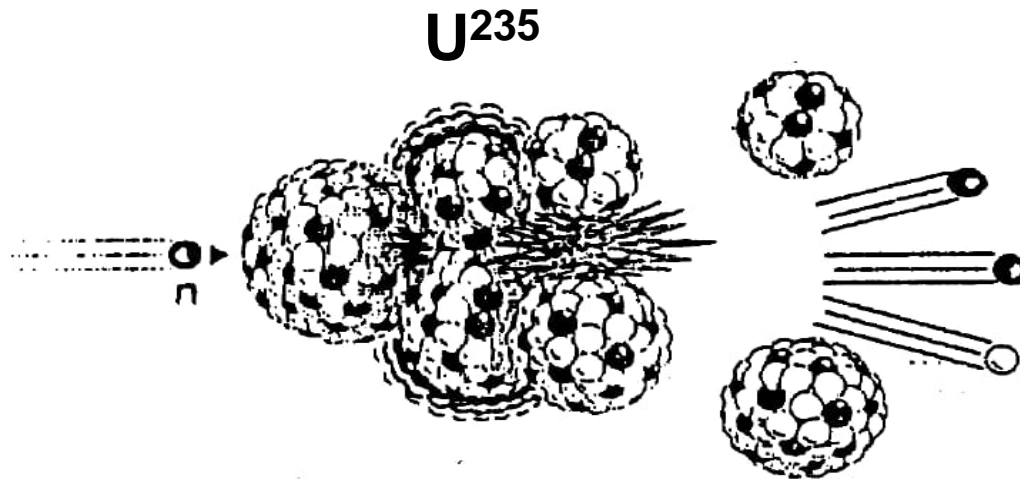

Neutron Sources Provide Neutrons for Many Spectrometers: Schematic Plan of the ILL Facility

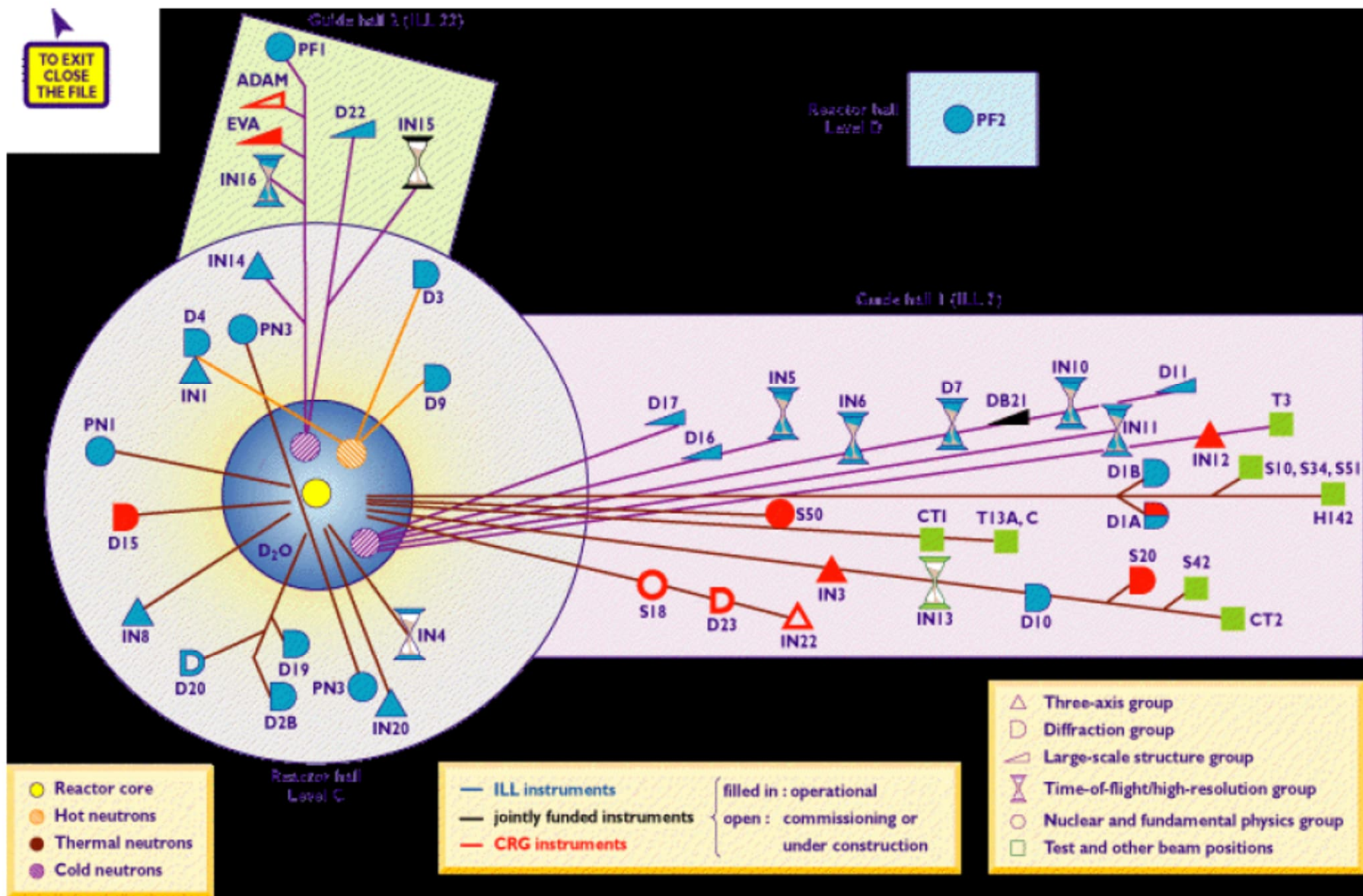

PRODUCTION OF NEUTRONS: **Spallation**

- Heavy metal (e.g. Hg, W) nuclei bombarded with high-energy protons ($E_p = 800 \text{ MeV}$)
- Protons from particle accelerators
- Typical reaction: $\text{Hg} + p \rightarrow \text{spallation product} + x n$
- x depends on E_p and the heavy metal employed
- For example: ^{238}U and $E_p = 800 \text{ MeV}$, $x = 28$
- Pulsed proton accelerator \rightarrow pulsed neutron flux
 \rightarrow **time-of-flight measurement**

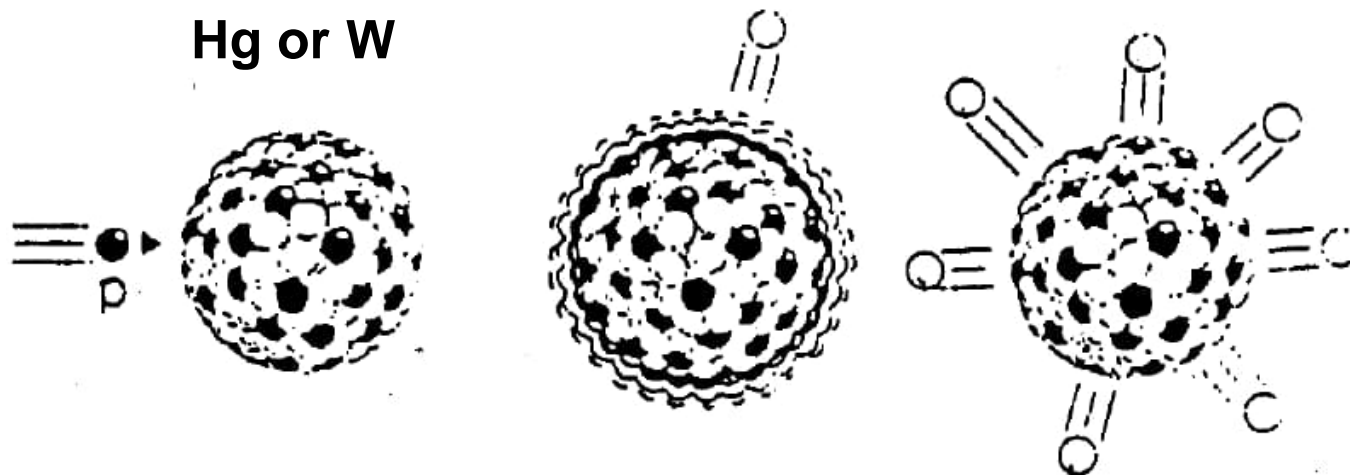



Science & Technology Facilities Council

ISIS

- **Spallation source**
- **Located in Oxfordshire, UK**
- **Isis is the local name for the River Thames**



TIME-of-FLIGHT DETECTOR

- Mandatory with spallation sources
- Detector is fixed at a certain 2θ value
- De Broglie relationship + Bragg's law:
- $\lambda = h/m_n v_n = 2d_{hkl} \sin\theta$
- Time-of-flight becomes: $t = 2d_{hkl} L(m_n/h) \sin\theta$
- Time-of-flight depends on d_{hkl} if all other parameters are fixed

Neutron Powder Diffraction using Time-of-Flight

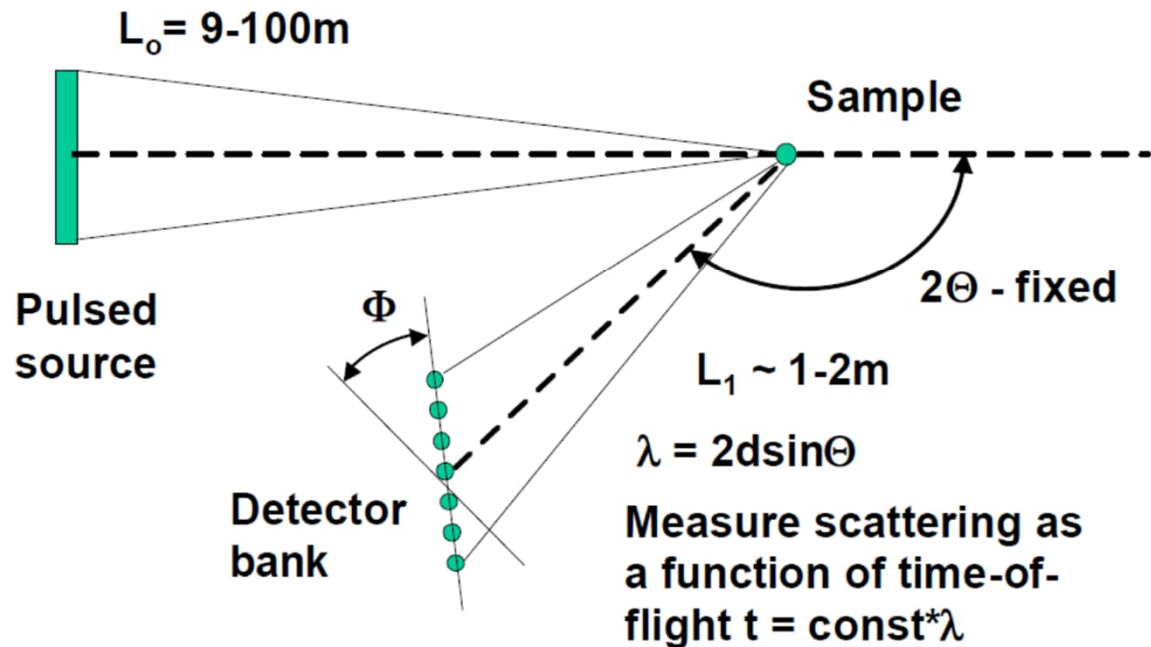

NEUTRON (powder) DIFFRACTION (ND)

- Elastic (= no energy lost) neutron scattering

- Production of neutrons: (i) nuclear reactor
(ii) spallation source
- Wavelength of so-called "thermal neutrons" $1 \sim 10 \text{ \AA}$
→ crystal structure determination
- Wavelength of neutron flux is less accurate than that of characteristic x-ray radiation → Lattice parameters are determined less accurately from ND than from XRD
- Neutron scattering weaker than x-ray scattering
→ Large sample amounts needed
- Neutron scattering does not depend on the reflection angle (x-ray scattering does)
- Neutron flux scatters from atomic nuclei → Scattering factor does not depend on electron density (atomic number)
→ Light and heavy atoms may be equally visible for neutrons

**Challenge to
separate a narrow
wavelength range**

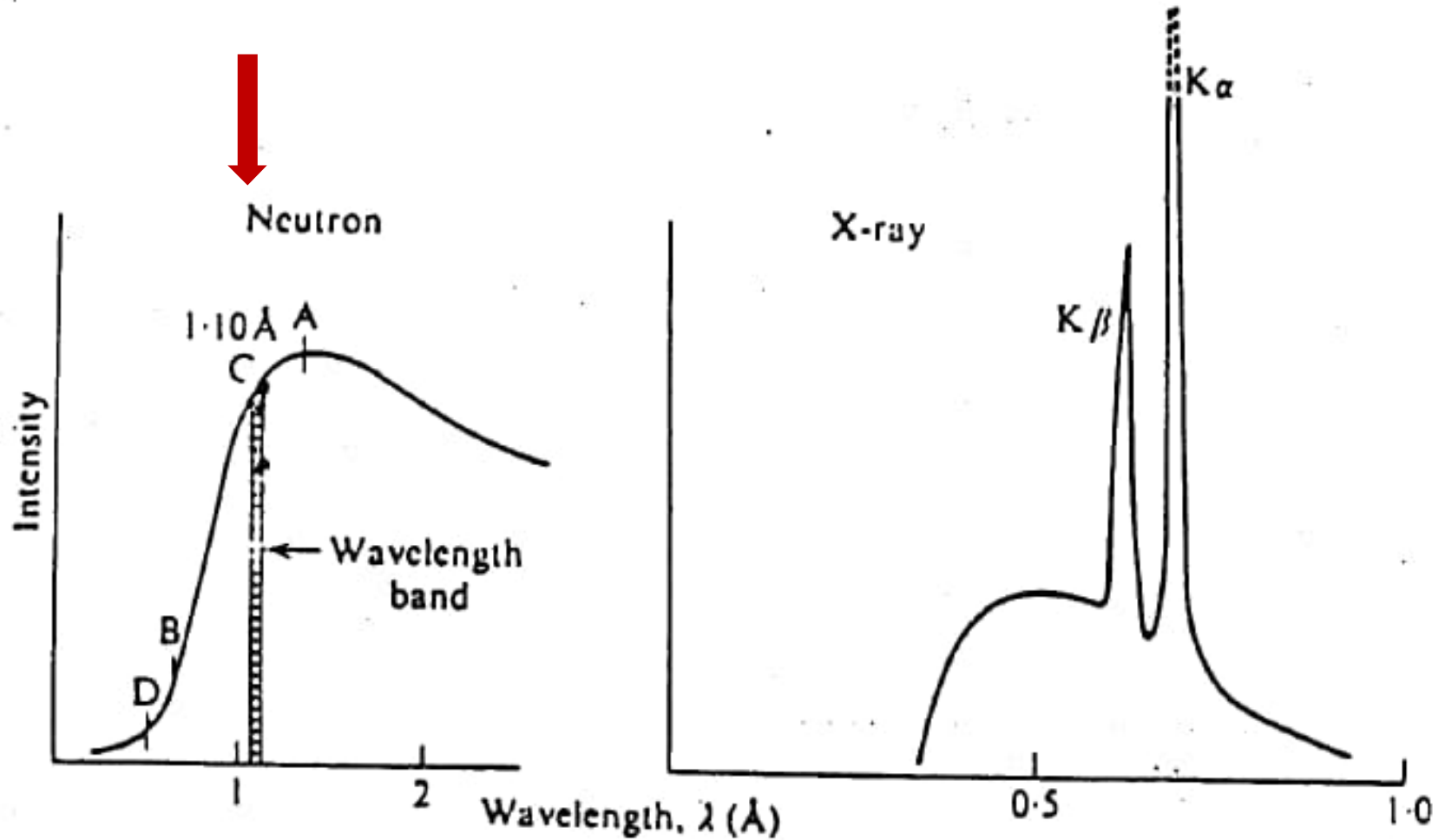

Neutrons scatter from an atomic nuclei

- **Scattering strength does not depend on atomic number**
 - positions of light elements (e.g. H and O) can be determined with the same accuracy as those of heavy elements
 - highly useful for example in studies on perovskite oxides
 - sometimes solving an unknown structure is more difficult with ND than with XRD, since all the atoms are "seen"
- **No "bonding effects" in atomic positions**
 - important when hydrogen-bonded structures are studied (ND reveals typically ~ 0.2 Å longer O-H bonds than XRD)
- **Scattering strength may vary strongly among different isotopes of the same element**
 - "isotope substitution"
- **Neutron scattering factor can be also negative !**

Scattering strength

- Tells how strongly neutrons/ x-rays are scattered (= diffracted)
- OTHER TERMINOLOGIES: Scattering factor, Scattering length, Scattering amplitude, Scattering cross-section, Form factor

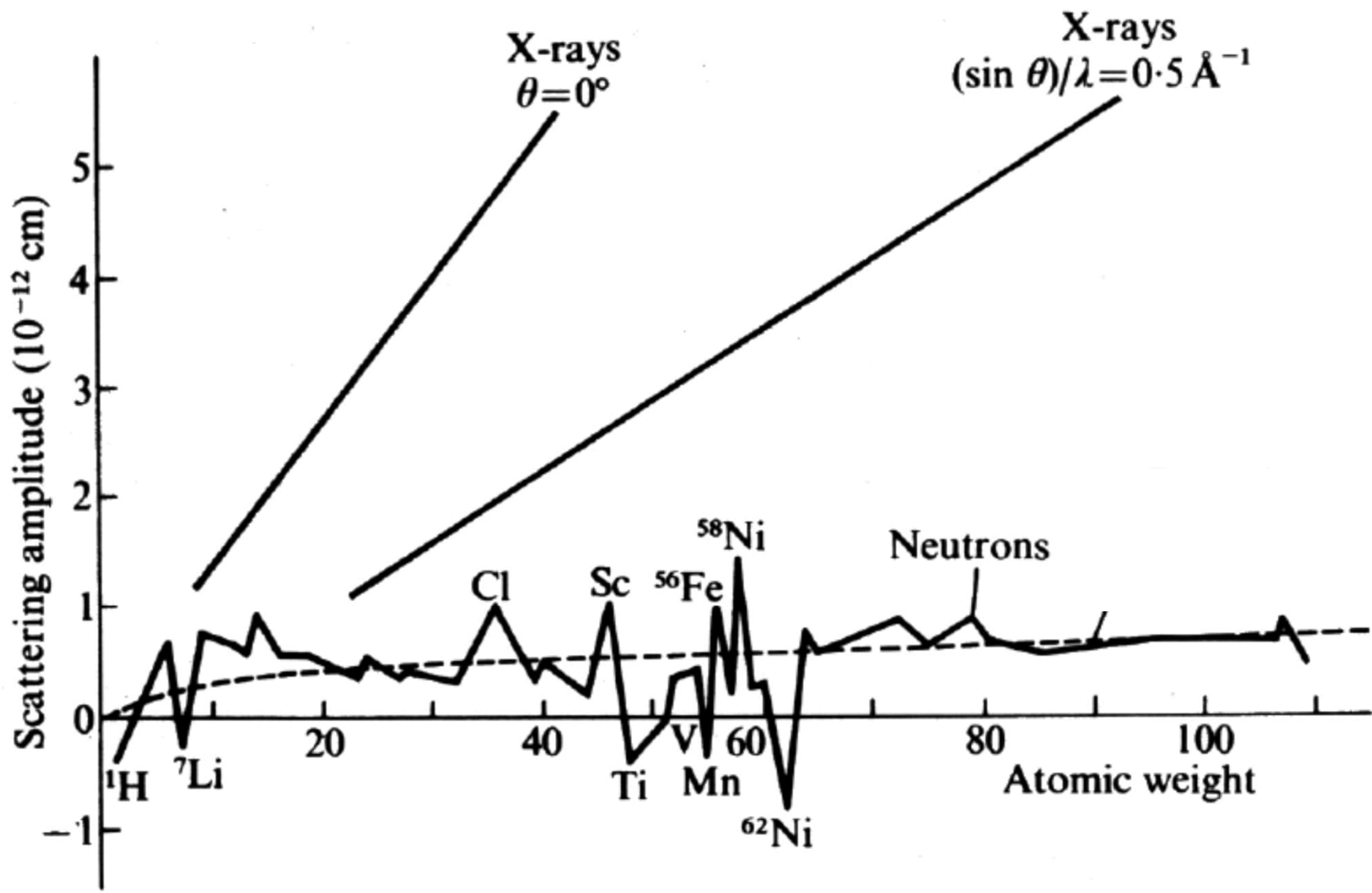

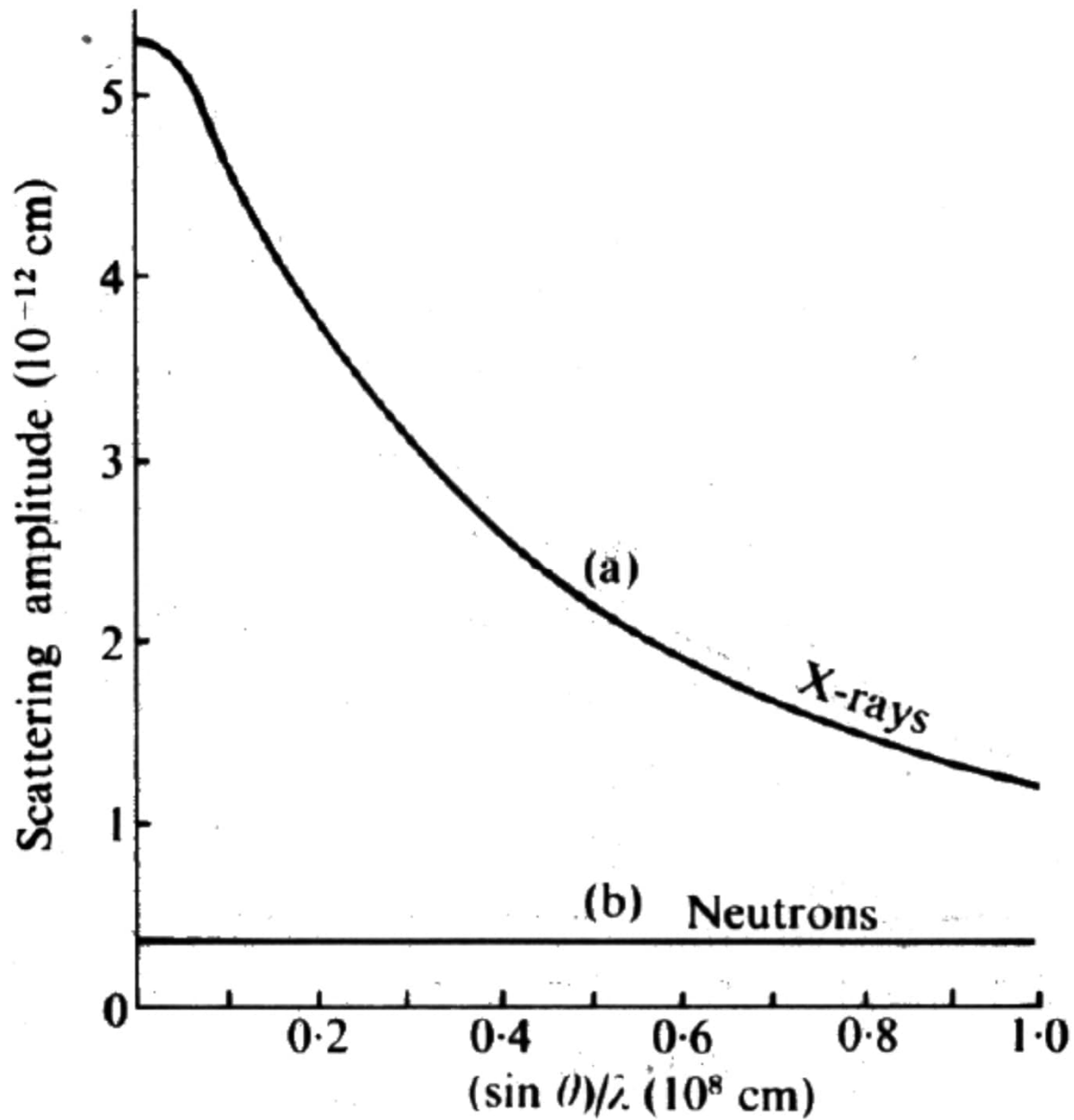

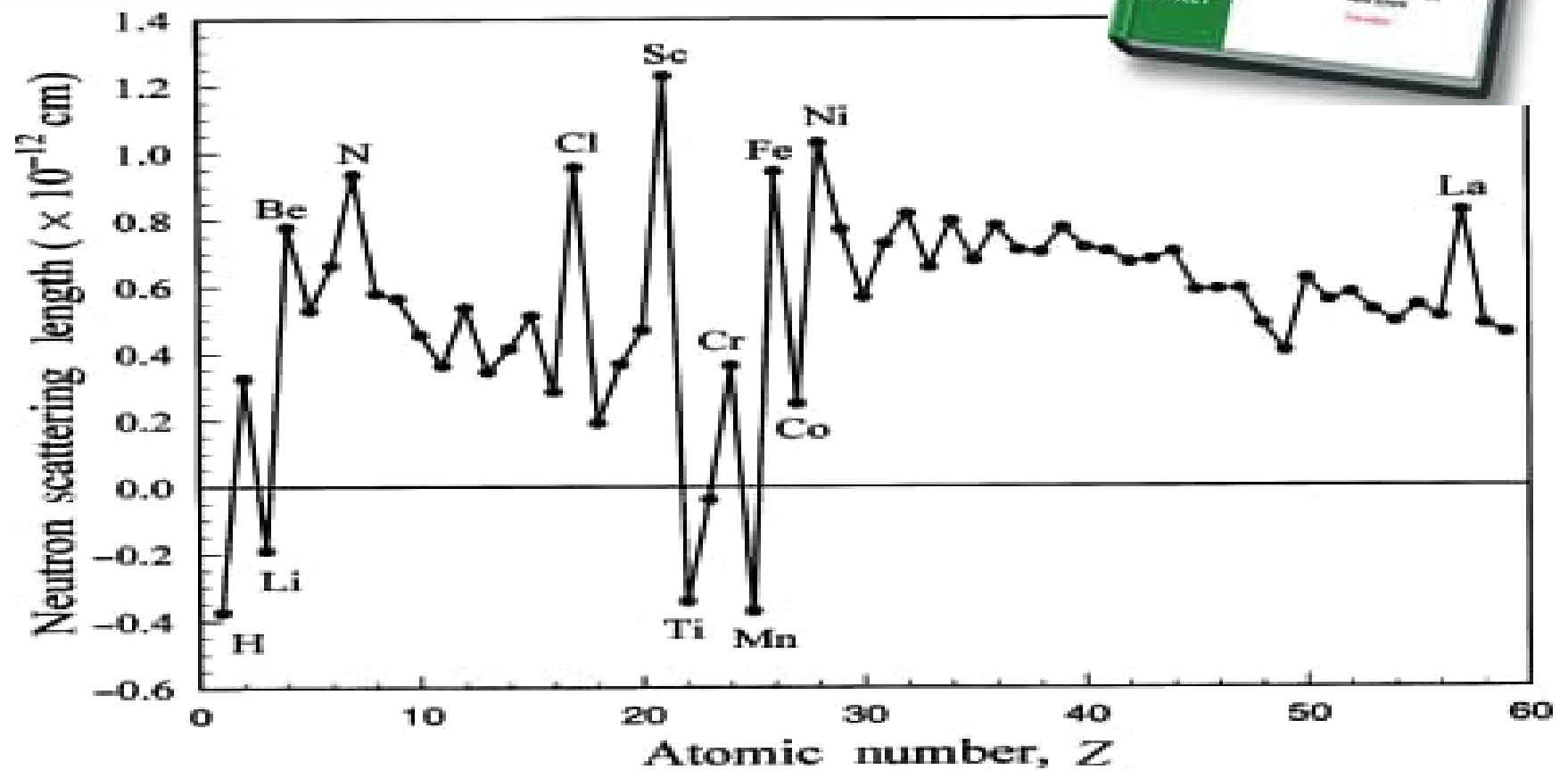
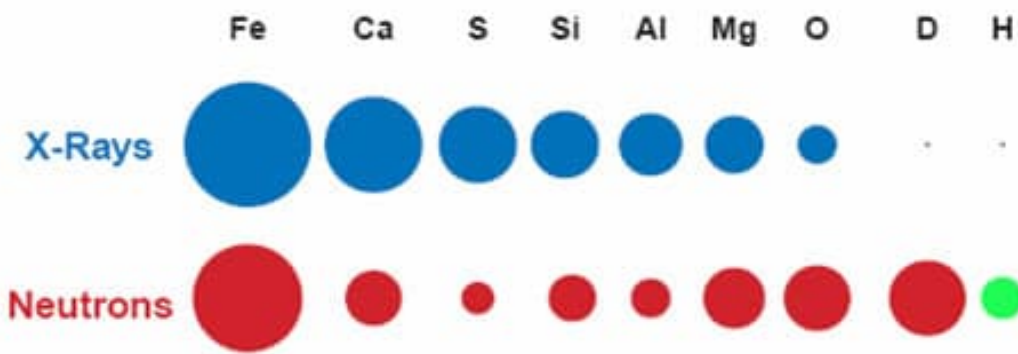

Nuclei Seen by X-Rays

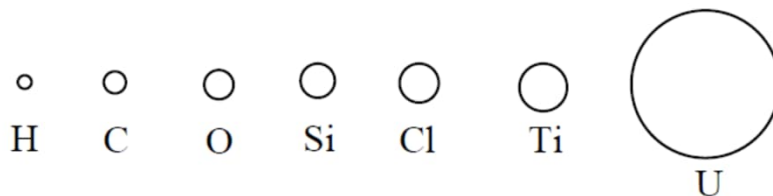

X-rays interact with the electron cloud

Nuclei Seen by Neutrons

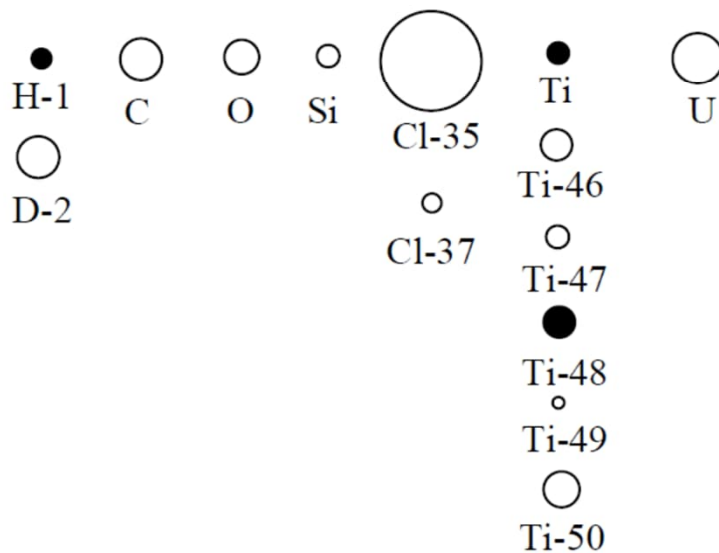

Neutrons interact with the nuclei

SAMPLES

- single crystal (optimally roundish: XRD 0.1 ~ 0.3 mm, ND ~1 cm)
- **powder: XRD >10 mg , ND preferably >1 g**
- thin film: XRD, ED
- amorphous material: XRD, ND
- liquid: XRD (θ - θ geometria)
- gas (ED); electron diffraction is a very local method

Vanadium
SAMPLE HOLDERS
for ND



Why ND and XRD patterns for the same sample may look different ?

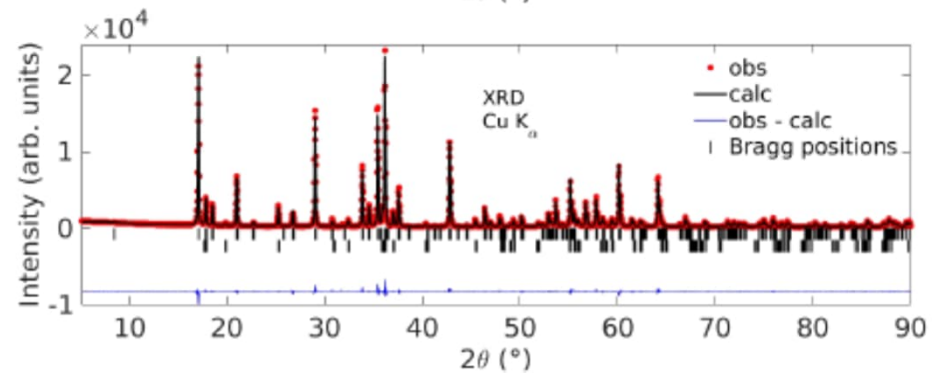
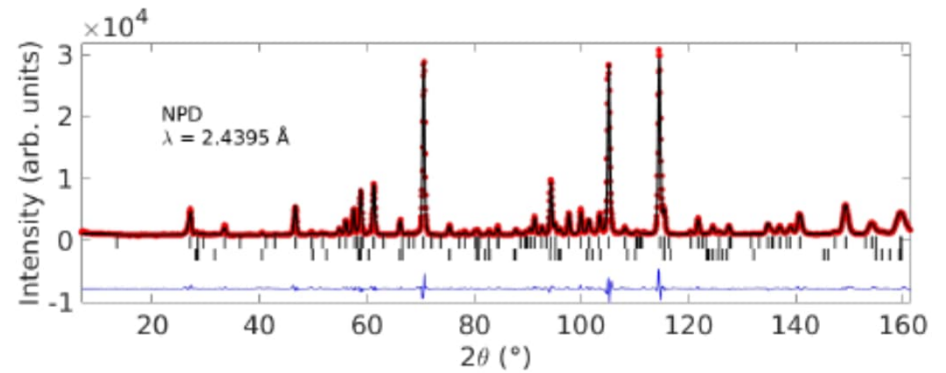
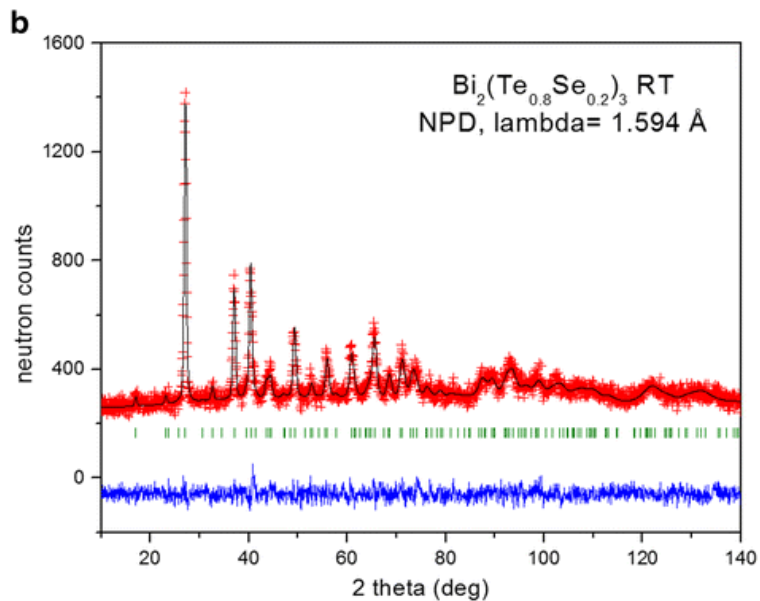
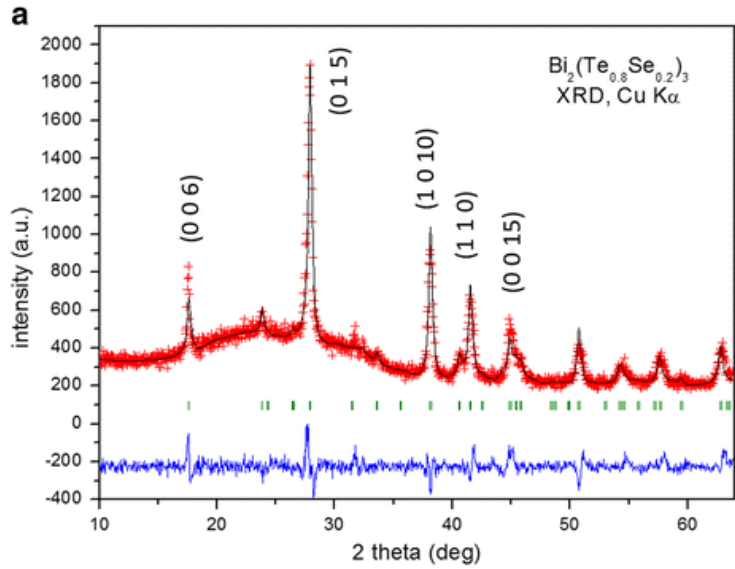
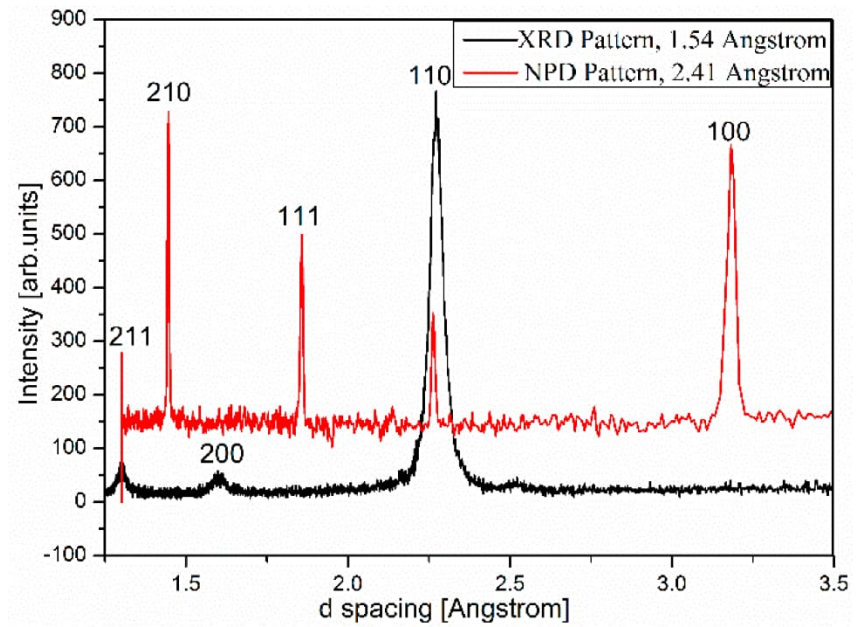

Why ND and XRD patterns for the same sample look different ?

- Different λ → To make them similar, plot in terms of d
- Wavelength range narrower for XRD (sharper peaks)
- Different sample preparation → Different orientation of crystallites
- Scattering factor depends on angle in XRD, not in ND
- Different atomic/nucleic scattering factors → Different peak intensity ratios
- ND sees magnetic ordering too, XRD not

Neutrons possess magnetic moment

- Neutrons have magnetic moment (though no electric charge)
- Stronger scattering from atoms with ordered spin → magnetic structure determination

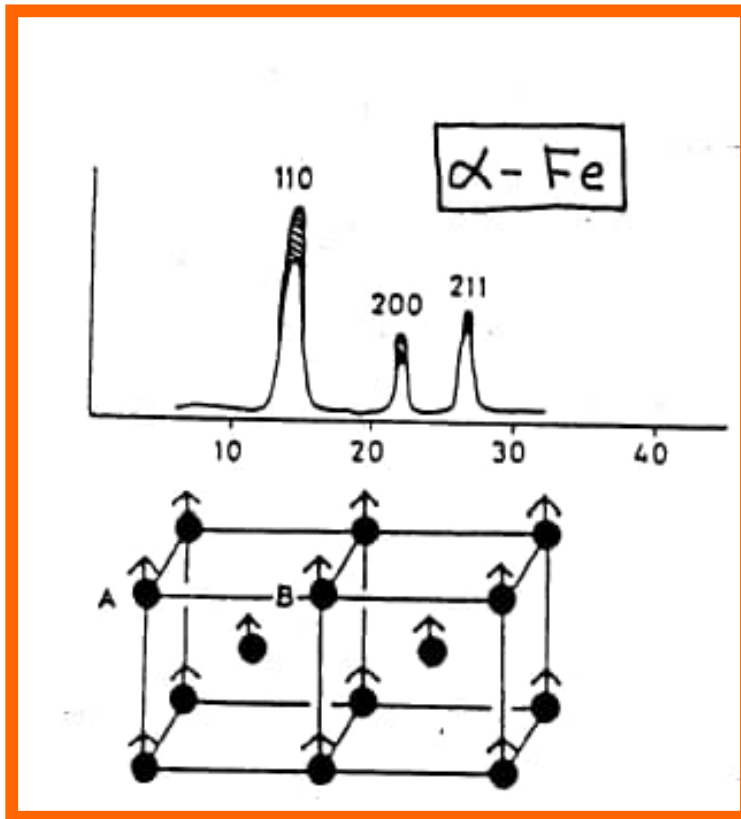

Ferromagnetic:
- changes in peak intensities

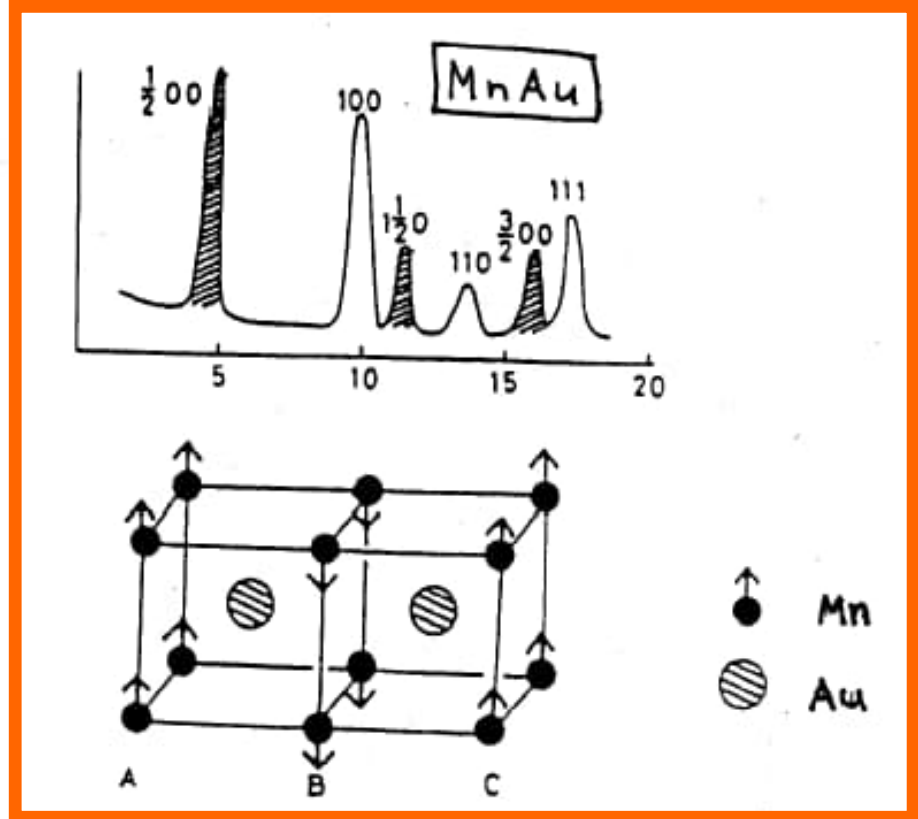

Antiferromagnetic:
- additional peaks

Antiferromagnetic hematite Fe_2O_3

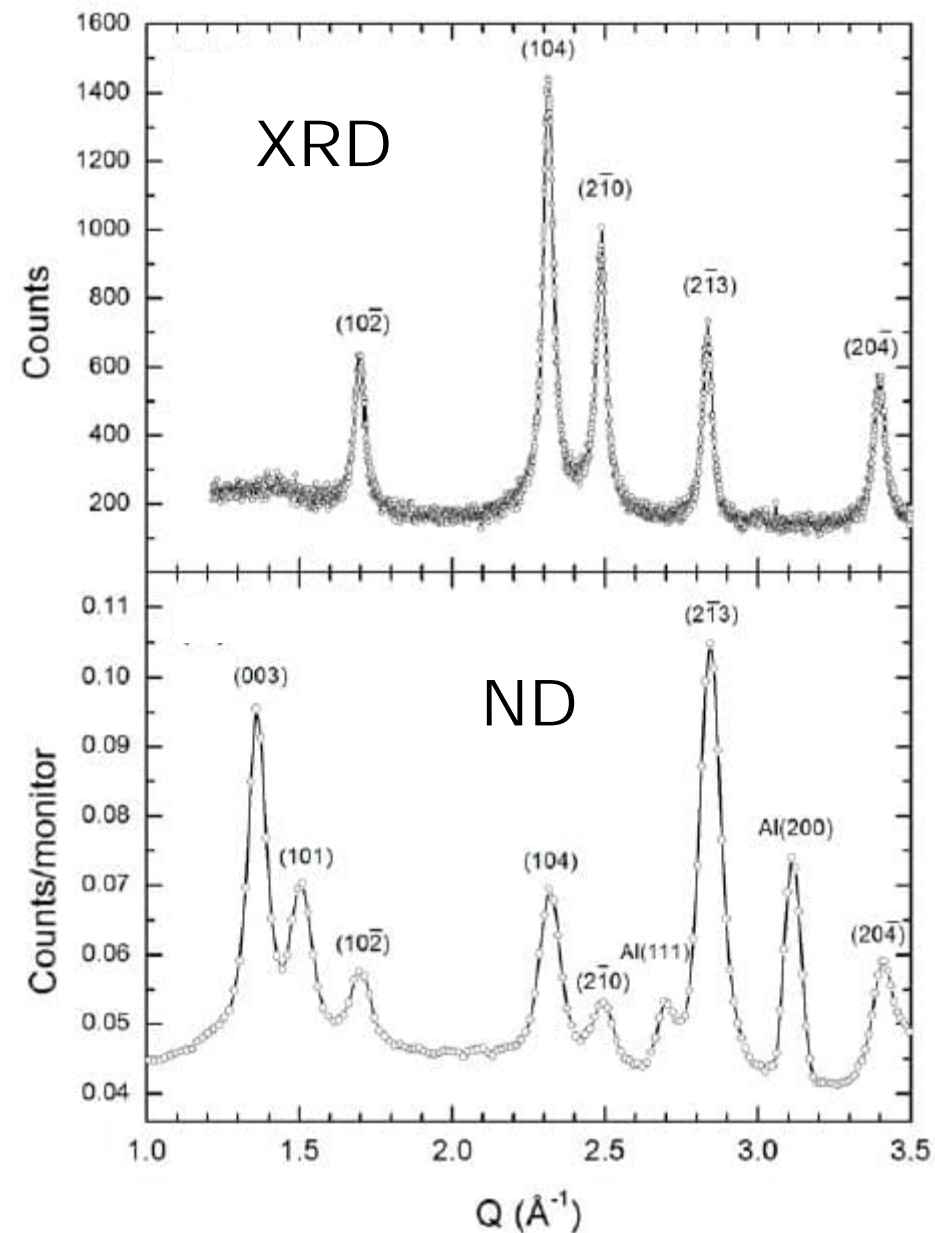

Antiferromagnetic MnO ($T_N \approx 120$ K)

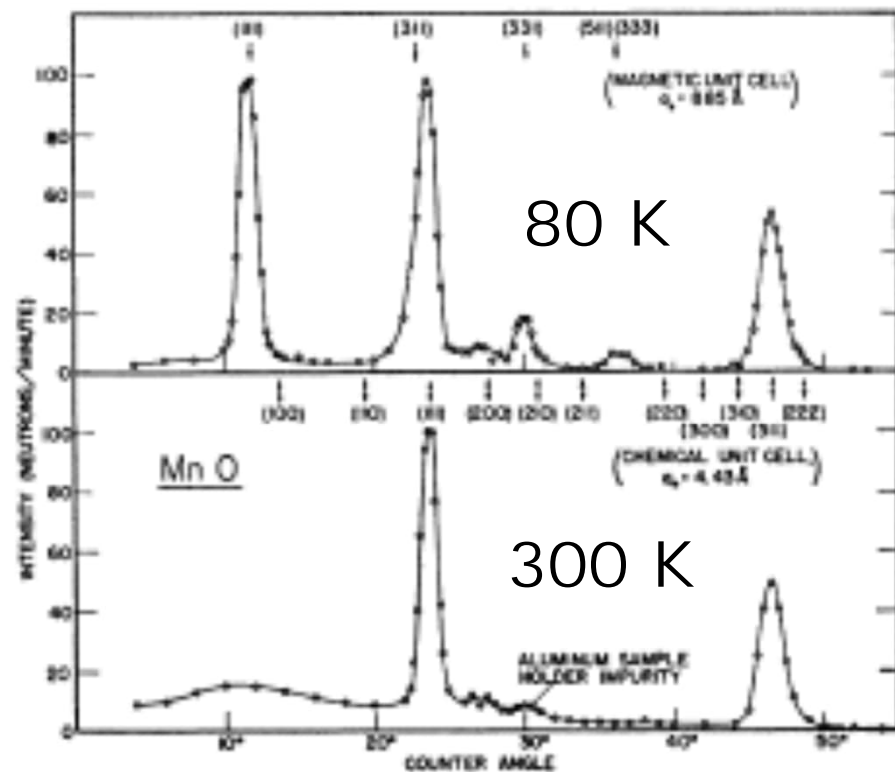
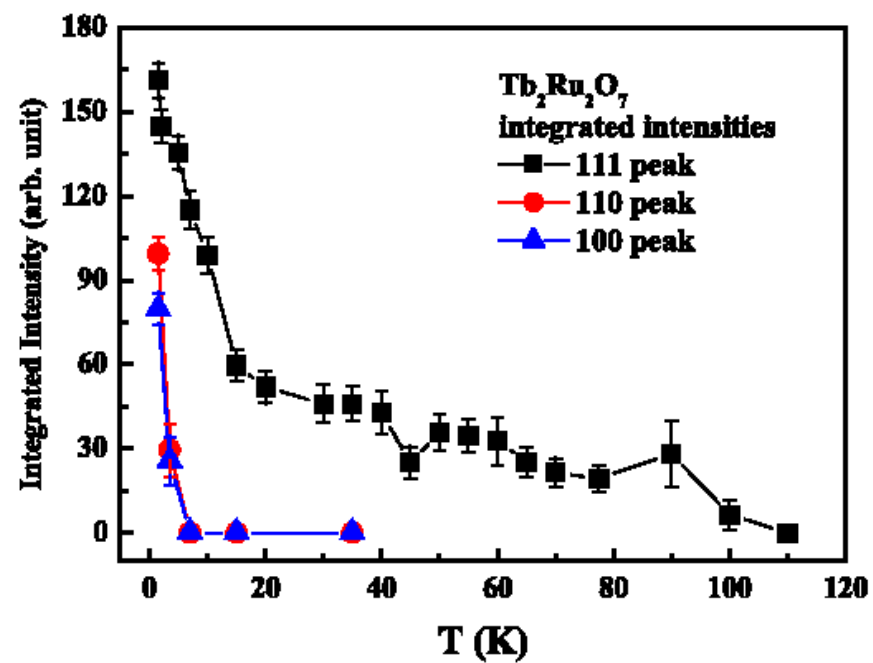
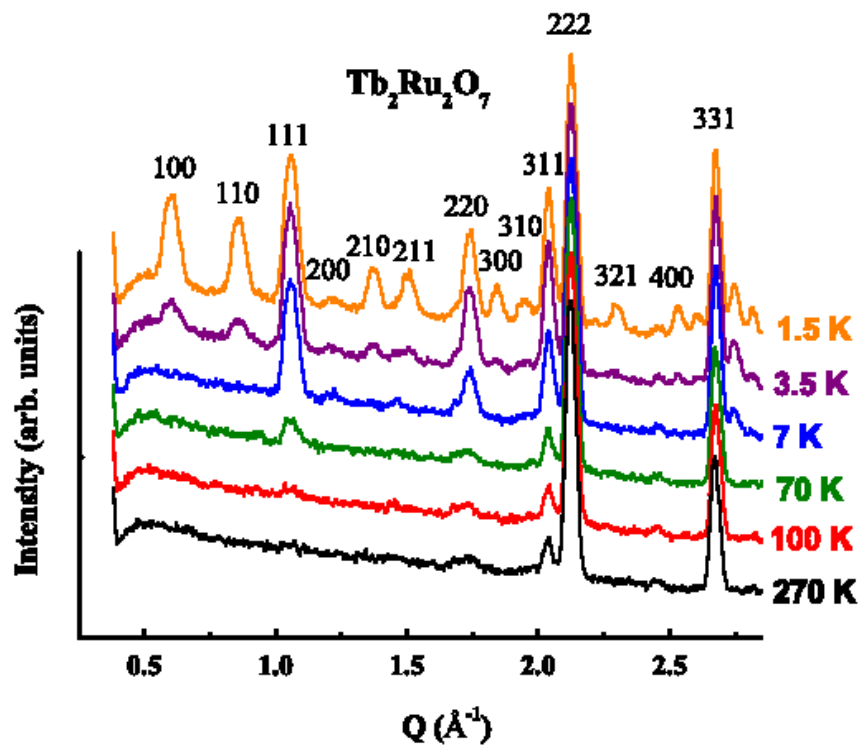

FIG. 1. Neutron diffraction patterns for MnO at room temperature and at 80°K.



Inelastic neutron scattering

Energy of thermal neutrons \approx

Energy of lattice vibrations (~ 10 meV)

→ **I**nelastic scattering

→ Energy spectrum of phonons

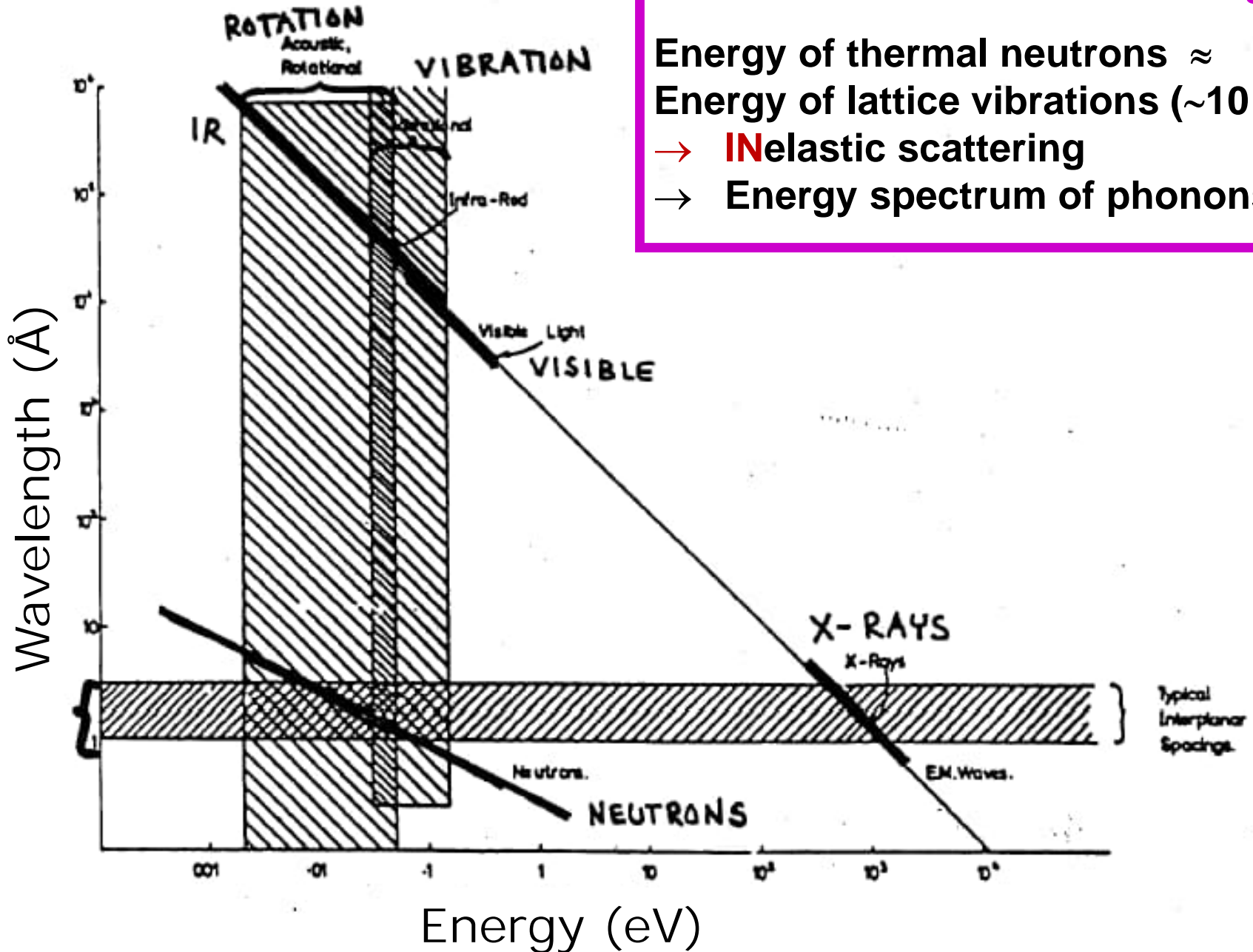

RESEARCH EXAMPLE from our lab

Double Perovskites $\text{Sr}_2\text{Cu}(\text{W},\text{Mo})\text{O}_6$

- **B-site ordered DP**
- Sr_2CuWO_6 : synthesis in air
- $\text{Sr}_2\text{CuMoO}_6$: high-pressure synthesis (only very small sample amounts!)
- Cu^{II} : d^9 (Jahn-Teller) & magnetic ($S = 1/2$)
- **WE EXPECTED:**
 - Low-dimensional (2D) magnetism
 - Interesting quantum effects
- **Magnetic measurements (SQUID):**
some magnetic transition around 25 K
- **URGENT QUESTION:**
is it long-range magnetism (FM or AFM ?)

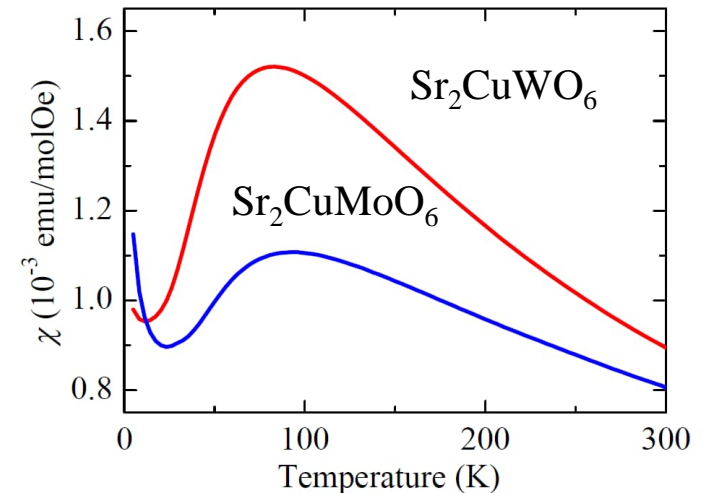
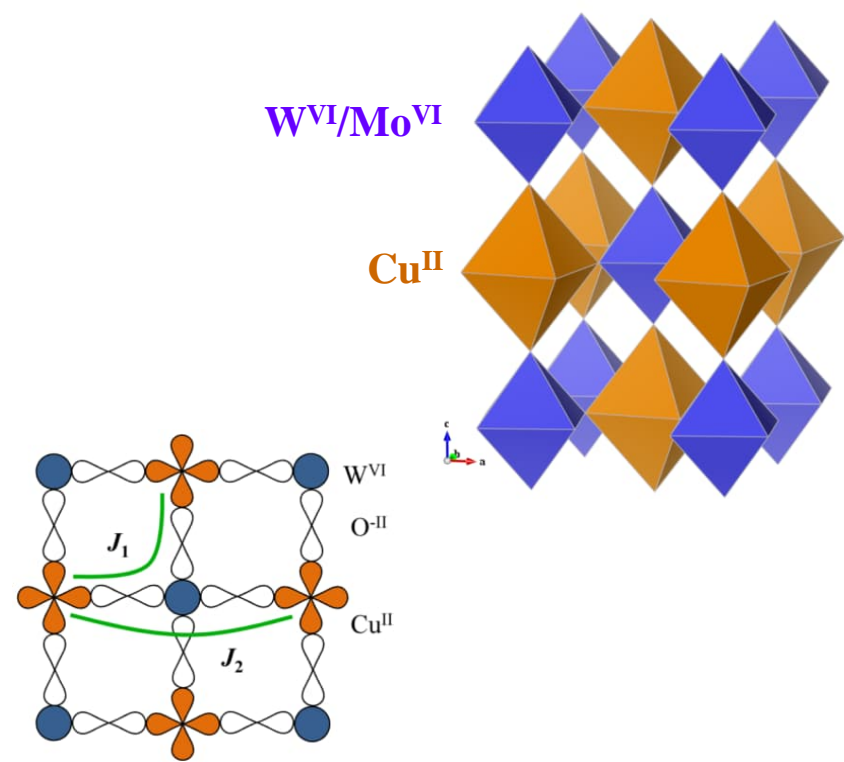

S. Vasala, J.-G. Cheng, H. Yamauchi, J.B. Goodenough & M. Karppinen, $\text{Sr}_2\text{Cu}(\text{W}_{1-x}\text{Mo}_x)\text{O}_6$: a quasi-two-dimensional magnetic system, *Chemistry of Materials* **24**, 2764 (2012).

We started with: Sr_2CuWO_6 (normal-pressure synthesized)

MUON SPIN EXPERIMENTS

- Paul Scherrer Institute, Switzerland
- Long-range order below 24 K !
- **QUESTION:** Can we confirm this with ND, and determine the magnetic structure

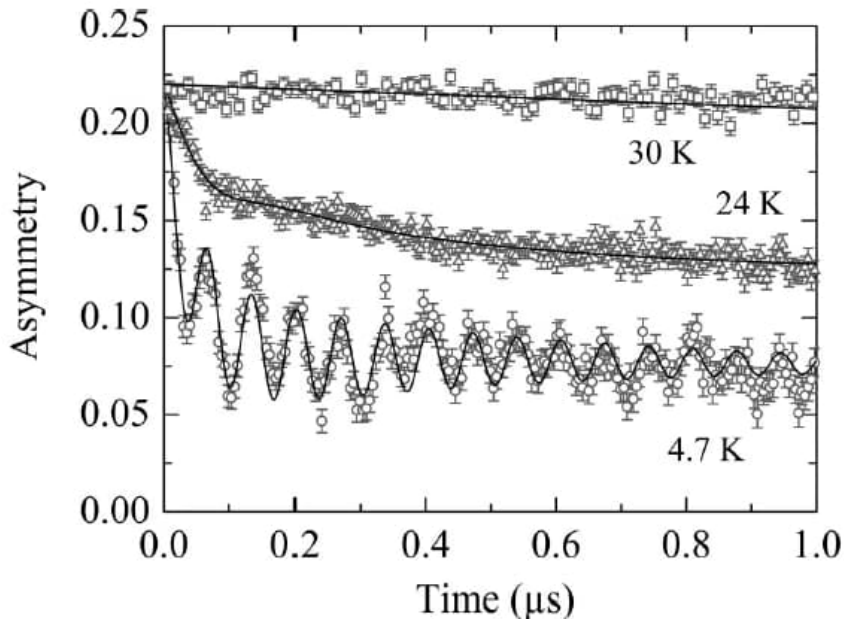

NEUTRON DIFFRACTION

- POWGEN beamline, SPS, Oak Ridge National Laboratory, USA
- No additional magnetic reflections (10 K versus 100 K) seen, WHY ?
- Sample amount large (~5 g) but the expected magnetic moment small ($< 0.5 \mu_B$)

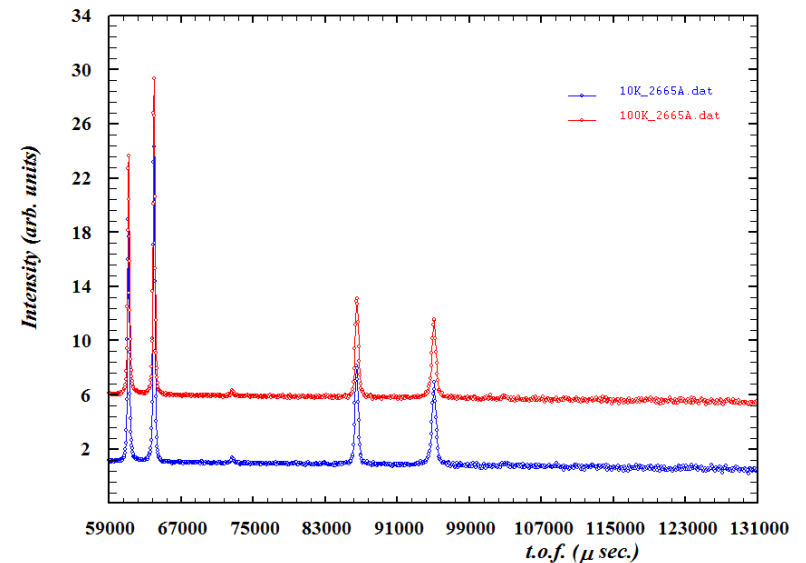

Vasala, Saadaoui, Morenzoni, Chmaissem, Chan, Chen, Hsu, Yamauchi & MKarppinen, Characterization of magnetic properties of Sr_2CuWO_6 and $\text{Sr}_2\text{CuMoO}_6$, *Physical Review B* **89**, 134419 (2014).

HIGH-FLUX NEUTRON DIFFRACTION

- High-flux triple-axis spectrometer Taipan, OPAL reactor, **ANSTO**, Australia
- Clear **additional magnetic reflections** (3 K versus 30 K)
- Type-II antiferromagnetic structure (in agreement with our electronic structure calculations)

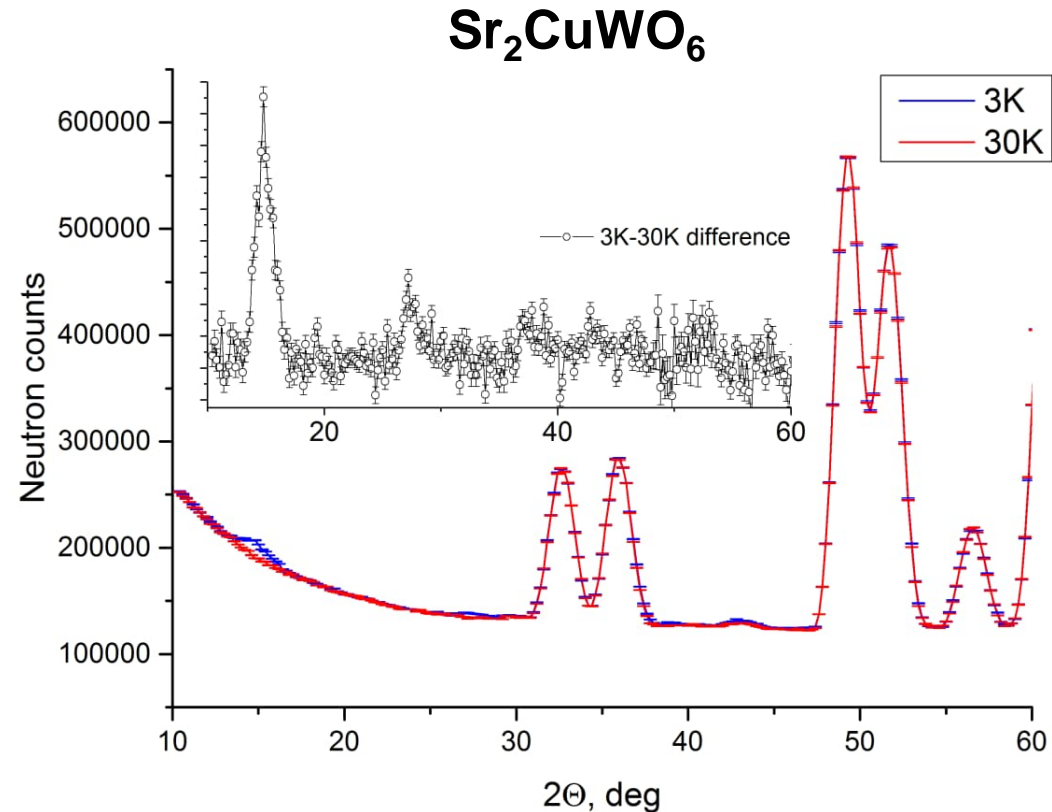
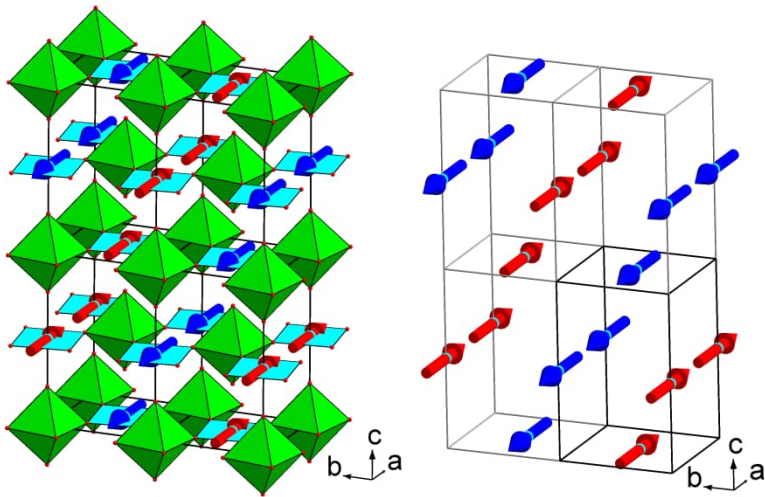

RESEARCH CONTINUES ...

- Magnetic structures of **high-pressure synt.** Sr_2CuBO_6 : $B = \text{Mo, Ir, Te}$
- **Small sample** amount of 50 ~ 200 mg !
- **High-flux** and **huge-detector-area** WISH diffractometer, **ISIS**, Oxford, UK (optimized for detecting low magnetic intensity from small sample sizes)
- Later: **discovery of rare spin-liquid-like state** in $\text{Sr}_2\text{Cu}(\text{Te}_{0.5}\text{W}_{0.5})\text{O}_6$

S. Vasala, H. Yamauchi & M. Karppinen, Synthesis, crystal structure and magnetic properties of a new B -site ordered double perovskite $\text{Sr}_2\text{CuIrO}_6$, *Journal of Solid State Chemistry* **220**, 28-31 (2014).

H.C. Walker, O. Mustonen, S. Vasala, D.J. Voneshen, M.D. Le, D.T. Adroja & M. Karppinen, Spin wave excitations in the tetragonal double perovskite Sr_2CuWO_6 , *Physical Review B* **94**, 064411 (2016).

O. Mustonen, S. Vasala, K.P. Schmidt, E. Sadrollahi, H. C. Walker, I. Terasaki, F.J. Litterst, E. Baggio-Saitovitch & M. Karppinen, Tuning the $S = 1/2$ square-lattice antiferromagnet $\text{Sr}_2\text{Cu}(\text{Te}_{1-x}\text{W}_x)\text{O}_6$ from Néel order to quantum disorder to columnar order, *Physical Review B* **98**, 064411 (2018).

O. Mustonen, S. Vasala, E. Sadrollahi, K.P. Schmidt, C. Baines, H.C. Walker, I. Terasaki, F.J. Litterst, E. Baggio-Saitovitch & M. Karppinen, Spin-liquid-like state in a spin-1/2 square-lattice antiferromagnet perovskite induced by $d^{10}-d^0$ cation mixing, *Nature Communications* **9**, 1085 (2018).

O. Mustonen, S. Vasala, H. Mutch, C.I. Thomas, G.B.G. Stenning, E. Baggio-Saitovitch, E.J. Cussen & M. Karppinen, Magnetic interactions in the $S = 1/2$ square-lattice antiferromagnets $\text{Ba}_2\text{CuTeO}_6$ and Ba_2CuWO_6 : parent phases of a possible spin liquid, *Chemical Communications* **55**, 1132 (2019).

	X-rays	Neutrons	Electrons
Typical E / λ	12 keV / 1.0 Å	25 meV / 1.8 Å	50 kV / 0.05 Å
Scattering from	Electron cloud	Nuclei	Electric field (nucleus & electrons)
Detects	Electron density	Atomic positions	Atomic positions
Scattering strength	Strong, depends strongly on Z	Weak, no dependence on Z or angle	Very strong, depends on Z
Penetration	Good	Good	Bad
Sample amount	10 ~ 100 mg	0.1 ~ 10 g	"Local"
Magnetic structure	NOT possible	Possible	NOT possible
Wavelength	Well monochromatic	Not perfectly monochromatic	Extremely monochromatic

Compare X-ray & Neutron Powder Patterns

X-ray Diffraction - CuK α Phillips PW1710

- Higher resolution
- Intensity fall-off at small d spacings
- Better at resolving small lattice distortions



10.000 0.025 159.00 CPD RRRR PbSO4 Cu K α X-ray data 22.9.
Scan no. = 1 Lambda1,lambda2 = 1.540 Observed Profile

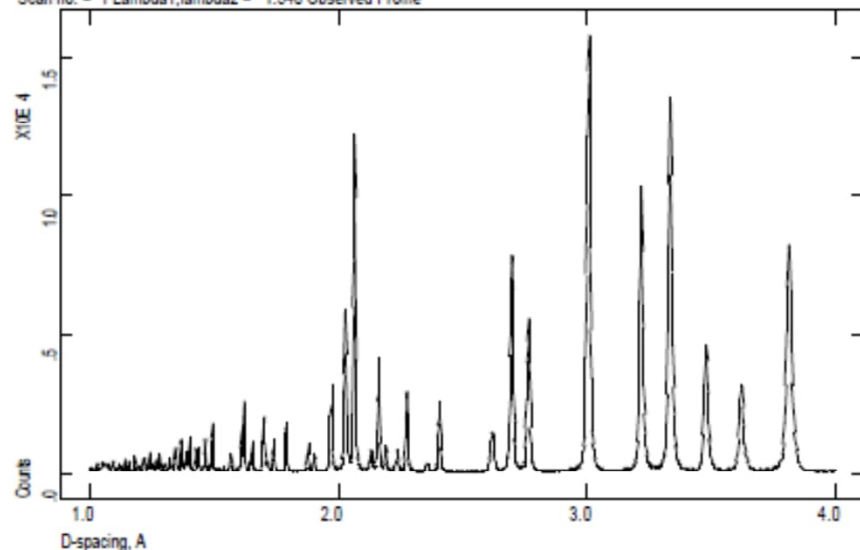

10.0 0.05 155.9 CPD RRRR PbSO4 1.909A neutron data 8.8
Scan no. = 1 Lambda = 1.9090 Observed Profile

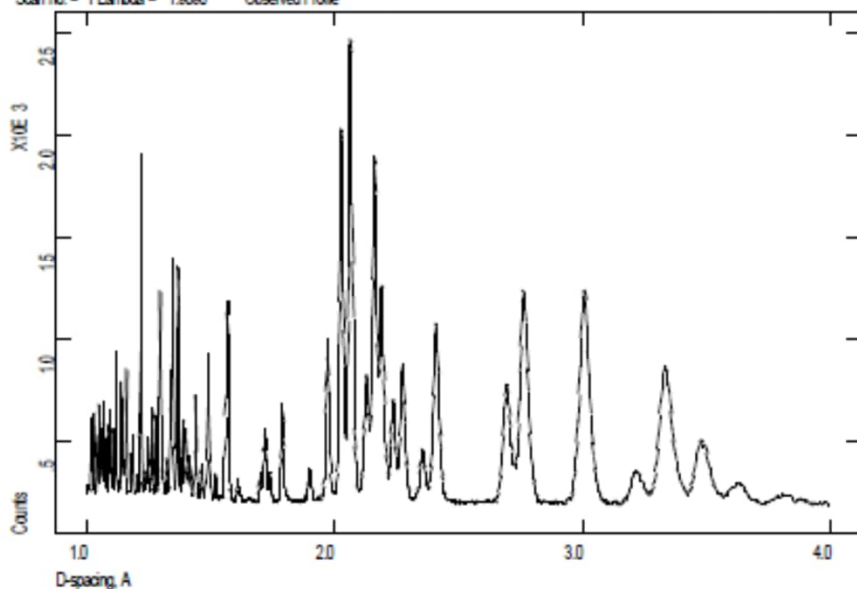

Neutron Diffraction - D1a, ILL $\lambda=1.909 \text{ \AA}$

- Lower resolution
- Much higher intensity at small d-spacings
- Better atomic positions/thermal parameters

