

Aalto ARTS

Summer School 2023

LIVING WITH WOODS.

views to forest – tree – wood

6.-18.8.2023

Pre-Course Symposium 25.5.2023

ARTS SUMMER SCHOOL 2023

DESIGN PROJECT 6.-18.8.2023

- During the two weeks on campus (6-18.8.2023) the groups will work on a design project.
- Students will be supported in their design with
 - short lectures / facilitated workshops
 - tutoring sessions
 - mid reviews
 - hands on work at the wood workshops.
- Design project
 - in groups of 5-6 people
 - mix of students from different institutions and disciplines
 - the projects will be showcased in an exhibition at the end of the summer school.



ARTS SUMMER SCHOOL 2023

DESIGN PROJECT 6.-18.8.2023

- The groups will design new living environments using wood and in balance with nature.
 - No net loss city
 - Sustainable use of wood and forests
 - Perspective of other species
- Site is the Otaniemi campus
 - Students can select their own site on the campus
- Design brief is open
 - Students can find their own approach to living environments.
 - The projects can be anything from student housing to insect hotels, urban interventions or developing the natural areas.



ARTS SUMMER SCHOOL 2023

DESIGN PROJECT 6.-18.8.2023 – AIM

Aim:

The aim of the two-week workshop is to study the use of wood in design interventions in the new living environment (ex. architecture, landscape architecture, interior architecture, design etc.) with the aim of causing no net loss in the natural environments. During the two weeks students will produce design proposals for new living environments on the Otaniemi campus that are in balance with nature and the wellbeing of humans and other species

The students will work in groups of 5-6 representing various disciplines and institutions. The groups are encouraged to produce designs utilizing the expertise of the various disciplines. The groups will select a concept or concepts studied in the pre-assignment as the basis for their project. These concepts are then applied to a design proposal on campus. **The groups will design new living environments using wood and in balance with nature.** The design solutions can range from student housing to pavilions and recreational areas in the public space.



ARTS SUMMER SCHOOL 2023

DESIGN PROJECT 6.-18.8.2023 – SCALES

The groups will work on three / four scales:

XL: global: The global scale considers how does the design project respond to global issues? There will not necessarily be any designs produced in this scale. The scale serves as a type of mission statement for the design project.

L: area / landscape: The large scale considers the whole Otaniemi campus area.

M: site / building / structure: The mid scale considers a selected site on the campus focusing on a building and its immediate surroundings.

S: detail / product / human scale: The smallest scale focuses on details, interior architecture or furniture design or products.

Each group determines how much they focus on each scale, but all scales should be considered in the final design proposal. The groups will select their own site and part of the campus that they are focusing on in their design work.



Säie pavillion (picture Kimmo Räisänen), Wood Program

ARTS SUMMER SCHOOL 2023

DESIGN PROJECT 6.-18.8.2023 – SCALES

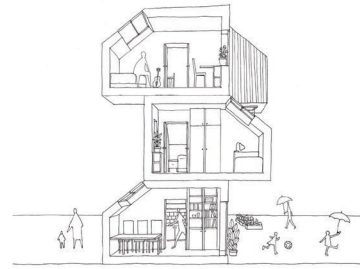

Kokoon (Wood Program 2016)

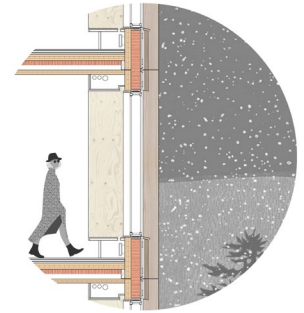

Anastasia Luzina, Wood Studio 2019

XL: Global

- How does the design project respond to global issues?

L: Area / landscape

- Considering the whole Otaniemi campus

M: Site / Building

- Considering a building or a site and their immediate surroundings

S: Detail / product / human scale

- Focusing on the human scale (human dimensions), details of structures or products such as furniture

ARTS SUMMER SCHOOL 2023

DESIGN PROJECT 6.-18.8.2023 – WAYS OF WORKING

Work:

The work consists of research, design work, and hands on work at the workshops.

The background information for the projects has been partly produced in the pre-assignments. During the two weeks the groups can deepen their understanding of the concepts that form the basis for their design projects.

The design work considers different scales so that the students from various backgrounds and disciplines can contribute. Students can illustrate their designs through drawings, visualizations, scale models etc.

The students will have the wood workshops in their use during the summer school, providing the possibility to build scale models or mock-ups and study the material in practice.

The groups can divide the work among themselves as they see best.



Aalto ARTS

Summer School 2023

LIVING WITH WOODS.

views to forest – tree – wood

6.-18.8.2023

Pre-Assignment Due 31.7.2023

ARTS SUMMER SCHOOL 2023

PRE-ASSIGNMENT 1,5 ECT (= 40 hours of work)

Before the two week workshop the students will produce background material to support the work during the summer school. The students will conduct pre-assignments in groups and individually and submit the material on MyCourses by July 31st. The pre-assignments will study:

1. **Site analysis** (of the Otaniemi campus) > one day workload (8h)
2. **Concepts** (related to the theme of the summer school) > one day workload
3. **Case studies** (the use of wood in architecture in the students' cultures) > one day workload
4. **Students' interests during the summer school** (used in forming the groups) > 60 min

ARTS SUMMER SCHOOL 2023

PRE-ASSIGNMENT GROUPS

Group 1: Aalto ARTS

Susanna Lumme

Henry Lång

Kazuma Miyuma

Jimin Hong

Aarni Tujala

Group 2: Aalto ARTS

Helena Vuola

Aino Nissinen

Maisa Johansson

Reetta Kanervo

Maribel Salazar

Group 3: Versailles

Matthias Colardelle

Emilie Boyard

Tomy Gallo

Group 4: AHO

Trond Kristen Ask Simensen Valde

Christina Sund

Heine Troland

Anna Dyakonova

Arina Perevedentseva

Group 5: Monterrey

Jose Pedro Aguirre Lopez

Daniela Morales Sánchez

Daniela Lozano Rodríguez

Priscila Davila Paez

Group 6: Parsons

Parisa Mah

Yetunde Sapp

Maite Santos Alcocer

Katharine Kim

Sara Fein

Group 7: SUTD

Wang Yi Wei

That Mhu Khin

Ng Ming Liang

Hannah Summer Lee I-Rei

Lim Pei Ying

Group 8: Royal College of Art

Hernan Romero

Hanju Seo

Subin Seol

Persephone Cooper

Zixiang Zhang

Group 9: TU Delft

Divya Agarwal

Emile Waterkeyn

Gijs Wels

Janna van der Jagt

Group 10: Warsaw

Józef Karzeł

Paweł Odrowąż-Sypniewski

Barnaba Perepiłyś

Daniel Sikorski

Duchna Łosiak

Group 11: Politecnico di Milano

Samuele Sala Veni

Emma Michel

Jiayu Wu

Camilla Indelicato

Valentina Callegari



Pre-Assignment 1

Site Analysis

ARTS SUMMER SCHOOL 2023

PRE-ASSIGNMENT 1 – SITE ANALYSIS

Aim:

The aim of the assignment is to produce background information about the Aalto University campus in Otaniemi. The campus will provide the site for the projects produced during the summer school. The students will work on the assignment in groups based on their institutions. Each group will be assigned one aspect of the campus to study. Each group will study the campus area as well as draw connections to the surrounding city.

Output:

The findings should be presented through maps, graphs and areal sections depending on the aspect under analysis. The material should be submitted as an A3 PDF –presentation on MyCourses by July 31st. The amount of pages depends on the amount of materials the groups produce.

Each group will present their site analysis in a 5-minute presentation on the first week of the summer school. The presentation should be self-explanatory so that the other students can study the material throughout the summer school.

ARTS SUMMER SCHOOL 2023

PRE-ASSIGNMENT 1 – SITE ANALYSIS

Site:

Otaniemi campus is located in the City of Espoo at the border of Helsinki. The campus is located between the Laajalahti bay, Laajalahti nature reserve and the Keilaniemi and Tapiola neighborhoods.

The area of the campus under investigation during the summer school is marked in the map on the right with the thick red line. The southern limit of the campus is the Kuusisaarentie street and in the west the Ring I highway. In the north the campus is bordered by the Laajalahti nature reserve. The students can define where to draw the border of the campus across the nature reserve in their investigations.

This area will serve as the site for the students' design tasks so the site analysis should cover at least this area. In addition to this framing the students can draw connections from the campus to the city around it.



ARTS SUMMER SCHOOL 2023

PRE-ASSIGNMENT 1 – SITE ANALYSIS

- CULTURAL HISTORY OF THE BUILT ENVIRONMENT, AGE OF BUILDINGS
- LANDSCAPE CULTURAL HISTORY
- TOPOGRAPHY / AREAL SECTIONS
- LANDSCAPE CHARACTERISTICS
- BUILT ENVIRONMENT: ARCHITECTURE, MATERIALS
- BUILT ENVIRONMENT: FUNCTIONS, SERVICES
- ZONING: PLANS FOR THE CAMPUS
- TRAFFIC, CIRCULATION, CONNECTIVITY
- PUBLIC SPACE, RECREATIONAL AREAS, URBAN LIFE
- LIVING ON THE CAMPUS - NOW AND FUTURE NEEDS, DEMOGRAPHICS
- FLORA & FAUNA, NON-HUMAN RESIDENTS

LEARNING OUTCOME:

Building the background knowledge and understanding of the site so that the two weeks can be spent on design

OUTPUT:

5 minute long PDF –presentation

Pre-Assignment 1

Site Analysis
&
Assignment guidelines

SITE ANALYSIS

Pre-assignment 1

CULTURAL HISTORY OF THE BUILT ENVIRONMENT, AGE OF BUILDINGS

How has the campus developed throughout the years? What buildings were on campus before the university? What buildings were part of the original Alvar Aalto campus plan? What are the most significant later layers on campus? Represent the ages of the buildings and the most significant historical layers through maps and diagrams. Shortly introduce the most important landmarks of the campus.

LANDSCAPE CHARACTERISTICS

Synthesize the important landscape characteristics of the campus: important views, spatiality of the landscape (open, closed, semi closed spaces in the landscape), important borders, landscape nodes and centers, most significant pathways, landscape inventory (RKY-alueet, VAMA, historical monuments, nature reserves), damage on landscape.

ZONING: PLANS FOR THE CAMPUS

What regulatory restrictions are prevalent on campus and how does it affect the built environment? What are the plans for campus development in the future? Represent the most important principles of zoning in maps or diagrams. Represent the future plans and projects of your choosing through pictures and short summaries.

LIVING ON THE CAMPUS - NOW AND FUTURE NEEDS, DEMOGRAPHICS

What could a day in Otaniemi look like for different individuals? Who lives here and what are the demographics? Who is Otaniemi designed for and how could the area develop to be more inclusive?

LANDSCAPE CULTURAL HISTORY

How was the land used historically? How has the land use changed and what has been the role of human impact. Identify culturally significant landscapes and milieu on campus. What are the values of the campus landscape?

BUILT ENVIRONMENT: ARCHITECTURE, MATERIALS

What building and neighborhood typologies are present on Aalto University campus? Describe the scale and positioning of the buildings. Is the campus plan open or closed? What materials are the buildings constructed from and what facade materials are used?

TRAFFIC, CIRCULATION, CONNECTIVITY

What transportation infrastructure exists in Otaniemi and how does it connect to Helsinki and the rest of Espoo? Which are the current traffic solutions and what public transport alternatives are available? How are bike lanes planned in relation to roads and sidewalks? How are parking places arranged on campus?

FLORA & FAUNA, NON-HUMAN RESIDENTS

What species of animals and vegetation can be common and can dominating species be found in Otaniemi? How do they use the campus? Represent the living environment of nonhuman species through maps and diagrams.

TOPOGRAPHY / AREAL SECTIONS

What are the different landscape levels in Aalto University Campus? Represent the topography of the campus through aerial sections of places you find interesting in terms of the topography.

BUILT ENVIRONMENT: FUNCTIONS, SERVICES

What functions do the buildings on campus serve? Which buildings serve Aalto University? Where is housing located? What services such as shops, restaurants, public services etc. can be found on campus?

PUBLIC SPACE, RECREATIONAL AREAS, URBAN LIFE

Identify the most important public spaces and places for urban life and recreation on campus. Describe the land ownership on campus. How much of the land is open to public and how much is privatized. What are the most important recreational areas and functions on campus? Describe the findings through maps, diagrams and other methods of your choosing.

ARTS SUMMER SCHOOL 2023

PRE-ASSIGNMENT 1 – SITE ANALYSIS

Group 1: Aalto ARTS

FAUNA, NONHUMAN RESIDENTS

Group 2: Aalto ARTS

LANDSCAPE CHARACTERISTICS

Group 3: École nationale supérieure de paysage (Versailles)

LANDSCAPE CULTURAL HISTORY

Group 4: The Oslo School of Architecture and Design

TOPOGRAPHY / AREAL SECTIONS

Group 5: Tecnológico de Monterrey

BUILT ENVIRONMENT: FUNCTIONS, SERVICES

Group 6: The New School: Parsons School of Design

BUILT ENVIRONMENT: ARCHITECTURE, MATERIALS

Group 7: Singapore University of Technology and Design

ZONING: PLANS FOR THE CAMPUS

Group 8: Royal College of Art

TRAFFIC, CIRCULATION, CONNECTIVITY

Group 9: TU Delft

PUBLIC SPACE, RECREATIONAL AREAS, URBAN LIFE

Group 10: Warsaw

LIVING ON THE CAMPUS - NOW AND FUTURE NEEDS,
DEMOGRAPHICS

Group 11: Politecnico di Milano

CULTURAL HISTORY OF THE BUILT ENVIRONMENT / AGES
OF BUILDINGS

CULTURAL HISTORY OF THE BUILT ENVIRONMENT, AGES OF BUILDINGS

How has the campus developed throughout the years?
What buildings were on campus before the university?
What buildings were part of the original Alvar Aalto campus plan?
What are the most significant later layers on campus?

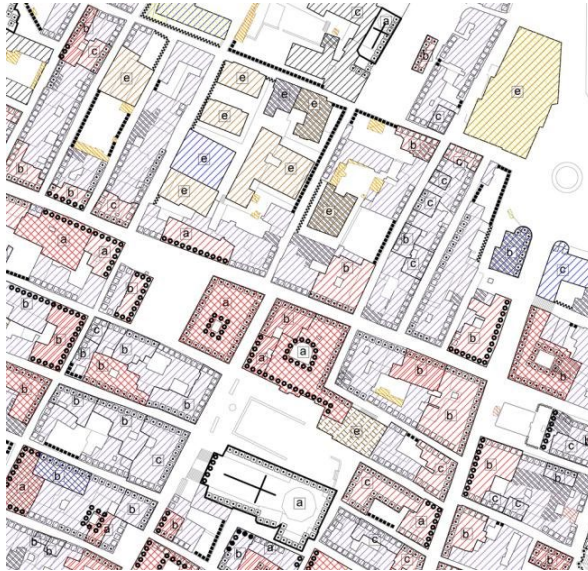

https://www.researchgate.net/figure/The-Historical-Architectural-Values-Map-Contents-Typology-of-each-building-colored_fig7_271639135



<https://www.instagram.com/p/ComraePIPI/?hl=sv>

Produce a map showing the different ages of buildings in Otaniemi.
Take note of culturally significant buildings, locate them in the map and shortly introduce them.

Students' Names

LANDSCAPE CULTURAL HISTORY

How was the land used historically?

How has the land use changed and what has been the role of human impact.

Identify culturally significant landscapes and milieus on campus.

What are the values of the campus landscape?

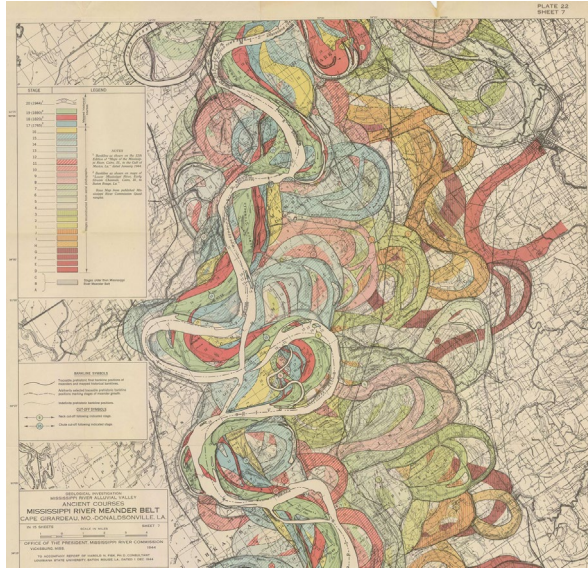

<https://www.atlasofplaces.com/cartography/mississippi-river-meander-belt/>

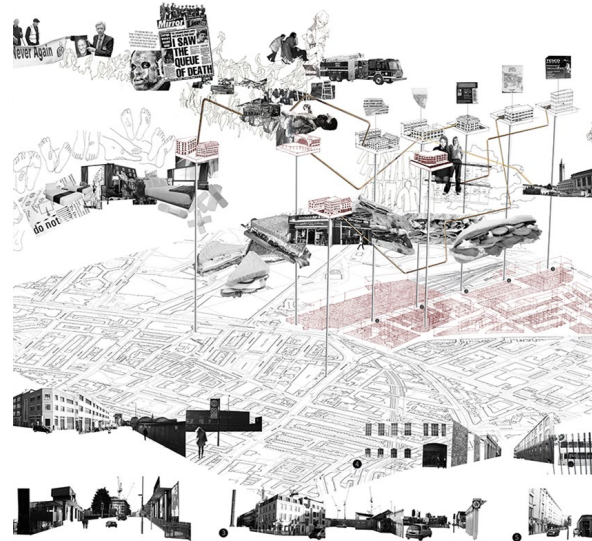

<https://i.pinimg.com/originals/1f/a5/3c/1fa53c0224d33f527a2a58553ff389224.png>

Study the land use historically through old maps and aerial photos.

Identify culturally significant landscapes and milieus on campus, locate them in the map and illustrate them.

Students' Names

TOPOGRAPHY / AREAL SECTIONS

What are the different landscape levels on Aalto University Campus?

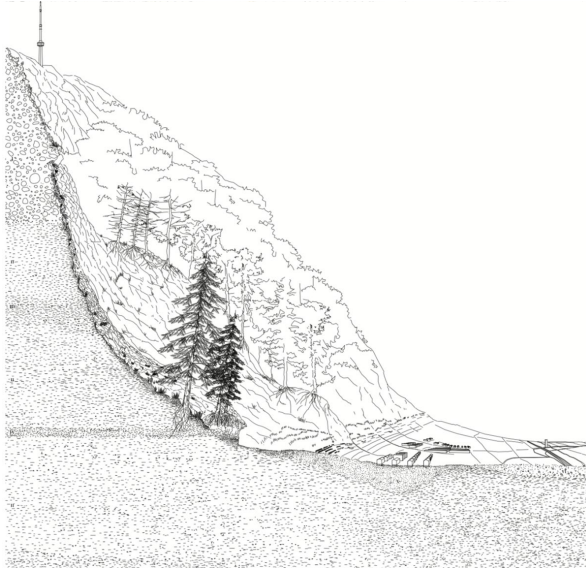

<https://studiotomemersons20.tumblr.com/post/613015766698278912/hs19-friesenberg-atlas-nature-geology-by>

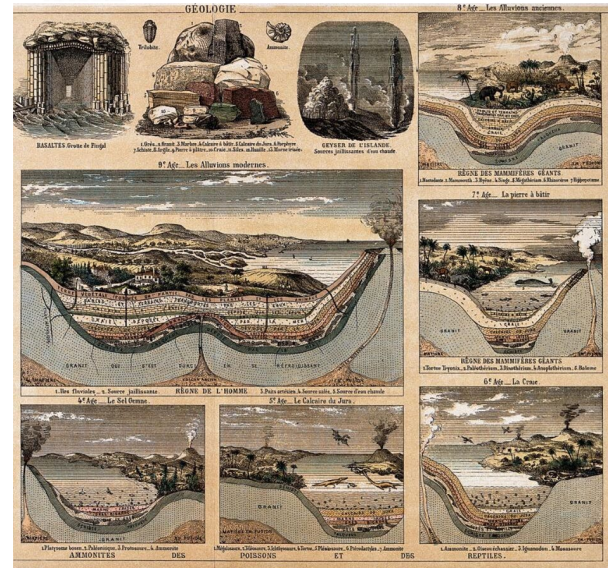

<https://www.behance.net/gallery/100065657/Landscape-Architecture-Section-in-Photoshop>

Represent the topography of the campus through areal sections of places you find interesting in terms of the topography.

Students' Names

LANDSCAPE CHARACTERISTICS

Synthesize the important landscape characteristics of the campus: important views, spatiality of the landscape (open, closed, semi closed spaces in the landscape), important borders, landscape nodes and centers, most significant pathways, landscape inventory (RKY-alueet, VAMA, historical monuments, nature reserves), damage on landscape

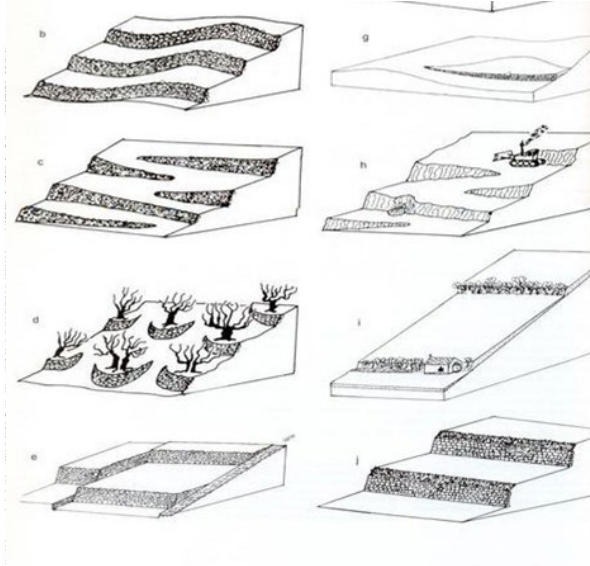

<https://i.pinimg.com/originals/50/3e/3f/503e3fda49aa821ad7e91b8d38a4a4.jpg>



<https://designobserver.com/feature/venice-from-gated-lagoon-to-bioregion/37564>

Synthesize the important landscape characteristics of the campus in maps, graphs and diagrams.

Students' Names

BUILT ENVIRONMENT: ARCHITECTURE, MATERIALS

What building and neighborhood typologies are present on Aalto University campus?
Describe the scale and positioning of the buildings. Is the campus plan open or closed?
What materials are the buildings constructed from and what facade materials are used?

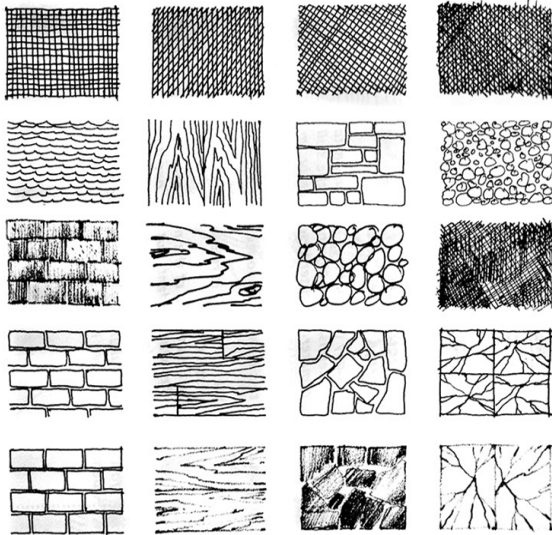

<http://www.studiolaforge.com/laforgeclasses/cross-hatching.html>

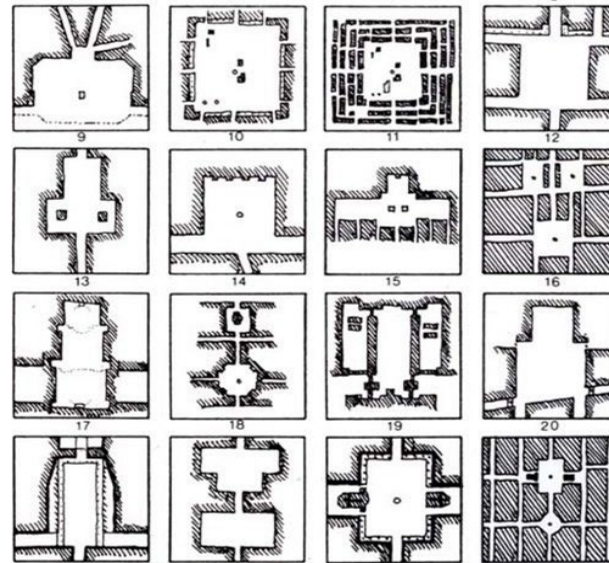

<https://i.pinimg.com/originals/9f/f8/Be/9ff88e780dc911f3960a6a78acffb4e4.jpg>

Identify characteristic building materials, architecture typologies and neighbour structures prevalent in Otaniemi and illustrate them on maps, diagrams, pictures, sketches etc.

Students' Names

BUILT ENVIRONMENT: FUNCTIONS, SERVICES

What functions do the buildings on campus serve?
Which buildings serve Aalto University? Where is housing located?
What services such as shops, restaurants, public services etc. can be found on campus?

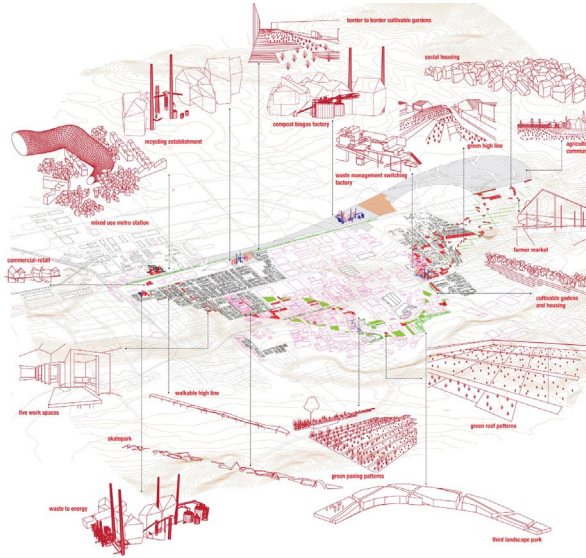

<https://divisare.com/projects/334982-riccardo-del-fabbro-learning-and-writing-for-tijuana#ig=1&slide=4>

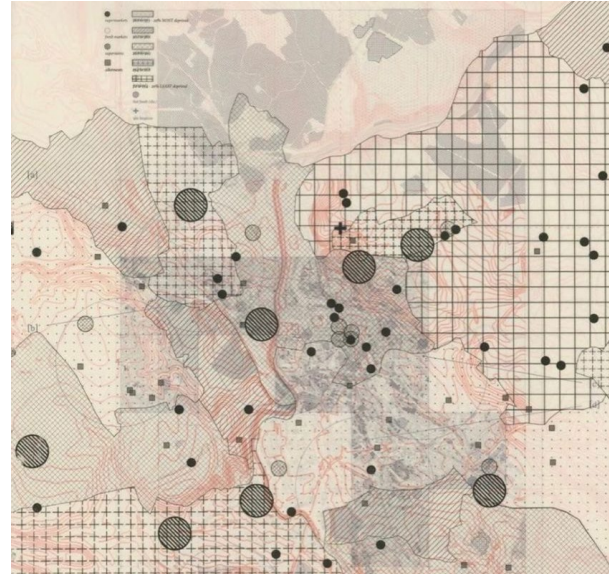

<https://i.pinimg.com/originals/d3/a2/1e/d3a21e8d44abef08097c870596533f20.jpg>

Identify the functions that the different buildings serve on campus.
Illustrate how these functions are connected together and who they serve.
Locate these typologies on a stylized map and utilize legends for explanations.

Students' Names

ZONING: PLANS FOR THE CAMPUS

What regulatory restrictions are prevalent on campus and how does it affect the built environment?

What are the plans for campus development in the future?

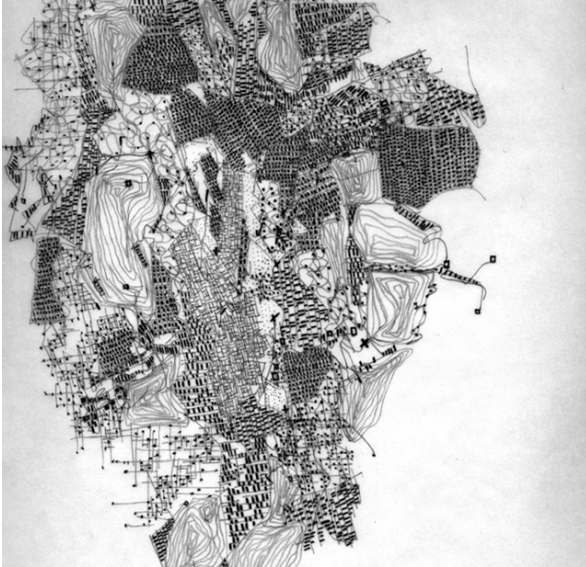

<https://socks-studio.com/2012/09/04/relational-cities-by-fabio-alessandro-fusco/>



<https://socks-studio.com/2023/04/23/architectural-narrative-new-york-city-the-edge-of-enigma-by-francisco-javier-rencoret-1991/>

Produce a map showing the zoning regulation on land use.
Shortly introduce the most important future plans and developments on the campus.

Students' Names

TRAFFIC, CIRCULATION, CONNECTIVITY

What transportation infrastructure exists in Otaniemi and how does it connect to Helsinki and the rest of Espoo?

Which are the current traffic solutions and what public transport alternatives are available?

How are bike lanes planned in relation to roads and sidewalks?

How are parking places arranged on campus?



<https://archive.dpa-etsam.com/projects/utovias>

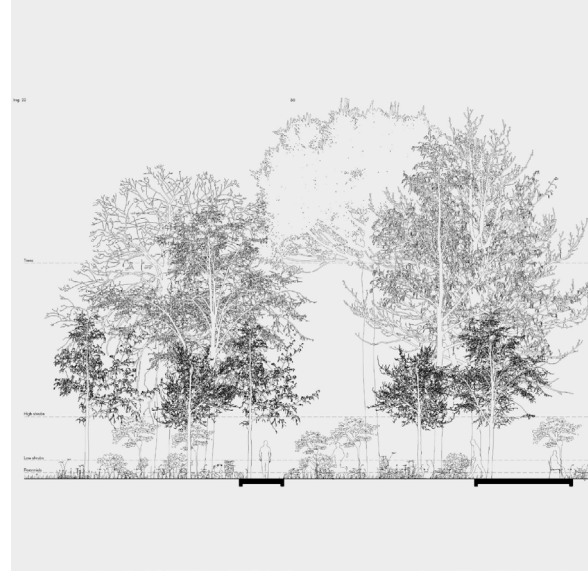

<https://divisare.com/projects/432593-51n4e-filip-dujardin-blerta-kambo-skanderbeg-square#lg=1&slide=16>

Produce a map showing the traffic infrastructure in Otaniemi.
Illustrate the circulation of different transportation modes, transportation nodes and parking places through maps and diagrams.

Students' Names

PUBLIC SPACE, RECREATIONAL AREAS, URBAN LIFE

Identify the most important public spaces and places for urban life and recreation on campus.
Describe the land ownership on campus. How much of the land is open to public and how much is privatized?
What are the most important recreational areas and functions on campus?



<https://socks-studio.com/2020/02/23/axonometric-realism-hortus-conclusus-by-beate-gutschow-2019/>



https://www.archdaily.com/267482/fishing-boat-harbor-and-river-of-liopetri-various-architects/birds_eye_view-2

Produce a collection of collages capturing the essence of a selection of public spaces and recreational areas in Otaniemi.
Compare these against each other and document the differences.
Illustrate the division of public and private land, including the most important public spaces and recreational areas through maps, diagrams, collages, illustrations etc.

Students' Names

LIVING ON THE CAMPUS NOW AND FUTURE NEEDS

What could a day in Otaniemi look like for different individuals?

Who lives here and what are the demographics?

Who is Otaniemi designed for and how could the area develop to be more inclusive?

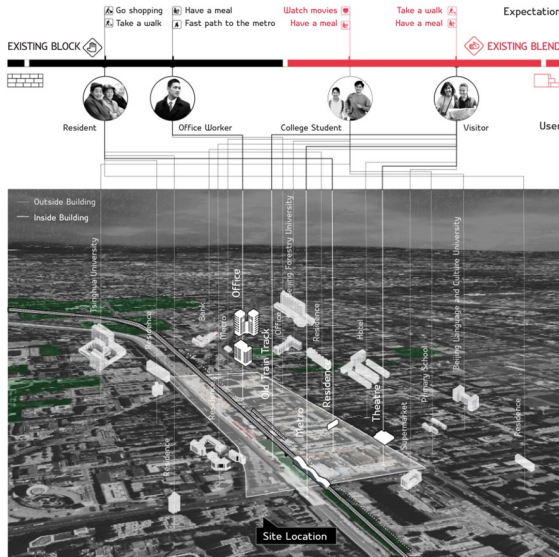

<https://i.pinimg.com/originals/35/e2/21/35e221de20d8ba81d349ff47c4e28927.png>

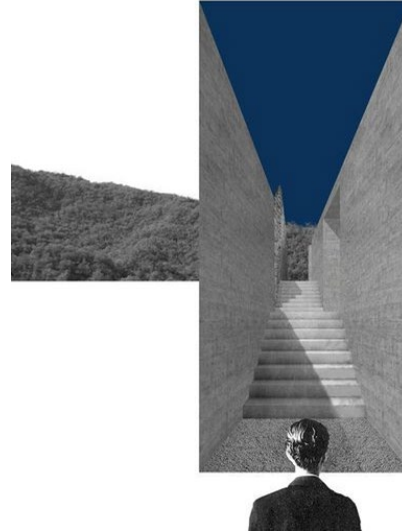

<https://i.pinimg.com/originals/ab/35/2b/ab352be6ca676521513e552cc213b74b.jpg>

Identify the lifestyles made possible in Otaniemi and produce collages and resident profiles with attached narratives.

Study the demographics and daily life of residents on campus through graphs, illustrations, sketches etc.

Produce a map of elements that make the campus inclusive or exclusive to certain groups.

Students' Names

FLORA & FAUNA, NON-HUMAN RESIDENTS

What species of animals and vegetation can be common and can dominating species be found in Otaniemi?
How do they use the campus?



<https://divisare.com/projects/371031-harry-gugger-studio-studio-basel-housing-competition/#g=1&slide=0>



<https://delva.la/projecten/vdma-eindhoven/>

What plant species and animals live in Otaniemi? How do they use the campus?
Represent the living environment of nonhuman species through
maps and diagrams.

Students' Names



Pre-Assignment 2

Concepts

ARTS SUMMER SCHOOL 2023

PRE-ASSIGNMENT 2 – CONCEPTS

Aim:

The aim of the assignment is to produce background information for the summer school based on the concepts relevant to the theme. The students will work on the assignment in groups based on their institutions. Each group will be assigned one concept to study.

Present the concept assigned to your group using case examples such as construction projects, products etc. The groups should study 2-4 case example projects and study how successful they are in implementing the concept under investigation.

The case examples can vary depending on scale from products to urban plans. The amount of case example projects should be based on the complexity of the case studies in question. The case example projects should be compared to each other.

Output:

The group members can contact each other on the MyCourses platform and if necessary, the home institutions of the group can facilitate a kickstart for the group work.

The findings will be presented in a 10-minute-long presentation during the first week of the summer school. The presentation slides should be submitted by July 31st in MyCourses as a PDF-file. Please practice the presentation beforehand and make sure you can stay within the time limit.

The presentation slides should be self-explanatory so that the other students can return to them during the summer school. Please keep this in mind when balancing the amount of text and images on the slides.

When using photographs or material from outside sources please remember to site the sources in the slides. Graphs and diagrams illustrating the concept should be preferably produced by the group members.

ARTS SUMMER SCHOOL 2023

PRE-ASSIGNMENT 2 – CONCEPTS

- REGENERATIVE DESIGN
- BIODIVERSITY AND ECOSYSTEM SERVICES
- POSTHUMANISTIC APPROACH IN DESIGN
- NO NET LOSS CITY - ECOLOGICAL COMPENSATION
- CRADLE TO CRADLE/GRAVE
- REVERSIBLE DESIGN & DESIGN FOR DISASSEMBLY
- URBAN MINING / MATERIAL PASSPORT -
RESOURCE EFFICIENCY
- SUSTAINABILITY CERTIFICATES
- CASCADING - MAXIMIZING MATERIAL FLOW STEPS
+ RE-, UP-, DOWNCYCLE
- BIOFILIA, NATURE BASED SOLUTIONS
- LIFE CYCLE ASSESSMENT

LEARNING OUTCOME:

Understanding the key concepts
related to the summer school theme.
Basis for the design work

OUTPUT:

10 minute PDF –presentation with
basic information about the concept
illustrated by 1-4 images explaining
the concepts

CONCEPTS

Pre-assignment 2

REGENERATIVE DESIGN

How can architecture and design contribute to repairing environments disturbed by human or natural activity? Could synthetic restorations function as architectural prosthetics, serving as temporary support until the targeted site or landscape can maintain itself again? Provide clear examples of design projects that successfully regenerate environments.

NO NET LOSS CITY - ECOLOGICAL COMPENSATION

How can urban developments compensate for their physical footprints and disruptions to natural environments. Does the presence of humans automatically degrade the quality of local natural values or could a city develop while supporting the already established ecosystems? Provide clear examples of design projects successfully compensating for the loss existing natural infrastructure.

URBAN MINING / MATERIAL PASS - RESOURCE EFFICIENCY

Can the existing built environment be seen as a material bank? How can structural elements in a building contain information, allowing individual parts to be identified within a larger composition? Could specific architectural components within a building be identified within a database, located and later utilized in new arrangements? Provide clear examples of design projects successfully labeling physical components with an associated digital database.

BIOFILIA, NATURE BASED SOLUTIONS

How can designers implement the knowledge retrieved from systems found in nature? Could the intelligence of flora and fauna be interpreted and transcribed into patterns and logics for construction systems and urban infrastructure? Provide clear examples of design projects successfully informed by systems identified in nature.

BIODIVERSITY AND ECOSYSTEM SERVICES

How could spatial and structural interventions maintain, transform and develop existing or novel ecosystems? How could architecture, flora and fauna co-exist and improve the quality of each other? Provide clear examples of design projects successfully contributing to a richer local and/or global biodiversity.

CRADLE TO CRADLE/GRAVE

How can life cycles of products and materials move from linear to circular systems? Could construction materials and architectural elements be refitted, rearranged and processed to obtain a new life? Provide clear examples of design projects successfully being included in a circular resource system.

SUSTAINABILITY CERTIFICATES

How can a contemporary building system gain value from conforming to established sustainability standards? What certificates exist today and could these encourage designers to look beyond conventions, generating new frameworks for architecture? Introduce the most relevant certificates and provide clear examples of design projects successfully meeting the standards. Produce a list of certificates you can find and select 5 for closer inspection. Include building, forest and wood material certificates.

LIFE CYCLE ASSESSMENT

How can designers identify the environmental impact of a material or used in a project? Every product is a result of a complex chain of events and could this information support decision-making in a creative process? Provide clear examples of design projects successfully implementing LCA and identify its intrinsic categorizations.

POSTHUMANISTIC APPROACH IN DESIGN

How can a non-human-centric architecture be manifested? Instead of developing architecture as sheltering devices, insulating humans from so called "nature", could architecture consider other species as well? Provide clear examples of design projects successfully using posthumanistic approach.

REVERSIBLE DESIGN & DESIGN FOR DISASSEMBLY

How can structural arrangements function as reversible assembly systems? Does a building necessarily only have to be built once, or can it be given an extended life through disassembly? Provide clear examples of design projects that are designed with disassembly in mind.

CASCADING - MAXIMIZING MATERIAL FLOW STEPS + RE-, UP-, DOWNCYCLE

How can the life of construction materials be extended beyond their first implementation? Could processing of building components retrieve value and store carbon for longer? Provide clear examples of design projects successfully utilizing materials processed from other products.

ARTS SUMMER SCHOOL 2023

PRE-ASSIGNMENT 2 – CONCEPTS

Group 1: Aalto ARTS

REGENERATIVE DESIGN

Group 2: Aalto ARTS

BIODIVERSITY AND ECOSYSTEM SERVICES

Group 3: École nationale supérieure de paysage (Versailles)

POSTHUMANISTIC APPROACH

Group 4: The Oslo School of Architecture and Design

NO NET LOSS CITY - ECOLOGICAL COMPENSATION

Group 5: Tecnológico de Monterrey

CRADLE TO CRADLE/GRAVE

Group 6: The New School: Parsons School of Design

REVERSIBLE DESIGN & DESIGN FOR DISASSEMBLY

Group 7: Singapore University of Technology and Design

URBAN MINING / MATERIAL PASSPORT / RESOURCE EFFICIENCY

Group 8: Royal College of Art

SUSTAINABILITY CERTIFICATES

Group 9: TU Delft

CASCADING / MAXIMIZING MATERIAL FLOW STEPS / RE-, UP-, DOWNCYCLE

Group 10: Warsaw

BIOFILIA, NATURE BASED SOLUTIONS, NATURAL MATERIALS

Group 11: Politecnico di Milano

LIFE CYCLE ASSESMENT (LCA)



Pre-Assignment 2

(presentation example)

REUSE:

The act of extending the lifetime and consequently relevance of a building through exchange of building components

CONCEPT OVERVIEW

REUSE

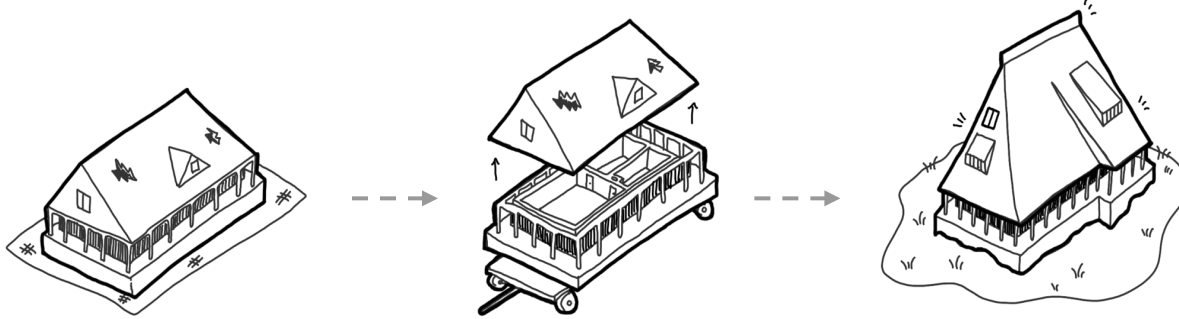

Illustration by author

EXTENDING SERVICE-LIFE

Building reuse/renovation - The objective is to renovate and improve existing structures/buildings rather than letting them go to waste. Apart from saving resources by reusing a building, it is very useful during renovation to look into the reduction of the waste production.

MAINTAINING ARCHITECTURAL VALUES

When heritage buildings are adapted for different functions, the new use and the interventions should preserve the originality and architectural character of the building in order to not give wrong or missing information for the further generations.

UTILIZING FUNCTIONING COMPONENTS

The process when a structural element is used again for the same structural purpose or another purpose in the built environment. Reducing or circumventing the need for new construction components in future project will significantly reduce the carbon footprint of the building sector.

CASE STUDIES

Relocated and Reused Ground Floor of Family House



photo by ArhiBox, <https://www.archdaily.com/781858/traditional-wooden-house-reconversion-arhibox>

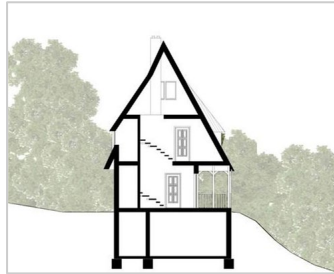

drawing by ArhiBox, <https://www.archdaily.com/781858/traditional-wooden-house-reconversion-arhibox>

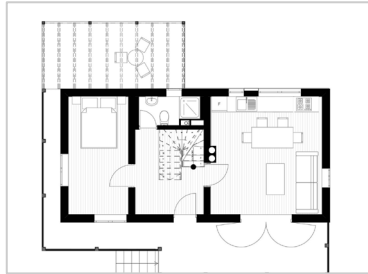

drawing by ArhiBox, <https://www.archdaily.com/781858/traditional-wooden-house-reconversion-arhibox>

Traditional Wooden House Reconversion, Vultureni, Romania. ArhiBox, 2016

Reinforced Airplane Hangar reused for Office Landscape



photo by ZGF Architects, <https://www.zgf.com/work/404-google-spruce-goose>

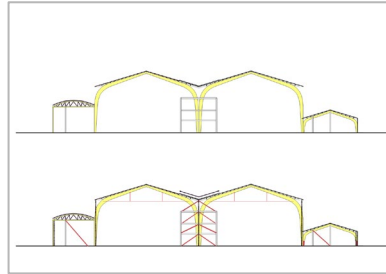

illustrations by ARUP,
https://cdn.ymaws.com/www.seaoc.org/resource/resmgr/docs/eise2019/2019_0403seaosc_spruce_goose_pdf

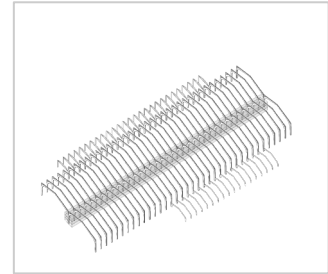

illustration by author

Google's New L.A. Office in Historic Hangar, California, USA. ZGF Architects, 2018



Pre-Assignment 3

Traditional and contemporary case studies from your home country.

ARTS SUMMER SCHOOL 2023

PRE-ASSIGNMENT 3 – CASE STUDIES

Aim:

The aim of the assignment is to produce background information for the summer school based on the use of wood internationally. The assignment is conducted individually. Each student should study the use of wood in living environments (architecture, landscape architecture or interior architecture, design, products etc.) in the context of their home country or culture or the country of their home institution.

The students should select two case studies one showcasing the traditional or historical use of wood and one contemporary example. The case study examples can be construction projects, furniture, products etc. The case studies should be selected based on a concept of the student's choosing from assignment 2. The concept does not have to be the one assigned to the student in pre-assignment 2 but the students can select the concepts that interest them.

Output:

The findings will be collected on a Miro board where students can add pictures, diagrams, text, links etc. As the students are working, they can see the work of the other students.

The assignment output will be printed as posters but not to be shown as presentation. Posters should be designed as self-explanatory so that the other students can return to it for international references during the summer school.

The Miro board will be printed out and exhibited during the summer school. The assignment output should be added to Miro by July 31st.

ARTS SUMMER SCHOOL 2023

PRE-ASSIGNMENT 3 – CASE STUDIES

Present **case study projects of the use of wood** in living environments

- examples from
 - architecture
 - landscape architecture
 - interior architecture
 - design, products etc.
- in the context of your home country or culture or the country of your home institution
- one **historical** example
- one **contemporary** example
- examples should be **selected based on a concept** of the student's choosing from assignment 2

LEARNING OUTCOME:
Building a collection of international references for the design project

OUTPUT:
Miro board featuring pictures, text and links.

ARTS SUMMER SCHOOL 2023

PRE-ASSIGNMENT 3 – CASE STUDIES

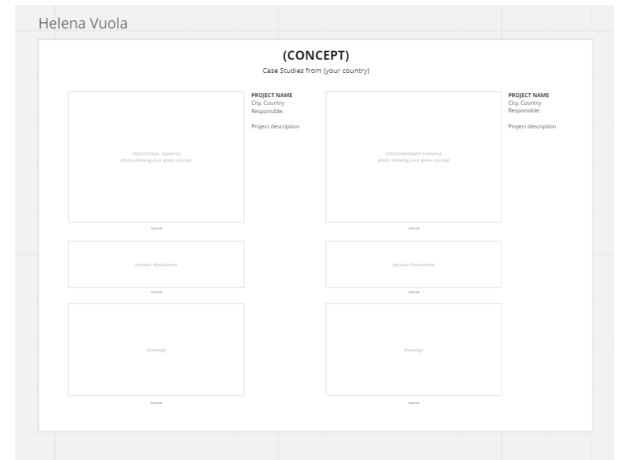
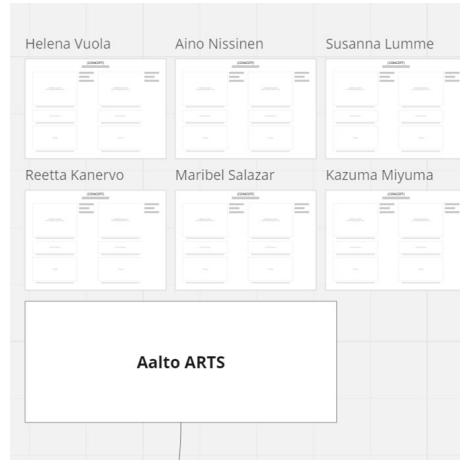
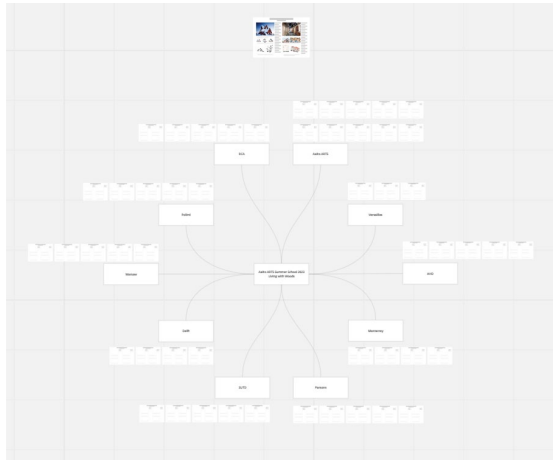

Link to Miro board (you will have to log in with the email you gave in your summer school application to edit):

https://miro.com/app/board/uXjVMLVXRyE=?share_link_id=597104593150



Pre-Assignment 3

(presentation example)

Traditional and contemporary case studies from your
home country

REUSE

Pre-assignment 2 - Case Studies from Sweden



photo by LKAB: <https://samhallsomvandling.lkab.com/sv/kiruna/tidplan-kiruna/projekt-4-kiruna/kiruna-kyrka/>



illustration by author

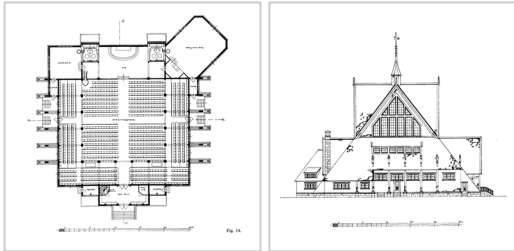

drawings from Kiruna Kyrka 1973. & o. ALMQVIST & WIKSELL
by Fredric Bedoire

KIRUNA KYRKA

Kiruna, Sweden

Responsible: LKAB

Completed 1912. The church is 40 m wide, weighing 40 tonnes.

Construction:
The foundation is made of Concrete and blocks of Granite. The rest of the church constructed with Pine wood.

Reuse aspect:
Due to mining activity the entire city of Kiruna needs to move and instead of constructing a new church, it will be relocated and reused.

The move will occur 2025 and is part of a larger city development which will be completed in 2035.

What parts need to be replaced and what parts can be repaired, perhaps used in different projects or archived/displayed at a museum?

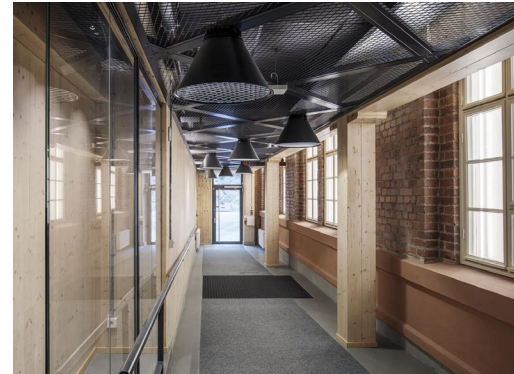

photo by Tengbom: <https://tengbom.se/projekt/12248/>

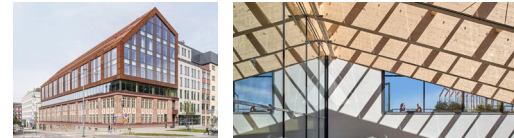
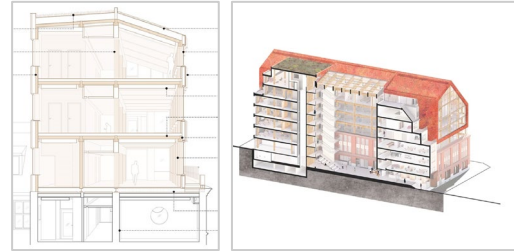

photo by Tengbom: <https://tengbom.se/projekt/12248/>



drawings from Svenskt Trå <https://www.svensktrå.se/publikationer-start/tidningen-tra/2020-2/tyra-latta-pabyggnader-visar-pa-hallbar-utveckling/>

TRIKÅFABRIKEN

Stockholm, Sweden

Responsible: Tengbom

Completed 2019. The office building houses 25 000 square metres.

Construction:
The original brick building function as a plinth for the added CLT and Glue laminated wood construction.

Reuse Aspect:
The original brick building was built in 1929 and served as a stockinette-factory. The original brick structure underwent restoratory work and a 5 storey tall addition of massive-wood was made, resulting in a relatively lightweight structure compared to concrete in order to reduce the stress on the original structure.

What parts need to be replaced and what parts can be repaired?



Pre-Assignment 4

Woodcha Kucha

ARTS SUMMER SCHOOL 2023

PRE-ASSIGNMENT – WOODCHA KUCHA

Aim:

The aim of the assignment is for the students to clarify what they are interested in related to the themes of the summer school and what they would like to work on in their design projects. The students will briefly elaborate what concepts they would like to work with in their designs and in what scale they would be interested to work in (area, building design / site, detail / product).

The students will also introduce their skillset and what they can bring to the projects, for example have they worked in wood workshops before.

Students will submit their introductions in the form of a PDF presentation with 4 slides with one picture and a few sentences per each slide. The presentations will be presented to other students in the beginning of the summer school on Sunday 6th of August. The answers will guide forming the groups.

OBJECTIVE:

Introducing the summer school students. The information will help in forming the groups for the two weeks.

OUTPUT:

A four slide Pecha Kucha presentation

ARTS SUMMER SCHOOL 2023

PRE-ASSIGNMENT – WOODCHA KUCHA

Introduce yourself in a four slide Pecha Kucha presentation

- 15 seconds per slide
- a few sentences and a picture per slide

Slides:

1. Introduce yourself with by completing the sentence: Me and my...
2. What themes and concepts are you interested in working with in your summer school design project?
3. What scales and disciplines are you interested in working with in your summer school design project?
4. What skills and experience do you bring to the summer school design project? Have you for example worked in wood workshops before or are you especially good at urban design projects for example?

OBJECTIVE:

Introducing the summer school students. The information will help in forming the groups for the two weeks.

OUTPUT:

A four slide Pecha Kucha presentation

ARTS SUMMER SCHOOL 2023

PRE-ASSIGNMENT 1,5 ECT (= 40 hours of work)

Remember to submit the material on MyCourses by July 31st

1. **Site analysis** (of the Otaniemi campus) > one day workload (8h)
2. **Concepts** (related to the theme of the summer school) > one day workload
3. **Case studies** (the use of wood in architecture in the students' cultures) > one day workload
4. **Students' interests during the summer school** (used in forming the groups) > 60 min

If you have any questions related to the pre-assignments please don't hesitate to contact:

Matti Jänkälä, Summer School Coordinator: matti.jankala@aalto.fi

ARTS SUMMER SCHOOL 2023

PRE-ASSIGNMENT GROUPS

Group 1: Aalto ARTS

Susanna Lumme

Henry Lång

Kazuma Miyuma

Jimin Hong

Aarni Tujala

Group 2: Aalto ARTS

Helena Vuola

Aino Nissinen

Maisa Johansson

Reetta Kanervo

Maribel Salazar

Group 3: Versailles

Matthias Colardelle

Emilie Boyard

Tomy Gallo

Group 4: AHO

Trond Kristen Ask Simensen Valde

Christina Sund

Heine Troland

Anna Dyakonova

Arina Perevedentseva

Group 5: Monterrey

Jose Pedro Aguirre Lopez

Daniela Morales Sánchez

Daniela Lozano Rodríguez

Priscila Davila Paez

Group 6: Parsons

Parisa Mah

Yetunde Sapp

Maite Santos Alcocer

Katharine Kim

Sara Fein

Group 7: SUTD

Wang Yi Wei

That Mhu Khin

Ng Ming Liang

Hannah Summer Lee I-Rei

Lim Pei Ying

Group 8: Royal College of Art

Hernan Romero

Hanju Seo

Subin Seol

Persephone Cooper

Zixiang Zhang

Group 9: TU Delft

Divya Agarwal

Emile Waterkeyn

Gijs Wels

Janna van der Jagt

Group 10: Warsaw

Józef Karzeł

Paweł Odrowąż-Sypniewski

Barnaba Pereplyś

Daniel Sikorski

Duchna Łosiak

Group 11: Politecnico di Milano

Samuele Sala Veni

Emma Michel

Jiayu Wu

Camilla Indelicato

Valentina Callegari

ARTS SUMMER SCHOOL 2023

PRE-ASSIGNMENT 1 – SITE ANALYSIS

Group 1: Aalto ARTS

FAUNA, NONHUMAN RESIDENTS

Group 2: Aalto ARTS

LANDSCAPE CHARACTERISTICS

Group 3: École nationale supérieure de paysage (Versailles)

LANDSCAPE CULTURAL HISTORY

Group 4: The Oslo School of Architecture and Design

TOPOGRAPHY / AREAL SECTIONS

Group 5: Tecnológico de Monterrey

BUILT ENVIRONMENT: FUNCTIONS, SERVICES

Group 6: The New School: Parsons School of Design

BUILT ENVIRONMENT: ARCHITECTURE, MATERIALS

Group 7: Singapore University of Technology and Design

ZONING: PLANS FOR THE CAMPUS

Group 8: Royal College of Art

TRAFFIC, CIRCULATION, CONNECTIVITY

Group 9: TU Delft

PUBLIC SPACE, RECREATIONAL AREAS, URBAN LIFE

Group 10: Warsaw

LIVING ON THE CAMPUS - NOW AND FUTURE NEEDS,
DEMOGRAPHICS

Group 11: Politecnico di Milano

CULTURAL HISTORY OF THE BUILT ENVIRONMENT / AGES
OF BUILDINGS

ARTS SUMMER SCHOOL 2023

PRE-ASSIGNMENT 2 – CONCEPTS

Group 1: Aalto ARTS

REGENERATIVE DESIGN

Group 2: Aalto ARTS

BIODIVERSITY AND ECOSYSTEM SERVICES

Group 3: École nationale supérieure de paysage (Versailles)

POSTHUMANISTIC APPROACH

Group 4: The Oslo School of Architecture and Design

NO NET LOSS CITY - ECOLOGICAL COMPENSATION

Group 5: Tecnológico de Monterrey

CRADLE TO CRADLE/GRAVE

Group 6: The New School: Parsons School of Design

REVERSIBLE DESIGN & DESIGN FOR DISASSEMBLY

Group 7: Singapore University of Technology and Design

URBAN MINING / MATERIAL PASSPORT / RESOURCE EFFICIENCY

Group 8: Royal College of Art

SUSTAINABILITY CERTIFICATES

Group 9: TU Delft

CASCADING / MAXIMIZING MATERIAL FLOW STEPS / RE-, UP-, DOWNCYCLE

Group 10: Warsaw

BIOFILIA, NATURE BASED SOLUTIONS, NATURAL MATERIALS

Group 11: Politecnico di Milano

LIFE CYCLE ASSESMENT (LCA)