

14 SEPTEMBER 2023

ENERGY FORUM, AALTO UNIVERSITY

Sustainable Sewage Treatment From Waste to Value

MICHAEL RECKTENWALD, PH.D. (ENG.)

KEMIRA OYJ, ESPOO

kemira

Overview

Principles of wastewater treatment

Your own impact on the environment and the water cycle

Wastewater treatment plant (WWTP) as a large biotech facility

Zoom-in to mass and energy flows

Energy self-sufficiency of WWTPs

Renewable methane as energy source

Nutrient recycling

Ideas are needed

SUSTAINABLE SEWAGE TREATMENT – FROM WASTE TO VALUE

Helsinki, Viikinmäki, 800 000 PE (Person Equivalents)

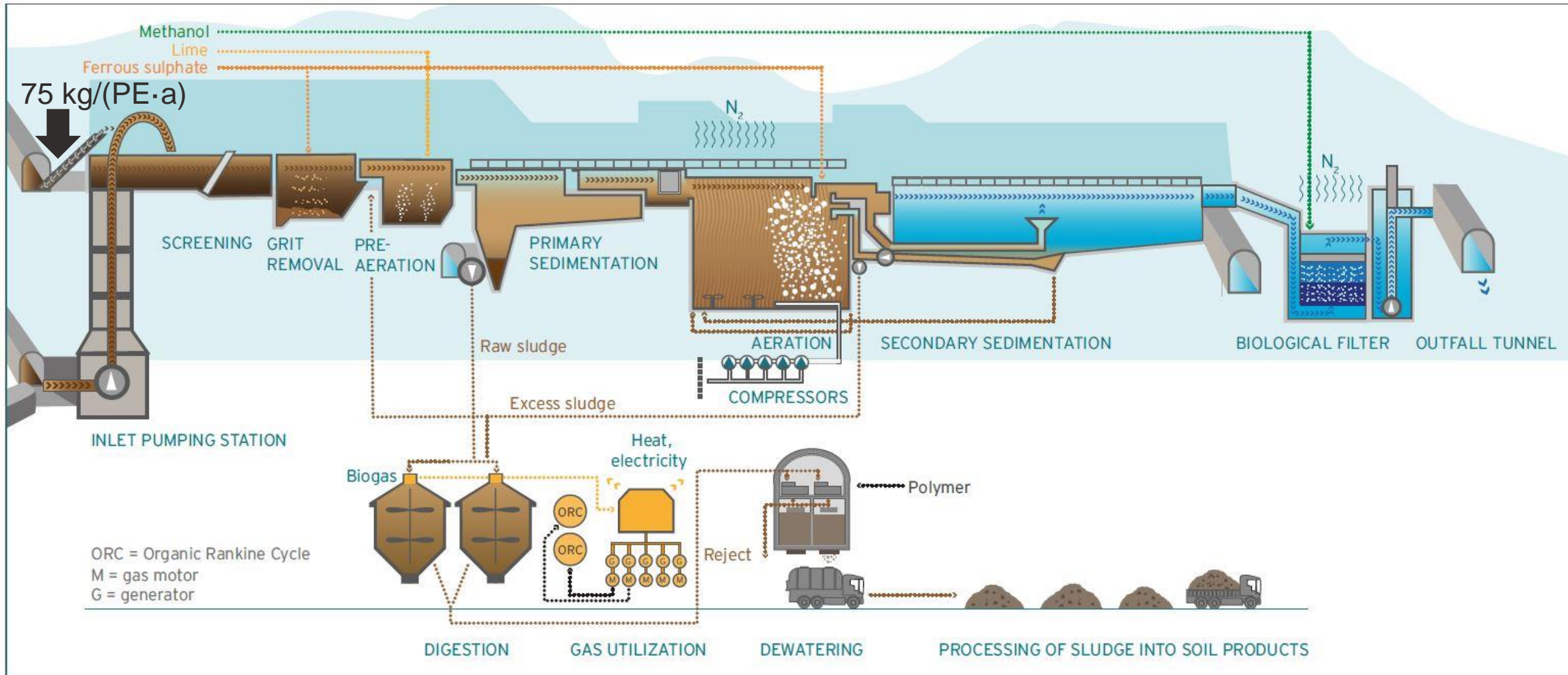

Nutrient release per capita – PE Person Equivalent

Average waste load – Dimensioning of the wastewater treatment plants

- Feed flow per day 400 l/(PE·d)

Your personal impact per year

- Solids 75 kg/(PE·a)
- Carbon 55 kg/(PE·a)
- Nitrogen 6 kg/(PE·a)
- Phosphorus 0.75 kg/(PE·a)



Environmental impact

Biochemical impact of the nutrients on the environment

- Phosphorus has by far the largest impact if released to the environment
- 1 g phosphorus can build up approx. 100 g biomass

• 1 g N → 14 g biomass

• 1 g P → 100 g biomass



SUSTAINABLE SEWAGE TREATMENT – FROM WASTE TO VALUE

Helsinki, Viikinmäki, 800 000 PE (Person Equivalents)

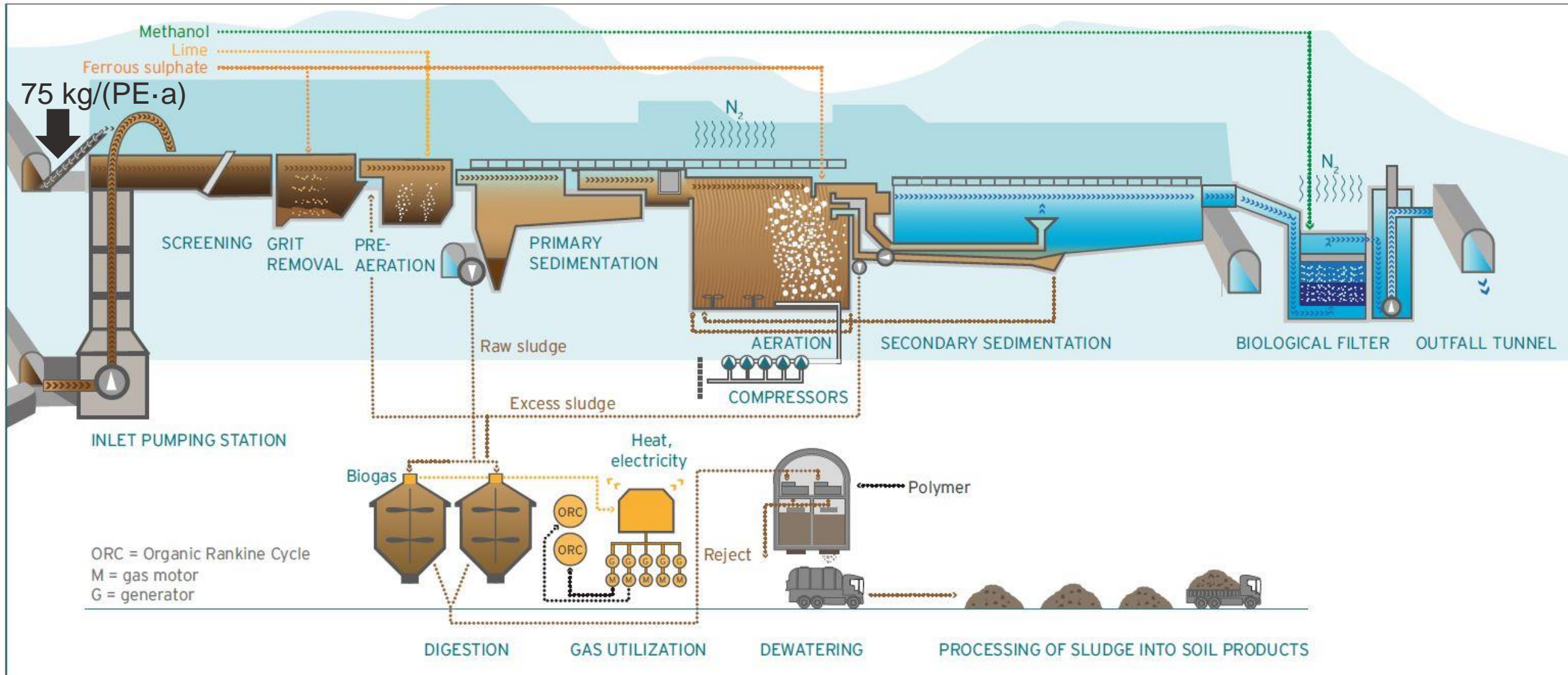

Biological treatment step – Zoom-in on “Biology”

Two steps are necessary for nitrogen degradation

Nitrification (aerobic = oxygen consuming step)



Denitrification (anaerobic = lack of oxygen)



Nitrogen is released to the air as N_2 . Carbon is consumed as carbon source and released as CO_2 .

The result is microbial sludge with bound C and P.



Nutrient Recycling: The Nitrogen Cycle

Biological degradation of nitrogen

- Energy need for the aeration **30 kWh/(PE·a)**
- Nitrogen feed load **6.5 kg/(PE·a)**
- Specific energy need for the degradation of nitrogen **2.5 kWh/kg N → 16 kWh/(PE·a)**

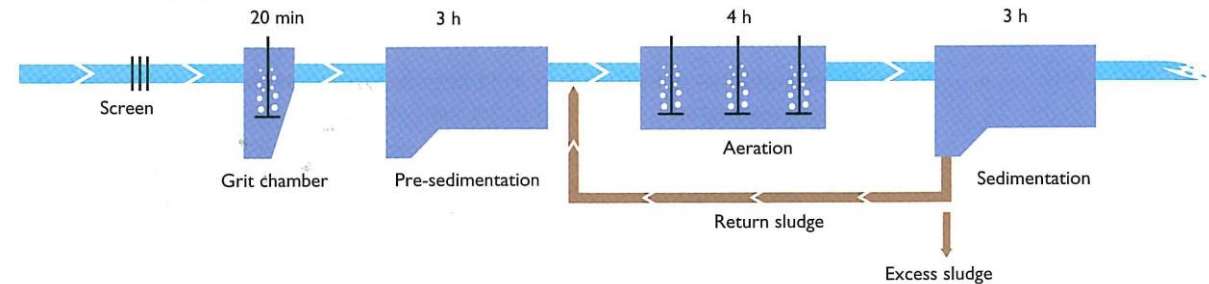

Haber-Bosch process (ammonia synthesis)

- Specific energy need **≈10 kWh/kg N** (Source: Ullmann encyclopedia)
- World production: 150 million metric tons ammonia per year, and increasing
- 1.5 % of the global energy production
- 3-5 % of the global carbon dioxide release

→ Nitrogen is run in a cycle with a massive energy input → Energy saving potential

SUSTAINABLE SEWAGE TREATMENT – FROM WASTE TO VALUE

Helsinki, Viikinmäki, 800 000 PE (Person Equivalents)

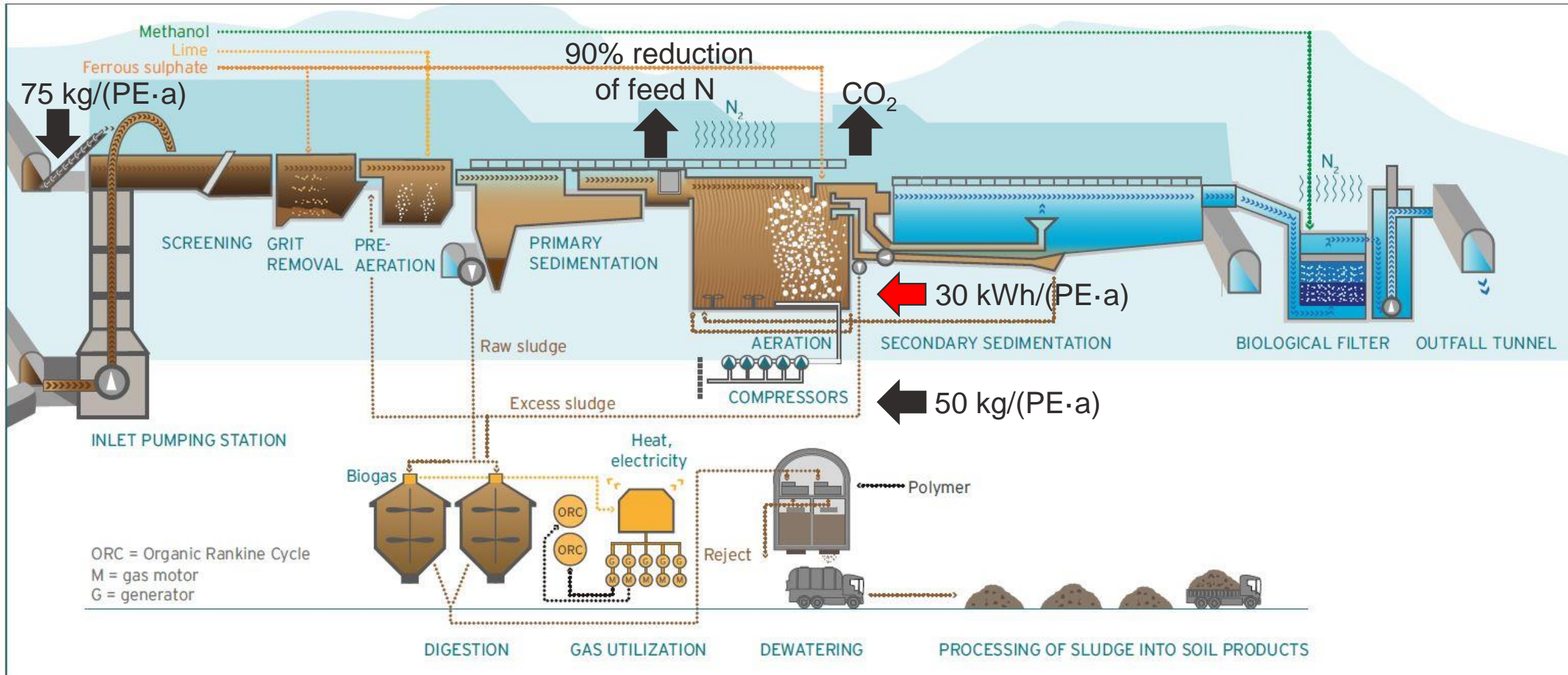

Anaerobic digesters are biotech reactors

Large reactors 1000 to 4000 m³

Residence time 15 to 25 days

Temperature 35 to 38 °C (mesophilic) – Energy need

Gentle mixing

Robust against
changes in the substrate



Anaerobic Digestion – Biotech in wastewater treatment

Main task: **Reduction** of the organic part → Disposal costs up to 300 EUR/t Dry Solids (DS)

Energy self-sufficiency of the wastewater treatment plant

Sludge feed to digestion: **52 kg/(PE-a) as solids**

- 70-80 % organic matter in solids

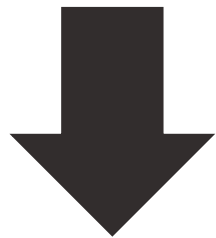

Volume and
cost reduction

Sludge effluent: **25 kg/(PE-a) as solids**

- 50-60 % organic matter in solids

Still, most of the organic matter is left

- It can be a raw material. Create new ideas for further use.

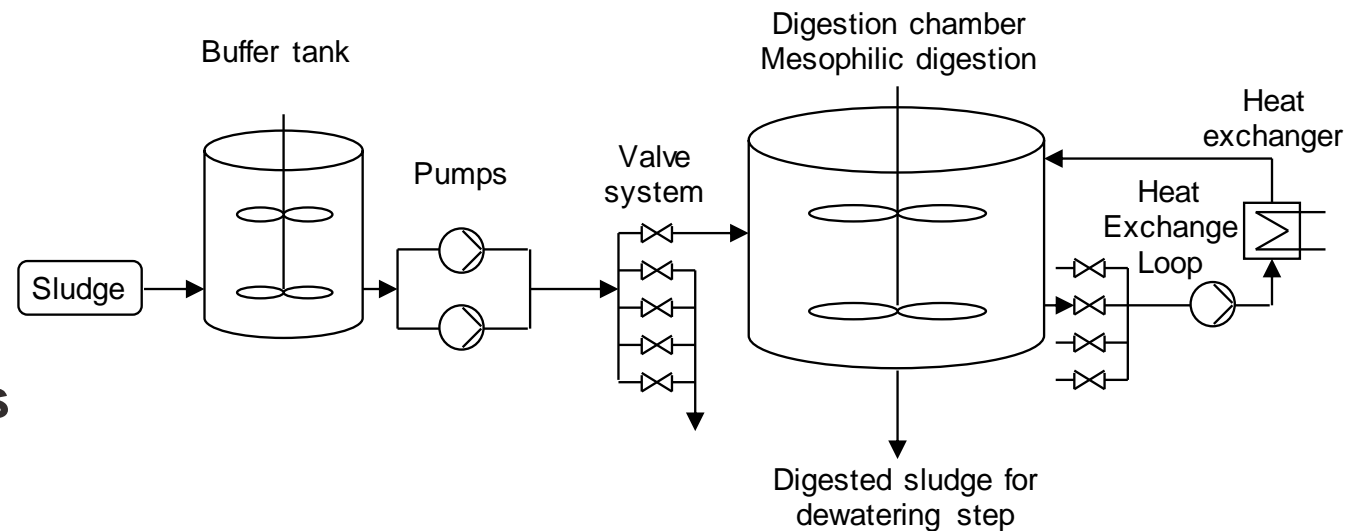

Sludge is the end product of the wastewater treatment

Disposal costs per metric ton DS

- Sludge dry matter for disposal 25 kg/(PE·a)
- 200-300 EUR Incineration
- 150-200 EUR Composting, Disposal
- 100-150 EUR Agriculture



Methane formation process

A microbial consortium

- A large number of different microbes
- Microbes are specialized on substrates

Biochemical mechanism

- Complex organic compounds are degraded
- Shorter units
- Monomers

Target

- Make the carbon-based nutrients bioavailable
- Produce energy for microbial metabolism

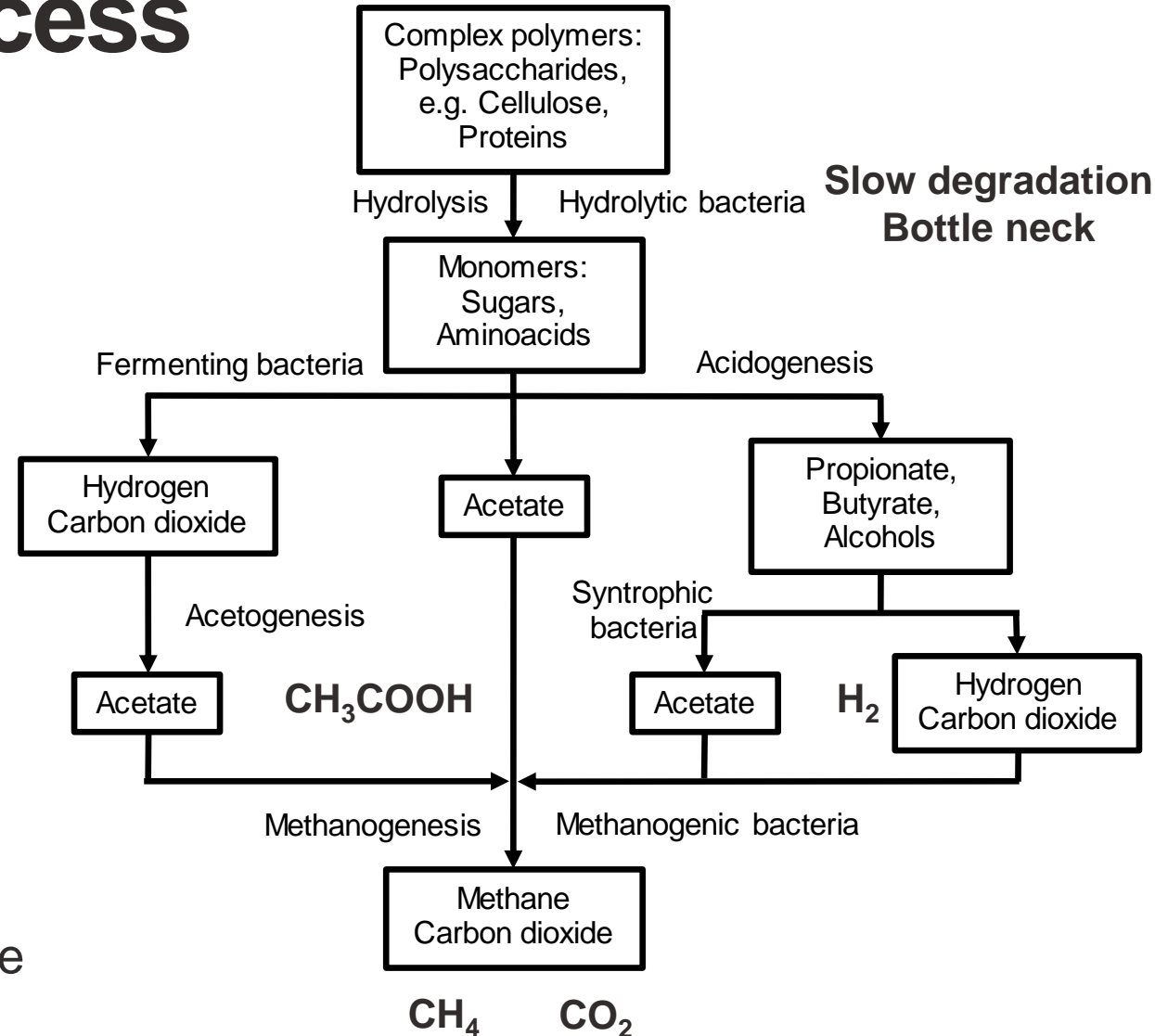

Biogas and Biomethane



Biogas

- Mix of 60 % methane, 40 % carbon dioxide and traces of hydrogen sulphide
- Can be used in Combined Heat and Power generation (CHP)



Biomethane

- Contains >95 % methane
- Upgrade: Stripping (= washing out) carbon dioxide and hydrogen sulphide by water
- Can be used in cars, buses, trains, gas grid



SUSTAINABLE SEWAGE TREATMENT – FROM WASTE TO VALUE

Mass flows

Helsinki, Viikinmäki

Size: 800 000 PE (Person Equivalent)

Feed flow: 102 million m³/a wastewater

Biogas: 13.4 million m³/a

→ 17 m³/(PE·a) biogas

→ 10 m³/(PE·a) biomethane

→ 94 kWh/(PE·a)

Electric power production: 25 500 MWh/a (31 kWh/(PE·a))

Dry sludge: 19 000 t/a → 24 kg/(PE·a) → Costs for disposal

Wet sludge (28 % DS) for disposal: 65 000 t/a (180 t/d)

Viikinmäen jätevedenpuhdistamo
Avloppsreningsverk • Wastewater treatment plant

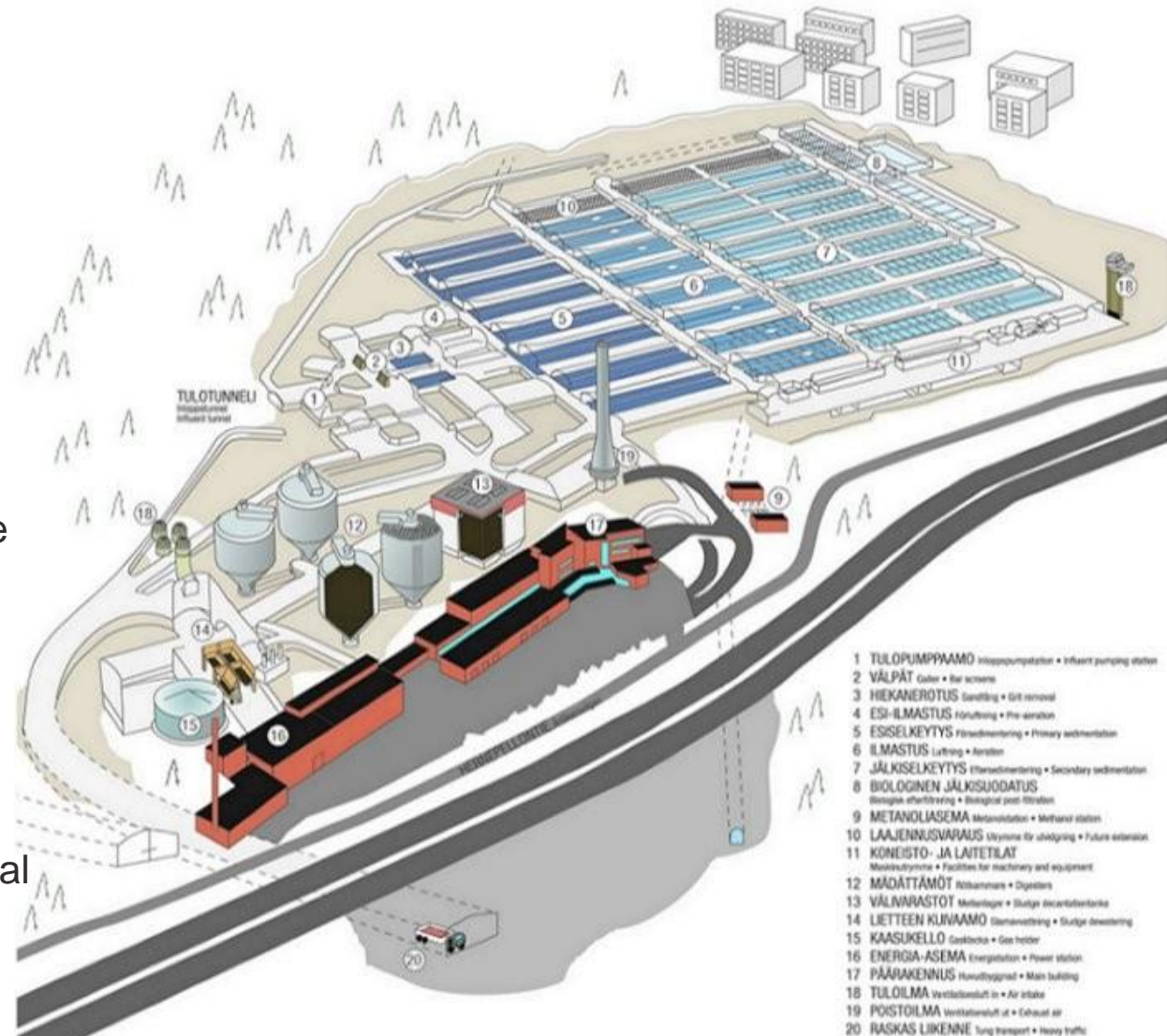

SUSTAINABLE SEWAGE TREATMENT – FROM WASTE TO VALUE

Helsinki, Viikinmäki, 800 000 PE (Person Equivalents)

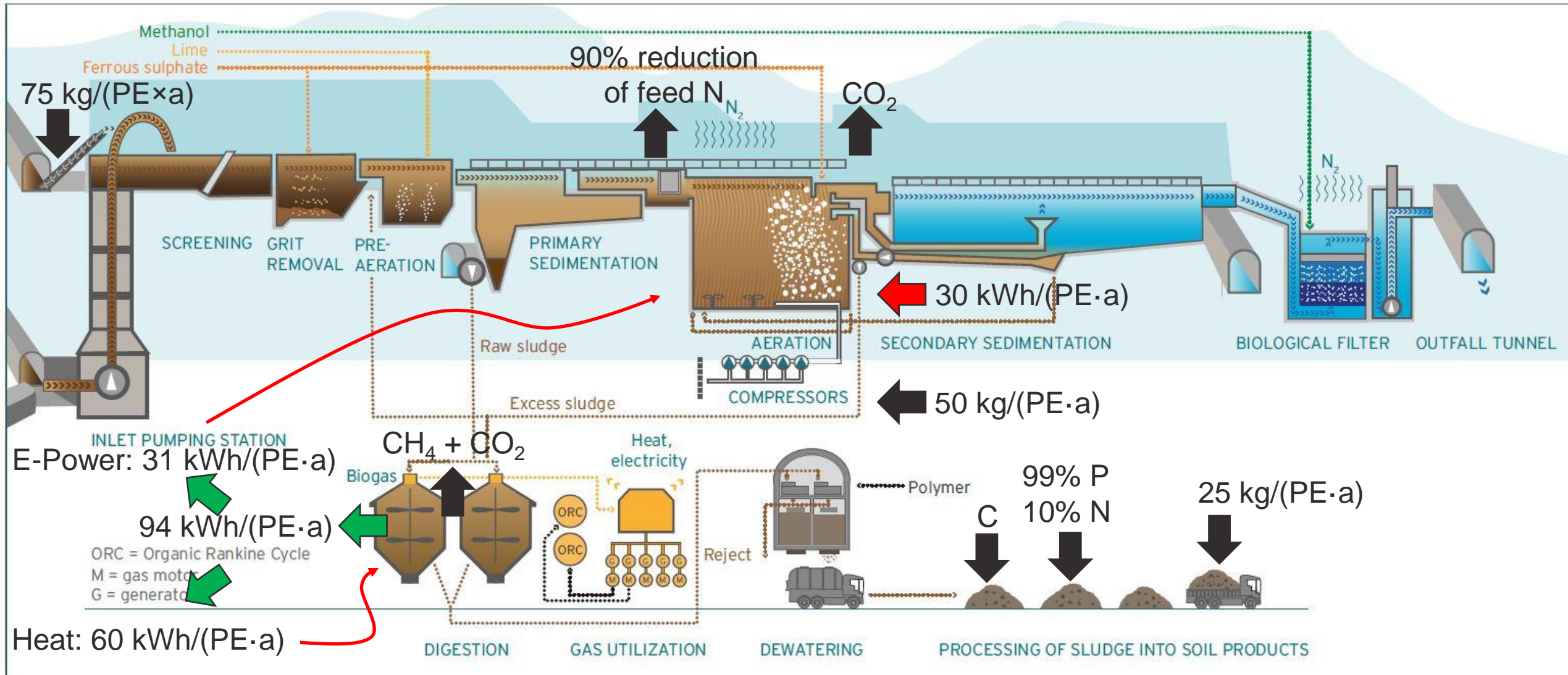

The Value in Waste

Waste reduction

- Minimizing the treatment costs
- Minimizing the disposal costs
- Degradation of harmful substances

Energy content

- Adding an extra loop to the carbon cycle

Recycling

- Nutrients: N and P are valuable compounds – Cleaning step
- Prohibiting nutrients from release to the natural water cycle
- Recycling organic matter to agriculture



New ideas are needed

Use the remaining 25 kg/(PE_{exa}) → Lower disposal costs

- Make the **biogas yield** more effective → Increased income

Biorefinery – Produce other material than methane

- Hydrogen H₂ has much higher energy content
- Hydrogen is much more versatile
- Produce **bio-based building blocks**
- Monomers for bio-based and biodegradable plastics

More effective nutrient recycling for N and P

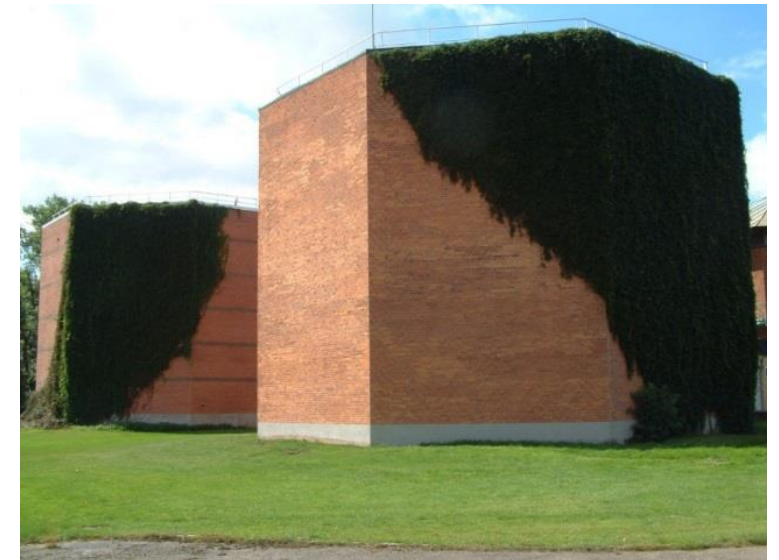

Sources and further reading

Kemira Handbook: About Water Treatment

- Free Download <https://www.kemira.com/insights/water-handbook-2020/>

YouTube: Polymers in Wastewater Treatment:

- <https://www.youtube.com/watch?v=TKAHZECfXok>

Deutsche Vereinigung für Wasserwirtschaft, Abwasser und Abfall (DWA)

- Many publications: <http://de.dwa.de/>

DESTATIS: <https://www.destatis.de/DE/Startseite.html>

European statistical office, EUROSTAT: <https://ec.europa.eu/eurostat/web/main/home>

International Water Association, IWA: <http://www.iwa-network.org/>

Viikinmäen jätevedenpuhdistamo: <https://www.hsy.fi/>

European Sustainable Phosphorus Platform: <https://phosphorusplatform.eu/42-r-d-projects/514-p-rex>

The End – Maybe not ...

Thank you for your attention

Kiitos mielenkiinnostanne

Tack för ert intresse

Questions? – Kysymyksiä? – Frågor?