



MEC-E1003 MACHINE DESIGN PROJECT

Stirling Engine Starter Project

Laboratory Guide

2023

Version 7.1



Aalto University
School of Engineering
Department of Mechanical Engineering



Stirling Engine Kit

Each team has three weeks to complete the following tasks:

- Attend the safety training and workshop orientation.
- Collect the Stirling engine kit.
- Machine the missing parts to complete the engine.
- Measure engine parts (see Measurement Inspections section).
- Assemble engine (see Assembly Instruction section).
- Measure engine speed and temperature (see Testing section).

Steps:

1. The necessary tools, measurement devices, and parts to assemble the Stirling Engine (see Figure 1) when the missing parts have been machined, will be provided in a numbered plastic bin. These bins will be distributed at the end of the first lecture.
2. Arrange with the Design Factory staff when you will attend the safety training and workshop orientation.
3. Arrange with your teammates and the Design Factory staff when you will machine the missing parts, after all team members have attended the safety training and workshop orientation.
4. Arrange with your teammates when it will be your turn, and where and how you collect the plastic bin with the kit from the teammate who had it before you.
5. Each student will individually inspection-measure parts and assemble the Stirling engine, replace everything in the bin, and hand the bin over to the next student.
6. The speed and temperature measurements will be performed in the welding shop in K2 building on Wednesday, September 27, or Friday, September 29, in one of several 1-hour slots in the afternoon.

The kits consists of:

- Caliper
- Outside micrometer
- Hex keys size 3, 2.5 and 2.
- Component parts of the engine



Figure 4 Stirling engine kit at K2 machine shop.

Please make sure all parts and tools are completed when you collect and return the kit.

Engine Assembly Views



Bill of Materials

ID	Part Name	Qty
1	Engine Frame Assembly	
1.1	Engine Frame	1
1.2	Bearing	2
1.3	Bearing Shaft	1
1.4	Base Screw	2
1.5	Connecting Screw	2
1.6	Frame O-ring	2
2	Displacer Assembly	
2.1	Displacer Piston	1
2.2	Displacer Piston Set Screw	1
2.3	Displacer Shaft	1
2.4	Displacer Shaft Pin	1
2.5	Displacer Connecting Link	1
3	Displacer Barrel Assembly	
3.1	Displacer Cylinder	1
3.2	Displacer Barrel	1
3.3	Displacer Cylinder O-ring	3
4	Power Piston Assembly	
4.1	Power Piston	1
4.2	Power Piston Pin	1
4.3	Power Piston Connecting Link	1
5	Power Cylinder Assembly	
5.1	Power Cylinder Head	1
5.2	Power Cylinder	1
6	Power Side Flywheel Assembly	
6.1	Power Side Flywheel	1
6.2	Flywheel Pin	1
6.3	Flywheel Set Screw	1
7	Displacer Side Flywheel Assembly	
7.1	Displacer Side Flywheel	1
7.2	Flywheel Pin	1
7.3	Flywheel Set Screw	1
8	Base Assembly	
8.1	Base Plate	1
8.2	Base Plate Label	1
8.3	Base Pad	4
9	Burner Assembly	
9.1	Burner Vial	1
9.2	Burner Cap	1
9.3	Burner Wick	1

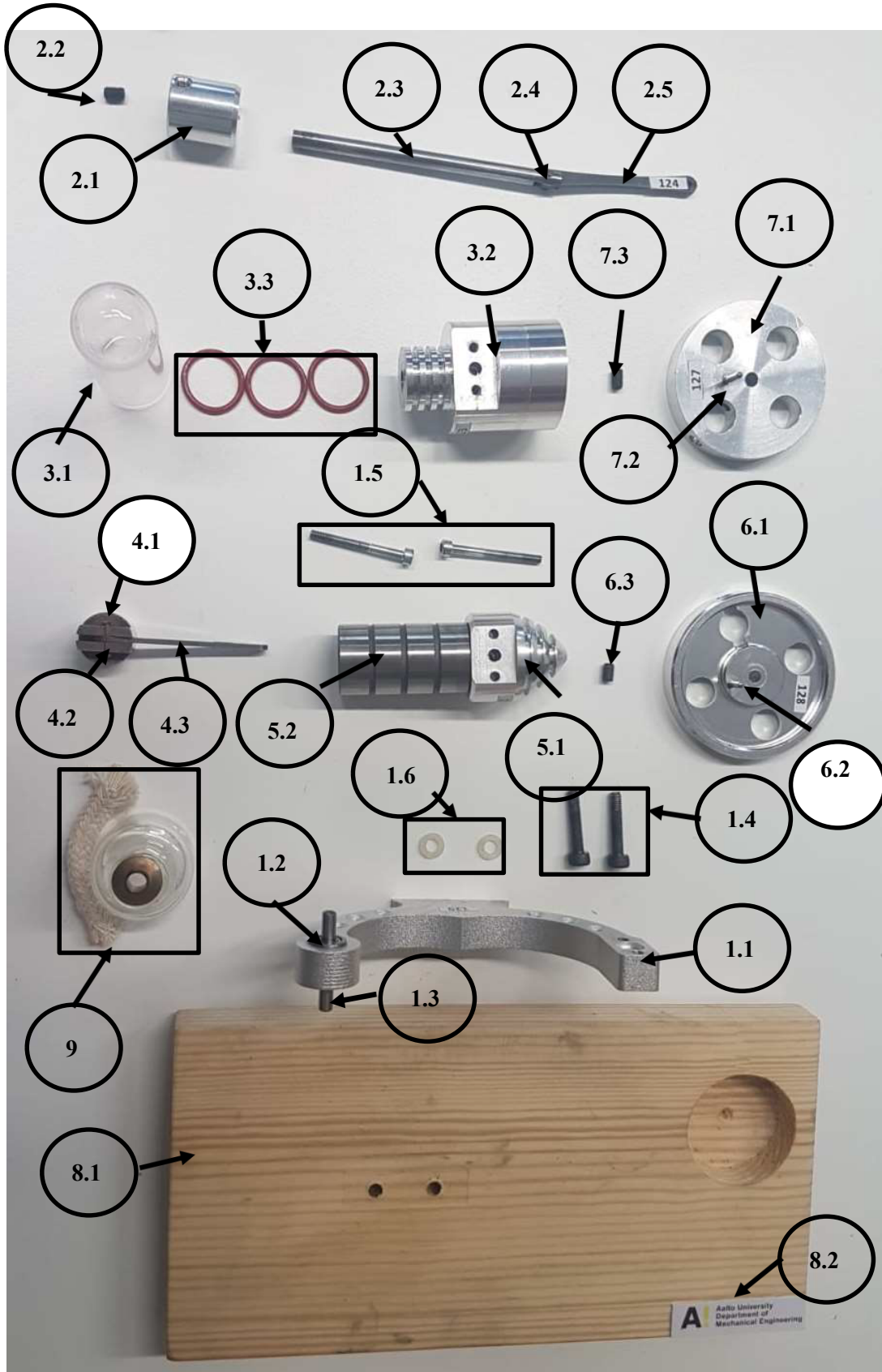

Parts Identification.

Displacer Barrel Part Drawing

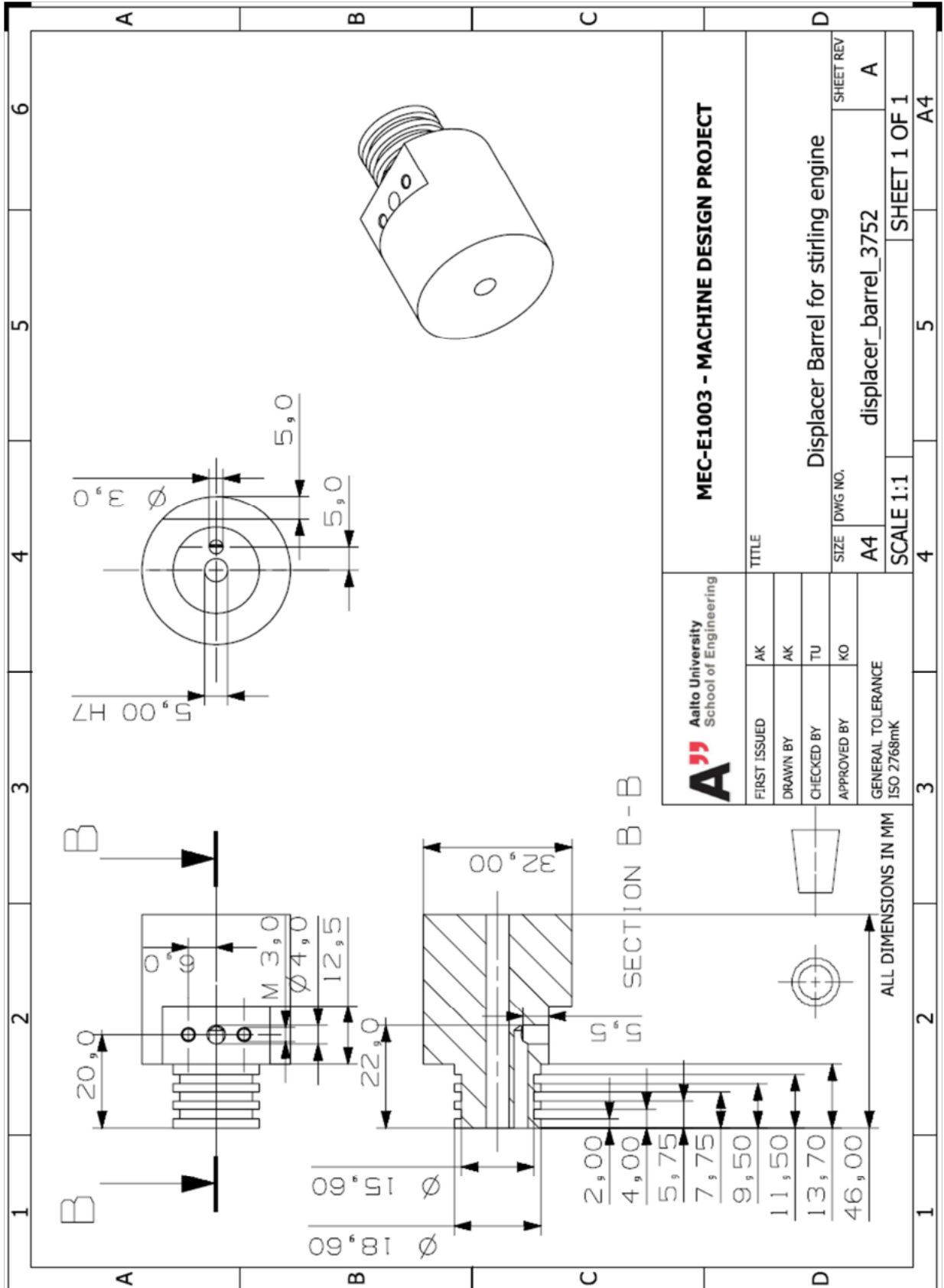

Displacer Side Flywheel Part Drawing

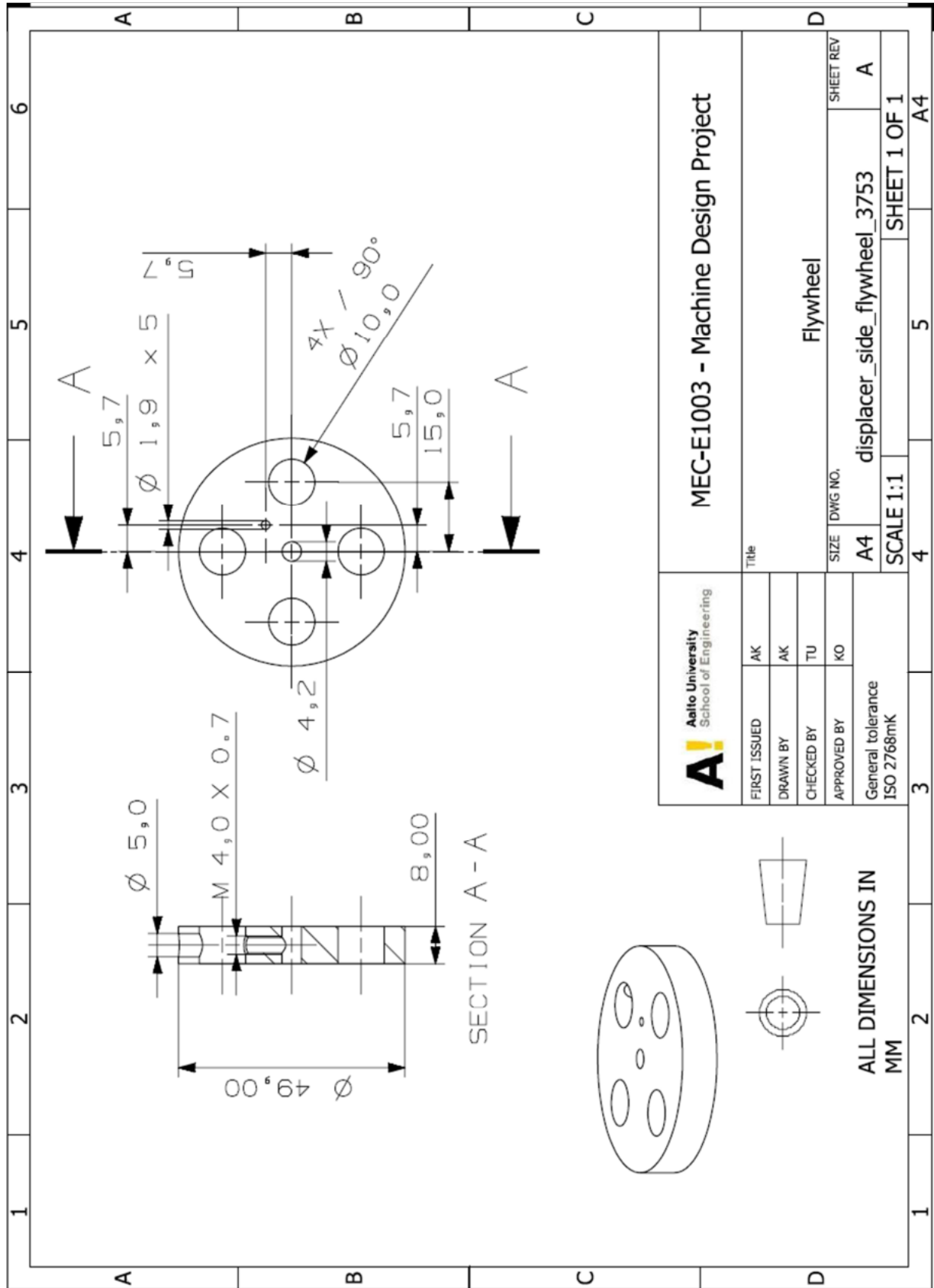

Stirling Engine Major Parts

For simplified reference, Figure 1 shows the names and placements of the major components of the engine.

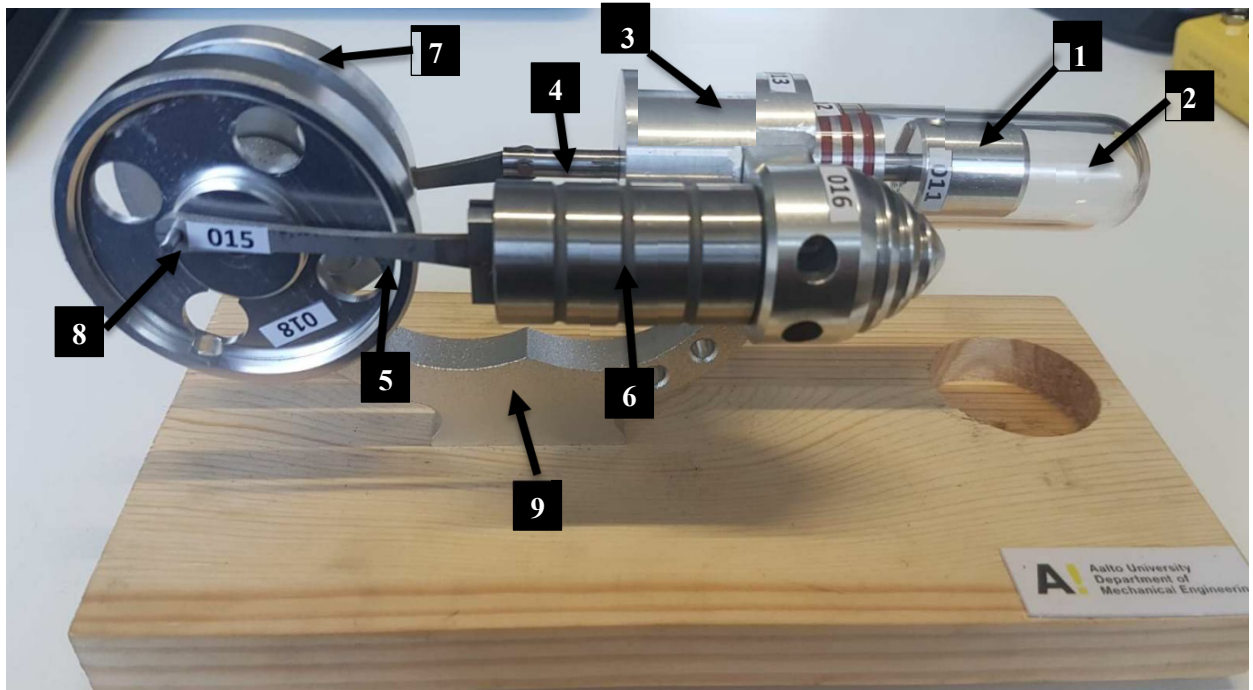

Figure 1 Parts for Inspection

Part number	Part name
1	Displacer
2	Displacer Cylinder
3	Displacer Barrel
4	Displacer Rod
5	Power Piston Assembly
6	Power Cylinder
7	Displacer Side Flywheel
8	Power Side Flywheel
9	Engine Frame

Measurement tools

You will learn and use two measurement devices, the caliper and the micrometer. Each are precision devices capable of sub-millimeter accuracy when used properly. Also other part properties will be measured including mass.

Caliper

If you have never used a caliper, please review instructions:

<https://www.wikihow.com/Use-a-Vernier-Caliper>

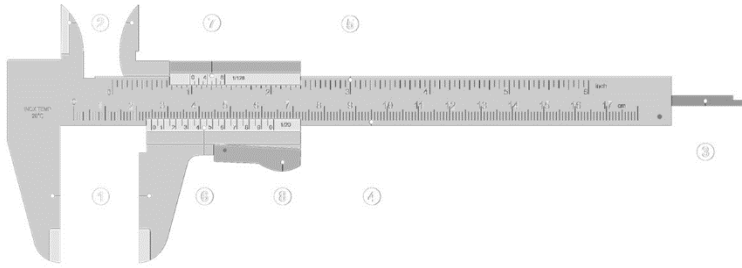

Figure 2 caliper

Micrometer:

If you have never used a micrometer, please review instructions:

<https://www.wikihow.com/Use-and-Read-an-Outside-Micrometer>



Figure 3 outside micrometer

Part Measurement Inspections

Inspection measurements will be taken for purposes of verifying the parts meet dimensional specifications. Several different types of measurements will be taken, including inside and outside dimensions, for practical experience. Dimensions on two parts can be compared against the part drawings provided above.

This guide will help you through the measurements. To ensure that the measurements are precise you must follow the instruction for taking each measurement.

Each measurement to be take is described next. Each measurement device to be used is listed as the *Tool*. Record the measurement to the decimal point stated as *Resolution*. Each measurement should be repeated 5 times. Measure each part one at a time across all 11 measurements. Then, restart at the first measurement. Do not take 5 measurements back to back individually.

Try to understand what you actual measurement repeatability really is. There is no correct answer, and smallest is not best. *Record your measurements in the spreadsheet template provided on the course website.*

Complete the data collection using the Excel spreadsheet “Measurement_Template2020.xlsx”.

MEC-1003 MACHINE DESIGN PROJECT MEASUREMENT SHEET											Engine Identification number:											
Do Not move cells in this document											ID											
Fill in Name field, Measurements, Part and Measurement ID if exist on part																						
Every student fills separate xls																						
Measurement number	Unit	Resolution	Part ID	1	2	3	4	5	Average	Std Dev	Displacer Piston Ampliud	Power Piston Ampliud	Expansion swept volume	Compression swept volume	Displacer cylinder inner diameter	Displacer cylinder outer diameter	Displacer cylinder length	RPM	Engine speed	Displacer cylinder temperature	Power cylinder temperature	
Displacer piston length	mm	0.01																				
Displacer piston diameter	mm	0.01																				
Displacer Rod Diameter	mm	0.001																				
Power Piston Diameter	mm	0.001																				
Power Piston length	mm	0.01																				
Displacer side flywheel pin location	mm	0.01																				
Power side flywheel pin location	mm	0.01																				
Displacer side flywheel Pin Diameter	mm	0.01																				
Power side flywheel Pin Diameter	mm	0.01																				
Displacer side flywheel diameter	mm	0.01																				
Power side flywheel diameter	mm	0.01																				
Displacer Piston Ampliud				0	0	0	0	0														
Power Piston Ampliud				0	0	0	0	0														
Expansion swept volume				0	0	0	0	0														
Compression swept volume				0	0	0	0	0														
Displacer cylinder inner diameter	mm	0.001																				
Displacer cylinder outer diameter	mm	0.001																				
Displacer cylinder length	mm	0.01																				
RPM																						
Engine speed	RPM																					
Displacer cylinder temperature	C																					
Power cylinder temperature	C																					

The cells in yellow should be completed individually remotely.

The cells in orange will be completed later at the K2 shop on the testing day.

Displacer Piston

The Displacer Piston is the part that moves the air inside the Displacer Cylinder, see ❶ in figure 2.

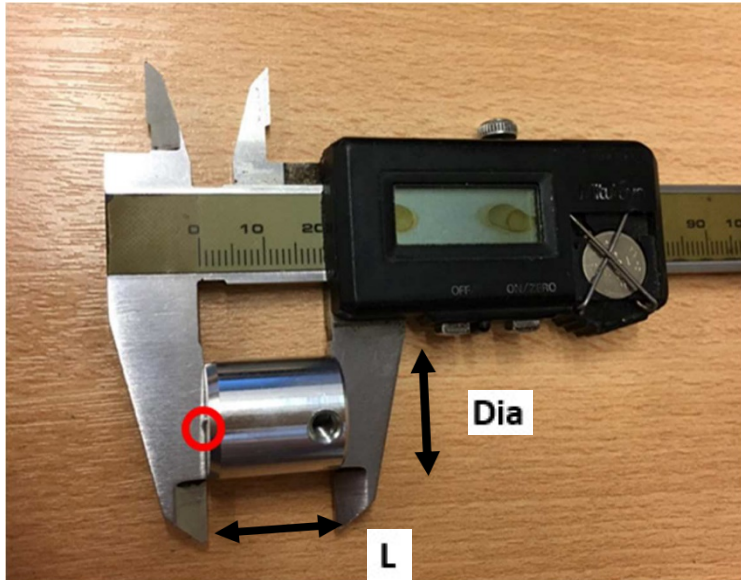

Figure 5 measure length (L) and the diameter (Dia) of the displacer. A Burr is shown by the red circle.

Displacer Piston length

Shown in Figure 5 as dimension L.

Tool: Caliper

Resolution: 0.01 mm

Notes: Ensure that you measure from the flat surface and not on the burr (suom. Jäyste).

Displacer Piston Diameter

Shown in Figure 5 as the dimension Dia.

Tool: Caliper

Resolution: 0.01 mm



Figure 9 Micrometer measurement of displacer rod diameter

Displacer Rod Diameter

The Displacer Rod Diameter is shown in Figure 9.

Tool: Micrometer

Resolution: 0.001 mm

Power Piston Assembly

The Power Piston Assembly consists of the Power Piston, Power piston pin, and the Power Piston connecting link. The Power Piston is the metal part that slides in the Power Cylinder, see ⑤ in Figure 2.

Power Piston



Figure 10 Power Piston diameter measurement

Power Piston Diameter

The Power Piston diameter is shown in Figure 10.

Tool: Micrometer

Resolution: 0.001 mm

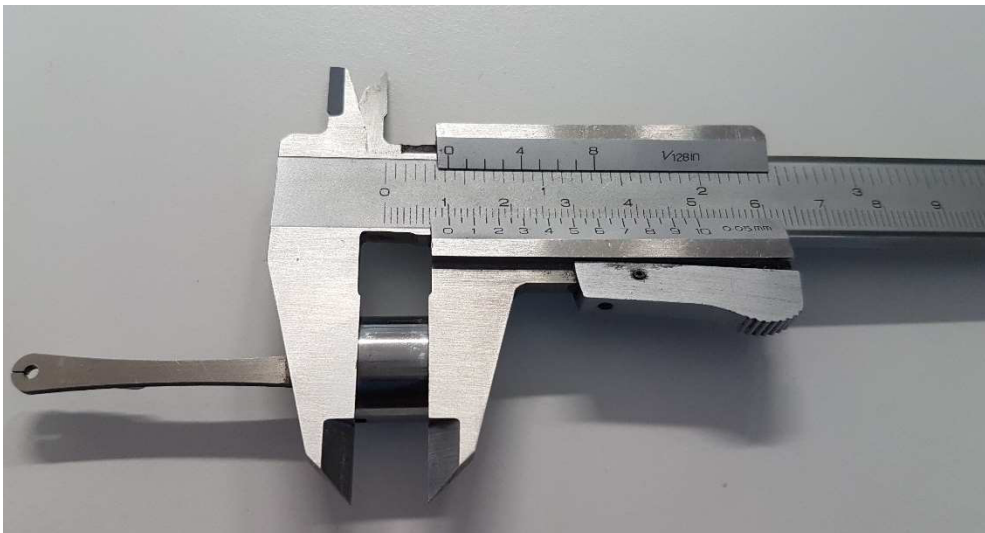

Figure 11 Power piston length measurement

Power Piston length

The Power Piston length is shown in Figure 11.

Tool: Caliper

Resolution: 0.01 mm

Flywheel Assemblies

Both flywheels require the same measurements, and so are described together. The Displacer Side Flywheel Assembly consists of the Displacer Side Flywheel and the Displacer Side Flywheel Pin, see ⑦ in Figure 1. The Power Side Flywheel Assembly similarly consists of the Power Side Flywheel and the Power Side Flywheel Pin, see ⑧ in Figure 1.

Displacer Side Flywheel



Figure 12 Pin location measurement

Displacer Side Flywheel Pin location

The pin location on the flywheel is shown in Figure 12.

Tool: Caliper (Step measurement)

Resolution: 0.01

Note: Ensure that you find the smallest distance between flywheel outer surface and pin.



Figure 13 Pin diameter measurement

Displacer Side Flywheel Pin Diameter

The flywheel pin diameter is shown in Figure 13.

Tool: Caliper (Step measurement)

Resolution: 0.01



Figure 14 Flywheel diameter measurement

Displacer Side Flywheel diameter

The Displacer Side Flywheel diameter is shown in Figure 14.

Tool: Caliper

Resolution: 0.01

Power side flywheel

Repeat these same measurements as the displacer side.

Power Side Flywheel Pin location

The pin location on the flywheel is shown in Figure 12.

Tool: Caliper (Step measurement)

Resolution: 0.01

Note: Ensure that you find the smallest distance between flywheel outer surface and pin.

Power Side Flywheel Pin Diameter

The flywheel pin diameter is shown in Figure 13.

Tool: Caliper (Step measurement)

Resolution: 0.01

Power Side Flywheel diameter

The flywheel diameter is shown in Figure 14.

Tool: Caliper

Resolution: 0.01

There are remaining part inspection measurements needed on the glass displacer cylinder. These will be provided as part of the final testing.

This concludes the part inspections needed.

Derived Measurements

There are additional variables we seek to have inspected for assurance, but for which are difficult or impossible to measure directly. Derived units such as power or efficiency may have specifications, but there is no direct sensor of these quantities. Rather, multiple measurements are taken and a formula applied.

For example, we may need to know a shaft radius. Invariably, we measure the diameter. Then we compute the radius with a formula of half the diameter.

For this engine, we will measure four variables of interest using formulas of directly measured variables. These include

- Displacer Piston Amplitude: half the stroke length of the displacer piston
- Power Piston Amplitude: half the stroke length of the power piston
- Expansion Swept Volume: the volume of air moved when the displacer piston moves
- Compression Swept Volume: the volume of air compressed/expanded

These variables are important for thermodynamic power.

Displacer Piston Amplitude

$$\text{Amplitude} = \text{Flywheel Diameter} / 2 - \text{Piston Location} - \text{Pin Diameter} / 2$$

Power Piston Amplitude

$$\text{Amplitude} = \text{Flywheel Diameter} / 2 - \text{Piston Location} - \text{Pin Diameter} / 2$$

Displacer Piston Swept Volume

$$\text{Swept Volume} = \pi \text{Diameter}^2 / 4 * \text{Amplitude} * 2$$

Power Piston Swept Volume

$$\text{Swept Volume} = \pi \text{Diameter}^2 / 4 * \text{Amplitude} * 2$$

Compute these for a row-wise sample of the five measured values, to generate five computed derived measurements.

Inspection Measurement Reflection

Look at the standard deviations of the part measurements. What do you notice?

You should see that your individual repeatability with a measurement device is larger than the resolution of the device. The device resolution is the best case only theoretically possible, with infinite patience and zero variation in process or environment.

You should see some dimensions have larger measurement repeatability standard deviation. These are more difficult for you to measure.

Are there any outliers in the 5 sample measurements? Why do you suppose?

For the two parts with drawings, how do their tolerances compare to your repeatability standard deviation? You would want that your measurement error is more than 10× smaller than the tolerance.

Finally, how does the variation of the derived variables compare with the variation of the directly measured variables?

Assembly Instructions

Only after completing the previous part inspections can you begin the assembly.

Tools

- Hex key size 3
- Hex key size 2,5
- Hex key size 2

Engine assembly

1. Install Engine Frame (1.1) to Base Plate (8.1) with two Base Screws (1.4), per Figure 15.

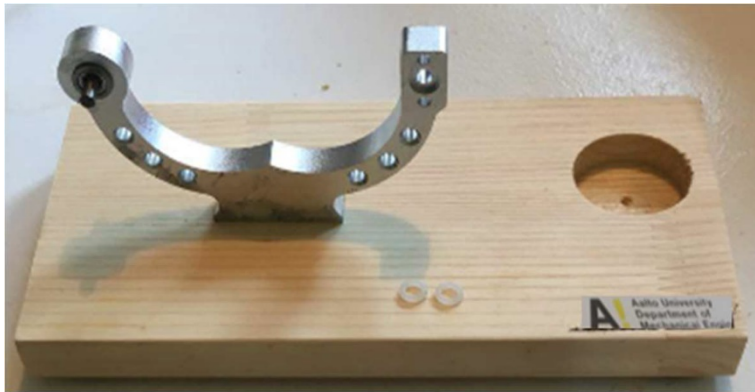

Figure 15 Engine frame assembly.

2. Install power (6) and displacer (7) side flywheel to Bearing Shaft (1.3), Figure 16. Flywheels are tightened to the shaft by Flywheel Set Screws (6.3 & 7.3). Ensure that pins (6.2&7.2) are perpendicular.



Figure 16 Flywheels assembly.

3. Set Frame O-rings (1.6) into Engine Frame (1.1), show in Figure 16 with red circle. This requires no tools, just place O-rings into the groove on the both sides of the engine frame. The location of the groove is shown in red circle in the above figure.
4. First, ensure the red Displacer Cylinder O-rings (3.3) are place onto Displacer Barrel (3.2) o-ring grooves, the Displacer Cylinder shown in Figure 17. If they have been removed, carefully install. Do not remove once installed, they can tear if over stretched. Do not remove for next use of the kit during disassembly on Day 3.
5. Insert Displacer Shaft (2.3) through center hole of the Displacer Barrel (3.2).
6. Place Displacer Piston (2.1) into the end of the Displacer Shaft (2.3). Ensure that the Displacer Piston Set Screw hole is aligned with flat surface on the shaft. Tighten the Displacer Piston Set Screw (2.2) to lock the Displacer Piston to the shaft, Figure 17.



Figure 17 Displacer piston assembly.

7. Place the Power Piston Assembly (4) into the Power Cylinder Assembly (5). Rotate the Power Piston to ensure the smallest friction between cylinder and piston.
8. Place Displacer Flywheel Pin (6.2) into the hole on the Displacer Connecting Link (2.5). Similarly place the Power Flywheel Pin (7.2) into the hole on the Power Piston Connecting Link (4.3). Figure 18.



Figure 18 Flywheels, displacer piston, and power piston assembly.

9. Put the Connecting Screws (1.5) through the Power Cylinder (5.1), Engine Frame (1.1) and tighten them into the threaded Displacer Barrel (3.2). Do not use more than finger force. The threads in the aluminum barrel are weak. Figure 19.



Figure 19 Flywheels, displacer piston, and power piston assembly.

10. While tightening the connecting screws, slightly rotate the flywheels to find lowest possible friction position of the cylinders in the hole allowance around the screws you are tightening. Allow the Displacer Piston to gently rotate slightly until you find the best possible position for it within the screw how allowance. Screw holes must always be slightly oversized.



Figure 20 Flywheels, displacer piston, and power piston assembly.

This completes the remote assembly tasks. The engine is not yet complete, you still need to install the displacer cylinder. You will do this last step in the K2 laboratory on the testing day.

11. The last step of the assembly you will do in the K2 shop, adding the Displacer Cylinder. Place the Displacer Cylinder (3.3) onto the Displacer Barrel (3.2), pushing against the o-ring friction. Use only mild hand force. Rotate the Displacer Cylinder backward and forward until the fit is tight and does not leak.

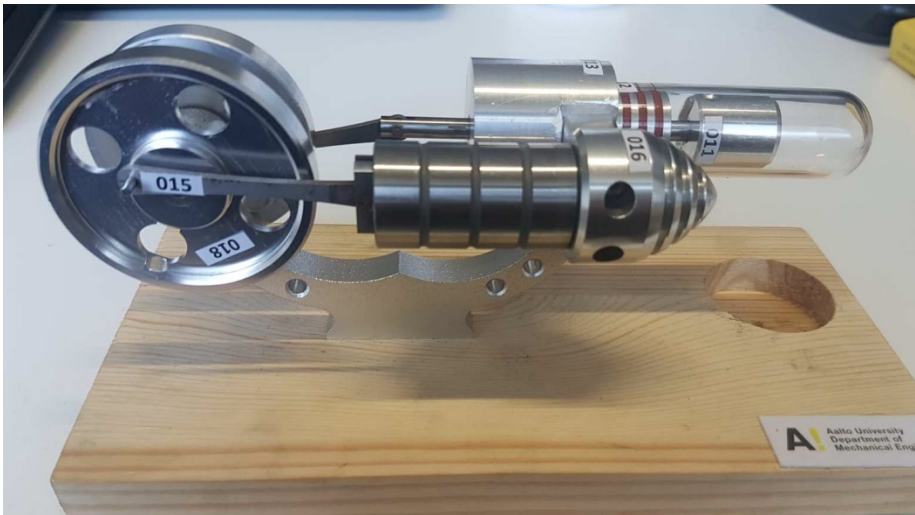

Figure 21 Engine final assembly.

Assembly Process Reflection

Notice the precision machined surfaces versus the non-machined surfaces.

Consider the functional surfaces.

- Where parts must rotate relative to one another
- Where parts must translate relative to one another
- Where parts must seal

What do you think the tolerances and fits must be on these parts and interfaces?

Consider the joint between any two mating parts. Each part interface must be defined relative to each part in 3 positions and 3 rotations. If you think of a spot on each part, we would like the position and orientation of each spot to the other to be precise.

- What defines the X position between the two parts? The surfaces, a machine element, or is there a small free allowance introducing positional error?
- Similarly, what defines the Y position between the two parts?
- Similarly, what defines the Z position between the two parts?
- Similarly, what defines the X rotational between the two parts?
- Similarly, what defines the Y rotational between the two parts?
- Similarly, what defines the Z rotational between the two parts?

Considering the first question against the second, where is this machine design weakest on provided tolerances versus needed functionality?

K2 Machine Laboratory Safe Work Practice and Policy

Read this entire K2 machine shop safety instructions before accessing to machine shop.

This is the minimum safe work practice for K2 machine shop to ensure safety of faculty, staff, students and research personnel as well as facility. Safety is top priority.

Use of machine shop resources is prioritized in following order: externally funded projects, research, department & school dictated technical services and education. ME department staff or student hobby use access is evaluated case by case basis by shop supervisor. Students are not provided access outside regular hours of operation.

- working alone in machine shop is forbidden
- machine tools may only be used by authorized personnel
- shop users must complete mandatory safety training and machine specific instruction before getting authorization for a specific machine tool
- students must have a faculty sponsor and signed endorsement for training & instruction
- authorization is personal and is valid for one year (refresher is provided if necessary)
- one K2 *staff member* must always be present on location to supervise
- student access is only during staff working hours
- never leave machine running unattended
- shop supervisor keeps list of training record
- shop supervisor gives each time clearance for use (setup & tools)
- machine tool guards must be used
- use chip/coolant shield
- use secure work-holding fixtures, remove spanner or chuck key
- protective gear (eyes & hearing) plus suitable clothing must be used, long hair must be tied back
- get to know nearest first aid point and eye wash station as well as nearest exit routes in case of fire
- machine and surroundings must be cleaned afterwards
- remove chips only with hook and brush, do *not* use pressurized air
- all tooling & equipment must be returned to proper places
- report tool damage, maintenance needs and safety concerns immediately to staff
- no eating or drinking at machine shop (room 105d is for coffee breaks).

Guideline for safety & machine tool authorization at K2 is 9 x 1,5 h training & demo = 15 h within 10 weeks. Scheduling and availability follows course requirements. A limited (for one specific machine too safety & machine tool training and authorization can be provided by shop supervisor depending on staff work load and project work order queue.

Use common sense, do not hurry. Stay safe!

Version 1.4 2016-08-26 (JP & SN & PK & EN & KA)

K2 Final Assembly

There remains one additional part to inspect and assemble. The inspections results are provided at the test fixture. They are precise to 0.001mm, and made use of an inside micrometer as as shown below. If you wish to make these inspections yourself, you may, let the teaching team know and arrangements can be made.

Displacer Cylinder

The Displacer Cylinder is the glass part that does not moves, see ② in figure 2.



Figure 6 Cylinder diameter measurement

Displacer Cylinder inner diameter

Shown in figure 6.

Tool: Caliper

Resolution: 0.01 mm



Figure 7 Cylinder outer diameter measurement

Displacer Cylinder outer diameter

Shown in figure 7.

Tool: outside micrometer

Resolution: 0.001 mm



Figure 8 Cylinder length measurement

Displacer Cylinder length

Shown in figure 8.

Tool: Caliper

Resolution: 0.01 mm

These dimensions are provided at the three test fixtures for each of the cylinders provided at each test fixture.

Operating Instructions

Only operate the engine in the K2 shop, welding room. You must come on campus to fuel the engine, run the engine and attain a speed test with the tachometer, and then drain the engine fuel.

At K2 welding room will be available 3 stations for running and testing the engine.



Figure 22 Testing stations at K2 shop, welding room.

Upon completion of the testing, you must then disassemble the engine and return it to the kit, and return the kit to K2.

Operation Pre-Check

Read this entire Operating Instructions section before attempting to operate the engine.

Ensure there is a fire safety certified staff in the K2 laboratory, or you may not fill, light or operate the engine.

Make sure the heat transfer cylinder and power cylinder do not leak air. A vacuum should exist against the power cylinder.

Ensure there is little friction in the moving parts, the engine does not have a lot of power. Even a small amount of friction can prevent running.

Make sure the displacer piston rod travels easily through the transfer piston guide bushing, add a tiny drop of oil as necessary. One drop is sufficient, two drops is excessive and will slow your engine.

Make sure there is no oil or dirt in the power cylinder or your engine will not run. With a paper towel made damp with a small amount of alcohol, wipe the inner cylinder as needed. In a safe isolated spot, allow the used paper towel to evaporate all alcohol and maintain supervision until completely evaporated. Note that oil from the transfer piston rod evaporates during operation and a portion subsequently condenses on the power cylinder. The power cylinder will get oiled over time and will need periodic cleaning.

Operational Test Preparation

First, finish the assembly by installing the glass Displacer Cylinder, step 11 of the previous assembly instruction.

Next, prepare the engine for speed test measurement. Cut a piece of black tape and paste it covering the hole located on the outer edge of the power flywheel (see Figure 23). This is the reflector tape that the laser tachometer will pick up to indicate speed.

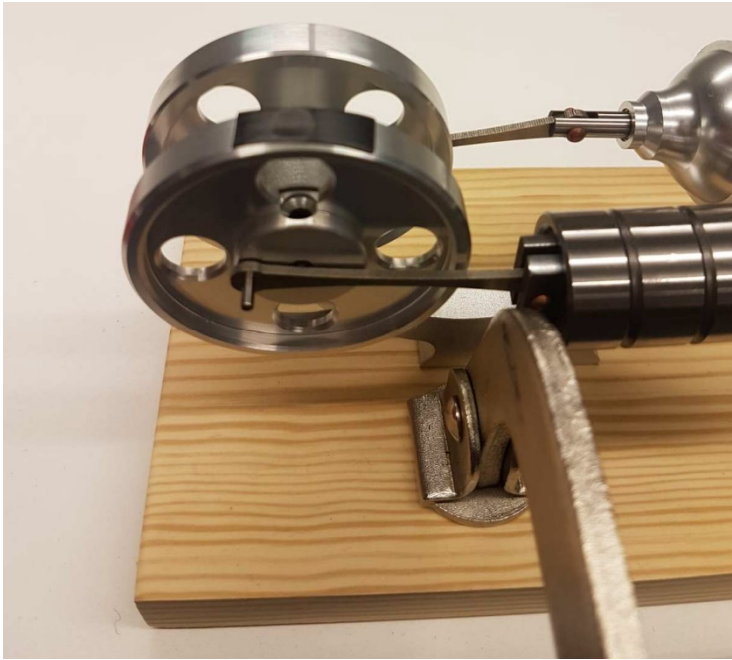

Figure 23 Reflecting tape on power side flywheel.

Before starting the engine, have an extinguisher readily available. Ensure there is a fire safety certified staff in the laboratory, or you may not fill, light or operate the engine.

Before starting, **WEAR SAFETY GLASSES**. Keep all children away from the engine, this is not a toy.

Check the tightness of the burner wick in the burner cap. It must fit snug with no empty air space and must require pull force to move the wick through the burner hole. If the wick is not snug, extra alcohol can be pulled through the burner generating spilled alcohol over the bottle and an area, creating a fire hazard.

Fill the fuel burner bottle **at most half full** with the provided denatured alcohol, in the orange capped filler bottle. Do not fill more than half full, there is a possibility of the fuel expanding with temperature and over-flowing the bottle. The burning alcohol would then spill over an area, creating a fire hazard.

Engine Test

A laser tachometer will be used to measure the engine revolution per minute.

Place the engine on the metal welding bench table, stable on all four legs, during operation. Use the C-clamp to secure it to the table. Ensure no debris, loose items or flammable materials are near the engine.

Place the burner in the holder on the base. Ensure no spilled alcohol. Ensure the wick is completely wetted with alcohol.

Wear safety glasses. Light the wick with a long stem butane lighter. Allow the flame to burn for a minute. Do not pick up the engine with the flame burning. Do not pick up the engine when it is above room temperature.

After the one minute warm up period, carefully spin the flywheel with the base not moving. The engine should run.

Failure to Run Diagnostics

If your engine does not run:

Are you spinning it backwards? After manually spinning, it should make many rotations in one direction, and few rotations in the opposite.

Is there a gas leak?

Check the screws holding the two cylinders together for tightness, burrs, misalignments, missing O-rings. Are the O-rings sealing?

Check the glass displacer cylinder for seal with the 3 O-rings on the displacer cylinder. Does the cylinder wiggle back and forth too easily?

Are the two crank shafts 90 degrees offset? If not, there will be no power generated.

If it is not one of these, contact the teaching team for help.

Operational Test

Aim the tachometer laser beam at the reflective tapes located on the displacer flywheel, keep the tachometer's laser beam steady. Make sure the tachometer is in RPM mode. Mode can be changed by pressing the MENU button. Each time the tape passes the tachometer's laser beam, some portion of that light will be reflected towards the instrument. The tachometer will count how many times the sensor is triggered during some duration of time.



Figure 24 Speed measurement settings.

Record your RPM measurements using the paper data recording matrix provided. Then later you can transfer this data into the spreadsheet template provided on the course website.

Next, proceed to measure temperatures. Aim the thermometer light at your desired measurement location, wait until the temperature stops varying and record the measurement. Make sure the infrared thermometer is in Celsius scale. Temperature scale can be changed by pressing the button.

Measure the temperature at the displacer cylinder (hot side) at the glass bulb end, with the flame continuing to burn.

Measure the power cylinder side temperature (cold side) using the infrared thermometer.

Repeat these two measurements 5 times, alternating hot and cold side measurements, to record 5 temperature measurements each.

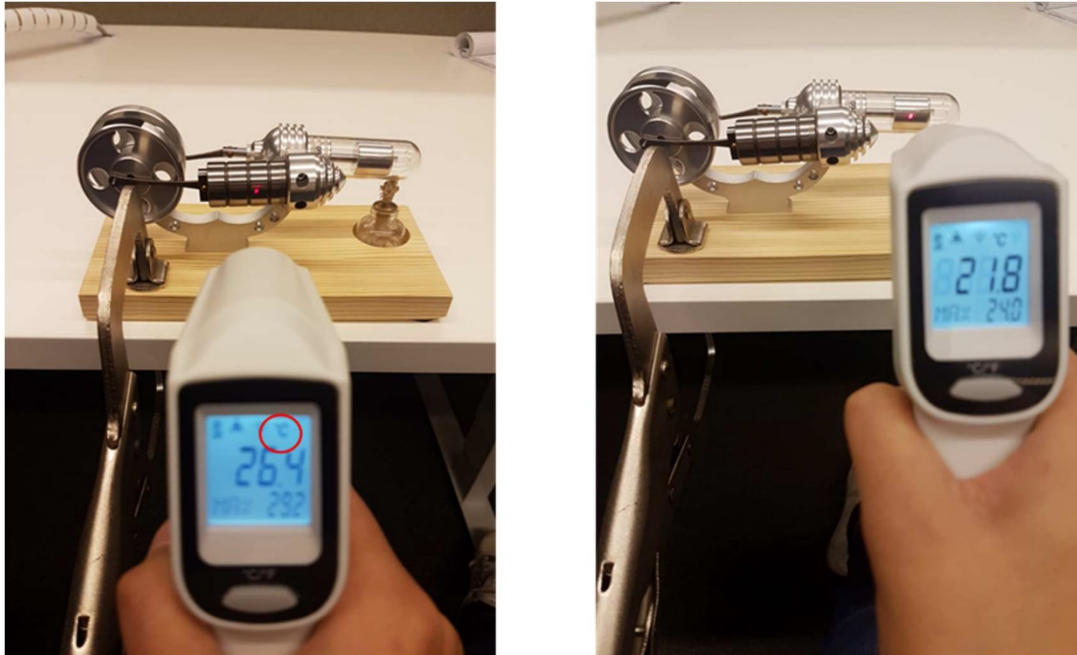

Figure 25 Temperature measurement settings.

Operation Shutdown

To shut the engine off, slow and stop the engine by lightly stalling the flywheel by hand from behind, away from the flame. When the flywheel is not rotating, blow out the alcohol wick.

Do not touch or handle the engine for at least 10 minutes after blowing out the flame. Allow the engine to cool back to a safe room temperature before touching or handling.

After finishing, record your data including speed to MyCourses.

After finishing, disassemble and clean the engine parts. Return back to the original kit form. Return the kit to K2.

This completes the operating instruction.

Operation Reflection

Consider how well the engine ran. What affects how fast the engine runs?

Where is there lost thermal power?

What are machine design ideas to reduce this?

Where is there lost mechanical power?

What are ideas to reduce this?

What are machine design ideas to reduce this?

This completes the operating instruction manual.