

Lecture 1:

Structure of crystalline materials

- Basics of crystalline materials
 - Dimensionality of solids
 - Molecular vs. non-molecular solids
- Key concepts for crystal structures
 - Unit cell
 - Crystal systems
 - Point group symmetry and translational symmetry
 - Crystal classes
 - Lattice types and Bravais lattices
 - Space groups

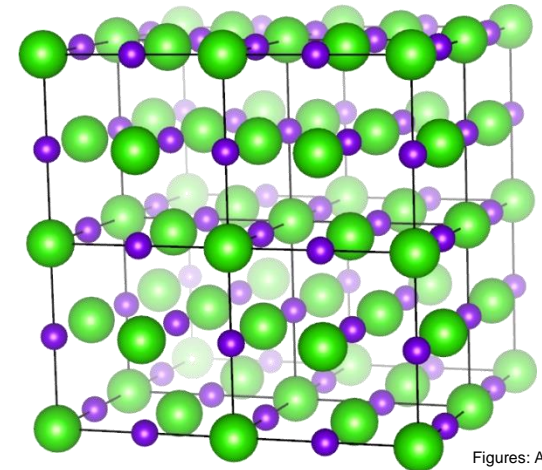
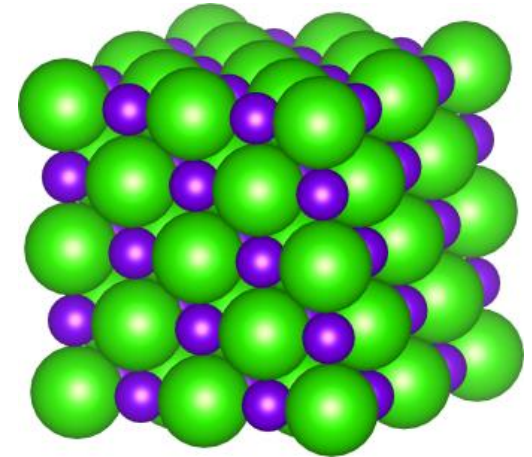

Figures: AJK

Basics of crystalline materials

States of bulk matter

Temperature increases →

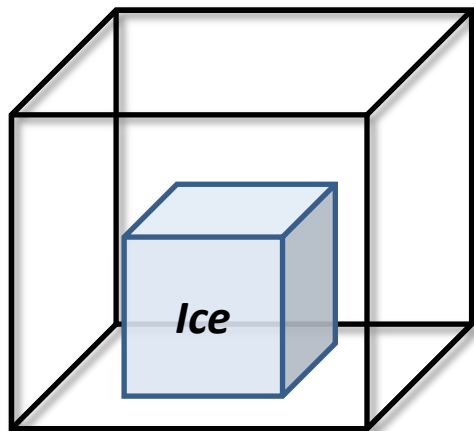

Solid: Adopts and maintains a shape that is independent of the container it occupies.

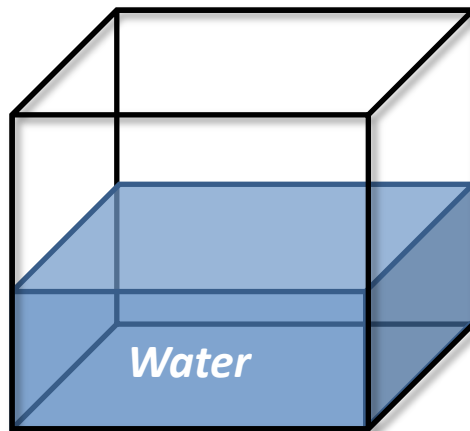

Liquid: Adopts the shape of the part of the container it occupies and is separated from the unoccupied part of the container by a definite surface.

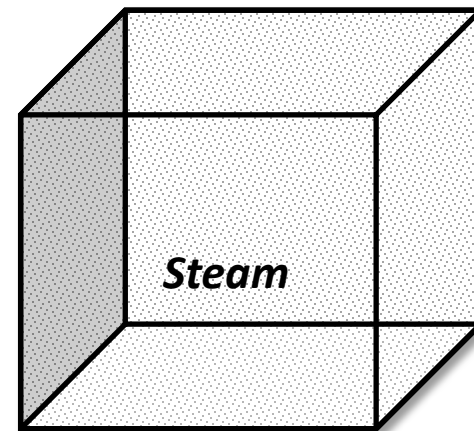

Figures: AJK

Gas: immediately fills any container it occupies

Condensed matter

Fluids (flow in response to forces such as gravity)

Dimensionality of solids

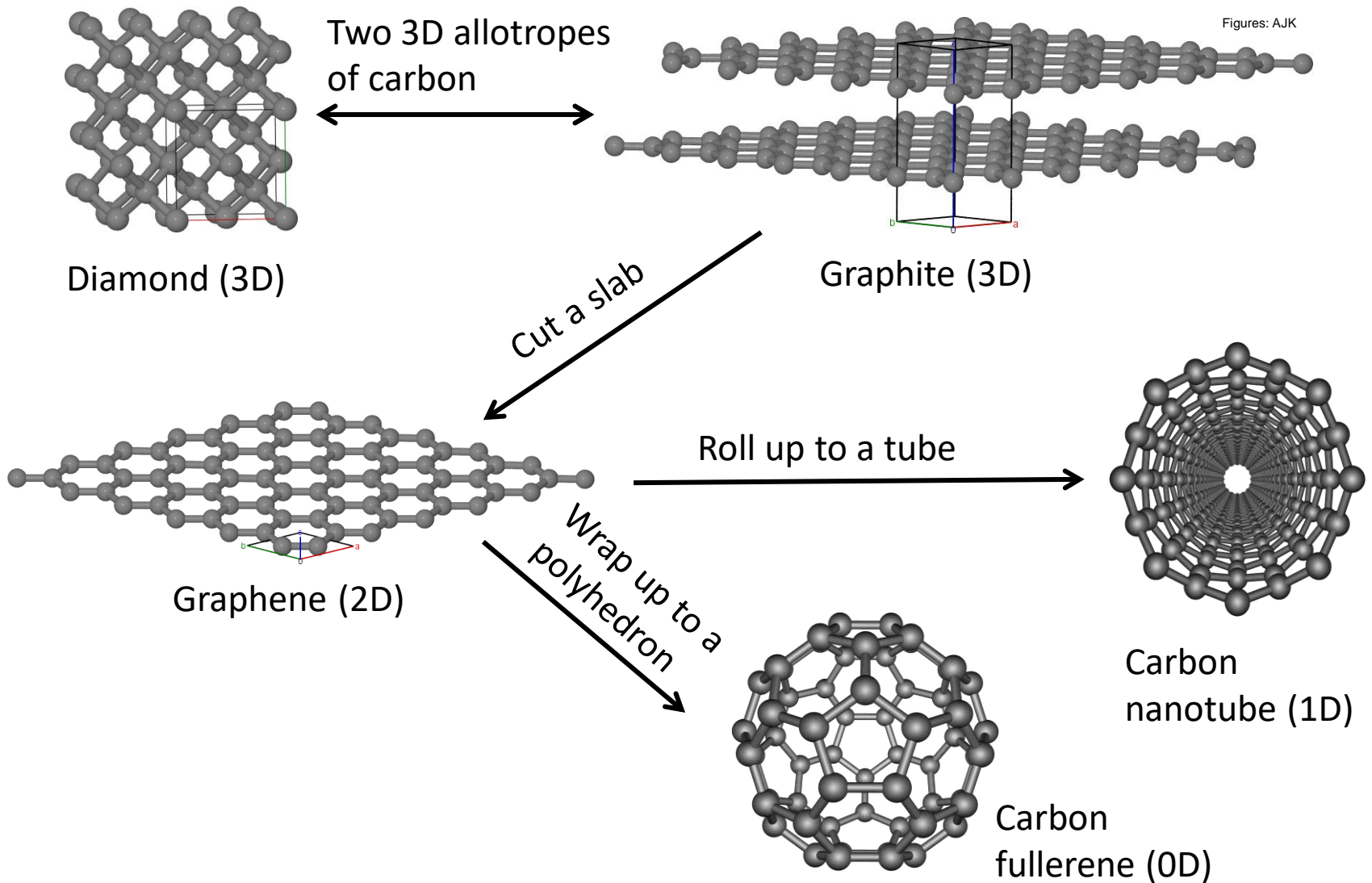

Crystalline materials

- A material is a crystal if it has essentially a **sharp diffraction pattern** ([IUCr definition](#))
- The definition includes
 - Periodic crystals
 - [Aperiodic crystals](#)
 - [Quasicrystals](#)
- **Periodic** crystal is a **regular** arrangement of atoms in three dimensions. These include
 - a) Single crystals
 - b) Polycrystals composed of many crystallites
- **Amorphous materials** are non-crystalline and lack long-range order
 - Not discussed on this course

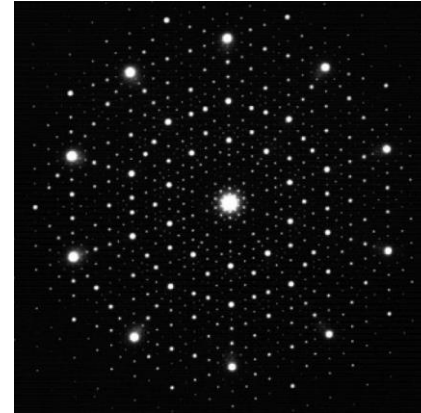

Figure: D. Slichtman/NIST



Photo: Virve Karttunen

Silicon single crystal grown by **Czochralski process** (*Deutsches Museum, München*)

Non-molecular crystalline solids

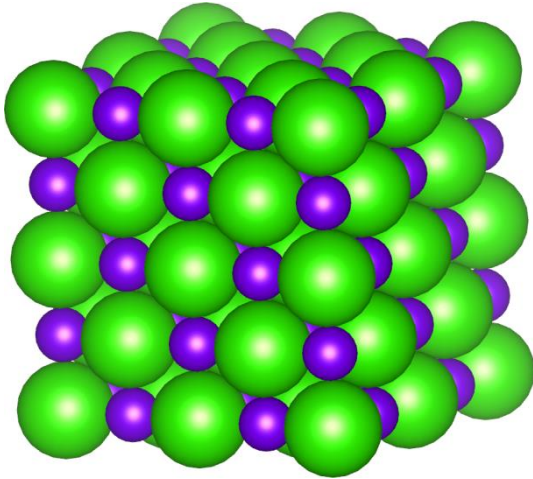

Ionic bonding
(*e.g.* NaCl)

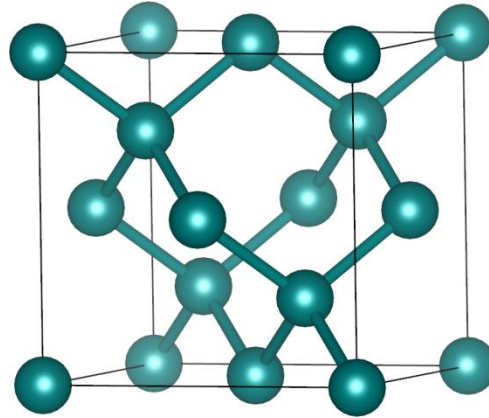

Covalent bonding
(*e.g.* silicon)

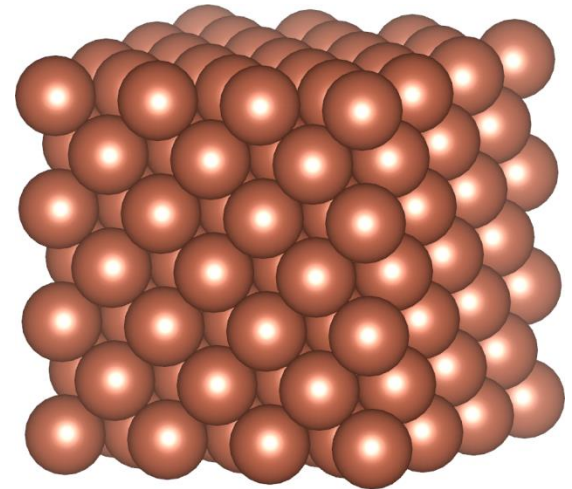

Metallic bonding
(*e.g.* copper)

Figures: AJK

- Coordination polymers such as ***metal-organic frameworks*** show covalent bonding of metal atoms and organic molecules
- Coordination polymers are challenging the traditional classifications of solid state structures (see *e.g.* review of H. Furukawa *et al.*, [Science 2013, 341, 1230444](#)).

Molecular crystalline solids

- Composed of molecules that are held together by (weak) [van der Waals forces](#)
- Discussed only little here, but can be interesting for intercalation chemistry
- Much more relevant for small-molecule chemistry
- **Crystal engineering** using *e.g.* **hydrogen** and **halogen** bonding is making the boundary between molecular and non-molecular solids less clear!

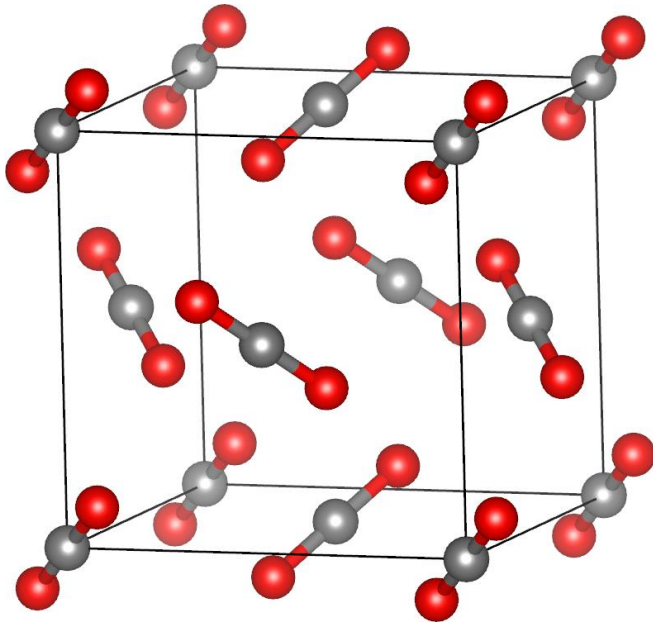

Solid CO₂ (space group *Pa-3*)
[Acta Cryst. B 1980, 36, 2750.](#)

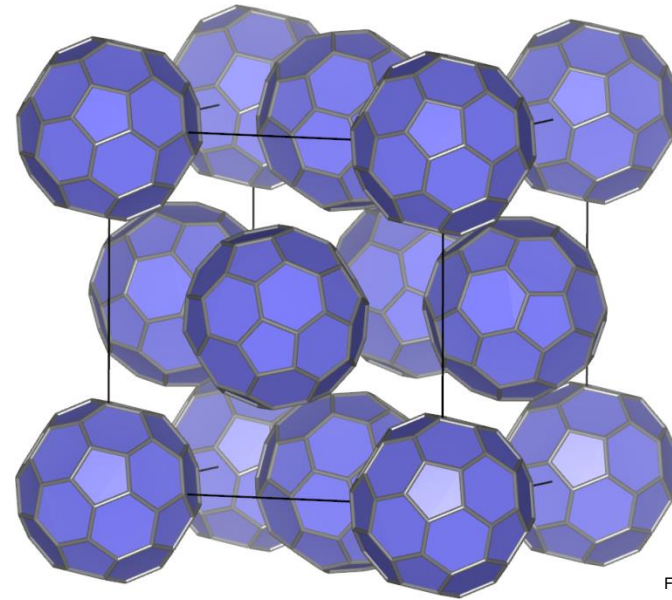

Solid C₆₀ (space group *Pa-3*)
[Nature 1991, 353, 147.](#)

Figures: AJK

Structure determination of crystalline materials

↑ Size scale increases

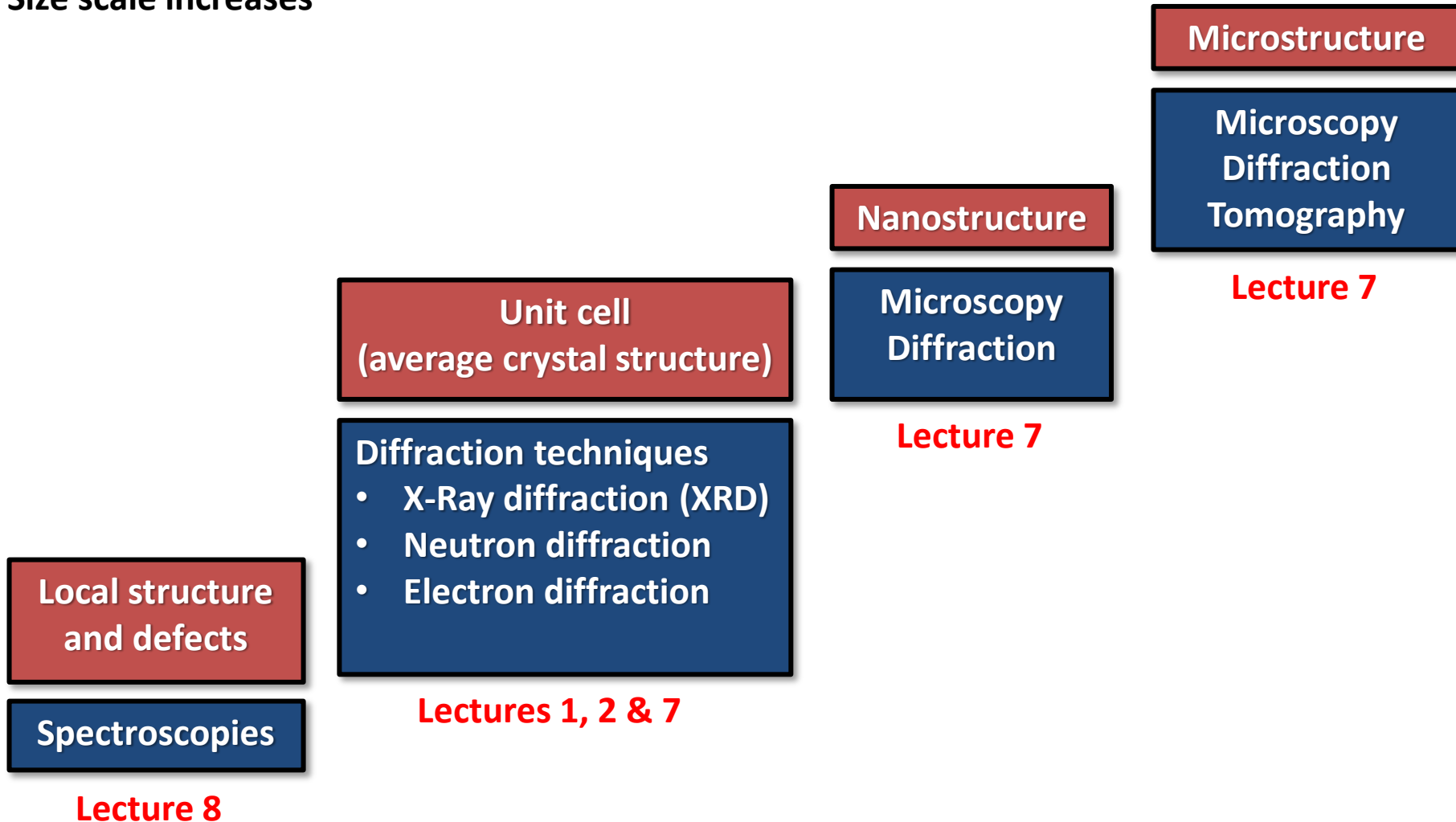

X-ray diffraction

- X-rays are electromagnetic radiation of wavelength $\sim 1 \text{ \AA}$ (10^{-10} m)
 - This matches the scale of atomic-level structure.
- The figure below shows a simplified illustration of single-crystal X-ray diffraction

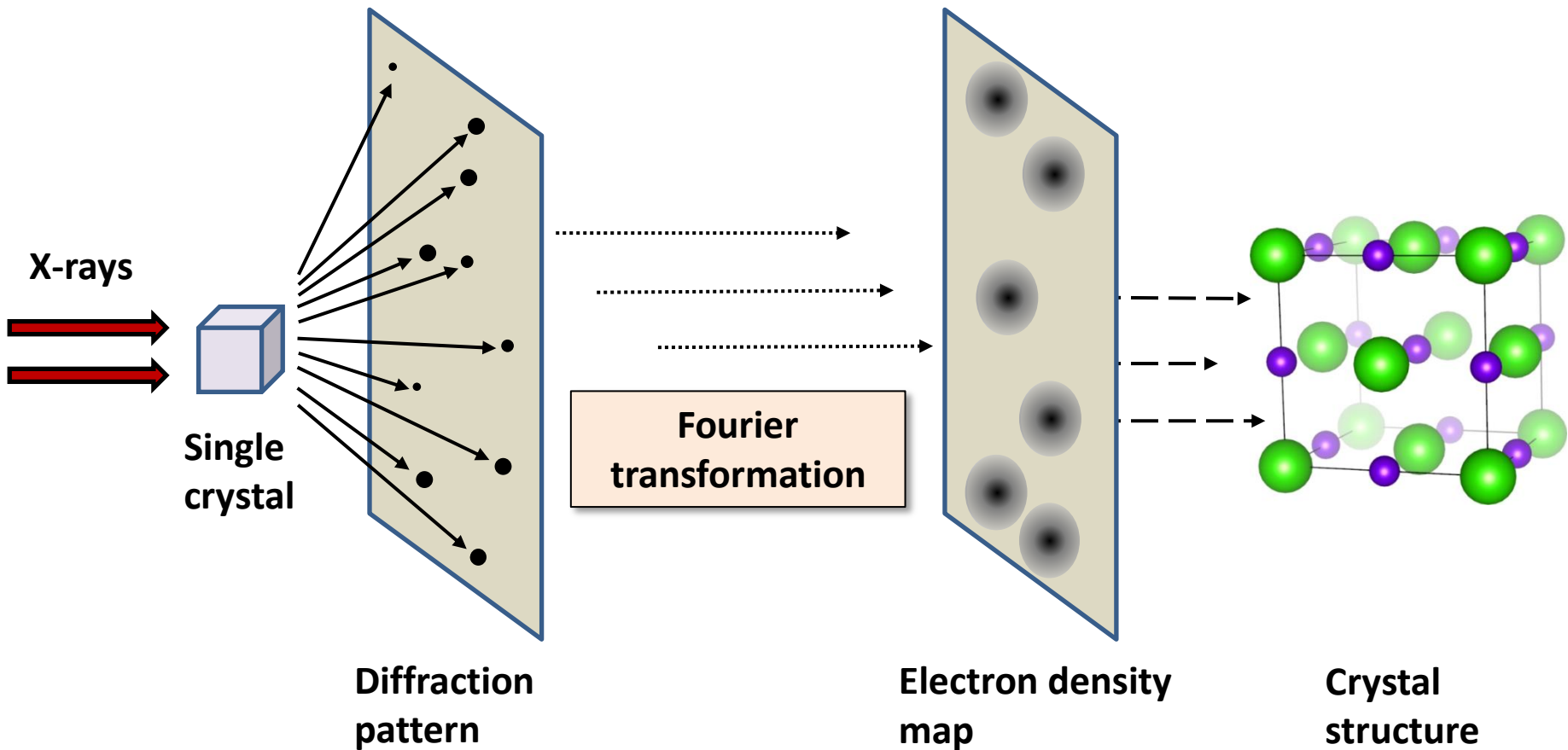

Key concepts for crystal structures

Key concepts for crystal structures

- To describe crystal structures, we will need the key concepts outlined below
- The following slides will introduce the concepts one by one, culminating in the concept of a **space group**

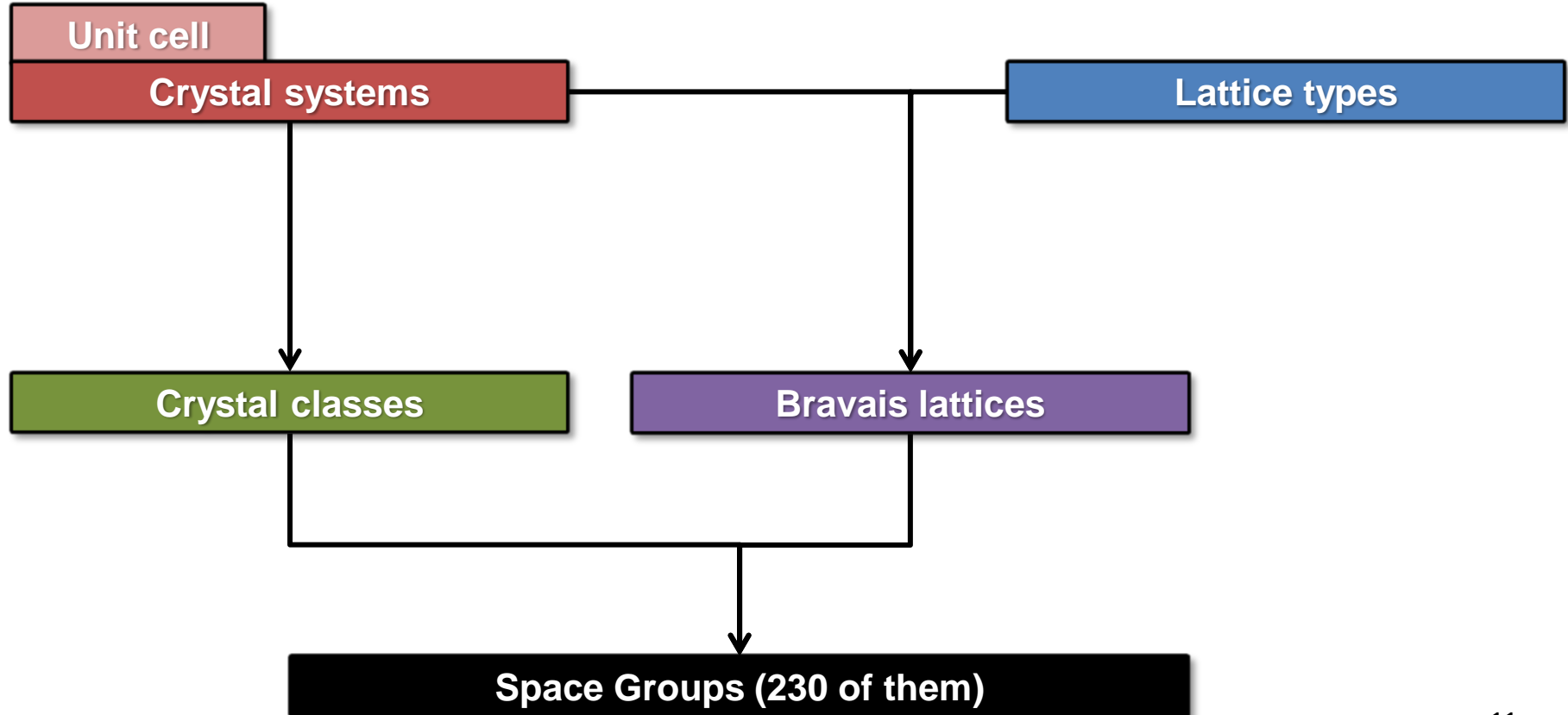

Unit cell

- **Crystal:** Regular arrangement of atoms in three dimensions
- The regular arrangement can be represented by a repeat unit called the **unit cell**
- **Unit cell:** The smallest repeating unit which shows the **full symmetry** of the crystal

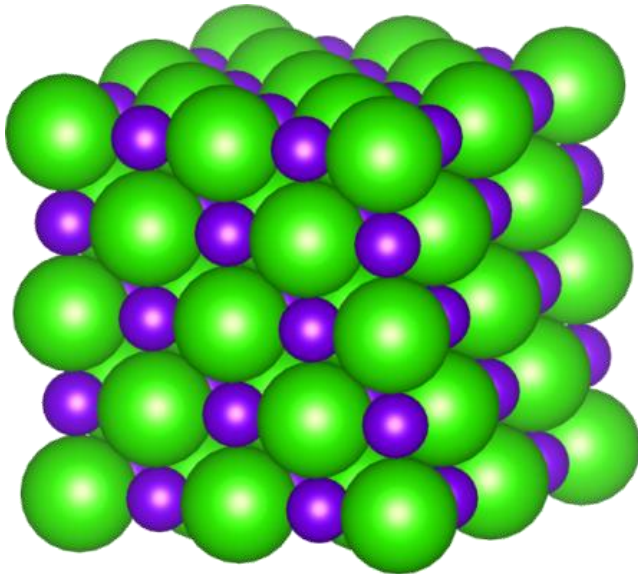

NaCl crystal: Regular arrangement of Na and Cl (space-filling representation)

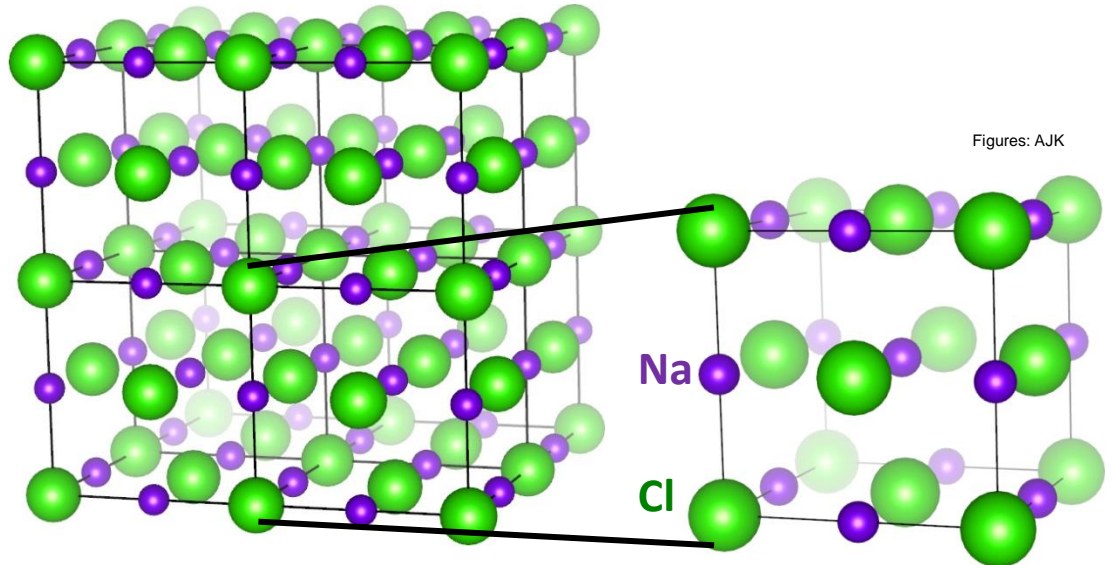

NaCl crystal (non-space-filling representation)

NaCl unit cell

Crystal systems

Figure 1.3 (a) The seven crystal systems and their unit cell shapes; $a, b, c, \alpha, \beta, \gamma =$ Lattice parameters

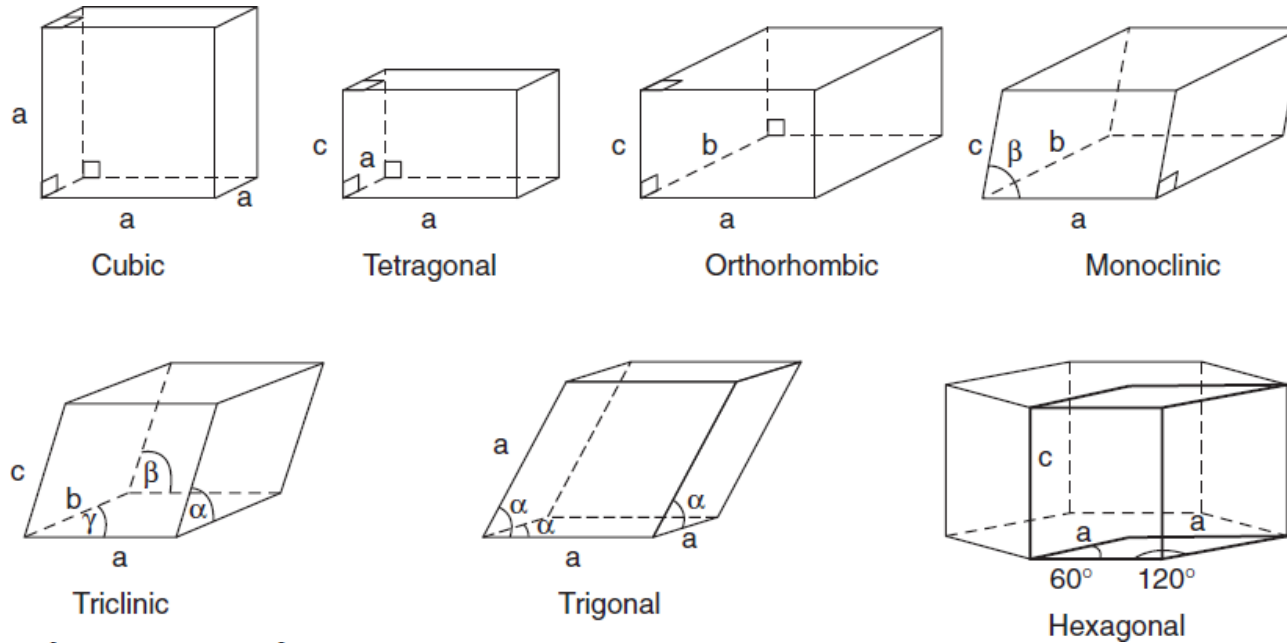
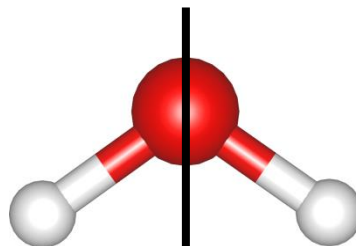

Table 1.1 The seven crystal systems

Crystal system	Unit cell shape ^b	Essential symmetry	Allowed lattices
Cubic	$a = b = c, \alpha = \beta = \gamma = 90^\circ$	Four threefold axes	P, F, I
Tetragonal	$a = b \neq c, \alpha = \beta = \gamma = 90^\circ$	One fourfold axis	P, I
Orthorhombic	$a \neq b \neq c, \alpha = \beta = \gamma = 90^\circ$	Three twofold axes or mirror planes	P, F, I, A (B or C)
Hexagonal	$a = b \neq c, \alpha = \beta = 90^\circ, \gamma = 120^\circ$	One sixfold axis	P
Trigonal (a)	$a = b \neq c, \alpha = \beta = 90^\circ, \gamma = 120^\circ$	One threefold axis	P
Trigonal (b)	$a = b = c, \alpha = \beta = \gamma \neq 90^\circ$	One threefold axis	R
Monoclinic ^a	$a \neq b \neq c, \alpha = \gamma = 90^\circ, \beta \neq 90^\circ$	One twofold axis or mirror plane	P, C
Triclinic	$a \neq b \neq c, \alpha \neq \beta \neq \gamma \neq 90^\circ$	None	P Ref: West p. 3-4

Symmetry

- The most characteristic feature of any crystal structure is its ***symmetry***
- The shape of the unit cell is not enough to determine the crystal system. It is the symmetry of the unit cell that really determines the crystal system
 - For example, a "pseudocubic" crystal structure could have $a = b = c$ and $\alpha = \beta = \gamma = 90^\circ$, but it would not possess the correct cubic symmetry
- In the context of crystals, we will encounter two types of symmetry:
 - **Point group symmetry** (both in crystals and molecules)
 - **Translational symmetry** of the crystal lattice (only in crystals)
- We describe the symmetry properties of crystals and molecules in terms of:
 - **Symmetry elements** (for example, a mirror plane)
 - **Symmetry operations** (the actual process of applying a symmetry element)
- In crystals and molecules, a symmetry operation transfers an atom into a new spatial position that cannot be distinguished from its original position



Mirror plane in a water molecule

Figure: AJK

Point group symmetry

- In point group symmetry operations, at least one point stays unchanged during the symmetry operation
- For learning point group symmetry, we will utilize the Symmetry@Otterbein website: <https://symotter.org/>
- The **point group** of a molecule is based on the symmetry elements that are present

Symmetry element	Symmetry operation	Schönflies symbol
Symmetry plane (mirror plane)	Reflection through plane	σ
Inversion	Every point x,y,z translated to $-x,-y,-z$	i
Proper axis (rotation)	Rotation about axis by $360/n$ degrees	C_n
Improper axis (improper rotation)	Rotation by $360/n$ degrees followed by reflection through plane perpendicular to rotation axis	S_n

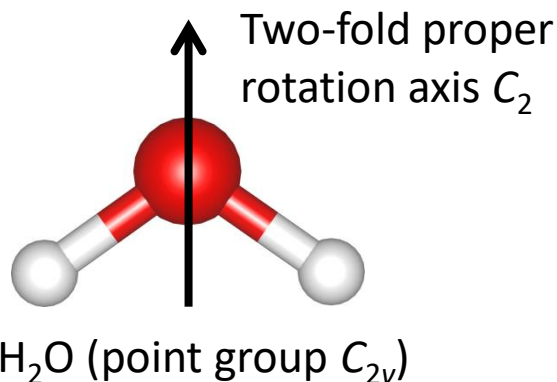
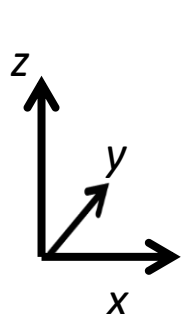

Mirror plane σ_{yz}

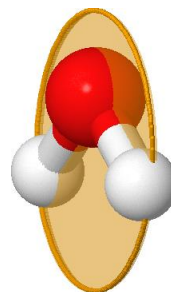

Mirror plane σ_{xz}

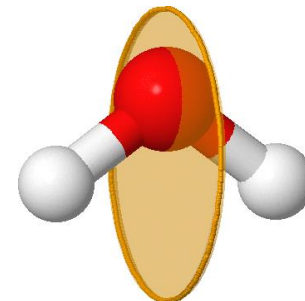

Symmetry elements in crystals

- Crystals may display rotational symmetries 2, 3, 4, and 6, not others
- In crystallography, the symmetries are labeled with **Hermann–Mauguin** symbols
- Crystals show several symmetry elements that are not present in molecules

Symmetry element	Hermann-Mauguin symbol (crystals)	Schönflies symbol (molecules)
Symmetry plane (mirror plane)	m	σ
Inversion	$\bar{1}$	i
Proper axis (rotation)	$n = 2, 3, 4, 6$	C_n
Improper axis (improper rotation)	–	S_n
Elements only in crystals		
Inversion axis (point symmetry)	$\bar{n} = \bar{3}, \bar{4}, \bar{6}$	–
Glide plane (includes translation)	a, b, c, d, n	–
Screw axis (includes translation)	$2_1, 3_1, \text{etc.}$	–

(Inversion axis, glide plane, and screw axis explained in more detail in extra slides)

Crystal classes

- By combining the seven crystal systems and 32 crystallographic point groups, we obtain the following 32 **crystal classes**:

Crystal system	Crystal classes (point groups) in Hermann-Mauguin notation	Crystal classes (point groups) in Schönflies notation
Triclinic	$1, \bar{1}$	C_1, C_i
Monoclinic	$2, m, 2/m$	C_2, C_s, C_{2h}
Orthorhombic	$222, mm2, mmm$	D_2, C_{2v}, D_{2h}
Tetragonal	$4, \bar{4}, 4/m, 422, 4mm, \bar{4}2m, 4/mmm$	$C_4, S_4, C_{4h}, D_4, C_{4v}, D_{2d}, D_{4h}$
Trigonal	$3, \bar{3}, 32, 3m, \bar{3}m$	$C_3, S_6 (C_{3i}), D_3, C_{3v}, D_{3d}$
Hexagonal	$6, \bar{6}, 6/m, 622, 6mm, \bar{6}m2, 6/mmm$	$C_6, C_{3h}, C_{6h}, D_6, C_{6v}, D_{3h}, D_{6h}$
Cubic	$23, \bar{4}3m, m\bar{3}, 432, m\bar{3}m$	T, T_d, T_h, O, O_h

Ref: Müller p. 24, [Wikipedia](#)

Lattice

- The most characteristic feature of any crystal structure is its *symmetry*
 1. Point group symmetry (discussed above)
 2. *Translational symmetry* of the *crystal lattice*
- Crystal structure = *basis* (atoms) + crystal lattice

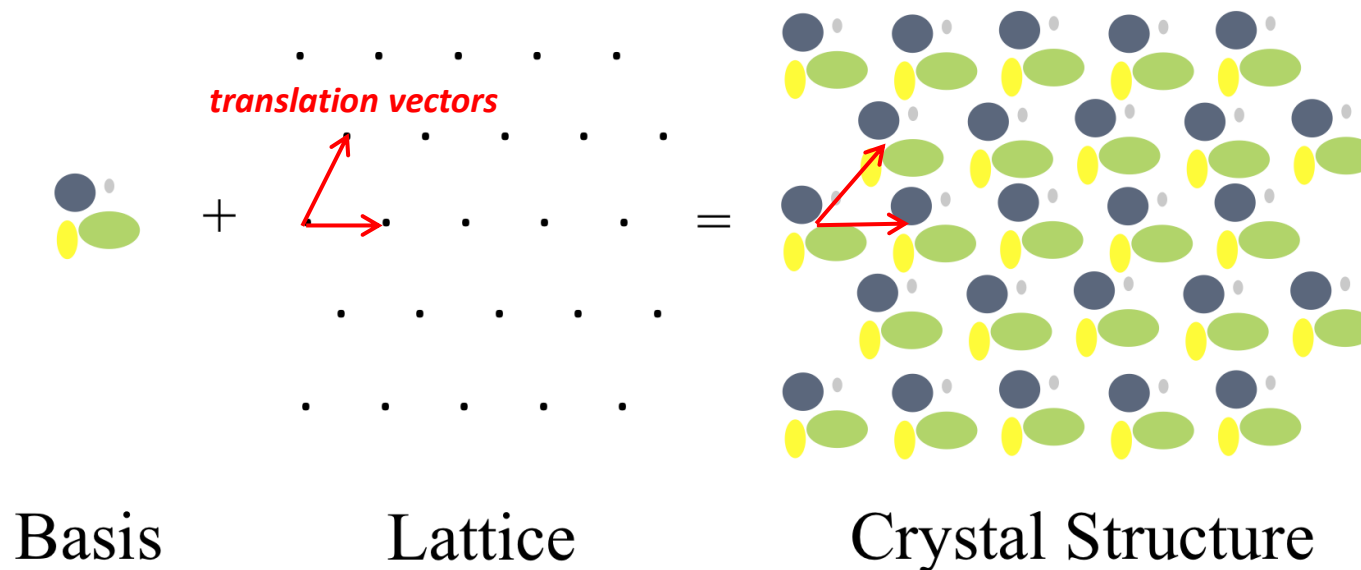

Lattice types

- Every crystal structure belongs to one of five **lattice types**:
 - The balls are lattice points, **not** atoms!

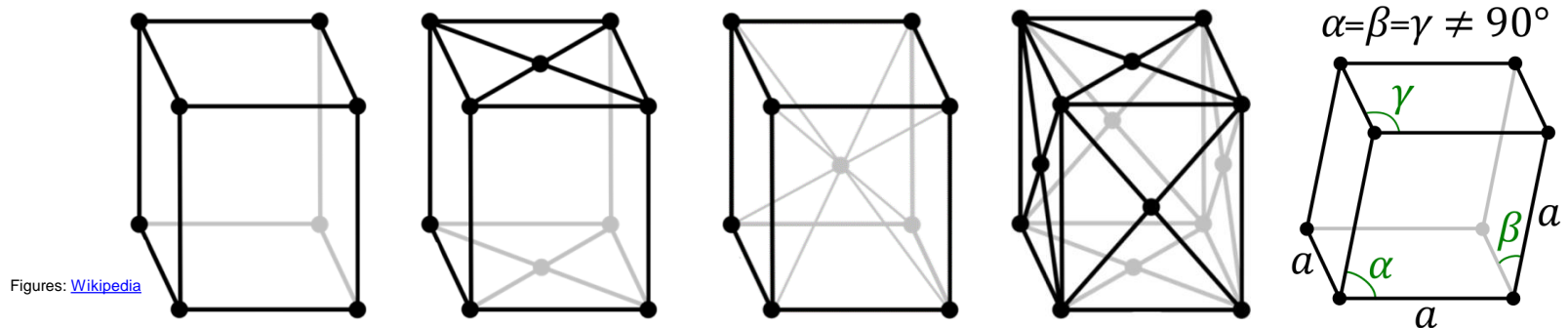

Lattice type	Primitive	Base-centered	Body-centered	Face-centered	Rhombohedral
Symbol	<i>P</i>	<i>A / B / C</i>	<i>I</i>	<i>F</i>	<i>R</i>
$V(C\text{-cell})/V(P\text{-cell})$	1	2	2	4	3

- **Primitive cell**: unit cell with the smallest possible volume
- **Centered unit cell**: the smallest repeating unit which shows the full symmetry of the crystal
- The centered unit cell is 2, 3, or 4 times larger than the primitive cell (table: $V(C\text{-cell})/V(P\text{-cell})$)

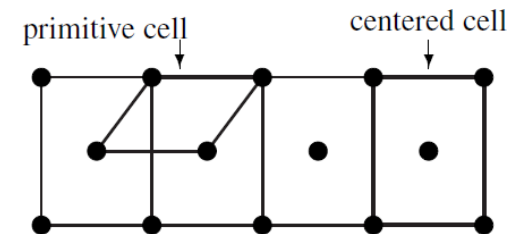

Ref: Müller p. 8

Bravais lattices (1)

- By combining 7 crystal systems and 5 lattice types we obtain 14 *Bravais lattices*

Triclinic

$$\alpha, \beta, \gamma \neq 90^\circ$$

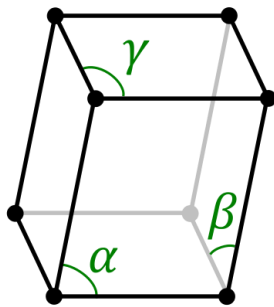

P

Monoclinic

$$\beta \neq 90^\circ \\ \alpha, \gamma = 90^\circ$$

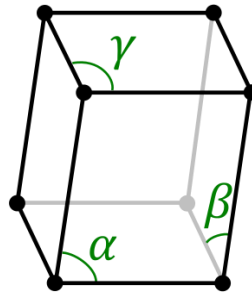

P

$$\beta \neq 90^\circ \\ \alpha, \gamma = 90^\circ$$

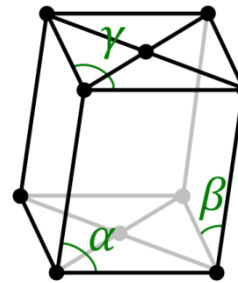

C

Orthorhombic

$$a \neq b \neq c$$

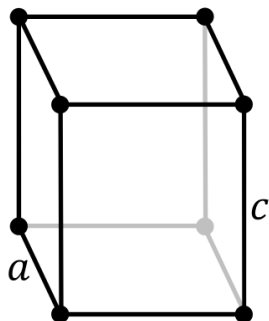

P

$$a \neq b \neq c$$

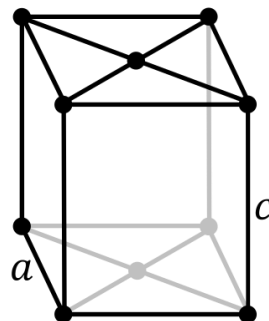

C

$$a \neq b \neq c$$

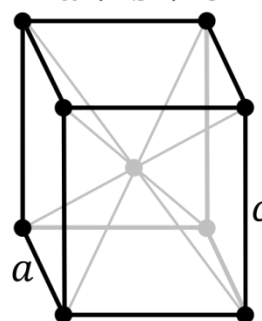

I

$$a \neq b \neq c$$

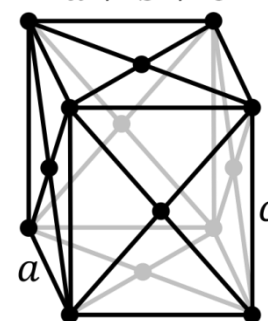

F

Figures: [Wikipedia](#)

Bravais lattices (2)

Tetragonal

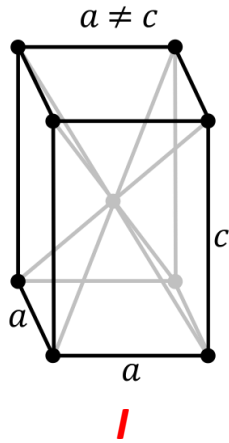
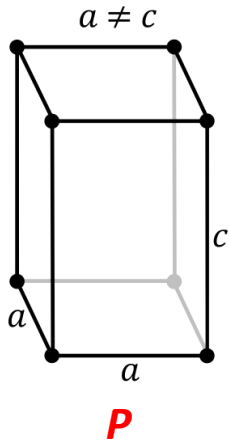

Rhombohedral

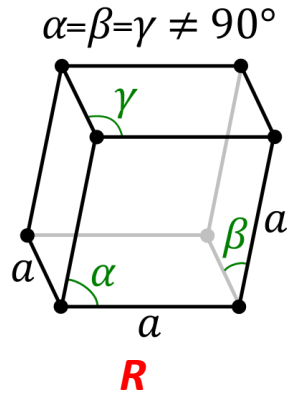

Hexagonal

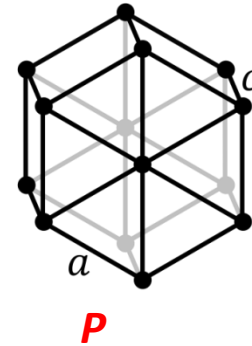

Cubic

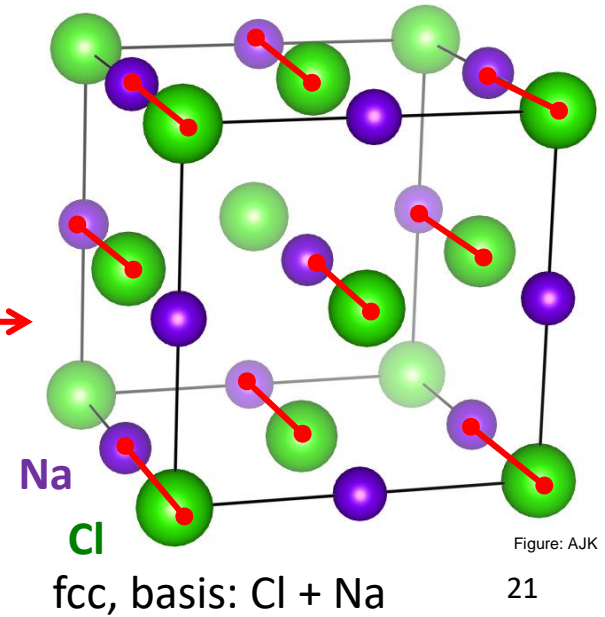
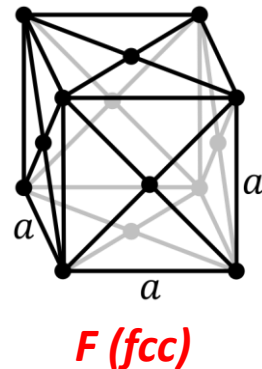
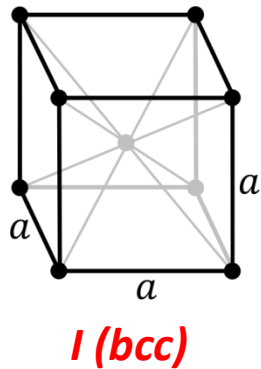
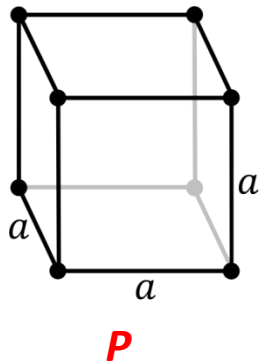

Crystal systems (7 of them)

Lattice types (5 of them)

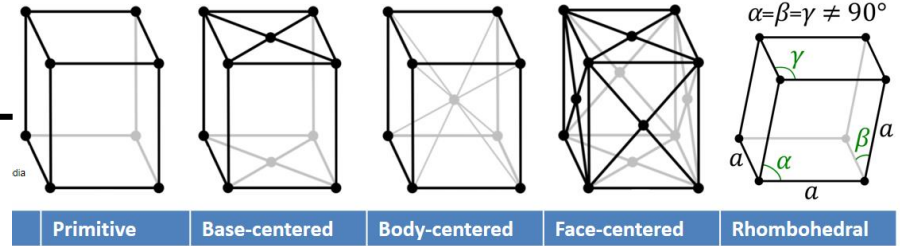
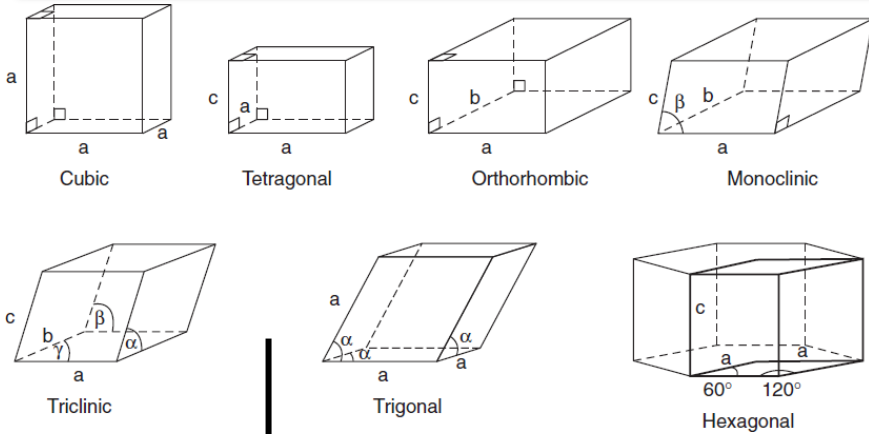

Crystal classes (32 of them)

Bravais lattices (14 of them)

Crystal system	Crystal classes (point groups) in Hermann-Mauguin notation
Triclinic	1, $\bar{1}$
Monoclinic	2, m , $2/m$
Orthorhombic	222, $mm2$, mmm
Tetragonal	4, $\bar{4}$, $4/m$, 422 , $4mm$, $\bar{4}2m$, $4/mmm$
Trigonal	3, $\bar{3}$, 32 , $3m$, $\bar{3}m$
Hexagonal	6, $\bar{6}$, $6/m$, 622 , $6mm$, $\bar{6}m2$, $6/mmm$
Cubic	23, $\bar{4}3m$, $m\bar{3}$, 432 , $m\bar{3}m$

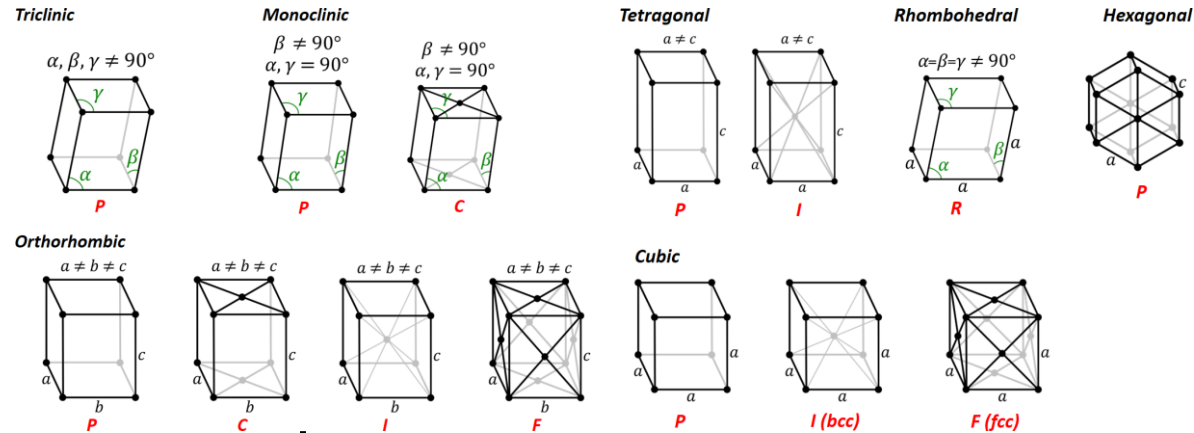

Space Groups (230 of them)

Summary: AJK. Individual figures from [Wikipedia](https://en.wikipedia.org/wiki/Bravais_lattices) and West (p. 3)

Space groups

- The **32** crystal classes and **14** Bravais lattices give rise to **230** space groups
- The Hermann-Mauguin symbol for the space group of NaCl: $Fm\bar{3}m$ (or $Fm-3m$)
- The symbol begins with a capital letter P , A , B , C , F , I , or R , specifying the presence of **translational symmetry** in three dimensions and the lattice type (**centering**)
- The letter is followed by a listing of the other symmetry elements
- Some examples:
 - All **triclinic** space groups: $P1$ and $P-1$
 - Some **monoclinic** space groups: $P2$, Pm , $C2/c$
 - Some **hexagonal** space groups: $P6$, $P6/mmm$, $P6/mcc$
 - Some **cubic** space groups: $Pm-3m$, $Im-3m$
- Note that some space groups can be defined with **alternate axes** and/or **origin** (see e.g. orthorhombic SGs in <http://img.chem.ucl.ac.uk/sgp/large/ortho.htm>)
- Everything about space groups: [International Tables of Crystallography](http://www.itc.dtu.dk/)
- Good resource: <http://img.chem.ucl.ac.uk/sgp/large/sgp.htm>
- Wikipedia: https://en.wikipedia.org/wiki/List_of_space_groups

Defining a crystal structure

- A crystal structure is defined by
 - Space group
 - Lattice parameters
 - Atomic coordinates (positions) in fractional coordinates ($0.0 \leq x, y, z < 1.0$)
 - Normally only ***symmetry-independent*** atoms in the ***asymmetric unit*** are listed
- For example, NaCl
 - ***Fm-3m***
 - $a = b = c = 5.6402 \text{ \AA}$ ($\alpha = \beta = \gamma = 90^\circ$ by definition for a cubic space group)
 - Atomic coordinates (x, y, z): **Cl**: 0.0, 0.0, 0.0; **Na**: 0.5, 0.5, 0.5
- Typically, crystal structures are distributed in Crystallographic Information Files (CIF)
- A ***definition*** of a crystal structure is not usually enough to understand the real chemistry. For this, we need a ***description*** of the crystal structure
 - Concepts such as bonding, packing of spheres, coordination, polyhedra, ...

Formula units (Z)

- Counting the contents of a unit cell for NaCl:
- 8 Cl⁻ ions in the 8 vertices, each belonging to 8 adjacent cells = $8/8 = 1$ Cl⁻ ion in total
- 6 Cl⁻ ions in the 6 centers of the faces, each belonging to two cells = $6/2 = 3$ Cl⁻ ions
- 1 Na⁺ ion in the center of the cell, not shared with other cells
- 12 Na⁺ ions in the centers of the 12 edges, each belonging to 4 cells = $12 / 4 = 3$ Na⁺ ions
- In total **4** Na⁺ ions and **4** Cl⁻ ions
 - NaCl is said to have **4** "formula units" per unit cell
 - Denoted with $Z = 4$

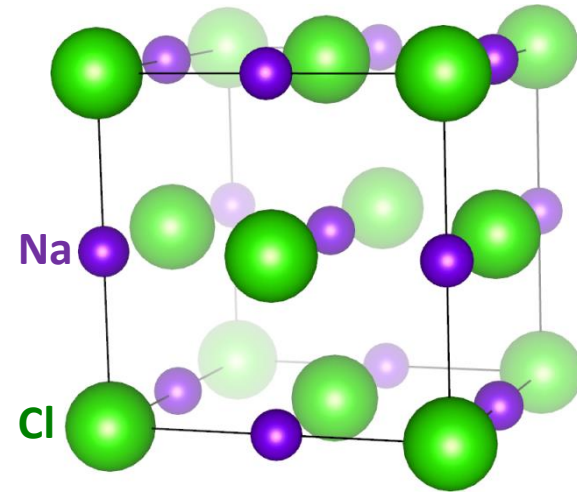

Figures: AJK

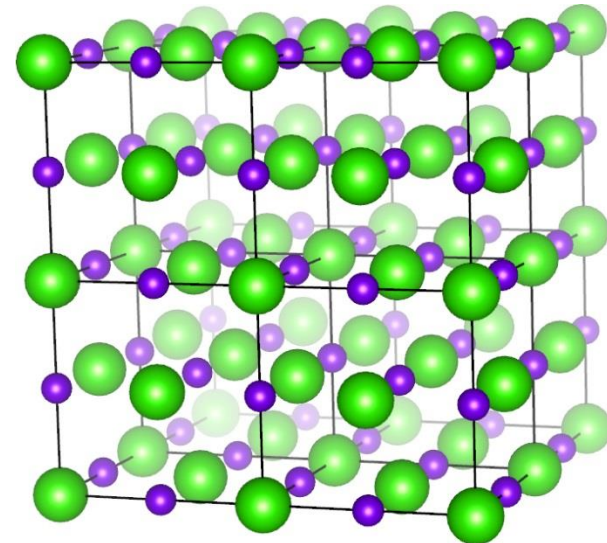

Extra slides

“Nice-to-know”-type material that is not needed for completing the exercises

More details on trigonal crystal system

Hexagonal crystal family

Hexagonal crystal system
(27 space groups)

Trigonal crystal system
(25 space groups)

Hexagonal Bravais lattice
(27 space groups)

Hexagonal Bravais lattice
(18 space groups)

Rhombohedral Bravais lattice
(7 space groups)

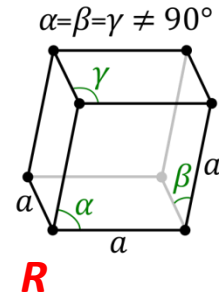
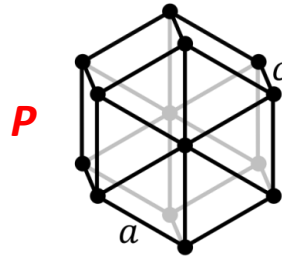
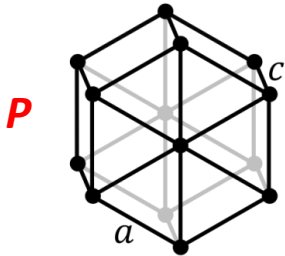

Can also be described with hexagonal unit cell (3 x larger)

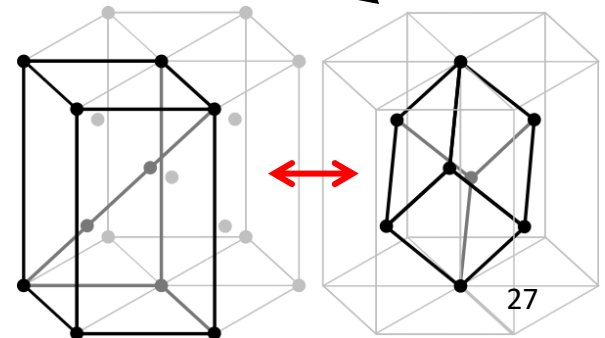

Figures: [Wikipedia](https://en.wikipedia.org/wiki/Hexagonal_crystal_system)

Table 1.1 The seven crystal systems

Crystal system	Unit cell shape ^b	Essential symmetry	Allowed lattices
Cubic	$a = b = c, \alpha = \beta = \gamma = 90^\circ$	Four threefold axes	P, F, I
Tetragonal	$a = b \neq c, \alpha = \beta = \gamma = 90^\circ$	One fourfold axis	P, I
Orthorhombic	$a \neq b \neq c, \alpha = \beta = \gamma = 90^\circ$	Three twofold axes or mirror planes	P, F, I, A (B or C)
Hexagonal	$a = b \neq c, \alpha = \beta = 90^\circ, \gamma = 120^\circ$	One sixfold axis	P
Trigonal (a)	$a = b \neq c, \alpha = \beta = 90^\circ, \gamma = 120^\circ$	One threefold axis	P
Trigonal (b)	$a = b = c, \alpha = \beta = \gamma \neq 90^\circ$	One threefold axis	R
Monoclinic ^a	$a \neq b \neq c, \alpha = \gamma = 90^\circ, \beta \neq 90^\circ$	One twofold axis or mirror plane	P, C
Triclinic	$a \neq b \neq c, \alpha \neq \beta \neq \gamma \neq 90^\circ$	None	P

Symmetry elements in crystals:

Inversion axis

- Denoted by \bar{n} . Rotation of $360^\circ / n$ followed by inversion.
- $\bar{1}$ = equal to inversion center
- $\bar{2}$ = equal to mirror plane (m)
- $\bar{3}, \bar{4}, \bar{6}$ are actual inversion axes
- For example, $\bar{3}$ inversion axis (equal to S_6 improper rotation):

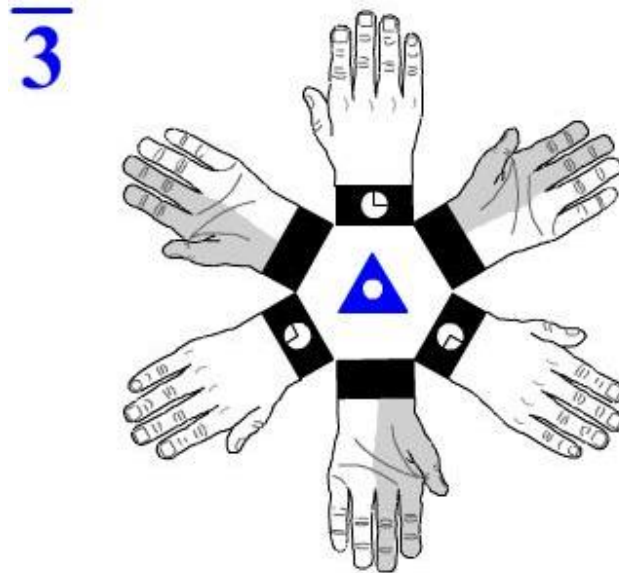

Figure: Margaret E. Kastner,
<http://www.crystallographiccourseware.com/>

Symmetry elements in crystals:

Glide plane

- Reflection followed by a translation
 - Simple glide planes are denoted as a , b , c (axis of the glide)
 - n glide: reflection followed by translation of $1/2$ along **two** cell edges
 - d glide (diamond glide): reflection followed by translation of $1/4$ along **two** cell edges

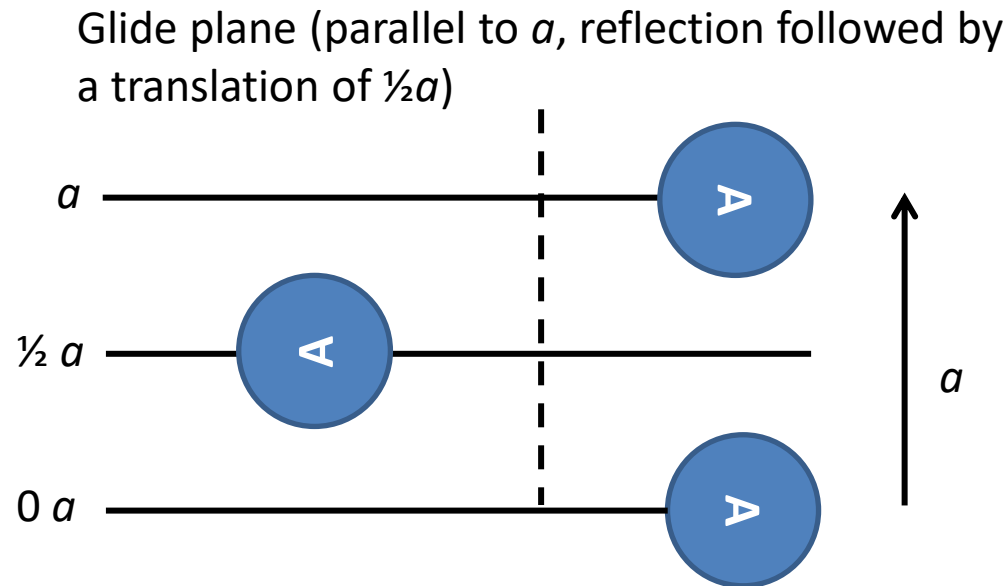
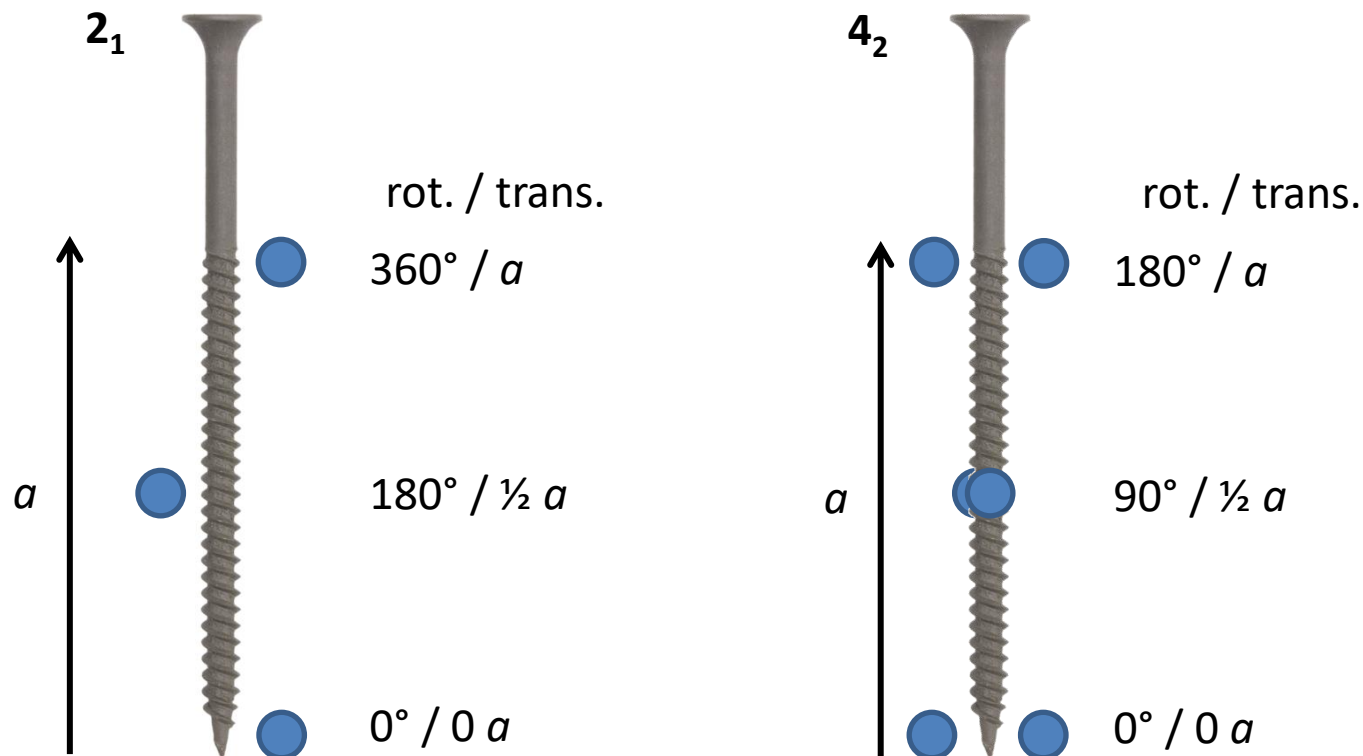

Figure: AJK

Symmetry elements in crystals: Screw axis

- Combination of rotation and translation, denoted as x_y :
 - Rotation of $360^\circ / x$; translation of y/x units along the screw axis
 - 2_1 screw axis: rotation of $360^\circ / 2 = 180^\circ$; translation of $1/2$ units
 - 4_2 screw axis: rotation of $360^\circ / 4 = 90^\circ$; translation of $2/4 = 1/2$ units



Quasicrystals (1)

- Quasicrystals exhibit long-range order, but do not have translational periodicity
- Quasicrystals can show "forbidden" rotational symmetries of 5, 8, 10, 12, etc.
- Discovered by Daniel Schechtman in 1982, Nobel prize 2011 ([link](#))

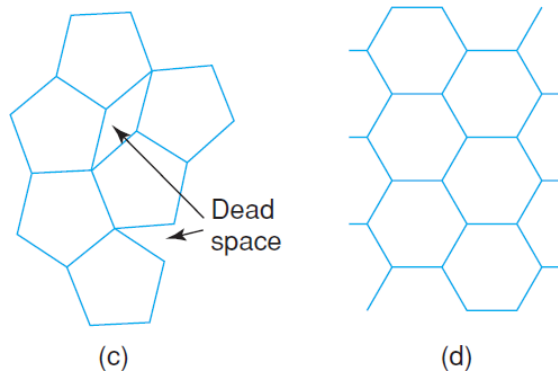

Figure 1.4. (c) the impossibility of forming a complete layer of pentagons; (d) a complete layer of hexagons

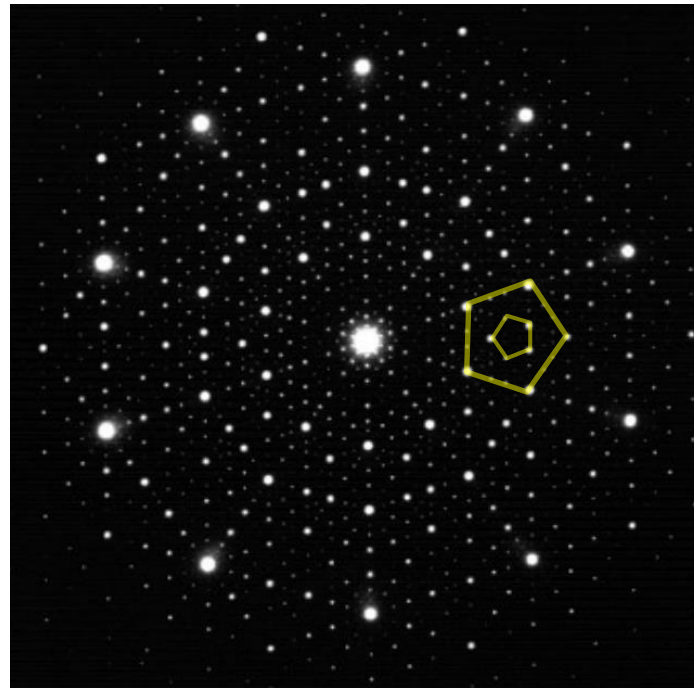

Figure: [Nobel committee](#)

Electron diffraction pattern from an icosahedral quasicrystal

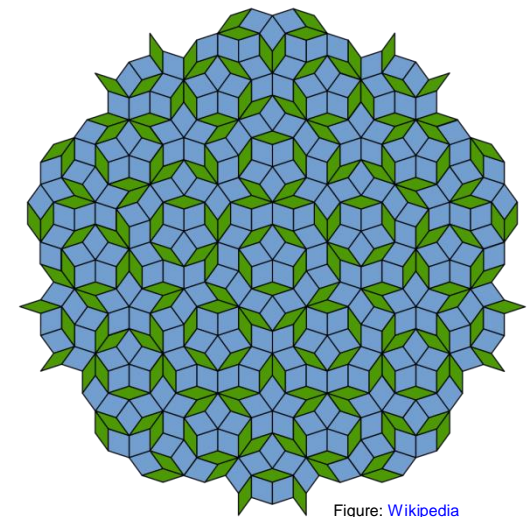
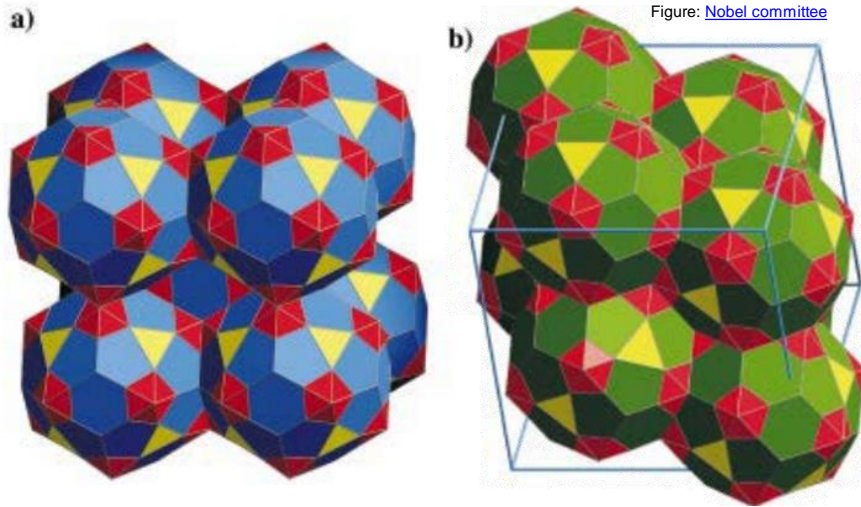

Figure: [Wikipedia](#)

Penrose tiling (no translational periodicity)

Quasicrystals (2)

- Icosahedral symmetry is allowed together with translational symmetry in 6-dimensional space
- Refinement of quasicrystal models involves the refinement of the position and shape of the atomic surfaces in 6-dimensional space for icosahedral quasicrystals



Polyhedral arrangements in icosahedral quasicrystal *approximants* in the system Ca-Cd ([Angew. Chem. 2001, 40, 4037-4039](#))

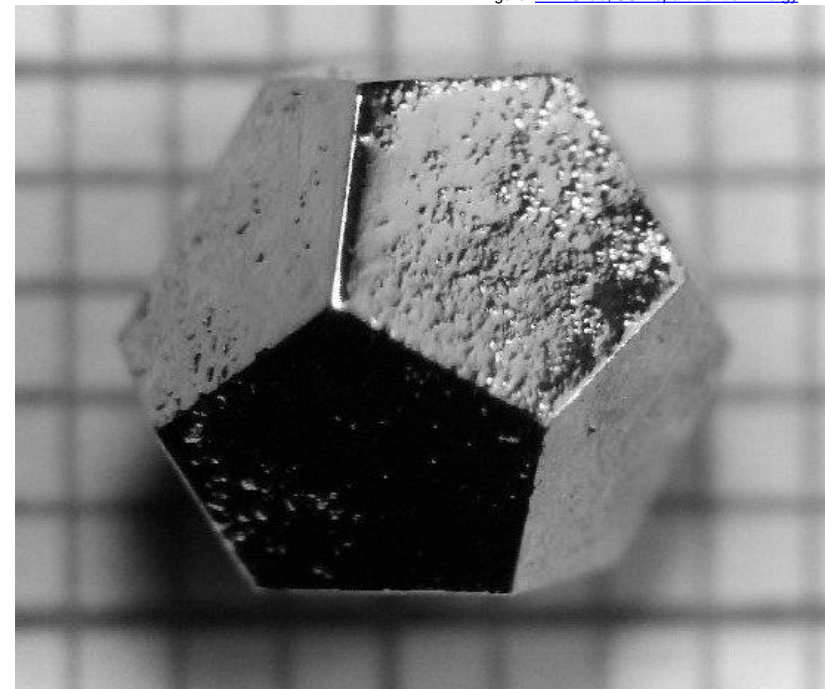

Ho-Mg-Zn dodecahedral quasicrystal
([Phys. Rev. B 1999, 59, 308–321](#))

mm

Perfect crystals do not exist

- Crystal structures from X-ray diffraction are "average" structures
- Real crystals possess defects (**lecture 13**)
- Point defects, line defects, grain boundaries, stacking faults, bulk defects, etc.
- Some defects can be characterized using techniques other than XRD (**lecture 8**)

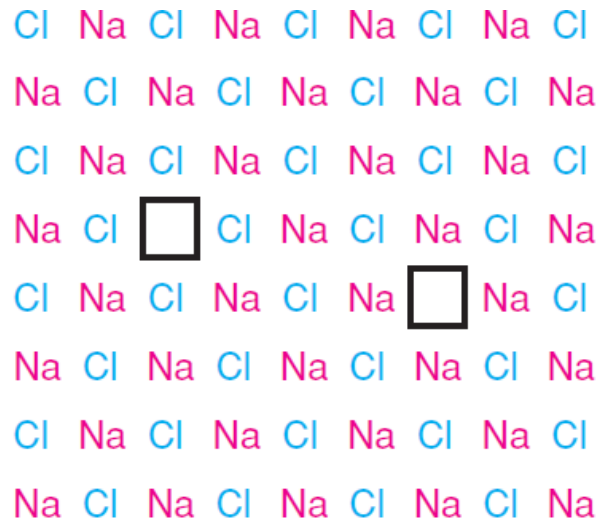

Figure 2.2 *2D representation of a Schottky defect with cation and anion vacancies.*