

SYSTEMIC
INNOVATION
& INTEGRATED
PLATFORM
STRATEGIES

Peter McGrory, Aalto University
Helsinki, FINLAND

INTEGRATED PLATFORMS ...

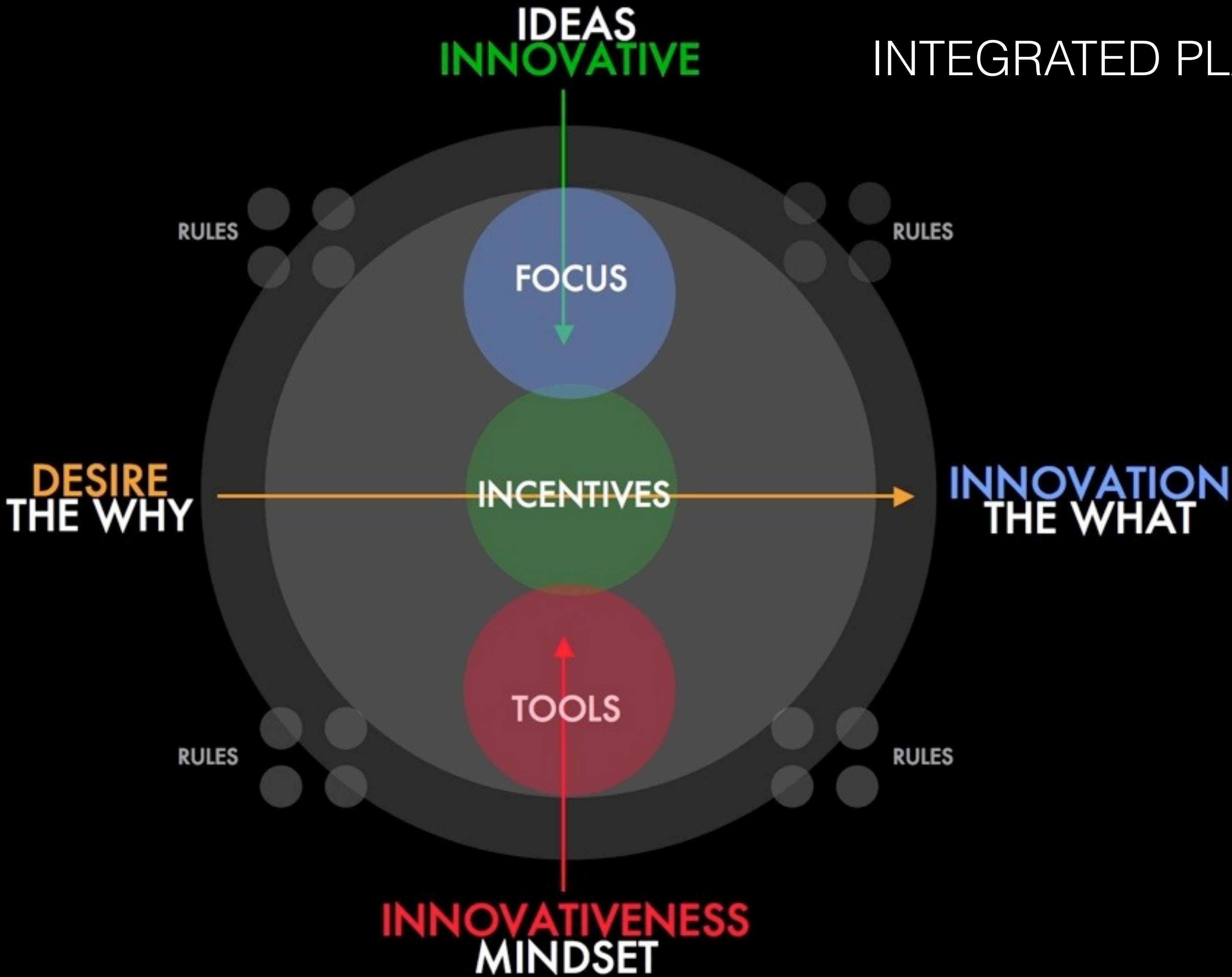

STRATEGY RULES

FIVE TIMELESS LESSONS FROM
BILL GATES, ANDY GROVE,
AND STEVE JOBS



DAVID B. YOFFIE and
MICHAEL A. CUSUMANO

Look Forward, Reason Back Chapter I	Make Big Bets, Without Betting the Company Chapter II	Build Platforms & Ecosystems, not just products & services Chapter III	Exploit Leverage & Power Play Judo and Sumo Chapter IV	Shape the Organization around your Personal Anchor Chapter V
Create or Curate a Vision; set priorities	Bet Big to Change the Game	Think Platforms, not just products or services	Stay under the radar	Know thyself— warts and all
Anticipate Customer Needs; match to capabilities	Don't Bet the Company; affordable loss	Think Ecosystems, not just platforms	Keep your enemies close	Pay extraordinary attention to detail—selectively
Anticipate Competitors' Moves; build entry barriers	Cannibalise your own business	Create some of your own compliments	Embrace and extend competitors' strengths	Never loose sight of the big picture
Anticipate Strategic Inflection Points; commit to change	Cut you losses	Evolve and Invent New Platforms to avoid obsolescence	Don't be afraid to throw your weight around	Give power to people with "the knowledge"

Build Platforms & Ecosystems,
not just products & services
Chapter III

Think Platforms,
not just products or services

Think Ecosystems,
not just platforms

Create some of your
own compliments

Evolve and Invent
New Platforms to avoid
obsolescence

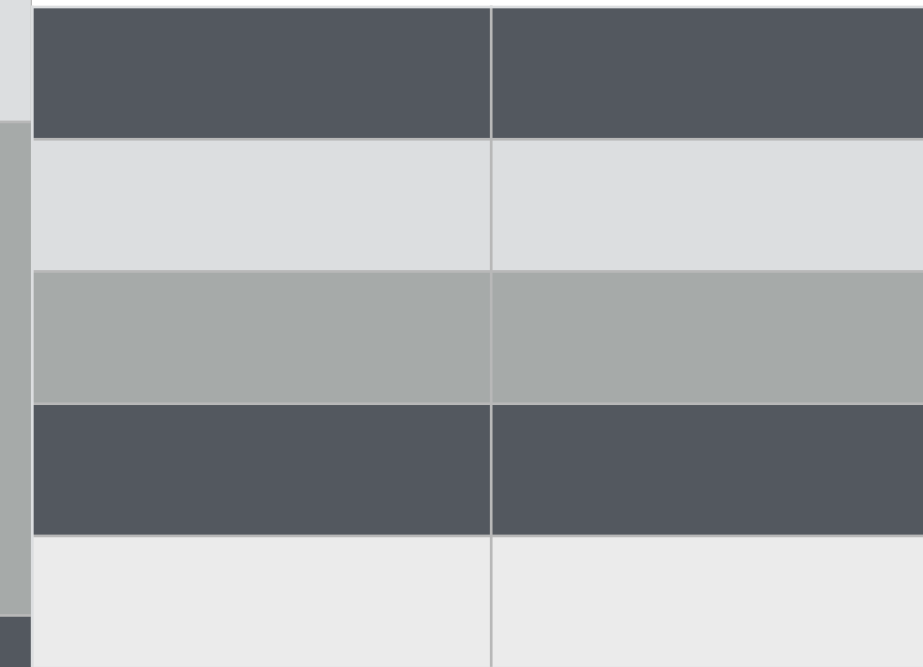
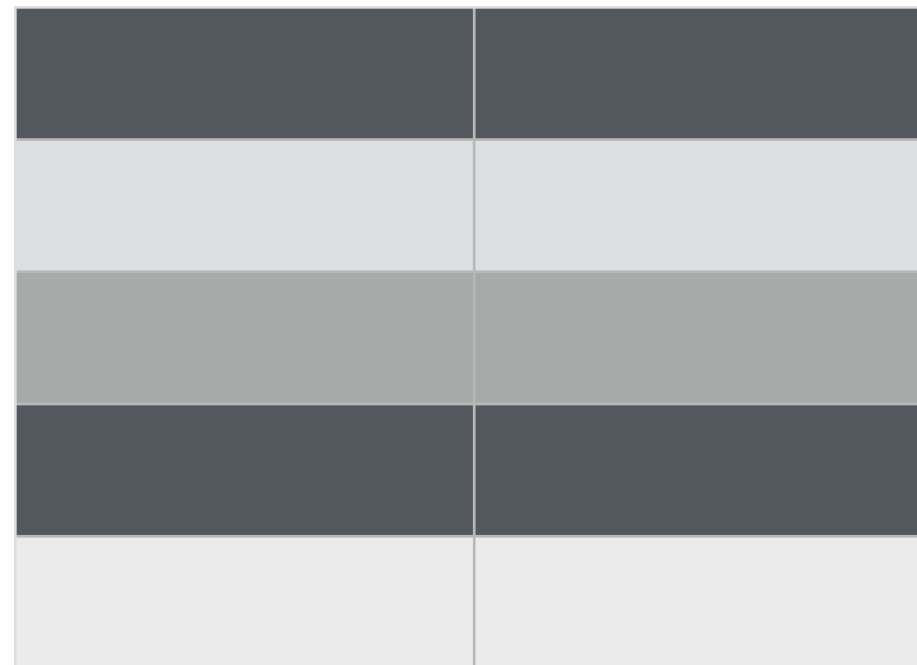

platform

the basis, foundation or core on which to
create and sustain value.

service



service

product platforms

dominant emphasis



software

peripheral

accessory

product

product



hardware

lo

augmentation / integration

hi

media content platforms

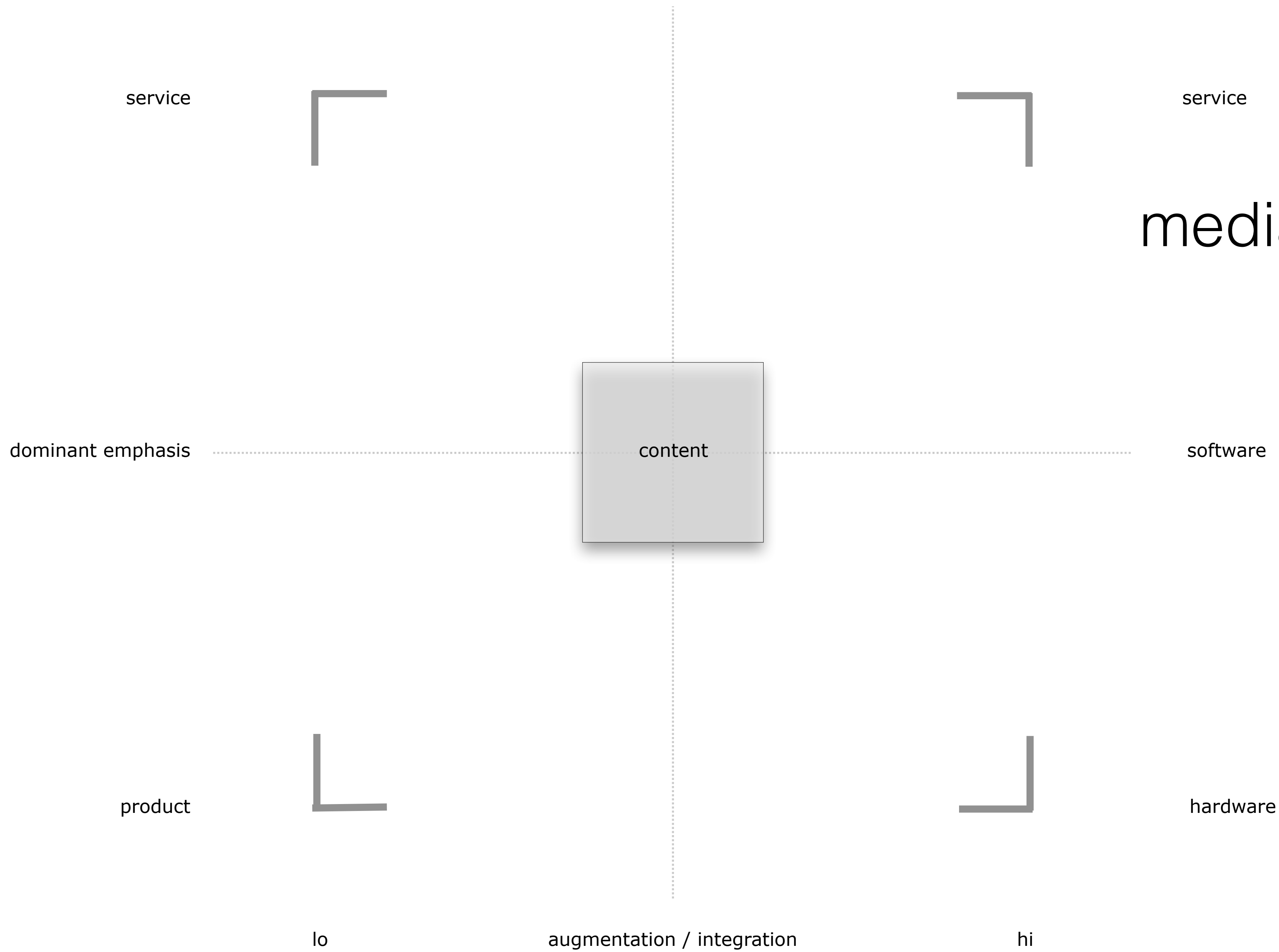



Mac OS X and iOS Platforms



Mac OS X

iOS

service



service

service platforms

dominant emphasis



software

product



hardware



lo

augmentation / integration

hi

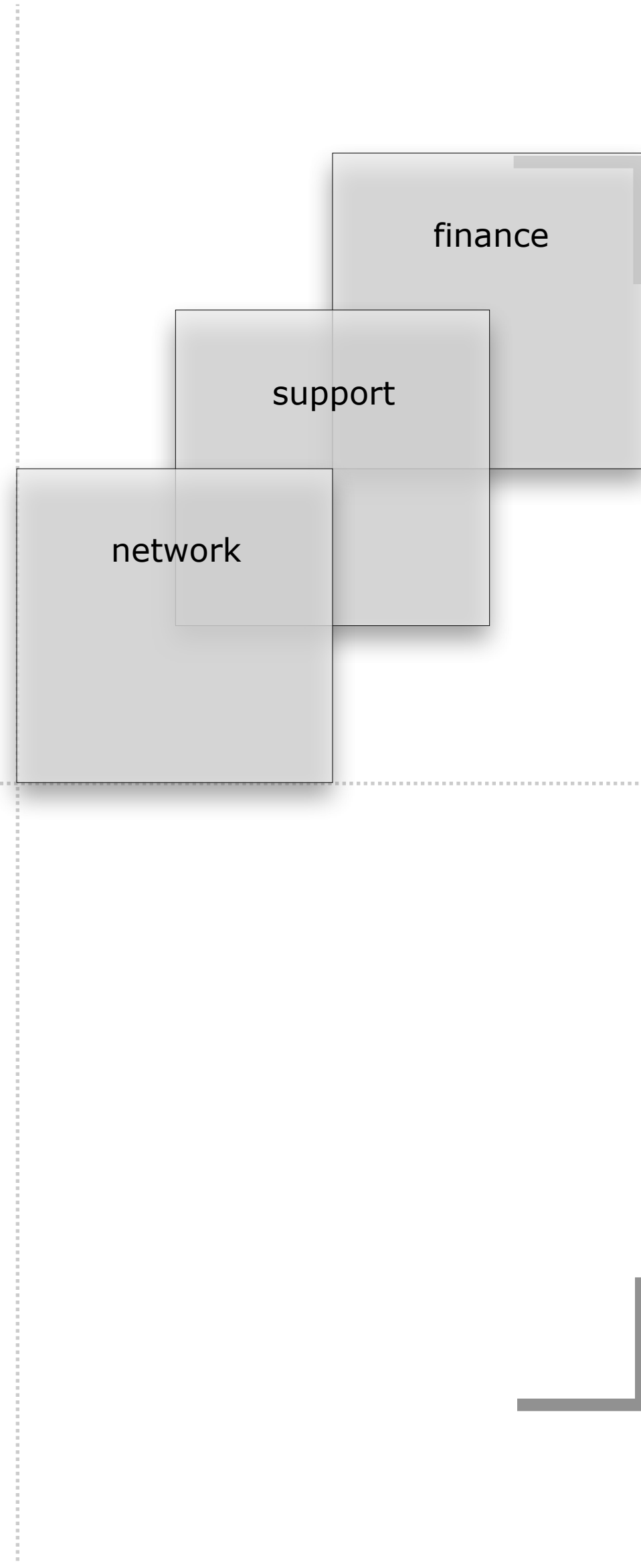

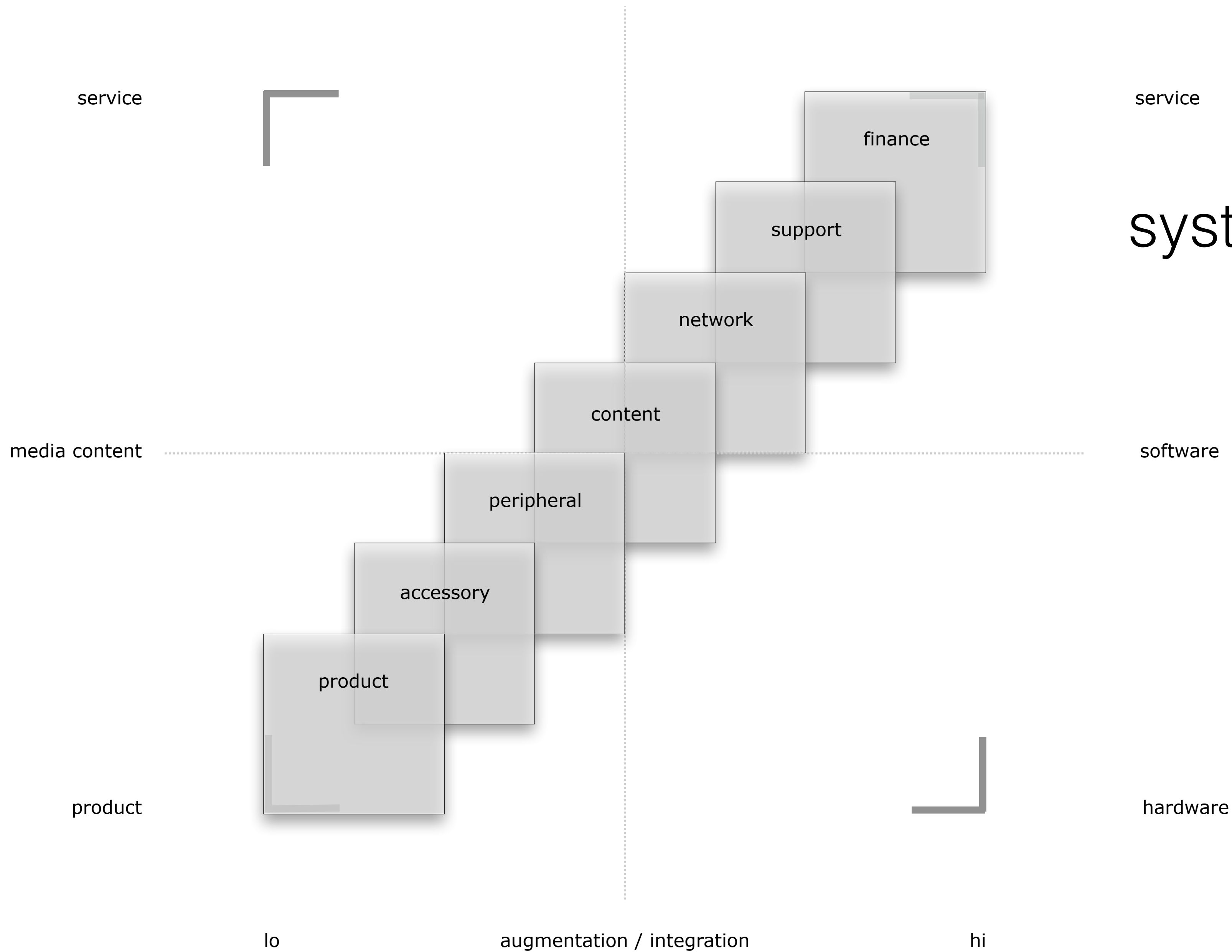

systemically integrated
platforms

technology platforms

enable companies to efficiently utilise and re-utilise a set of product and/or process technologies.

technology platforms

are essentially about product development,
manufacturing and logistic efficiencies
via a set of complimentary commonalities
(inside-out approach).



design platforms



technology platforms



nike air max
1987



flyknit air max evolution
2014



2008

FLYWIRE

design platforms

design platforms

enable companies to effectively utilise and re-utilise a set of distinguishing features, characteristics, attributes or elements i.e., perceptual triggers and locks via conscious consistencies and progressive continuities.

design platforms

assure the affective interface i.e., the transfer or signification of meaning, value and relation between products, product segments, successive product generations, and their users (outside-in approach).

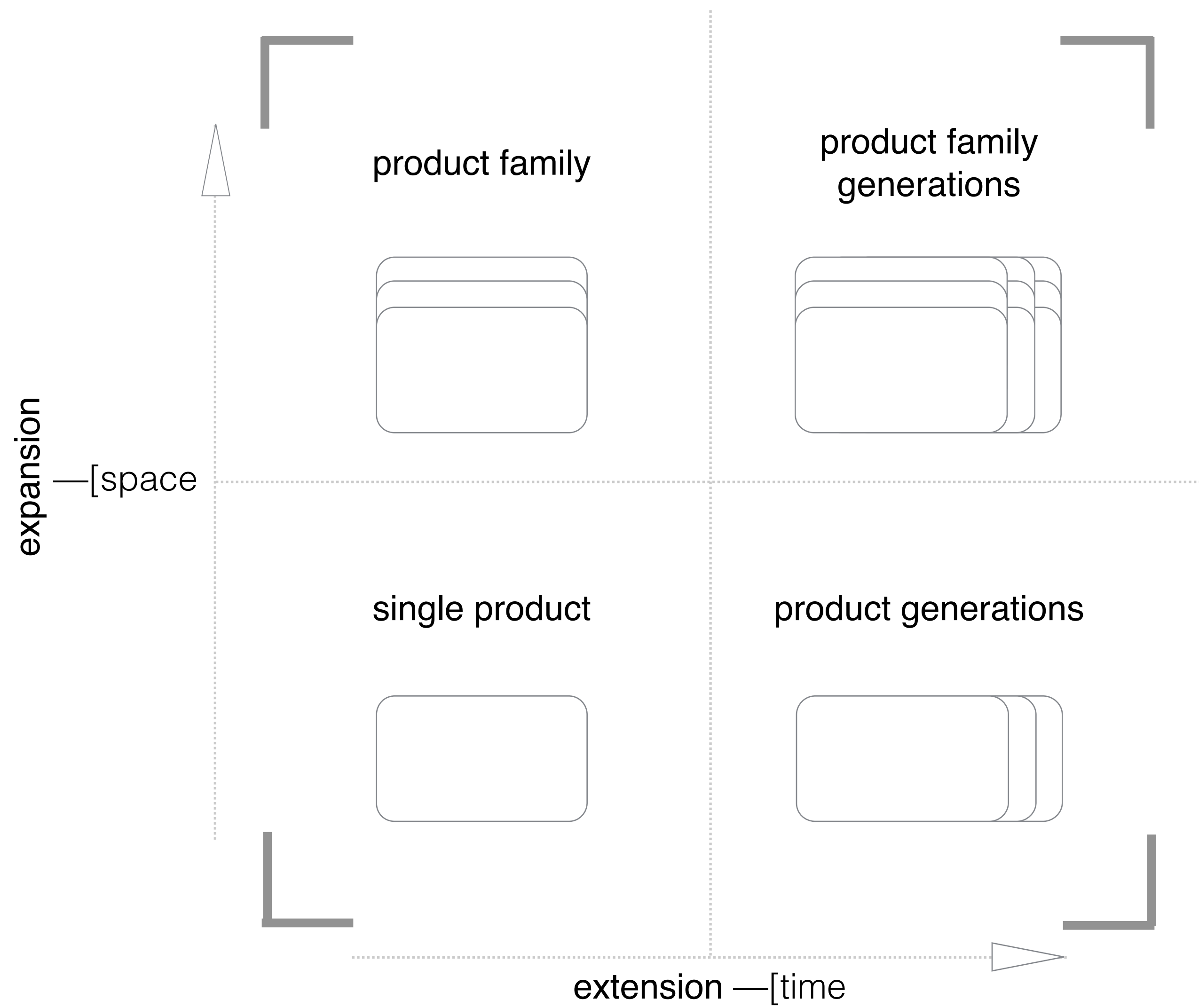

platform
extension / expansion

radical innovation

radical innovation

creates drastic, disruption and transformational changes to the competitive environment for a product or a service, or create entirely new businesses and eco-systems
i.e., 'game changing'.

radical innovation

occur infrequently but generate transformative and expansive growth when successful.

radical innovation

necessitate a longer-term view on investment.

radical innovation

remember, 'radical' is always 'relative' ...

radical innovation

... involves playing 'with-the-rules' vs.,
playing 'by-the-rules'

innovation scope

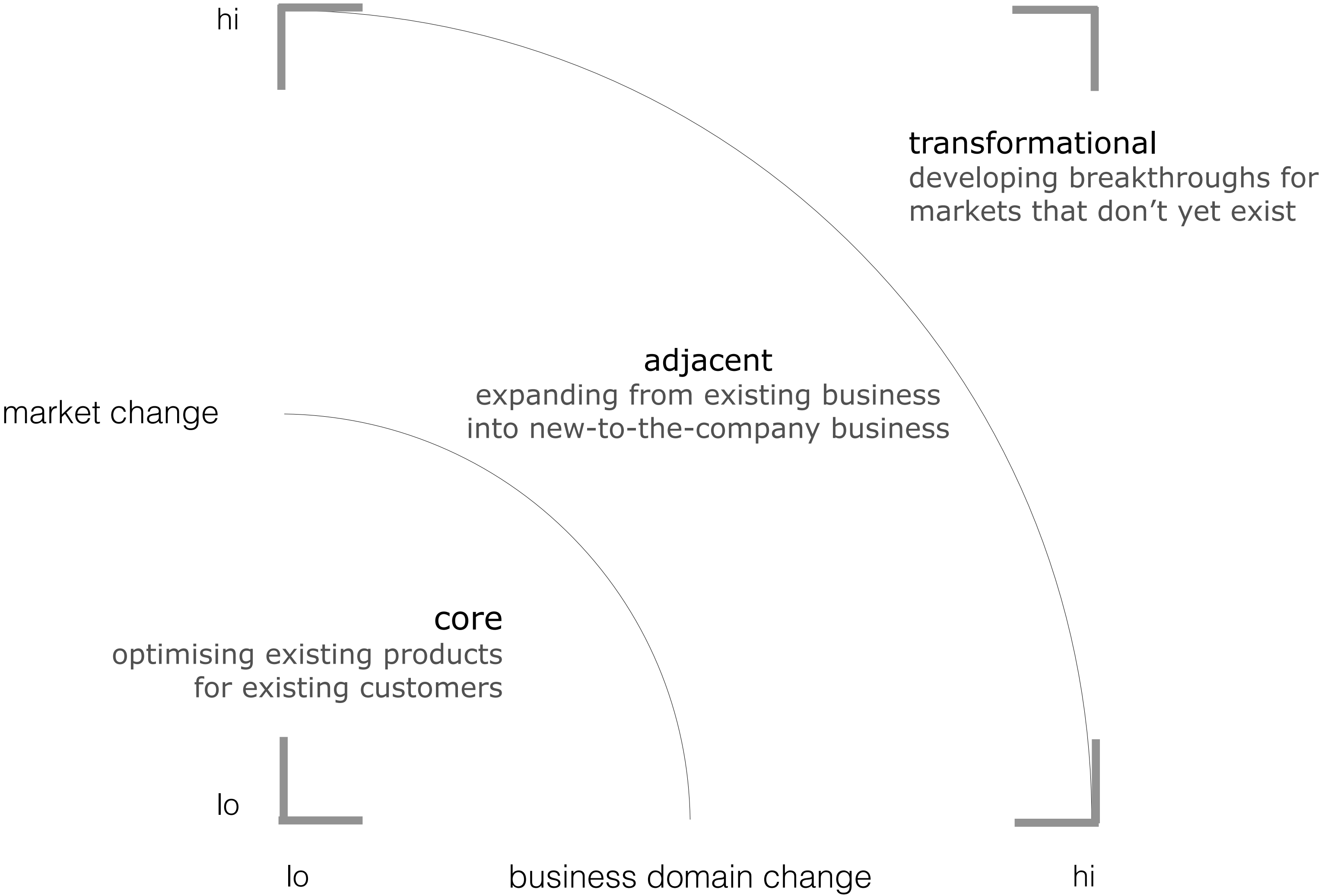

radical innovation necessitates a longer-term view on investment

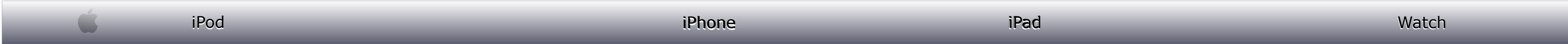

iPod
2001
Press Releases

iPhone
2007
Pods Sold

iPad
2010

Watch
2015

innovation scope

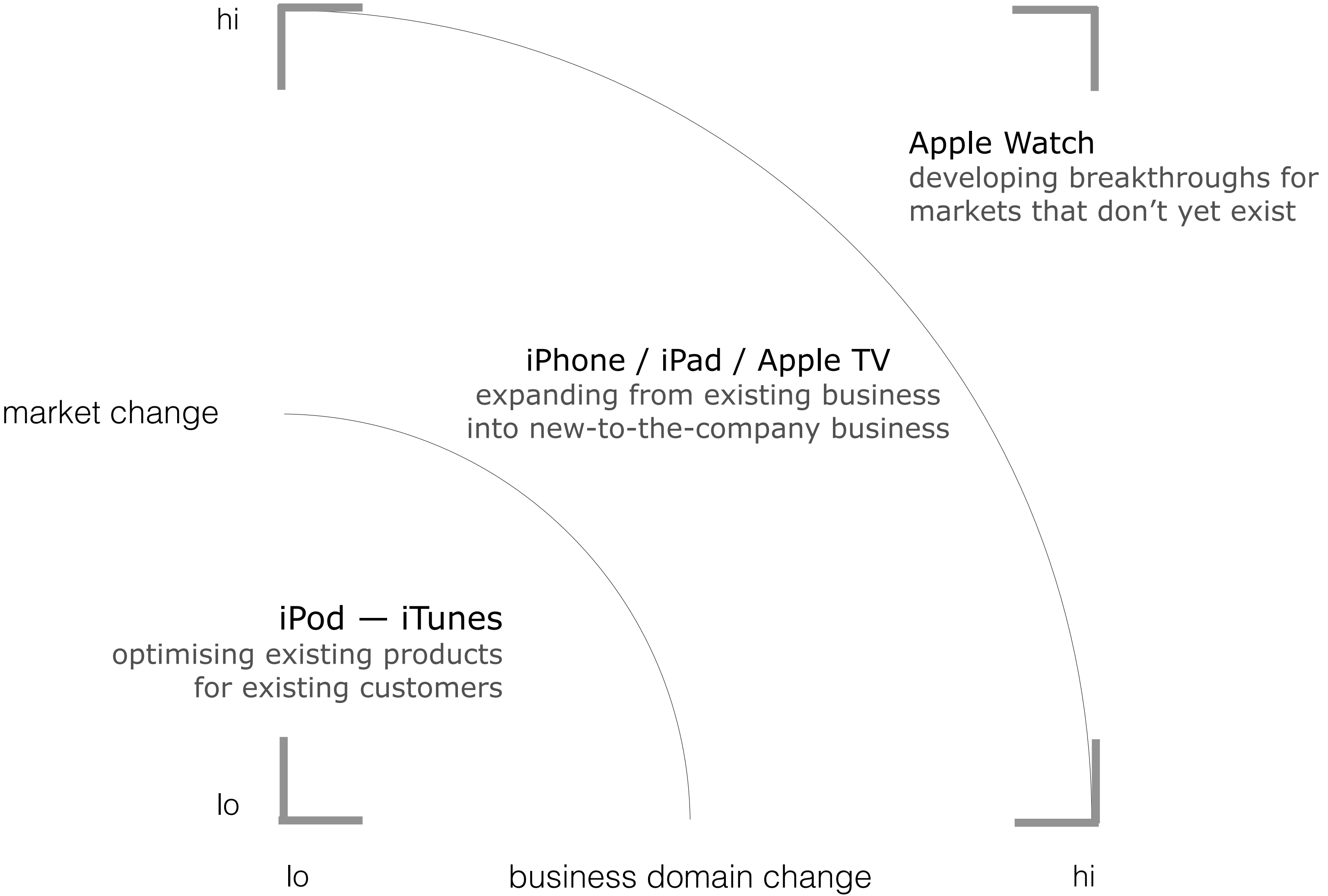

Apple WATCH

You. At a glance.

[Learn more >](#) [Watch the keynote](#) 





blade-less fan



purifier



hairdryer



humidifier



hot+cold

air-multiplier

systemically integrated (i.e., holistic and synergistic) platforms ...

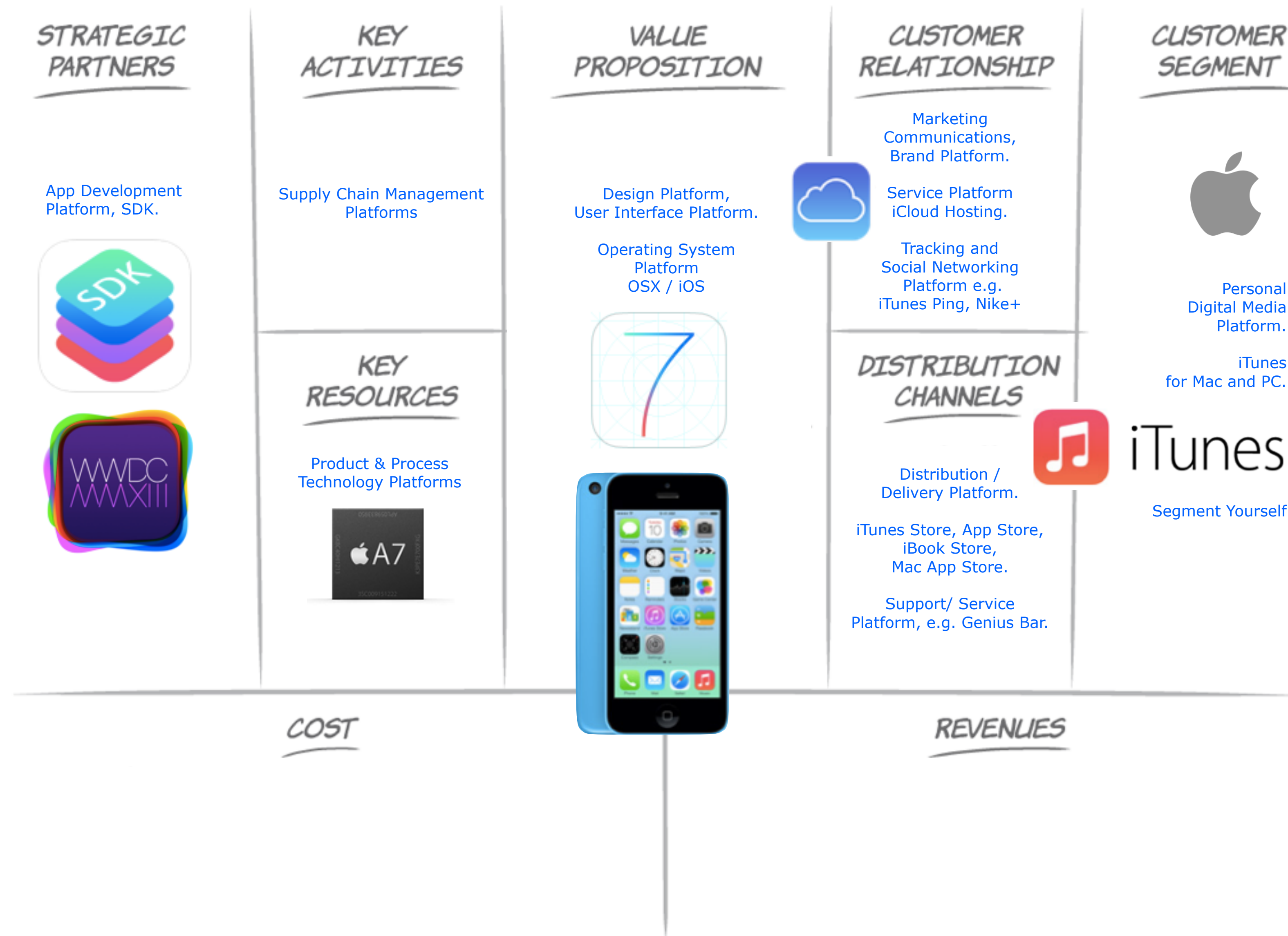

eco-system partners ...

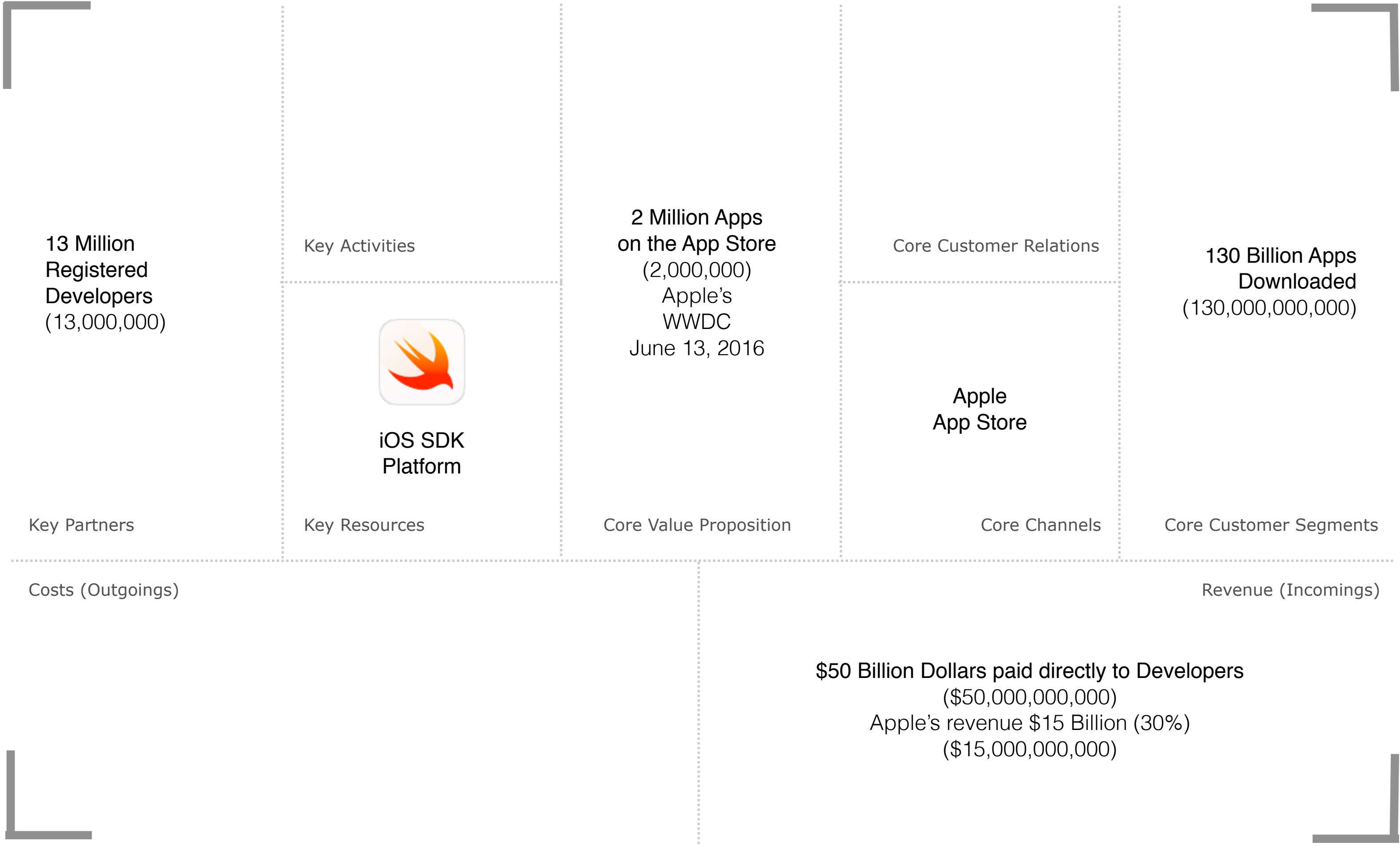

Service Platform — iCloud Hosting, Push Notification and Push Synchronization Platform

Development Platform — Apple SDK

Distribution / Delivery Platform — iTunes Store, App Store (iAd), iBook Store, The Mac App Store
(Discover and Download Apps)

Tracking and Social Networking Platform — Ping, Nike+iPod (incorp., Push Notification)

Application Led Platform — Media Content e.g. Music, Video, Games, Apps

Personal Digital Media Platform for Mac or PC — iTunes

Operating System Platform — MAC OS X / iOS (Mobile Operating System)

Support (Service) Platform — Genius Bar /

Design Platform — User Interface UI Platform / Technology (Product / Process) Platform
/ Marketing Communications Platform ...

... **Plan** e.g. AppleCare Protection Plan / **Program** e.g. Apple Recycling Program (Package)

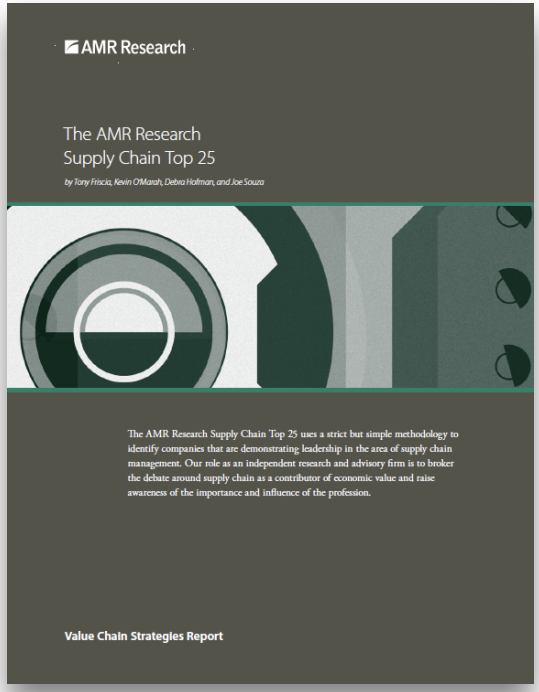
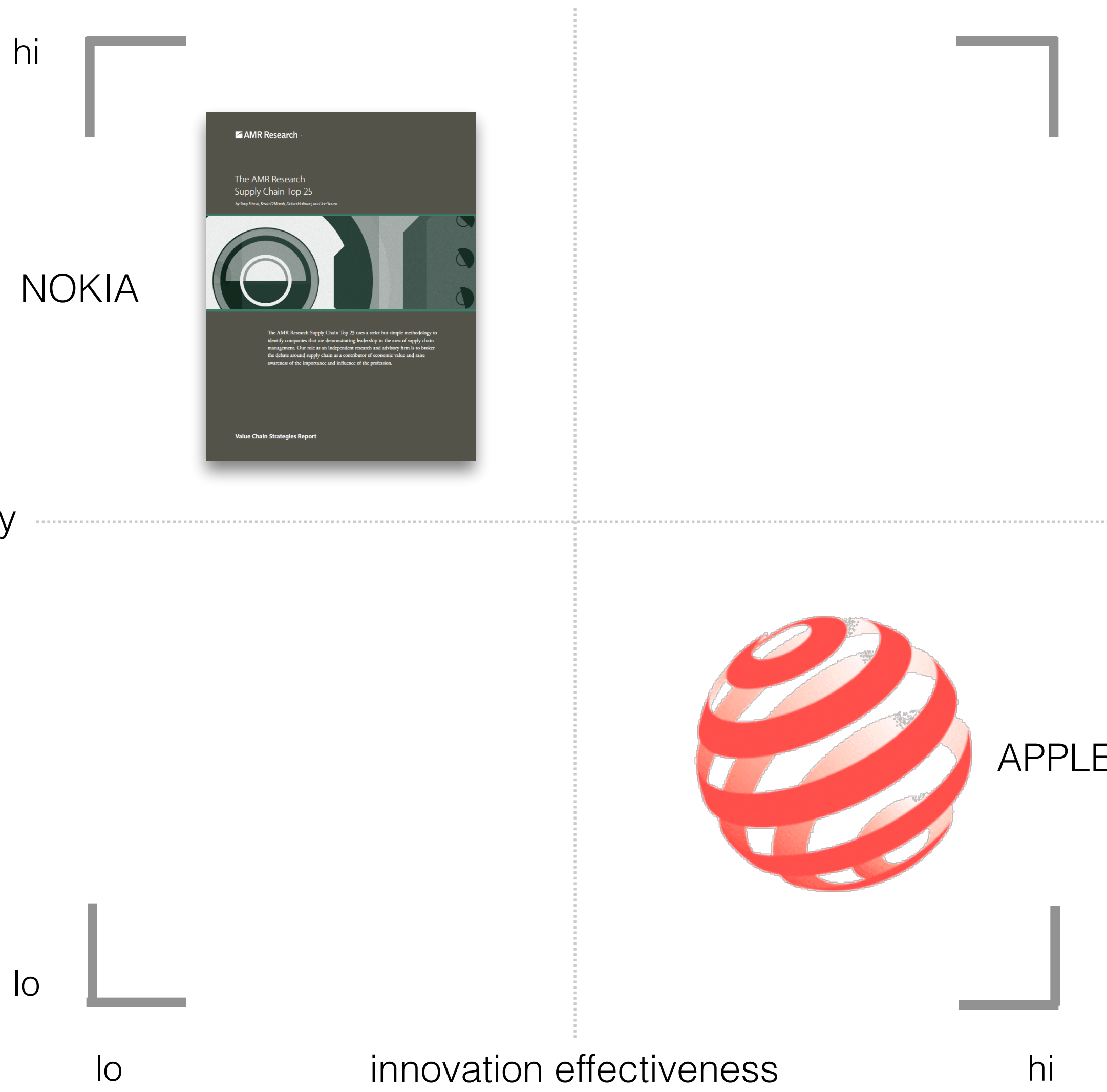

APPLE

innovation emphasis

hi



APPLE



operational efficiency

lo



lo

innovation effectiveness

hi

integrated
innovation efforts
i.e., synergy

 AMR Research

The AMR Research Supply Chain Top 25

by Tony Friscia, Kevin O'Marah, Debra Hofman, and Joe Souza

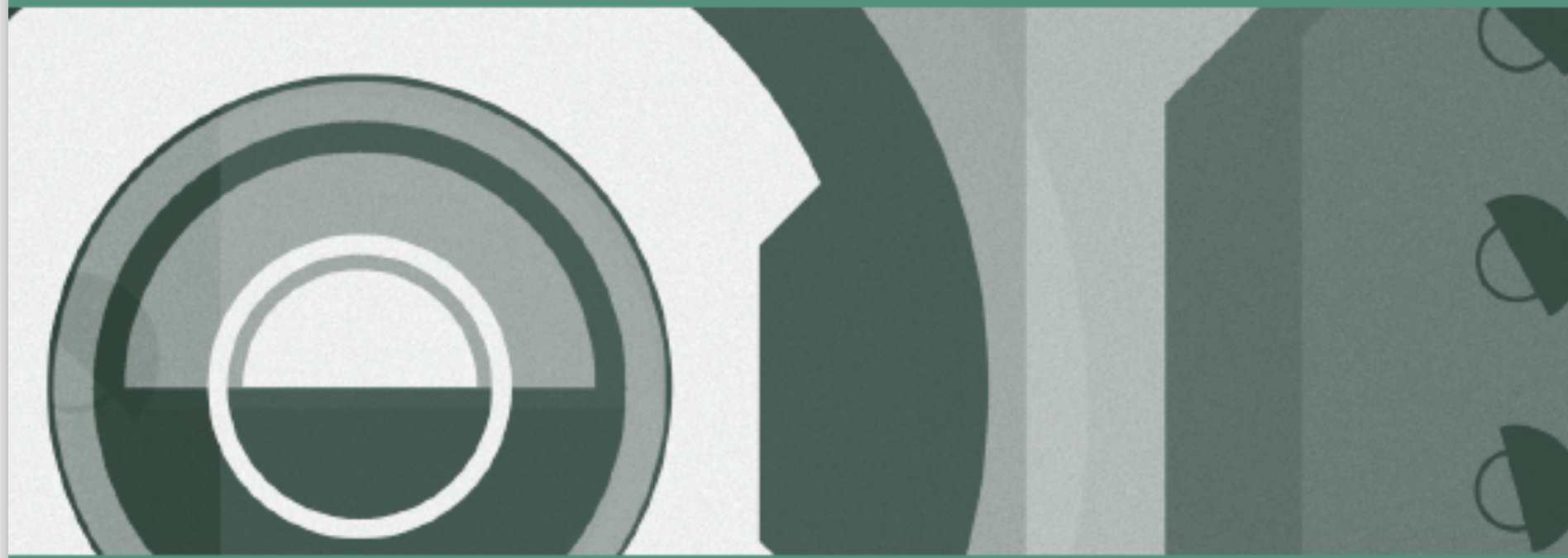

The AMR Research Supply Chain Top 25 uses a strict but simple methodology to identify companies that are demonstrating leadership in the area of supply chain management. Our role as an independent research and advisory firm is to broker the debate around supply chain as a contributor of economic value and raise awareness of the importance and influence of the profession.

Value Chain Strategies Report

THE MOST INNOVATIVE COMPANIES 2015

FOUR FACTORS THAT DIFFERENTIATE
LEADERS



BCG

THE BOSTON CONSULTING GROUP

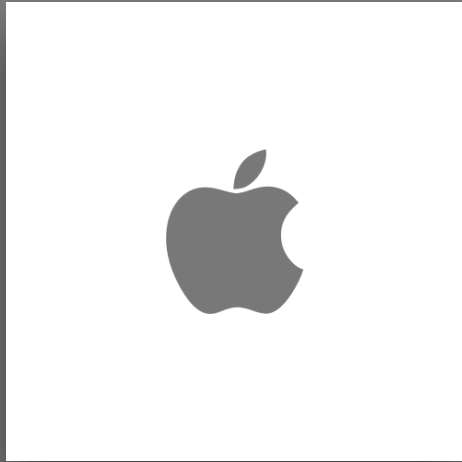

“enriching the lives of our customers”



“to organize the world’s information
and make it universally accessible and
useful”

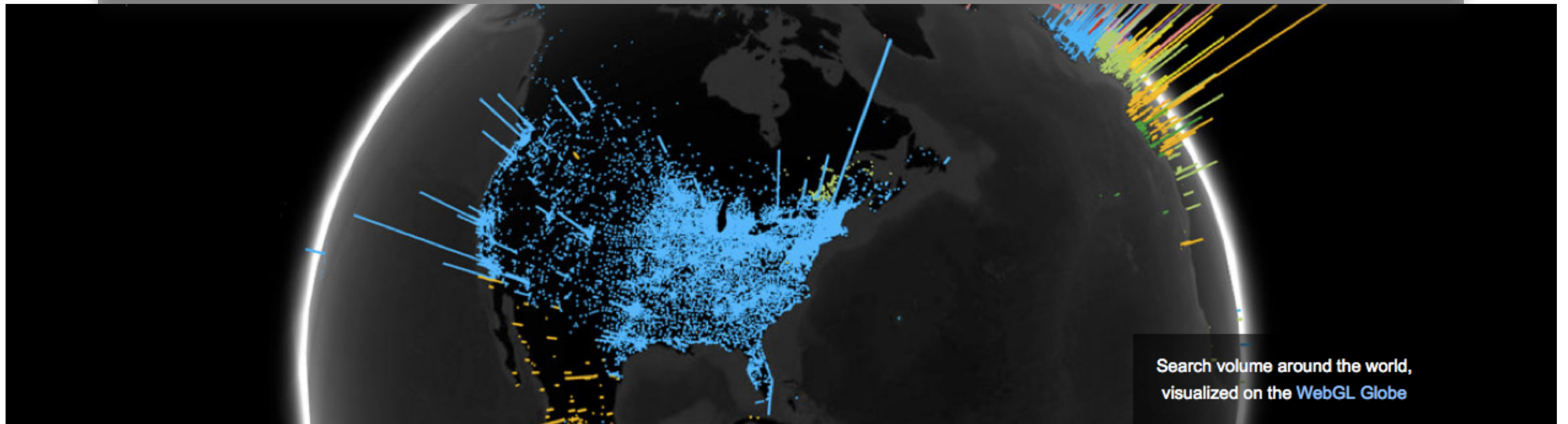



SIMPLE RULES

HOW TO THRIVE
IN A COMPLEX WORLD

DONALD SULL | KATHLEEN M. EISENHARDT

Google



Google Search

I'm Feeling Lucky

method.



“people against dirty”



clean



safe



green



design



fragrance



Search for someone by name:

“connecting the world’s professionals to enable them to be more productive and successful”

**The world's largest professional network:
400 million strong.**

Connect. Find. Be found.



Build your professional identity online and stay in touch with colleagues and classmates.

Power your career.

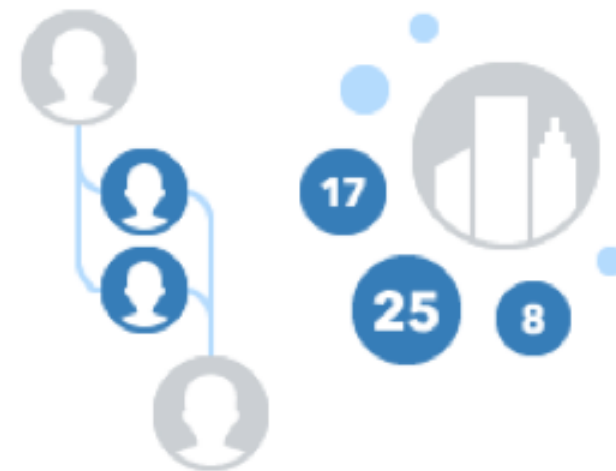

Discover professional opportunities, business deals, and new ventures.

Learn and share.



Get the latest news, inspiration, and insights you need to be great at what you do.

It's free.

Join now



“accelerating the world’s transition towards electric mobility” — clean tech

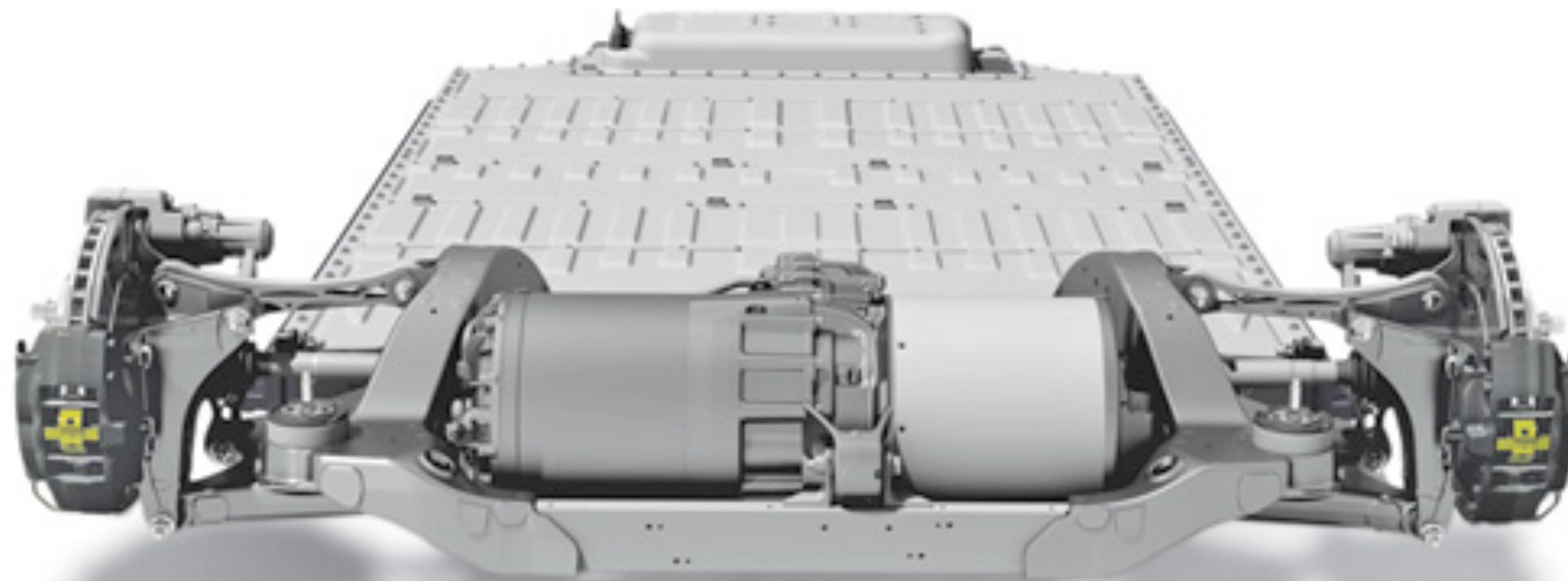



Facebookログイン

メールまたは電話番号:

パスワード:

ログインしたままにする

ログイン またはFacebookに登録

[パスワードを忘れた場合はこちら](#)

“making the world more open and
connected”



4 MINUTE READ

Facebook Agrees: The Key To Its Future Success Is Design

In the past year, Facebook's design staff has gone from 20 to 90. We talk with its brightest stars about the sea change that this represents for Silicon Valley.



ADVERTISEMENT

twitter

Definition: A Tweet is a 140-character message posted via Twitter.



“instantly connecting people everywhere
to what’s most important to them”





Where do you want to go?

Check in 

Check out 

1 Guest 

 **SEARCH**

“unlocking unique spaces worldwide”



Airbnb

founders



Today, we are on the cusp of a Fourth Industrial Revolution. Developments in genetics, artificial intelligence, robotics, nanotechnology, 3D printing and biotechnology, to name just a few, are all building on and amplifying one another. This will lay the foundation for a revolution more comprehensive and all-encompassing than anything we have ever seen. Smart systems—homes, factories, farms, grids or cities—will help tackle problems ranging from supply chain management to climate change. The rise of the sharing economy will allow people to monetize everything from their empty house to their car.— UBER's Market Valuation \$60+billion

AIRBNB's Market Valuation \$25+billion

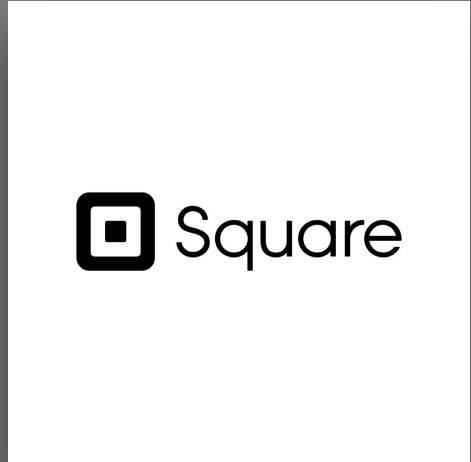

"simplifying commerce for everyone"

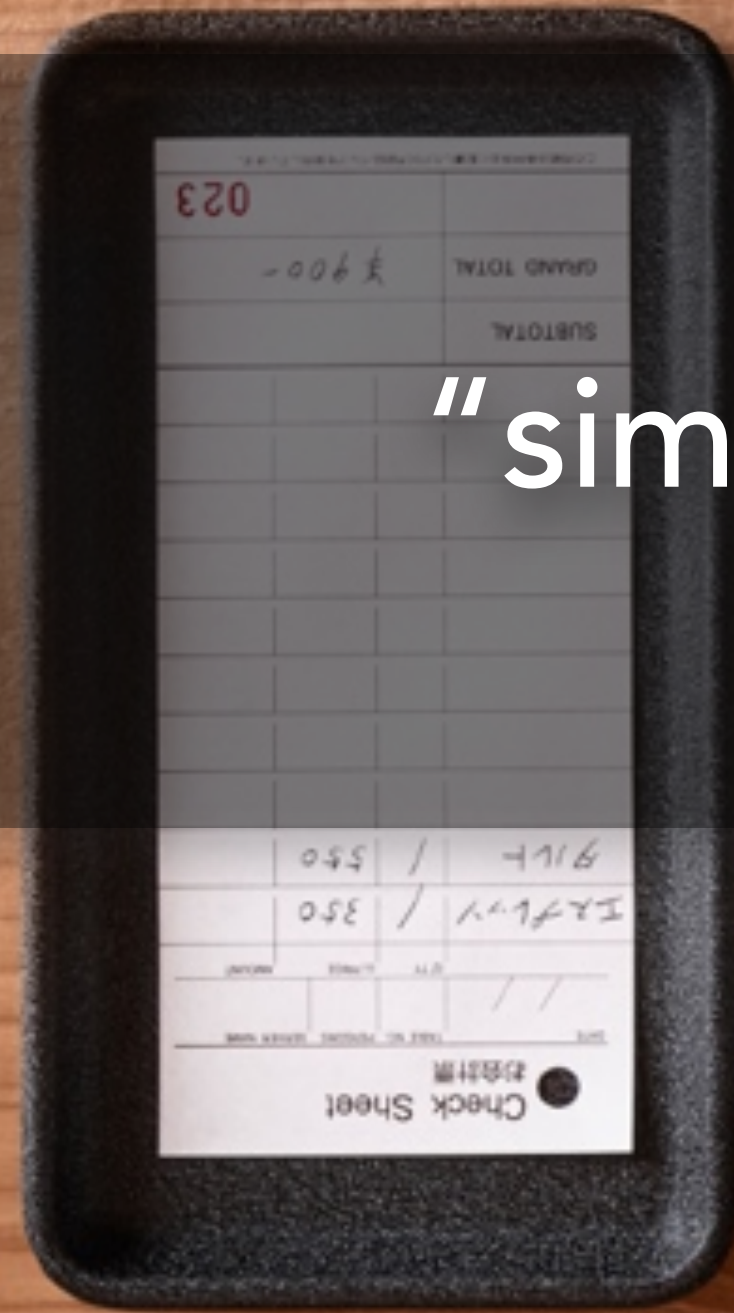

nest



Meet the Nest Thermostat.
Saving energy is a beautiful thing.

[▶ Watch the video](#)



“welcome conscious home”



sense-of-clarity

clear, concise and succinct sense-of-purpose

entrepreneurism

'silicon valley is not a place, it's a state-of-mind'

sense-of-challenge

tackle big, bold, audacious problems

create

platforms, not just products or services

because platforms are the basis, foundation or core on which to create and sustain value and competitive advantage

create

design platforms, not only technology platforms

design from the outside-in 'effectiveness', not only engineer from the inside-out 'efficiencies'

create

eco-systems, not just platforms

create

eco-systems which are open and shared, yet closed and proprietary

create

more value than you alone capture

ref.: 'double-sided markets'

create

value beyond a single device

ref.: 'network effects' via., the 'internet of things'

peter.mcgrory@aalto.fi