



Aalto University
School of Electrical
Engineering

ELEC-E8126: Robotic Manipulation Learning

Ville Kyrki

23.3.2020

Learning goals

- Understand application areas of learning in robotics.
- Understand challenges of learning in robotics.

Applications of learning in robotics

- What can you think of?

Applications of learning in robotics

- Learn how world works
 - Robot and/or environment dynamics
- Learn what to do (and how)
 - Learn a control policy, skill, task
- Learn to understand environment / situation
 - Learn to perceive
- *Learn how to interact, ...*

Types of machine learning

- Supervised learning
 - Learn input-output mappings from examples
 - Give some examples!
- Reinforcement learning
 - Learn by acting and observing rewards
 - Give some examples!
- Unsupervised learning
 - Cluster inputs without outputs
 - Give some examples!

Scope of learning

Scope can vary from e.g. adapting physical parameters to learning “everything”.

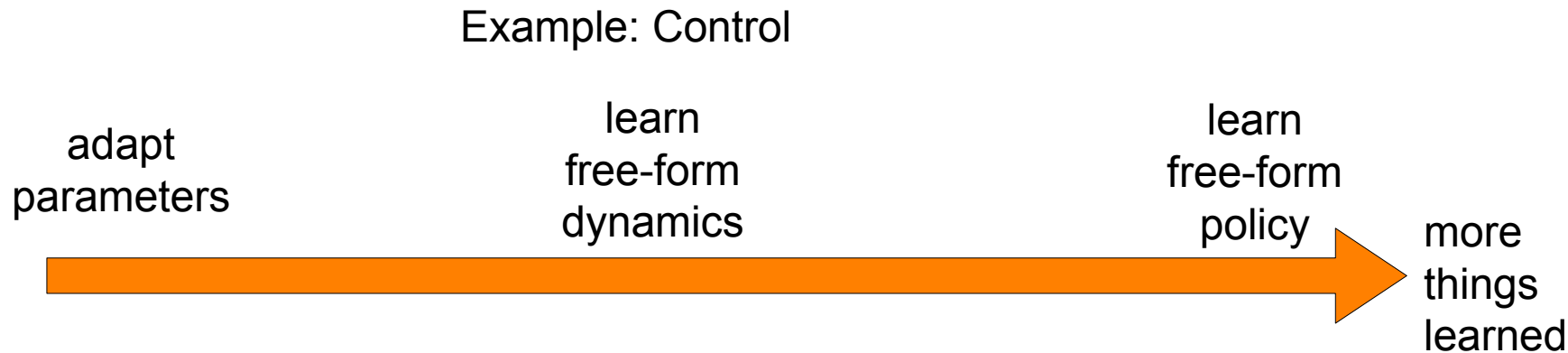

Scope of learning

Scope can vary from e.g. adapting physical parameters to learning “everything”.

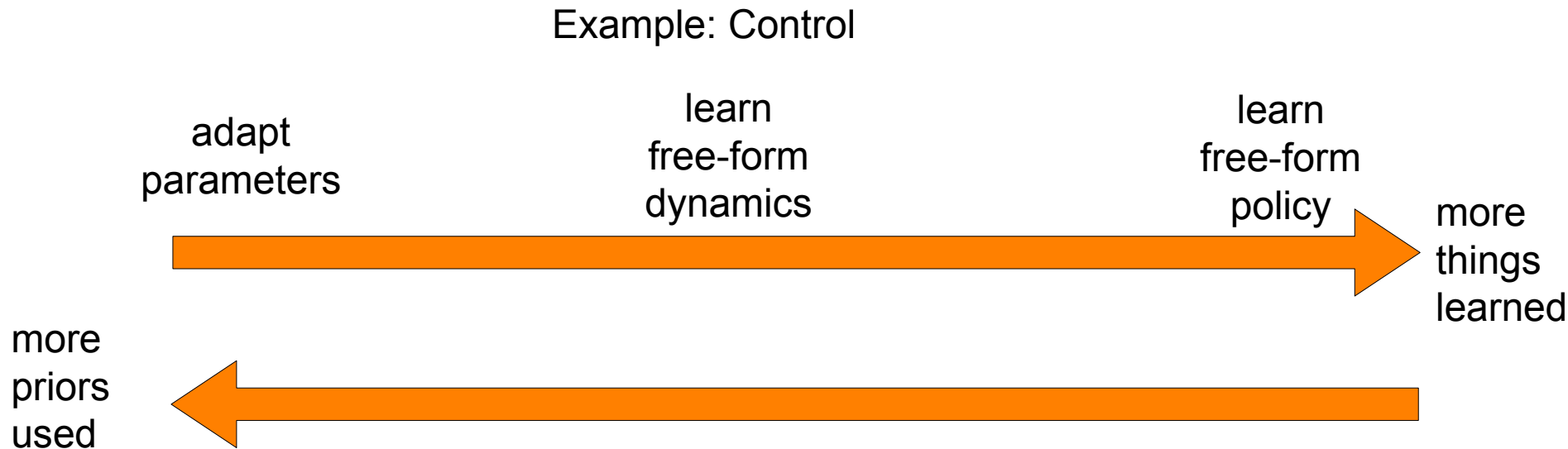

Effect of priors

- When are priors useful?
- What's their meaning in learning?
- When are they harmful?

Challenges of learning in robotics

- Data cost is usually high.
 - Physical experiments time consuming and potentially unsafe.
- Desired operation not always easy to define.
 - For reinforcement learning.
- Safety and performance of learning difficult to guarantee.
 - Depends on data and method used.
 - Possibly weak transparency – internal operation often difficult to characterize.

Some solutions

- Data cost
 - Simulation may provide training data.
 - Reality gap between simulation and real world a challenge.
- Safety and transparency
 - Learned models may be hard to interpret.
 - Explainable learning currently a topic of major interest.

Let's watch a video

<https://www.youtube.com/watch?v=jwSbzNHGfIM>

Example: Dextrous manipulation

A Distributed workers collect experience on randomized environments at large scale.



B We train a control policy using reinforcement learning. It chooses the next action based on fingertip positions and the object pose.



C We train a convolutional neural network to predict the object pose given three simulated camera images.

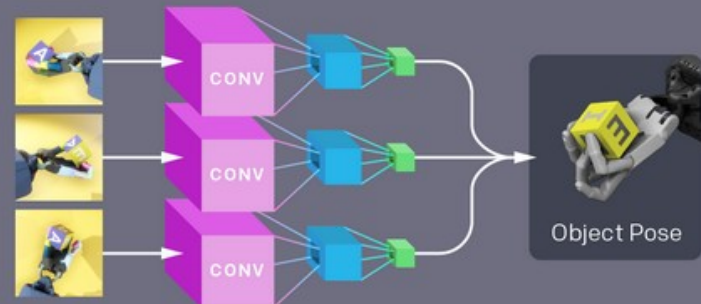

Example: Dextrous manipulation

Transfer to the Real World

D We combine the pose estimation network and the control policy to transfer to the real world.



Example: Dextrous manipulation



Analyze!

- Could this approach be used in practice?
- In which cases?
- Why or why not? Which constraints are there for use?
- Any other notes?

Example: Learning grasp stability

- Learn to predict if a grasp is stable based on tactile sensor measurements.
- Simple simulation and analytic grasp quality measures to generate training data.
- Statistical ML.

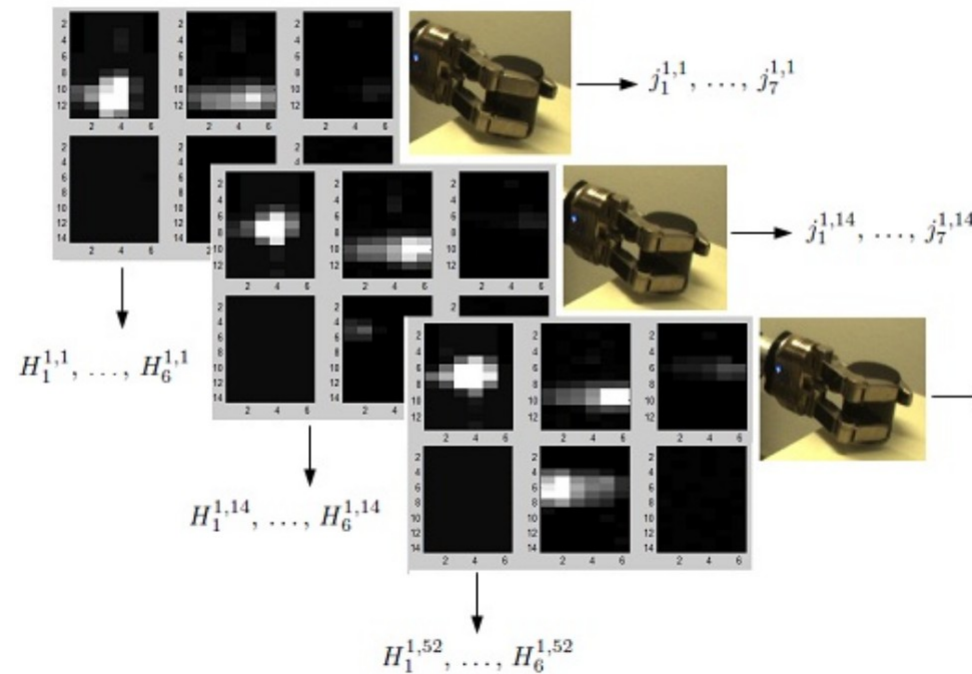

Bekiroglu et al. 2011

Example: Learning where to grasp Dex-Net 2.0

- Simulated pointcloud training data creation.

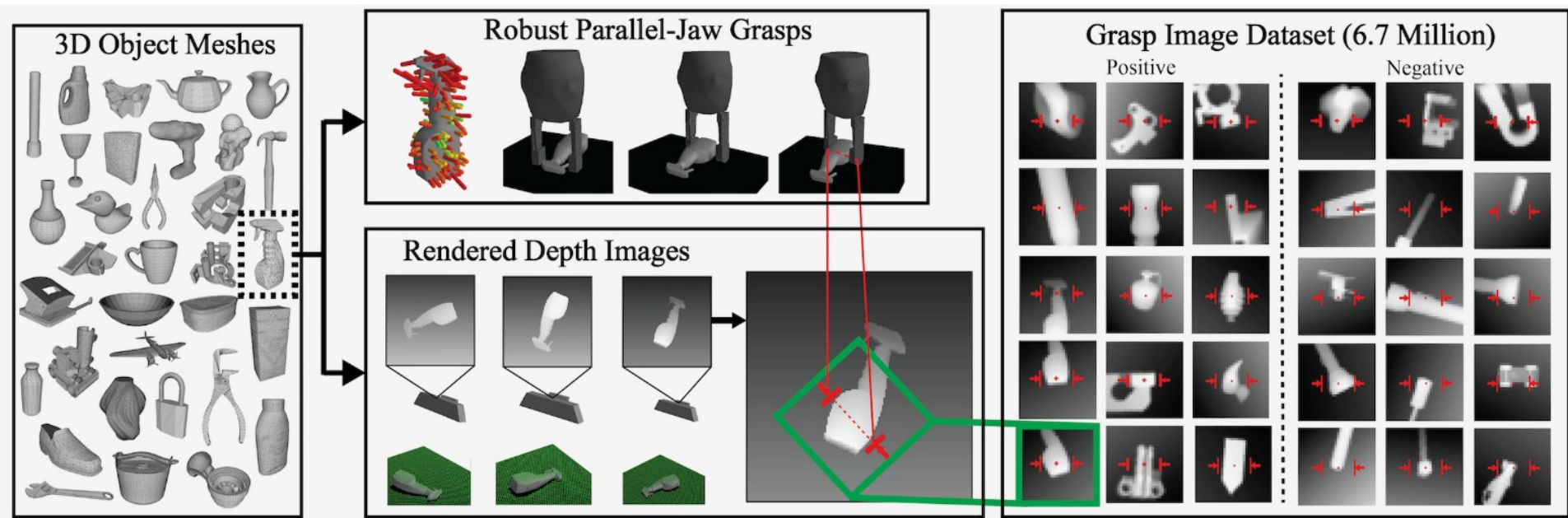

Mahler et al., 2017

Example: Learning where to grasp

Dex-Net 2.0

- Learn to predict quality metric from image using convolutional NN.

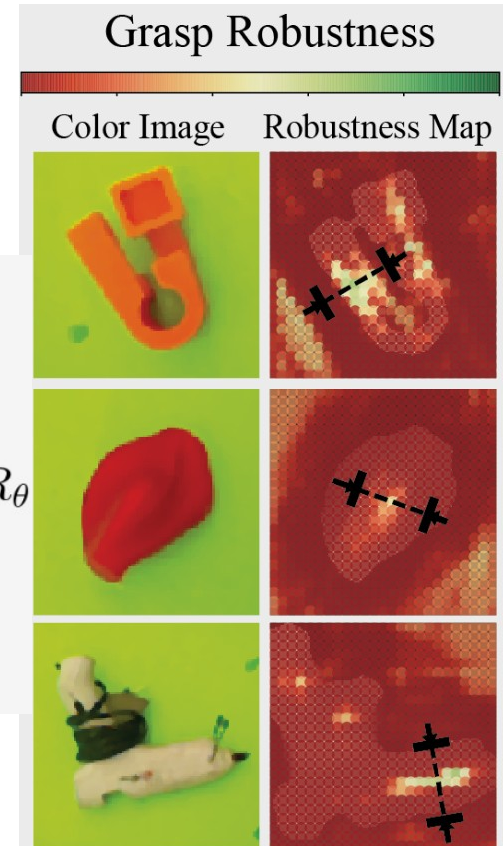
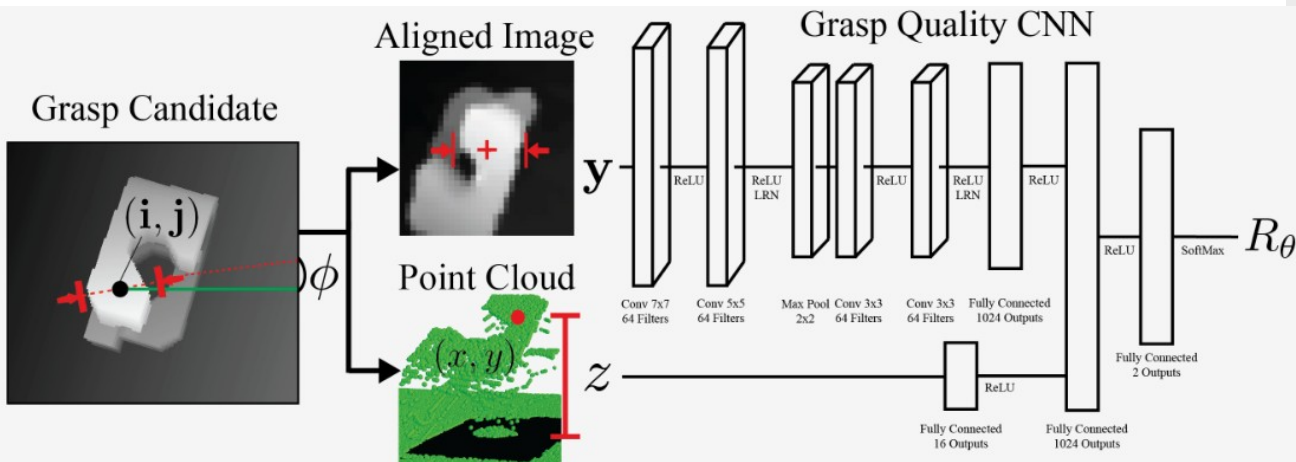

Mahler et al., 2017

Example: Learning movements

Movement primitives

- General idea: Learn trajectories (trajectory primitives).
 - Can be modulated, e.g. end-point or speed change.
 - Learned from e.g. human demonstration.
 - May be improved by reinforcement learning.
 - Sequencing can also be learned.



Muelling et al. 2013

Example: Learning in-contact skills

- Learn position and force trajectories from human demonstration.
- Impedance control with force feed-forward.
- Can be improved by reinforcement learning.

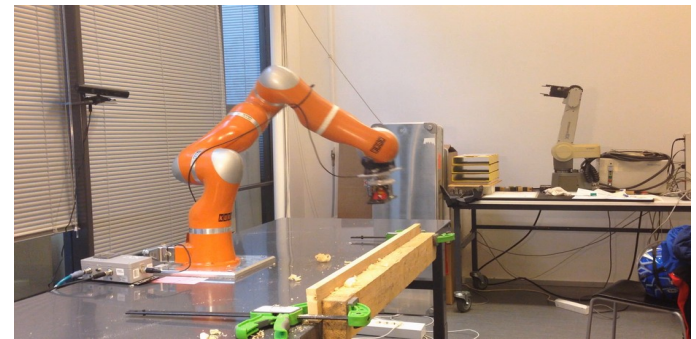
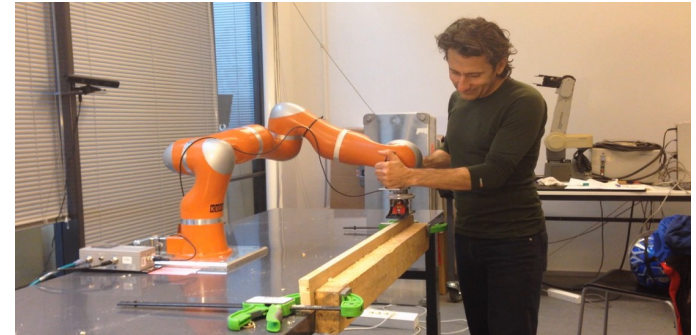

Example: End-to-end learning of deep visuomotor policies

- Learn a NN controller from vision to torques.
- Training: Learn first individual trajectories using reinforcement learning, train NN using supervised learning.

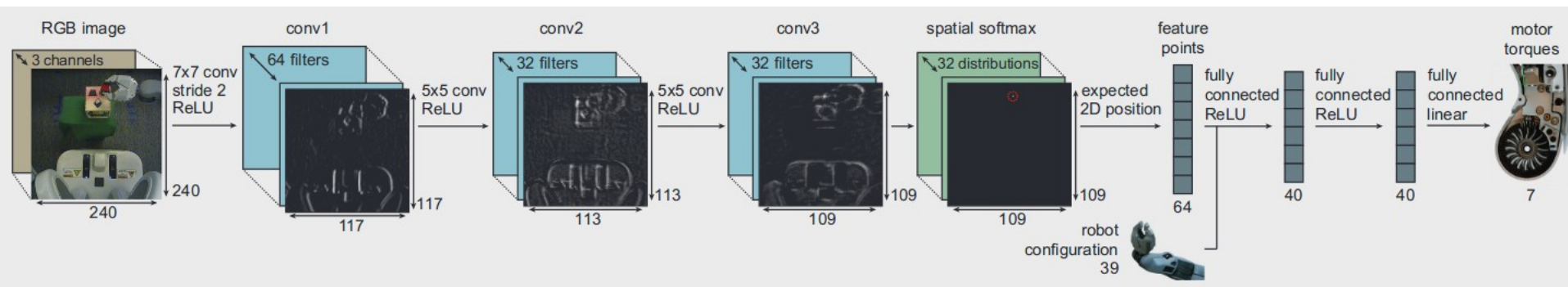

Levine et al. 2015

Summary

- Machine learning provides tools for subproblems in robotic manipulation.
- Data availability is often a challenge.
- At the moment, robot learning still primarily only in research labs because of lack of robustness.