

A?

Aalto University
School of Electrical
Engineering

E4230

Microwave EO Instrumentation

Jaan Praks



- Ulaby
- Long
- Blackwell
- Elachi
- Fung
- Ruf
- Sarabandi
- Zebker
- Van Zyl

Microwave Radar and Radiometric Remote Sensing

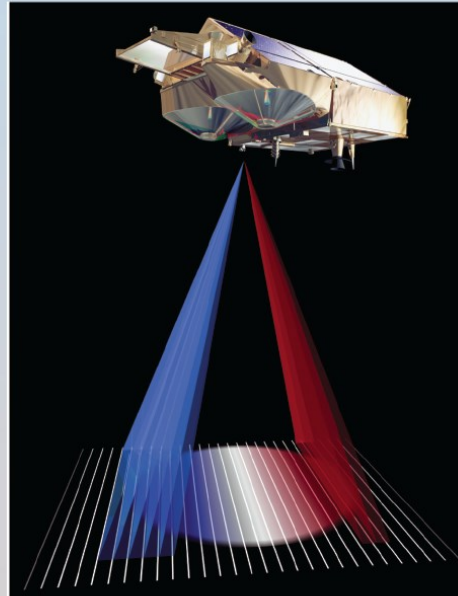

These PowerPoint slides are intended for educational use. They should not be used for sale or financial profit.



Aalto University
School of Electrical
Engineering

Origin of EM radiation

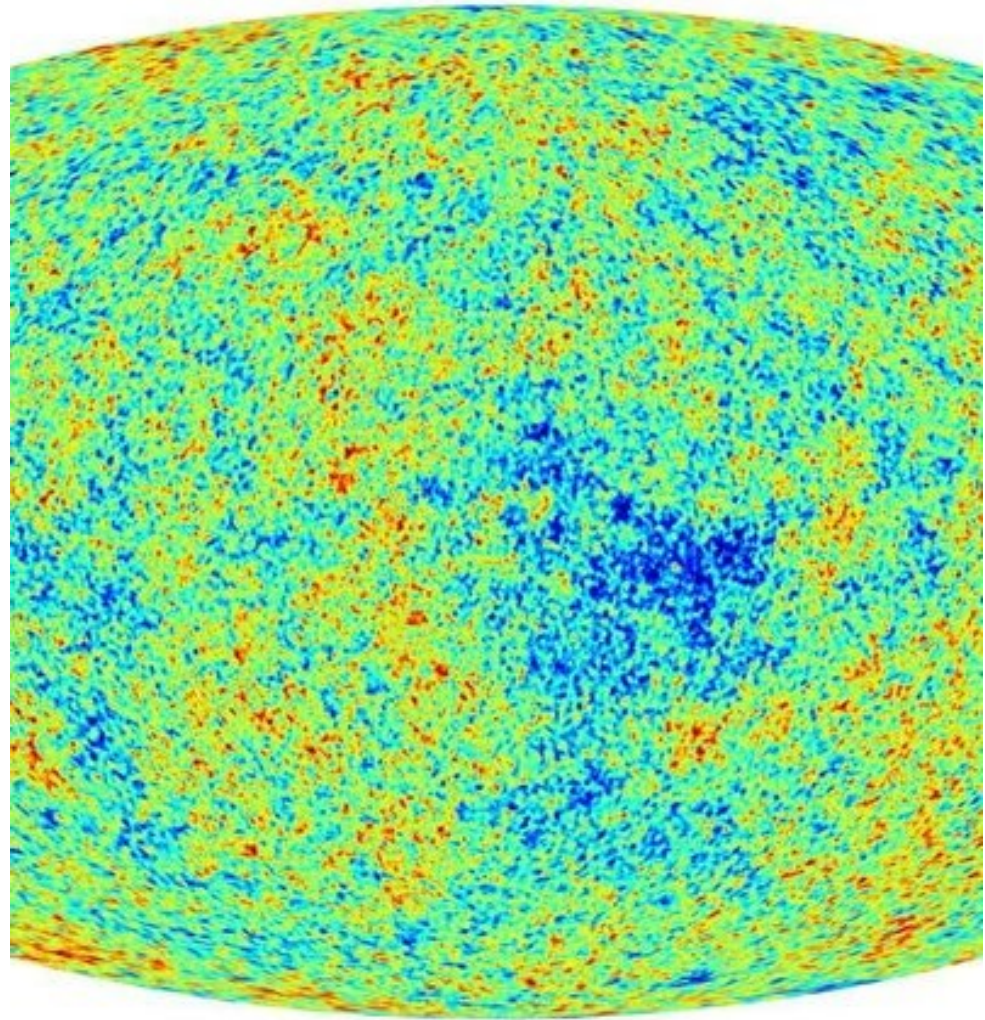

300 μ K

+300 μ K

Radiation origin

When there is a transition between quantum level E_1 and E_2 , the frequency f of the emitted radiation (photon) is given by Bohr's equation. Also, transition from rotational and vibrational involves energy radiation.

All substances at a finite absolute temperature radiate electromagnetic energy.

A liquid or solid may be regarded as an enormous molecule with a correspondingly increased number of degrees of freedom, which leads to such a large number of closely spaced spectral lines that the radiation spectrum becomes effectively continuous, with all frequencies being radiated.

Atomic gases radiate electromagnetic waves at discrete frequencies, or wavelengths; that is, they have line spectra.

Blackbody concept

A **blackbody** is defined as an idealized, perfectly opaque material that **absorbs all the incident radiation** at all frequencies, reflecting none.

A body in thermodynamic equilibrium emits to its environment the same amount of energy it absorbs from its environment. Hence, in addition to being a perfect absorber, a **blackbody also is a perfect emitter**.

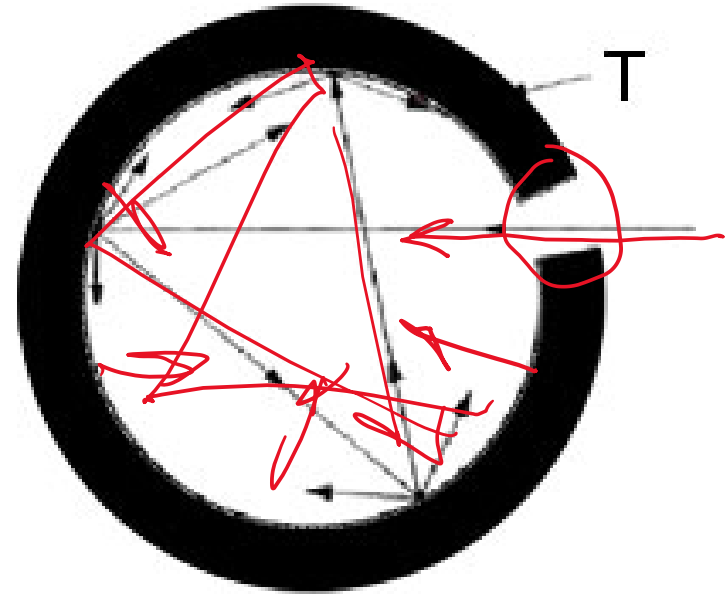

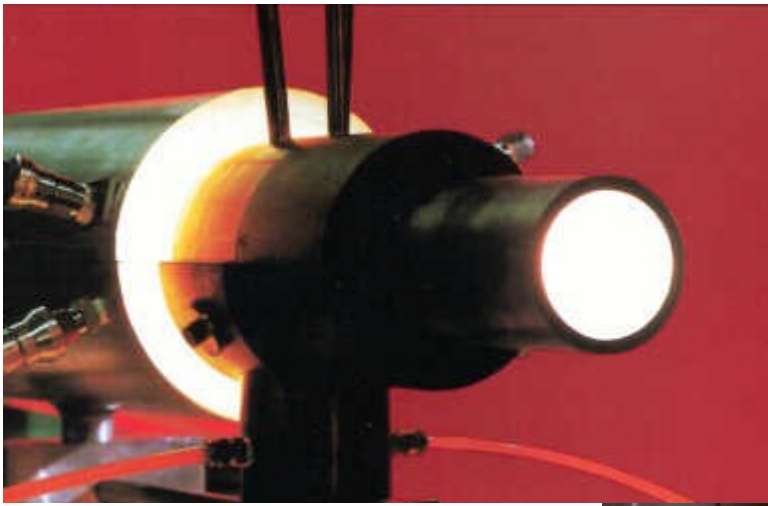

Planck's law

$$I_f = \frac{2hf^3}{c^2} \frac{1}{e^{\frac{hf}{kT}} - 1}$$

A **blackbody** is defined as an idealized, perfectly opaque material that absorbs all the incident radiation at all frequencies, reflecting none.

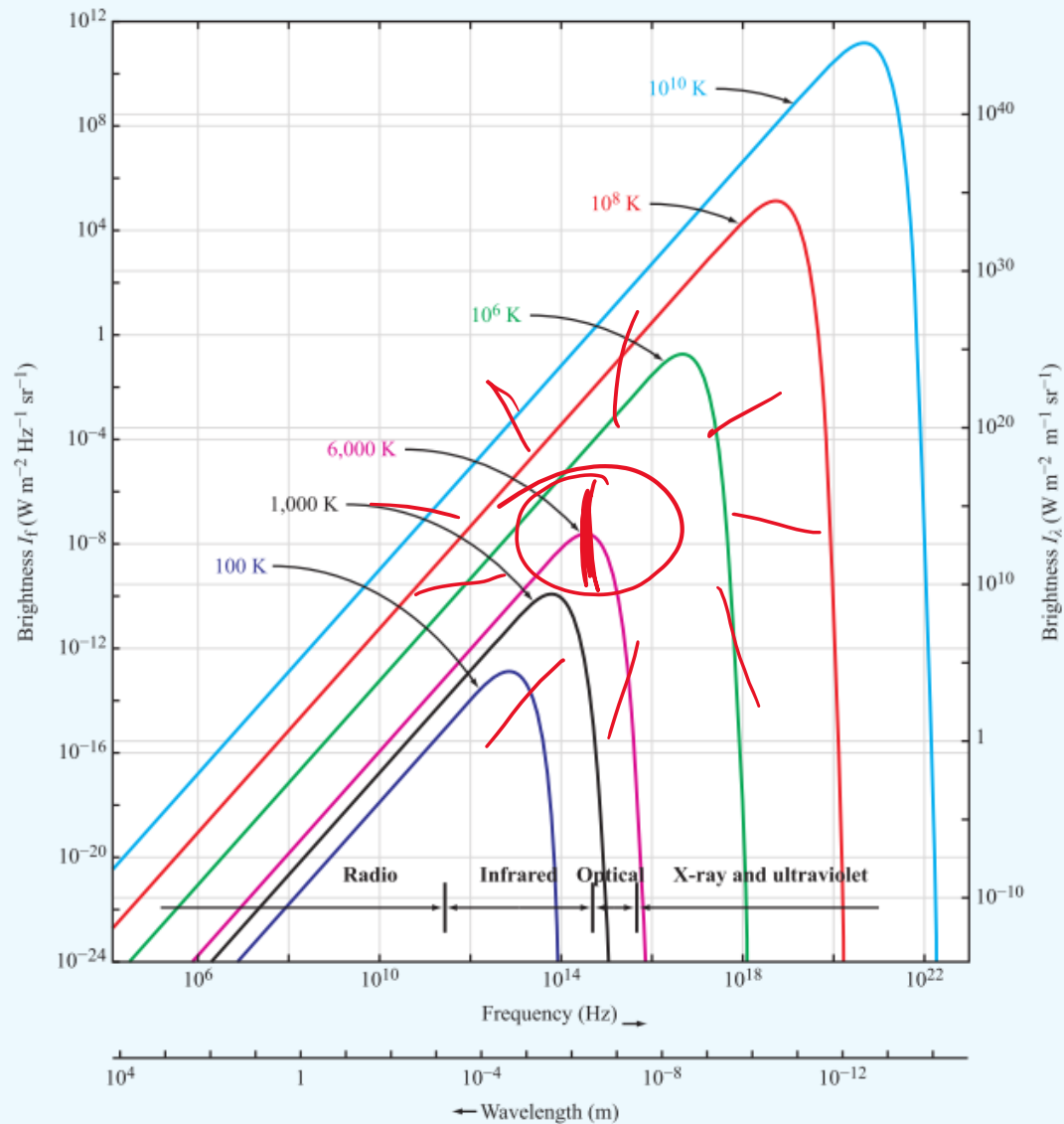

Figure 6-1: Planck's radiation law [adapted from Kraus, 1966].

Rayleigh–Jeans's law

The Rayleigh–Jeans approximation is very useful in the microwave region: it is mathematically simpler than Planck's law and yet its fractional deviation from Planck's exact expression is less than 1% if $\lambda T > 0.77 \text{ m K}$, or equivalently, $f/T < 3.9 \times 10^8 \text{ Hz K}^{-1}$.

$$I_f \approx \frac{2kT}{\lambda^2}$$

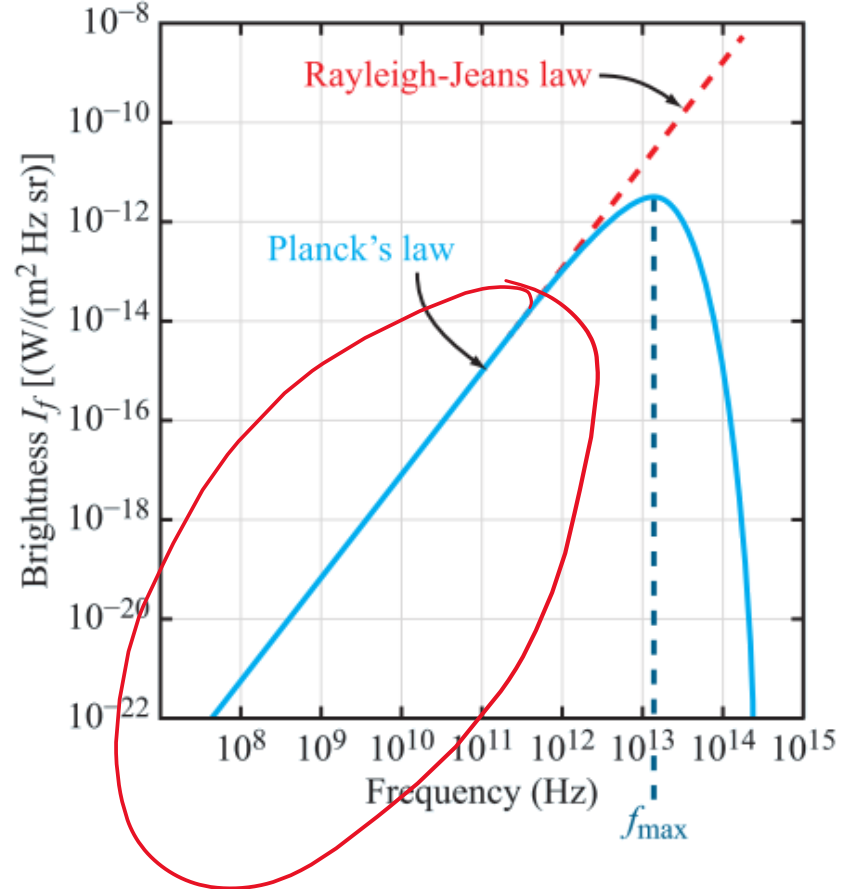

Figure 6-3: Comparison of Planck's law with its low-frequency approximation (Rayleigh–Jeans law) at 300 K.

EM waves

A time-varying electric field induces a magnetic field and, conversely, a time-varying magnetic field induces an electric field. This cyclic pattern often results in **electromagnetic waves** propagating through free space and in material media.

Waves propagating in a lossless medium (e.g., air and perfect dielectrics) do not attenuate. When propagating in a lossy medium (material with nonzero conductivity, such as water), part of the power carried by an EM wave gets converted into heat.

The interaction of EM wave with media may involve **scattering, absorption, transmission, and emission**, or combinations.

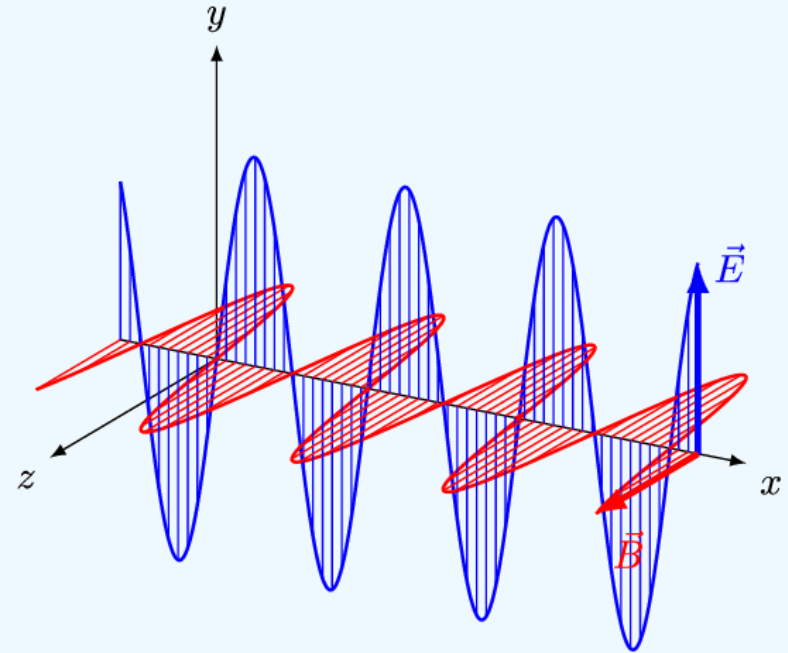

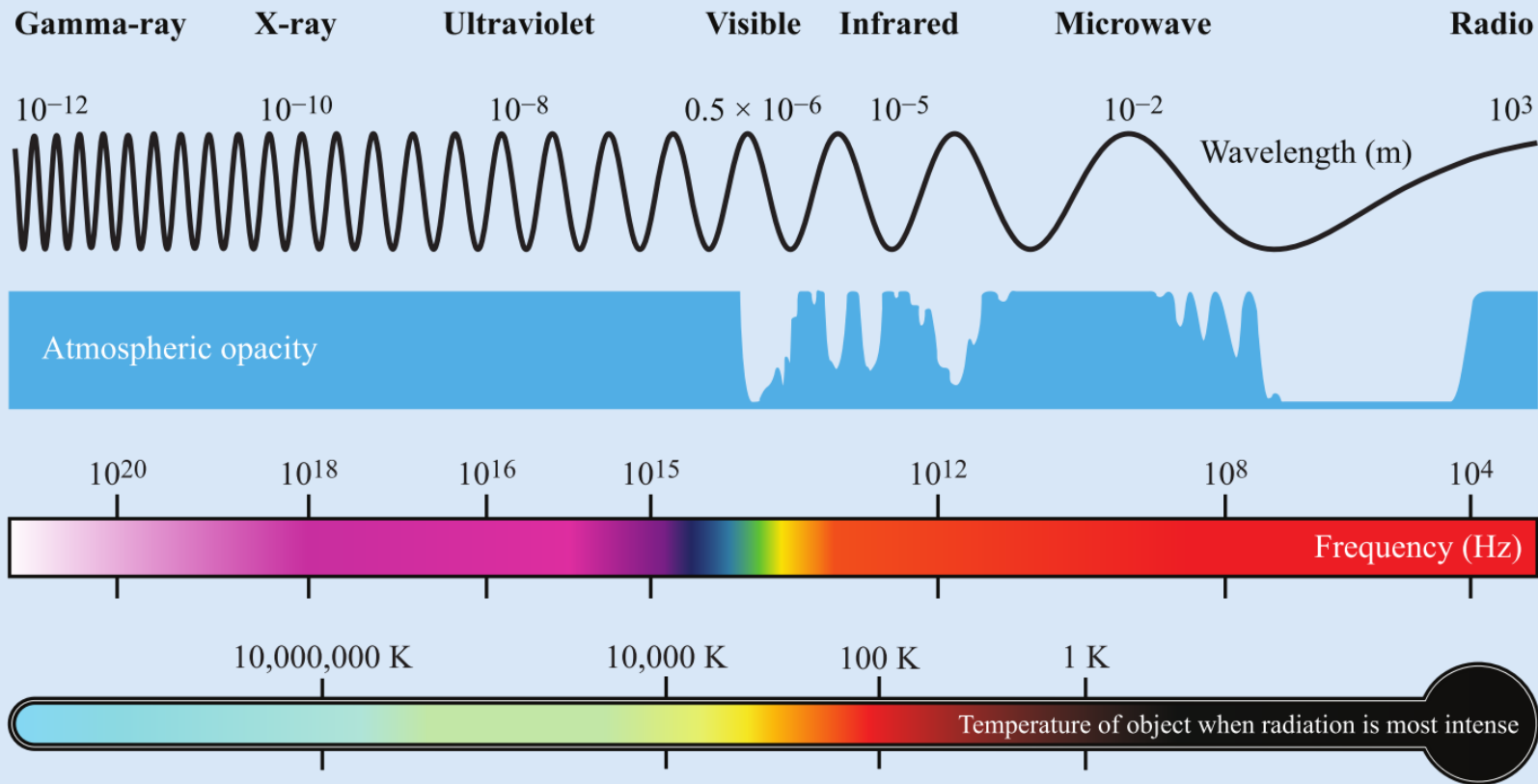



Aalto University
School of Electrical
Engineering

Microwaves

Table 1-5: Common band designations (GHz).

Band	Frequency Range (GHz)
P	0.225–0.390
L	0.390–1.550
S	1.550–4.20
C	4.20–5.75
X	5.75–10.9
K	10.9–36.0
Q	36.0–46.0
V	46.0–56.0
W	56.0–100

By convention, the microwave region encompasses the UHF, SHF, and EHF bands, extending from 0.3 to 300 GHz (1 m to 1 mm in wavelength)

A?

Aalto University
School of Electrical
Engineering

E4230

Microwave EO Instrumentation

Take a break





Aalto University
School of Electrical
Engineering

EM wave propagation

Chapter 2 in the course textbook

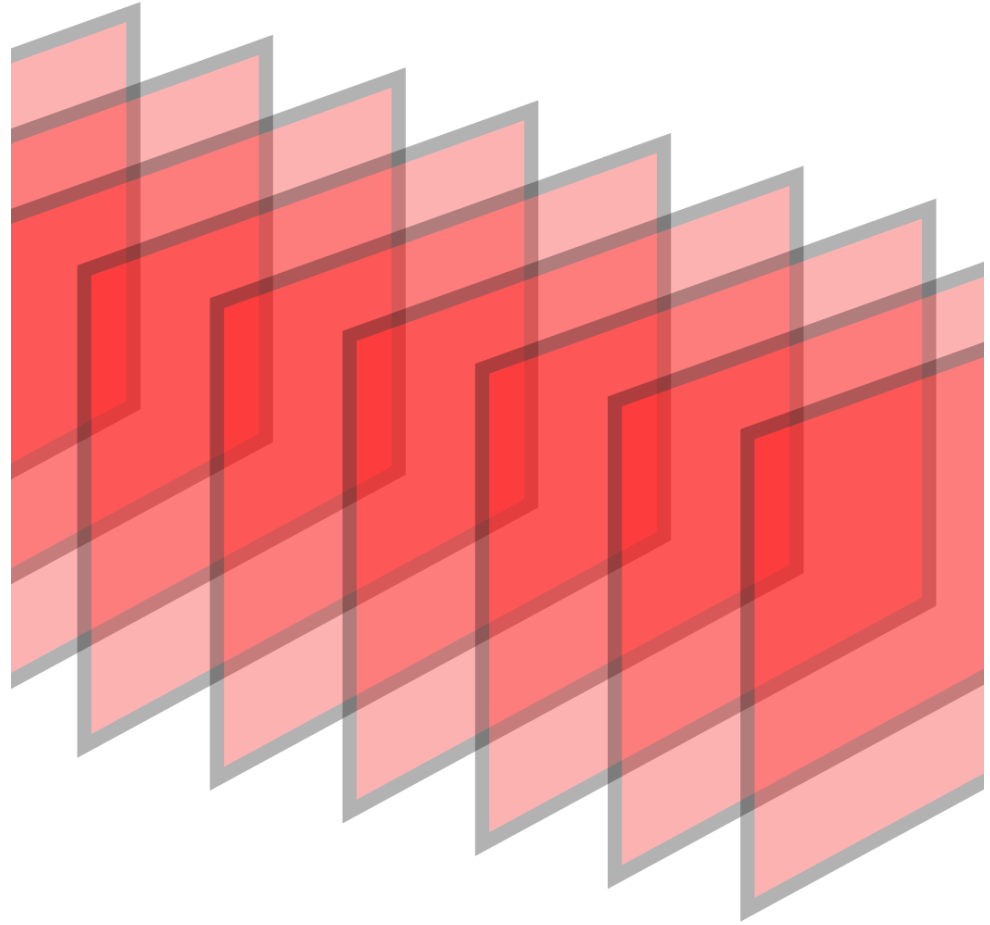

Fundamental EM relations

Maxwell equations

$$\begin{aligned}\nabla \cdot \mathbf{E} &= \rho_v / \epsilon' \epsilon_0, \\ \nabla \times \mathbf{E} &= -j\omega\mu\mathbf{H}, \\ \nabla \cdot \mathbf{H} &= 0, \\ \nabla \times \mathbf{H} &= \mathbf{J} + j\omega\epsilon'\epsilon_0\mathbf{E}.\end{aligned}$$

$$\begin{aligned}\rho_v &= 0 \text{ (no charges)} \\ \mathbf{J} &= 0 \text{ (no currents)}\end{aligned}$$

$$\begin{aligned}\nabla \cdot \mathbf{E} &= 0, \\ \nabla \times \mathbf{E} &= -j\omega\mu\mathbf{H}, \\ \nabla \cdot \mathbf{H} &= 0, \\ \nabla \times \mathbf{H} &= j\omega\epsilon\epsilon_0\mathbf{E}.\end{aligned}$$

Fundamental parameters

(a) Free space:

$$\epsilon' = 1$$

$$\mu = \mu_0 = 4\pi \times 10^{-7} \text{ H/m}$$

$$\rho_v = 0$$

$$\sigma = 0$$

Lossless
media

(b) Pure dielectric:

ϵ' : medium-specific

$\mu = \mu_0$ (all materials except ferromagnetic)

$$\rho_v = 0$$

$$\sigma = 0$$

Lossy
media

(c) Conducting medium:

ϵ' : medium-specific

$\mu = \mu_0$ (except ferromagnetic)

ρ_v may or may not be zero

$$\sigma \neq 0$$

- $\epsilon \epsilon_0 =$ *electrical permittivity* (F/m),[†]
- $\mu =$ *magnetic permeability* (H/m),
- $\rho_v =$ *volume charge density* (C/m³),
- $\sigma =$ *conductivity* (S/m)

where $\epsilon_0 = 8.85 \times 10^{-12}$ F/m is the permittivity of free space and ϵ' is the *permittivity of the material relative to that of free space*.

► We denote the *relative permittivity* by the symbol ϵ' , instead of ϵ , so we may use the latter in future sections to represent the complex dielectric constant of the material under sinusoidal time-varying conditions. ◀

A?

Aalto University
School of Electrical
Engineering

E4230

Microwave EO Instrumentation

Take a break





Aalto University
School of Electrical
Engineering

Lossless media

$$\nabla \cdot \mathbf{E} = \rho_{\text{y}} \cancel{\epsilon_0},$$

$$\nabla \times \mathbf{E} = -j\omega\mu\mathbf{H},$$

$$\nabla \cdot \mathbf{H} = 0,$$

$$\nabla \times \mathbf{H} = \cancel{j} + j\omega\epsilon'\epsilon_0\mathbf{E}.$$

EM wave equation

Homogeneous wave equation arises as Maxwell equation solution

$$\nabla^2 \mathbf{E} - \gamma^2 \mathbf{E} = 0.$$

$$\nabla^2 \mathbf{H} - \gamma^2 \mathbf{H} = 0.$$

$$\nabla^2 \mathbf{E} = \left(\frac{\partial^2}{\partial x^2} + \frac{\partial^2}{\partial y^2} + \frac{\partial^2}{\partial z^2} \right) \mathbf{E}.$$

where constant γ is known as *propagation constant*

$$\gamma^2 = -\omega^2 \mu \epsilon \epsilon_0,$$

Lossless Media

propagation constant is real, the wave number

nonconducting ($\sigma = 0$) \rightarrow no attenuation, lossless

$$\gamma^2 = -\omega^2 \mu \epsilon' \epsilon_0$$

$$\gamma^2 = -k^2$$

Wavenumber

$$k = \omega \sqrt{\mu \epsilon' \epsilon_0}.$$

$$\nabla^2 \mathbf{E} + k^2 \mathbf{E} = 0.$$

$$\frac{d^2 E_x}{dz^2} + k^2 E_x = 0$$

$$E_x(z) = E_x^+(z) + E_x^-(z) = E_{x0}^+ e^{-jkz} + E_{x0}^- e^{jkz}$$

A uniform plane wave is characterized by electric and magnetic fields that have uniform properties at all points across an infinite plane.

A plane wave has no electric- or magnetic-field components along its direction of propagation.

Transverse wave

A uniform plane wave is characterized by electric and magnetic fields that have uniform properties at all points across an infinite plane.

A plane wave has no electric- or magnetic-field components along its direction of propagation.

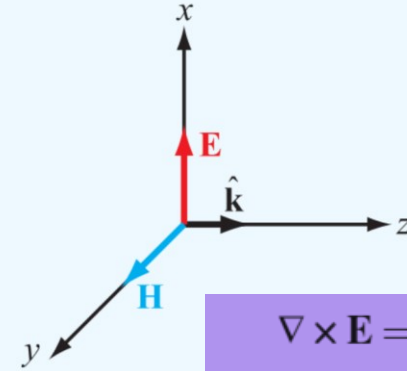

$$\nabla \times \mathbf{E} = -j\omega\mu\mathbf{H},$$

Figure 2-2: A transverse electromagnetic (TEM) wave propagating in the direction $\hat{\mathbf{k}} = \hat{\mathbf{z}}$. For all TEM waves, $\hat{\mathbf{k}}$ is parallel to $\mathbf{E} \times \mathbf{H}$.

Intrinsic wave impedance

Because

$$\nabla \times \mathbf{E} = -j\omega\mu\mathbf{H},$$

$$H_{y0}^+ = \frac{k}{\omega\mu} E_{x0}^+,$$

Intrinsic (wave) impedance

$$\eta = \frac{\omega\mu}{k} = \frac{\omega\mu}{\omega\sqrt{\mu\epsilon'\epsilon_0}} = \sqrt{\frac{\mu}{\epsilon'\epsilon_0}} \quad (\Omega),$$

Intrinsic impedance describes how much magnetic field is induced by electric field and how much electric field is induced by magnetic field in lossless homogeneous media. Wave impedance unit is ohm (Ω).

Transverse electromagnetic wave

phase velocity and wavelength

$$\mathbf{H} = \frac{1}{\eta} \hat{\mathbf{k}} \times \mathbf{E},$$

$$\mathbf{E} = -\eta \hat{\mathbf{k}} \times \mathbf{H}. \quad \eta = \frac{\omega\mu}{k} = \frac{\omega\mu}{\omega\sqrt{\mu\epsilon'\epsilon_0}} = \sqrt{\frac{\mu}{\epsilon'\epsilon_0}} \quad (\Omega),$$

From angular frequency (ω) and wavenumber (k) we can derive **phase velocity** (u_p)

$$u_p = \frac{\omega}{k} = \frac{\omega}{\omega\sqrt{\mu\epsilon'\epsilon_0}} = \frac{1}{\sqrt{\mu\epsilon'\epsilon_0}} \quad (\text{m/s}),$$

wavelength (λ) is connected to wavenumber and phase velocity as

$$\lambda = \frac{2\pi}{k} = \frac{u_p}{f} \quad (\text{m}).$$

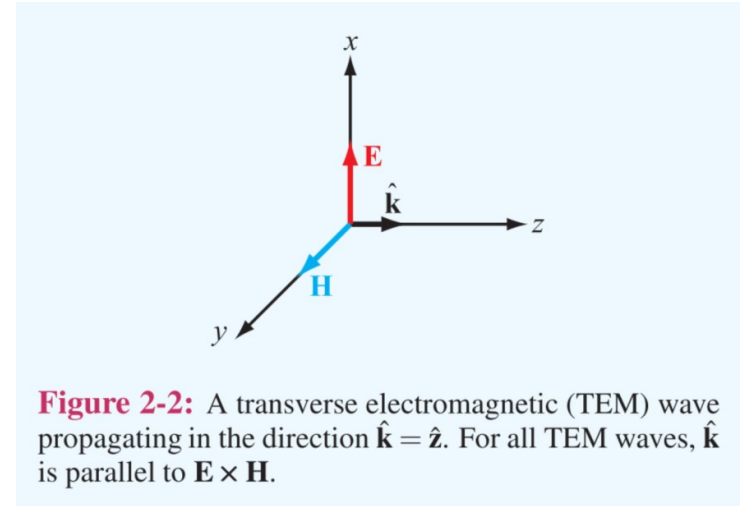

Figure 2-2: A transverse electromagnetic (TEM) wave propagating in the direction $\hat{\mathbf{k}} = \hat{\mathbf{z}}$. For all TEM waves, $\hat{\mathbf{k}}$ is parallel to $\mathbf{E} \times \mathbf{H}$.

Wave in free space

phase velocity in free space

$$u_p = c = \frac{1}{\sqrt{\mu_0 \epsilon_0}} = 299,792,458 \approx 3 \times 10^8 \quad (\text{m/s})$$

intrinsic impedance of free space

$$\eta = \eta_0 = \sqrt{\frac{\mu_0}{\epsilon_0}} = 377 \quad (\Omega) \approx 120\pi \quad (\Omega)$$

$$\mathbf{H} = \frac{1}{\eta} \hat{\mathbf{k}} \times \mathbf{E},$$

$$\mathbf{E} = -\eta \hat{\mathbf{k}} \times \mathbf{H}.$$

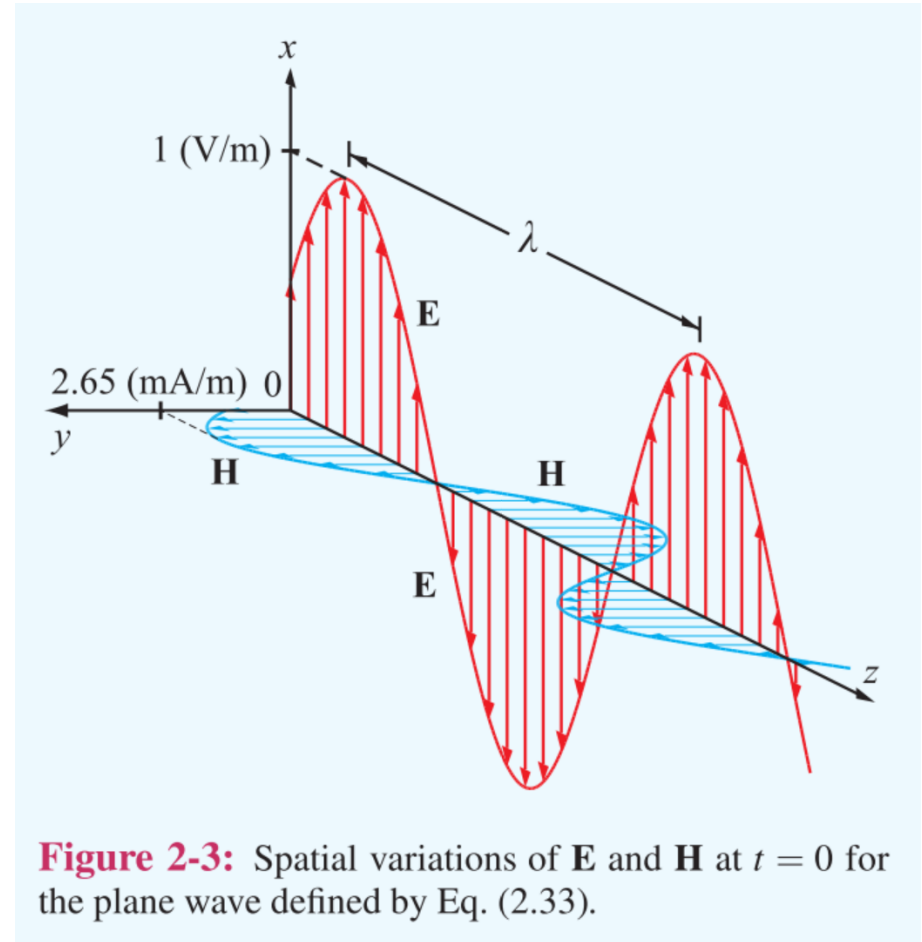

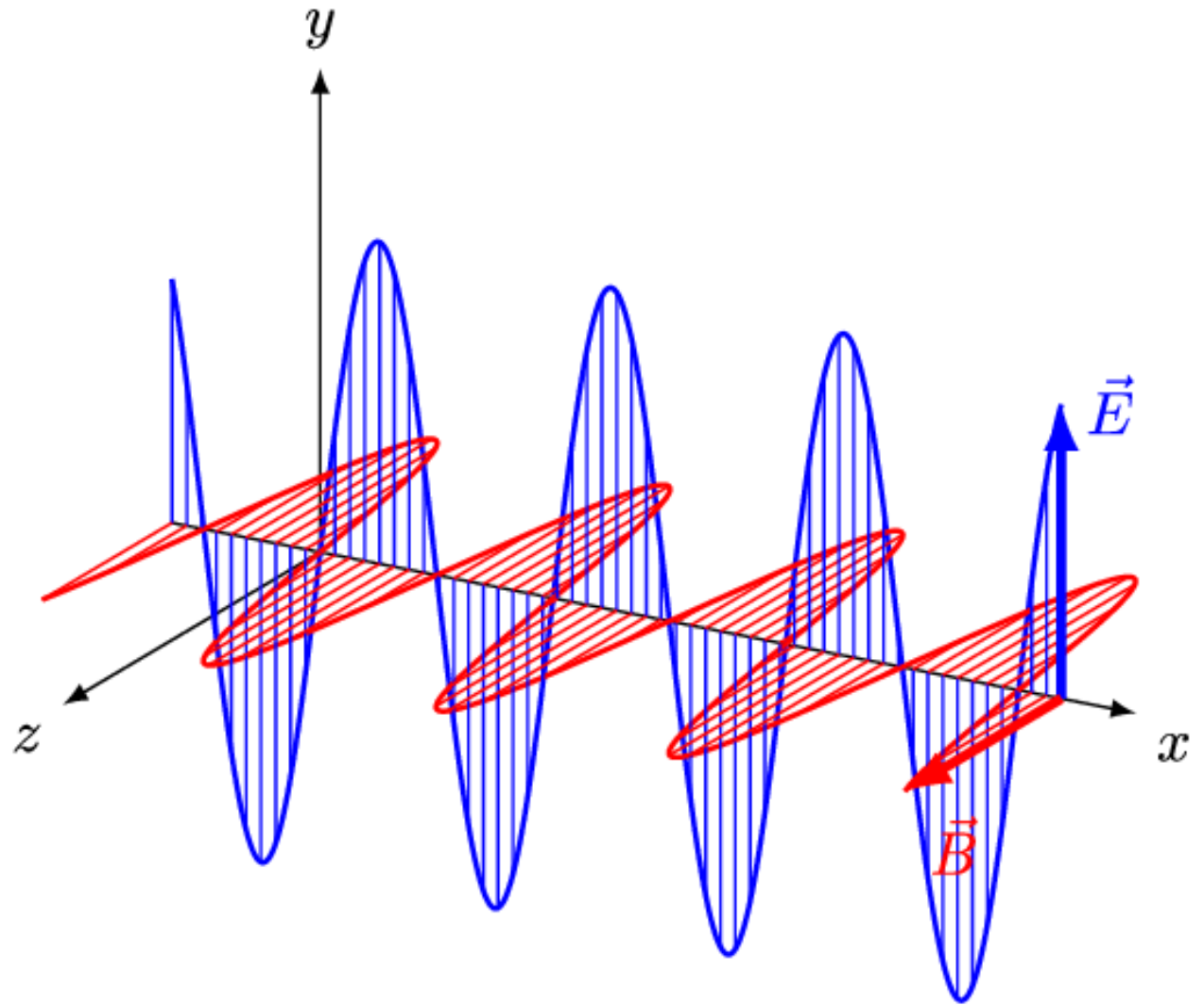

Plane-wave approximation

can be used, if we are far enough

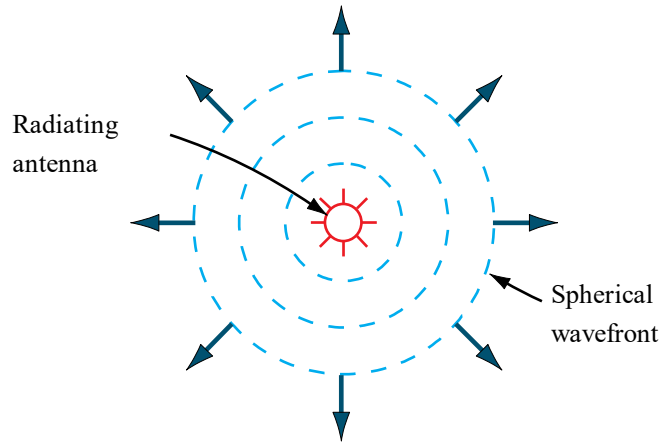

(a) Spherical wave

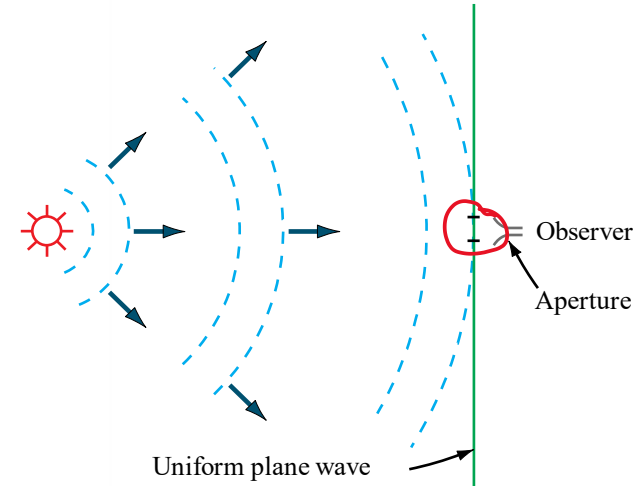

(b) Plane-wave approximation

Figure 2-1: Waves radiated by an EM source, such as a lightbulb or an antenna, have spherical wavefronts, as in (a); to a distant observer, however, the wavefront across the observer's aperture appears approximately planar, as in (b).

Plane wave

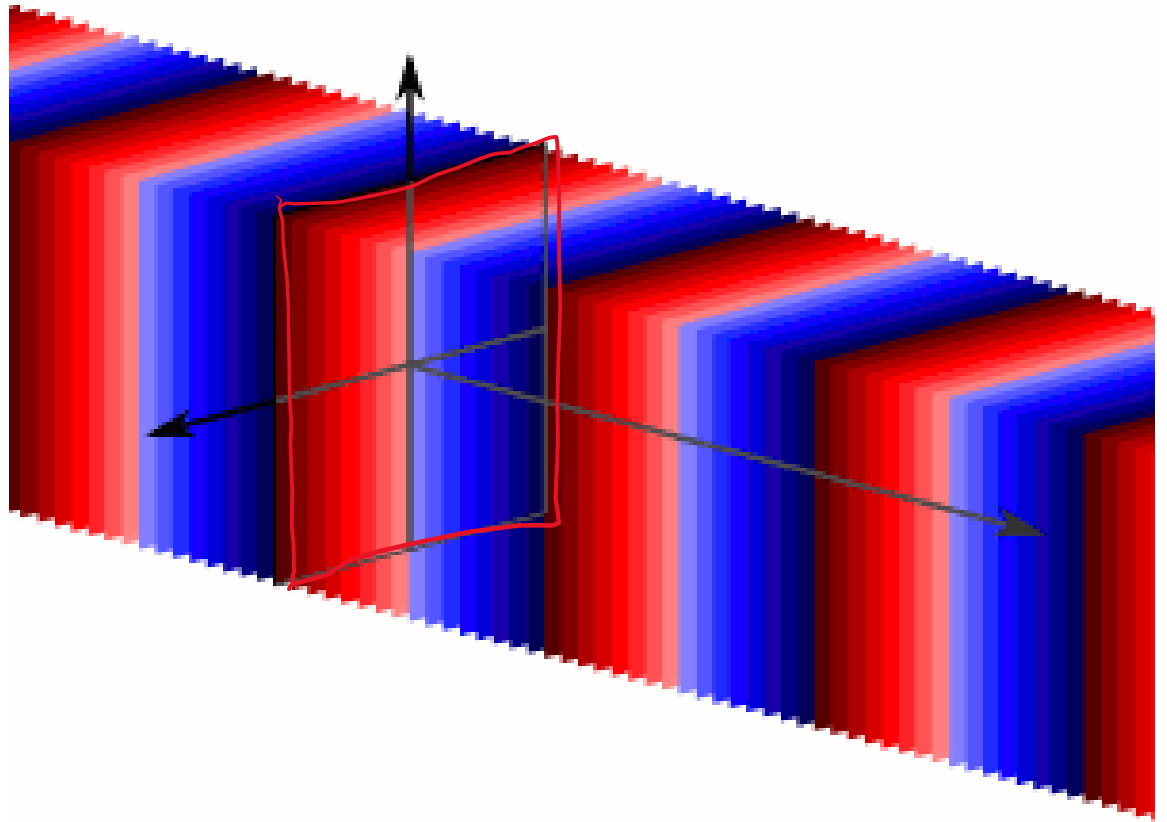

Recap

- **Traverse electromagnetic wave is a plane wave.**
- **Plane wave is described by phase velocity and wavelength (or wavenumber and angular frequency) are dependent on magnetic permeability and electric permittivity of the material.**

A?

Aalto University
School of Electrical
Engineering

E4230

Microwave EO Instrumentation

Take a break





Aalto University
School of Electrical
Engineering

Lossy (conducting) media

$$\begin{aligned}\nabla \cdot \mathbf{E} &= \rho_v / \cancel{\epsilon_0}, \\ \nabla \times \mathbf{E} &= -j\omega\mu\mathbf{H}, \\ \nabla \cdot \mathbf{H} &= 0, \\ \nabla \times \mathbf{H} &= \mathbf{J} + j\omega\epsilon'\epsilon_0\mathbf{E}.\end{aligned}$$

Propagation constant is complex!

Maxwell equations with currents

Maxwell equations in vacuum (no charges)

$$\begin{aligned}\nabla \cdot \mathbf{E} &= \cancel{\rho_v} / \epsilon' \epsilon_0, \\ \nabla \times \mathbf{E} &= -j\omega\mu\mathbf{H}, \\ \nabla \cdot \mathbf{H} &= 0, \\ \nabla \times \mathbf{H} &= \mathbf{J} + j\omega\epsilon'\epsilon_0\mathbf{E}.\end{aligned}$$

$$\nabla \times \mathbf{H} = \mathbf{J} + j\omega\epsilon'\epsilon_0\mathbf{E}$$

$$= (\sigma + j\omega\epsilon'\epsilon_0)\mathbf{E} = j\omega\epsilon_0 \left(\epsilon' - j\frac{\sigma}{\omega\epsilon_0} \right) \mathbf{E}$$

complex dielectric constant

$$\begin{aligned}\nabla \cdot \mathbf{E} &= 0, \\ \nabla \times \mathbf{E} &= -j\omega\mu\mathbf{H}, \\ \nabla \cdot \mathbf{H} &= 0, \\ \nabla \times \mathbf{H} &= j\omega\epsilon\epsilon_0\mathbf{E}.\end{aligned}$$

Complex dielectric constant

Maxwell equations in vacuum
(no charges)

$$\begin{aligned}\nabla \cdot \mathbf{E} &= 0, \\ \nabla \times \mathbf{E} &= -j\omega\mu\mathbf{H}, \\ \nabla \cdot \mathbf{H} &= 0, \\ \nabla \times \mathbf{H} &= j\omega\varepsilon\varepsilon_0\mathbf{E}.\end{aligned}$$

By using
complex dielectric constant

$$\varepsilon = \varepsilon' - j\frac{\sigma}{\omega\varepsilon_0} = \varepsilon' - j\varepsilon''$$

**we can maintain the same
Maxwell equation formalism
and the same wave equation
solution**

Dielectric loss factor

$$\varepsilon = \varepsilon' - j \frac{\sigma}{\omega \varepsilon_0} = \varepsilon' - j \varepsilon''$$

Dielectric loss factor

$$\varepsilon'' = \frac{\sigma}{\omega \varepsilon_0}$$

conductivity

Intrinsic wave impedance of lossy medium is also complex

$$\nabla \times \mathbf{E} = -j\omega\mu\mathbf{H},$$

$$\mathbf{H}(z) = \hat{\mathbf{y}} H_y(z) = \hat{\mathbf{y}} \frac{E_x(z)}{\eta_c} = \hat{\mathbf{y}} \frac{E_{x0}}{\eta_c} e^{-\alpha z} e^{-j\beta z}$$

In a lossless medium, $\mathbf{E}(z,t)$ is in phase with $\mathbf{H}(z,t)$; however, this property no longer holds true in a lossy medium because η_c is complex.

intrinsic wave impedance of lossy medium is also complex

$$\begin{aligned} \eta_c &= \sqrt{\frac{\mu_0}{\epsilon\epsilon_0}} = \sqrt{\frac{\mu_0}{\epsilon'\epsilon_0}} \left(1 - j\frac{\epsilon''}{\epsilon'}\right)^{-1/2} \\ &= \frac{\eta_0}{\sqrt{\epsilon'}} \left(1 - j\frac{\epsilon''}{\epsilon'}\right)^{-1/2} \quad (\Omega),^\dagger \end{aligned}$$

[†] We set $\mu = \mu_0$ because the natural materials encountered in remote sensing are nonmagnetic. This includes water, ice, soil, and vegetation, among many others.

Wave equation with complex dielectric constant

$$\nabla^2 \mathbf{E} - \gamma^2 \mathbf{E} = 0.$$

$$\gamma^2 = -\omega^2 \mu \epsilon \epsilon_0 = -\omega^2 \mu \epsilon_0 (\epsilon' - j\epsilon'')$$

Propagation constant becomes also complex!

$$\gamma = \alpha + j\beta$$

$$\frac{d^2 E_x(z)}{dz^2} - \gamma^2 E_x(z) = 0$$

$$\mathbf{E}(z) = \hat{\mathbf{x}} E_{x0} e^{-\gamma z} = \hat{\mathbf{x}} E_{x0} e^{-\alpha z} e^{-j\beta z}$$

$$|E_x(z)| = |E_{x0} e^{-\alpha z} e^{-j\beta z}| = |E_{x0}| e^{-\alpha z}$$

The real part α of the propagation constant is called **attenuation constant**, as it describes attenuation of the amplitude during propagation.

Attenuation constant and skin depth

$$|E_x(z)| = |E_{x0}e^{-\alpha z}e^{-j\beta z}| = |E_{x0}|e^{-\alpha z}$$

$$\delta_s = \frac{1}{\alpha} \quad (\text{m}),$$

This distance δ_s , called the **skin depth (or penetration depth)** of the medium, characterizes how deep an electromagnetic wave can penetrate into a conducting medium.

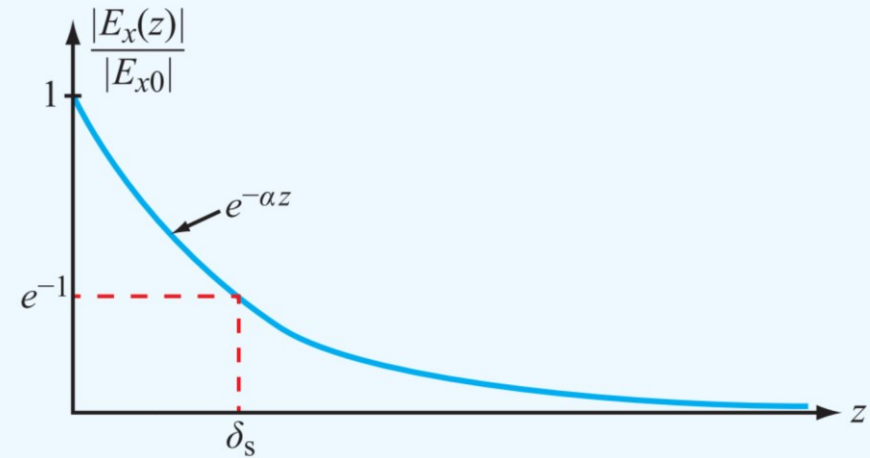

Figure 2-10: Attenuation of the magnitude of $E_x(z)$ with distance z . The skin depth δ_s is the value of z at which $|E_x(z)|/|E_{x0}| = e^{-1}$, or $z = \delta_s = 1/\alpha$.

Penetration of electromagnetic wave

As the field attenuates, part of the energy carried by the electromagnetic wave is converted into heat due to conduction in the medium.

Perfect dielectric:

When $\sigma = 0$, ($\varepsilon'' = 0$, $\alpha = 0$) therefore $\delta_s = \infty$
Wave keeps traveling forever

Perfect conductor:

When $\sigma = \infty$, ($\varepsilon'' = 0$, $\alpha = 0$) therefore $\delta_s = 0$
Wave stops on the surface

When $\varepsilon''/\varepsilon' \ll 1$, the medium is considered a **low-loss dielectric**.

When $\varepsilon''/\varepsilon' \gg 1$, the medium is considered a **good conductor**.

Low loss dielectric

$$\alpha = -\omega\sqrt{\mu\epsilon_0} \Im\{\sqrt{\epsilon}\},$$

$$\beta = \omega\sqrt{\mu\epsilon_0} \Re\{\sqrt{\epsilon}\}.$$

$$\begin{aligned}\gamma &\approx j\omega\sqrt{\mu_0\epsilon'\epsilon_0} \left(1 - j\frac{\epsilon''}{2\epsilon'}\right) \\ &\approx j\frac{2\pi}{\lambda_0} \sqrt{\epsilon'} \left(1 - j\frac{\epsilon''}{2\epsilon'}\right).\end{aligned}$$

$$\begin{aligned}\alpha &\approx \frac{\pi\epsilon''}{\lambda_0\sqrt{\epsilon'}} \quad (\text{Np/m}), \\ \beta &\approx \frac{2\pi}{\lambda_0} \sqrt{\epsilon'} \quad (\text{rad/m}).\end{aligned}$$

$$\eta_c \approx \frac{\eta_0}{\sqrt{\epsilon'}} \left(1 + j\frac{\epsilon''}{2\epsilon'}\right)$$

$$\eta_c \approx \frac{\eta_0}{\sqrt{\epsilon'}},$$

Table 2-1: Expressions for α , β , η_c , u_p , and λ for various types of nonmagnetic media.[†]

	Any Medium	Lossless Medium ($\sigma = 0$)	Low-Loss Medium ($\epsilon''/\epsilon' \ll 1$)	Good Conductor ($\epsilon''/\epsilon' \gg 1$)	Units
$\alpha =$	$\omega \left[\frac{\mu_0 \epsilon' \epsilon_0}{2} \left[\sqrt{1 + \left(\frac{\epsilon''}{\epsilon'} \right)^2} - 1 \right] \right]^{1/2}$	0	$\frac{\pi \epsilon''}{\lambda_0 \sqrt{\epsilon'}}$	$\frac{\pi \sqrt{2\epsilon''}}{\lambda_0}$	(Np/m)
$\beta =$	$\omega \left[\frac{\mu_0 \epsilon' \epsilon_0}{2} \left[\sqrt{1 + \left(\frac{\epsilon''}{\epsilon'} \right)^2} + 1 \right] \right]^{1/2}$	$\frac{2\pi \sqrt{\epsilon'}}{\lambda_0}$	$\frac{2\pi \sqrt{\epsilon'}}{\lambda_0}$	$\frac{\pi \sqrt{2\epsilon''}}{\lambda_0}$	(rad/m)
$\eta_c =$	$\sqrt{\frac{\mu_0}{\epsilon' \epsilon_0}} \left(1 - j \frac{\epsilon''}{\epsilon'} \right)^{-1/2}$	$\frac{\eta_0}{\sqrt{\epsilon'}}$	$\frac{\eta_0}{\sqrt{\epsilon'}}$	$\frac{(1+j)\eta_0}{\sqrt{2\epsilon''}}$	(Ω)
$u_p =$	ω/β	$c/\sqrt{\epsilon'}$	$c/\sqrt{\epsilon'}$	$c\sqrt{2/\epsilon''}$	(m/s)
$\lambda =$	$2\pi/\beta = u_p/f$	u_p/f	u_p/f	u_p/f	(m)

Notes: In practice, a material is considered a low-loss medium if $\epsilon''/\epsilon' < 0.01$ and a good conducting medium if $\epsilon''/\epsilon' > 100$; $c = 3 \times 10^8$ m/s; $\eta_0 = 377 \Omega$.

Some helpful definitions

- **Angular frequency** – radians per unit time
- **Intrinsic impedance** – relation between H and E fields in EM wave
- **Transverse EM** – no H or E in wave propagation direction
- **Wavenumber** – wave cycles (or radians) per unit distance
- **Phase velocity** – velocity of the phase component
- **Propagation constant** – measure of change in phase and amplitude of propagating wave
- **Permittivity** – measure of material ability to resist electric field
- **Permeability** – measure of material ability to support formation of magnetic field



Can you define?

- **Angular frequency**
- **Intrinsic impedance**
- **Transverse EM**
- **Wavenumber**
- **Phase velocity**
- **Propagation constant**
- **Permittivity**
- **Permeability**



A?

Aalto University
School of Electrical
Engineering

E4230

Microwave EO Instrumentation

Take a break



Polarization

The polarization of a uniform plane wave describes the locus traced by the tip of the E vector (in the plane orthogonal to the direction of propagation) at a given point in space as a function of time.

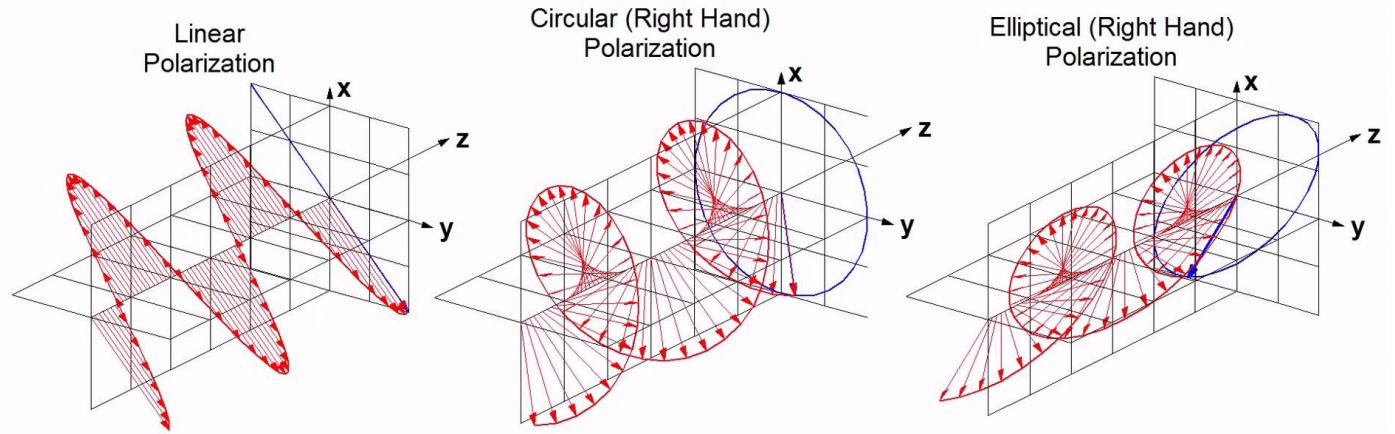
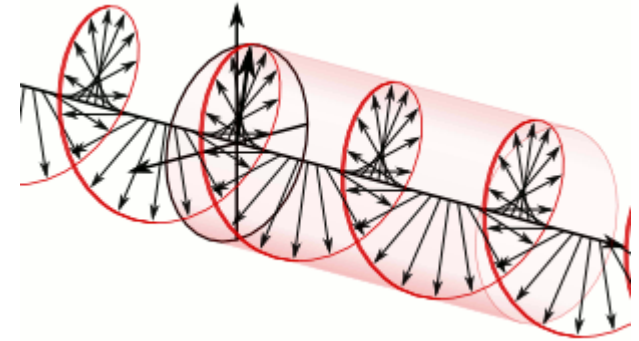

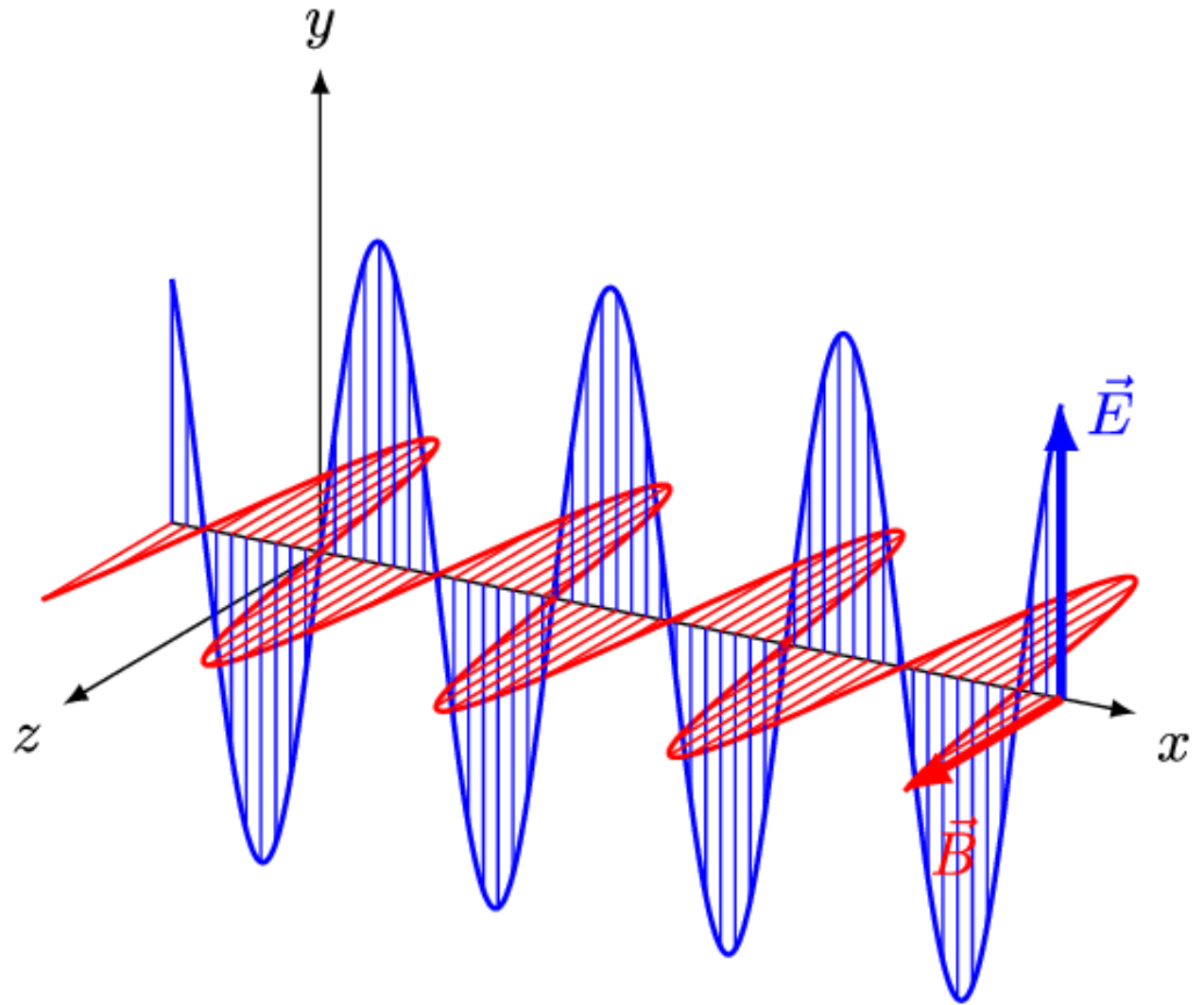

$$\mathbf{E}(z) = \hat{\mathbf{x}}E_x(z) + \hat{\mathbf{y}}E_y(z)$$

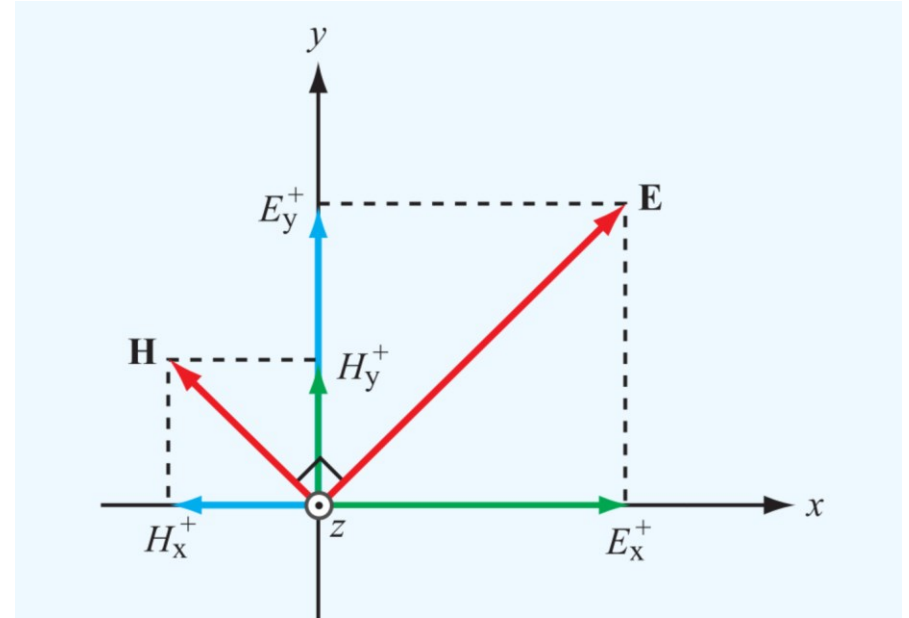

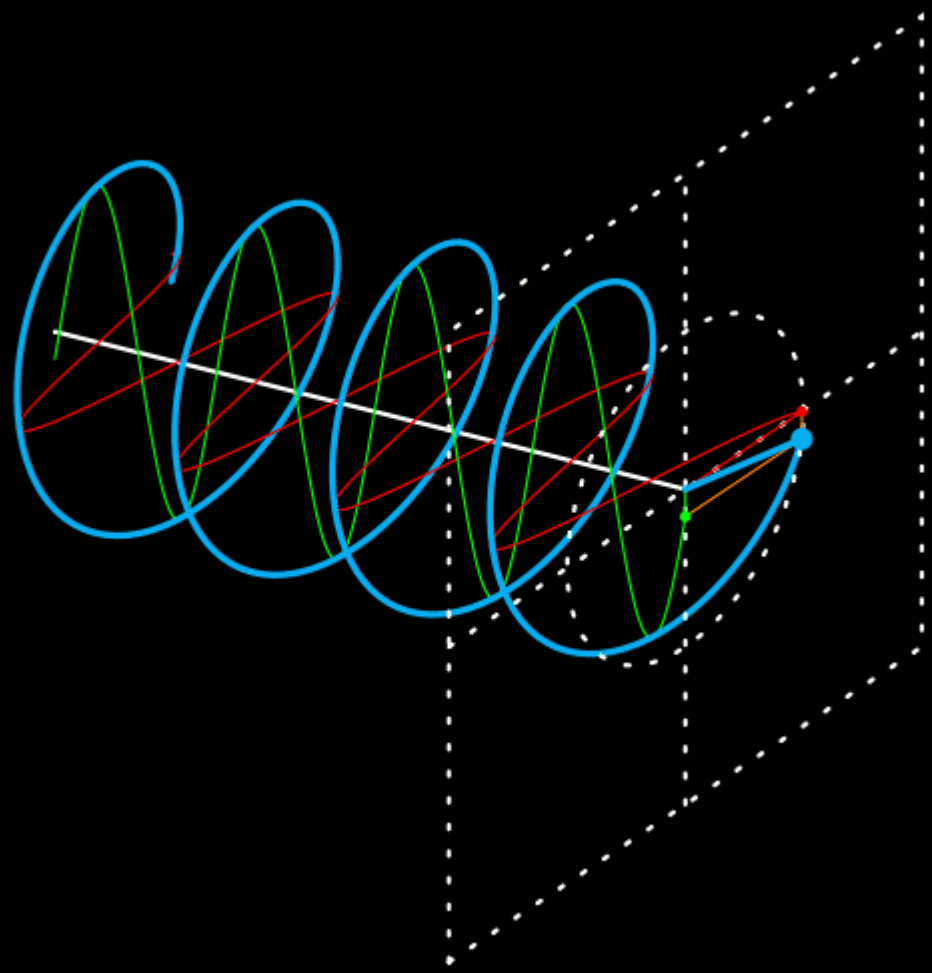

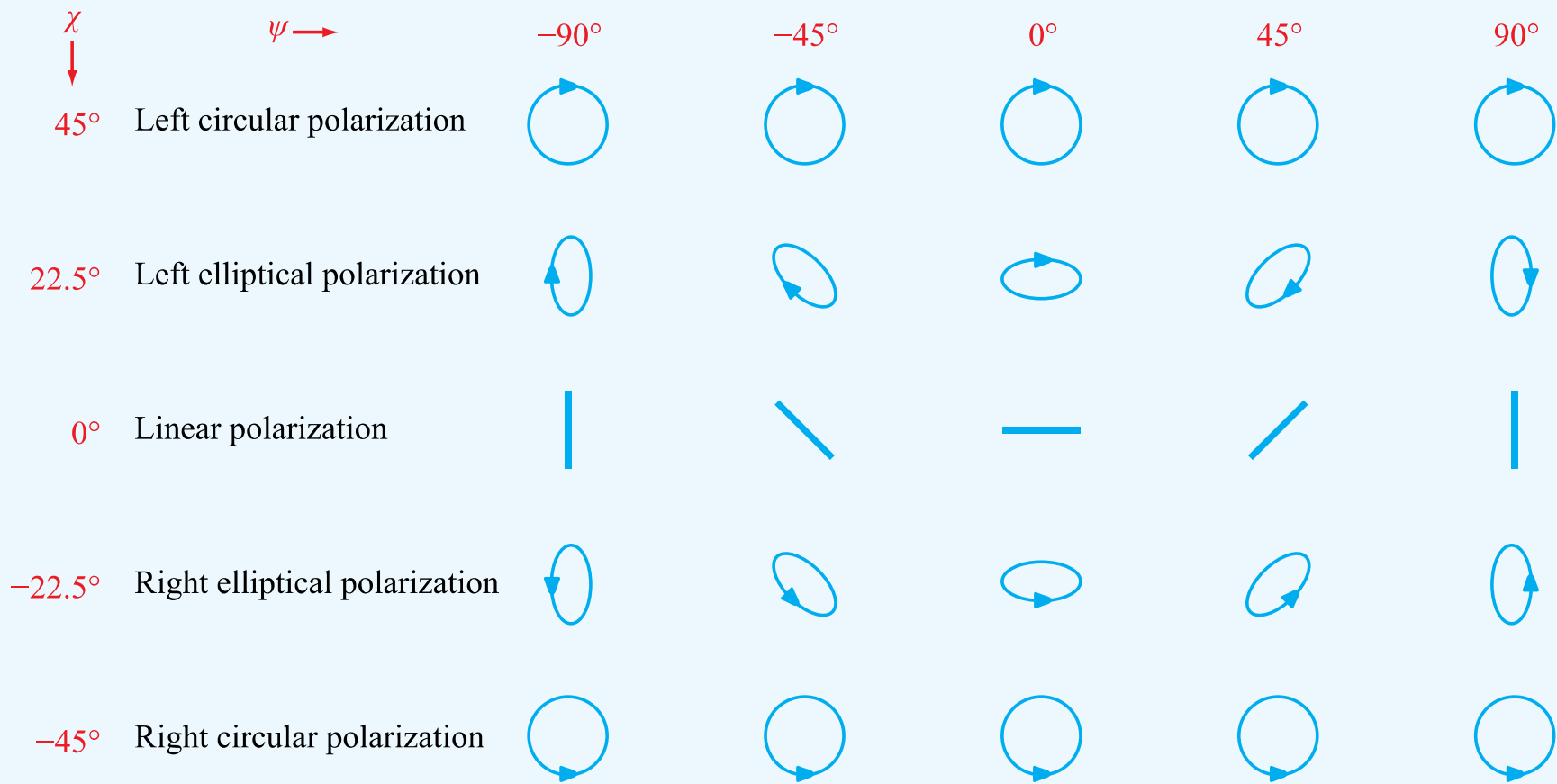

(ψ, χ)

A?

Aalto University
School of Electrical
Engineering

E4230

Microwave EO Instrumentation

Take a break



Wave reflection and transmission

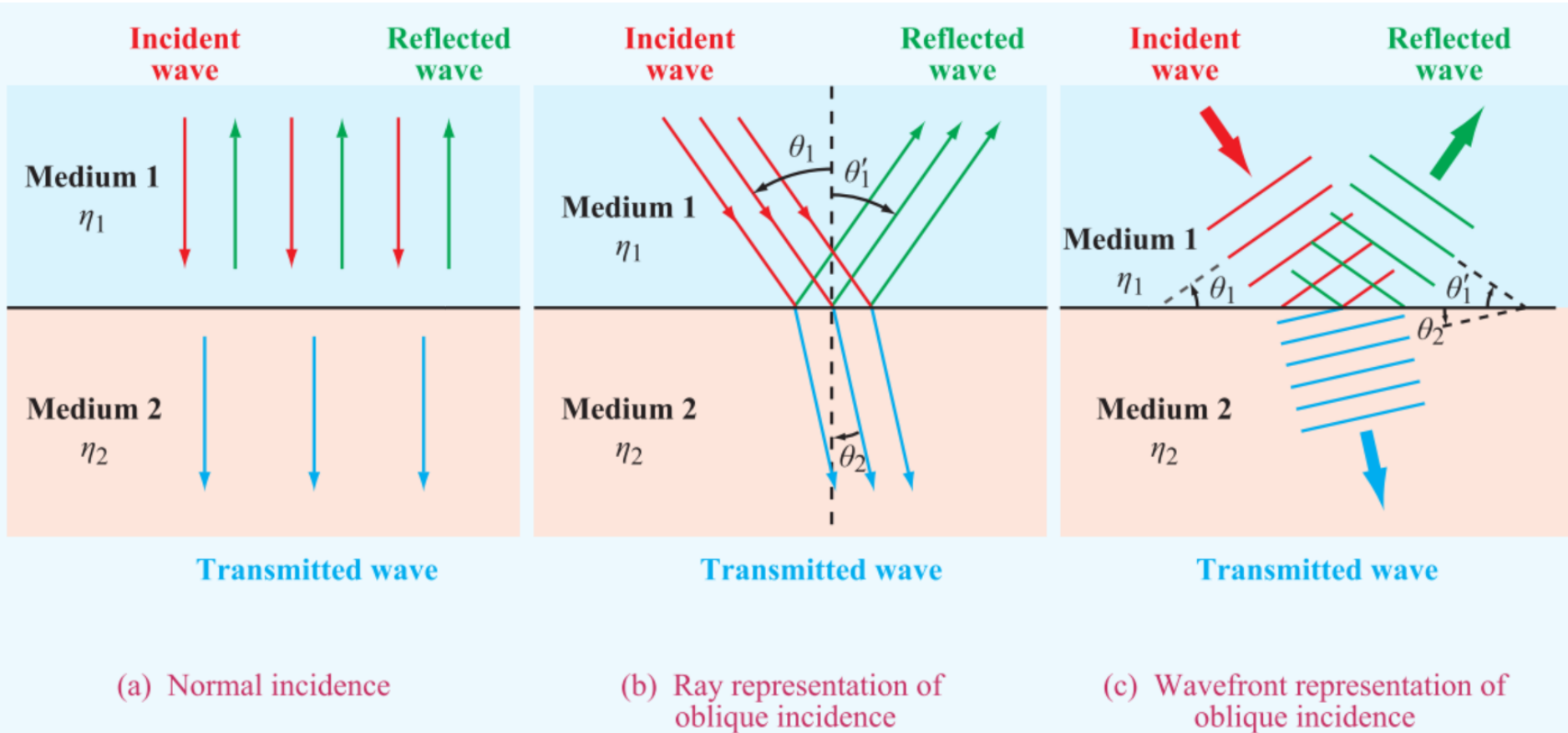

Figure 2-12: Ray representation of wave reflection and transmission at (a) normal incidence and (b) oblique incidence, and (c) wavefront representation of oblique incidence.

Reflection/Transmission Normal Incidence

$$E_0^r = \left(\frac{\eta_2 - \eta_1}{\eta_2 + \eta_1} \right) E_0^i = \rho E_0^i, \quad (2.87a)$$

$$E_0^t = \left(\frac{2\eta_2}{\eta_2 + \eta_1} \right) E_0^i = \tau E_0^i, \quad (2.87b)$$

where

$$\rho = \frac{E_0^r}{E_0^i} = \frac{\eta_2 - \eta_1}{\eta_2 + \eta_1} \quad (\text{normal incidence}), \quad (2.88a)$$

$$\tau = \frac{E_0^t}{E_0^i} = \frac{2\eta_2}{\eta_2 + \eta_1} \quad (\text{normal incidence}). \quad (2.88b)$$

The quantities ρ and τ are called the Fresnel reflection and transmission coefficients

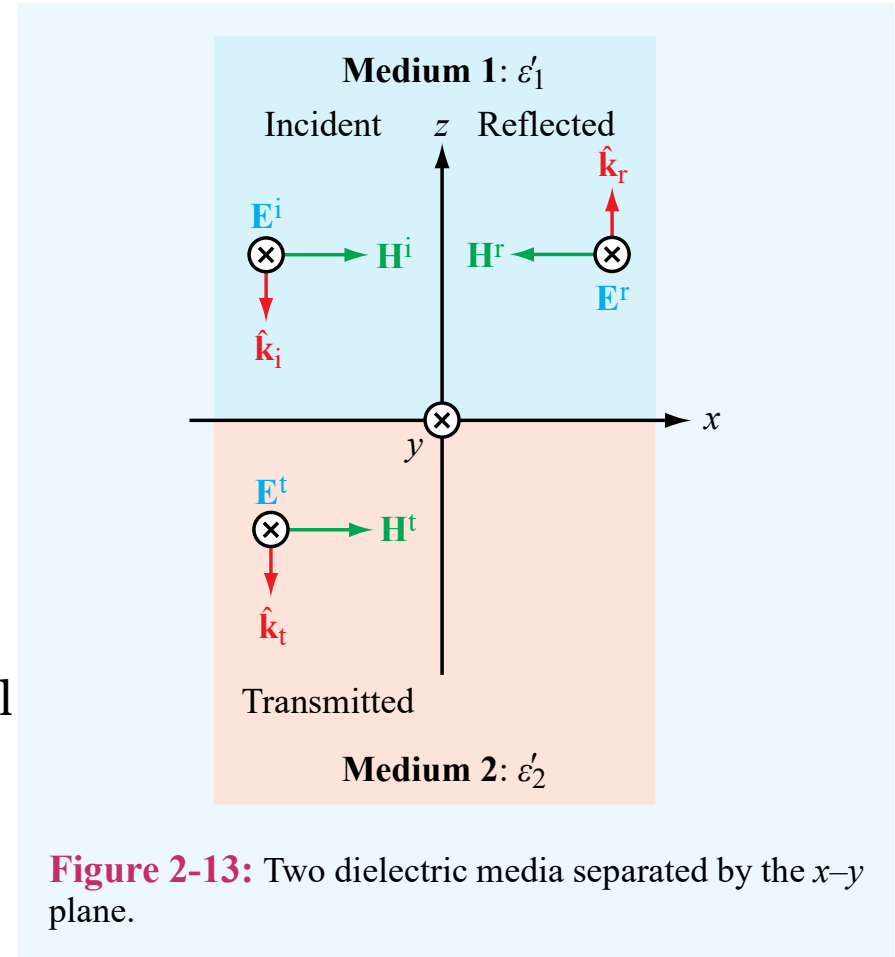

Figure 2-13: Two dielectric media separated by the x - y plane.

Refraction

angles are interrelated by *Snell's laws*:

$$\theta_1 = \theta_1' \quad (\text{Snell's law of reflection}),$$

$$\frac{\sin \theta_2}{\sin \theta_1} = \frac{u_{p2}}{u_{p1}} = \sqrt{\frac{\epsilon_1'}{\epsilon_2'}} \quad (2.95)$$

(Snell's law of refraction),

$$\sin \theta_c = \frac{n_2}{n_1} \sin \theta_2 \Big|_{\theta_2 = \pi/2} = \frac{n_2}{n_1} = \sqrt{\frac{\epsilon_2'}{\epsilon_1'}}.$$

(critical angle)

Inward refraction

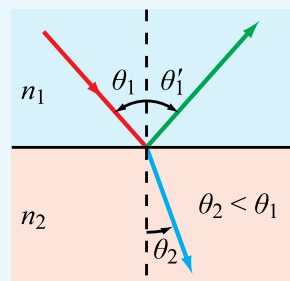

(a) $n_1 < n_2$

Outward refraction

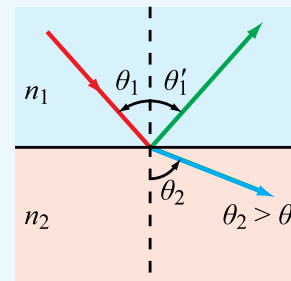

(b) $n_1 > n_2$

No transmission

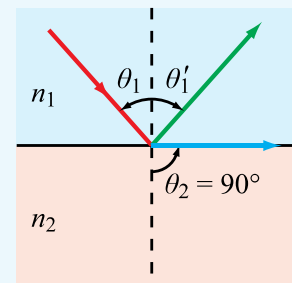

(c) $n_1 > n_2$ and $\theta_1 = \theta_c$

$$\theta = \left(\frac{\theta'}{n_1} \right) \quad \theta > \theta'$$

$$\theta = \left(\frac{\theta'}{n_2} \right) \quad \theta < \theta'$$

$$\theta' = \theta <$$

H and V Polarizations

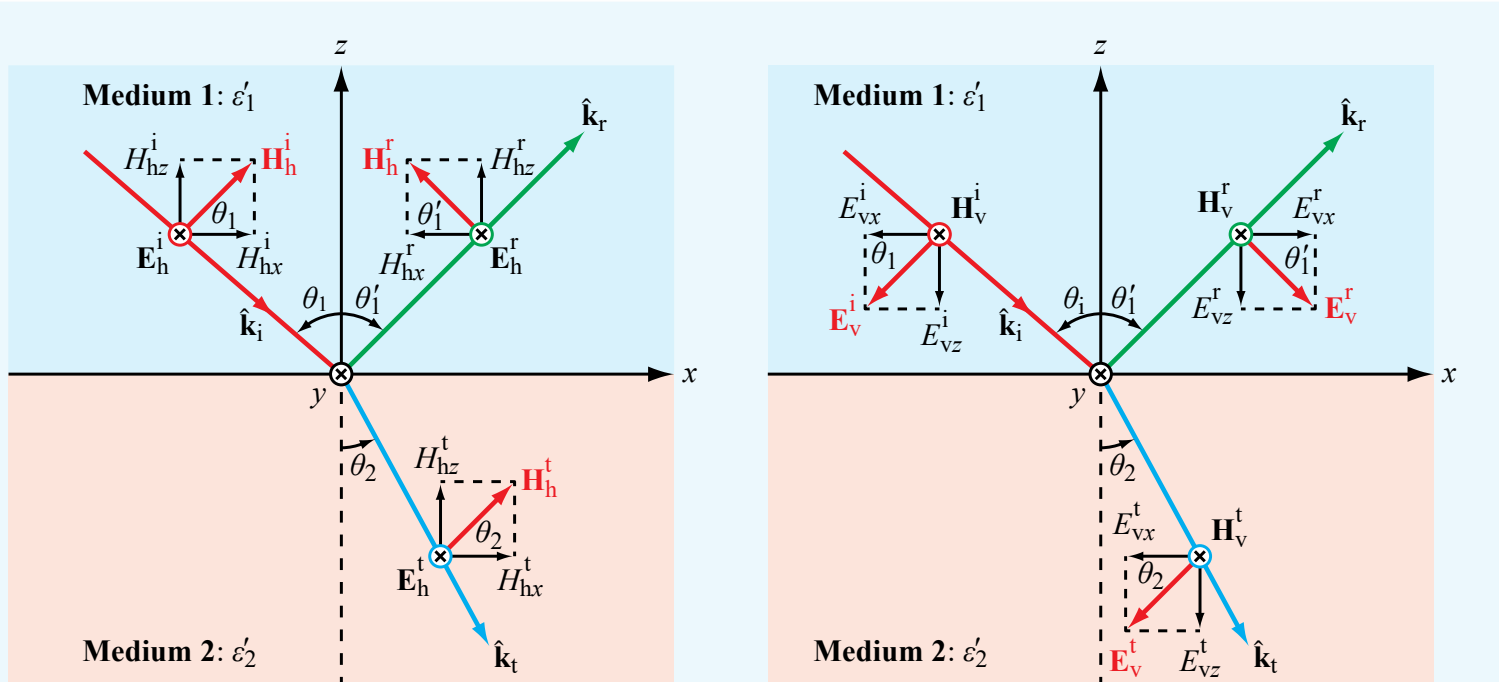

(a) Horizontal polarization

(b) Vertical polarization

Figure 2-16: The plane of incidence is the plane containing the direction of wave travel, $\hat{\mathbf{k}}_i$, and the surface normal to the boundary. In the present case the plane of incidence containing $\hat{\mathbf{k}}_i$ and $\hat{\mathbf{z}}$ coincides with the plane of the paper. A wave is a) perpendicularly polarized (also called *horizontally polarized*) when its electric field vector is perpendicular to the plane of incidence and (b) parallel polarized (also called *vertically polarized*) when its electric field vector lies in the plane of incidence.

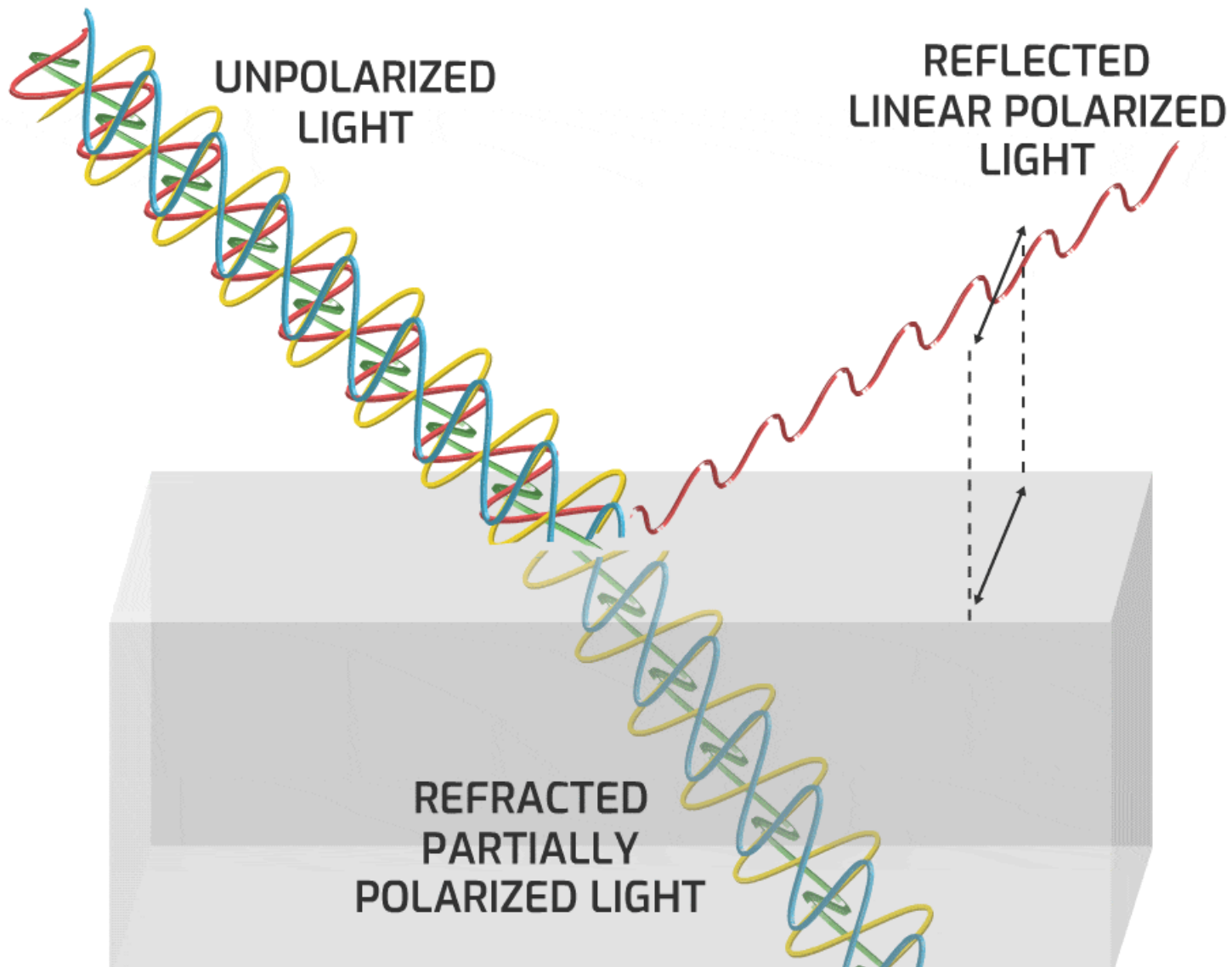

H Polarization

$$\rho_h = \frac{E_{h0}^r}{E_{h0}^i} = \frac{\eta_2 \cos \theta_1 - \eta_1 \cos \theta_2}{\eta_2 \cos \theta_1 + \eta_1 \cos \theta_2},$$

$$\tau_h = \frac{E_{h0}^t}{E_{h0}^i} = \frac{2\eta_2 \cos \theta_1}{\eta_2 \cos \theta_1 + \eta_1 \cos \theta_2}.$$

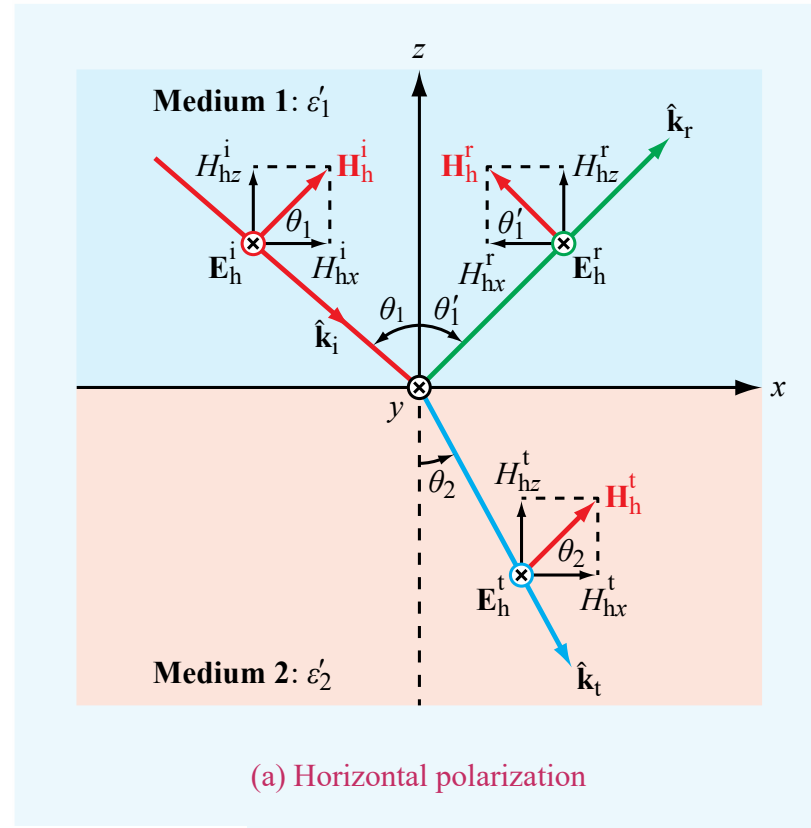

$$\mathbf{E}_h^i = \hat{y} E_{h0}^i e^{-jk_1(x \sin \theta_1 - z \cos \theta_1)},$$

$$\mathbf{H}_h^i = (\hat{x} \cos \theta_1 + \hat{z} \sin \theta_1) \frac{E_{h0}^i}{\eta_1} e^{-jk_1(x \sin \theta_1 - z \cos \theta_1)},$$

V Polarization

$$\mathbf{E}_v^i = (-\hat{\mathbf{x}} \cos \theta_1 - \hat{\mathbf{z}} \sin \theta_1) E_{v0}^i e^{-jk_1(x \sin \theta_1 - z \cos \theta_1)}$$

$$\mathbf{H}_v^i = \hat{\mathbf{y}} \frac{E_{v0}^i}{\eta_1} e^{-jk_1(x \sin \theta_1 - z \cos \theta_1)}$$

$$\rho_v = \frac{E_{v0}^r}{E_{v0}^i} = \frac{\eta_2 \cos \theta_2 - \eta_1 \cos \theta_1}{\eta_2 \cos \theta_2 + \eta_1 \cos \theta_1},$$

$$\tau_v = \frac{E_{v0}^t}{E_{v0}^i} = (1 + \rho_v) \frac{\cos \theta_1}{\cos \theta_2}.$$

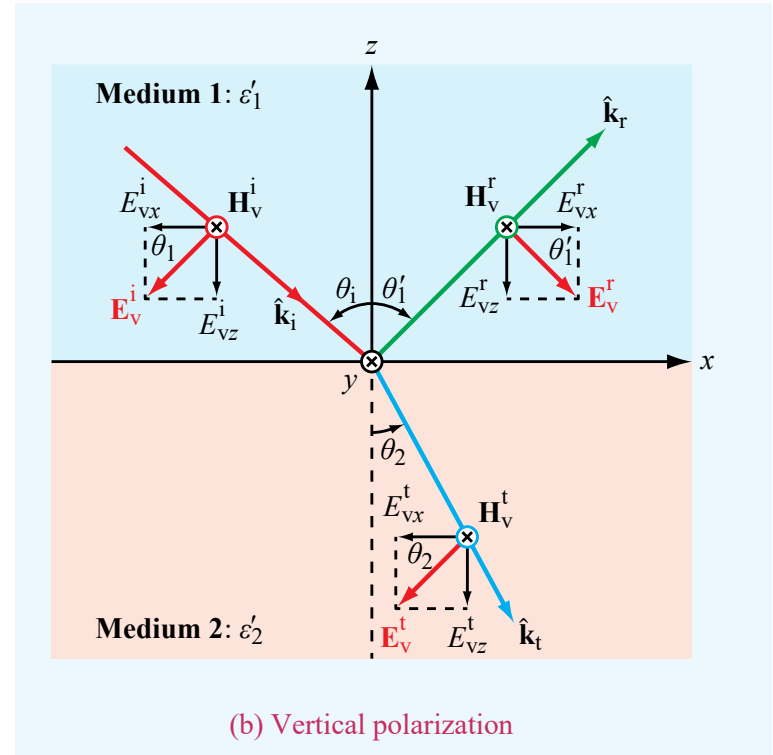

Reflection Coefficient

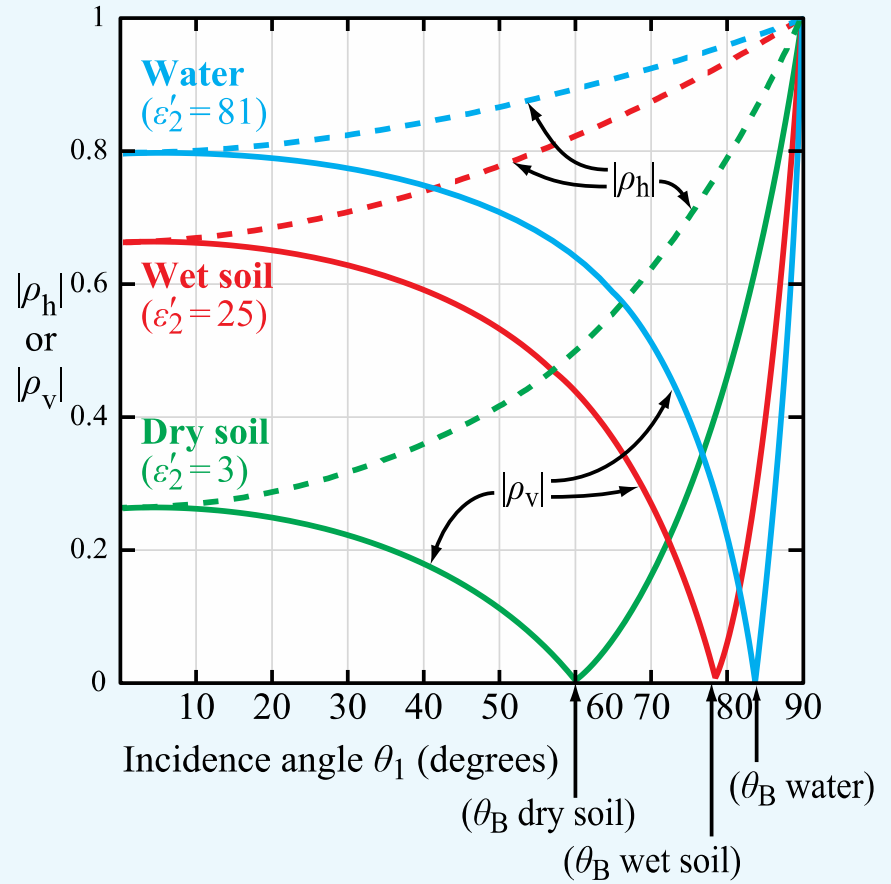

$$|\rho| = \frac{|\rho_h| + |\rho_v|}{2}$$

Role of Loss Factor

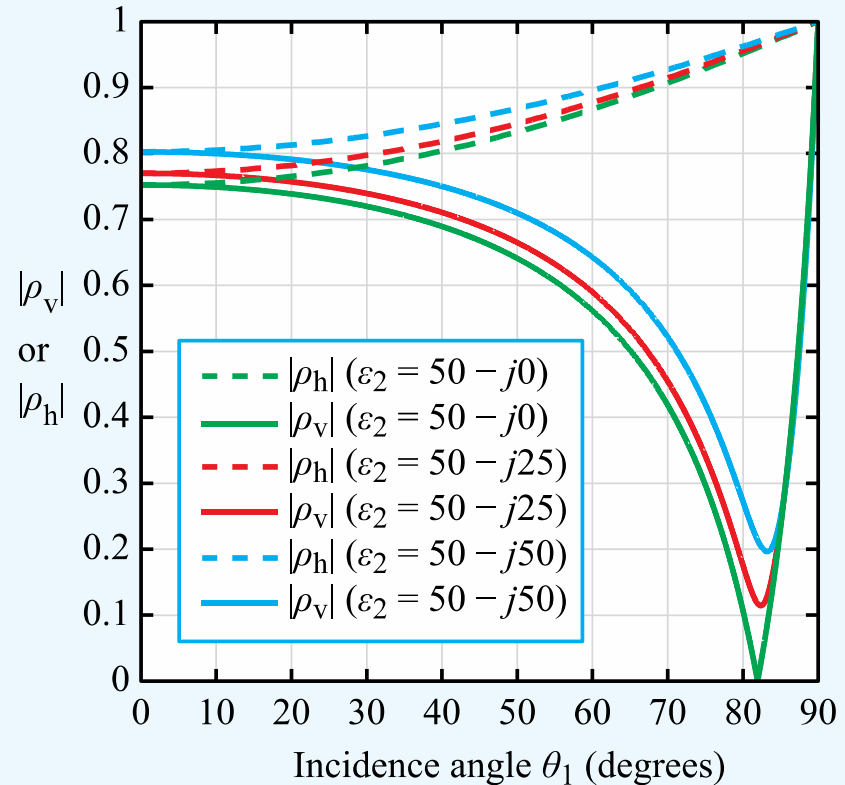

$$\frac{|\rho|}{\epsilon} = \frac{\epsilon' - \epsilon''}{\epsilon' + \epsilon''}$$

Layered Media

- **Medium 1:** ϵ'_1 , μ_0 , and $\sigma_1 = 0$

$$\rightarrow \alpha_1 = 0, \quad \gamma_1 = jk_1 = j \frac{2\pi}{\lambda_0} \sqrt{\epsilon'_1}, \quad (2.115a)$$

$$\eta_1 = \frac{\eta_0}{\sqrt{\epsilon'_1}} \quad (2.115b)$$

- **Medium 2:** $\epsilon_2 = \epsilon'_2 - j\epsilon''_2$ and μ_0

$$\rightarrow \gamma_2 = \alpha_2 + j\beta_2 \quad (\text{see Table 2-1}), \quad (2.116a)$$

$$\eta_2 = \frac{\eta_0}{\sqrt{\epsilon_2}}. \quad (2.116b)$$

If medium 2 is low-loss (i.e., $\epsilon''_2/\epsilon'_2 \ll 1$), then

$$\alpha_2 \approx \frac{\pi}{\lambda_0} \frac{\epsilon''_2}{\sqrt{\epsilon'_2}}, \quad \beta_2 \approx \frac{2\pi}{\lambda_0} \sqrt{\epsilon'_2}. \quad (2.116c)$$

- **Medium 3:** $\epsilon_3 = \epsilon'_3 - j\epsilon''_3$ and μ_0

$$\rightarrow \gamma_3 = \alpha_3 + j\beta_3 \quad (\text{see Table 2-1}), \quad (2.117)$$

$$\eta_3 = \frac{\eta_0}{\sqrt{\epsilon_3}}. \quad (2.118)$$

- (b) Snell's Law Phase-Matching Condition

$$\bullet \gamma_1 \sin \theta_1 = \gamma_2 \sin \theta_2 = \gamma_3 \sin \theta_3 \quad (2.119a)$$

$$\rightarrow \cos \theta_2 = \left[1 - \left(\frac{\gamma_1}{\gamma_2} \sin \theta_1 \right)^2 \right]^{1/2} \quad (2.119b)$$

$$\approx \left[1 - \left(\frac{\beta_1}{\beta_2} \sin \theta_1 \right)^2 \right]^{1/2} \quad (2.119c)$$

if medium 2 is low loss

$$\cos \theta_3 = \left[1 - \left(\frac{\gamma_1}{\gamma_3} \sin \theta_1 \right)^2 \right]^{1/2}. \quad (2.120)$$

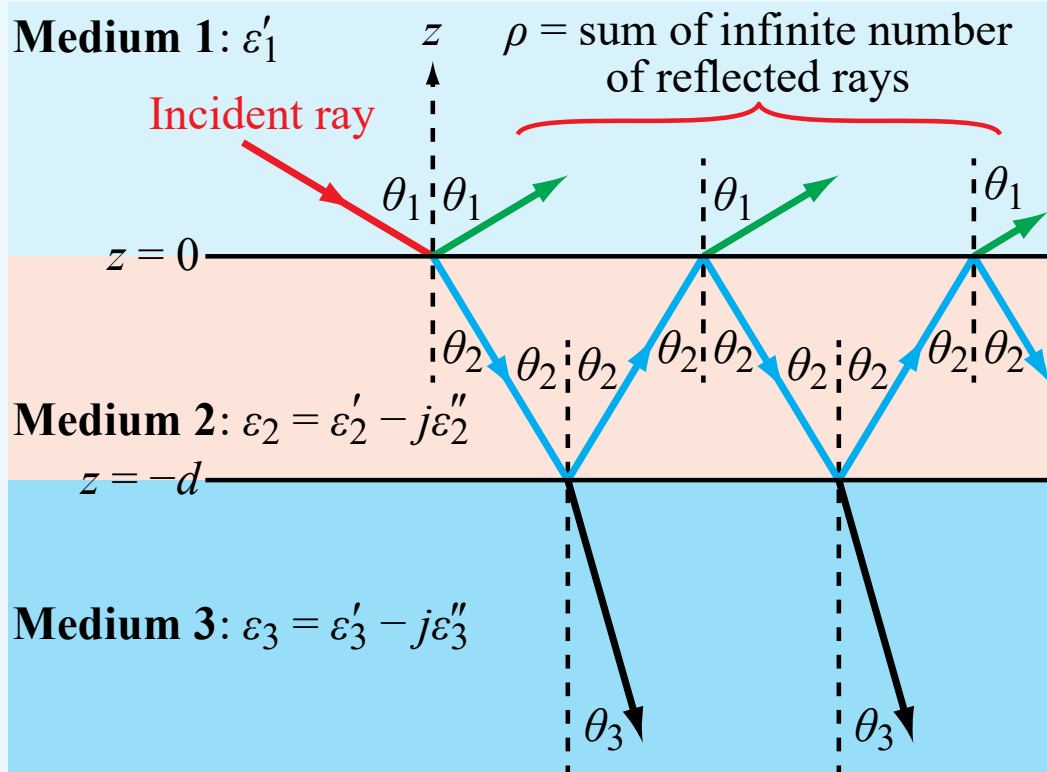
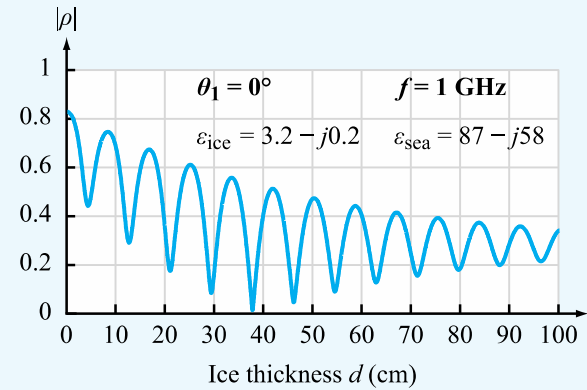

Figure 2-20: Multiple reflections in a two-layer composite.

Air over ice over water

1. Note **oscillatory** behavior as a function of ice thickness

2. Note Polarization behavior near **Brewster** angle



(a) $|\rho|$ versus d

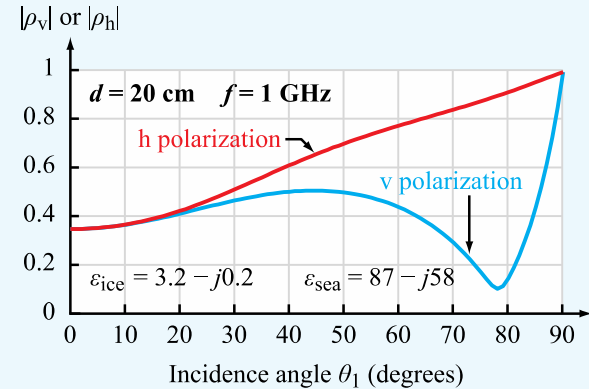

(b) $|\rho_v|$ and $|\rho_h|$ versus θ

$$\begin{array}{ccc} |\rho| & & \\ \theta & & |\rho| \quad |\rho| \end{array}$$

A?

Aalto University
School of Electrical
Engineering

E4230

Microwave EO Instrumentation

Take a break





Aalto University
School of Electrical
Engineering

EM wave in volume

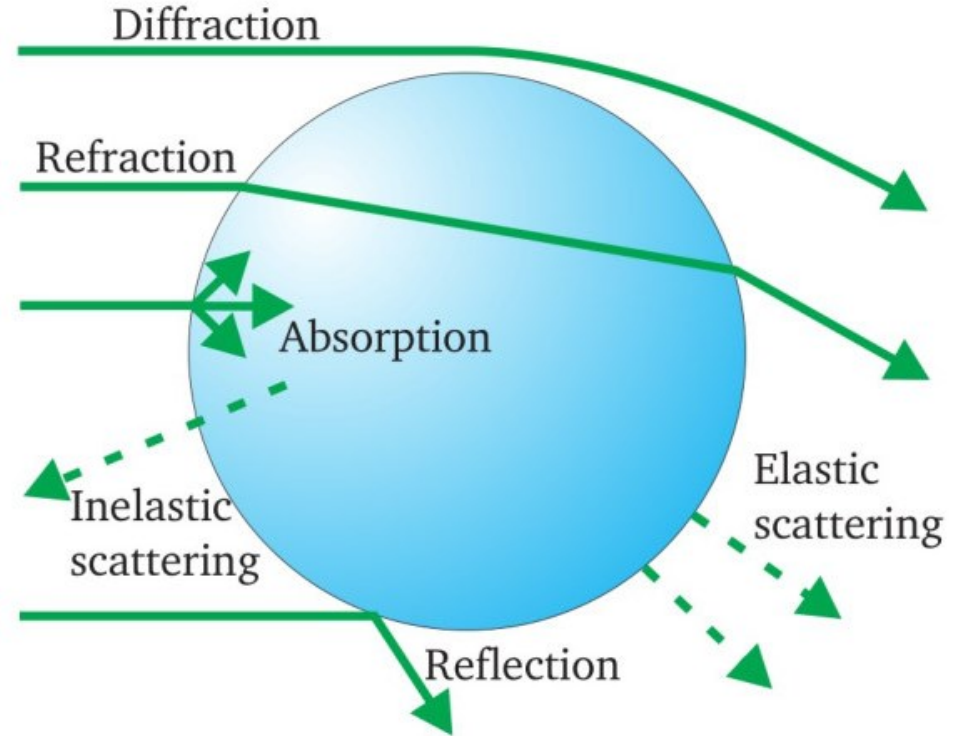

Emission: All substances at finite temperatures radiate EM energy

Absorption: Energy into heat

Scattering: Energy to other directions due to particles in the propagation path

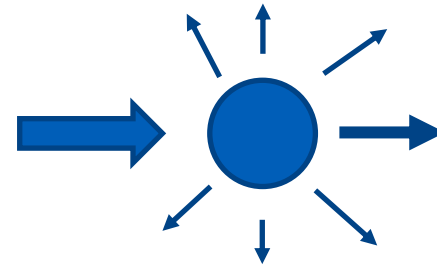
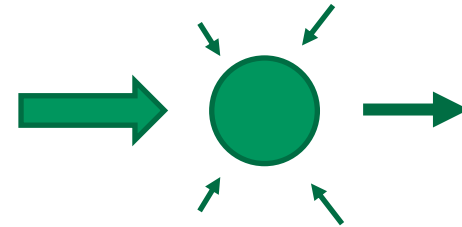
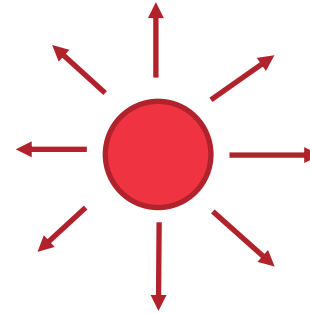

Absorption

Oxygen and water vapor are the **only atmospheric constituents** that exhibit **significant absorption** bands in the microwave spectrum.

Conduction takes EM radiation energy and contributes it to temperature of the body. The body emits energy according to its temperature. Energy is transferred to another frequency.

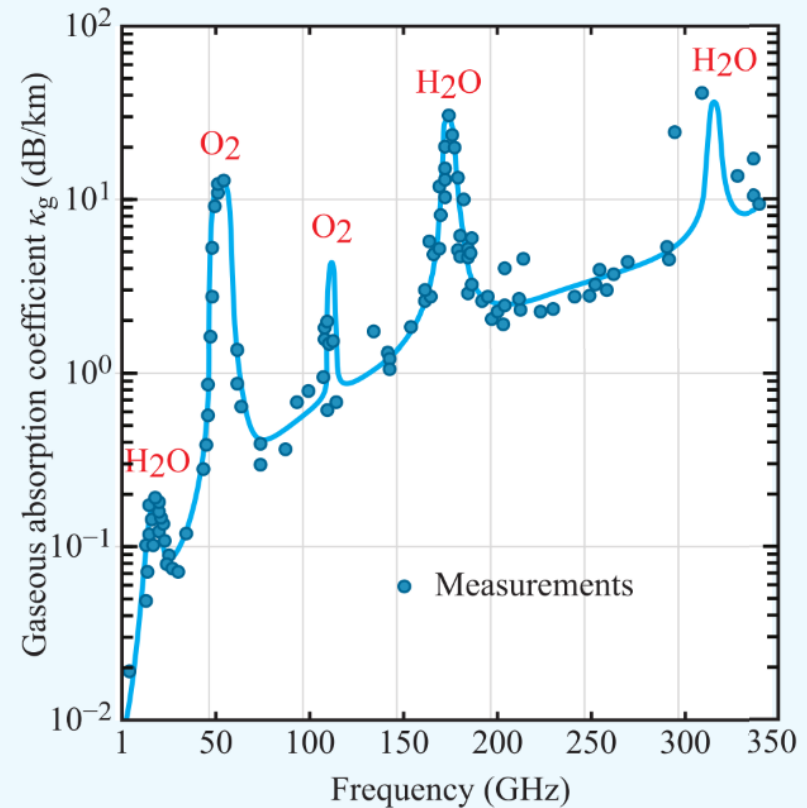
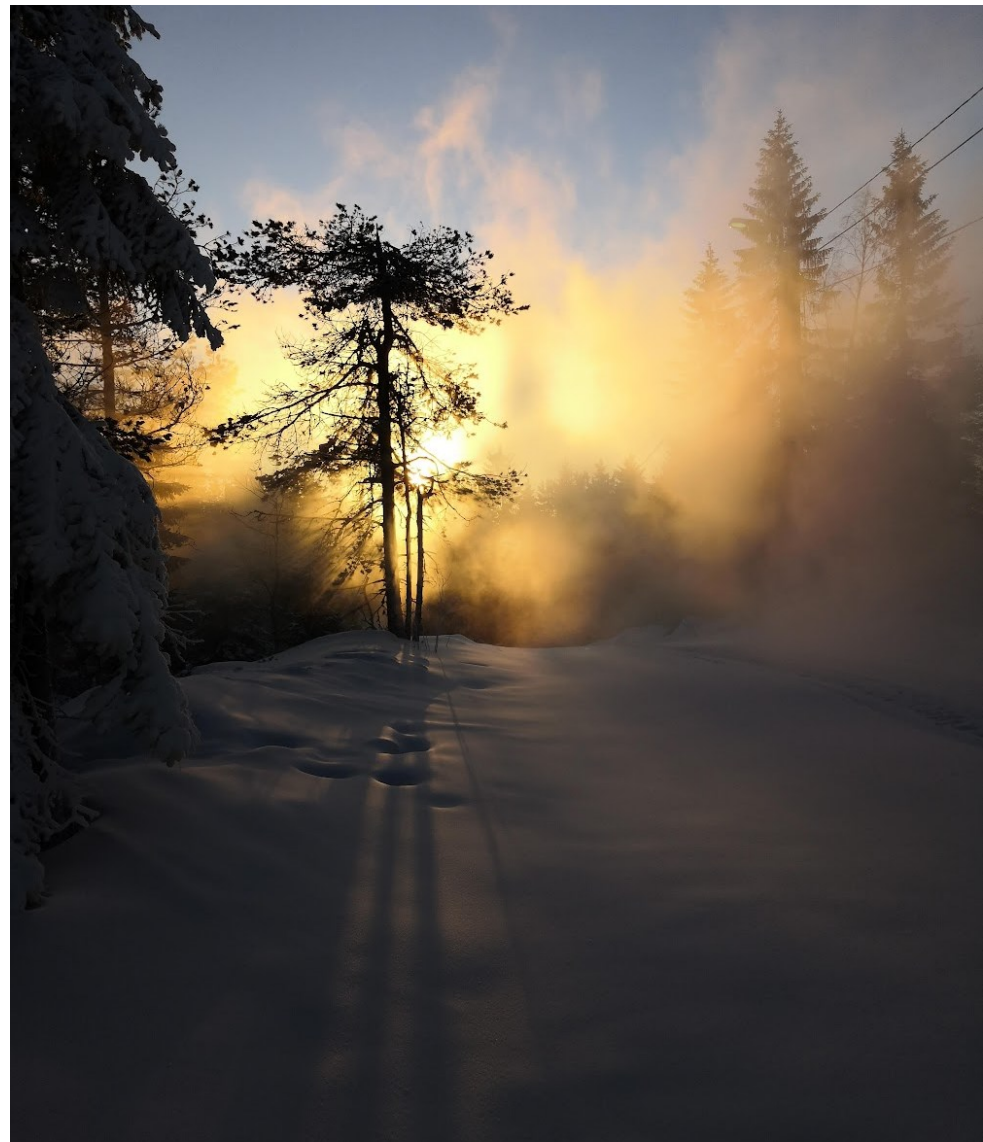

Figure 8-8: Microwave absorption spectrum due to atmospheric gases, $\kappa_g(f)$, at sea level for surface conditions $P_0 = 1013$ mb, $T_0 = 293$ K, and $\rho_0 = 7.5$ g/m³. Solid curves are calculated according to theory, and dots are measured values [Crane, 1981].



Aalto University
School of Electrical
Engineering

Scattering



Scattering

In scattering the direction of the radiation is altered, usually because of series of reflections, and the direction information is lost.

But what happens is the object is smaller than wavelength?

Mie Scattering

Mie derived equations for scattering and absorption of electromagnetic waves by dielectric sphere of arbitrary radius 1908.

normalized circumference χ and relative index of refraction n

$$\chi = k_b r = \frac{2\pi r}{\lambda_b} = \frac{2\pi r}{\lambda_0} \sqrt{\epsilon'_b}$$

$$n = \frac{n_p}{n_b} = \left(\frac{\epsilon_p}{\epsilon_b} \right)^{1/2} = \epsilon^{1/2},$$

Mie's solution lead to expressions for the scattering and extinction efficiencies

$$\xi_s(n, \chi) = \frac{2}{\chi^2} \sum_{l=1}^{\infty} (2l+1) (|a_l|^2 + |b_l|^2),$$
$$\xi_e(n, \chi) = \frac{2}{\chi^2} \sum_{l=1}^{\infty} (2l+1) \Re\{a_l + b_l\},$$

Where a_l and b_l are Mie coefficients

$$a_l = \frac{\left(\frac{A_l}{n} + \frac{l}{\chi}\right) \Re\{W_l\} - \Re\{W_{l-1}\}}{\left(\frac{A_l}{n} + \frac{l}{\chi}\right) W_l - W_{l-1}}$$
$$b_l = \frac{\left(nA_l + \frac{l}{\chi}\right) \Re\{W_l\} - \Re\{W_{l-1}\}}{\left(nA_l + \frac{l}{\chi}\right) W_l - W_{l-1}}$$

Rayleigh Scattering

When the particle size is much smaller than incident wave, Rayleigh approximation can be used.

The corresponding scattering and absorption cross sections Q_s and Q_a

$$Q_s = \frac{2\lambda^2}{3\pi} \chi^6 |K|^2,$$
$$Q_a = \frac{\lambda^2}{\pi} \chi^3 \Im\{-K\}.$$

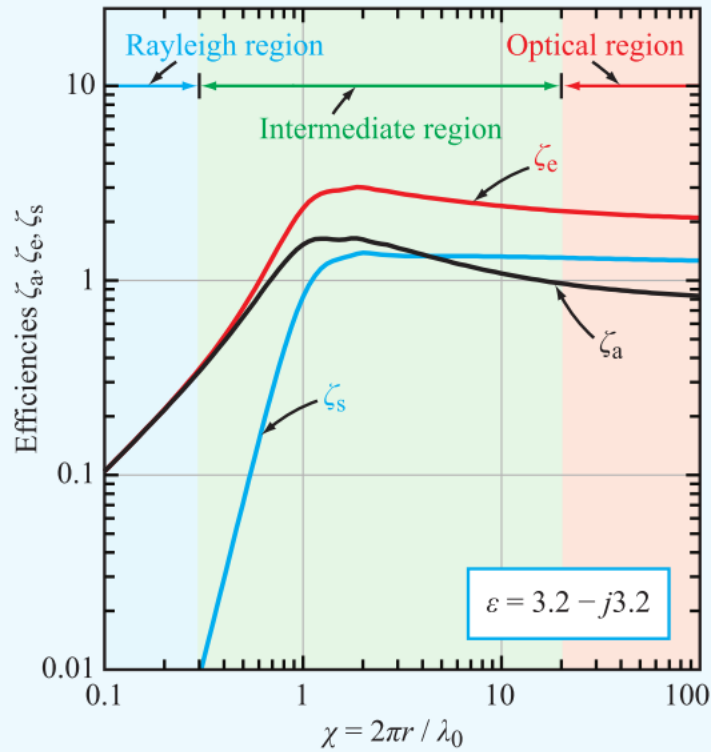

Figure 8-19: Calculated extinction, absorption, and scattering efficiencies as a function of χ for a sphere with $\epsilon = 3.2(1 - j1)$.

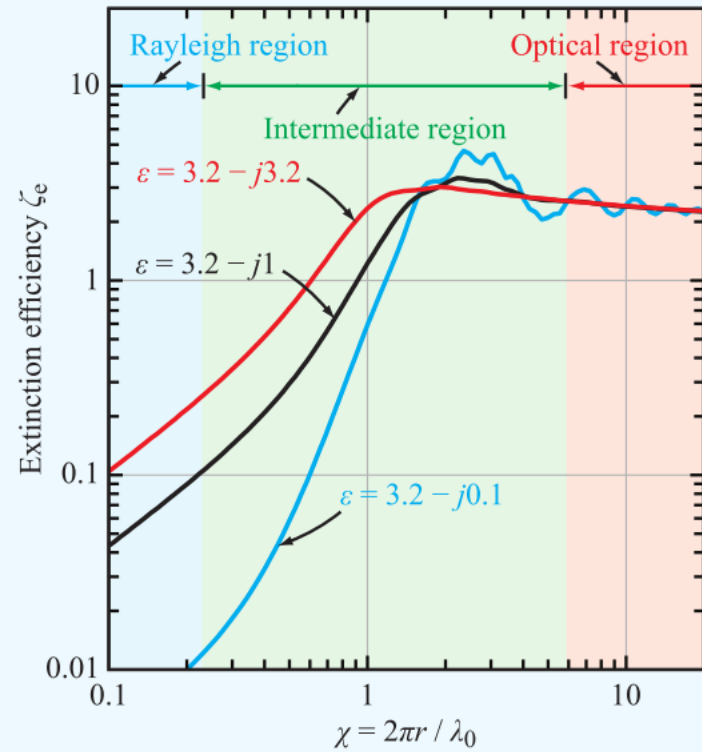

Figure 8-20: The role of ϵ''/ϵ' .

A?

Aalto University
School of Electrical
Engineering

E4230

Microwave EO Instrumentation

Take a break





Aalto University
School of Electrical
Engineering

Microwave Dielectric Properties of Natural Earth Materials

Chapter 4 in course textbook



Terms Describing Natural Media

Term	Explanation / Example	Opposite / Example
Homogeneous	Characteristics (ϵ , μ , σ) remain the same independent of location (pure water)	Nonhomogeneous (snow = ice+air+water)
Isotropic	Characteristics (ϵ , μ , σ) do not depend on direction (water)	Anisotropic (sea ice has brine liquid pockets, mostly vertical)

Propagation, absorption and phase constants

Relative dielectric constant or permittivity

$$\varepsilon = \varepsilon' - j\varepsilon''$$

index of refraction

$$\varepsilon = n^2.$$

$$n = n' - jn''$$

$$\varepsilon' = (n')^2 - (n'')^2, \quad \varepsilon'' = 2n'n'',$$

$$n' = \Re\{\sqrt{\varepsilon}\}, \quad n'' = -\Im\{\sqrt{\varepsilon}\}.$$

$$E(z) = E_0 \exp(-\gamma z)$$

Propagation constant

$$\gamma = \alpha + j\beta$$

Propagation constant
Phase constant

$$\alpha = k_0 n'' = -k_0 \Im\{\sqrt{\varepsilon}\} \quad \text{Np/m,}$$

$$\beta = k_0 n' = k_0 \Re\{\sqrt{\varepsilon}\} \quad \text{rad/m,}$$



Debye Equation for Pure Water

ϵ_{w0} = relative static permittivity of water = $f(T)$; T = temperature

$\epsilon_{w\infty}$ = high-frequency limit for water relative permittivity ~ 4.9

τ_w = relaxation time for water = $f(T)$

f = frequency

ϵ_w' has its max. value at low freq.

ϵ_w'' obtains its maximum value $\frac{1}{2} (\epsilon_{w0} - \epsilon_{w\infty})$ at $f = 1/(2\pi f \tau_w)$;

then ϵ_w' is at half-way of its whole range $\epsilon_{w0} - \epsilon_{w\infty}$

$$\epsilon_w = \epsilon_w' - j \epsilon_w''$$

$$\epsilon_w = \epsilon_{w\infty} + \frac{\epsilon_{w0} - \epsilon_{w\infty}}{1 + j2\pi f \tau_w}$$

$$\epsilon_w' = \epsilon_{w\infty} + \frac{\epsilon_{w0} - \epsilon_{w\infty}}{1 + (2\pi f \tau_w)^2}$$

$$\epsilon_w'' = \frac{2\pi f \tau_w (\epsilon_{w0} - \epsilon_{w\infty})}{1 + (2\pi f \tau_w)^2}$$

Permittivity of water

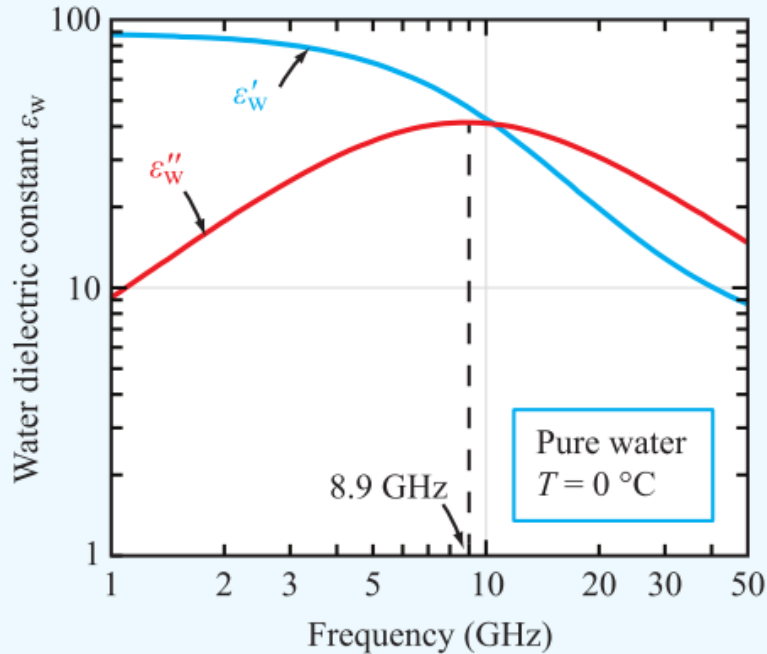

(a) $T = 0\text{ }^\circ\text{C}$

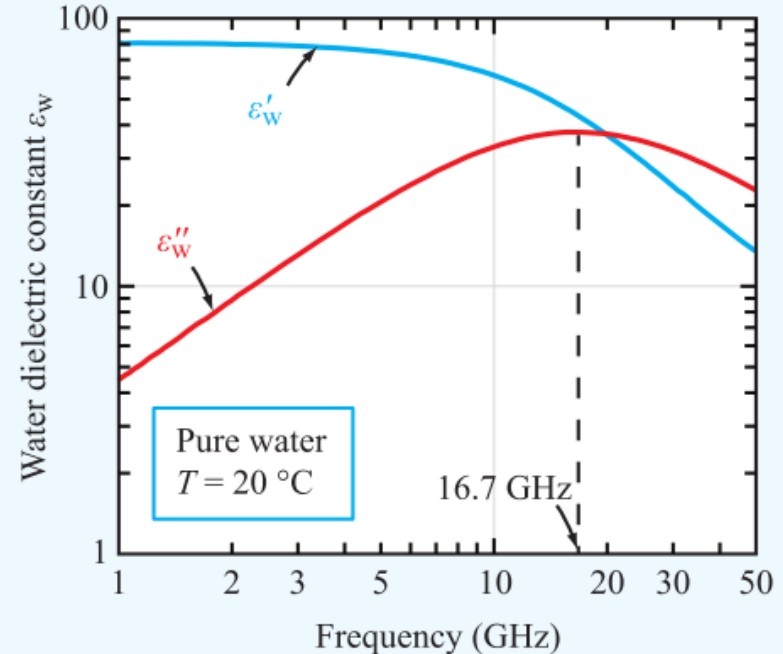

(b) $T = 20\text{ }^\circ\text{C}$

Figure 4-1: Microwave spectra of the permittivity and dielectric loss factor of pure water at (a) $0\text{ }^\circ\text{C}$ and (b) $20\text{ }^\circ\text{C}$.

Permittivity of vegetation

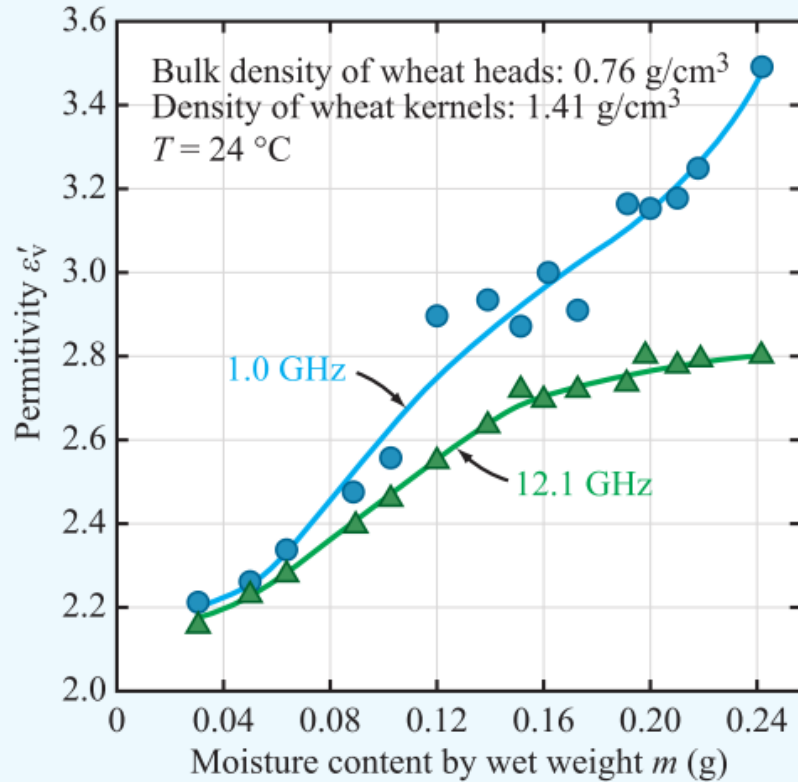

(a) Permittivity ϵ'_v

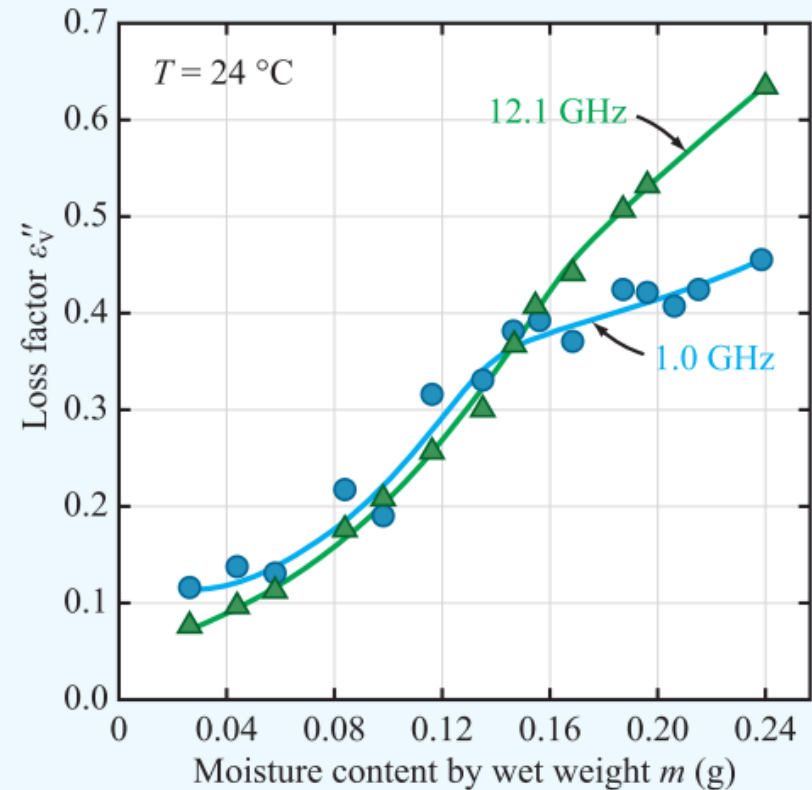

(b) Loss factor ϵ''_v



Debye Equation for Sea Water

- Sea water contains salts => conduction losses

$$\epsilon_{sw}'' = \frac{2\pi\tau_{sw}(\epsilon_{sw0} - \epsilon_{sw\infty})}{1 + (2\pi f\tau_{sw})^2} + \frac{\sigma_i}{2\pi f\epsilon_0}$$

- σ_i = conductivity
- Subscript sw: sea water
- $\epsilon_{sw0} = f(T, S)$
- $\tau_{sw} = f(T, S)$
- $\sigma_i = f(T, S)$
- Conductivity loss is the higher the lower the frequency is
- Oceans: $S \sim 35$ ppt
- Gulf of Finland (brackish water) : $S \sim 5$ ppt

Sea Surface Salinity (SSS) values

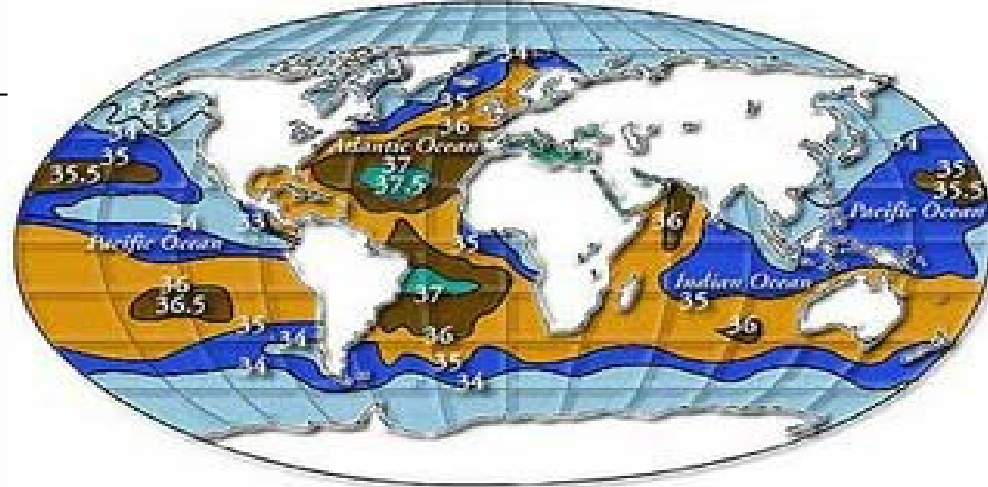



Aalto University
School of Electrical
Engineering

Antennas

Chapter 3 in the course textbook

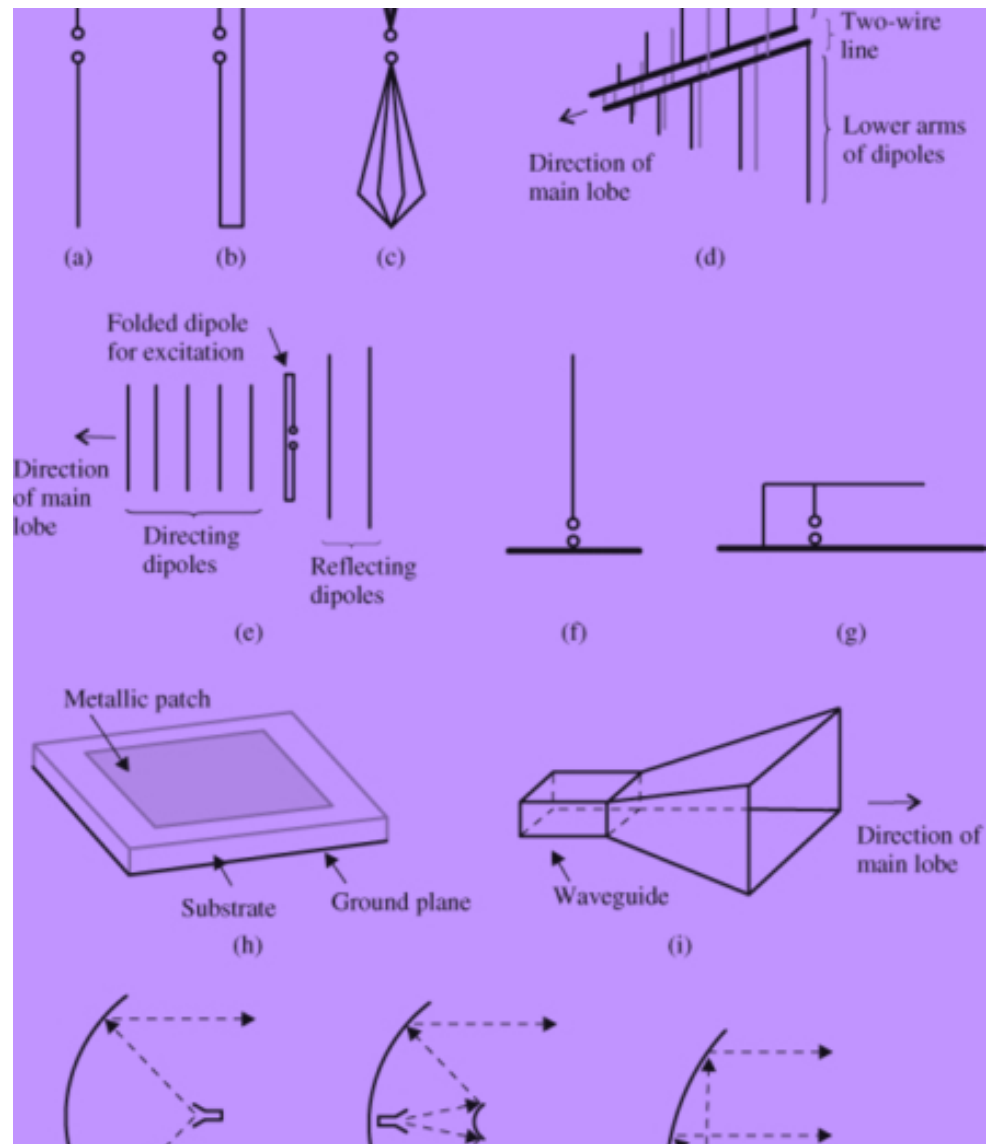

Decibel scale

$$G = \frac{P_1}{P_2}$$

$$G \text{ [dB]} = 10 \log G = 10 \log \left(\frac{P_1}{P_2} \right) \quad (\text{dB})$$

$$\begin{aligned} A &= 10 \log \left[\frac{\mathcal{S}(z)}{\mathcal{S}(0)} \right] \\ &= 10 \log(e^{-2\alpha z}) \\ &= -20\alpha z \log e \\ &= -8.68\alpha z = -\alpha \text{ [dB/m]} z \quad (\text{dB}) \end{aligned}$$

$$\alpha \text{ [dB/m]} = 8.68\alpha \text{ [Np/m]}$$

Table 2-2: Power ratios in natural numbers and in decibels.

G	G [dB]
10^x	$10x$ dB
4	6 dB
2	3 dB
1	0 dB
0.5	-3 dB
0.25	-6 dB
0.1	-10 dB
10^{-3}	-30 dB



Aalto University
School of Electrical

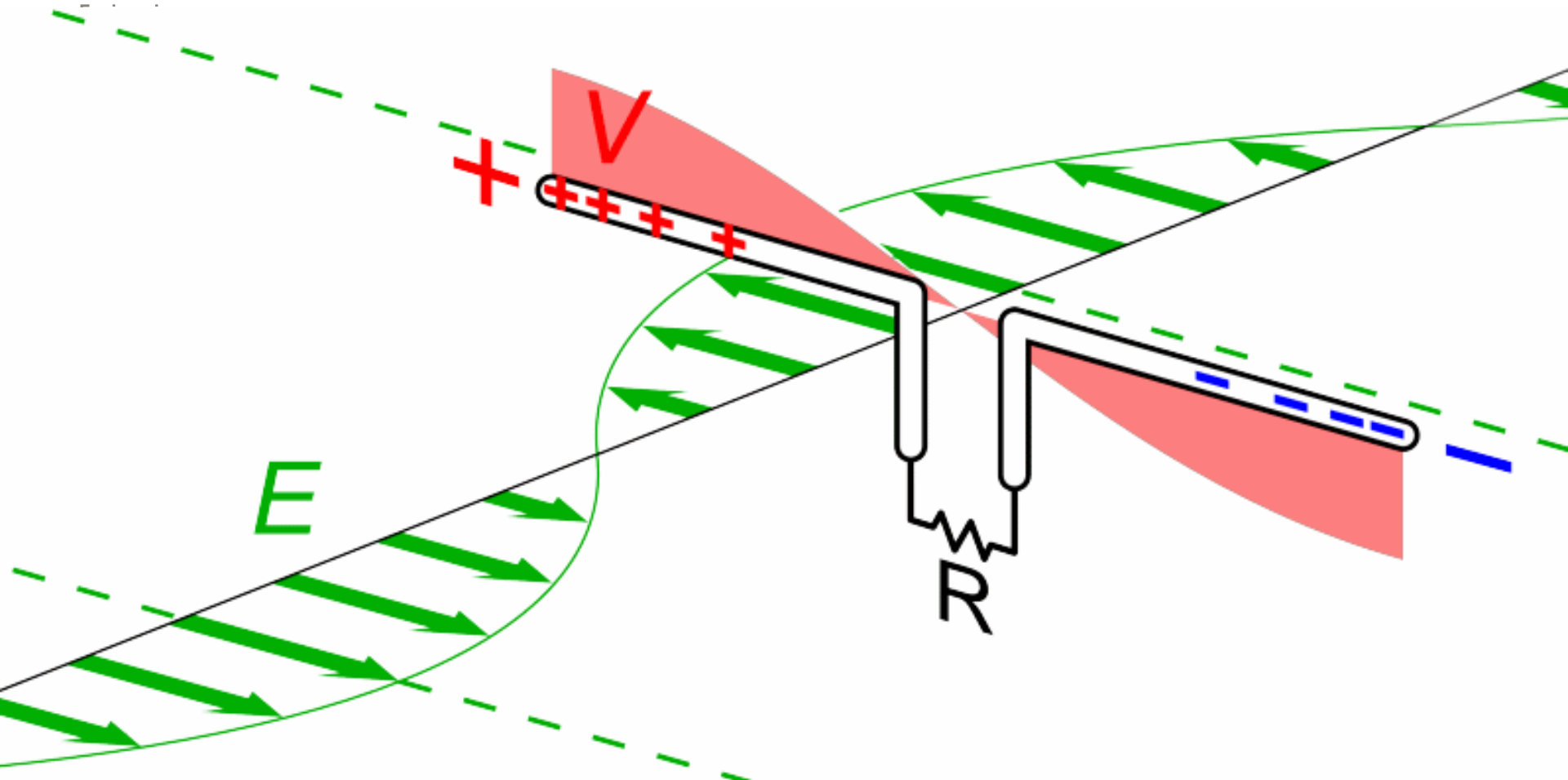

Antenna

An **antenna** is a transducer that converts a guided wave propagating on a **transmission line** into an **electromagnetic wave propagating** in an unbounded **medium** (usually free space), or vice versa.

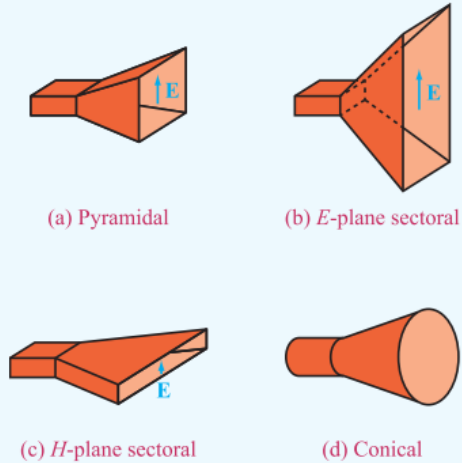

Figure 3-26: Commonly used types of horn antennas.

Reciprocity

The directional function characterizing the relative distribution of power radiated by an antenna is known as the antenna radiation pattern, or simply the antenna pattern.

An isotropic antenna is a hypothetical antenna that radiates equally in all directions.

Reciprocity means that antenna behaves the same way in reception and transmission. The process is independent of time direction.

Most antennas are reciprocal devices, exhibiting the same radiation pattern for transmission as for reception.

As a reciprocal device, an antenna operating in the receiving mode extracts from an incident wave only that component of the wave whose electric field matches the antenna polarization state.

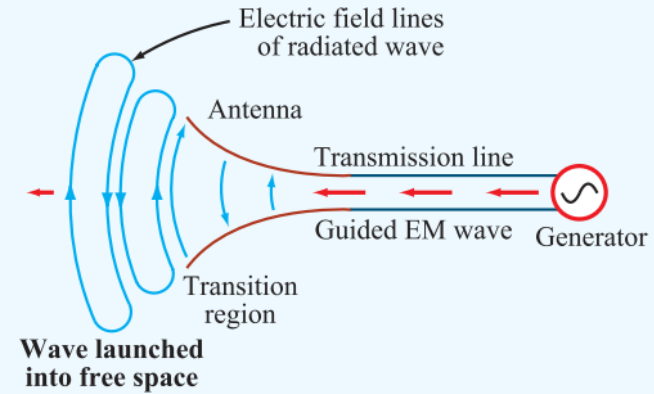

(a) Transmission mode

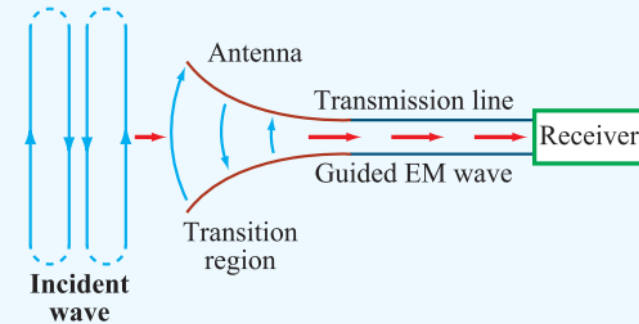

(b) Reception mode

Figure 3-1: Antenna as a transducer between a guided electromagnetic wave and a free-space wave, for both transmission and reception.

Various antennas

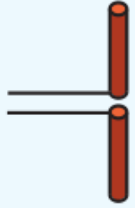

(a) Thin dipole



(b) Biconical dipole



(c) Loop

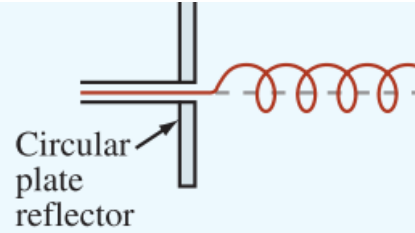

(d) Helix

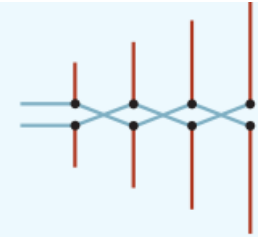

(e) Periodic

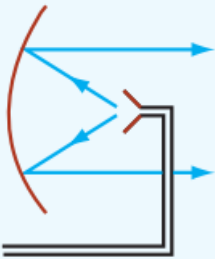

(f) Parabolic dish reflector

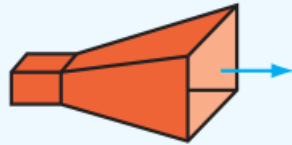

(g) Horn

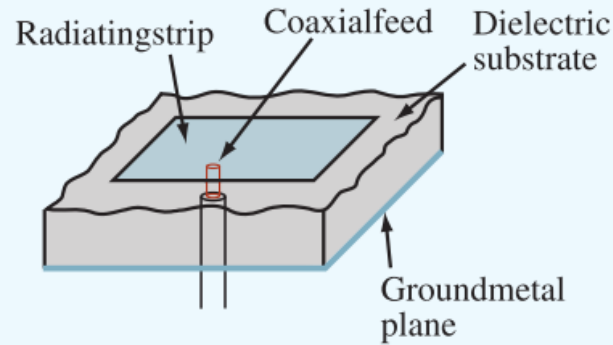

(h) Microstrip

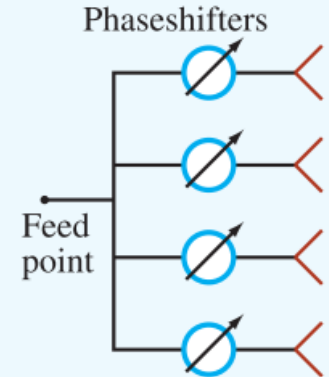

(i) Antenna array

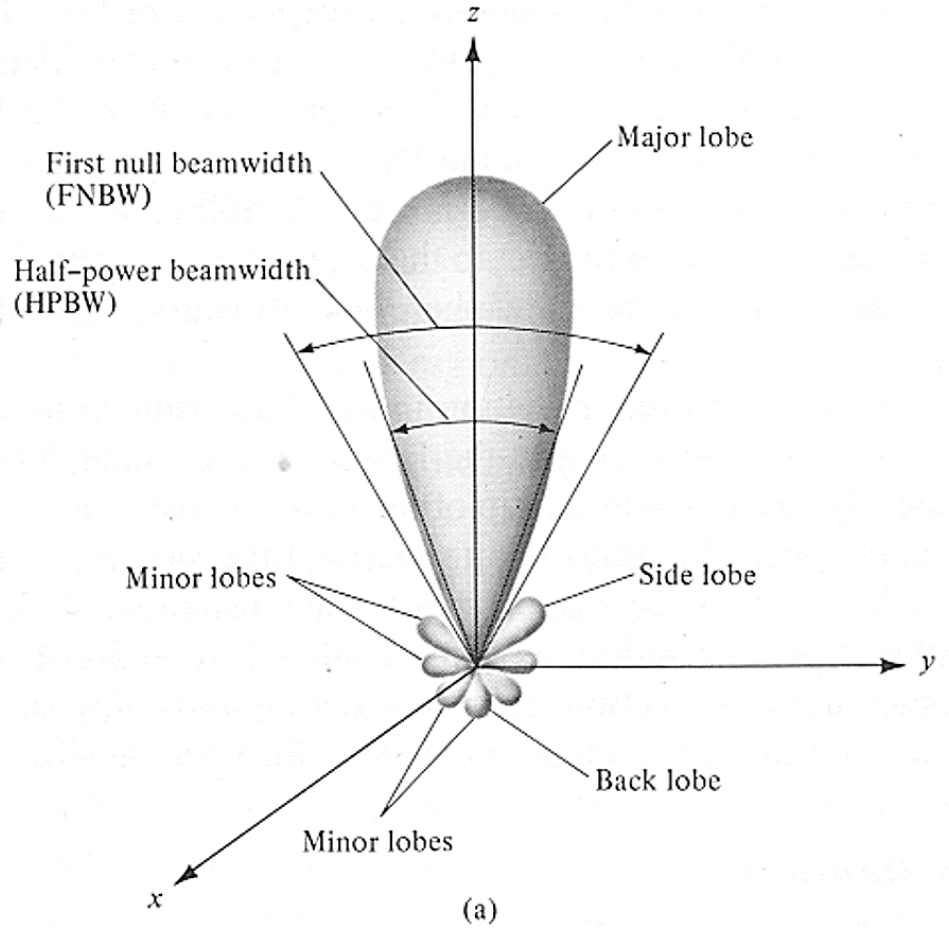
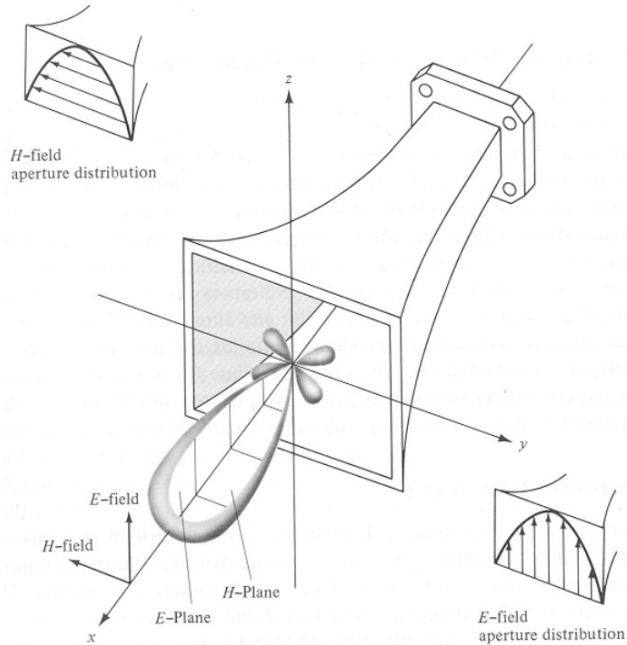

Far-field

Distance where the wavefront across the receiving aperture may be considered planar.

By convention, the far-field distance is defined as the distance R from the antenna at which the maximum error between the phase of the spherical wave radiated by the antenna and the phase of its plane-wave approximation is $\pi/8$. For an antenna whose longest linear dimension is d , the far-field distance is

$$R \geq 2d^2/\lambda$$

where λ is the wavelength of the wave radiated by the antenna.

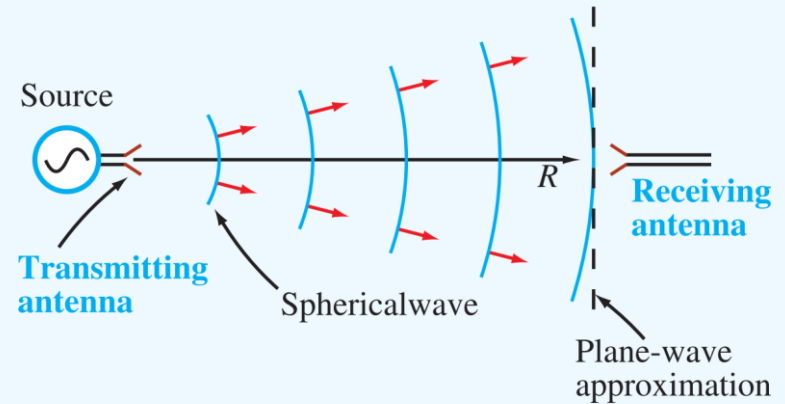

Antenna pattern

An antenna pattern describes the far-field directional properties of an antenna when measured at a fixed distance from the antenna.

Reciprocal antenna has the same directional pattern in the transmission and receiving mode.

The normalized radiation intensity $F(\theta, \varphi)$ characterizes the directional pattern of the energy radiated by the antenna.

Typical antenna has mainlobe, sidelobes and backlobes.

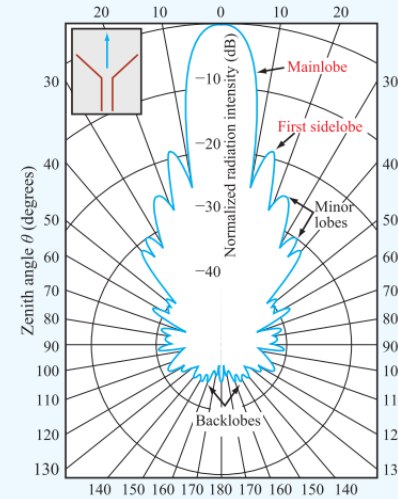

(a) Polar diagram

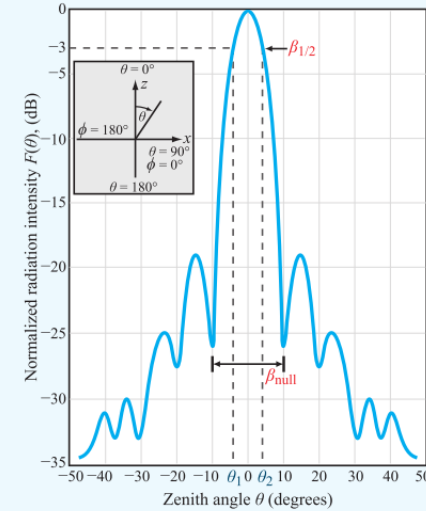

(b) Rectangular plot

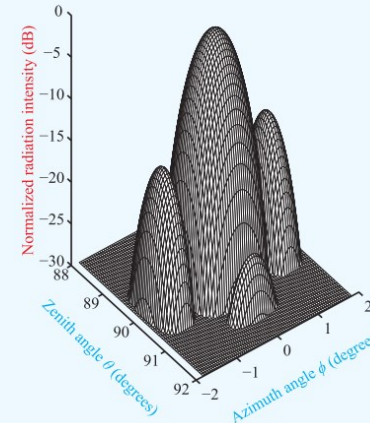

Directivity and Gain

The peak directivity D of an antenna is defined as the ratio of its maximum normalized radiation intensity, to the average value of $F(\theta, \varphi)$ over all directions (over 4π space).

The gain G accounts for ohmic losses in the antenna material, whereas the directivity does not. For a lossless antenna, $\xi = 1$ and $G = D$

$$G = \xi D$$

Where the efficiency $\xi = P_{rad} / P_t$

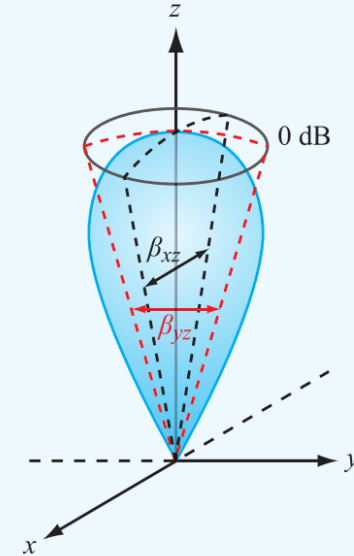

Figure 3-11: The solid angle of a unidirectional radiation pattern is approximately equal to the product of the half-power beamwidths in the two principal planes; that is, $\Omega_p \approx \beta_{xz}\beta_{yz}$.

Antenna arrays

When two or more antennas are used together, the combination is called an **antenna array**.

Antenna patterns add up coherently!

Through the use of electronically controlled solid-state phase shifters, the beam direction of the antenna array can be steered electronically by controlling the relative phases of the array elements.

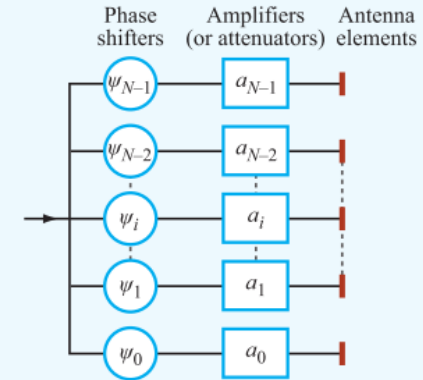

(a) Array elements with individual amplitude and phase control

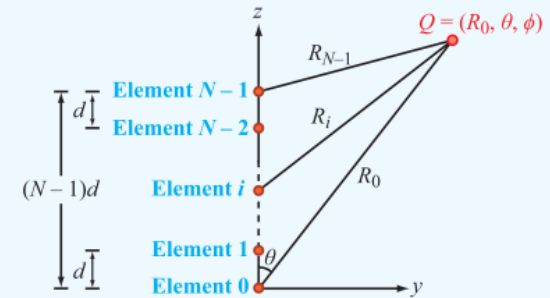

(b) Array geometry relative to observation point

Figure 3-21: Linear-array configuration and geometry.

A?

Aalto University
School of Electrical
Engineering

END

Multiple Reflection Method

ρ_{12} = reflection coefficient at the boundary between media 1 and 2, for incidence in medium 1 at angle θ_1 .

ρ_{21} = reflection coefficient at the boundary between media 1 and 2, for incidence in medium 2 at angle θ_2 . Note that $\rho_{21} = -\rho_{12}$.

τ_{12} = transmission coefficient from medium 1 to medium 2 when incidence is at angle θ_2 . Note that $\tau_{12} = 1 + \rho_{12}$ for h polarization and $\tau_{12} = (1 + \rho_{12}) \cos \theta_1 / \cos \theta_2$ for v polarization.

τ_{21} = transmission coefficient from medium 2 to medium 1 when incidence is at angle θ_2 . Note that $\tau_{21} = 1 + \rho_{21}$ for h polarization and $\tau_{21} = (1 + \rho_{21}) \cos \theta_2 / \cos \theta_1$ for v polarization.

$\mathcal{L} = e^{-\gamma_2 d \cos \theta_2}$ = propagation factor in medium 2 between its top boundary and bottom boundary (or between its bottom boundary and top boundary) along angle θ_2 .

ρ_{23} = reflection coefficient at the boundary between media 2 and 3 for incidence in medium 2 at angle θ_2 .

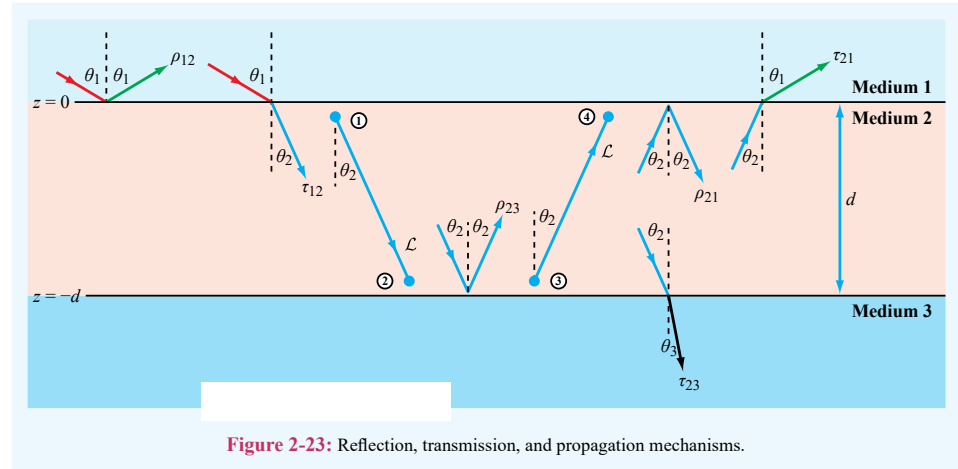

Figure 2-23: Reflection, transmission, and propagation mechanisms.

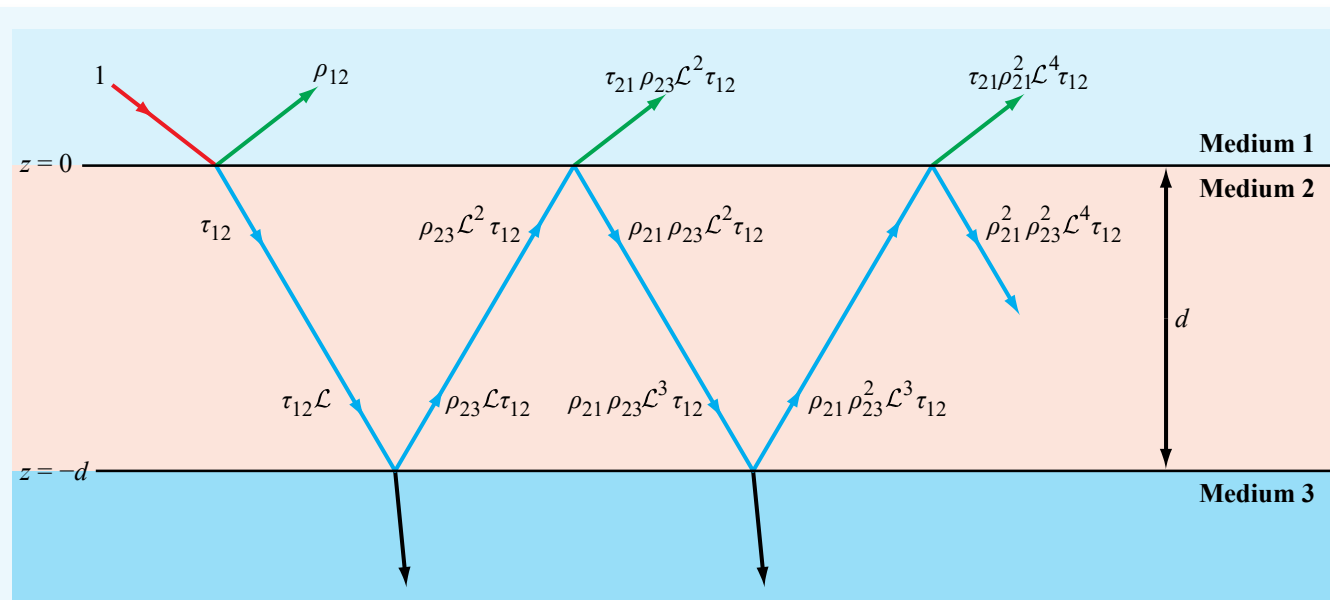

Figure 2-24: Multiple reflection process.

$$\begin{aligned} \rho &= \rho_{12} + \tau_{21}\rho_{23}\mathcal{L}^2\tau_{12} + \tau_{21}\rho_{23}^2\rho_{21}\mathcal{L}^4\tau_{12} + \dots \\ &= \rho_{12} + \tau_{21}\tau_{12}\rho_{23}\mathcal{L}^2(1 + x + x^2 + \dots), \quad (2.141) \end{aligned}$$

$$\tau_{21} = 1 + \rho_{21} = 1 - \rho_{12},$$

$$\tau_{12} = 1 + \rho_{12},$$

$$\frac{1}{1-x} = 1 + x + x^2 + \dots,$$

$$\rho = \frac{\rho_{12} + \rho_{23}e^{-2\gamma_2 d \cos \theta_2}}{1 + \rho_{12}\rho_{23}e^{-2\gamma_2 d \cos \theta_2}}, \quad \uparrow$$

Code 2.4

Code 2.4

This module computes the reflection properties of a two-layer composite with planar boundaries. Medium 1 is air with $\epsilon_1 = 1$. The incidence angle in medium 1, and the frequency in GHz also are inputs. The reflection coefficient and reflectivity are plotted against the thickness of the top layer, for both h and v polarizations.

$$\epsilon_2 = \epsilon_2' - j\epsilon_2''$$

$$\epsilon_3 = \epsilon_3' - j\epsilon_3''$$

matlab code: [module2_4.m](#)

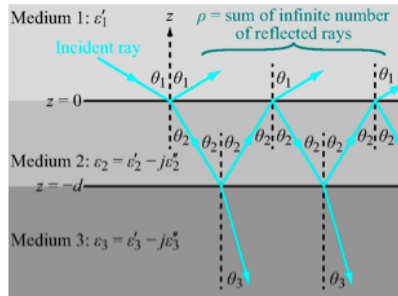

Real Part: ϵ_2' :

Imag Part: ϵ_2'' :

Real Part: ϵ_3' :

Imag Part: ϵ_3'' :

Incidence Angle (deg):

Frequency (GHz):

Reflection by Two-Layer Composite

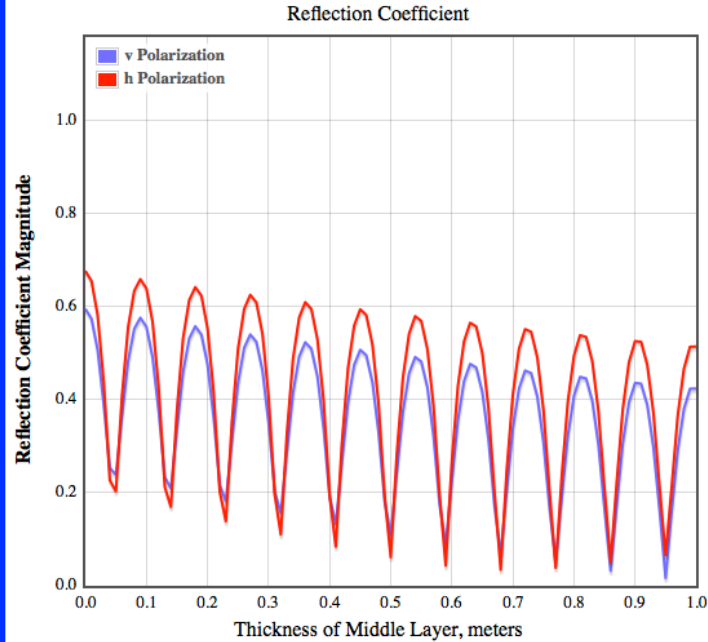

- Plot Reflection Coefficient Magnitude
- Plot Reflectivity

Code 2.3

Code 2.3

This module computes the reflection coefficients, transmission coefficients, reflectivities and transmissivities for incidence in medium 1 upon the planar boundary of a lossless or lossy medium (medium 2) at any incidence angle, for both h and v polarizations.

$$\epsilon_1 = \epsilon_1' - j \epsilon_1''$$

$$\epsilon_2 = \epsilon_2' - j \epsilon_2''$$

matlab code: [module2_3.m](#)

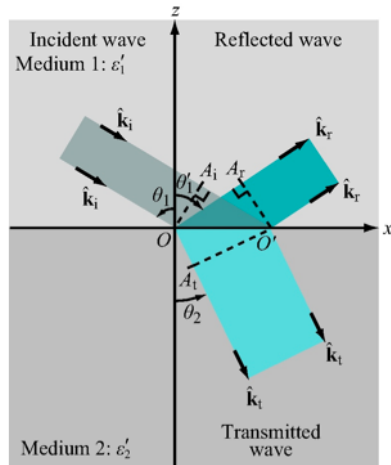

Real Part: ϵ_1' :

Imag Part: ϵ_1'' :

Real Part: ϵ_2' :

Imag Part: ϵ_2'' :

Oblique Reflection and Transmission at Planar Boundary

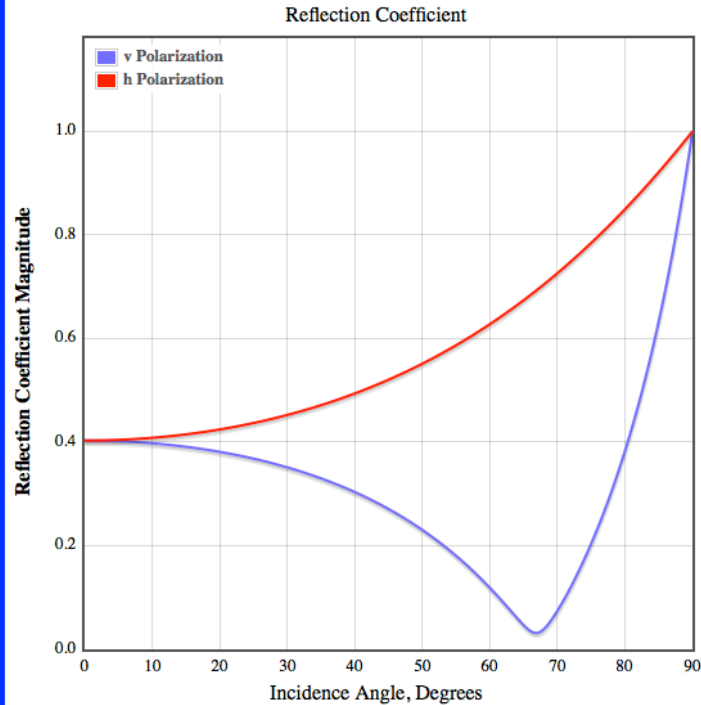

- Plot reflection coefficient magnitude
- Plot reflectivity
- Plot transmission coefficient magnitude
- Plot transmissivity