

# SCHEDULE

	Date	Topic
1.	Tue 14.09.	Lec-1: Introduction
2.	Fri 17.09.	Lec-2: Crystal Chemistry & Tolerance parameter
3.	Fri 17.09.	EXERCISE 1
4.	Tue 21.09.	Lec-3: Crystal chemistry & BVS
5.	Fri 24.09.	Lec-4: Molecular Symmetry & Point Groups
6.	Fri 24.09.	EXERCISE 2
7.	Tue 28.10.	Lec-5: Crystallography & Space Groups
8.	Fri 01.10.	Lec-6: XRD & Reciprocal Lattice
9.	Fri 01.10.	EXERCISE 3
10.	Tue 05.10.	Lec-7: ND & GI-XRD
11.	Fri 08.10.	Lec-8: Rietveld
12.	Fri 08.10	EXERCISE 4: Rietveld
13.	Tue 12.10.	Lec-9: Synchrotron rad. & XAS & RIXS
14.	Fri 15.10.	Lec-10: EXAFS & Mössbauer
15.	Fri 15.10.	EXERCISE 5
16.	Tue 19.10.	Seminars: XPS, ED, HRTEM, SEM, AFM
17.	Fri 22.10.	Lec-11: XRR
18.	Fri 22.10.	EXERCISE 6: XRR

**EXAM: Friday, Oct. 29<sup>th</sup>, 2021**

# LECTURE 6: X-RAY (POWDER) DIFFRACTION

- X-ray sources and XRD equipment
- Bragg Equation (you have learned this earlier!)
- Reciprocal lattice, Brillouin zone, Ewald sphere
- Allowed and forbidden reflections
- XRD **pattern**: Peak positions, peak intensities, peak shapes
- Indexing (Miller indices) & Lattice parameter determination
- Structure determination issues: scattering factor, structure factor, phase problem
- Rietveld refinement!

# Our X-ray diffractometers: you have already used them?

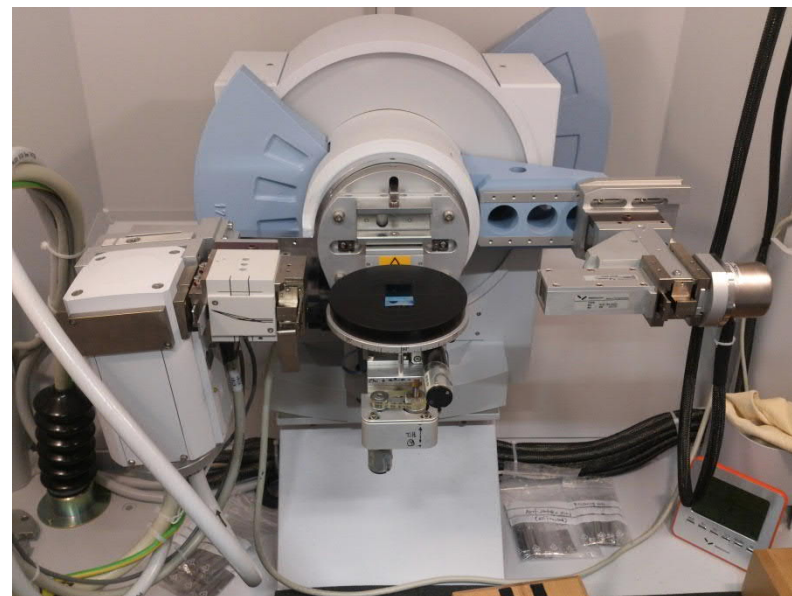
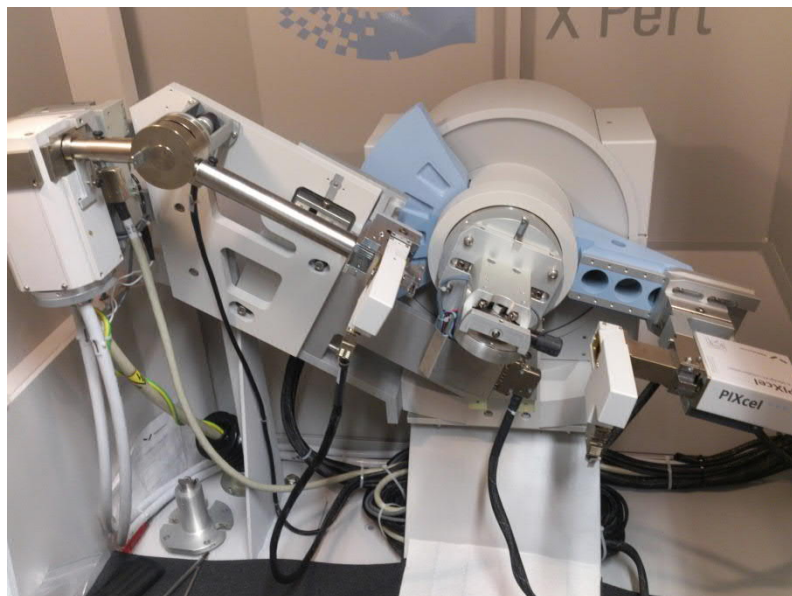

## Powder XRD

### PANalytical X'Pert PRO MPD Alpha1

- $\theta/2\theta$
- Johansson Ge monochromator
- Programmable slits
- Sample spinner
- PIXcel detector

## Thin-film XRD

### PANalytical X'Pert PRO MPD

- $\omega/2\theta$
- Cu mirror and collimator slit
- IR controlled sample stage
  - Height (z, 75 mm)
  - Rotation ( $\varphi$ ,  $n \cdot 360^\circ$ )
  - Tilt ( $\psi$ ,  $20^\circ$ )

## Our previous X-ray diffractometer: 1980s → 2013

Edellisen sukupolven XRD-laitteemme, **Philipsin 1980-luvulta aina vuoden 2013 alkuun palvellut vanha pulveri-diffraktometrime** oli todellinen työhevonen ja laboratoriomme tärkeimpiä työkaluja sekä tutkimuksessa että opetuksessa. Loppuaikoina vaikeutena oli ettei siihen enää saanut varaosia.

Ennen kuin hävitimme vanhan diffraktometrin uusien tieltä kutsuimme sen aikoinaan hankki-  
neet emeritus-professori Lauri Niinistön ja laboratorioyli-insinööri Lassi Hiltusen vierailulle laitokselle. Herrat muistelivat, että vanhan laitteen korkealämpötila-mittauksissa käytetty goniometri oli peräisin vieläkin vanhemmasta XRD-laitteesta, joka oli ollut käytössä jo Teknillisen korkeakoulun Hietalahden tiloissa. Goniometri ja sen lisälaitteet päätettiin säilyttää muistona laboratoriomme pitkästä röntgenkristallografian historiasta.



# EARLY HISTORY OF X-RAY DIFFRACTION

- 1895 **Röntgen:** x-ray radiation
- 1912 Von Laue: diffraction of x-rays in crystalline solids (Nobel 1914)
- 1913 W.H. & W.L Bragg: **Bragg** equation (Nobel 1915)
- 1913 W.L. Bragg: first crystal structures: NaCl, KBr, ZnS, diamond
- 1923 First crystal structure determination of an organic compound
- 1924 Weissenberg: single-crystal camera
- 1934 Patterson: "heavy-atom method"
- 1935 Le Galley: first powder diffractometer
- 1942 Buerger: precession camera
- 1947 **First commercial powder diffractometer (Philips)**
- 1948- Development of "direct methods"  
(H. Hauptman ja J. Karle, Nobel 1985)
- 1960 First crystal structure determination of protein
- 1962- Development of automatic four-circle diffractometers
- 1969 **Rietveld:** "whole pattern analysis" (for neutron powder diffraction)

# DIFFRACTION IN CRYSTALLINE MATERIAL

- **Wavelength of radiation** of the same order of magnitude as the **distances between atoms in crystals**
  - part of the radiation is reflected from crystals (**elastic scattering**)
  - diffraction can be utilized for crystal structure studies
- Within the electromagnetic radiation spectrum x-ray radiation is of the proper wavelength → **X-ray diffraction**
- **Particles have wave nature**
  - moving particles have wavelength
  - particles with proper **mass/energy** ratio can be utilized for diffraction
  - **neutron diffraction** and **electron diffraction**

# X-RAY DIFFRACTION

- X-ray radiation is scattered from the **electron clouds of atoms**
- More electrons at the reflection plane (heavy atoms)  
→ high intensity of reflected radiation
- Less electrons at the reflection plane (light atoms)  
→ low intensity of reflected radiation
- Production of x-ray radiation:
  - (i) generator + x-ray tube (e.g. Cu-K<sub>α</sub> 1.54 Å, Mo-K<sub>α</sub> 0.71 Å)
  - (ii) synchrotron (radiation with continuous wavelength)
- Recording of reflected radiation:
  - (i) as pulses on counter (x-ray diffractometer)
  - (ii) as black spots on film (x-ray camera; historical)

# X-RAY TUBE: e.g. Cu

- Characteristic X-ray radiation:  $\text{Cu-K}_\alpha$  ( $\text{K}\alpha_1 + \text{K}\alpha_2$ ) and  $\text{Cu-K}_\beta$
- To get monochromatic radiation  $\text{Cu-K}_\alpha$  and  $\text{Cu-K}_\beta$  radiation with need to be separated (with a filter)

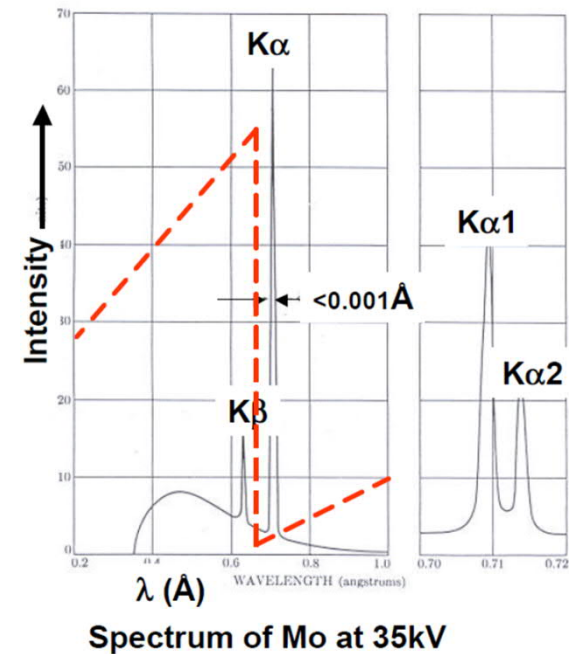
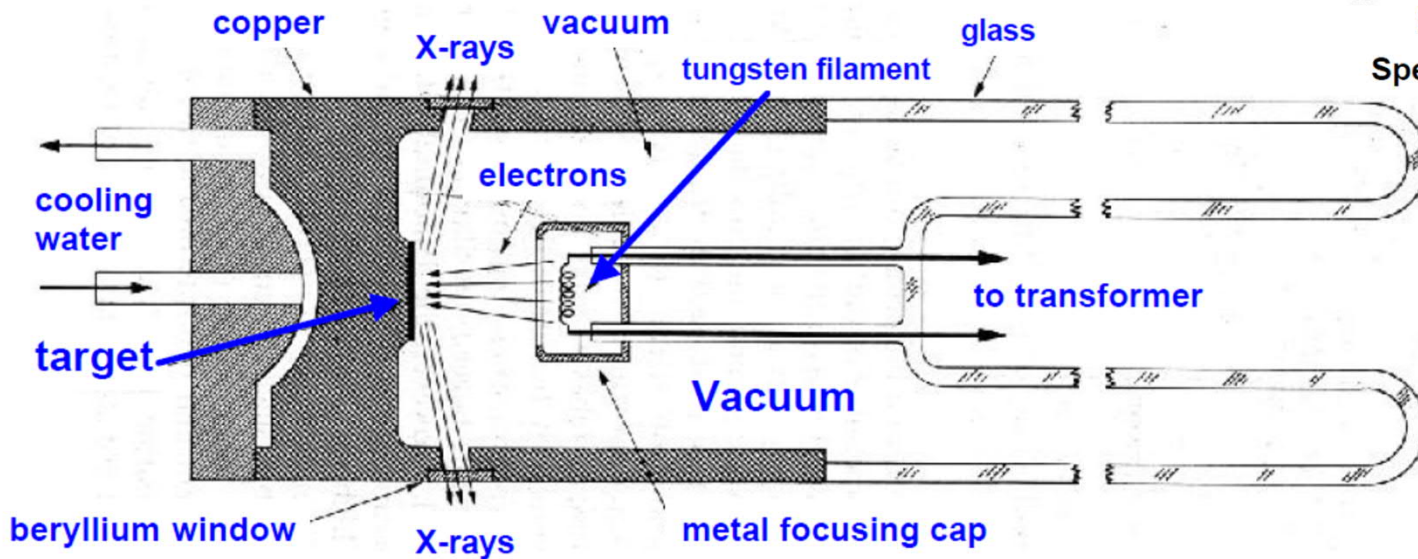

Spectrum of Mo at 35kV

X-rays are produced whenever high-speed electrons collide with a metal target. A source of electrons – hot W filament, a high accelerating voltage between the cathode (W) and the anode and a metal target, Cu, Al, Mo, Mg. The anode is a water-cooled block of Cu containing desired target metal.



- **Copper:  $K\alpha_1$ :  $\lambda = 1.5406 \text{ \AA}$ ,  $K\alpha_2$ :  $\lambda = 1.5444 \text{ \AA}$ ,  $K\beta$ :  $\lambda = 1.3923 \text{ \AA}$**
- **Typically: Cu- $K\alpha$  and Cu- $K\beta$  are separated, but not  $K\alpha_1$  and  $K\alpha_2$  (filters are expensive)**
- **If  $K\alpha_2$  is removed, total intensity decreases**
- **Intensity ratio:  $K\alpha_1 : K\alpha_2 = 2 : 1$**
- **$K\alpha_1$  and  $K\alpha_2$  not separated  $\rightarrow$  double reflections in the XRD pattern**
- **These are especially visible in the high  $2\theta$  range (Bragg law  $\rightarrow$  resolution increases with increasing  $2\theta$ )**

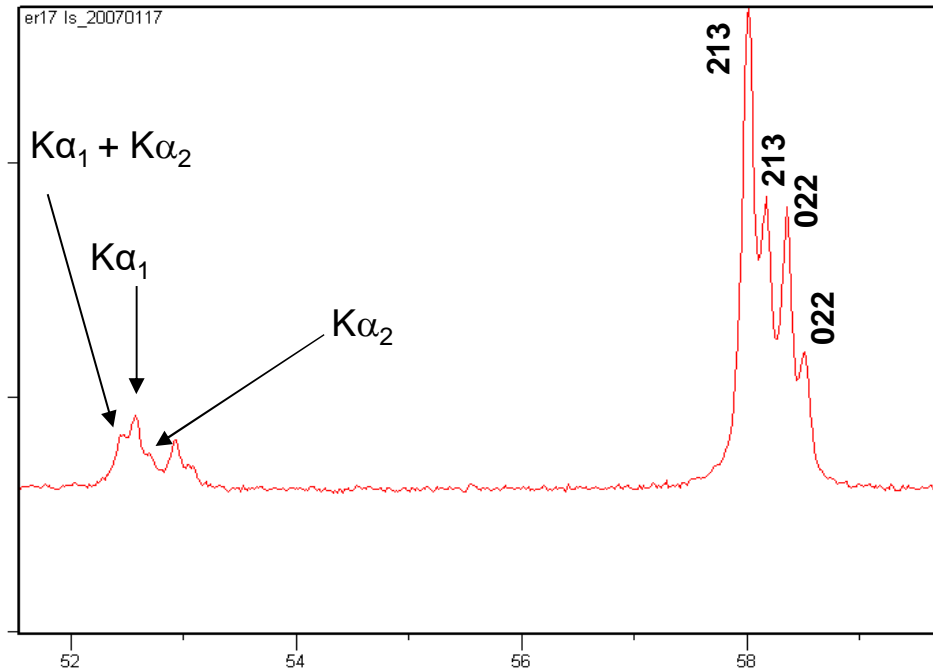
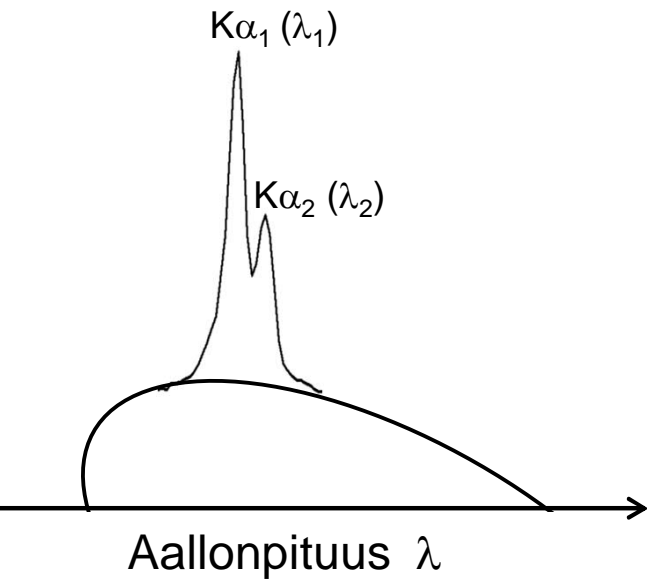

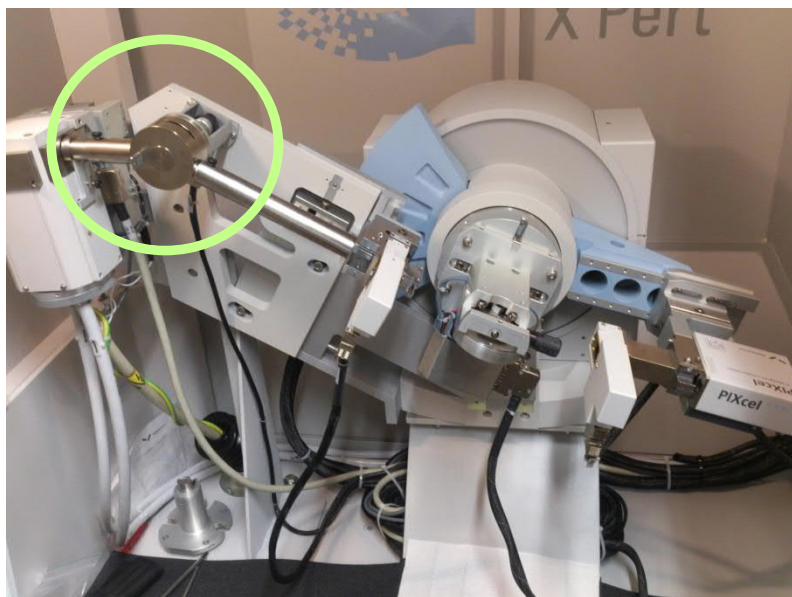

## Powder XRD PANalytical X'Pert PRO MPD Alpha1

- $\theta/2\theta$
- **Johansson Ge monochromator ( $K\alpha_2$  filter)**
- Programmable slits
- Sample spinner
- PIXcel detector

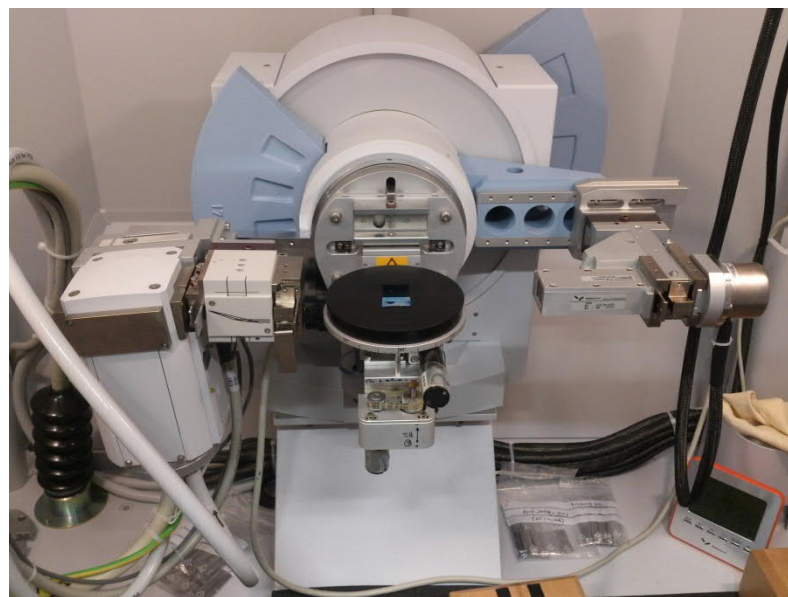

## Thin-film XRD PANalytical X'Pert PRO MPD

- $\omega/2\theta$
- Cu mirror and collimator slit
- IR controlled sample stage
  - Height (z, 75 mm)
  - Rotation ( $\phi$ ,  $n \cdot 360^\circ$ )
  - Tilt ( $\psi$ ,  $20^\circ$ )

# SYNCHROTRON RADIATION

- **Very bright/intense** x-ray radiation
- Used for x-ray diffraction in case of demanding samples (e.g. light elements)
- **Continuous spectrum** (c.f. the characteristic peaks from x-ray tube)
- We will discuss synchrotron radiation in detail in the context of EXAFS and XANES

$$\text{brilliance} = \frac{\text{photons}}{\text{second} \cdot \text{mrad}^2 \cdot \text{mm}^2 \cdot 0.1\% \text{ BW}}$$

Diagram illustrating the components of the brilliance equation:

- photons
- second
- mrad<sup>2</sup>
- mm<sup>2</sup>
- 0.1% BW

Labels with arrows pointing to the denominator terms:

- Divergence (points to mrad<sup>2</sup>)
- Beam area (points to mm<sup>2</sup>)
- Wavelength spread (points to 0.1% BW)

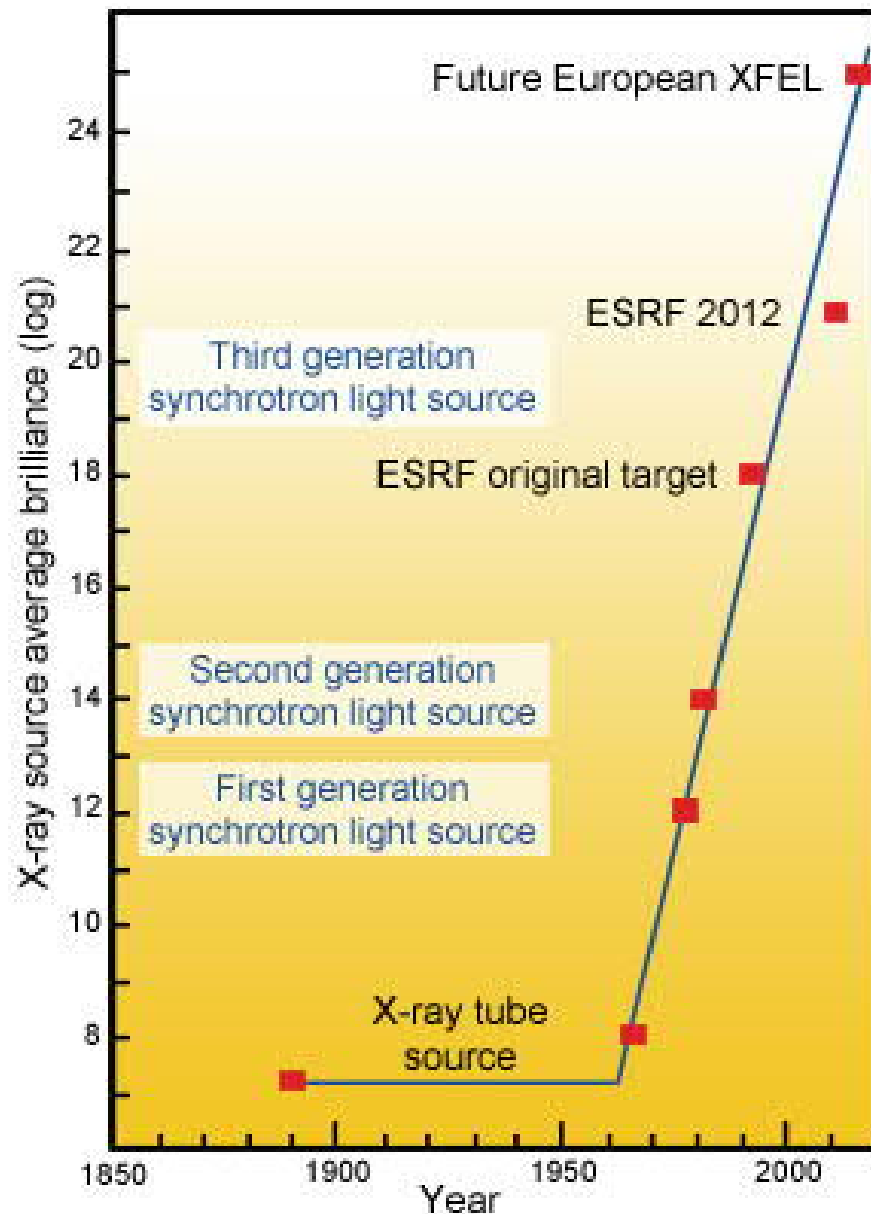

# XRD Pattern of NaCl Powder

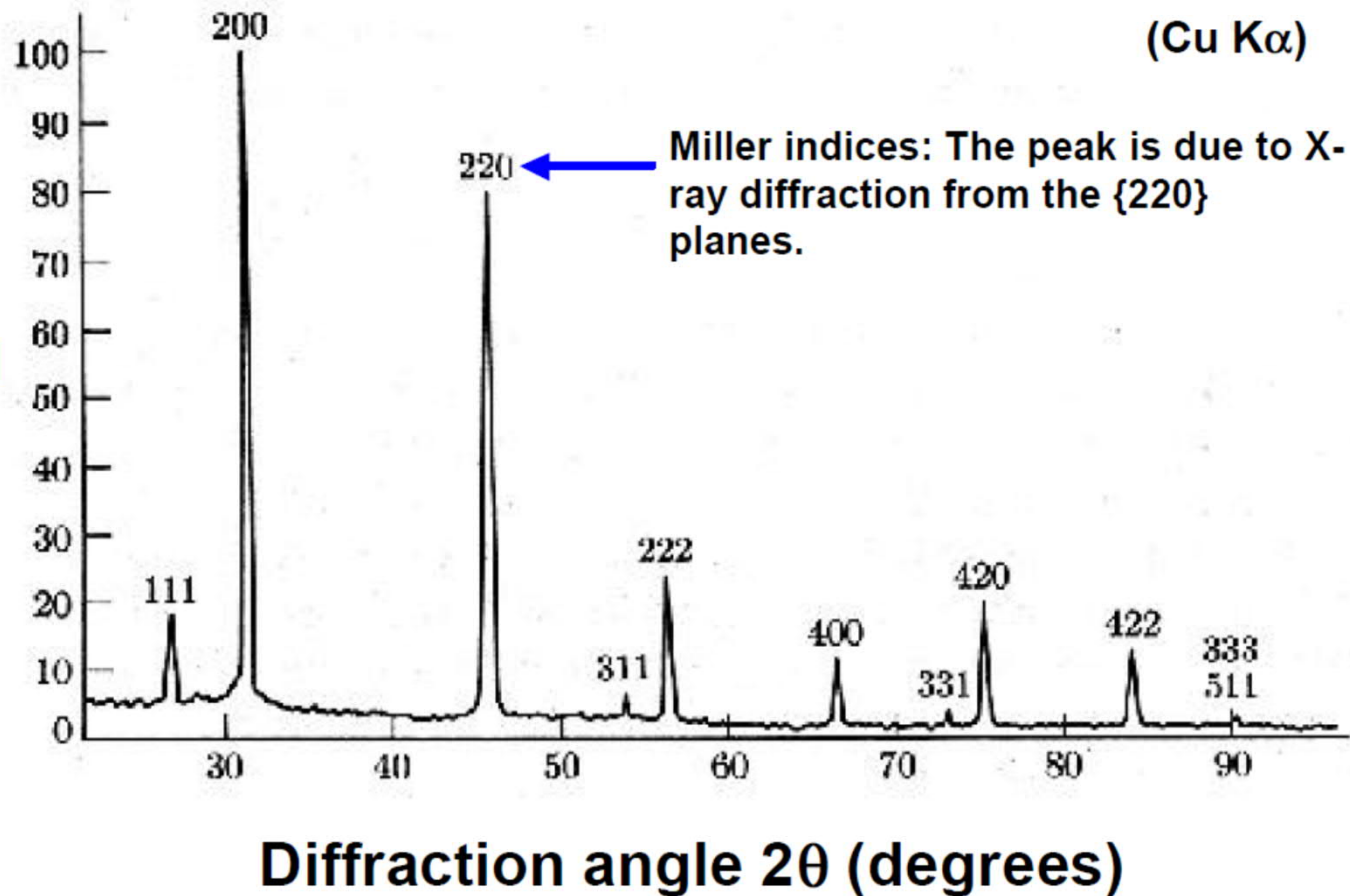

As you are going to see soon, not only the peak positions and intensities but also the peak shapes carry information; Hence, the correct terminology is “pattern”, not diffractogram

You have learned the Bragg's law: this is a good presentation to recall it

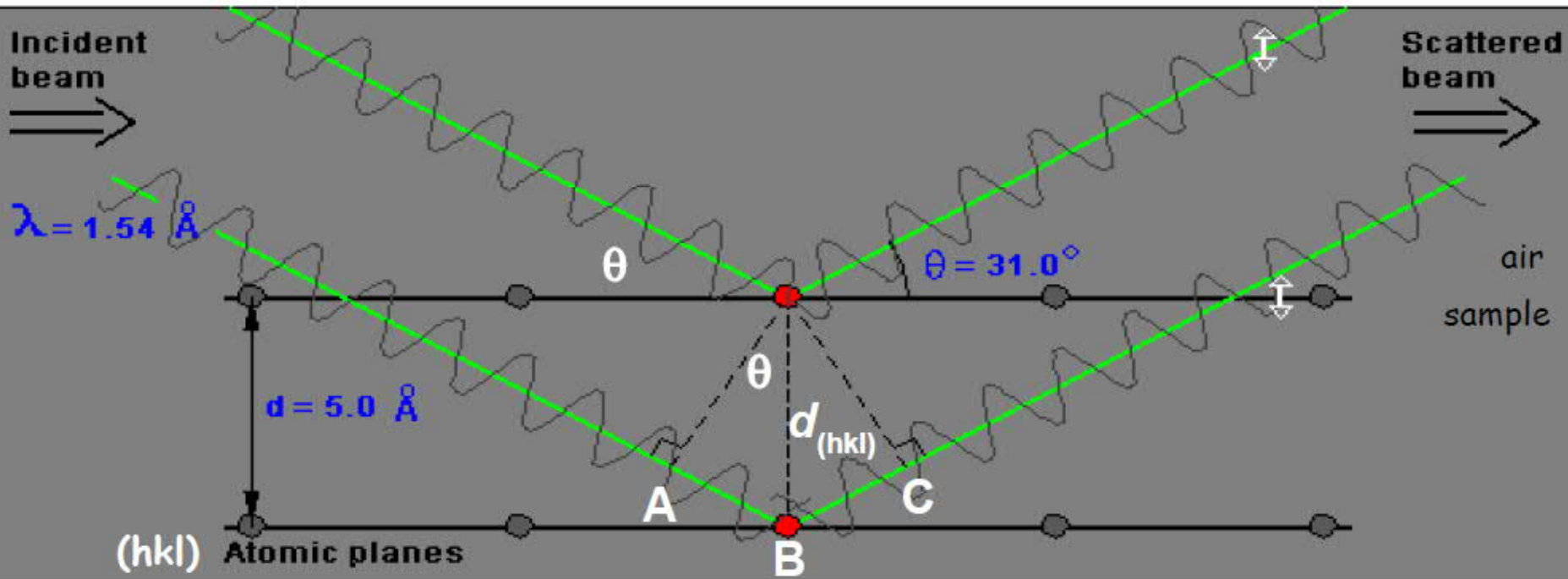

Lambda	Distance	Theta
1.5418	4.99999	31.0

Figure from <http://www.eserc.stonybrook.edu/ProjectJava/Bragg/>

**Bragg's law**

**Constructive interference**  
$$n\lambda = 2d \sin\theta$$

# RECIPROCAL LATTICE

- **Direct lattice** = "real" lattice
- **Reciprocal lattice:** (mathematically) Fourier transform of the direct lattice
  - Reciprocal space sometimes called momentum space or K-space
  - Fourier transformation equations are symmetrical:  
reciprocal lattice of the reciprocal lattice is equivalent to the original direct lattice
- Planes in real lattice are points in reciprocal lattice, and vice versa
- Length of reciprocal lattice vector is proportional to the reciprocal of the length of direct lattice vectors →  
Big in real space is small in reciprocal space, and vice versa
- Reciprocal lattice has important role in diffraction theory:
  - **Diffraction pattern represents reciprocal lattice, not direct lattice**
  - From the diffraction pattern, the reciprocal vectors can be determined
- Brillouin Zone = "Unit cell" in Reciprocal lattice

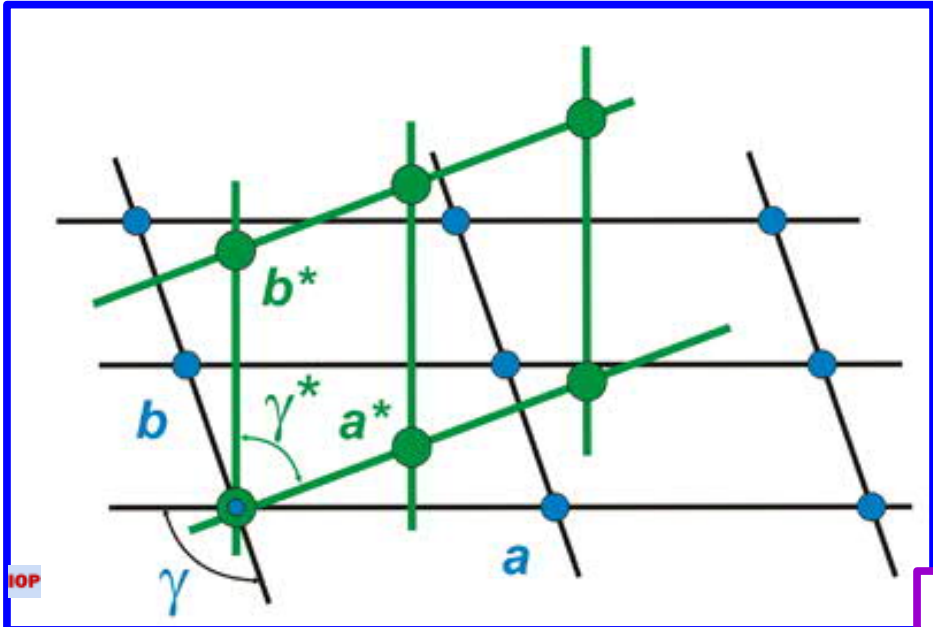

IOP

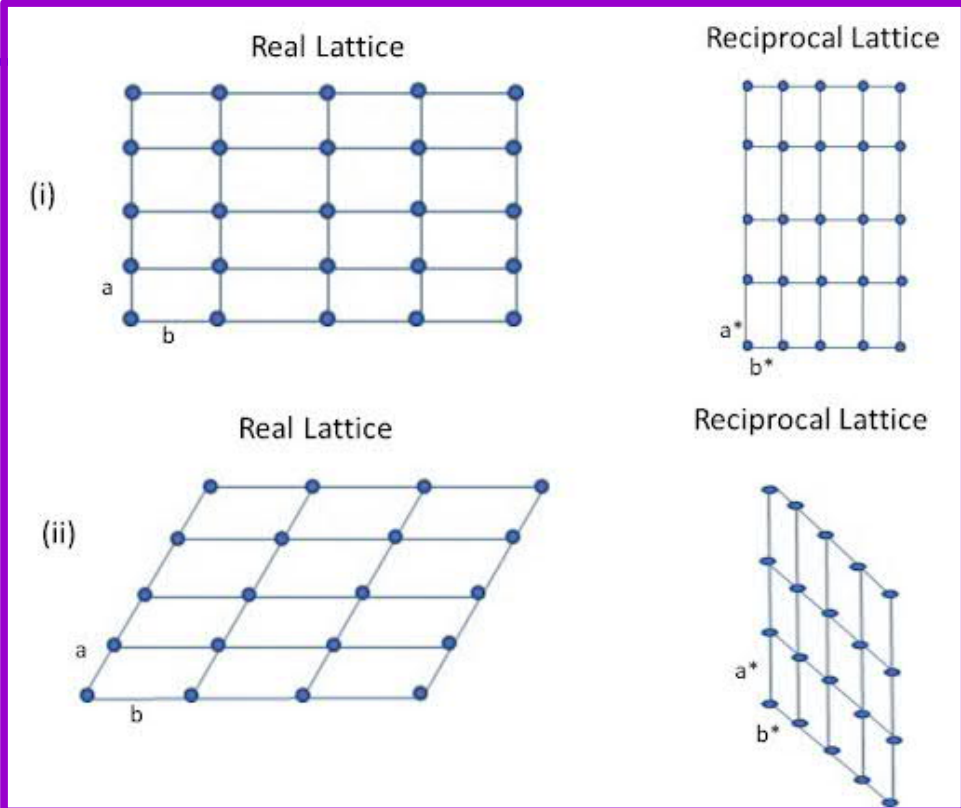
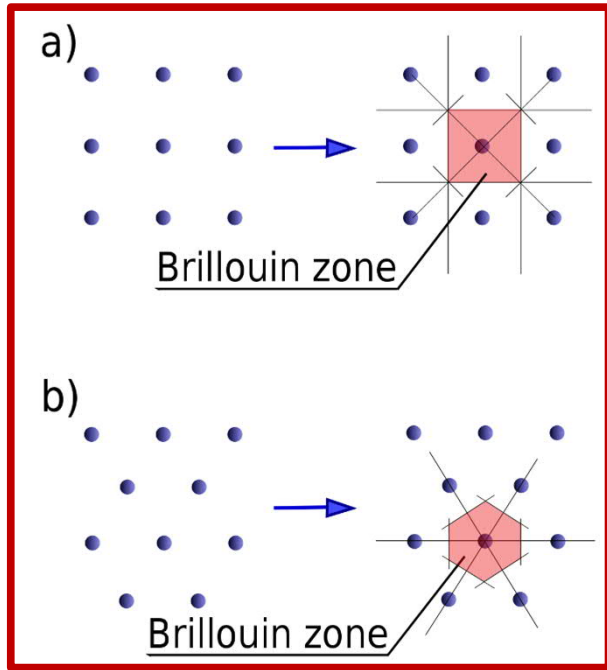

# Ewald sphere

- Radius:  $1/\lambda$  ( $\lambda$  = wavelength of incident beam)
- Illustrates which reciprocal lattice points result in diffraction signal (reciprocal points that touch the sphere)

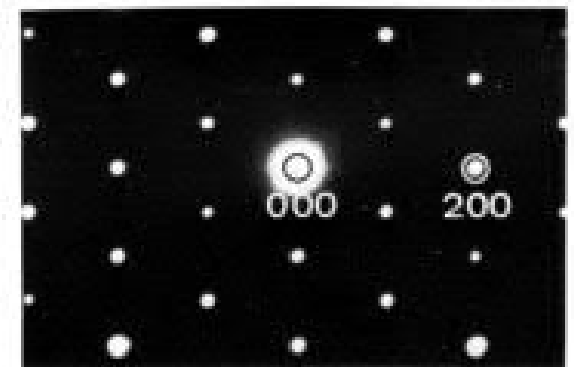
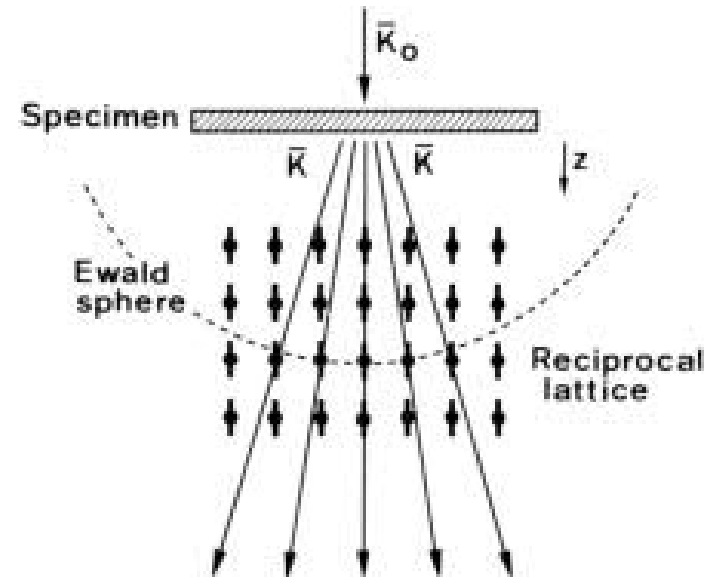
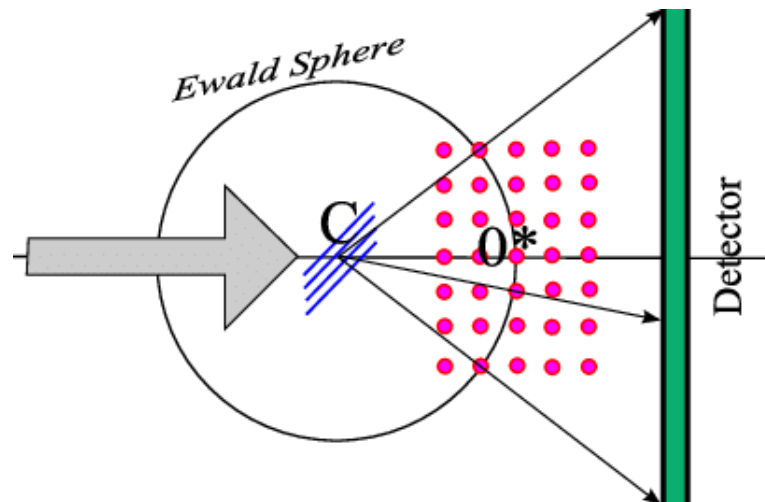
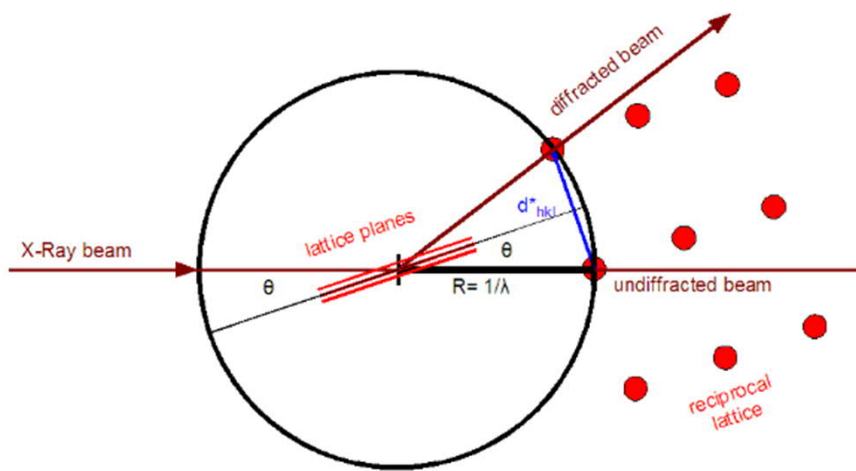



## Single Crystal Diffraction

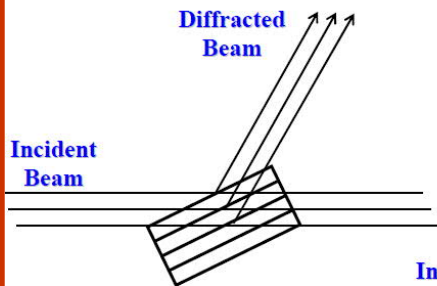

## Powder Diffraction

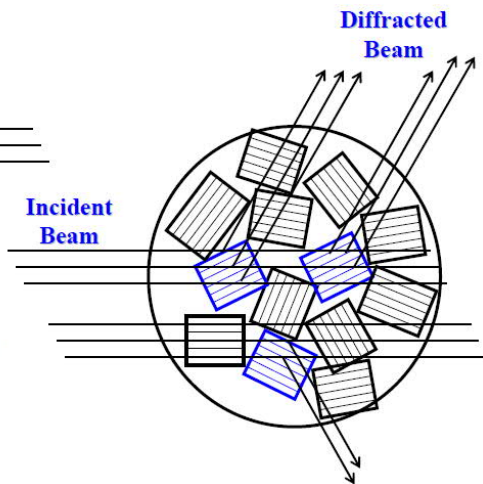

In powder diffraction only a small fraction of the crystals (shown in blue) are correctly oriented to diffract.

## Single Crystal Diffractometer (4 circles)



## Powder Diffractometer (2 circles)

<https://chemistry.osu.edu/~woodward/>

## Single Crystal Diffraction (3D)



## Powder Diffraction (1D)

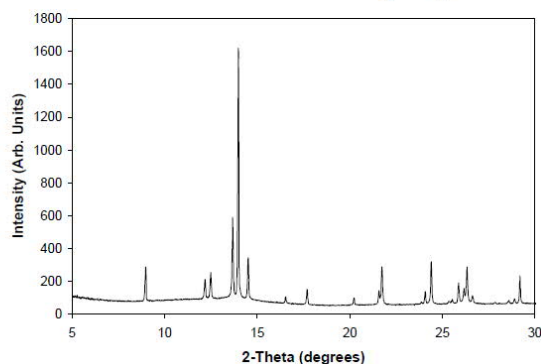

## Information in a Diffraction Pattern

- **Peak Positions**
  - The peak positions tell you about the translational symmetry. Namely what is the size and shape of the unit cell.
- **Peak Intensities**
  - The peak intensities tell you about the electron density inside the unit cell. Namely where the atoms are located.
- **Peak Shapes & Widths**
  - The peak widths and shapes can give information on deviations from a perfect crystal. You can learn about the crystallite size if it is less than roughly 100 - 200 nm. You can also learn about extended defects and microstrain.

# JCPDS Card

Quality of data

①	5-628	②	2.82	1.99	1.63	3.26	④	NaCl	★
	$d$		100	55	15	13		Sodium Chloride	
	$I/I_1$		(Halite)						
	Rad. $\text{CuK}\alpha_1$	$\lambda$ 1.5405	Filter Ni	Dia.					
	Cut off	$I/I_1$ Diffractometer	$I/I_1$ cor.						
⑤	Ref. Swanson and Fuyat, NBS Circular 539, Vol. 2, 41 (1953)								
	Sys. Cubic	S.G. Fm3m (225)							
⑥	$a_0$ 5.6402	$b_0$	$c_0$	A	C				
	$\alpha$	$\beta$	$\gamma$	Z 4	Dx 2.164				
⑦	Ref. Ibid.								
	$e\alpha$	$n\omega/\beta$ 1.542	$e\gamma$	Si gn					
	$Z\gamma$	D	mp	Color	Colorless				
⑧	Ref. Ibid.								
	An ACS reagent grade sample recrystallized twice from hydrochloric acid.								
	X-ray pattern at 26°C								
	Merck Index, 8th Ed., p. 956								
	Halite-galena-periclasite group.								
		$d$ Å	$I/I_1$	$hkl$	$d$ Å	$I/I_1$	$hkl$		
		3.258	13	111					
		2.821	100	200					
		1.994	55	220					
		1.701	2	311					
		1.628	15	222					
		1.410	6	400					
		1.294	1	331					
		1.261	11	420					
		1.1515	7	422					
		1.0855	1	511					
		0.9969	2	440					
		0.9533	1	531					
		0.9401	3	600					
		0.8917	4	620					
		0.8601	1	533					
		0.8503	3	622					
		0.8141	2	444					

- file number
- three strongest lines
- lowest-angle line
- chemical formula and name
- data on diffraction method used
- crystallographic data
- optical and other data
- data on specimen
- data on diffraction pattern.

Joint Committee on Powder Diffraction Standards, JCPDS (1969)  
 Replaced by International Centre for Diffraction Data ICDD (1978)

## Qualitative Analysis Searching with the ICDD

Once you have a powder pattern you can use it like a fingerprint to see if it matches the powder pattern of an already known compound. Nowadays this is usually done with the help of a computer.

The International Centre for Diffraction Data (ICDD) maintains a database of known powder diffraction patterns ([www.icdd.com](http://www.icdd.com))

- 115,000 patterns (not all unique)
- 95,000 Inorganic compounds
- 20,000 Organic compounds

## ICDD “Card”

### “FINGERPRINT” APPROACH

### Phase recognition + Impurity phases

I believe you have done this in some lab works already?

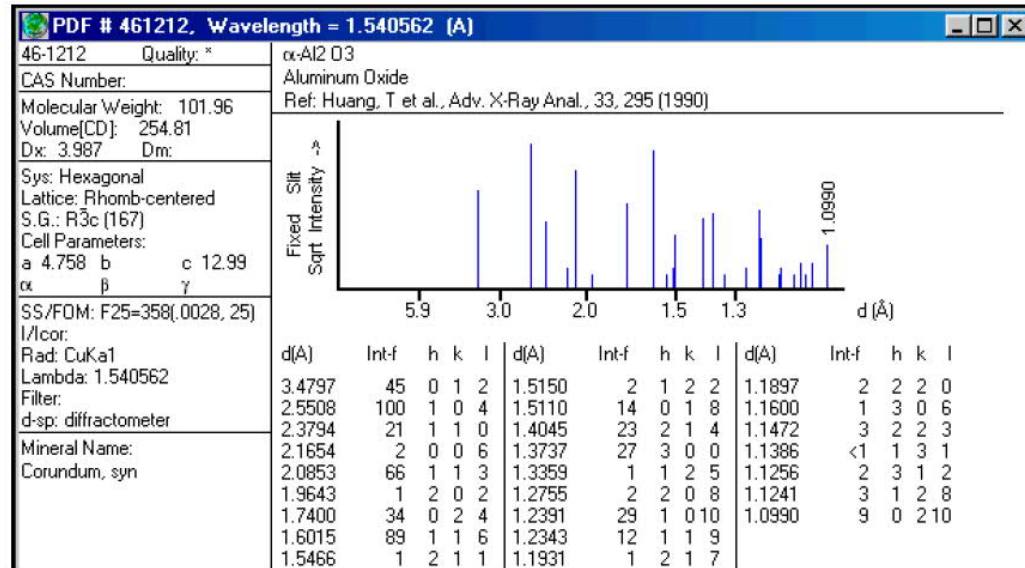

# EXAMPLES OF XRD PATTERNS

Experimental patterns (on the top) and JSPDS card data (below) for some (double) perovskite samples.

The JSPDS data are kind of "diffractogram lines" showing the peak positions and intensities, but not the shapes).

$\text{CuWO}_4$  (JSPDS: 01-070-1732)

$\text{Sr}_2\text{CuWO}_6$  (JSPDS: 01-076-0086)

$\text{Ba}_2\text{CuWO}_6$  (JSPDS: 01-076-0084)

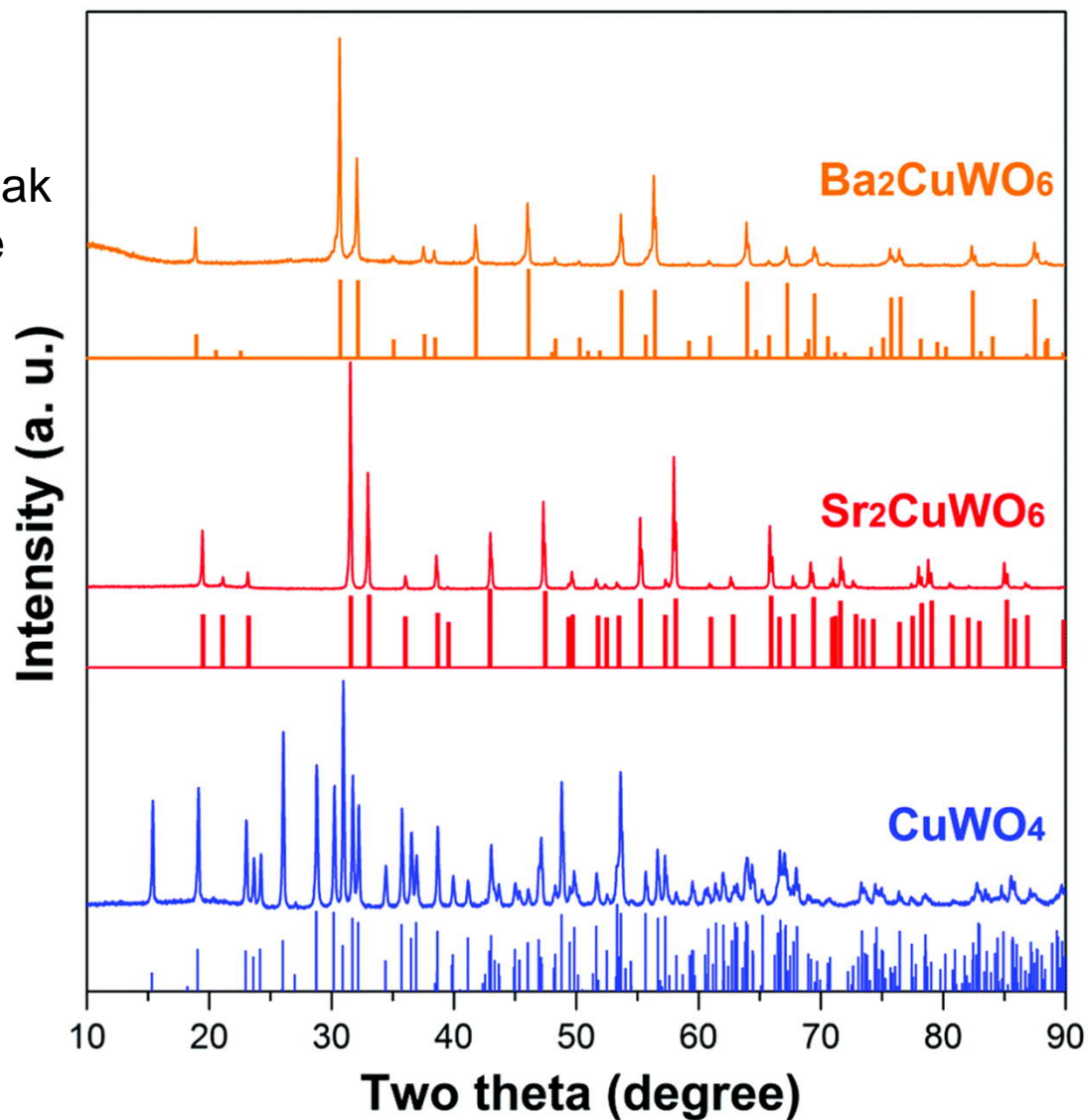

## **FURTHER ANALYSIS OF DIFFRACTION PATTERN**

- **First step: Indexing → find the Miller indices for the reflections**
- **This allows the determination of the lattice parameters**
- **This is relatively easy for high-symmetry structures**

# Example of XRD Pattern

- The unit cell size and geometry may be resolved from the angular positions of the diffraction peaks.
- The arrangement of atoms within the unit cell is associated with the relative intensities of these peaks

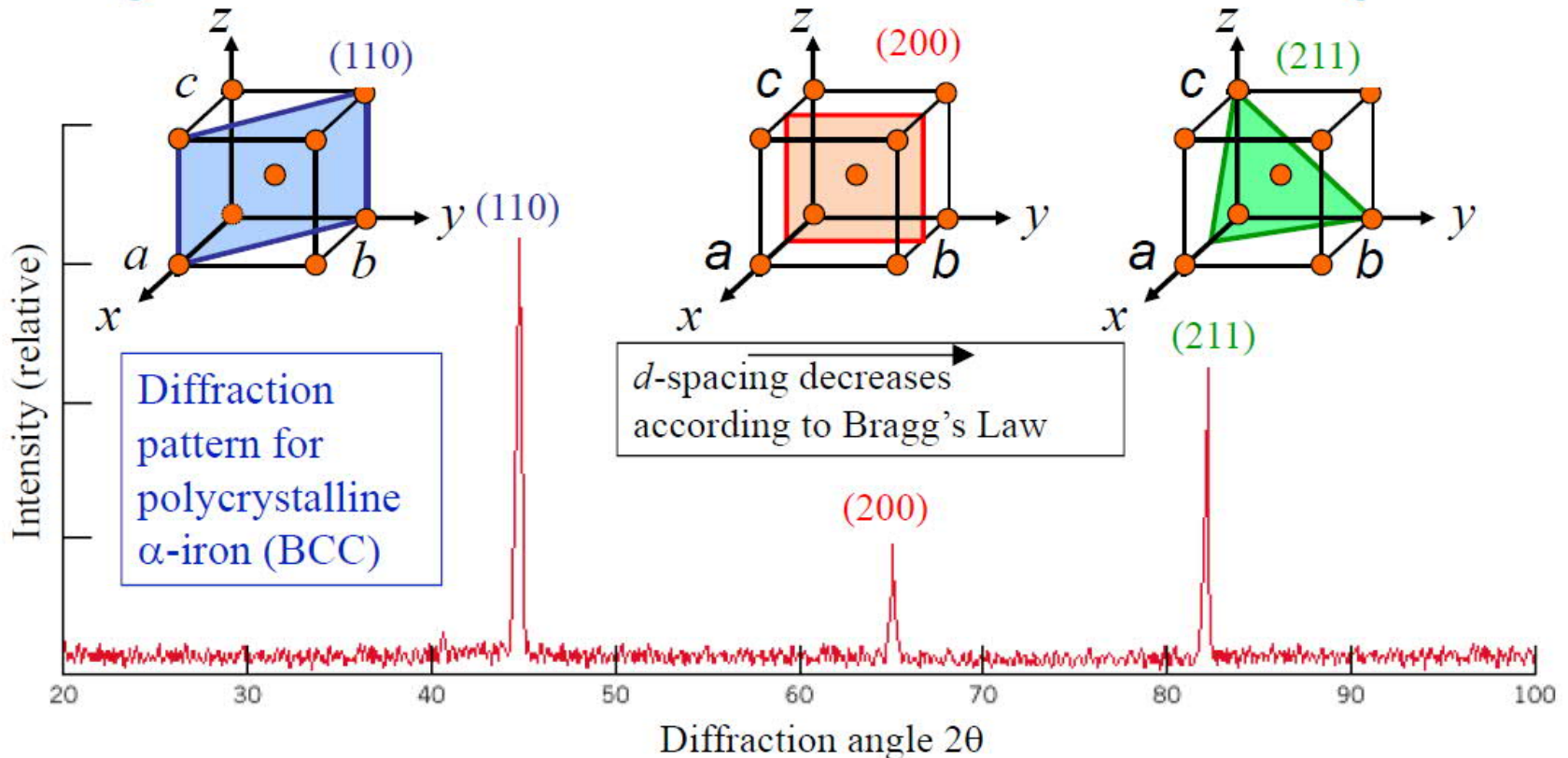

**Only few peaks and at nearly same distance from each other → CUBIC**  
**Can we see whether the lattice is primitive or not ? (Answer: YES !)**

# More on Bragg's Law

- **Bragg's Law** is a necessary but insufficient condition for diffraction.
- It **only defines the diffraction condition for primitive unit cells**, e.g. P cubic, P tetragonal, etc., where atoms are only at unit cell corners.
- Crystal structures with non-primitive unit cells have atoms at additional lattice (basis) sites.
- These extra scattering centers can cause out-of-phase scattering to occur at certain Bragg angles.
- The net result is that some of the diffraction predicted by Bragg's Law (eq. 1) does not occur, i.e. certain sets of planes do not exist (**forbidden reflections**).
- **Selection (or Reflection) rules:**

Bravais Lattice	Example Compounds	Allowed Reflections	Forbidden Reflections
Primitive Cubic	Simple Cubic ( $\alpha$ -Po)	Any h,k,l	None
Body-Centered Cubic	Body-Centered Cubic metal	h+k+l even	h+k+l odd
Face-Centered Cubic	Face-Centered Cubic metal	h,k,l all odd or all even	h,k,l mixed odd or even
Face-Centered Cubic	NaCl-rocksalt, ZnS-zincblende	h,k,l all odd or all even	h,k,l mixed odd or even
Face-Centered Cubic	Si, Ge - Diamond cubic	As FCC, but if all even and $h+k+l \neq 4n$ , then absent (n is integer)	h,k,l mixed odd or even and if all even and $h+k+l \neq 4n$
Primitive Hexagonal	Hexagonal closed packed metal	All other cases	$h+2k=3n$ , l odd

**In the example on the previous page, only 110, 200 and 211 peaks seen, while 100 and 210 are missing → Body-centered cubic**

# Selection Rules for Cubic Crystals

$$d_{hkl} = \frac{a}{\sqrt{h^2 + k^2 + l^2}} = \frac{a}{\sqrt{S}}$$

where “S” is reflection or line #,  
 e.g. (100) is 1<sup>st</sup> order reflection and (200) is 4<sup>th</sup> order reflection.

As we will determine later when we calculate the structure factors, these selection rules also hold for other Bravais lattices, e.g. I-tetragonal, F-orthorhombic, etc.

P		I		F		
S	(hkl)	S	(hkl)	S	(hkl)	
1	100	-	-	-	-	→ Odd+even
2	110	2	110	-	-	→ Odd+even
3	111	-		3	111	→ All odd
4	200	4	200	4	200	→ All even
5	210	-	-	-	-	→ Odd+even
6	211	6	211	-	-	→ Odd+even
7	-	-	-	-	-	
8	220	8	220	8	220	→ All even
9	221,300	-	-			→ Odd+even
10	310	10	310			→ Odd+even
11	311	-	-	11	311	→ All odd
12	222	12	222	12	222	→ All even

**Table 1.1** Interplanar spacings  $d_{hkl}$  for different crystal systems and their dependency on Miller indices  $hkl$ . Parameters  $a$ ,  $b$  and  $c$  give the lengths of the crystallographic unit cell, while  $\alpha$ ,  $\beta$  and  $\gamma$  specify the angles between them.

Crystal system	Constraints	$\frac{1}{d_{hkl}^2} =$
Cubic	$a = b = c$ $\alpha = \beta = \gamma = 90^\circ$	$\frac{h^2 + k^2 + l^2}{a^2}$
Tetragonal	$a = b$ $\alpha = \beta = \gamma = 90^\circ$	$\frac{h^2 + k^2}{a^2} + \frac{l^2}{c^2}$
Orthorhombic	$\alpha = \beta = \gamma = 90^\circ$	$\frac{h^2}{a^2} + \frac{k^2}{b^2} + \frac{l^2}{c^2}$
Hexagonal	$a = b$ $\alpha = \beta = 90^\circ$ $\gamma = 120^\circ$	$\frac{4}{3} \frac{h^2 + hk + k^2}{a^2} + \frac{l^2}{c^2}$
Trigonal/ Rhombohedral	$a = b = c$ $\alpha = \beta = \gamma$	$\frac{(h^2 + k^2 + l^2)\sin^2 \alpha + 2(hk + hl + kl)(\cos^2 \alpha - \cos \alpha)}{a^2(1 - 3\cos^2 \alpha + 2\cos^3 \alpha)}$
Monoclinic	$\alpha = \gamma = 90^\circ$	$\frac{h^2}{a^2 \sin^2 \beta} + \frac{k^2}{b^2} + \frac{l^2}{c^2 \sin^2 \beta} - \frac{2hl \cos \beta}{ac \sin^2 \beta}$
Triclinic	None	Exercise 4



## Example: SrTiO<sub>3</sub>

The crystal structure of SrTiO<sub>3</sub> is cubic, space group *Pm3m* with a unit cell edge  $a = 3.90 \text{ \AA}$ . Calculate the expected  $2\theta$  positions of the first three peaks in the diffraction pattern, if the radiation is Cu K $\alpha$  ( $\lambda = 1.54 \text{ \AA}$ ).

1. Recognize the hkl values for the first few peaks:

100, 110, 111, 200, 210, 211, 220, etc.

Calculate the interplanar spacing,  $d$ , for each peak:

$$1/d^2 = (h^2 + k^2 + l^2)/a^2$$

2. Use Bragg's Law to determine the  $2\theta$  value:

$$\lambda = 2d_{hkl} \sin \theta_{hkl}$$

## Peak Positions

$$\text{Bragg's Law: } \lambda = 2d_{hkl} \sin \theta_{hkl}$$

The interplanar spacing,  $d$ , for a given hkl reflection is given by the unit cell dimensions

*Cubic:*

$$1/d^2 = (h^2 + k^2 + l^2)/a^2$$

*Tetragonal:*

$$1/d^2 = \{(h^2 + k^2)/a^2\} + (l^2/c^2)$$

*Orthorhombic:*

$$1/d^2 = (h^2/a^2) + (k^2/b^2) + (l^2/c^2)$$

*Hexagonal:*

$$1/d^2 = (4/3)\{(h^2 + hk + k^2)/a^2\} + (l^2/c^2)$$

*Monoclinic:*

$$1/d^2 = (1/\sin^2 \beta)\{(h^2/a^2) + (k^2 \sin^2 \beta/b^2) + (l^2/c^2) - (2hlc \cos \beta/ac)\}$$

## Example: SrTiO<sub>3</sub>

***hkl = 100***

$$1/d^2 = (1^2 + 0^2 + 0^2)/(3.90 \text{ \AA})^2 \rightarrow d = 3.90 \text{ \AA}$$

$$\sin \theta_{100} = 1.54 \text{ \AA} / \{2(3.90 \text{ \AA})\} \rightarrow \theta = 11.4^\circ (2\theta = 22.8^\circ)$$

***hkl = 110***

$$1/d^2 = (1^2 + 1^2 + 0^2)/(3.90 \text{ \AA})^2 \rightarrow d = 2.76 \text{ \AA}$$

$$\sin \theta_{110} = 1.54 \text{ \AA} / \{2(2.76 \text{ \AA})\} \rightarrow \theta = 16.2^\circ (2\theta = 32.4^\circ)$$

***hkl = 111***

$$1/d^2 = (1^2 + 1^2 + 1^2)/(3.90 \text{ \AA})^2 \rightarrow d = 2.25 \text{ \AA}$$

$$\sin \theta_{111} = 1.54 \text{ \AA} / \{2(2.25 \text{ \AA})\} \rightarrow \theta = 20.0^\circ (2\theta = 40.0^\circ)$$

**How to calculate lattice parameters if we know the structure type and Miller indices**

# Tetragonal $\text{Sr}_3\text{Fe}_2\text{O}_7$

- Ruddlesden-Popper structure; consists of layers:  $\text{SrO-SrO-FeO}_2\text{-SrO-FeO}_2$
- Absorbs easily water molecules in between  $\text{SrO-SrO}$  layers
- c-parameter increases while a- and b-parameters remain nearly the same
- How can you see this from the XRD patterns: (a)  $\text{Sr}_3\text{Fe}_2\text{O}_7$ , (b)  $\text{Sr}_3\text{Fe}_2\text{O}_7 + \text{water}$

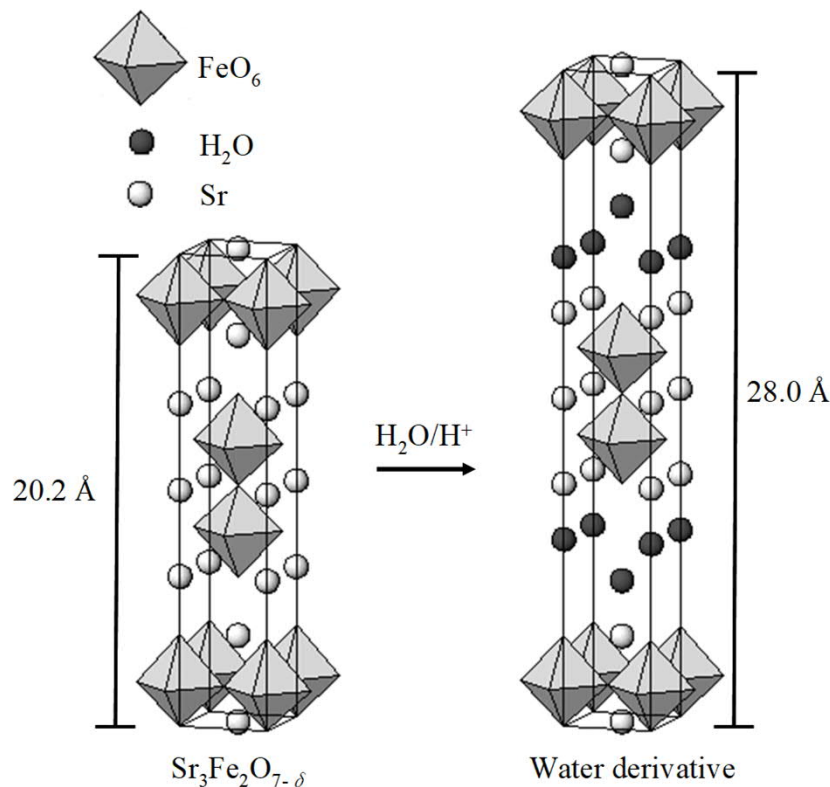

Lehtimäki, Hirasa, Matvejeff, Yamauchi & Karppinen,  
*J. Solid State Chem.* **180**, 3247 (2007).

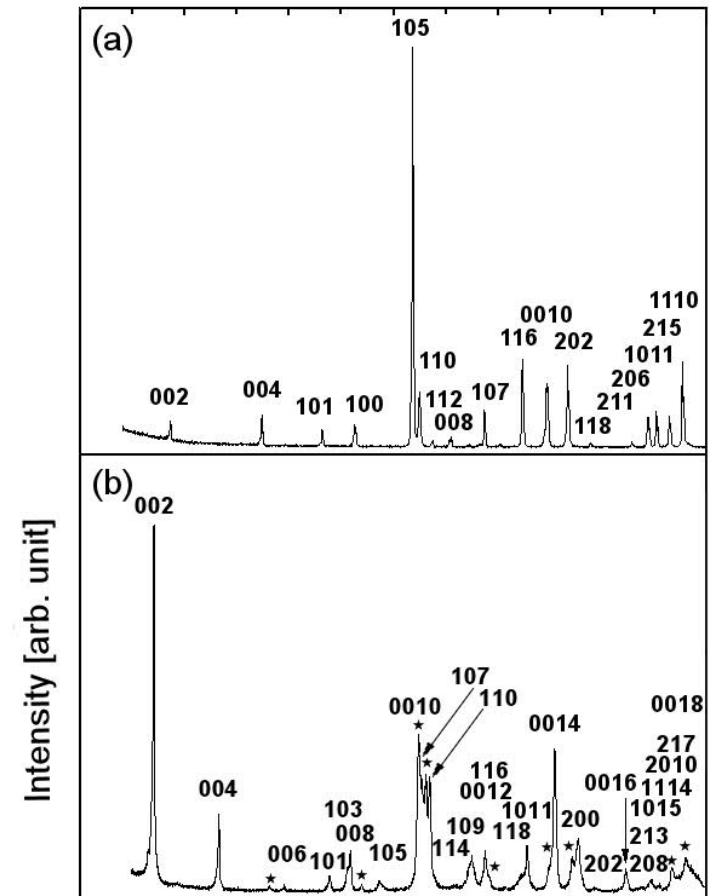

## EXAMPLE: DETERMINATION OF LATTICE PARAMETERS

Calculate the lattice parameters based on the following data for the seven first Bragg reflections:

**tetragonal**  $P4/mmm$ ;  $\text{CuK}_\alpha = 1.5406 \text{ \AA}$ .

**ANSWER:**

$$\sin^2\theta = (h^2 + k^2) \cdot \frac{\lambda^2}{4a^2} + l^2 \cdot \frac{\lambda^2}{4c^2}$$

$2\theta$	$hkl$
22.766	1 0 0
23.026	0 0 2
32.411	1 1 0
32.603	1 0 2
40.136	1 1 2
46.499	2 0 0
47.054	0 0 4

Miller	$2\theta$	$\sin\theta$	$\sin^2\theta$	Parameter ( $\text{\AA}$ )
002	23.03	0.1996	0.0398	7.724 $\rightarrow$ c
004	47.05	0.3991	0.1593	7.725 $\rightarrow$ c
100	22.77	0.1947	0.0390	3.905 $\rightarrow$ a = b
200	46.50	0.3947	0.1558	3.906 $\rightarrow$ a = b

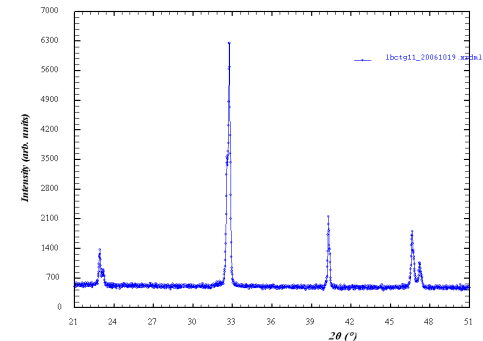

**RECOMMENDATION:** Take an average of the two values; Also, you could verify the numbers by using the 110, 102 and 112 reflections.

# Indexing

- Indexing is the process of determining the unit cell dimensions from the peak positions. To index a powder diffraction pattern it is necessary to **assign Miller indices,  $hkl$ , to each peak.**
- A diffraction pattern cannot be analyzed until it has been indexed. **It is always the first step in analysis.**
- Unfortunately it is not just the simple reverse of calculating peak positions from the unit cell dimensions and wavelength.
- We will show how one can manually index diffraction patterns of high symmetry structures. For lower symmetry structures (orthorhombic, monoclinic, triclinic) it is usually necessary to use a computer algorithm. **This is called Autoindexing.**

# Indexing a Cubic Pattern

Bragg's Law tells us the location of a peak with indices hkl,  $\theta_{hkl}$ , is related to the interplanar spacing, d, as follows:

$$\lambda = 2d_{hkl} \sin \theta_{hkl}$$

$$1/d = 2 \sin \theta / \lambda$$

$$1/d^2 = 4 \sin^2 \theta / \lambda^2$$

Earlier we saw that for a cubic phase the d-values can be calculated from the Miller indices (hkl)

$$1/d^2 = (h^2 + k^2 + l^2)/a^2$$

Combining these two equations we get the following relationship

$$\sin^2 \theta / (h^2 + k^2 + l^2) = \lambda^2 / 4a^2$$

Need to find values of h,k,l for that give a constant when divided by each  $\sin^2 \theta$ .

## Cubic Example

2-Theta	1000 $\sin^2\theta$	1000 $\sin^2\theta$ /CF	hkl
22.21	37.1		
31.61	74.2		
38.97	111		
45.31	148		
51.01	185		
56.29	222		
66.00	297		
70.58	334		
75.03	371		
79.39	408		

We need to find a common factor, CF, that can be divided into each of the values in the second column to give an integer =  $h^2+k^2+l^2$

$$CF = (37.1/1000) = \lambda^2 / 4a^2 \rightarrow (a = 4.00 \text{ \AA})$$

2-Theta	1000 $\sin^2\theta$	1000 $\sin^2\theta$ /CF	hkl
22.21	37.1	1.00	1 0 0
31.61	74.2	2.00	1 1 0
38.97	111	2.99	1 1 1
45.31	148	3.99	2 0 0
51.01	185	4.99	2 1 0
56.29	222	5.98	2 1 1
66.00	297	8.01	2 2 0
70.58	334	9.00	3 0 0 / 2 2 1
75.03	371	10.00	3 1 0
79.39	408	11.00	3 1 1

# INDEXING EXAMPLE

XRD pattern measured for a sample of cubic unit cell using Cu-K $_{\alpha}$  ( $\lambda = 1.5418 \text{ \AA}$ ) radiation shows peaks at  $2\theta$  values listed in the table below. Index the reflections. What is the Bravais lattice type?

**Answer:** First we calculate  $\sin^2\theta$  values, and multiply them by  $10^6$  just for convenience. To find the "constant value" A, we calculate the differences between consecutive  $\sin^2\theta$  values; from this list we can "see" that ca. 19355 is included as a term in all these difference numbers, hence, it could be our "A". Then we notice that  $h^2+k^2+l^2 = (10^6 \times \sin^2\theta) / A$ . Finally the hkl combinations can be easily derived from these numbers. From the resultant allowed reflections, we conclude that the lattice type is face-centered cubic.

$$\lambda = 2d \sin \theta$$

$$\frac{1}{d^2} = \frac{h^2 + k^2 + l^2}{a^2}$$

$$\frac{1}{d^2} = \frac{h^2 + k^2 + l^2}{a^2} = \frac{4 \sin^2 \theta}{\lambda^2}$$

$$\sin^2 \theta = \left( \frac{\lambda^2}{4a^2} \right) (h^2 + k^2 + l^2)$$

$$\left( \frac{\lambda^2}{4a^2} \right) \text{ is constant}$$

$2\theta$	$\sin^2\theta \cdot 10^6$	Difference	Constant	$\frac{\sin^2\theta \cdot 10^6}{A}$	hkl
27,88	58036			2,999	111
32,3	77369	19334	19355 (ka.)	3,997	200
46,32	154685	77316		7,992	220
54,92	212640	57955		10,986	311
57,6	232087	19446		11,991	222
67,6	309465	77378		15,989	400
74,62	367390	57925		18,982	331
76,9	386674	19284		19,978	420
85,88	464077	77403		23,977	422
92,54	522158	58081		26,978	511; 333

# Is it possible to UNAMBIGUOUSLY solve the crystal structure from the measured XRD pattern ?

- The answer is: NO; the reason is described on the following slides
- However, we can get a lot of important information from the pattern (from the peak positions, intensities and shapes)
- We can use so-called Rietveld refinement to try to solve the unknown structure by a kind of “guess-and-check” approach (this is the topic of next week’s lecture and exercise)

## Information in a Diffraction Pattern

- **Peak Positions**
  - The peak positions tell you about the translational symmetry. Namely what is the size and shape of the unit cell.
- **Peak Intensities**
  - The peak intensities tell you about the electron density inside the unit cell. Namely where the atoms are located.
- **Peak Shapes & Widths**
  - The peak widths and shapes can give information on deviations from a perfect crystal. You can learn about the crystallite size if it is less than roughly 100 - 200 nm. You can also learn about extended defects and microstrain.

## Scattering factor ( $f$ )

Describes the scattering capability of one atom (assumed to be a point); it is directly proportional to the number of electrons (in the case of XRD). For a fixed element,  $f$  also depends on scattering angle, wavelength and oxidation state. Scattering factors are tabulated.

## Structure factor ( $F$ )

Describes the overall scattering effect of all atoms in the unit cell (depends on the particular atoms and their positions = symmetry).  $F_{hkl}$  is a complex number with amplitude  $|F_{hkl}|$  and phase angle. Diffraction intensity is proportional to the square of the structure factor.

## Electron density map

If the structure factor is known, it is possible to calculate electron densities within the unit cell (through Fourier transform). From such electron density map the locations of the (heavy) atoms can be "seen".

## Phase problem

Because reflection intensity is proportional to  $F^2$  (not  $F$ ), it is not possible to derive phase angle from the measured intensities, only the amplitude. In other words, we lose part of the information !



# Peak intensity

There are many influences on the intensities of the diffraction pattern (instrument, thermal vibrations of the atoms etc.) but one of these factors depends only on the structure of the crystal – aptly named

## The Structure factor

$$F(hkl) = \sum_{j=1}^N f_j e^{2\pi i(hx_j + ky_j + lz_j)}$$

N is the number of atoms in the cell,  $f_j$  is the **form factor** of the  $j$ th atom and  $xyz$  are the structural coordinates of this atom.

The intensity of a peak is proportional to  $F^2$ .

## Form factor (X-rays)

Also called scattering factor!

$$f(q) = \sum_{i=1}^4 a_i e^{-b_i \left(\frac{q}{4\pi}\right)^2} + c_i$$

With  $q$  being the scattering vector,  $a_i, b_i, c_i$  are atom specific values that are tabulated (e.g. In the international tables for crystallography, who would have guessed...)

## The phase problem

We can write:

$$F(hkl) = |F(hkl)| e^{i\phi(hkl)}$$

With  $|F(hkl)|$  being the amplitude and  $\Phi$  being the „phase“. Because we can get the amplitude but not the phase we can't solve this and just calculate the electron density directly. This is called the:

### Phase Problem

## The structure Factor

The intensity of a peak is proportional to  $F^2$ !

The electron density as function of  $xyz$  can be expressed as:

$$\rho(xyz) = \frac{1}{V} \sum_{hkl} F(hkl) e^{-2\pi i(hx + ky + lz)}$$

But unfortunately we can't measure  $F(hkl)$  we only measure  $F^2$ , from which we can get  $|F(hkl)|$  which is the same as  $|F(\overline{hkl})|$

$$|F(hkl)| = |F(\overline{hkl})|$$

(this is called "Friedels law")

## Form factor (X-rays)

The form factor is related to:

- The number of electrons (think 1 to 1)
- Small ions get easily lost e.g.  $\text{LaTiO}_3$
- Can't discriminate between atoms close e.g. Fe Cr
- Angle dependent i.e. decay at high angles.

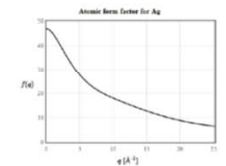
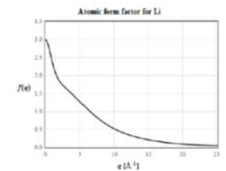

Form factors for Li and Ag

**WE DO NOT GO DEEP INTO THESE EQUATIONS; JUST GET AN IDEA!**

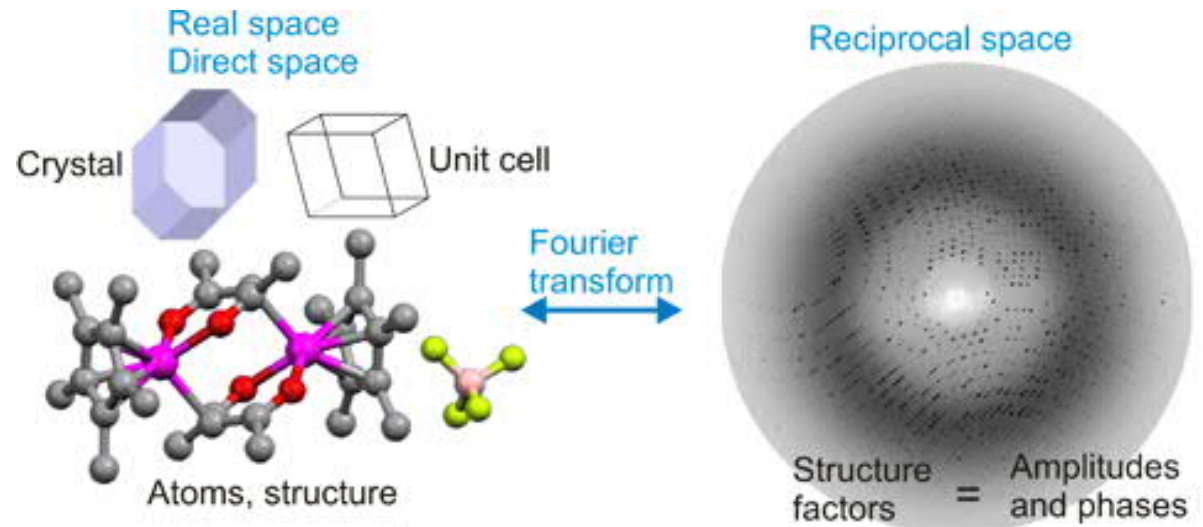

## PEAK INTENSITY

$$I_{hkl} = sLpF^2_{hkl}$$

$$\rho(xyz) = \frac{1}{V} \sum_{hkl}^{+\infty}_{-\infty} \underbrace{|F(hkl)|}_{\text{Amplitudes}} \cdot e^{-2\pi i[hx+ky+lz-\underbrace{\phi(hkl)}_{\text{Phases}}]}$$

Real space  
Direct space

Reciprocal space

**Amplitude:  $|F_{hkl}| = \sum_j f_j N_j (\exp[(2\pi i)(hx_j + ky_j + lz_j])) \exp(-M_j)$**

$f_j$  = **scattering factor** (of atom j) ; depends on the number of electrons

$N_j$  = **occupancy factor** (of the atom on the site)

$M_j = 8\pi^2 U_{iso}^2 \sin^2 \theta / \lambda^2 \rightarrow U_{iso} =$  (square root of the mean) **thermal parameter**

## **SUMMARY IN BRIEF**

- **When X-rays of suitable wavelength hit crystals, a diffraction pattern is produced which is reciprocal to the real space pattern**
- **From this reciprocal pattern (including systematic absences) we can gain information about the lattice type and the unit cell parameters**
- **From the peak intensities, we can get the amplitude of the structure factor, but not the phase. This is so-called phase problem prevents us from directly calculating the atomic positions within the cell**
- **To solve the entire crystal structure, we need to use an iteration method, i.e. guess the structure, calculate structure factor and diffraction pattern, compare it with the experimental pattern, and make a new improved guess → This is called Rietveld method (next week!)**

# Le Bail

- Powder diffraction patterns are commonly complicated by overlapping diffraction peaks
- Le Bail method extracts intensities ( $I_{hkl}$ ) from powder diffraction data
- The approximate unit cell and space group are given as an input
- The algorithm refines the unit cell, the profile parameters and the peak intensities to match the measured powder diffraction pattern
- The structure factor and the associated structural parameters (atomic positions, etc.) are not included in the analysis
- The method provides a quick method to refine the unit cell
- "Modern phase identification method"

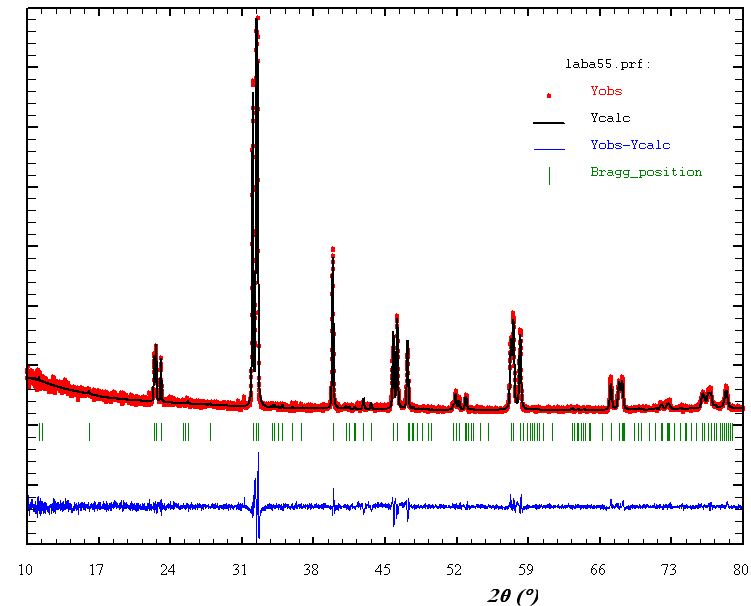

# INFORMATION FROM POWDER XRD DATA

1. Lattice parameters
2. Positions of (heavier) metal atoms
3. Positions of lighter atoms such as oxygen atoms
4. Occupancies of atomic sites
5. Thermal parameters

Rietveld →  
next week!

## DEBYE-WALLER FACTOR (thermal motion)

- All atoms vibrate at their atomic lattice sites
- This vibration enhances with increasing temperature
- Thermal motion decreases the atomic scattering factor ( $f$ )
- Light atoms usually vibrate more strongly
- "Terminal" atoms usually vibrate more strongly than atoms with multiple bonds
- Vibration is typically unisotropic (described using ellipsoids)

**BY THE WAY, PLEASE CONFIRM THAT YOU UNDERSTAND THE CONCEPTS/WORDS (we will come to these again later)**

- **Lattice point**
- **Atom site in crystal structure**
- **Site multiplicity: Number of atom positions produced by the symmetry of a space group from a single site noted in structure descriptions**
- **Site occupation factor: Probability to find the atom at a specific site; this value ranges from 0 (no atom) to 1 (100%; site fully occupied)**

# FINAL NOTE:

- In many XRD diffractometers it is possible to heat or cool the sample and also sometimes to control the atmosphere
- As an example, below are XRD patterns collected for a superconductor sample upon heating to see its gradual loss of oxygen (small structural changes) and then complete decomposition

## High Temperature XRD Patterns of the Decomposition of $\text{YBa}_2\text{Cu}_3\text{O}_{7-\delta}$

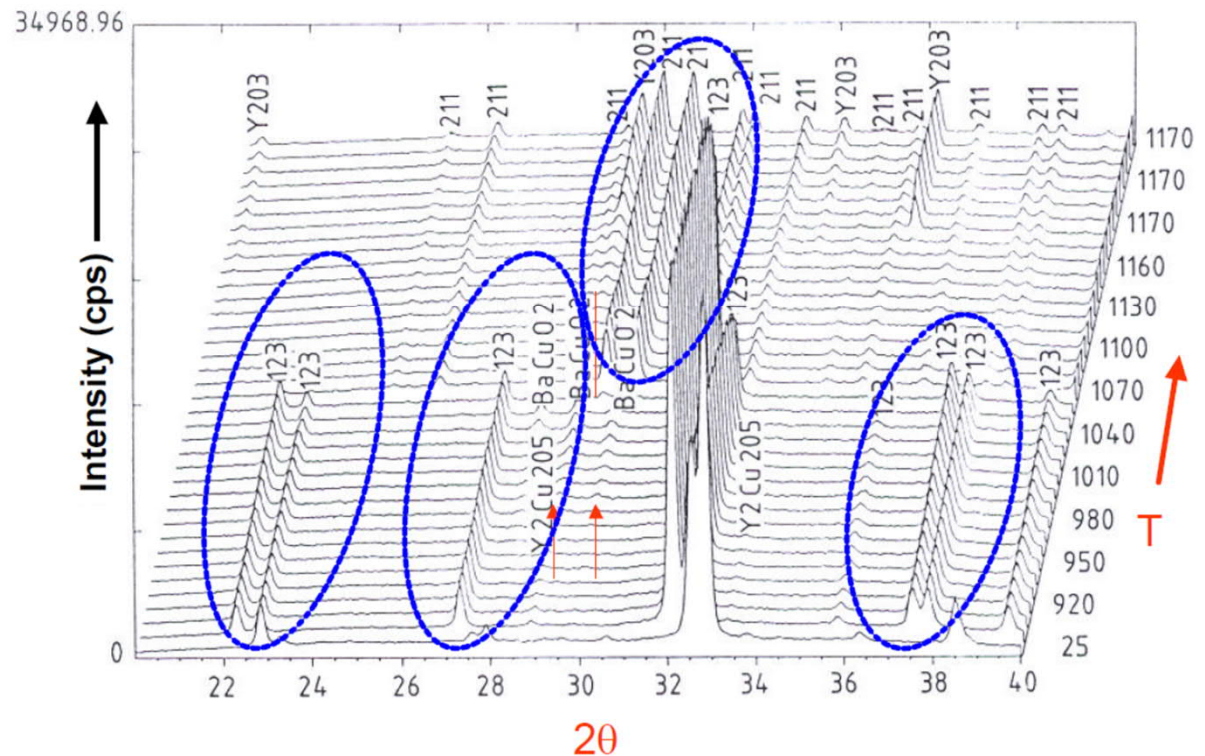

# Information Content of an Idealized Diffraction Pattern

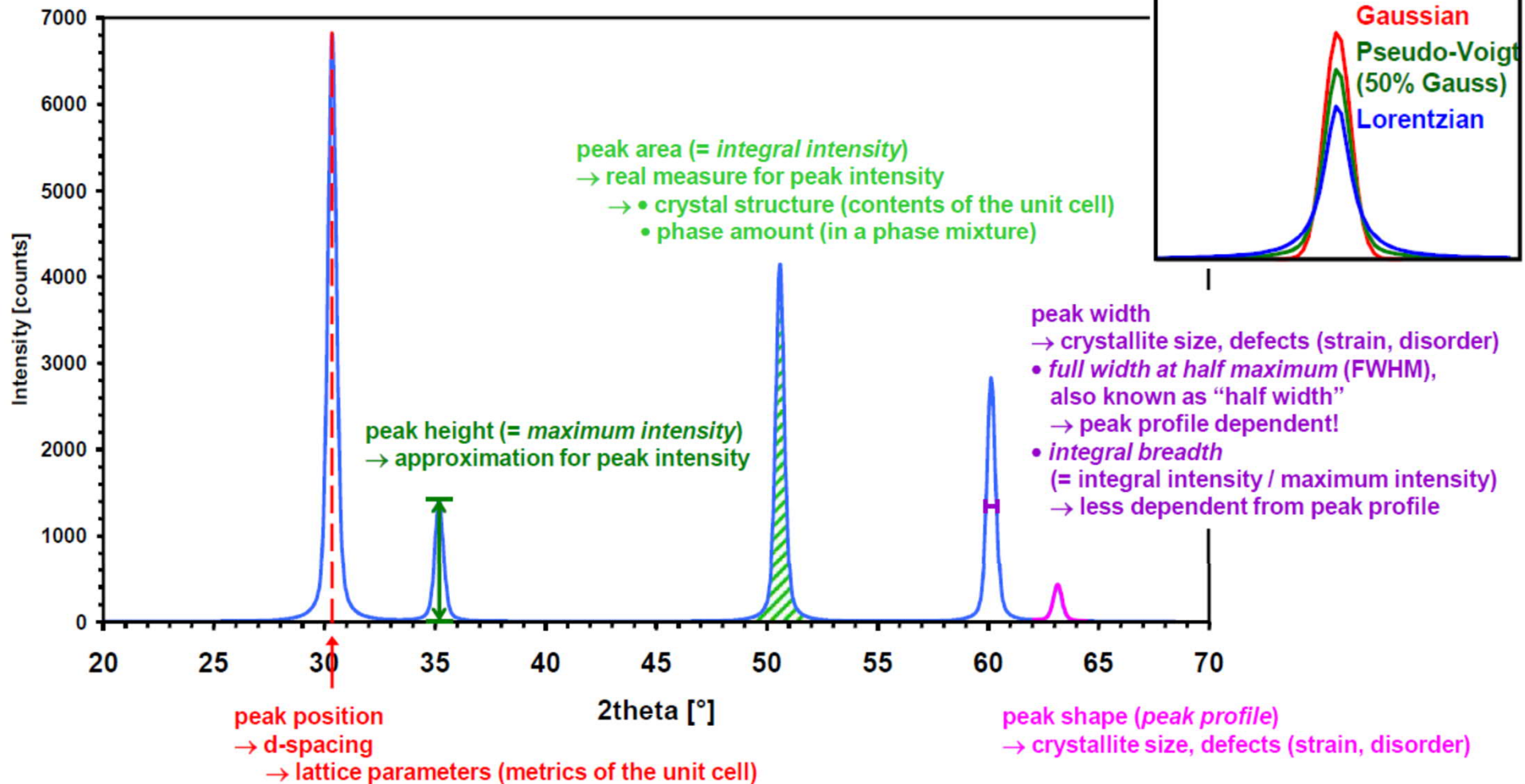



# Peak Width-Full Width at Half Maximum

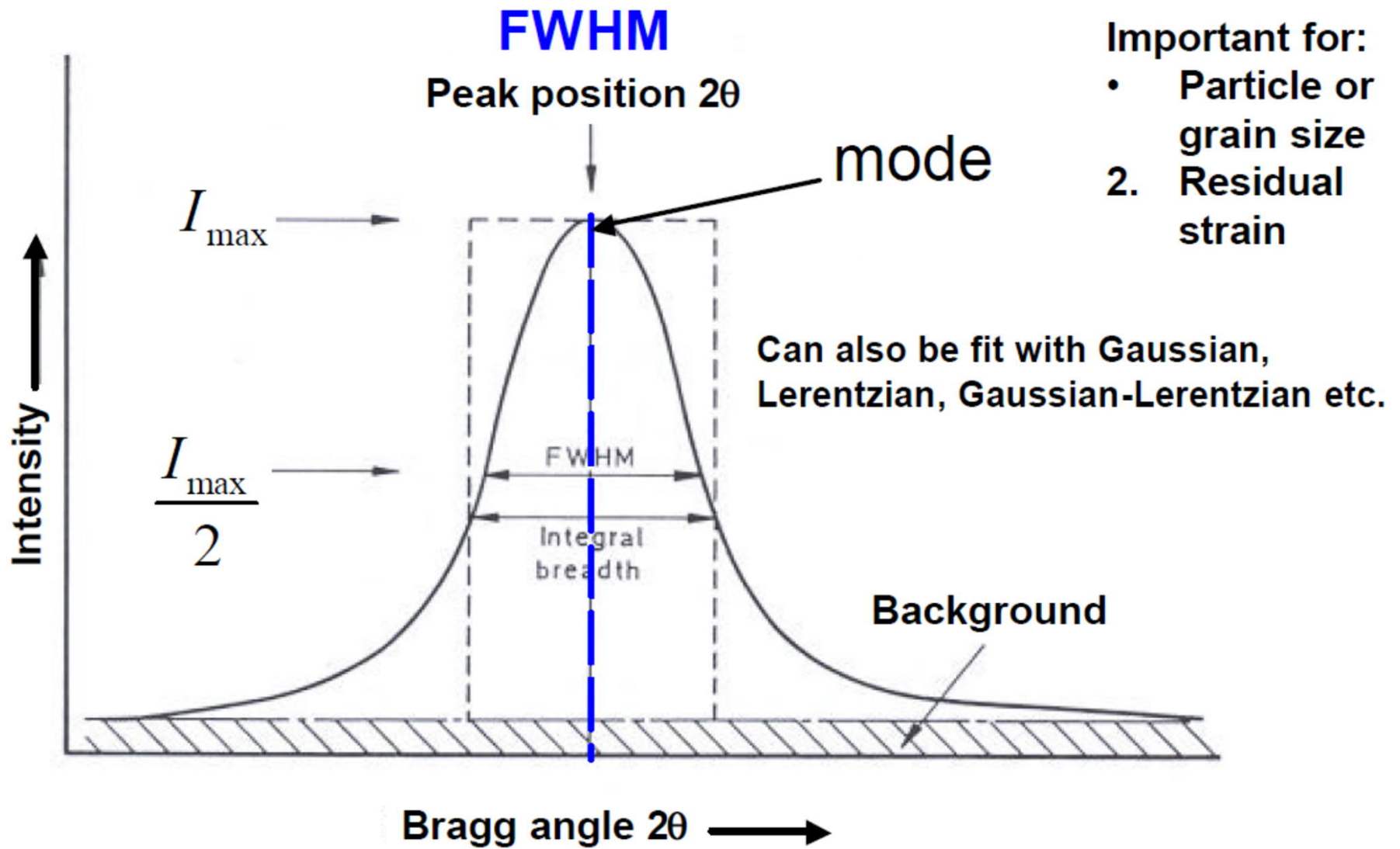

# SOME ISSUES in XRD (1):

- Sample displacement
- Instrumental “zero” shift → Si standard

## Sample Displacement Error

- In general, peak positions are the most accurate measure in powder diffraction.
- However, in Bragg-Brentano geometry, peak positions are very sensitive to sample position.

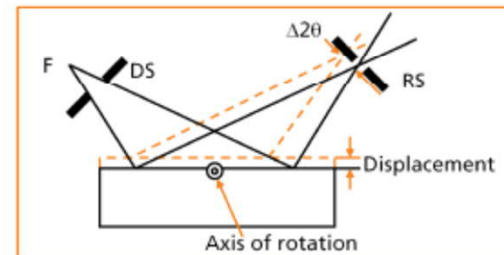

The peak shift effect due to specimen displacement is maximal for low angles and zero at  $180^\circ 2\theta$ .

An indication of the specimen displacement effect:  $\Delta 2\theta \approx 0.06^\circ$  at  $2\theta = 30^\circ$  for  $100 \mu\text{m}$  displacement.

# SOME ISSUES (2)

- Amorphous sample: flat and very broad peaks and elevated background
- Particle size decreases → peaks get broader
- The peak width can be used for particle size determination (Scherrer equation)

Alumina Powder Diffraction

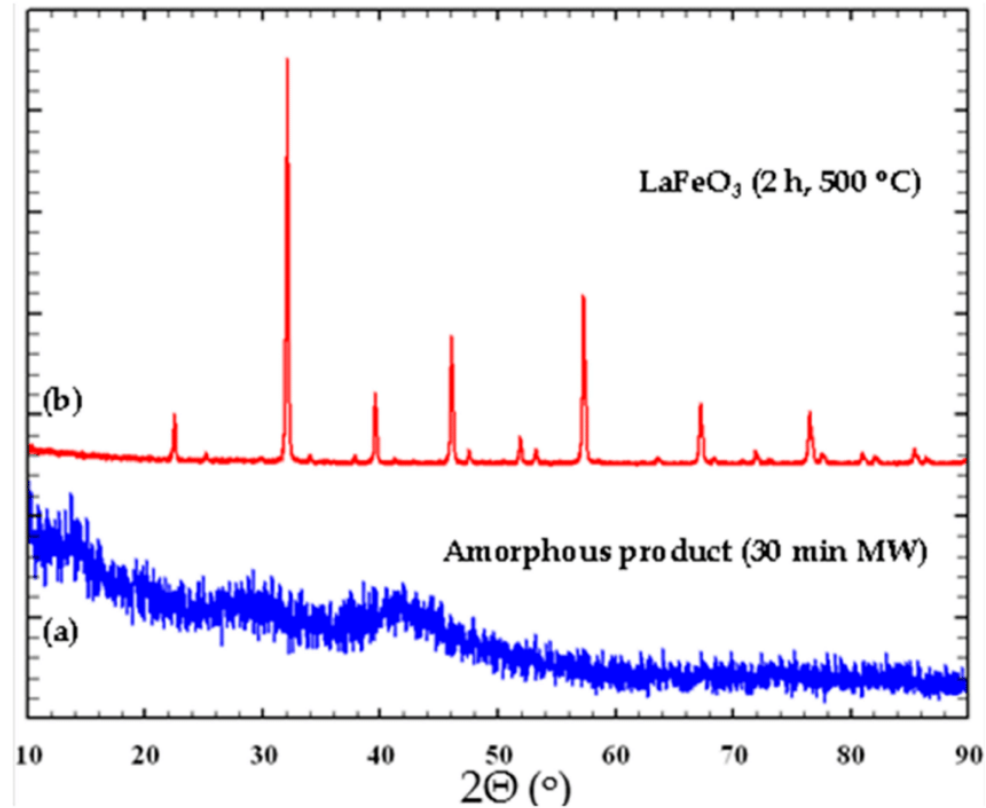
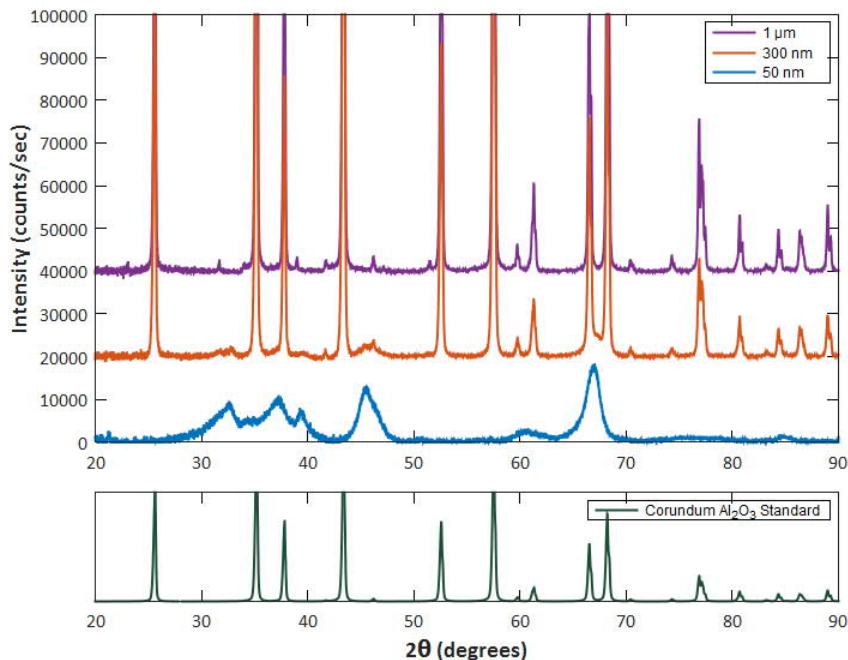

The Scherrer Equation was published in 1918

$$B(2\theta) = \frac{K\lambda}{L \cos \theta}$$

Peak width (B) is inversely proportional to crystallite size (L)

# SOME ISSUES (3)

- Preferred orientation → some peaks gain intensity, some lose it

 PANalytical

## Preferred Orientation

- Extreme problem for powder samples with crystal-related shape or non-spherical particles

Preferred orientation

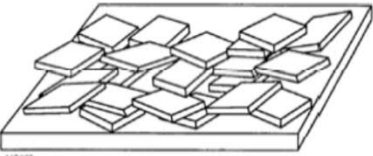

Random orientation

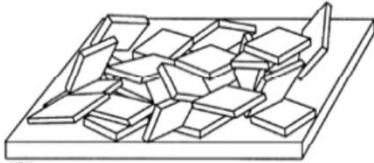

Basic XRD Course © 2013 PANalytical B.V. All rights reserved. 26

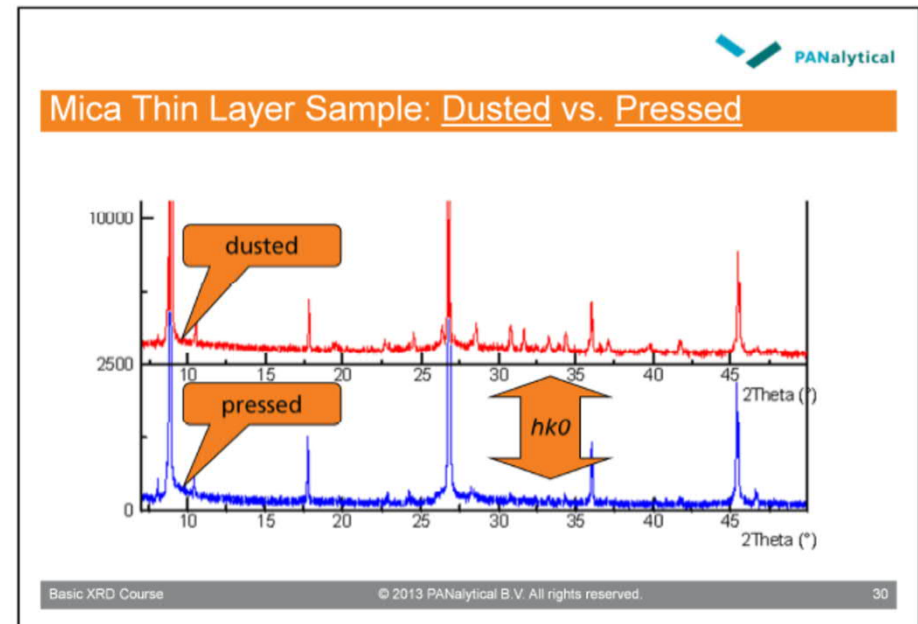

The dusted sample has a random orientation.

The pressed sample has a preferred orientation (reflections of type  $hk0$  disappear).

# SOME MORE ISSUES: STRAIN EFFECT

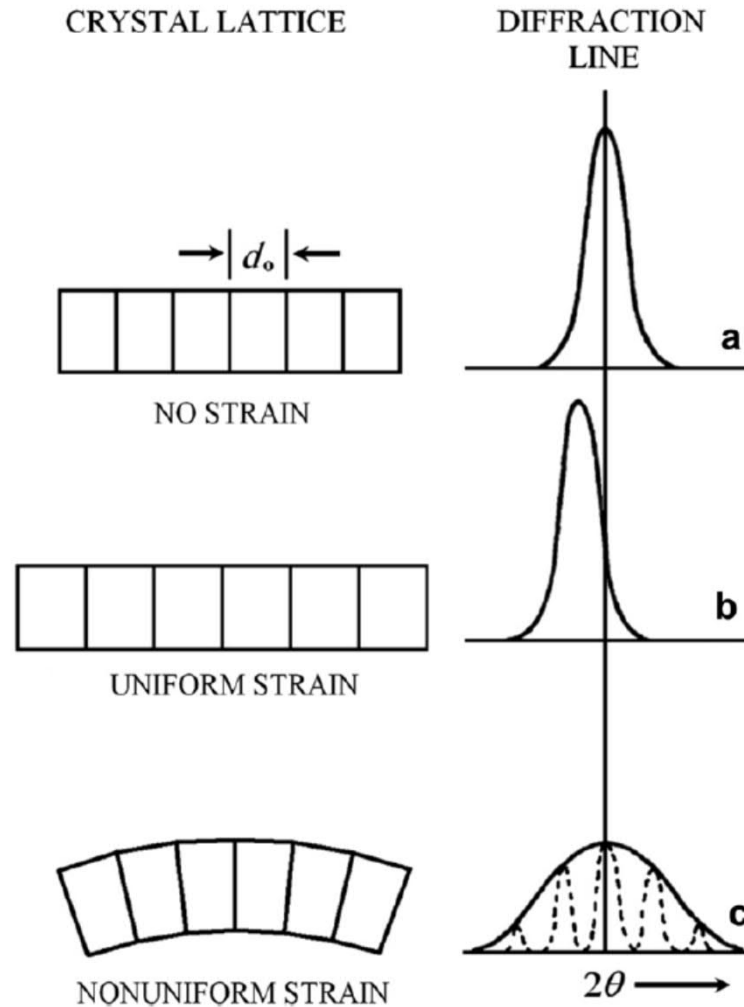

# MORE ISSUES ...

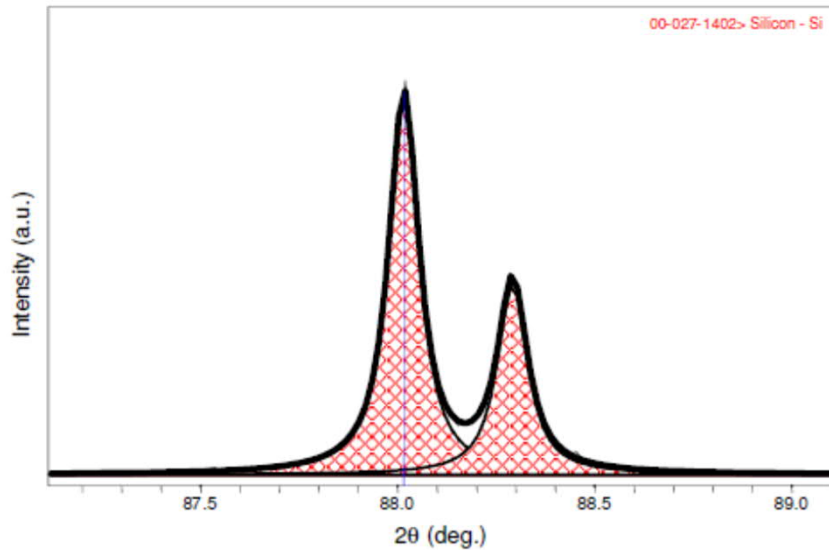

This is a single diffraction peak, featuring the  $K\alpha_1$  and  $K\alpha_2$  doublet

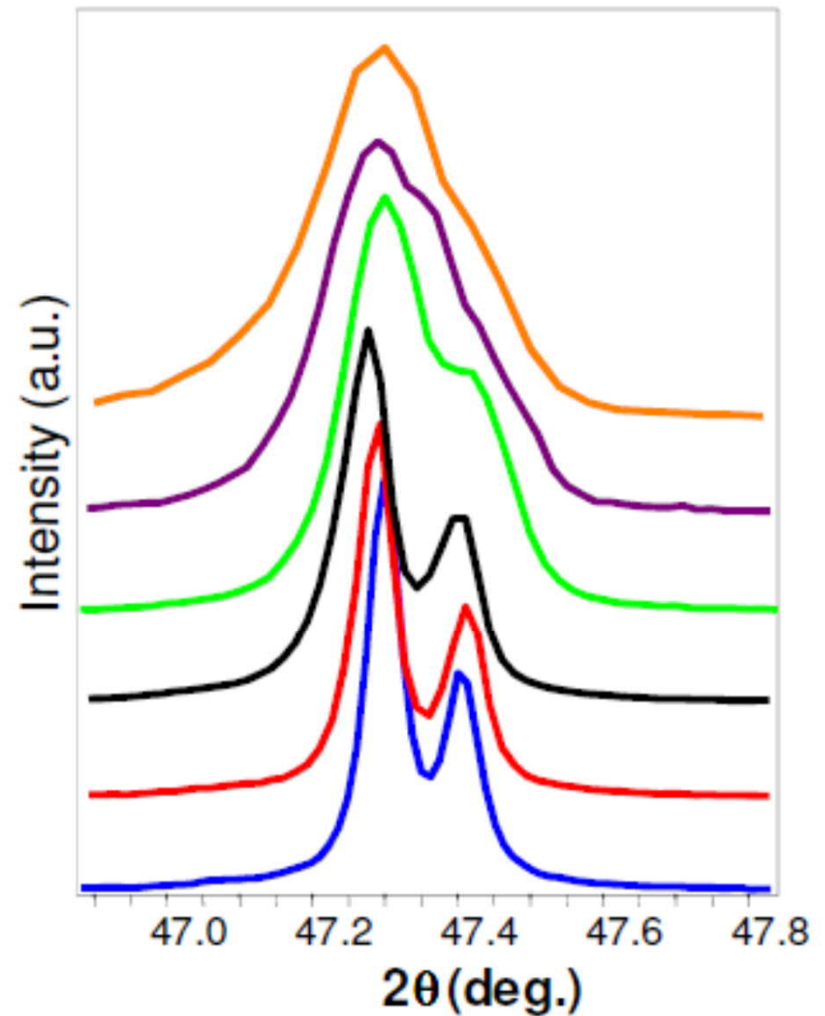

Patterns collected from the same sample with different instruments and configurations at MIT

<http://prism.mit.edu/xray>