

Functional Inorganic Materials

Fall 2021

Tuesdays: 14.15 - 16.00
Thursdays: 12.15 - 14.00
Remote Zoom lectures

#	Date	Who	Topic
1	Tue 02.11.	Maarit	Introduction + Materials design
2	Thu 04.11.	Antti	Computational materials design
3	Tue 09.11.	Maarit	Superconductivity: High- T_c superconducting Cu oxides
4	Thu 11.11.	Maarit	Ionic conductivity (Oxygen): SOFC and Oxygen storage
5	Tue 16.11.	Maarit	Ionic conductivity (Lithium & Proton): Li-ion battery
6	Thu 18.11.	Antti	Thermal conductivity
7	Tue 23.11.	Antti	Thermoelectricity
8	Thu 25.11.	Maarit	Hybrid materials
9	Tue 30.11.	Maarit	Luminescence materials
10	Thu 02.12.	Antti	Piezoelectricity
11	Tue 07.12.	Antti	Pyroelectricity and ferroelectricity
12	Thu 09.12.	Antti	Magnetic and multiferroic oxides

LECTURE EXERCISE 9

- 1. Photoluminescence is a light conversion process, but is it for up- or down-conversion? Could it be (in principle) utilized for enhancing solar cells? Please, elaborate your answer little bit.**
- 2. Propose an explanation why some Eu-organic materials have shown to yield intense luminescence emission, while Eu_2O_3 does not yield.**
- 3. Your supervisor assigns to you the following research topic: Select one of the two compounds, $\text{LaMgB}_5\text{O}_{10}$ or $\text{LaSrB}_5\text{O}_{10}$, and find the optimal lanthanide(s) to be used as chemical substituent(s) to modify the compound so that it would yield intense white light luminescence. Which host compound and substituent(s) you would select? Why? Would you synthesize the substituted material under oxidizing or reducing conditions? Why?**
- 4. Why researchers are so eager to investigate Ln-organic materials as upconversion materials?**

Electromagnetic Spectrum

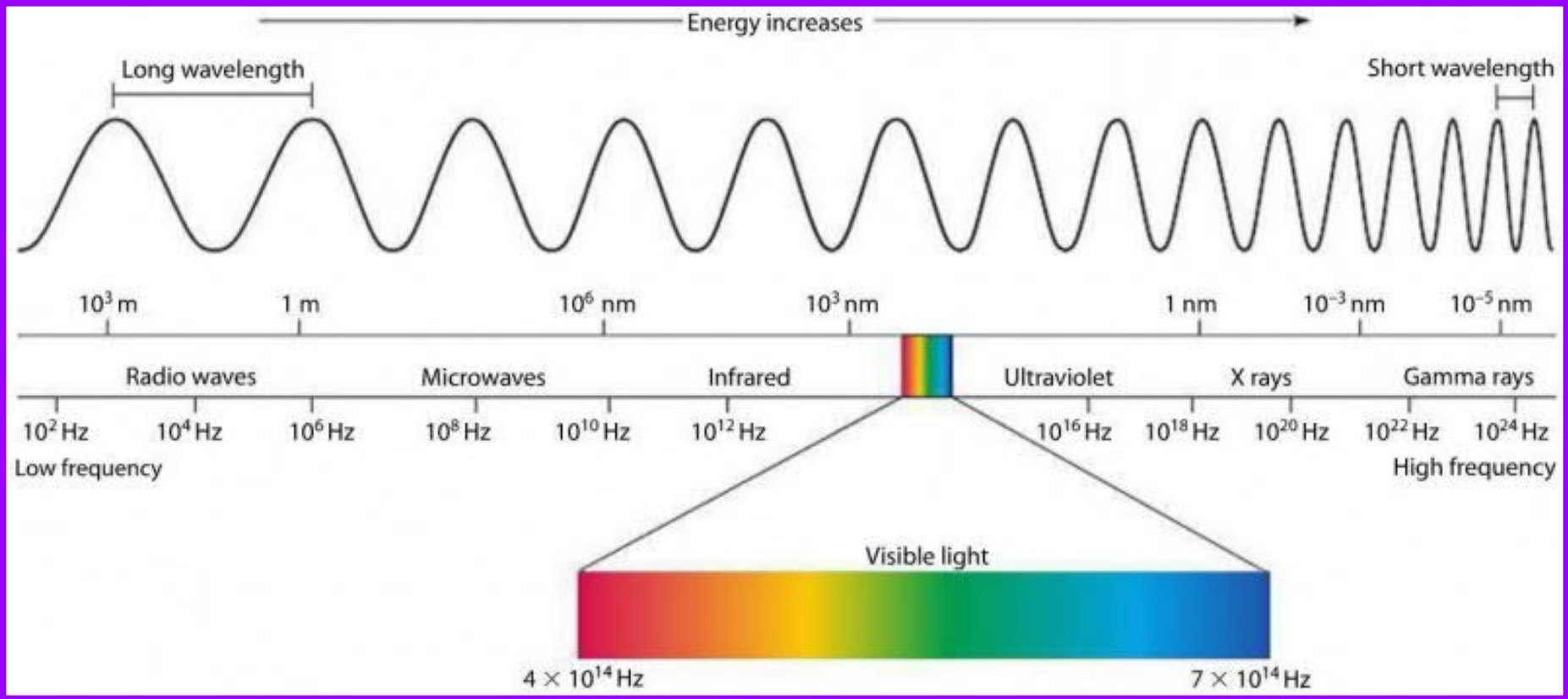

LUMINESCENCE

- Material (**phosphor**) absorbs higher-energy photon and emits smaller-energy photon (shorter-to-longer wavelength; **UV** → **Vis**)
- Energy difference typically lost as heat
- Different ways to excite luminescence:
 - **photoluminescence**
 - electroluminescence
 - thermoluminescence
 - chemiluminescence
 - triboluminescence
 - bioluminescence

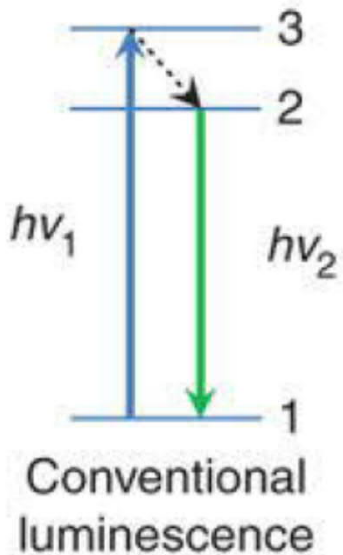

LECTURE 9: Luminescence Materials

❖ PHOTOLUMINESCENCE

- Semiconductors: ZnO
- **Lanthanide compounds**
- Host lattice, Activator, Sensitizer
- Prototype application: Fluorescence lamp

❖ UPCONVERSION

- **Lanthanide compounds**
- Possible application: Solar cell

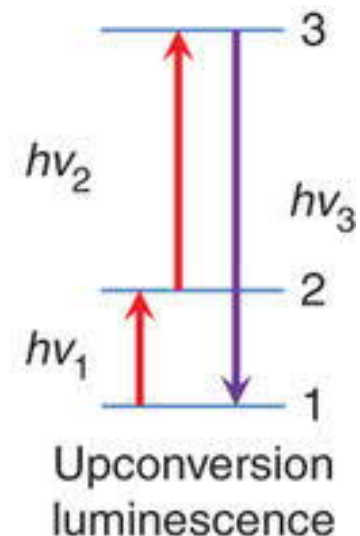
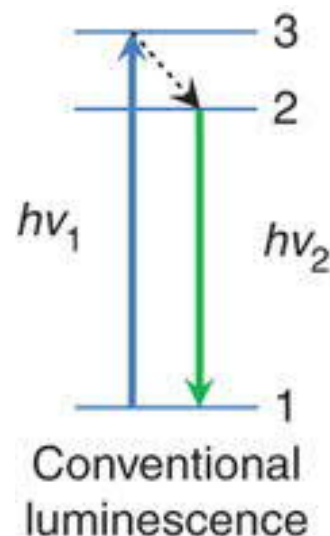

Semiconductors: ZnO

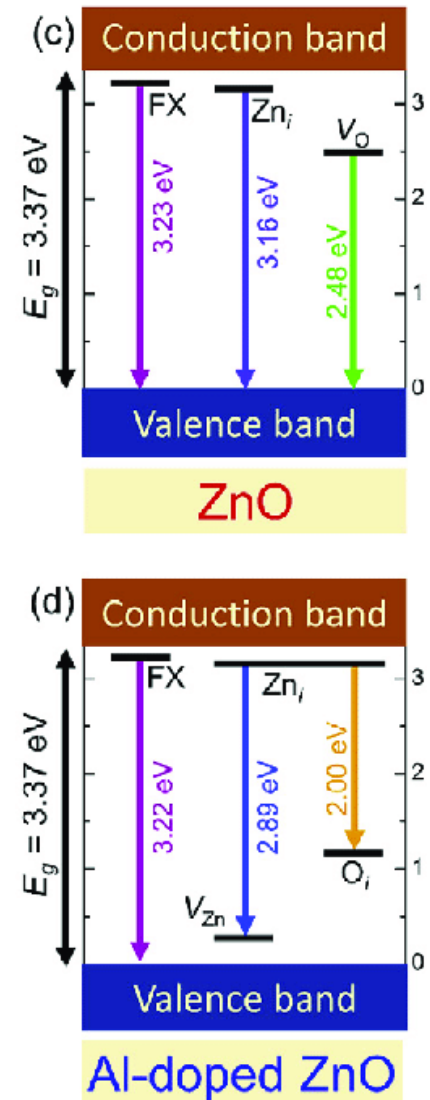
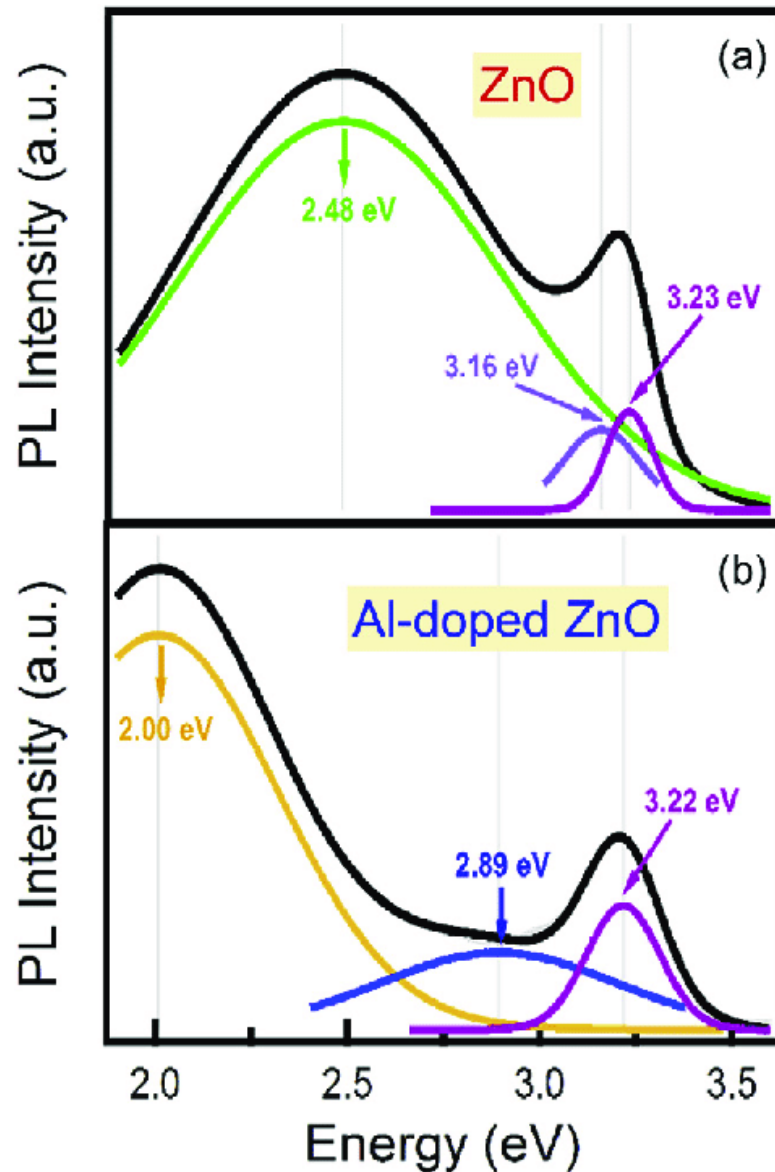
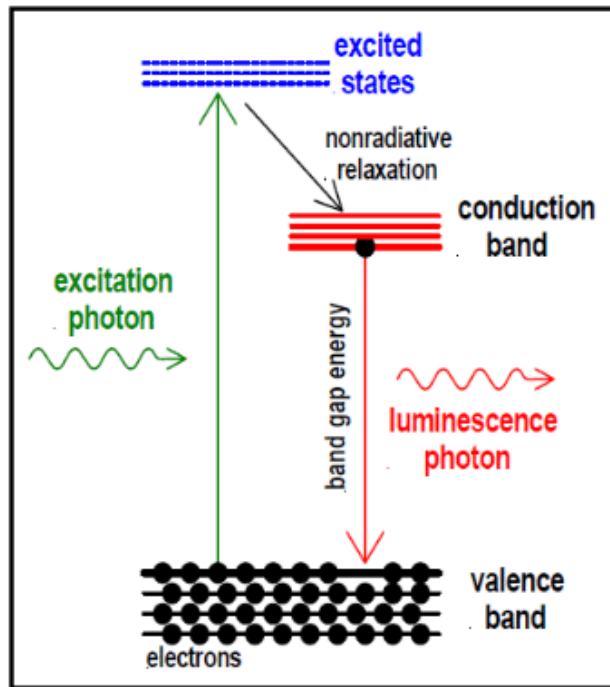

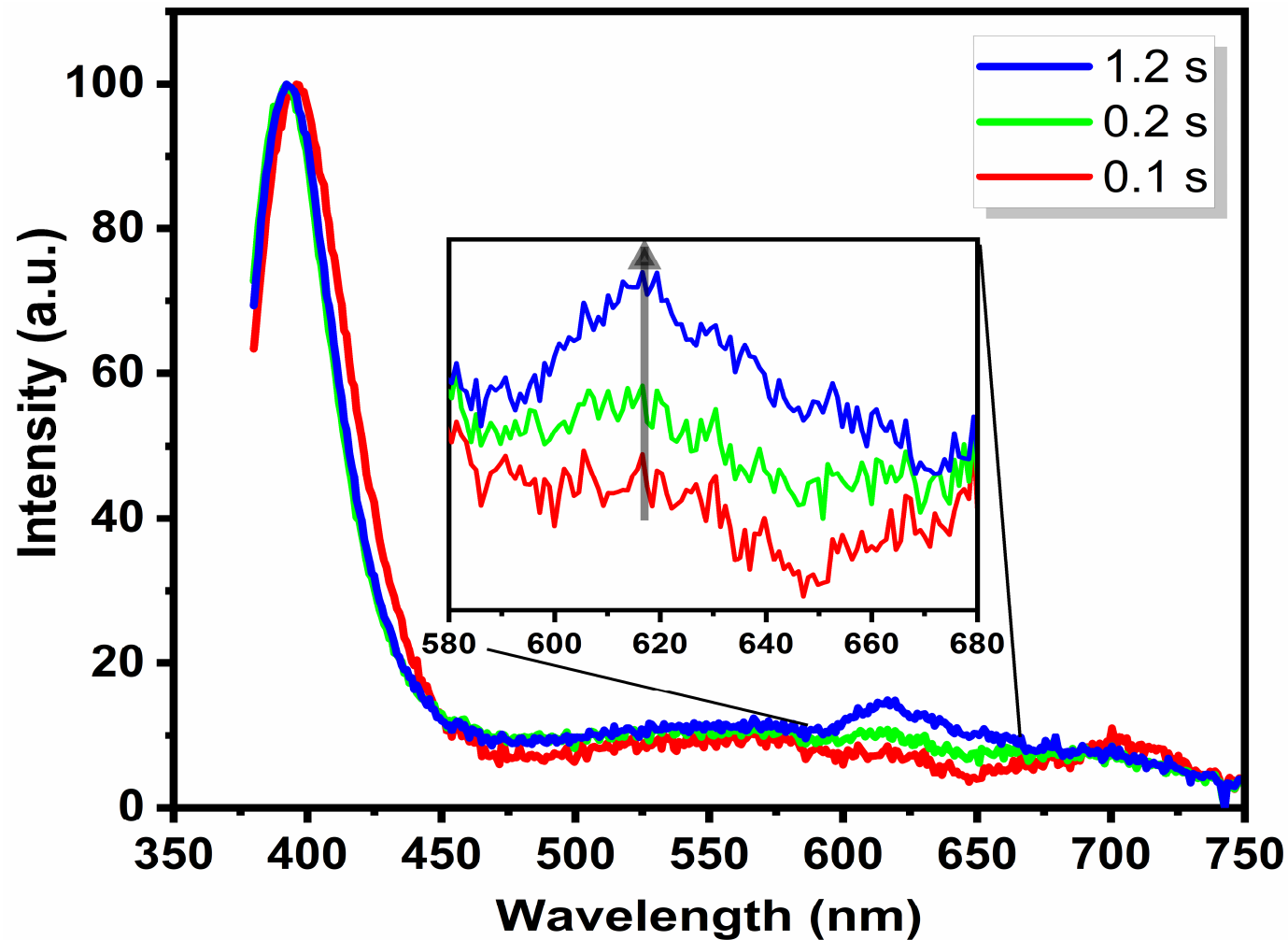

Photoluminescence spectra for ALD ZnO films (with varied purge times)

Defect peak around 618 nm:

- Due to negatively charged oxygen interstitials which have captured protons
- Increase n-type doping → Increase electrical conductivity
- Scatter phonons → Decrease thermal conductivity

1	H																18	
2	Li	Be											B	C	N	O	F	He
3	Na	Mg											Al	Si	P	S	Cl	Ar
4	K	Ca	Sc	Ti	V	Cr	Mn	Fe	Co	Ni	Cu	Zn	Ga	Ge	As	Se	Br	Kr
5	Rb	Sr	Y	Zr	Nb	Mo	Tc	Ru	Rh	Pd	Ag	Cd	In	Sn	Sb	Te	I	Xe
6	Cs	Ba		Hf	Ta	W	Re	Os	Ir	Pt	Au	Hg	Tl	Pb	Bi	Po	At	Rn
7	Fr	Ra		Rf	Db	Sg	Bh	Hs	Mt									

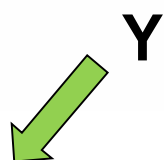

Inner Transition Elements														
f-block														
La	Ce	Pr	Nd	Pm	Sm	Eu	Gd	Tb	Dy	Ho	Er	Tm	Yb	Lu
Ac	Th	Pa	U	Np	Pu	Am	Cm	Bk	Cf	Es	Fm	Md	No	Lr

→ Lanthanides (Ln)

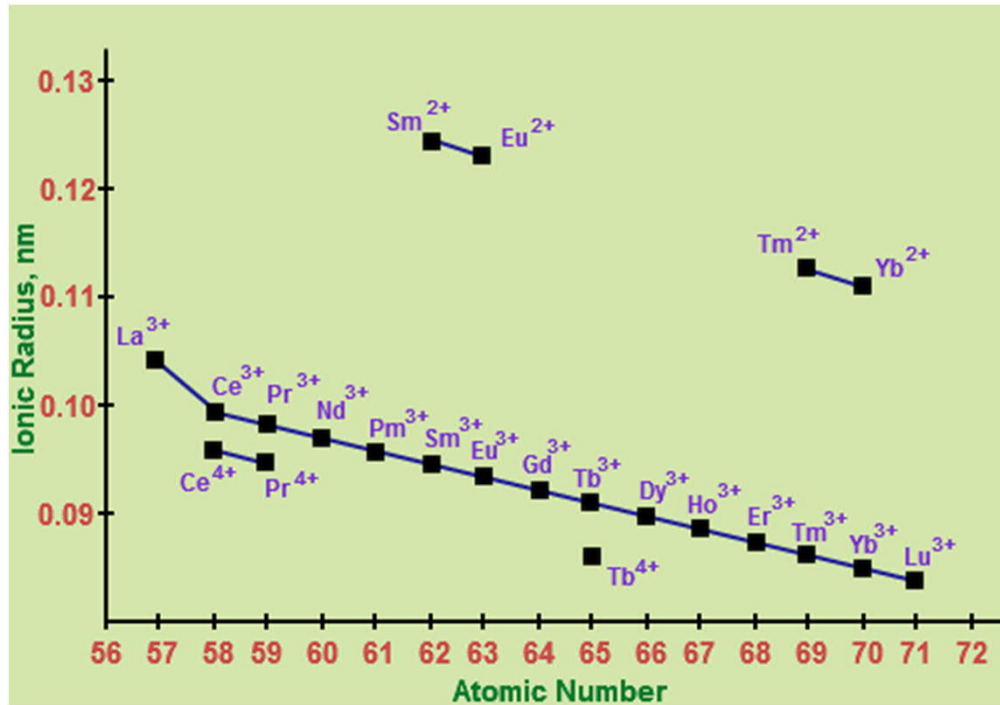

La	lanthanum	Tb	terbium
Ce	cerium	Dy	dysprosium
Pr	praseodymium	Ho	holmium
Nd	neodymium	Er	erbium
Pm	promethium	Tm	thulium
Sm	samarium	Yb	ytterbium
Eu	europium	Lu	lutetium
Gd	gadolinium	Y	yttrium

Electronic configurations and oxidation states of lanthanides (Ln)

Z	Element	Electronic configuration	Oxidation states
57	Lanthanum (La)	$4f^05d^16s^2$	+III
58	Cerium (Ce)	$4f^15d^16s^2$	+III, +IV
59	Praseodymium (Pr)	$4f^25d^16s^2$	+III
60	Neodymium (Nd)	$4f^35d^16s^2$	+III
61	Promethium (Pm)	$4f^45d^16s^2$	+III
62	Samarium (Sm)	$4f^55d^16s^2$	+III
63	Europium (Eu)	$4f^75d^06s^2$	+II, +III
64	Gadolinium (Gd)	$4f^75d^16s^2$	+III
65	Terbium (Tb)	$4f^75d^26s^2$	+III, +IV
66	Dysprosium (Dy)	$4f^95d^16s^2$	+III
67	Holmium (Ho)	$4f^{10}5d^16s^2$	+III
68	Erbium (Er)	$4f^{11}5d^16s^2$	+III
69	Thulium (Tm)	$4f^{12}5d^16s^2$	+III
70	Ytterbium (Yb)	$4f^{14}5d^06s^2$	+II, +III
71	Lutetium (Lu)	$4f^{14}5d^16s^2$	+III

4f orbitals

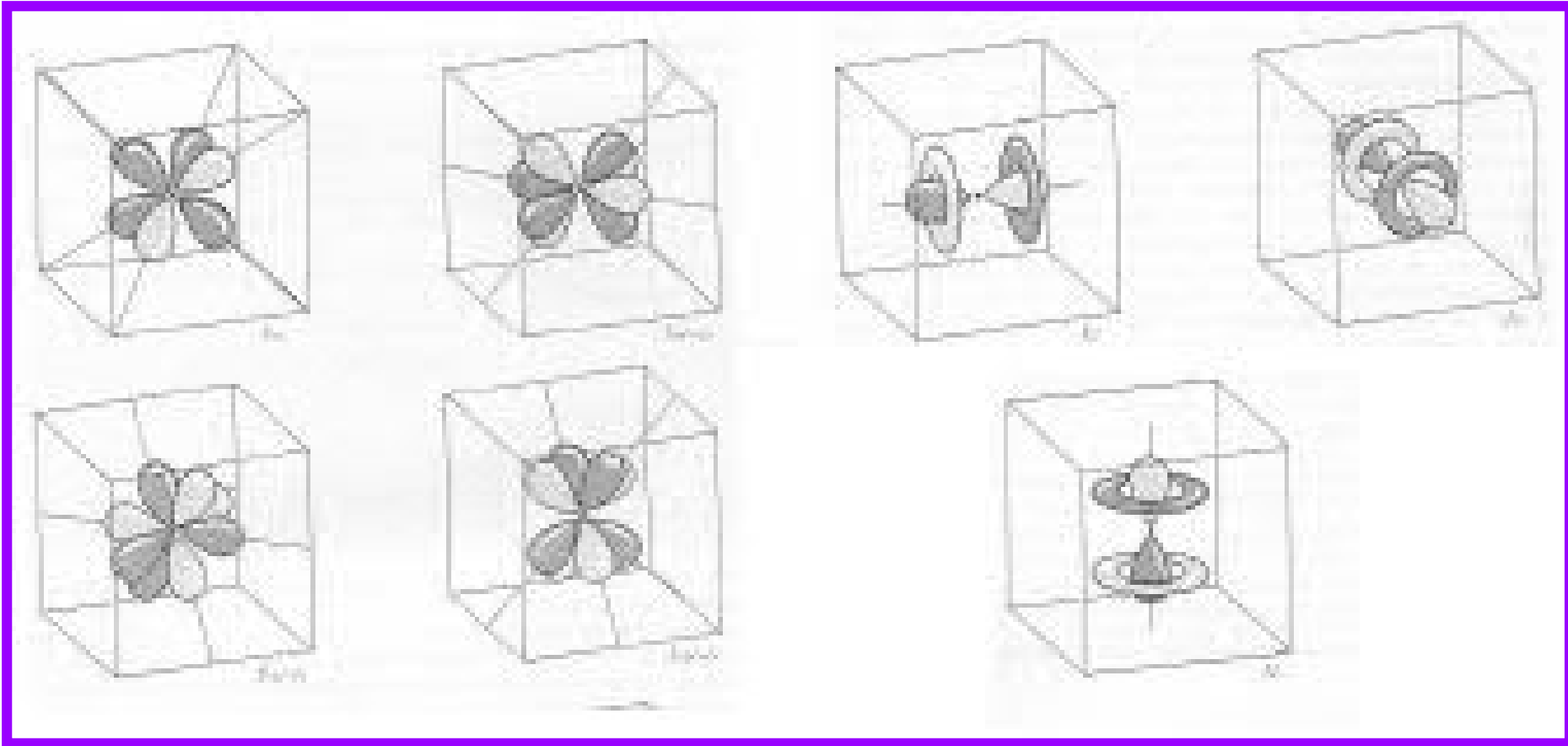

SPECTROSCOPIC PROPERTIES

- In solid: 4f orbital energies splitted due to crystal field effect (ref. d orbitals)
- More complicated splitting scheme compared to the case of d orbitals

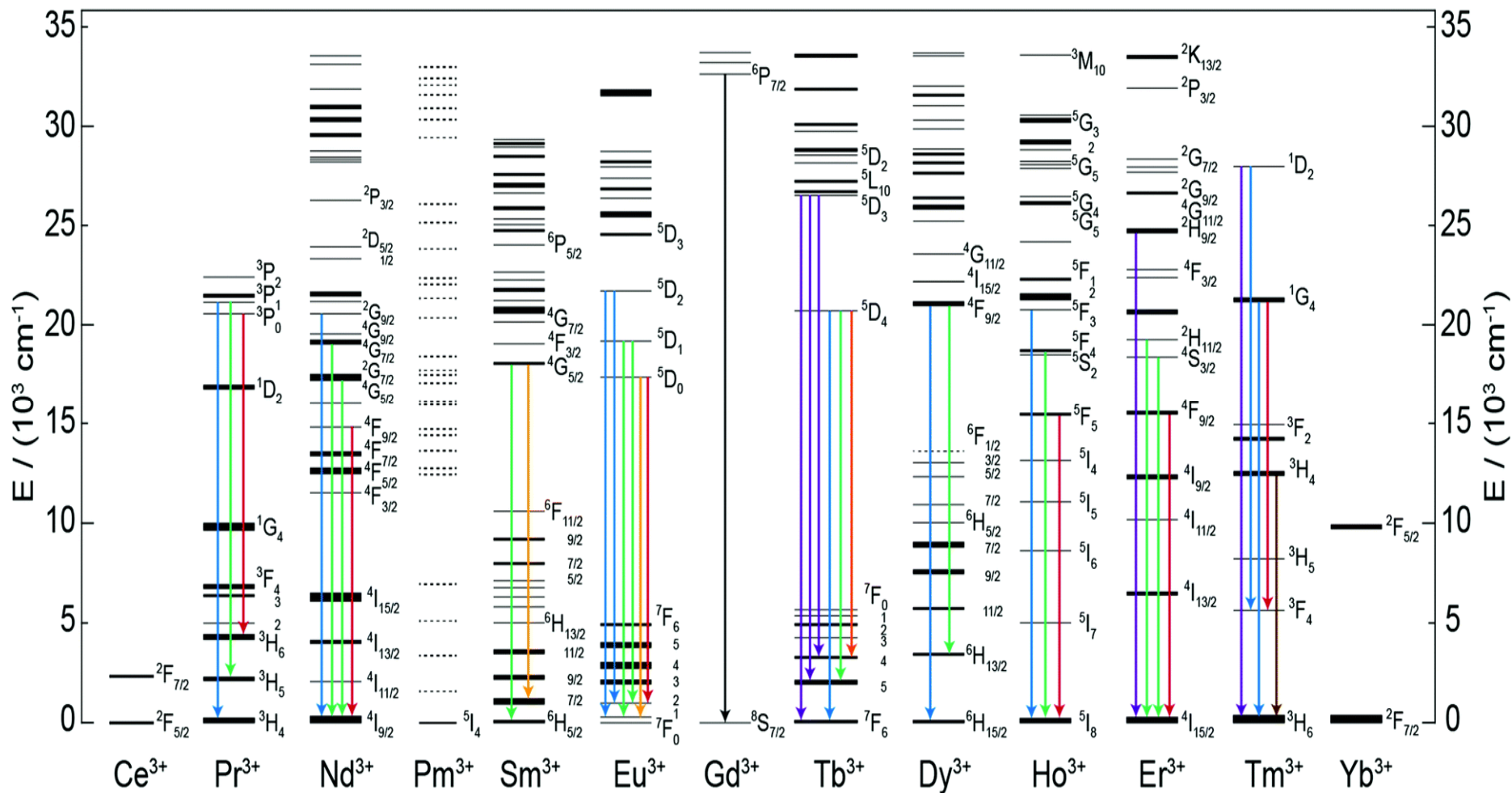

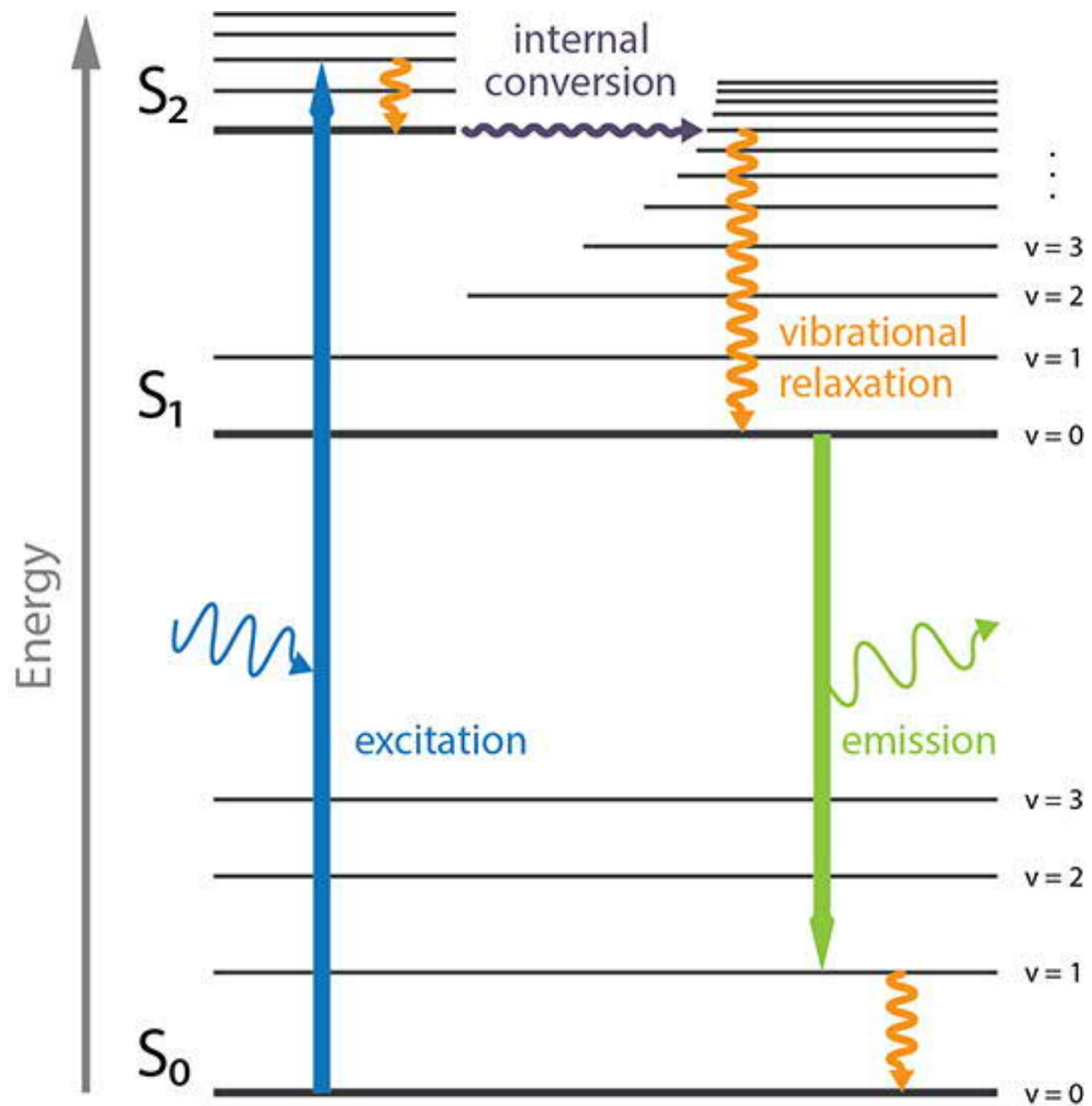

ENERGY TRANSFER: Sensitizer (S) → Activator (A)

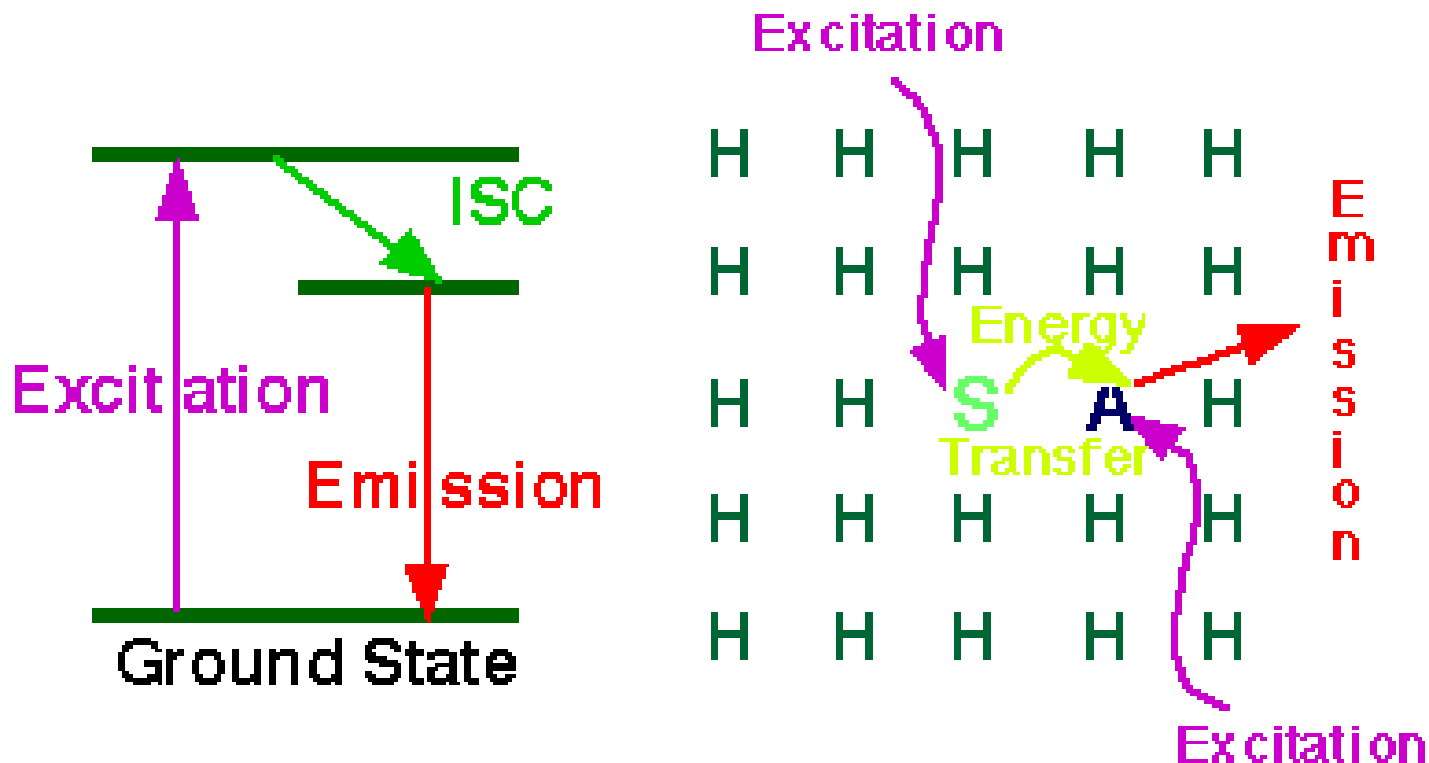

LANTHANIDES in Optoelectronics

- **Electron transitions within 4f orbitals**
& between 4f and 5d orbitals
→ lanthanides have unique optical properties
- **4f orbitals embedded deep within outer orbitals**
→ energy levels not much affected by surroundings
→ emission wavelengths narrow/fixed
- **Absorption efficiency low for f-f transitions**
→ use of sensitizers
- **Fluorescent lamps:**

$Y_2O_3:Eu^{3+}$	red
$CeMgAl_{11}O_{19}:Tb^{3+}$	green
$(Ce,Gd)MgB_5O_{10}:Tb^{3+}$	green
$BaMgAl_{10}O_{17}:Eu^{2+}$	blue
$Sr_5(PO_4)_3(F,Cl):Eu^{2+}$	blue
- **EL displays:**

$ZnS:Mn^{2+}$	yellow
$SrS:Ce^{3+}$	bluishgreen
$ZnS:Tb^{3+}$	green
- **Lasers:**

$Y_3Al_5O_{12}:Nd^{3+}$	1064 nm
-------------------------	---------

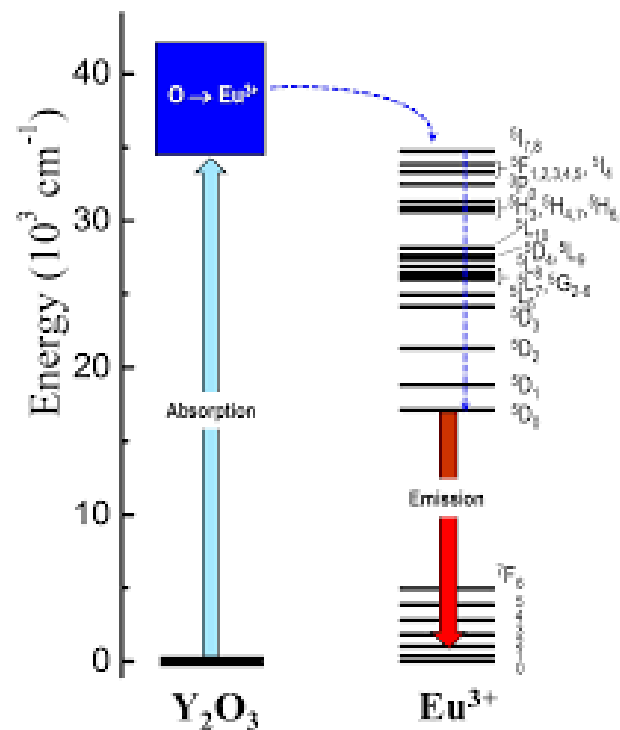

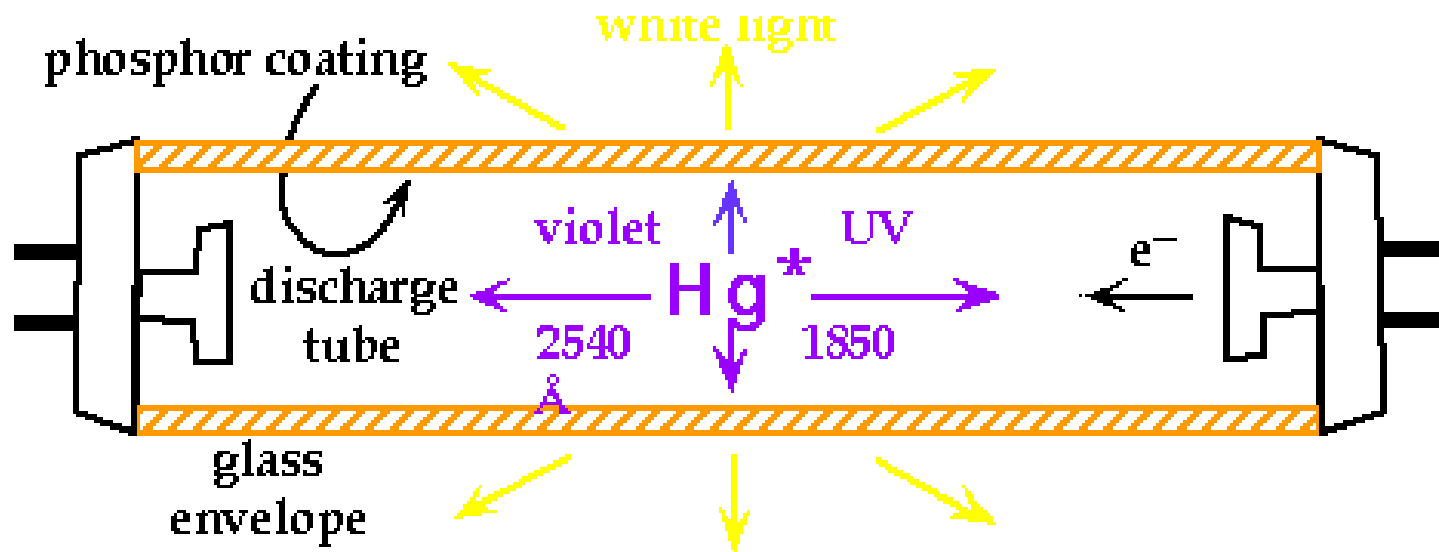

FLUORESCENCE LAMP

- Glass tube filled with argon gas and mercury vapour and coated with luminescence material (particles)
- Tungsten electrodes at each end of the tube generate current
- Flowing current ionizes Ar gas and excites Hg to emit UV radiation (254 & 185 nm)
- This UV radiation excites the luminescence phosphor coating which then emits visible (white) light

Energy Migration → Concentration Quenching

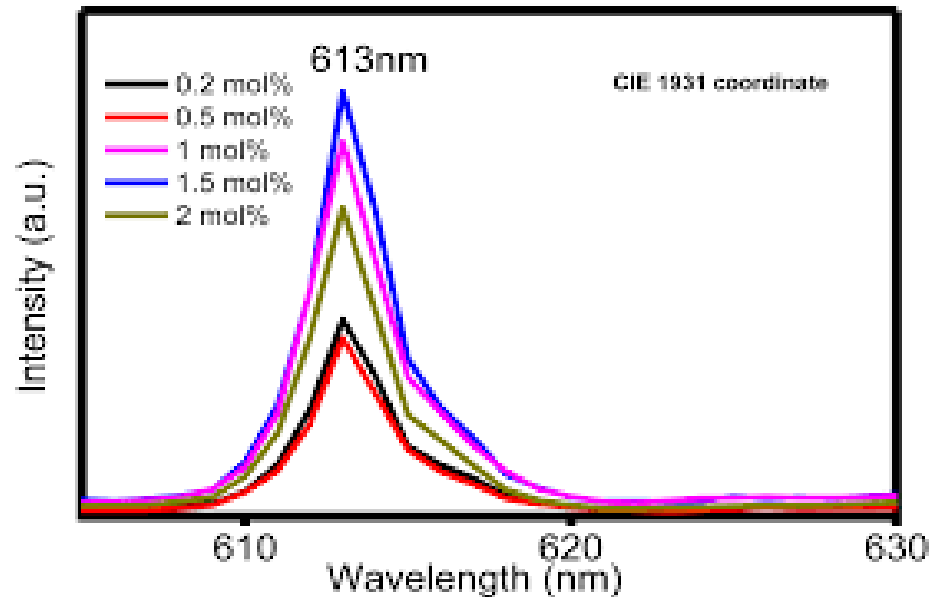
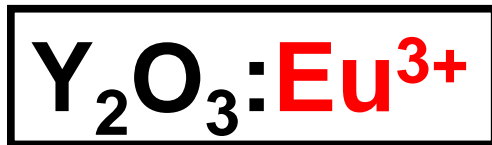
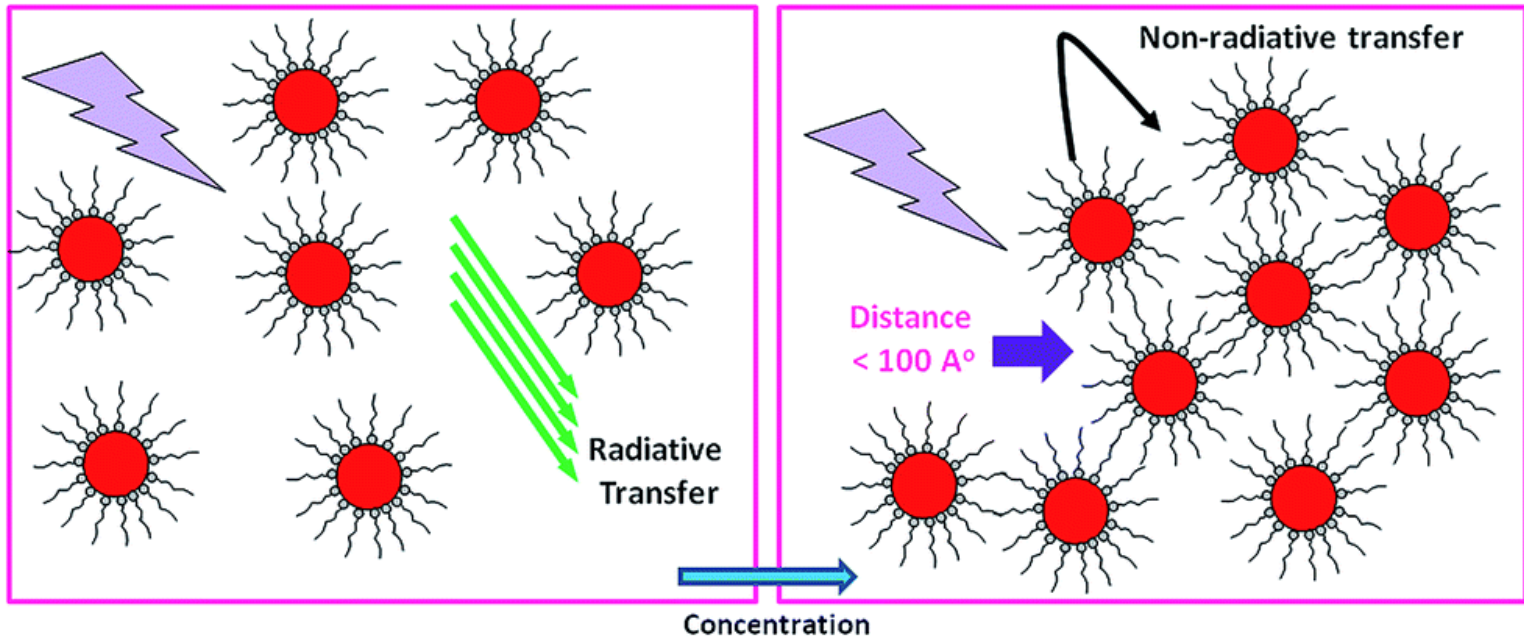

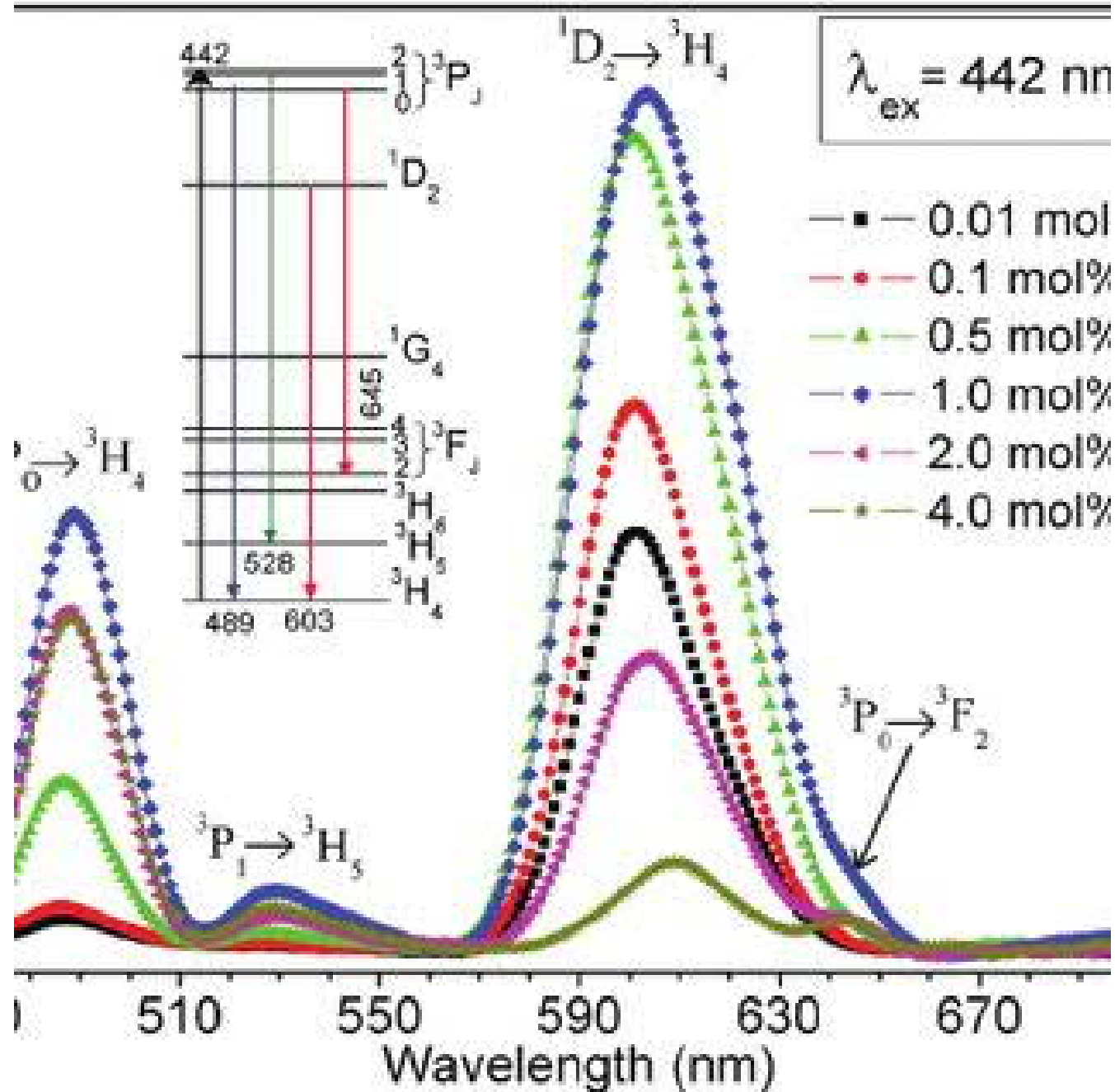

ALD/MLD Eu-organic Flexible Phosphors

PRECURSORS:

Eu(thd)₃ + pyridinedicaboxylic acid

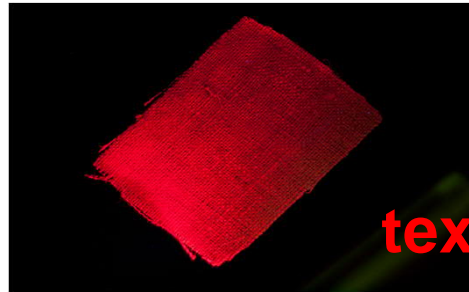

textile

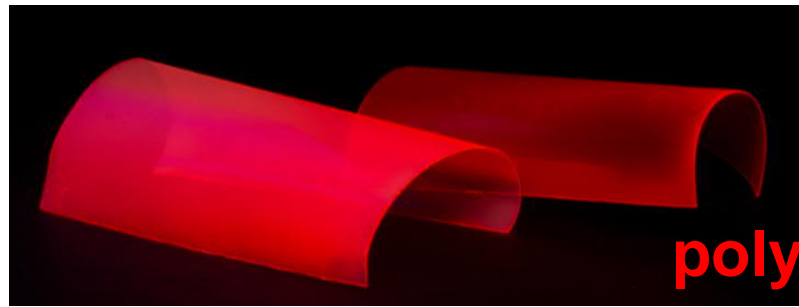

polymer

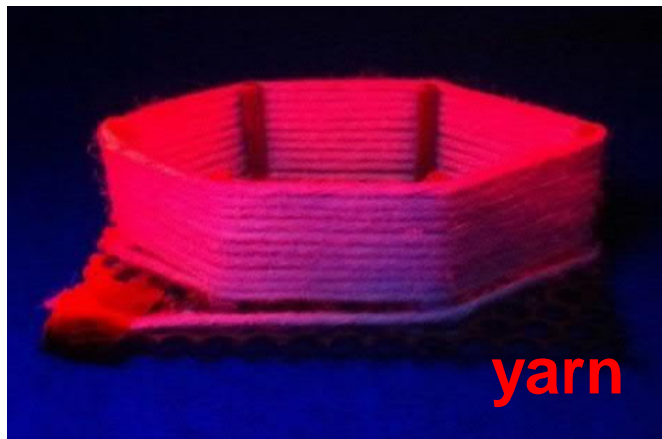

yarn

Eu-organic

Eu₂O₃

Tensile tests
(elongation)

2%

2%

10 μm

10 μm

4%

4%

10 μm

10 μm

8%

8%

10 μm

10 μm

Z. Giedraityte, P. Sundberg & M. Karppinen,
J. Mater. Chem. C **3**, 12316 (2015).

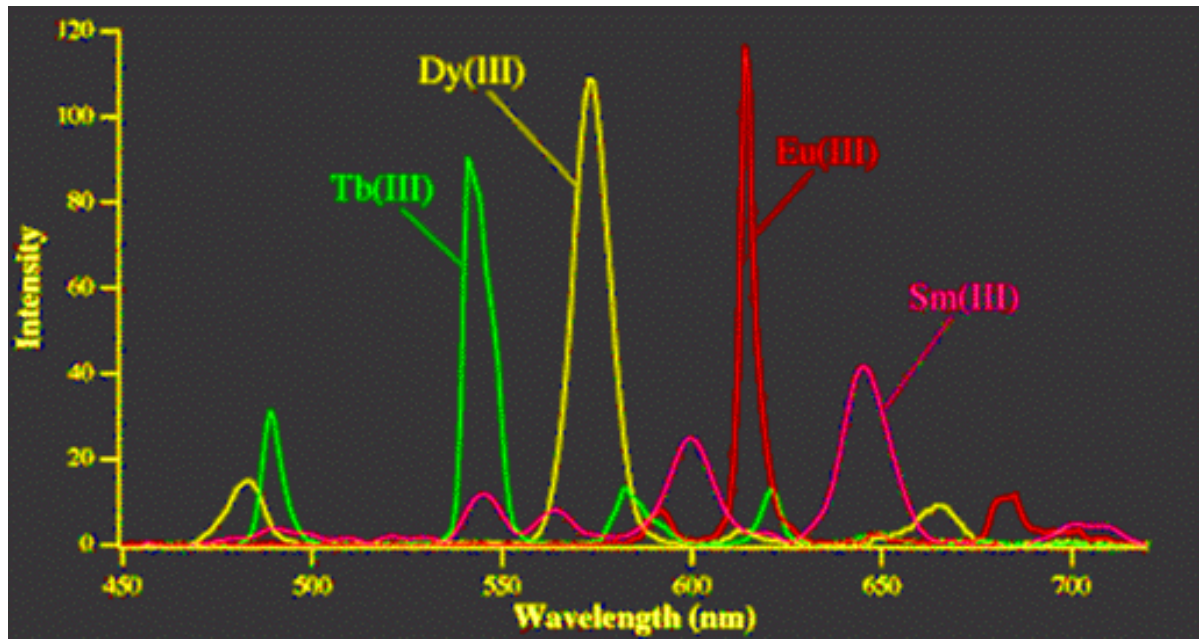

5D_3



Tb³⁺

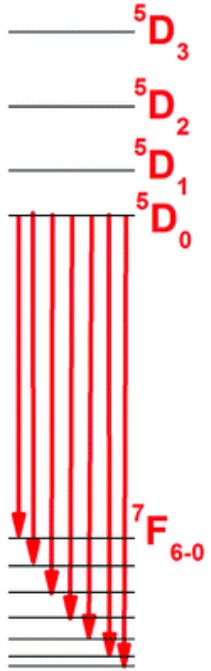

Eu³⁺



Dy³⁺

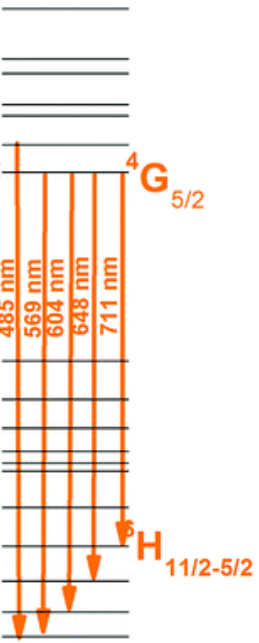

Sm³⁺

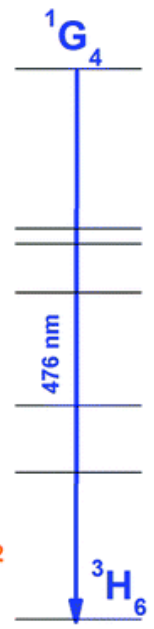

Tm³⁺

**WHITE LIGHT
from single
material:
LaMgB₅O₁₀**

ALD/MLD grown
Eu-organic thin film

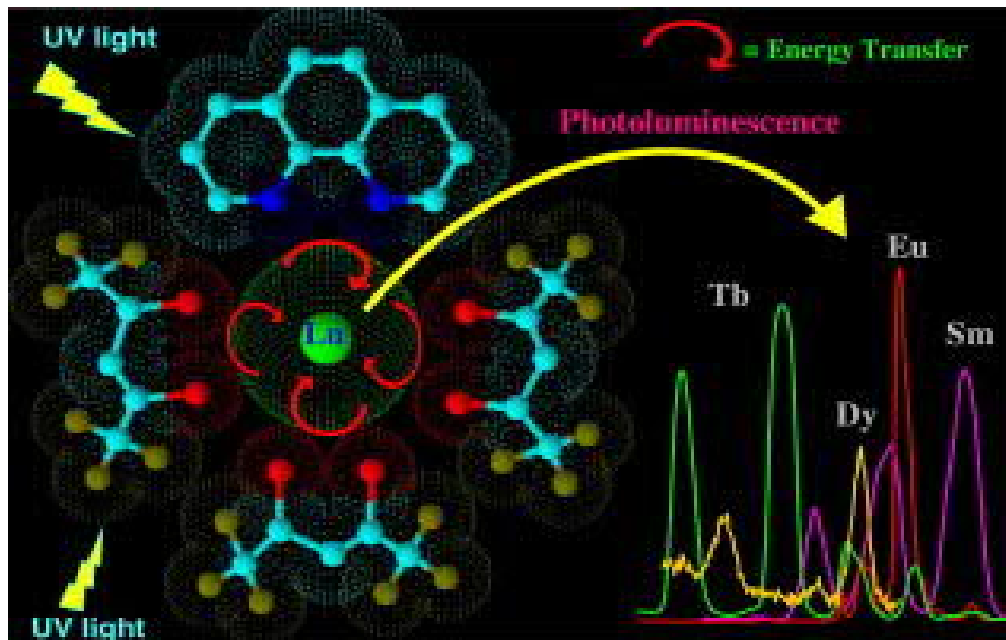
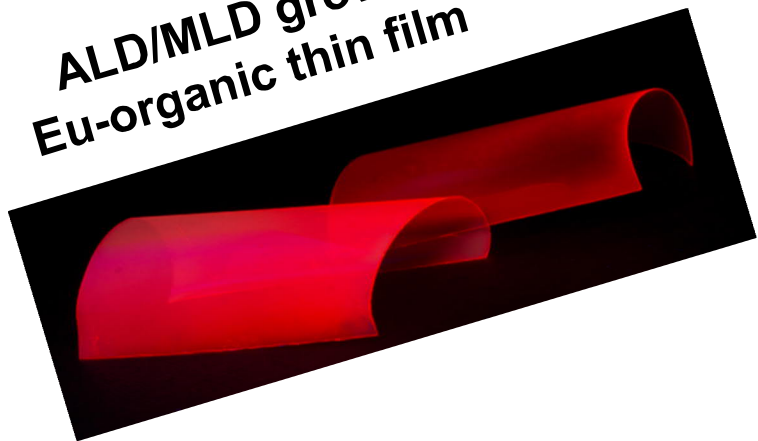

Ln-organic complex

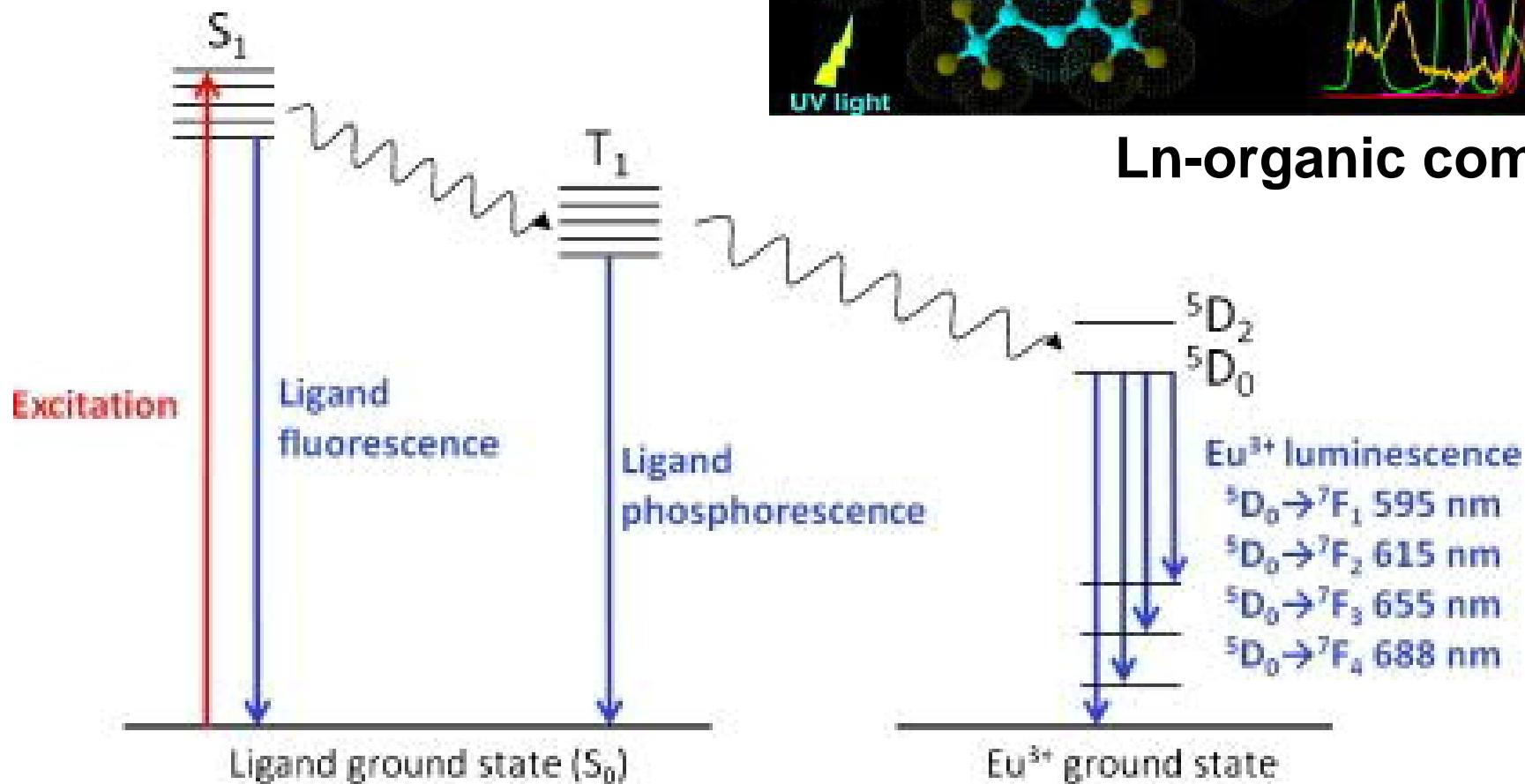

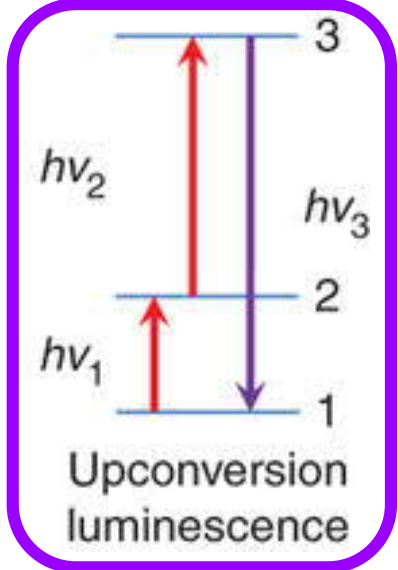
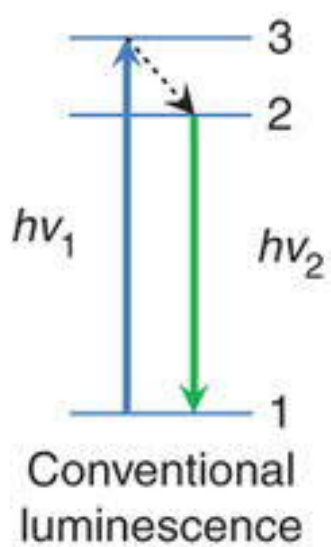

UPCONVERSION EMISSION

- for example from IR to Visible

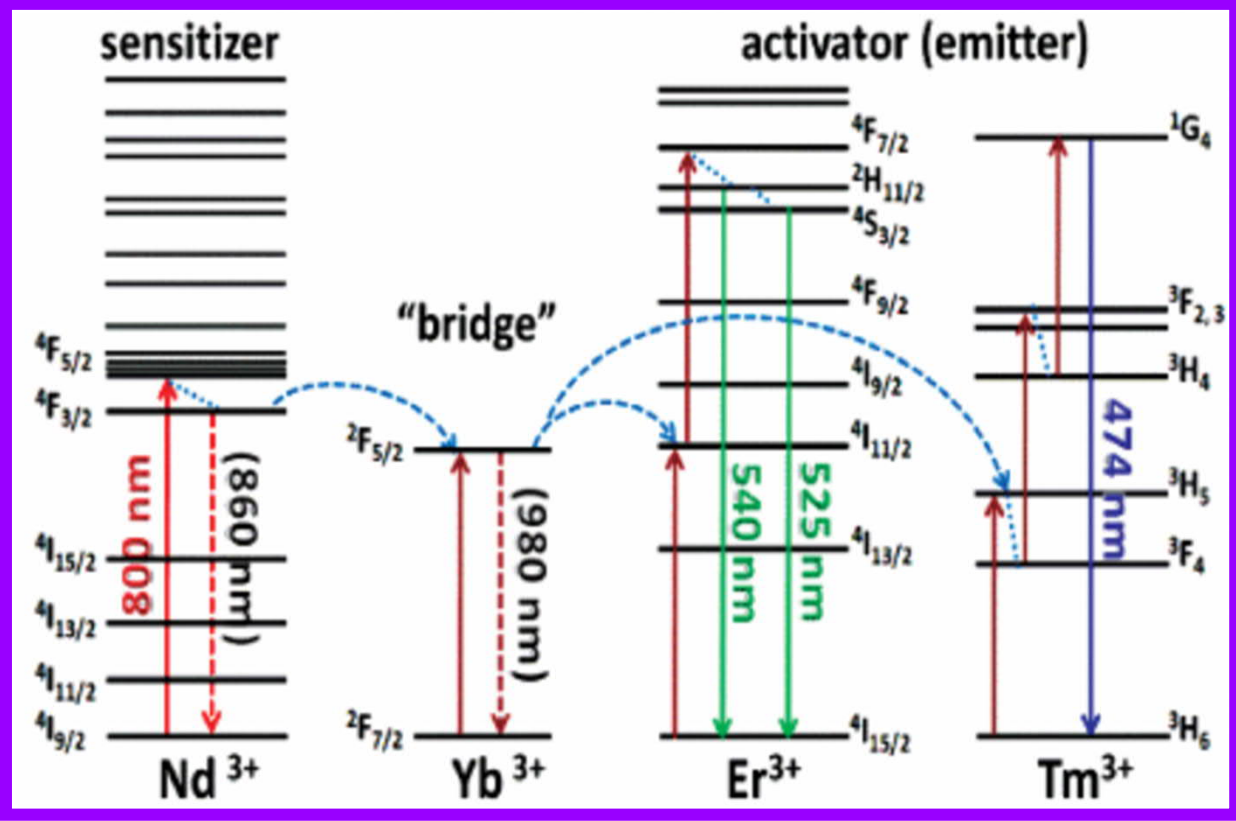

ALD/MLD of Ln-Organic Upconversion Materials

(Y, Yb, Er)-pyrazine

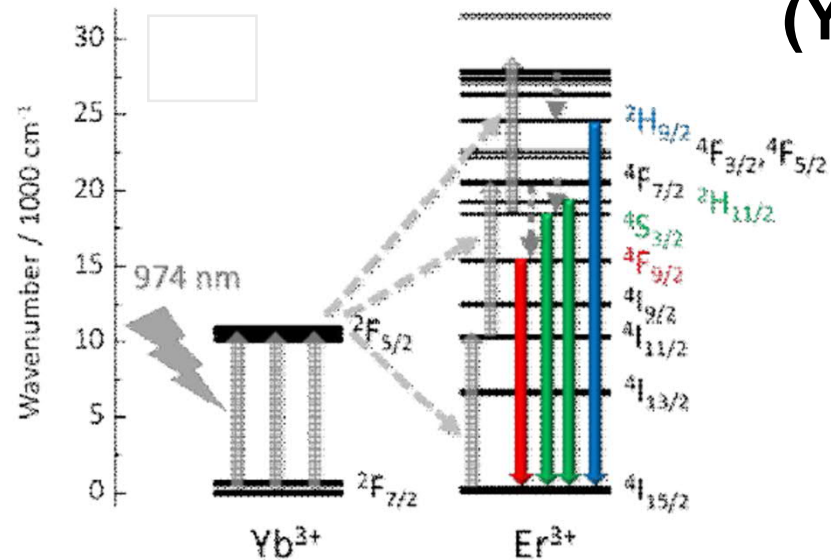
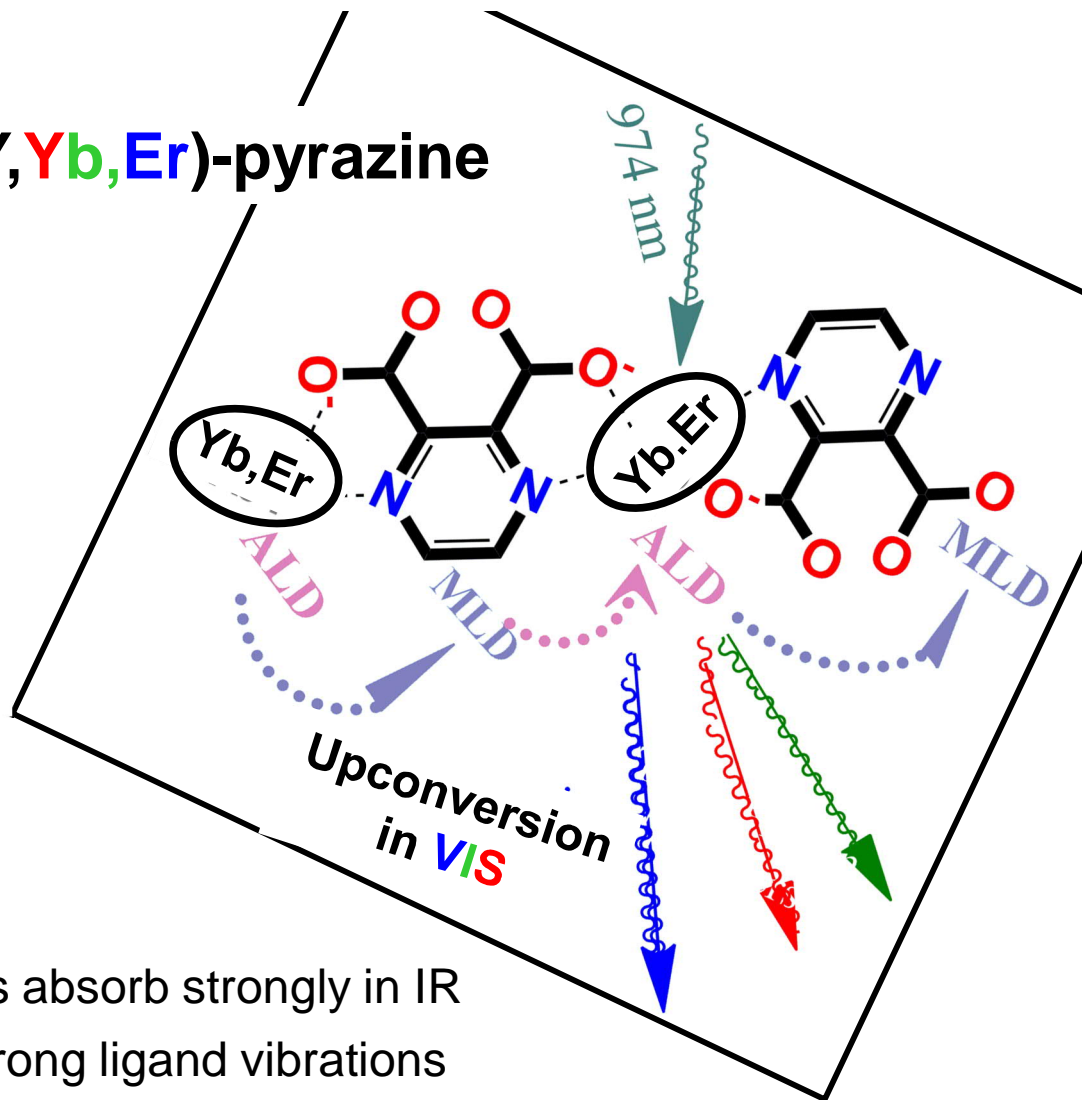

UPCONVERSION:
Near-IR → VIS light

- **Metal-Organic COMPLEX:** organics absorb strongly in IR
- **PROBLEM:** energy losses due to strong ligand vibrations
- **ALD/MLD Ln-ORGANIC FILMS:** organics more tightly bound → losses avoided

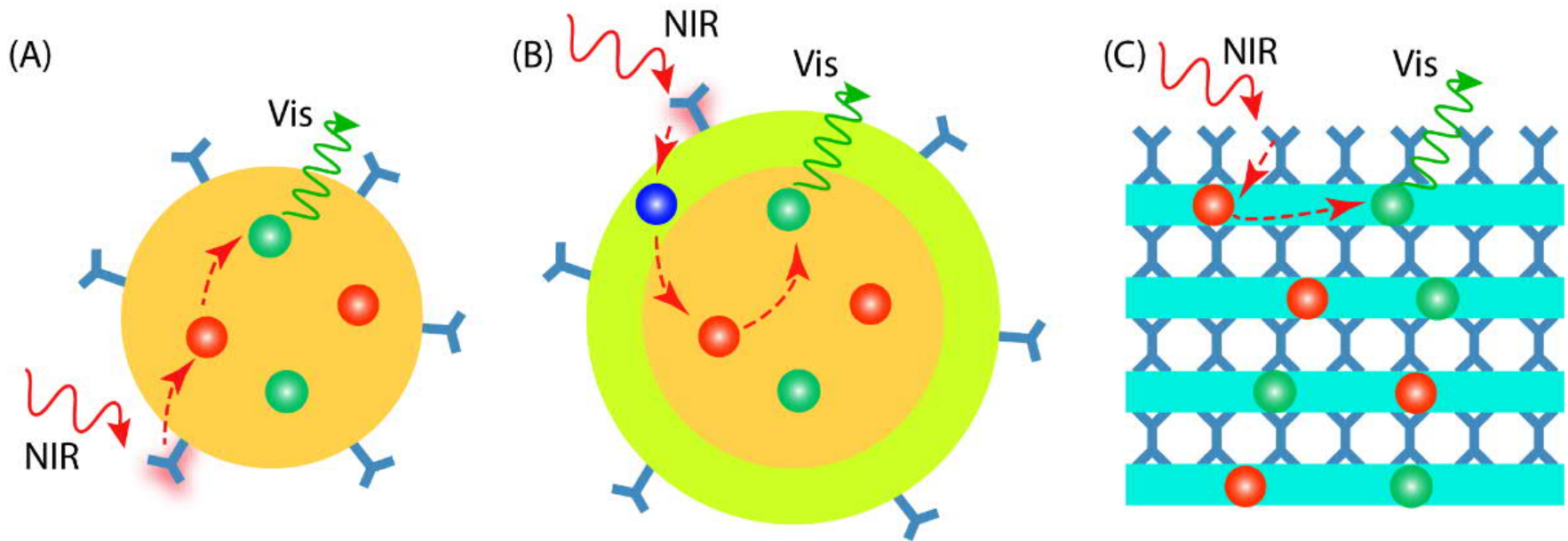

Different designs for inorganic-organic UC materials

- (A) Core-only NP with organic antenna on the surface
- (B) Core-shell NP with organic antenna on the shell surface
- (C) Thin film with inorganic and organic interlayers

Organic ligands (blue) could contribute to energy absorption, transferring their absorbed energy to the sensitizer ions (red). The sensitizer further transfers the energy to the activator ions (green) for the desired UC emission.

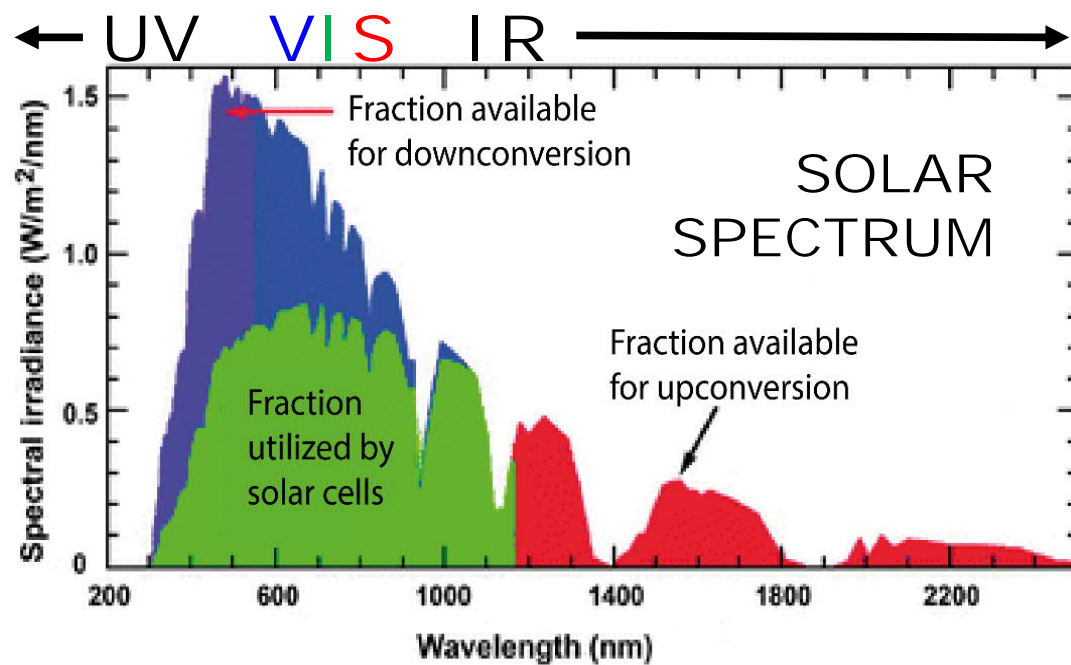
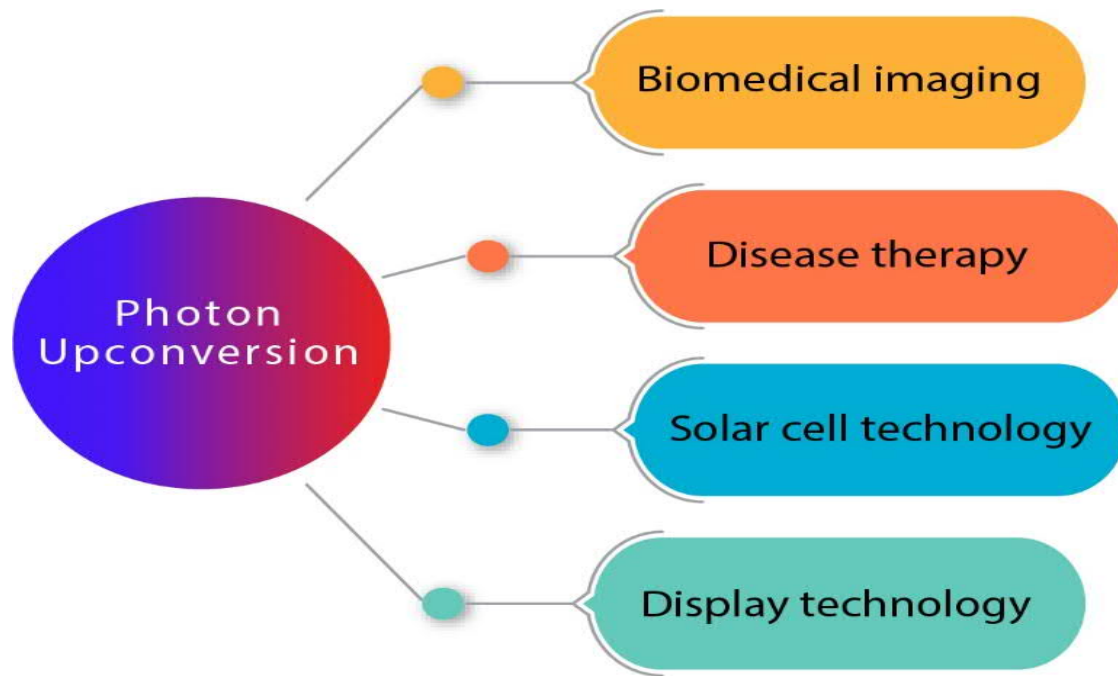
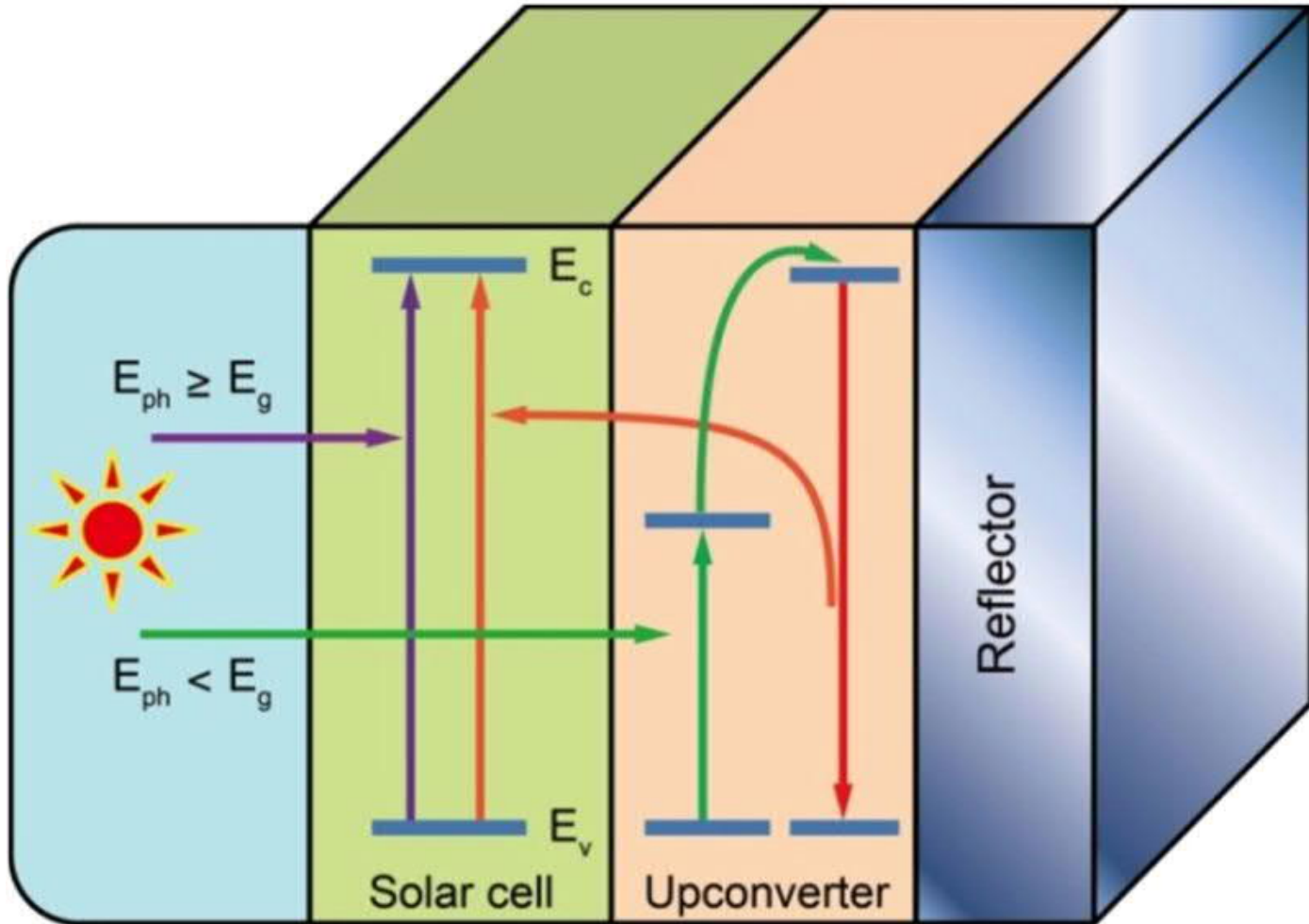
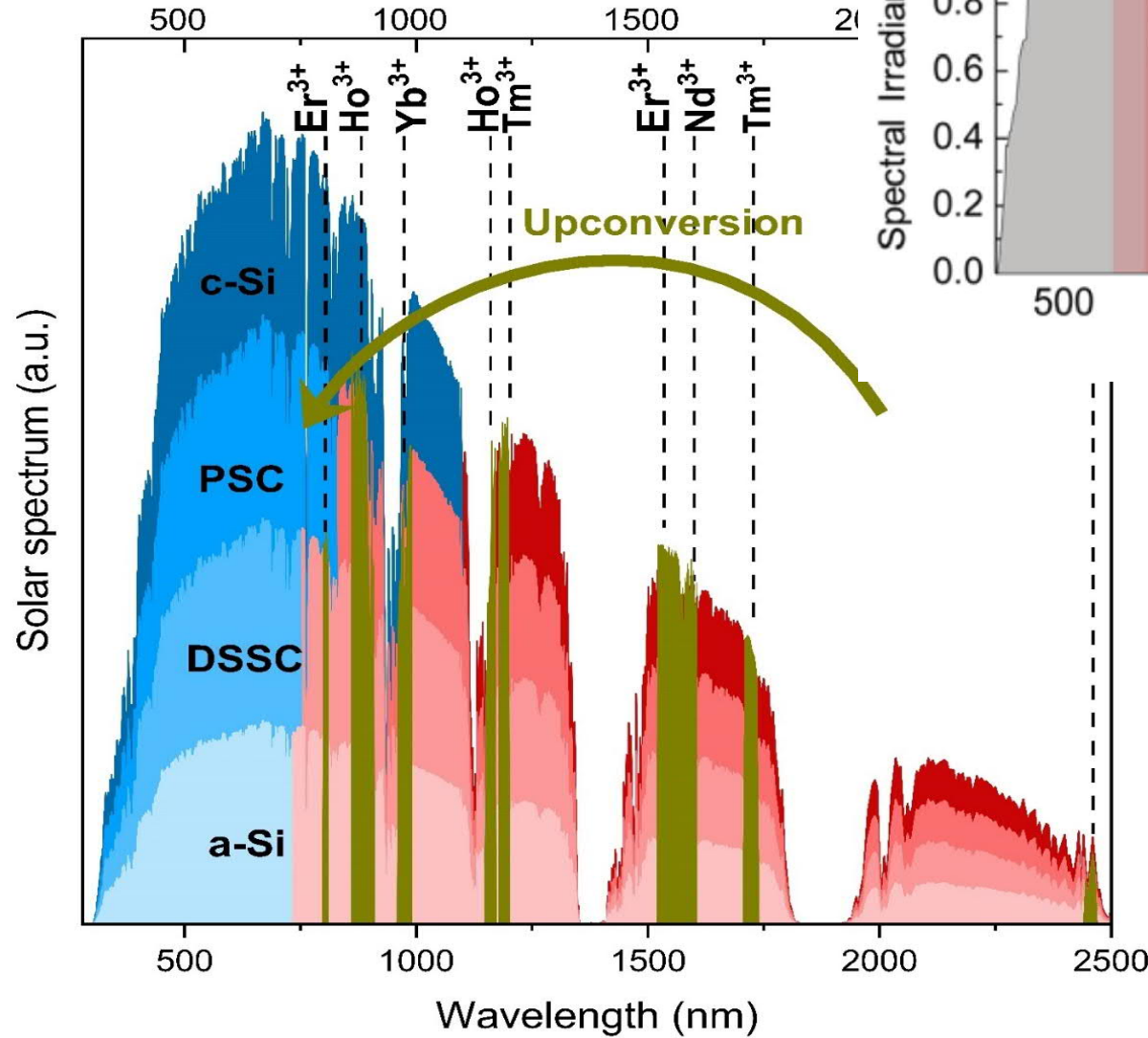
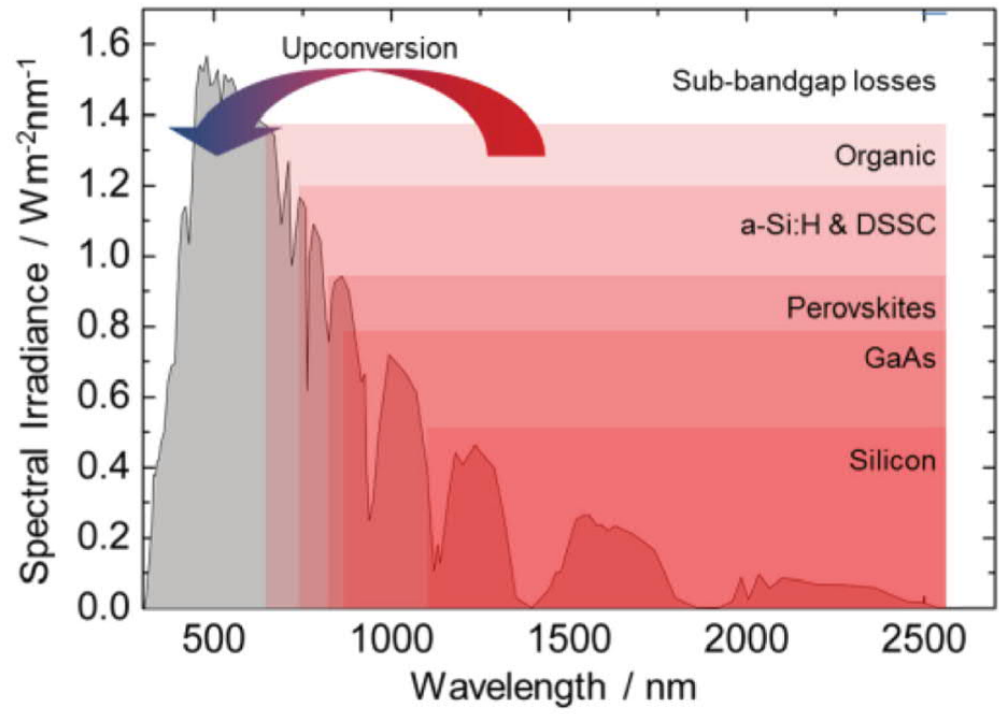
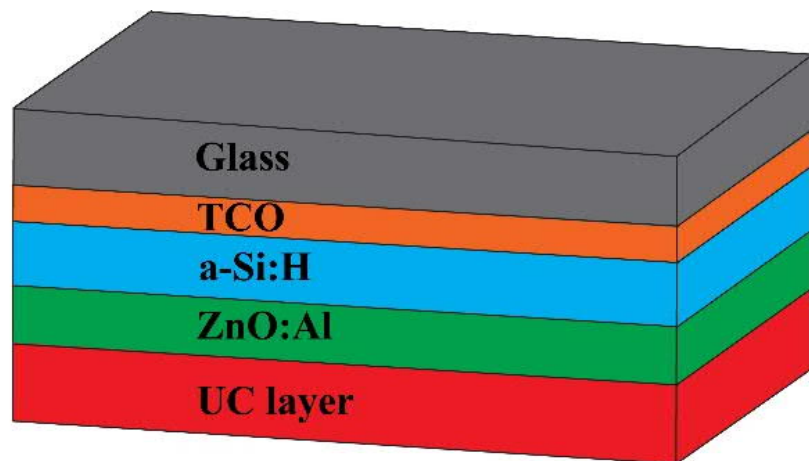

Figure 7 from Weifeng Yang et al 2014 Nanotechnology 25 482001



c-Si: crystalline Si
a-Si: amorphous Si
PSC: perovskite SC
DSSC: dye-sensitized SC





a-Si

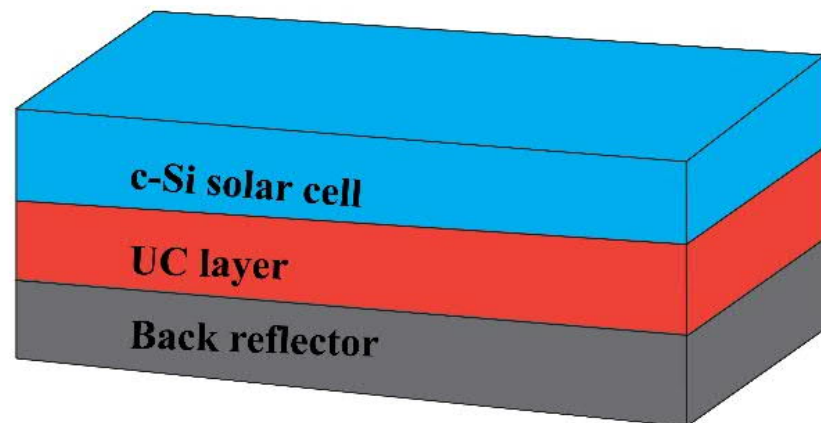

c-Si

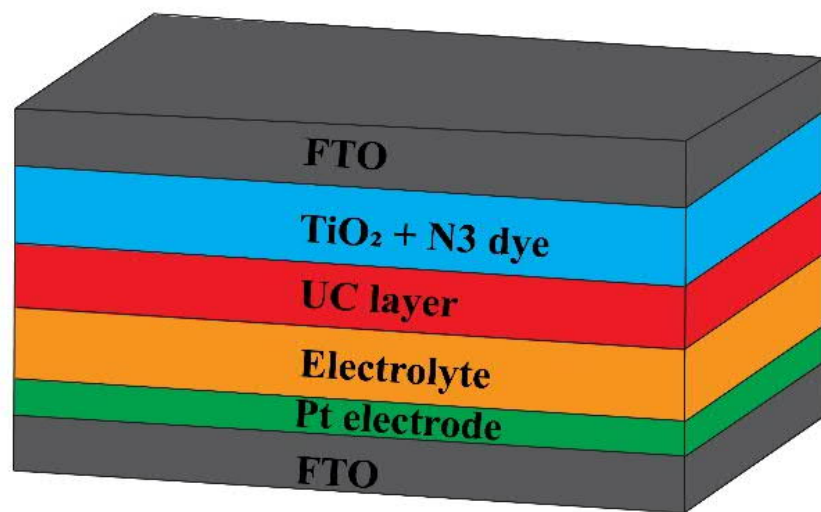

DSSC

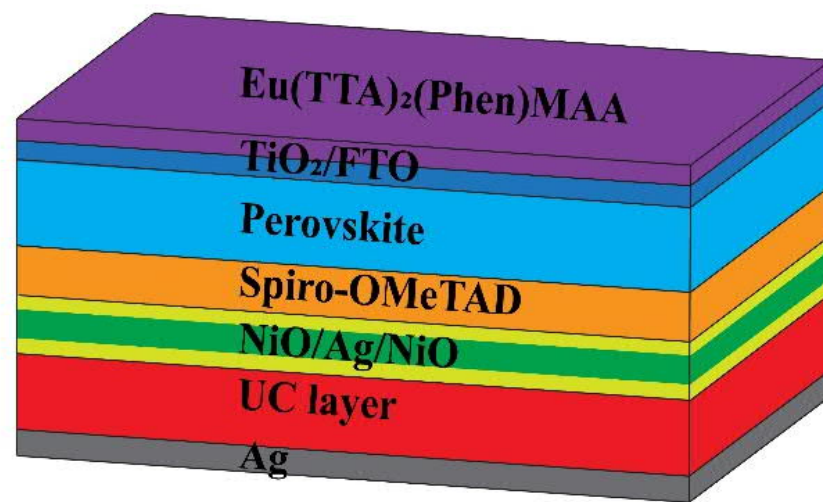

PSC

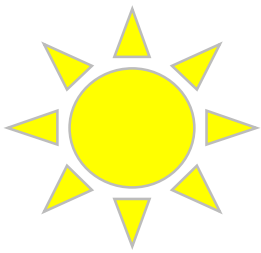

SOLAR CELLS

- Solar spectrum: UV + VIS + IR
- Solar cells utilize mostly VIS light
- Photon Upconverting Thin Film (PUTF)

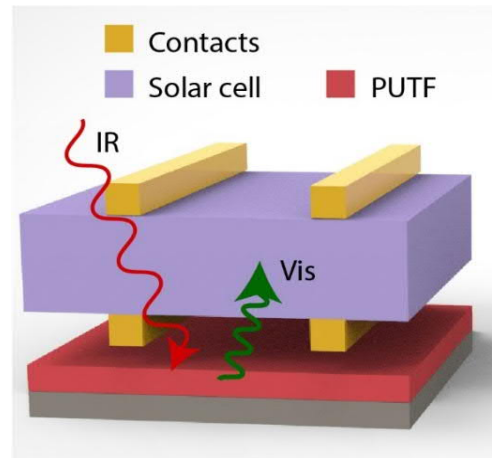

c-Si PV + ALD (Er,Ho)₂O₃ PUTF

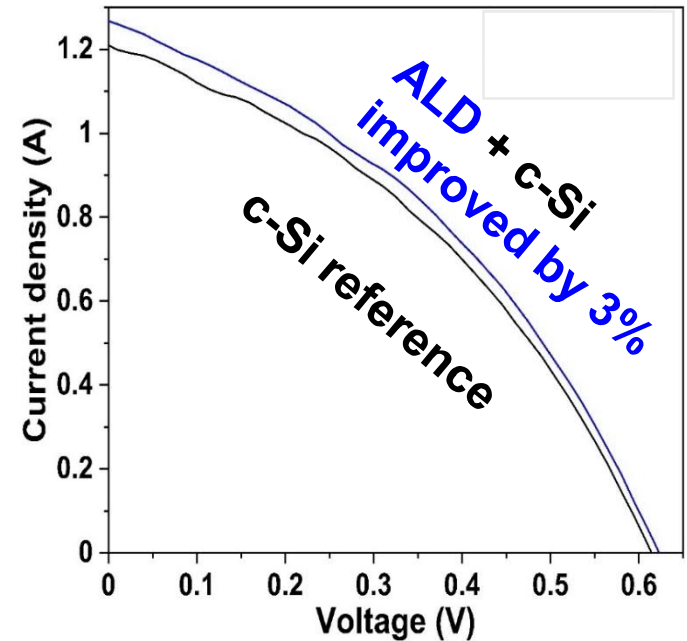
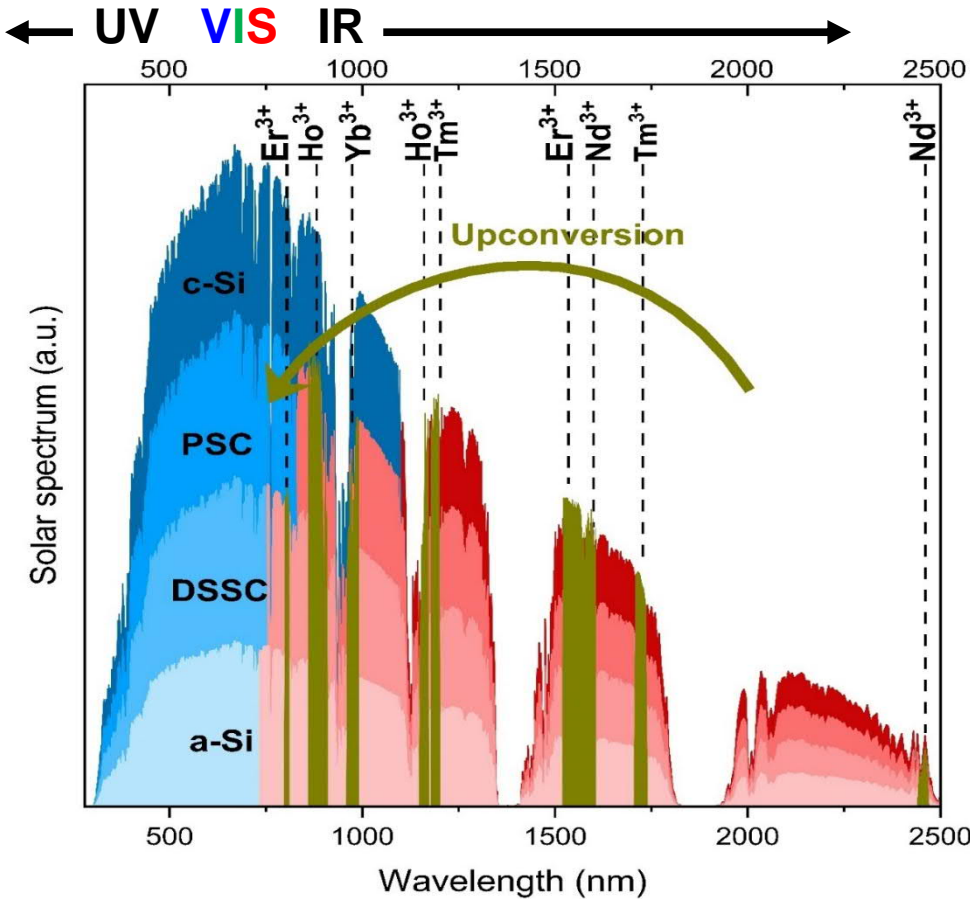

A. Ghazy, M. Safdar, M. Lastusaari, A. Aho, A. Tukiainen, H. Savin, M. Guina & M. Karppinen, Luminescent (Er,Ho)₂O₃ thin films by ALD to enhance the performance of silicon solar cells, *Solar Energy Materials & Solar Cells* 219, 110787 (2021).