



Aalto University
School of Chemical
Technology

*Synthetic biology (Course
CHEM-E8125), spring 2022*

Synbio biotech examples

Prof. Merja Penttilä

A key synbio application potential is in **CIRCULAR BIOECONOMY – towards a bio-based society**



Industrial biotechnology

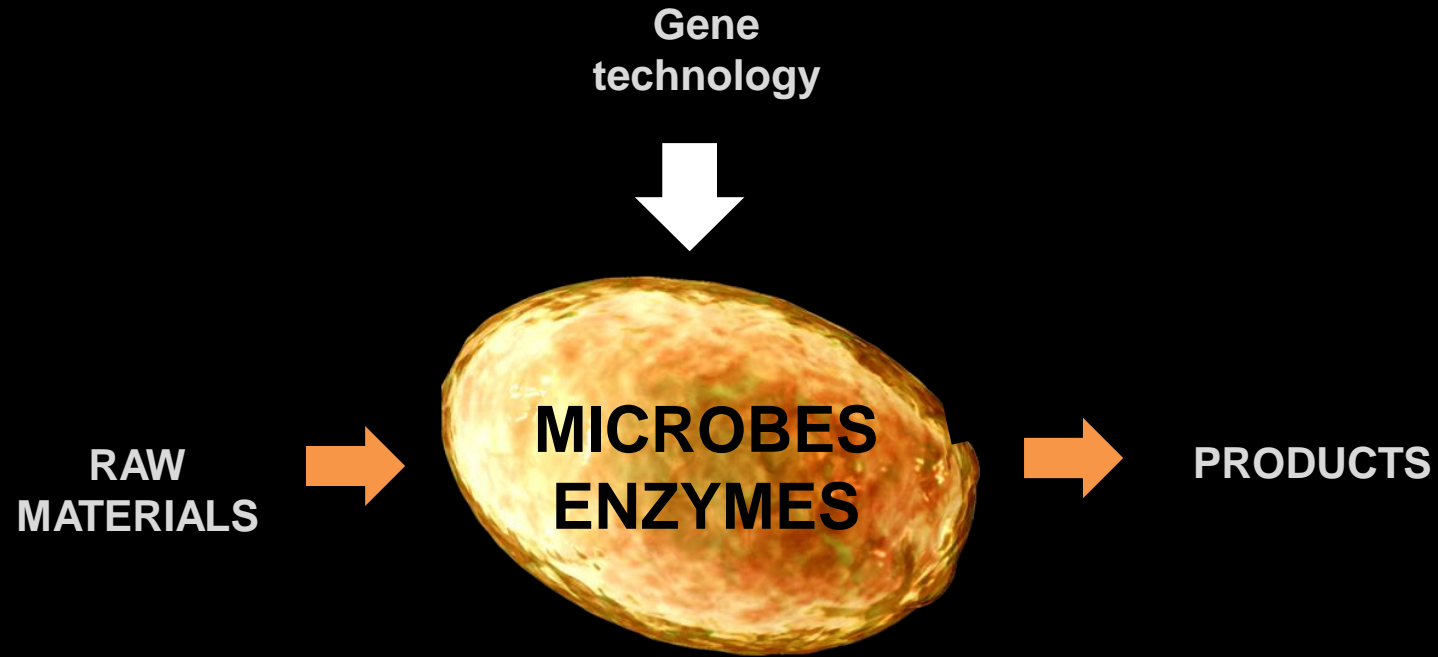

Efficient production of only the wanted product in closed bioreactors

A single unit operation

Ambient temperatures and pressures, no toxic catalysts

Atmospheric CO₂

H₂

Industrial flue gases

Synthesis gas

Methane, methanol

Industrial sidestream sugars

Ligno-cellulose

Food industry sidestreams

Packaging and textile waste

Versatile use of non-fossil raw materials and unique possibilities to broaden the product range

Natural synthesis power
Evolution power
Reaction specificity

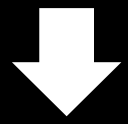

RAW MATERIALS

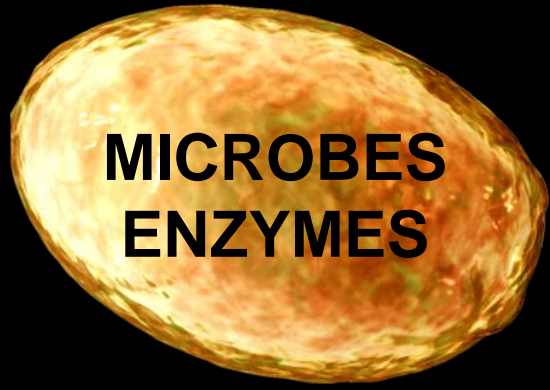
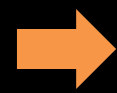

**MICROBES
ENZYMES**



PRODUCTS



Atmospheric CO₂



H₂

Industrial flue gases

Synthesis gas

Methane, methanol

Industrial sidestream sugars

Ligno-cellulose

Food industry sidestreams

Packaging and textile waste

Versatile use of non-fossil raw materials and unique possibilities to broaden the product range

Natural synthesis power
Evolution power
Reaction specificity

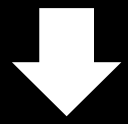

RAW MATERIALS

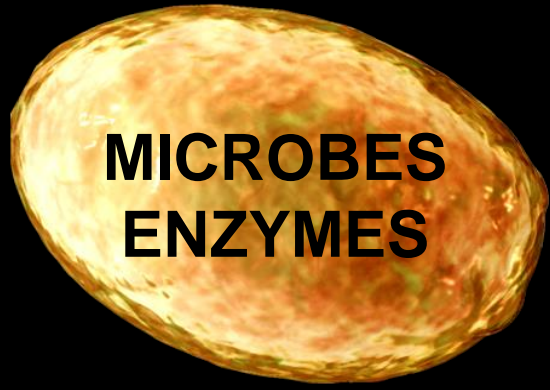

**MICROBES
ENZYMES**

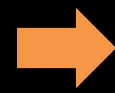

PRODUCTS

Engineering biology using DNA as a code
- Synthetic DNA

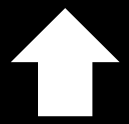

SYNTHETIC BIOLOGY

Faster process development

- Computer-aided design of production strains
- Rapid construction and testing of strains using automation and robotics
 - New reactions, new products, more efficient processes



Atmospheric CO₂



H₂

Industrial flue gases

Synthesis gas

Methane, methanol

Industrial sidestream sugars

Ligno-cellulose

Food industry sidestreams

Packaging and textile waste

Heterogenous raw material



Single (pure) product

Xylose



Xylitol

Glucose
Mannose
etc



Growth

MICROBE

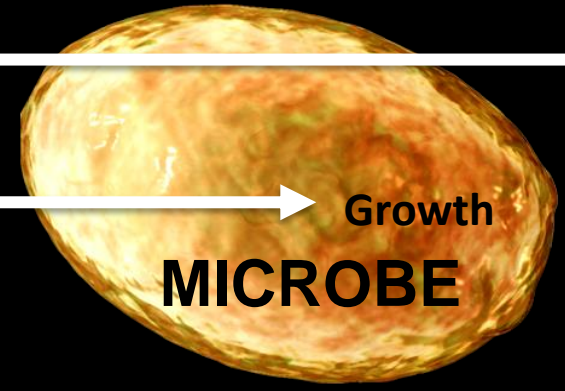

Xylose
Glucose
Mannose
etc



MICROBE

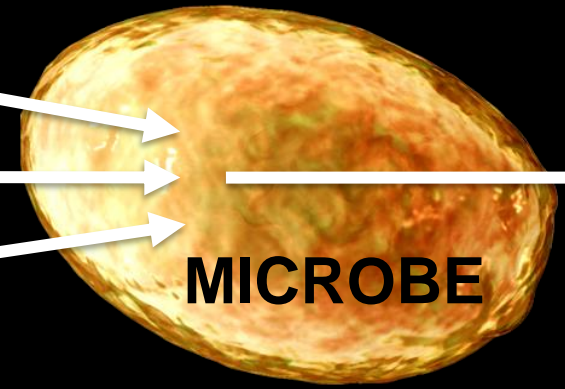

Ethanol, or
Lactic acid, or
Glycolic acid
etc



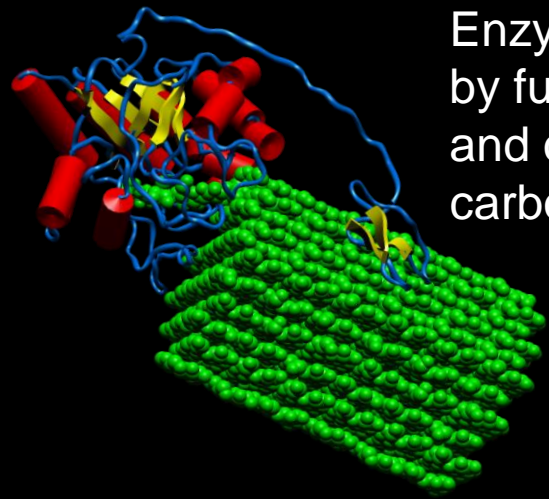

Enzymes produced
by fungi digest cellulose
and other plant biomass
carbohydrates to sugar



Sugar

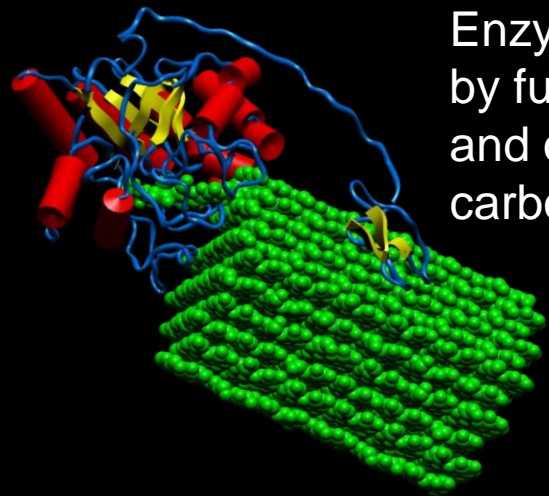

Enzymes produced
by fungi digest cellulose
and other plant biomass
carbohydrates to sugar



Sugar



Baker's yeast
- A cell factory



Ethanol



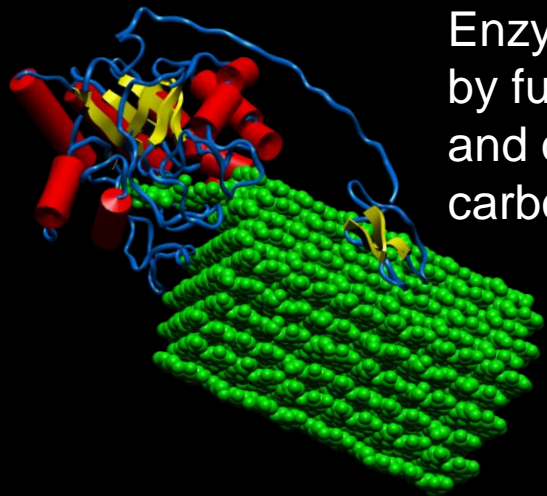

Enzymes produced by fungi digest cellulose and other plant biomass carbohydrates to sugar



Sugar



Baker's yeast
- A cell factory

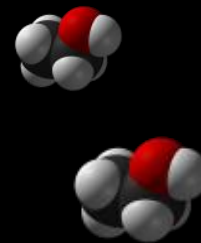
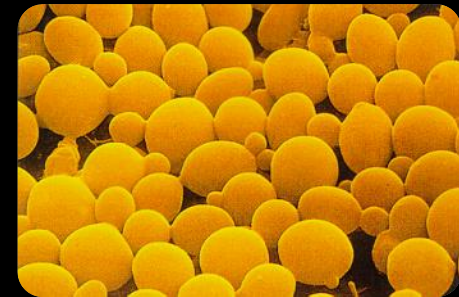

Ethanol



Biofuel

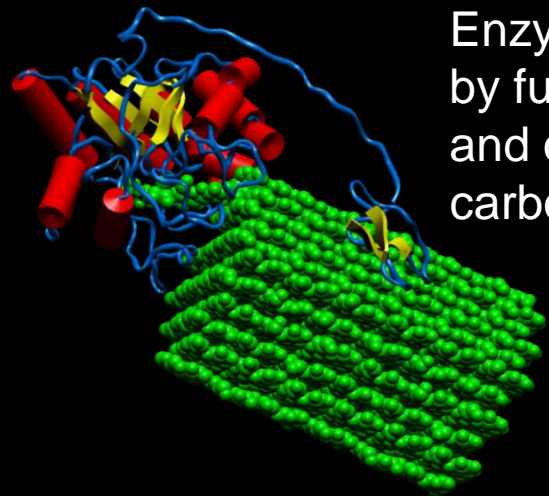

Enzymes produced by fungi digest cellulose and other plant biomass carbohydrates to sugar

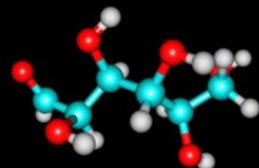

Sugar



Baker's yeast
- A cell factory



Lactic acid

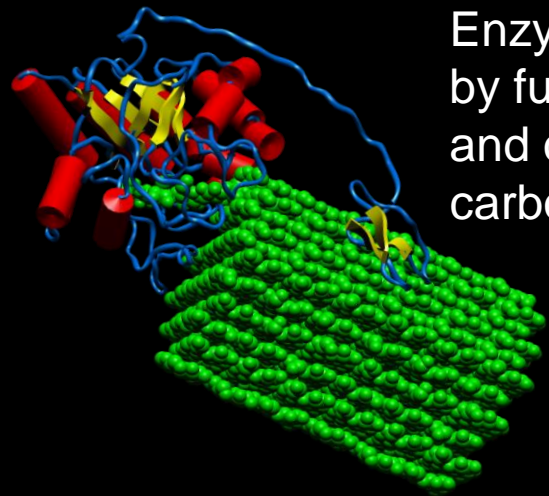

Enzymes produced by fungi digest cellulose and other plant biomass carbohydrates to sugar



Sugar



Baker's yeast
- A cell factory



Lactic acid

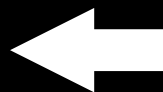

Bioplastic PLA

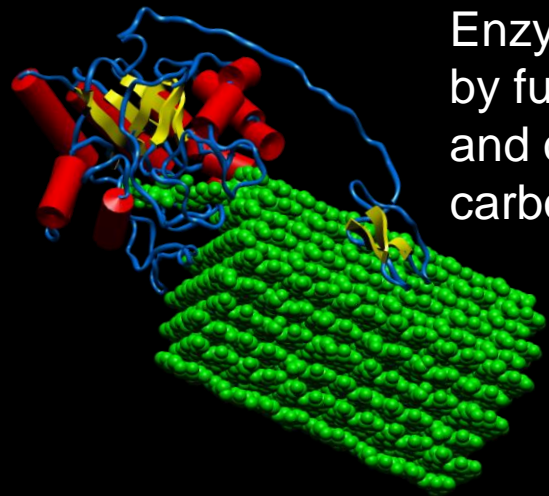

Enzymes produced by fungi digest cellulose and other plant biomass carbohydrates to sugar



Sugar

Baker's yeast
- A cell factory



Xylitol
Vanillin
Terpenes

Insulin
Artemisin
Opioids
etc

Food &
Feed Protein

Silk
PHB
Hyaluronan
Alginate
Isoprene
etc

Lactic acid
Succinic acid
Itaconic acid
Acrylic acid
Muconic acid
etc

Ethanol
Butanol
Biodiesel
Jet fuels
etc

VTT has experience in ENZYMATIC HYDROLYSIS of many different biomasses

Steam exploded or hydrothermally treated, acidic pretreatment

- Softwood
- Hardwood
- Wheat straw
- Wheat bran
- Sugar cane bagasse
- Grass silage

From alkaline pretreatment

- Softwood
- Hardwood
- Wheat straw
- Wheat bran
- Sugar cane bagasse
- Waste wood/recycled wood
- Green biomasses, grass silage



Other

- Waste fiber
- Spent grain
- Municipal waste (sorted, mixed)
- Sludges from paper mills
- Solid recovered fuel (SRF)



Production host engineering at VTT

Microbes & products

Bacteria

Escherichia coli
Clostridium ljungdahlii
Synechocystis (cyanobacteria)
Rhodococcus opacus

Yeasts

Saccharomyces cerevisiae
Kluyveromyces lactis
Kluyveromyces marxianus
Yarrowia lipolytica
Scheffersomyces stipitis
Pichia kudriavzevii
Candida sonorensis
Pichia membranefaciens
Candida methanosorbosa
Cryptococcus curvatus

Filamentous fungi

Trichoderma reesei
Aspergillus niger
Aspergillus oryzae
Mucor circinelloides

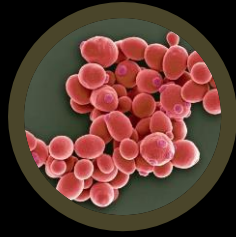

Organism
selection

Organism
development

Process
development

Scale-up
and piloting

Chemicals

Ethanol
Butanol
Triacylglycerids &
derivatives

Lactic acid
Glycolic acid
Xylonic acid
Arabinoic acid
Galactaric acid
Glucaric acid

Xylitol
Pigments
Isoprene
 γ -terpinene
Ent-pimaradiene
Alcaloids
Styrene

Proteins

Industrial enzymes
Material proteins
Antibodies
Food proteins
Feed proteins

KORVAA headphones, made from microbially produced materials

Reach:
>350
mill.
readers

MICROBIAL BIOPLASTIC PLA
The 3D printed biodegradable plastic PLA is made from lactic acid that is produced by the yeast *Saccharomyces cerevisiae*.

ENZYMATICALLY PRODUCED CELLULOSE
The microbial and enzymatically produced cellulose is naturally lignin free.

COMPOSITE OF FUNGAL MYCELIUM AND BACTERIAL CELLULOSE
This material consists of mycelium, the cells of the fungus *Trichoderma reesei*, which is grown in a bioreactor and mixed with microbially produced cellulose. The dried composite is hard and light.



FUNGAL MYCELIUM
The growth of the fungus *Phanerochaete chrysosporium* creates a leather-like material.

BIOSYNTHETIC SPIDER SILK
Sustainable microbially produced silk protein.

PROTEIN FOAM AND PLANT CELLULOSE
A foaming protein, hydrophobin, is produced by the fungus *Trichoderma reesei*. It is nature's strongest "bubble-maker" which aids fungal cells to grow into air from a moist soil.

VTT and Aalto University researches, design company Aivan, Nina Pulkkis

Cell chemistry can be harnessed for production of platform chemicals that can replace oil-based compounds – and for many new complex molecules difficult to synthesize chemically

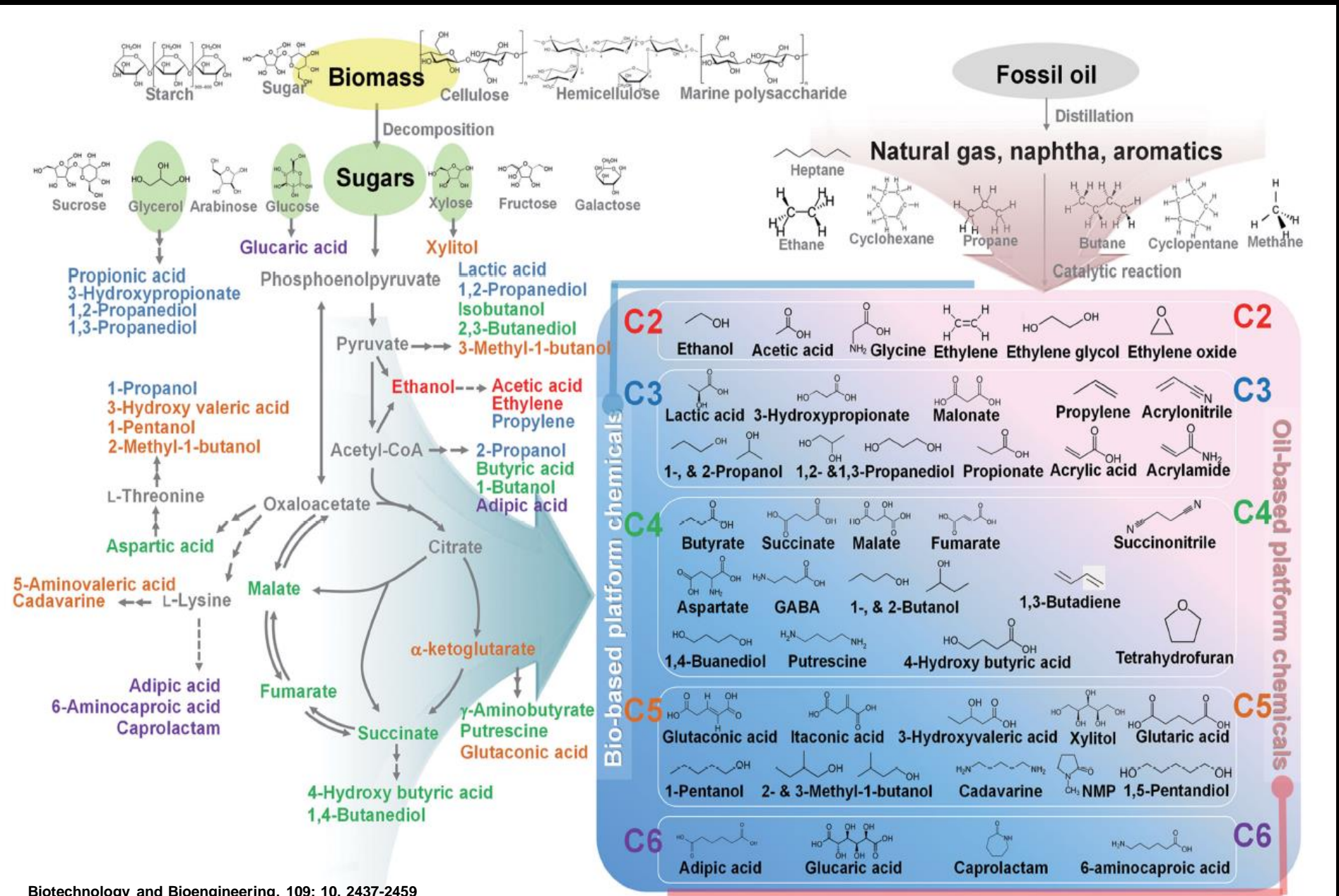

Bioreactors for ethanol and lactic acid can be more than 1000 m³ in size



10⁸ small cell factories fit in one liter

Biotechnology is suited also for very large scale

Industrial production is established for various products

Saccharomyces cerevisiae
baker's yeast is a robust process organism

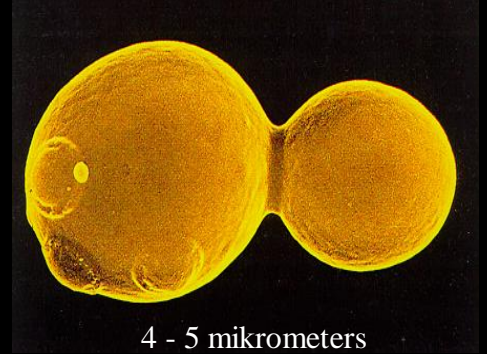
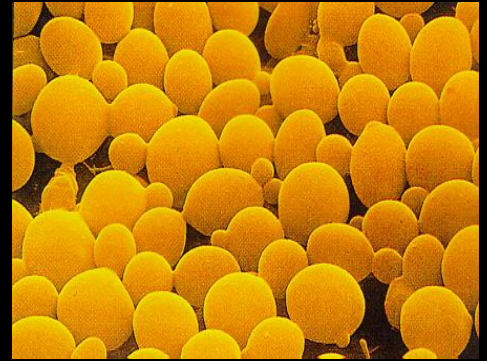

4 - 5 mikrometers

Bioreactors for ethanol and lactic acid can be more than 1000 m³ in size



Synthetic chassis vs. use of synbio tools in “natural” hosts?

- Process robustness is important – traditionally difficult to engineer
 - Low pH, T, raw material or product tolerance, pressure, oxygen variation, growth rate
- Natural organisms, even non-conventional ones may provide beneficial features and natural biodiversity (e.g. lipid production, acid tolerance, difficult to engineer pathways)
- Host is critical for achieving high production yields, rates and titres

A difficult question: Synthetic chassis or a favoured host, or a new natural one?

Does the Yeast 2.0 make a difference?

Saccharomyces cerevisiae
baker's yeast is a robust
process organism

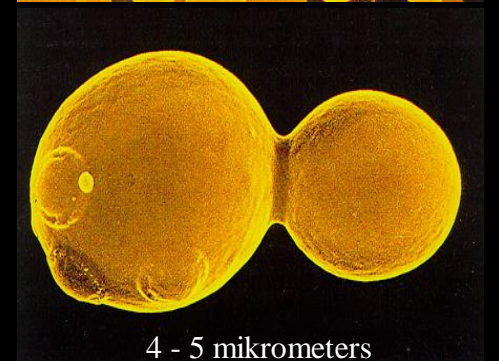
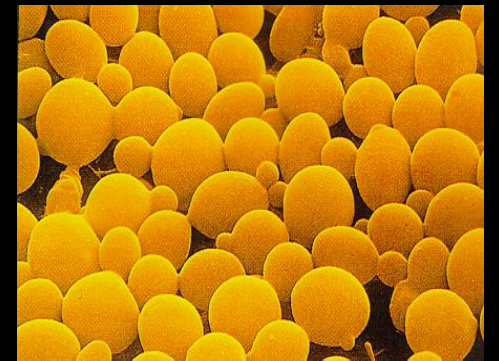

4 - 5 mikrometers

Needs in industrial production

- Replacement of fossil resources with renewable ones (plant biomass, photosynthesis) in production of chemicals, materials and fuels
 - Engineering of substrate utilisation pathways & photosynthetic organisms
- Equivalent products to petrochemicals by microbial fermentation
 - Metabolic engineering, heterologous pathway expression
- Novel, better products through biotechnology (materials, drugs etc)
 - Combinatorial pathways, novel enzyme catalysts, strong novel biodegradable materials
- Efficiency of production (titer, rate, yield)
 - Cut-off side reactions, increase flux, engineer cellular energetics & redox; predictive cellular modelling,.. thermodynamics, chemical biology etc
- Improve process robustness
 - Mutagenesis, product efflux, stress biomarkers, ...

Synthetic biology targets

- Host strains that have predictable behaviour and are easy to manipulate (“minimalistic” chassis)
- New product pathways (balanced redox and energy, minimal carbon loss = carbon economy)
- Controllable and efficient expression (expression modules and circuits with synthetic designed elements)
- Novel chemistry (protein engineering, combinatorial biochemistry)
- Control of process robustness (intracellular sensors and control loops)

**Design-Build-Test-Learn
(DBTL)
cycle of synthetic biology**

Automation of strain engineering
(ultimately towards a robot scientist)

The Design-Build-Test-Learn cycle of Synthetic Biology

Engineering biology using DNA as a code

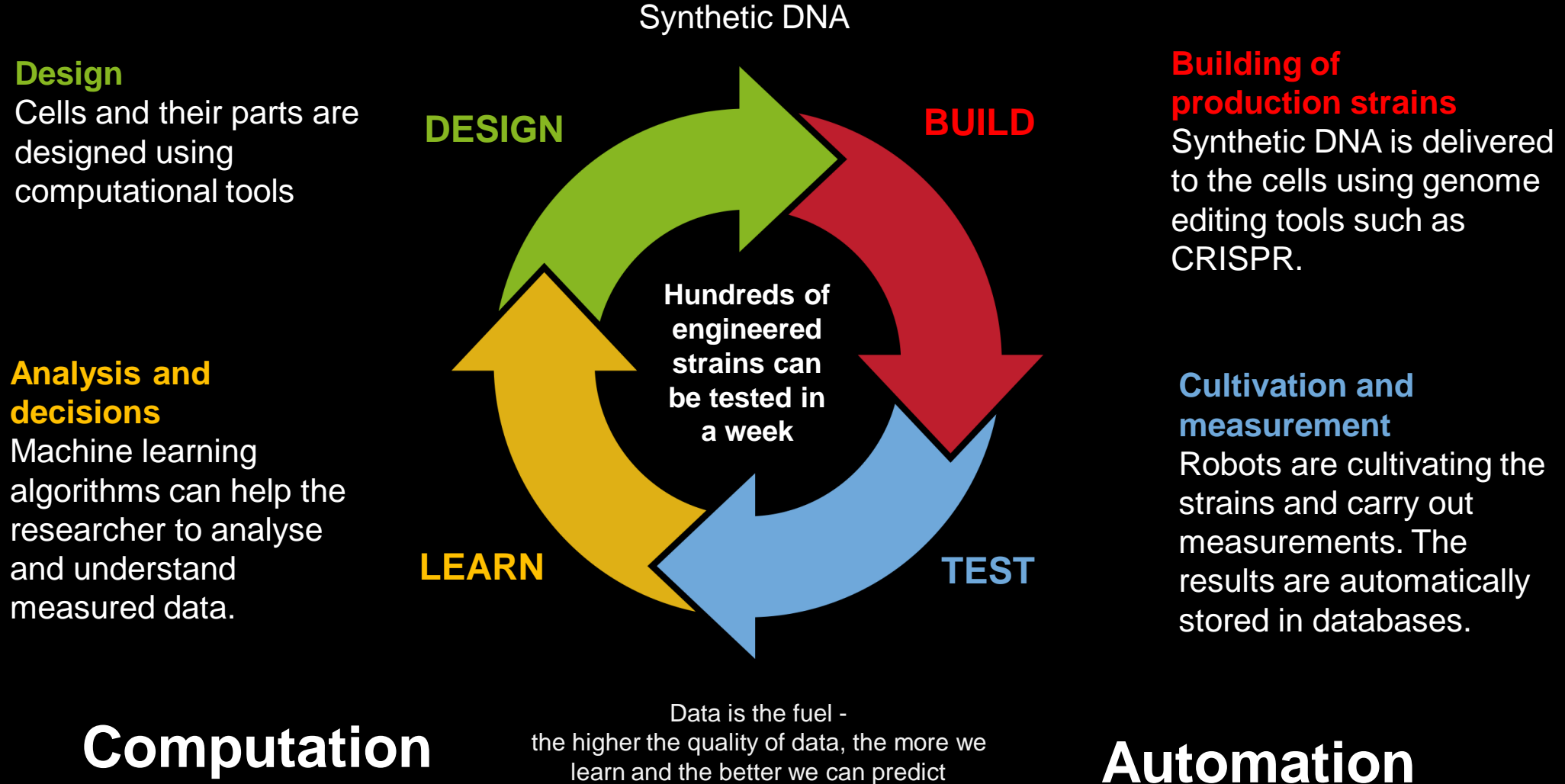

The Design-Build-Test-Learn cycle of Synthetic Biology

Engineering biology using DNA as a code

Design

- Mining for best genes from databases
- Design of cell biochemistry for high product yields
- Novel reactions

Analysis and decisions

- Mastering cell complexity using AI
- Prediction of new engineering targets

Computation

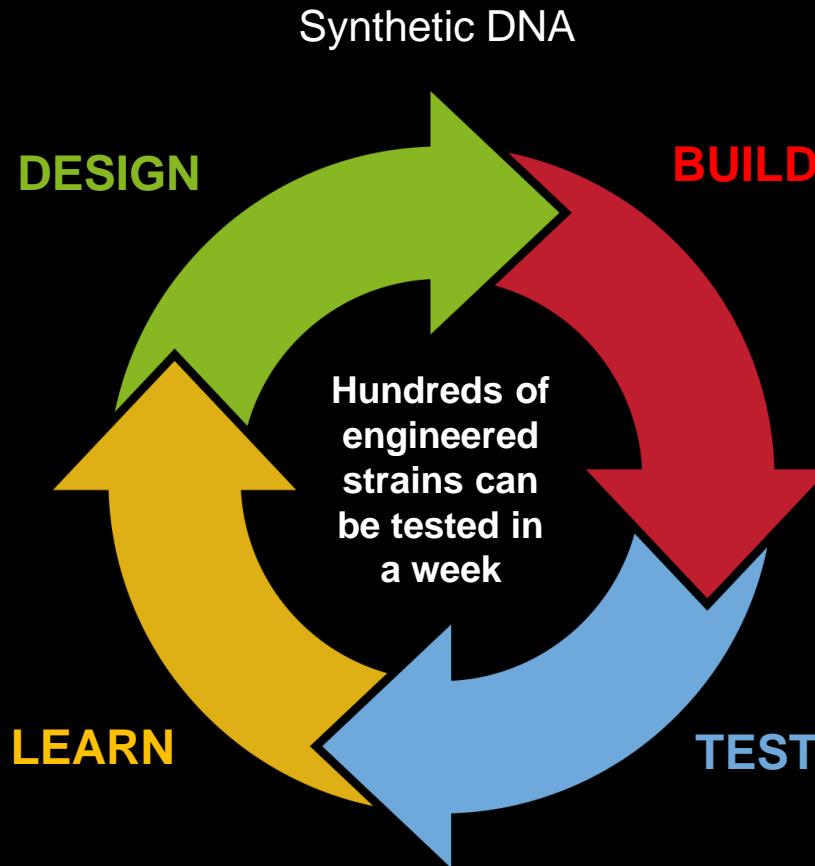

Building of production strains

- CRISPR
- Designed control of growth and production
- Automated cell engineering

Cultivation and measurement

- High throughput screening robotics
- Fully automated, parallel small-scale bioreactor cultures
- On-line analytics

Automation

Data is the fuel -
the higher the quality of data, the more we learn and the better we can predict

Aalto-VTT national Bioeconomy infrastructure: From synthetic biology to piloting

A versatile
computing platform
for design, prediction
and analysis



Controlled parallel
bioreactor systems with
automated sampling
and analytics

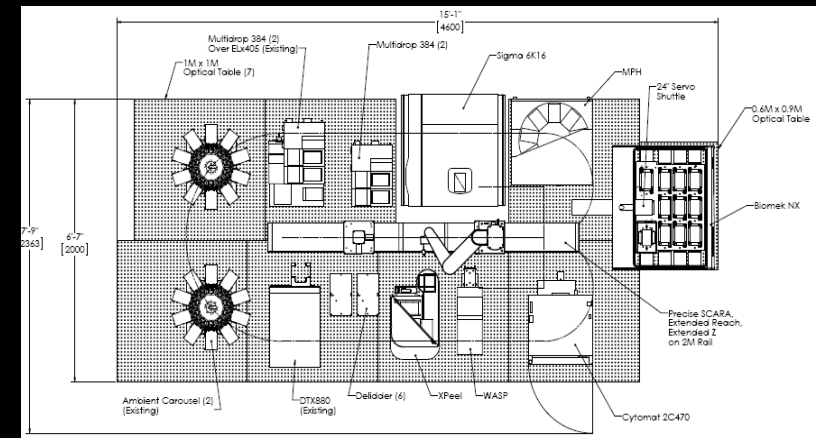
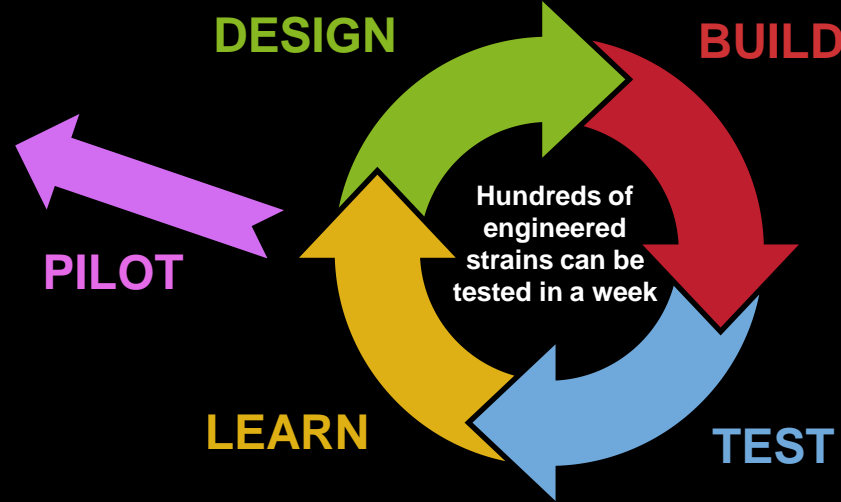

A robotic platform for
efficient DNA assembly,
transformation and
strain screening



International Consortia



Engineering Biology Research Consortium (USA)



Global Biofoundries Alliance



EU-IBISBA Industrial Biotechnology Innovation and Synthetic biology Accelerator

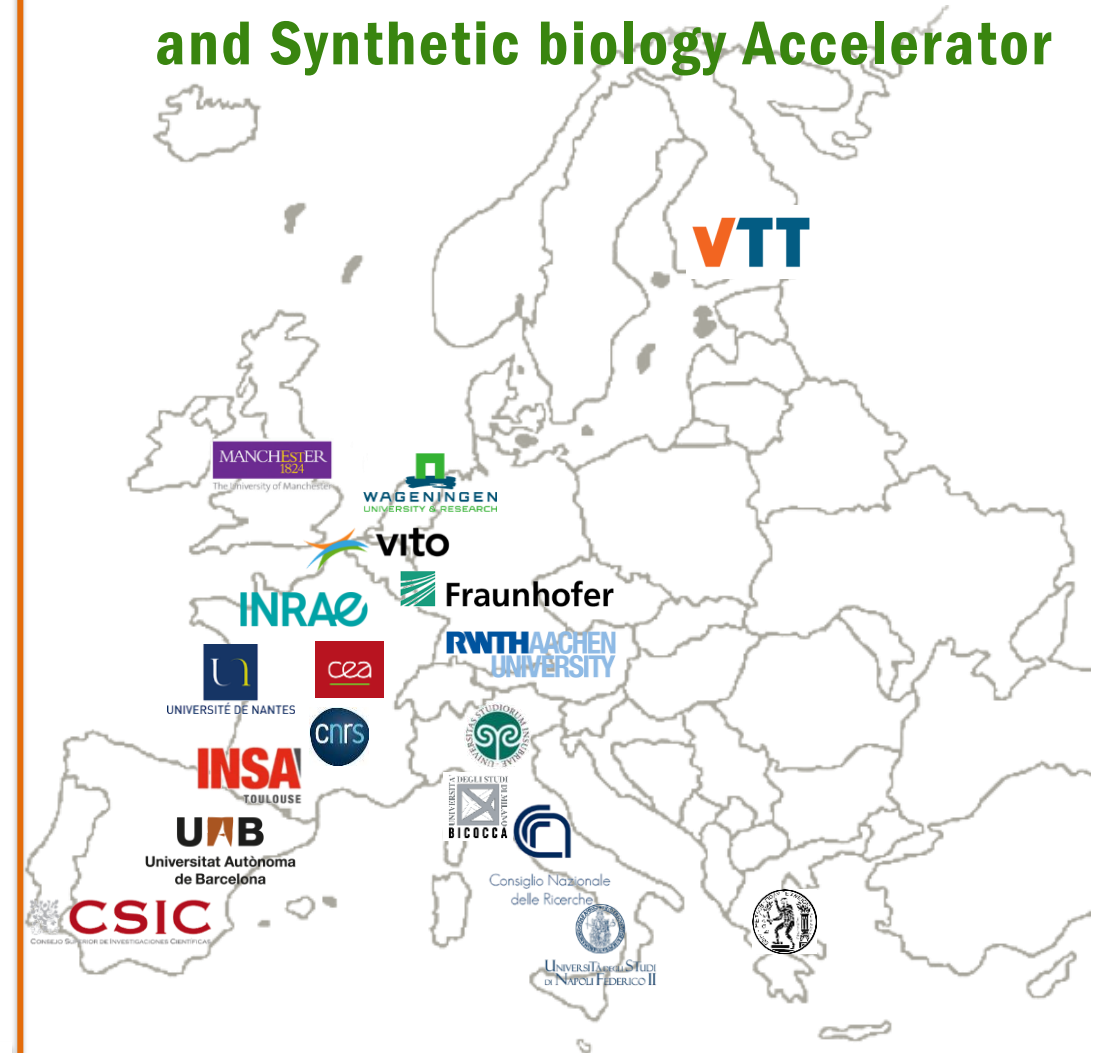

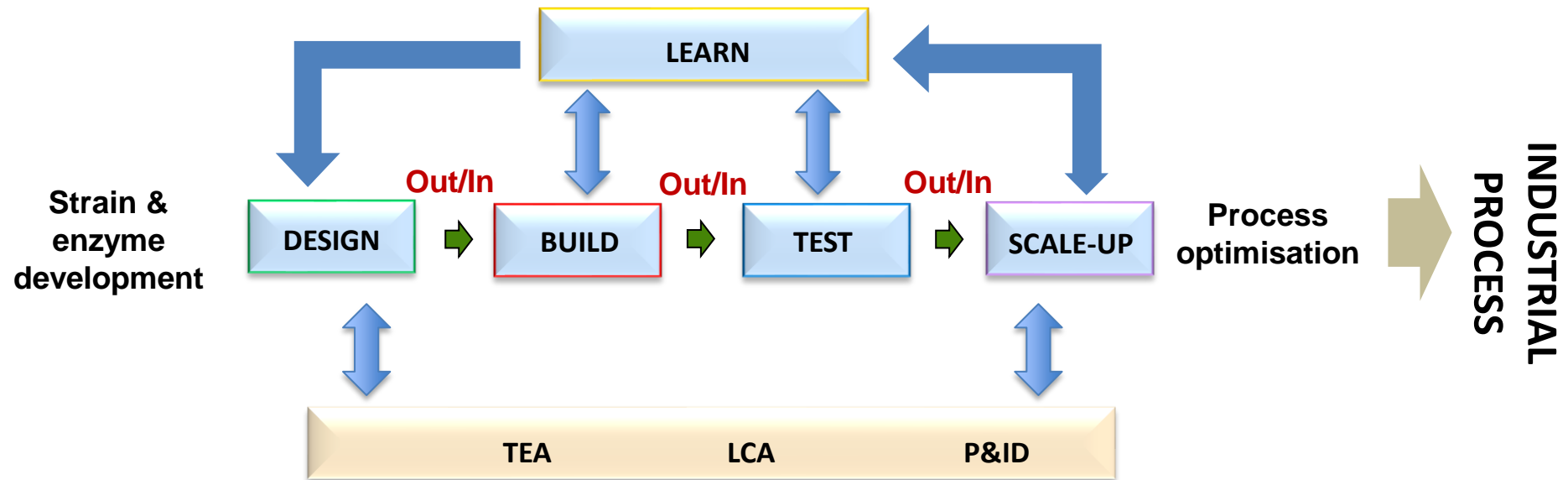

EU project IBISBA

Aim to accelerate biotechnology development through excellence in capabilities and infrastructure
– from biocatalyst design to bioprocess



TEA, technoeconomic analysis
LCA, life cycle analysis
P&ID, piping and instrumentation diagram

From distributed capabilities to harmonised seamless services

- **Dissection of tasks** that are needed to carry out projects – computational and wet lab

- For creation of a **hierarchical structures of modular tasks** that can be combined to make **seamless workflows** (for automation) and for tracing back experiments
- For **harmonizing the Protocols** so that highest quality of results are obtained similarly in different labs. The Input to the next phase is verified with go/no go criteria (the devil is in the details!)
- **Experimental and computational verification** of key steps and parameters (that are good examples for most biotech cases)

- Making biology engineerable

IBISBA

Workflow steps with protocols

- Design
 - Execution of Design
 - Design production strain
 - Information search
 - Computational metabolic design
 - Computational product pathway design
 - Enumerate pathway options (e.g. Retropath)
 - Score pathways without chassis
 - Chassis embedding
 - Receive input from product pathway design
 - Map metabolites between pathway and chassis
 - Add production pathway to chassis SBML in silico
 - Fill metabolic gaps
 - Screen potential substrates in in silico
 - Screen growth conditions
 - Growth-product coupling (e.g. OptKnock, RobustKnock, Minimal Cut Sets)
 - Calculate expected yields
 - Estimate productivities
 - Evaluate and choose pathways
 - Genetic design for chassis
 - Select and/or design enzyme
 - Design DNA constructs for expression host
 - Design growth medium and cultivation conditions
 - Criteria for successful outcome of #Design
- Build
- Test
- Learn
- Upscale

Protocols linked to tasks



IBISBA Workflow platform

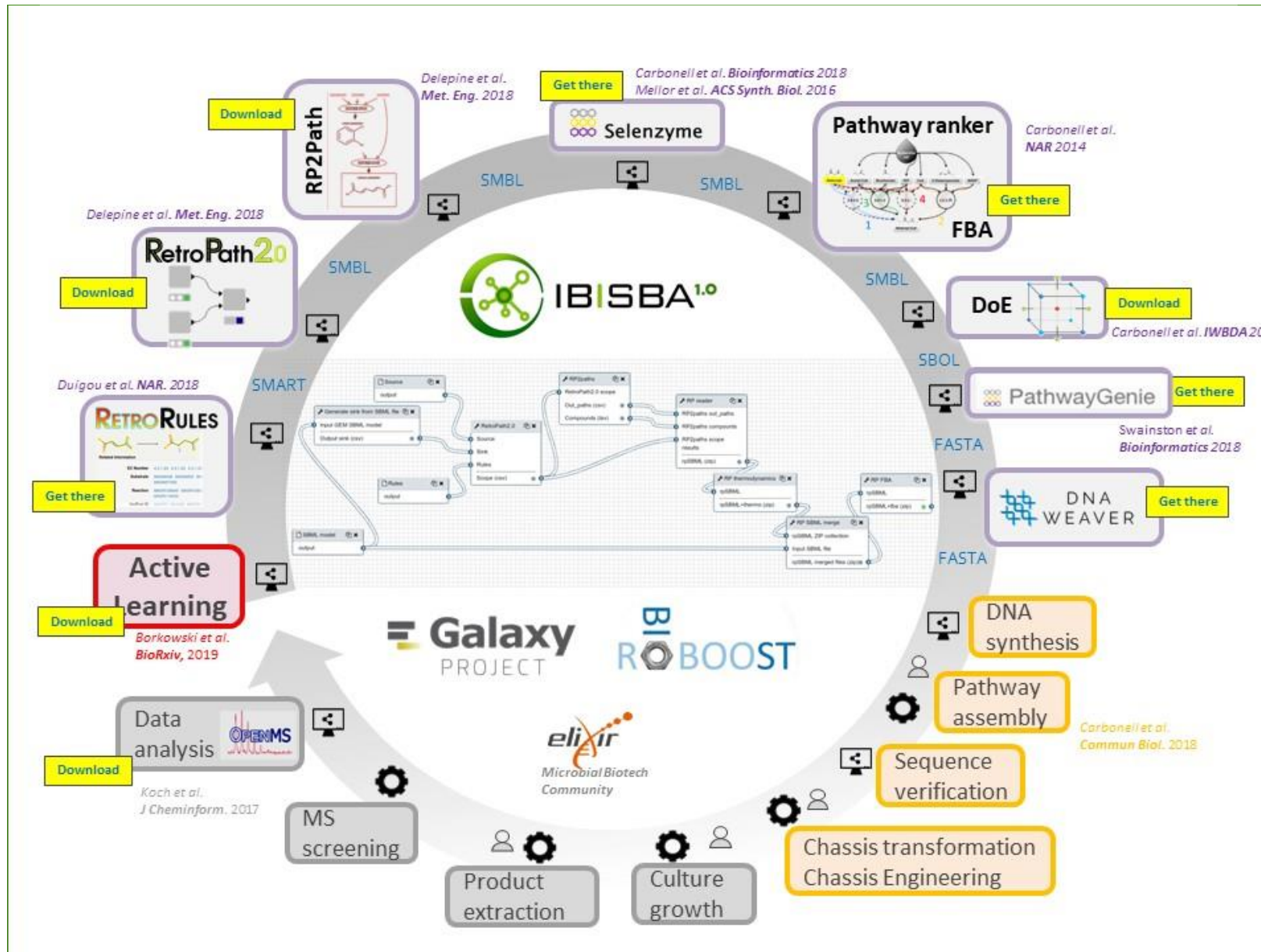

Synbio examples for biotechnology

Synthetic pathway and strain optimization for opioid synthesis in yeast

Stephanie Galanie et al. *Science*
2015;349:1095-1100

- Overexpression of two native yeast enzymes
- Deletion of one native yeast gene
- Expression of 21 heterologous enzymes from plants, mammals, bacteria, and yeast (color codes)
- P450 enzyme (SalSyn) engineering to obtain a fusion protein for correct glycosylation and activity

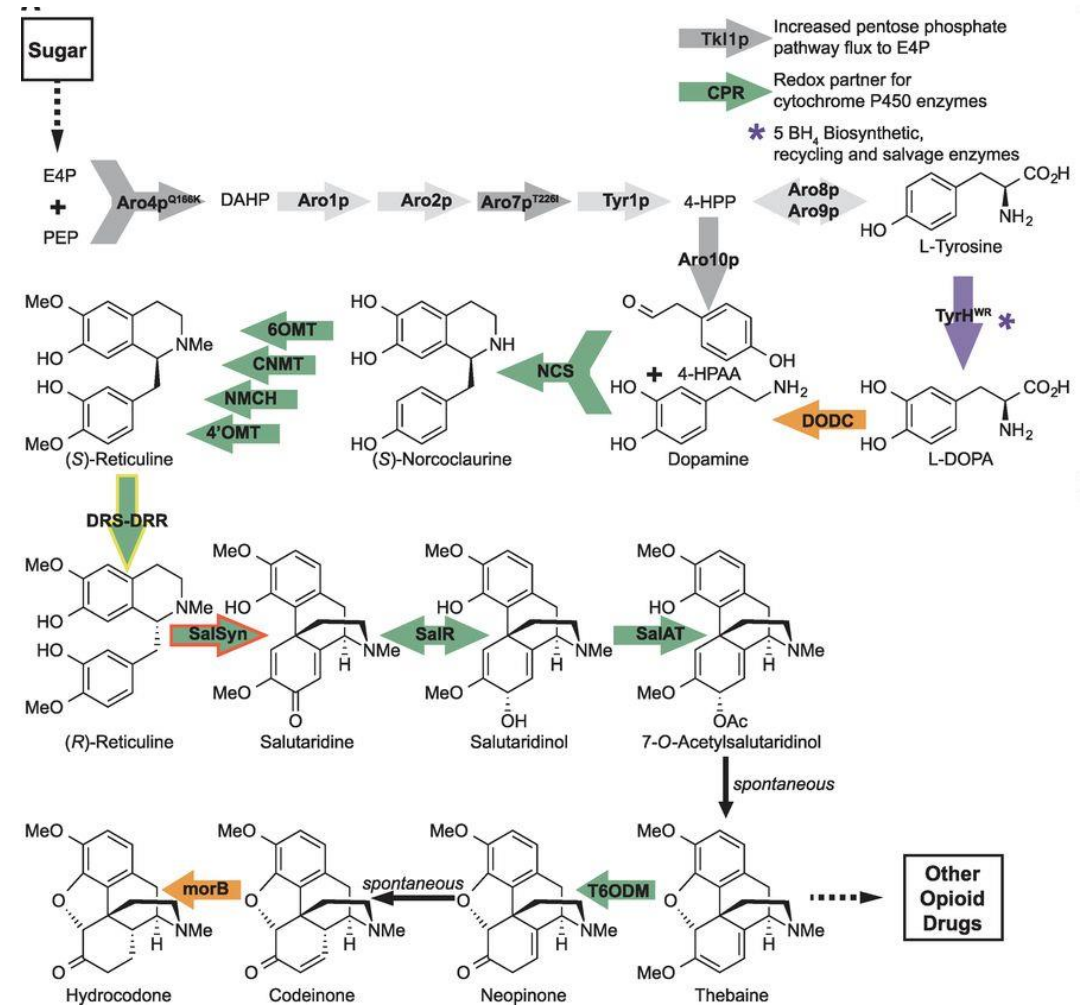

Biosynthetic scheme for production of thebaine and hydrocodone from sugar. Thebaine is a starting material for many opioid drugs through biosynthetic and semisynthetic routes. Block arrows indicate enzyme-catalyzed steps. **Light gray arrows**, unmodified yeast enzymes; **dark gray arrows**, overexpressed and modified yeast enzymes; **purple arrows**, mammalian (*Rattus norvegicus*) enzymes; **orange arrows**, bacterial (*Pseudomonas putida*) enzymes; **green arrows**, plant (*Papaver somniferum*, *P. bracteatum*, *Coptis japonica*, *Eschscholzia californica*) enzymes. Yellow outline highlights DRS-DRR; **red outline** highlights engineered SalSyn. E4P, erythrose 4-phosphate; PEP, phosphoenolpyruvate; DAHP, 3-deoxy-d-arabino-2-heptulosonic acid 7-phosphate; 4-HPP, 4-hydroxyphenylpyruvate; 4-HPAA, 4-hydroxyphenylacetaldehyde; BH₄, 5,6,7,8-tetrahydrobiopterin; Tk1p, transketolase; CPR, cytochrome P450 reductase; Aro4p^{Q168K}, DAHP synthase; Aro1p, pentafunctional *arom* enzyme; Aro2p, bifunctional chorismate synthase and flavin reductase; Aro7p^{T226I}, chorismate mutase; Tyr1p, prephenate dehydrogenase; Aro8p, aromatic aminotransferase I; Aro9p, aromatic aminotransferase II; Aro10p, phenylpyruvate decarboxylase; TyrH^{WR}, feedback inhibition-resistant tyrosine hydroxylase (mutations R37E, R38E, W166Y); DODC, L-DOPA decarboxylase; NCS, (S)-norcoclaurine synthase; 6OMT, norcoclaurine 6-O-methyltransferase; CNMT, coclaurine N-methyltransferase; NMCH, N-methylcoclaurine hydroxylase; 4'OMT, 3'-hydroxy-N-methylcoclaurine 4'-O-methyltransferase; DRS-DRR, 1,2-dehydroreticuline synthase-1,2-dehydroreticuline reductase; SalSyn, salutaridine synthase; SalR, salutaridine reductase; SalAT, salutaridinol 7-O-acetyltransferase; T6ODM, thebaine 6-O-demethylase; morB, morphinone reductase.

Cannabinoid synthesis in yeast

Nature 2019, vol 567:123

Complete biosynthesis of cannabinoids and their unnatural analogues in yeast

Xiaozhou Luo^{1,15}, Michael A. Reiter^{1,2,15}, Leo d'Espaux^{3,12}, Jeff Wong^{3,12}, Charles M. Denby^{1,13}, Anna Lechner^{4,5,14}, Yunfeng Zhang^{1,6}, Adrian T. Grzybowski¹, Simon Harth³, Weiyin Lin³, Hyunsu Lee^{3,7}, Changhua Yu^{3,5}, John Shin^{3,4}, Kai Deng^{8,9}, Veronica T. Benites³, George Wang³, Edward E. K. Baidoo³, Yan Chen³, Ishaan Dev^{3,4}, Christopher J. Petzold³ & Jay D. Keasling^{1,3,4,5,10,11*}

Synthetic pathway required for efficient precursor (hexanoyl-CoA) production

Introduced also a gene for a previously undiscovered enzyme with geranylpyrophosphate:olivetolate geranyltransferase activity (CsPT4) (known natural producer gene gave no activity)

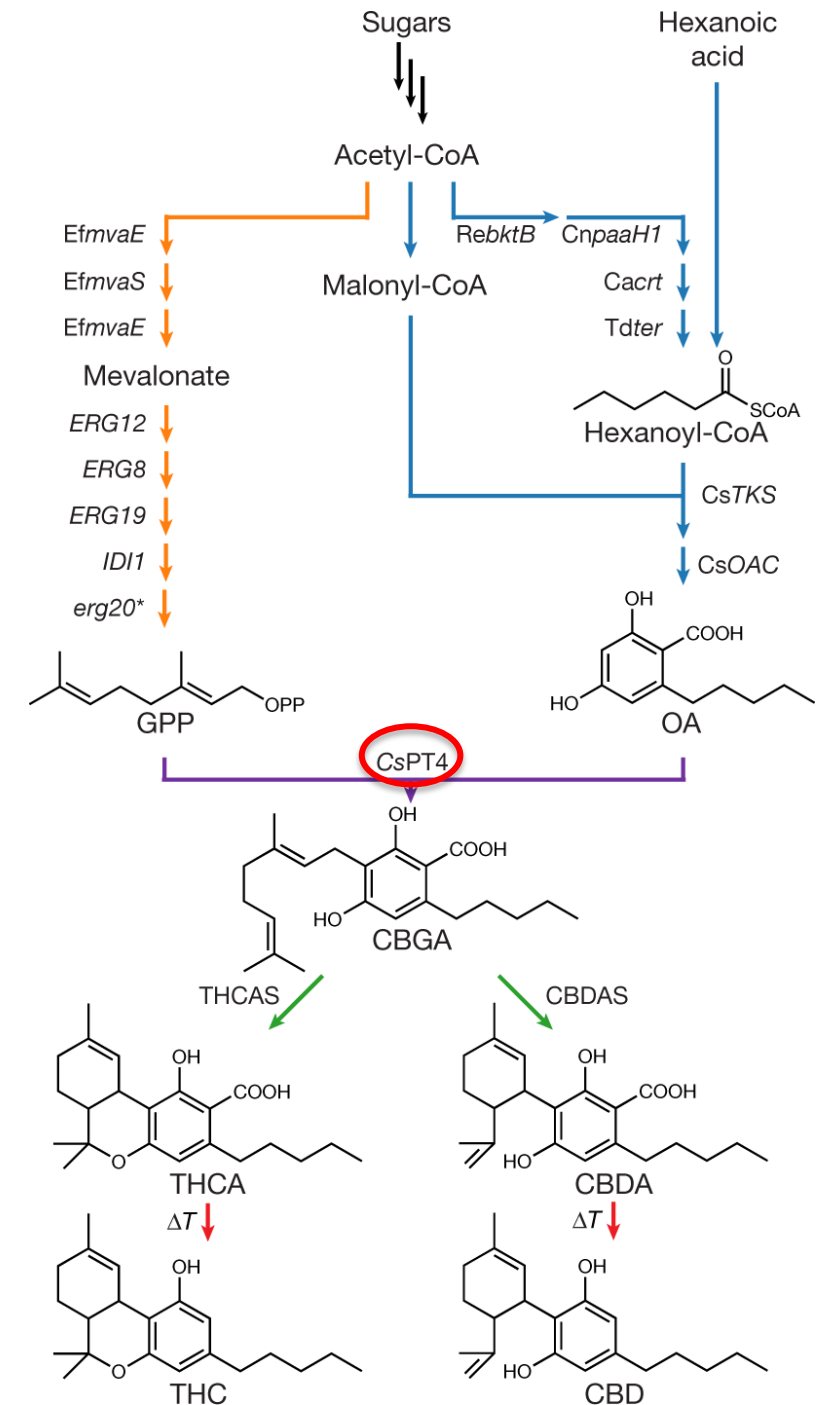

Synthetic non-oxidative glycolysis

– prevention of carbon loss in AcCoA formation (1)

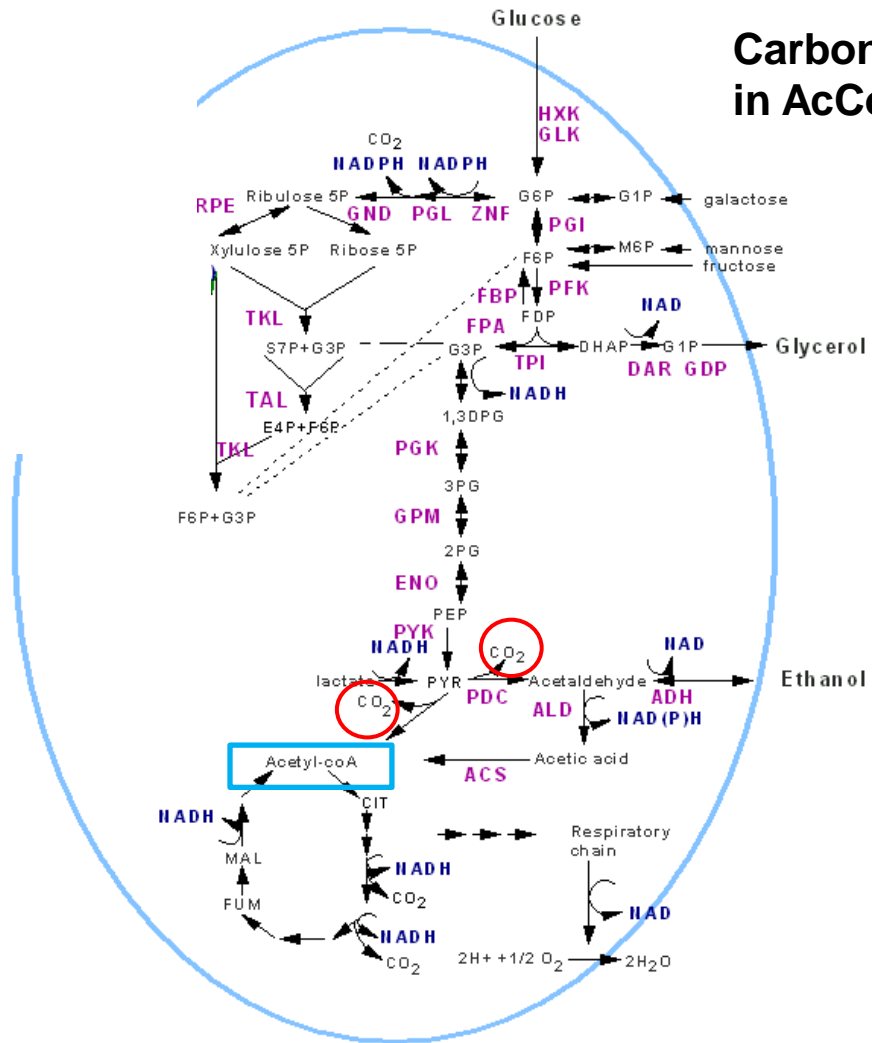

Carbon is lost
in AcCoA formation

AcCoA is a key intermediate
in product pathways

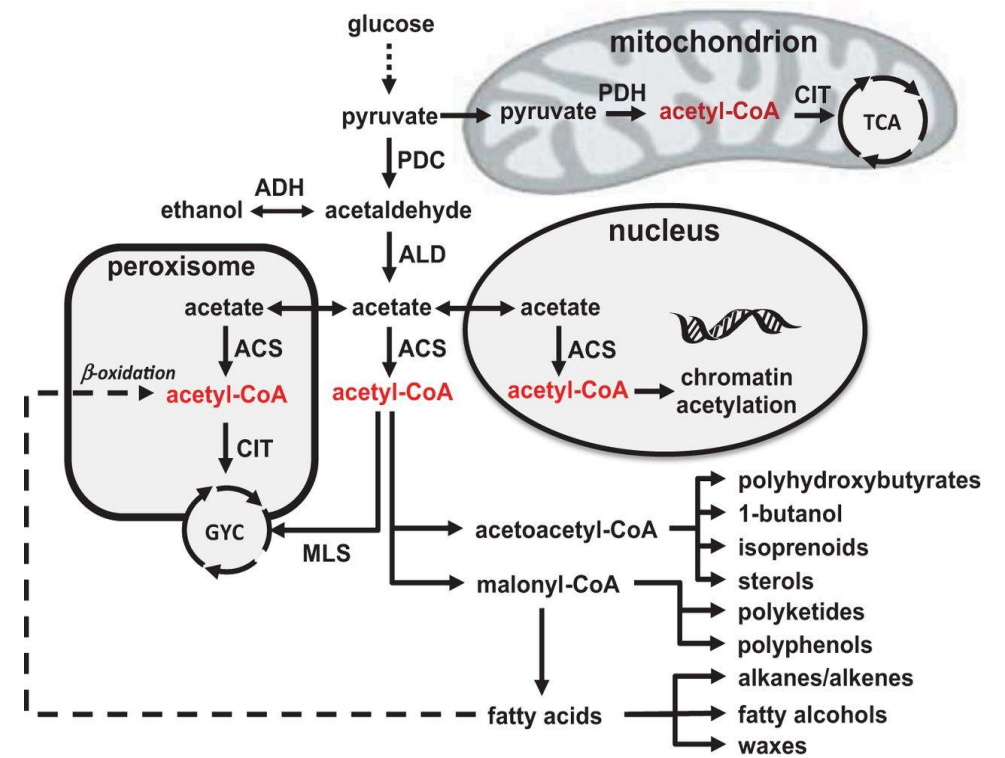

Bogorad et al. (2013). Synthetic non-oxidative glycolysis enables complete carbon conservation. *Nature* 502, 693-697.

Synthetic non-oxidative glycolysis

– prevention of carbon loss in AcCoA formation (2)

C1 or sugar as carbon sources

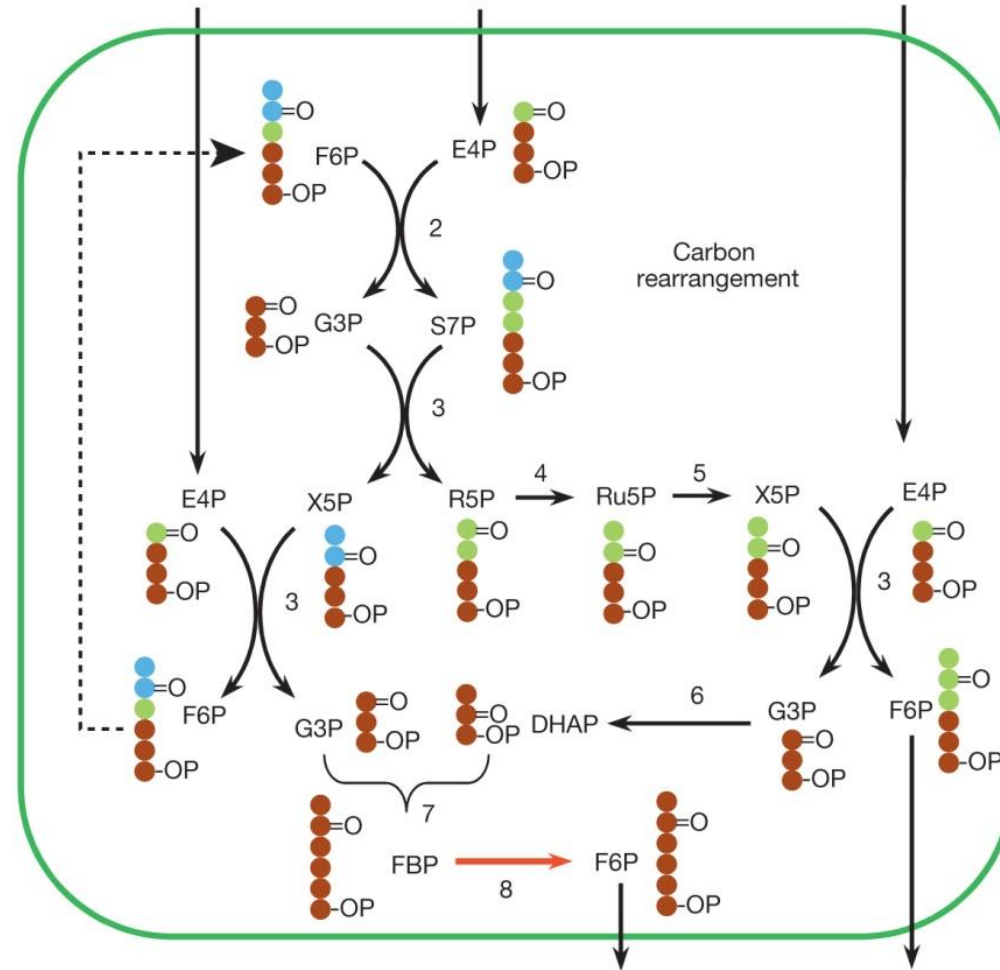
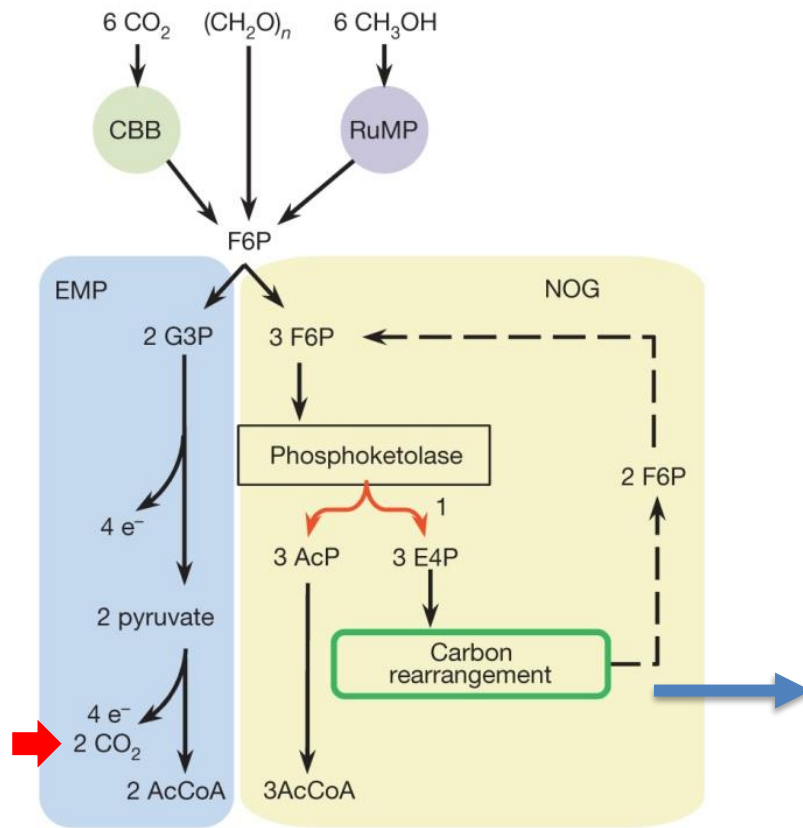

Bogorad et al. (2013). Synthetic non-oxidative glycolysis enables complete carbon conservation. *Nature* 502, 693-697.

Enzyme numbers: 1, phosphoketolase; 2, Tal; 3, Tkt; 4, Rpi; 5, Rpe; 6, Tpi; 7, Fba; 8, Fbp. DHAP, dihydroxyacetone phosphate; Ru5P, ribulose 5-phosphate.

Synthetic non-oxidative glycolysis

– prevention of carbon loss in AcCoA formation (3)

PHOSPHOKETOLASE:

D-fructose 6-phosphate + phosphate \rightarrow acetyl phosphate + D-erythrose 4-phosphate + H₂O

D-xylulose 5-phosphate + phosphate \rightarrow acetyl phosphate + D-glyceraldehyde 3-phosphate + H₂O

D-sedoheptulose 7-phosphate + phosphate \rightarrow acetyl phosphate + D-ribose 5-phosphate + H₂O

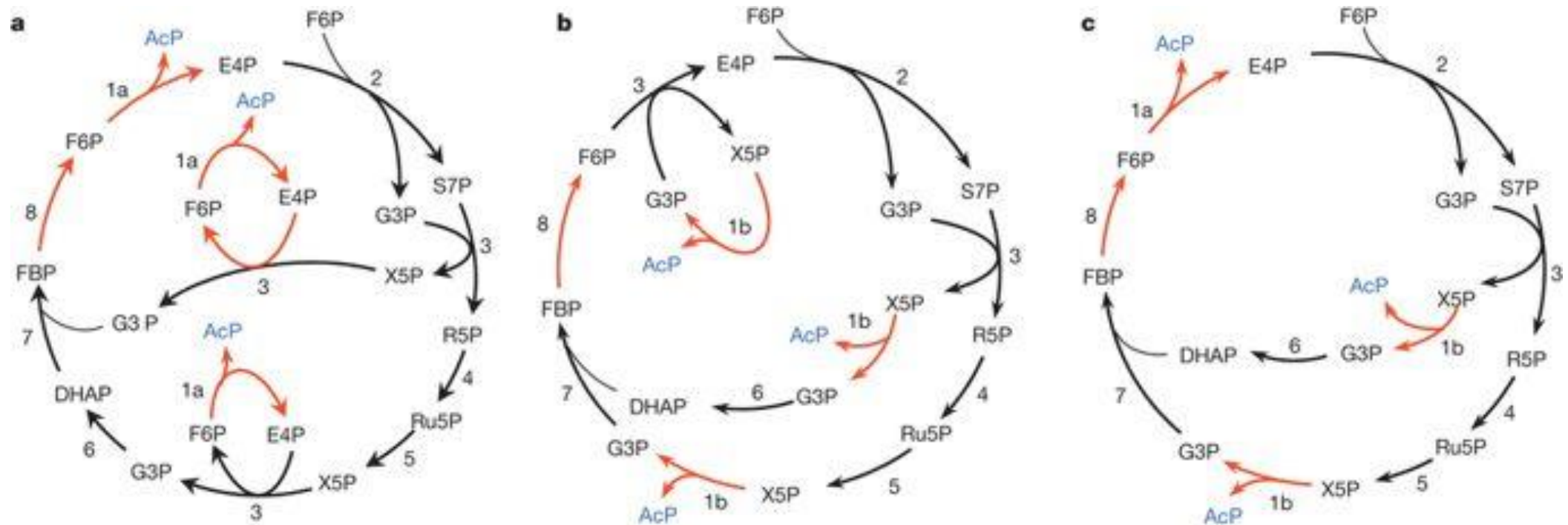

Phosphate acetyl transferase (PTA): CoA + acetyl phosphate \rightarrow acetyl-CoA + phosphate

Engineering for C-Si bonds

Silicon based life ?

- at least biochemicals

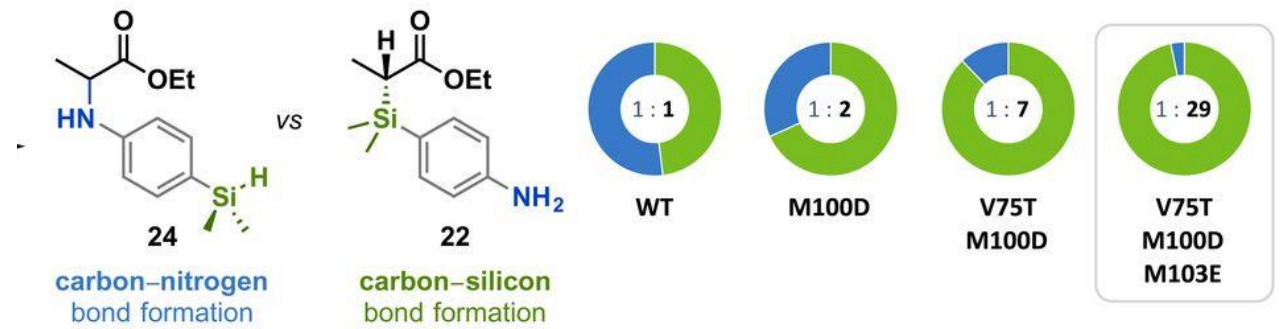

- Silicon is the second most abundant element on Earth, after oxygen
- It is not found in biochemistry but life based on silicon (instead of carbon) has been suggested as alternative (e.g. in space)
- Frances Arnold and her group were able to create C-Si bonds in living *E.coli* by engineering an enzyme of *Rhodothermus marinus* from Icelandic hot springs using (only 3 rounds!) directed evolution
- Si has both metal and non-metal properties
 - > enzyme: cytochrome C (heme Fe²⁺), an electron transfer protein that does not perform a catalytic function in nature
- The engineered reaction is 15-fold more efficient than with chemical catalysts with certain Si compounds



President Sauli Niinistö is giving the Millennium Technology Prize 2016 to Frances Arnold (California Institute of Technology, USA). Figure M. Penttilä

S. B. Jennifer Kan, Russell D. Lewis, Kai Chen, Frances H. Arnold. Directed evolution of cytochrome c for carbon-silicon bond formation: Bringing silicon to life. *Science* 25 November 2016. Vol 354 (6315). !048-1051.

The finding could help chemists to develop new pharmaceuticals and industrial catalysts — and perhaps explain why evolution has almost completely shunned silicon.

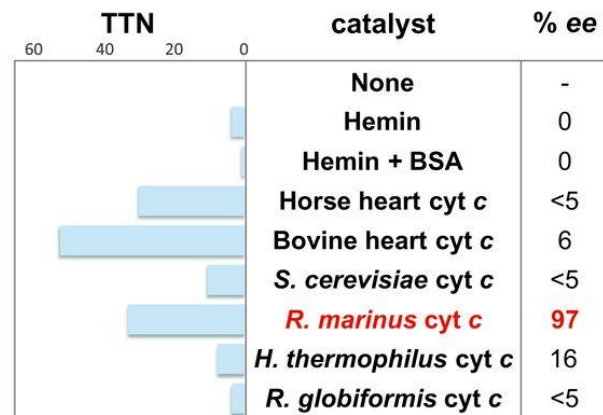
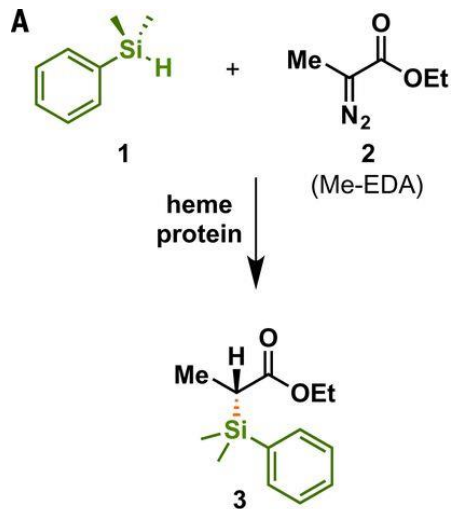

Various P450s and myoglobin also catalyzed the formation of carbon-silicon bonds, but the reactions were not enantioselective (see Supplementary Materials).

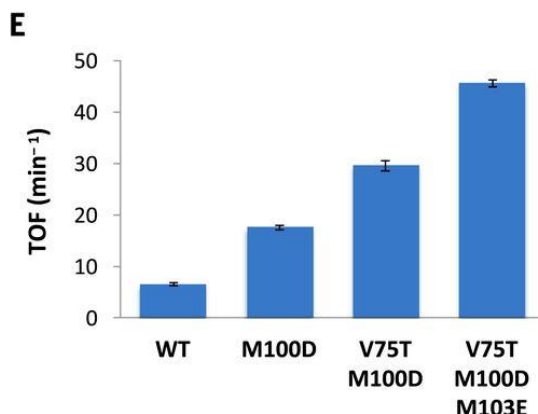
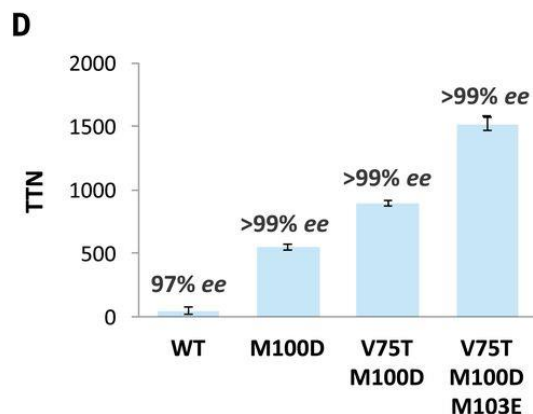
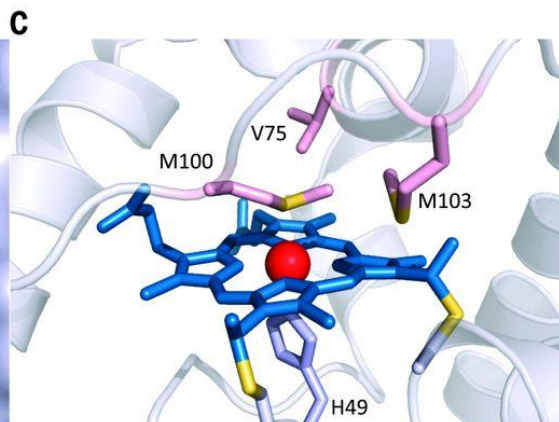
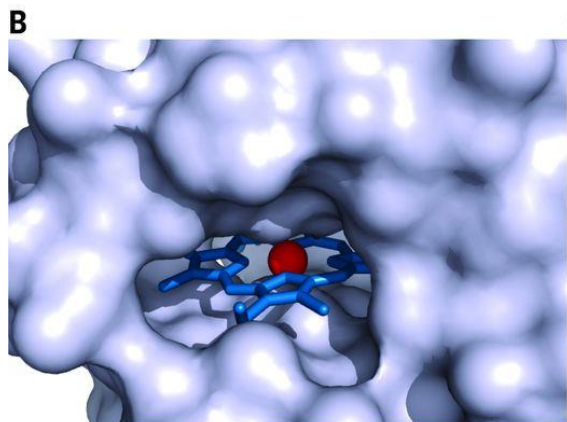

Heme protein-catalyzed carbon-silicon bond formation.

(A) Carbon-silicon bond formation catalyzed by heme and purified heme proteins. (B) Surface representation of the heme-binding pocket of wild-type *Rma* cyt c (PDB ID: 3CP5). (C) “Active site” structure of wild-type *Rma* cyt c showing a covalently bound heme cofactor ligated by axial ligands H49 and M100. Amino acid residues M100, V75, and M103 residing close to the heme iron were subjected to site-saturation mutagenesis. (D) Directed evolution of *Rma* cyt c for carbon-silicon bond formation [reaction shown in (A)]. Experiments were performed using lysates of *E. coli* expressing *Rma* cyt c variant (OD₆₀₀ = 15; heat-treated at 75°C for 10 min), 10 mM silane, 10 mM diazo ester, 10 mM Na₂S₂O₄, 5 vol % MeCN, M9-N buffer (pH 7.4) at room temperature under anaerobic conditions for 1.5 hours. Reactions were done in triplicate. (E) Carbon-silicon bond forming rates over four generations of *Rma* cyt c. Single-letter abbreviations for the amino acid residues are as follows: D, Asp; E, Glu; M, Met; T, Thr; and V, Val. TTN, total turn over number.

S. B. Jennifer Kan, Russell D. Lewis, Kai Chen, Frances H. Arnold. Directed evolution of cytochrome c for carbon-silicon bond formation: Bringing silicon to life. *Science* 25 November 2016. Vol 354 (6315):1048-1051.

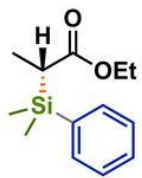
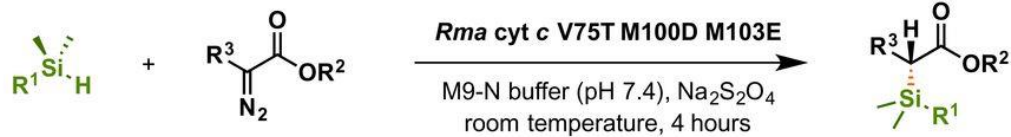

3: 2520 TTN, >99% ee



4: 1410 TTN, >99% ee



5: 2830 TTN, >99% ee



6: 2030 TTN, >99% ee



7: 140 TTN, >99% ee [a]



8: 150 TTN, >99% ee [a]



9: 680 TTN, >99% ee

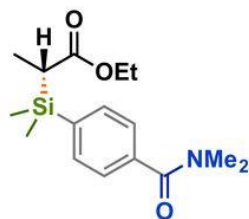

10: 1220 TTN, >99% ee

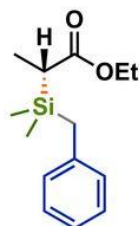

14: 740 TTN, >99% ee

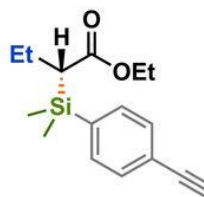

16: 47 TTN, >99% ee [c]

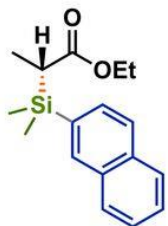

11: 510 TTN, 95% ee

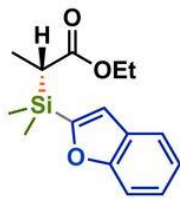

12: 490 TTN, 98% ee

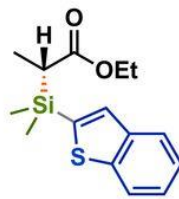

13: 210 TTN, 98% ee

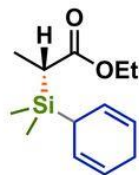

15: 630 TTN, 99% ee



17: 660 TTN, >99% ee

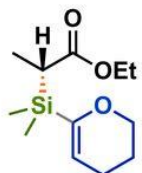

18: 930 TTN, >99% ee

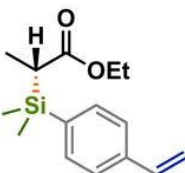

19: 520 TTN, 98% ee [d]

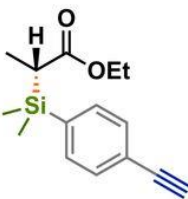

20: 5010 TTN, >99% ee [b]



21: 910 TTN, >99% ee [c, d]



22: 6080 TTN, >99% ee
8210 TTN, >99% ee [e]

Scope of *Rma* cyt c V75T M100D M103E-catalyzed carbon–silicon bond formation.

Standard reaction conditions: lysate of *E. coli* expressing *Rma* cyt c V75T M100D M103E ($OD_{600} = 1.5$; heat-treated at 75°C for 10 min), 20 mM silane, 10 mM diazo ester, 10 mM $Na_2S_2O_4$, 5 vol % MeCN, M9-N buffer (pH 7.4) at room temperature under anaerobic conditions. Reactions performed in triplicate. [a] $OD_{600} = 5$ lysate. [b] $OD_{600} = 0.5$ lysate. [c] $OD_{600} = 15$ lysate. [d] 10 mM silane. [e] $OD_{600} = 0.15$ lysate.

Can be used already for *in vitro* enzymatic catalysis. Will take some time to make larger scale production with cells possible?

S. B. Jennifer Kan, Russell D. Lewis, Kai Chen, Frances H. Arnold. Directed evolution of cytochrome c for carbon–silicon bond formation: Bringing silicon to life. *Science* 25 November 2016. Vol 354 (6315):1048-1051.

Read this article

Retrosynthetic design of metabolic pathways to chemicals not found in nature

[Geng-MinLin, Robert Warden-Rothman & Christopher A.Voigt](#)

Current Opinion in Systems Biology 14, 82-107 (2019)

<https://doi.org/10.1016/j.coisb.2019.04.004>

Biochemistry vs. Chemistry

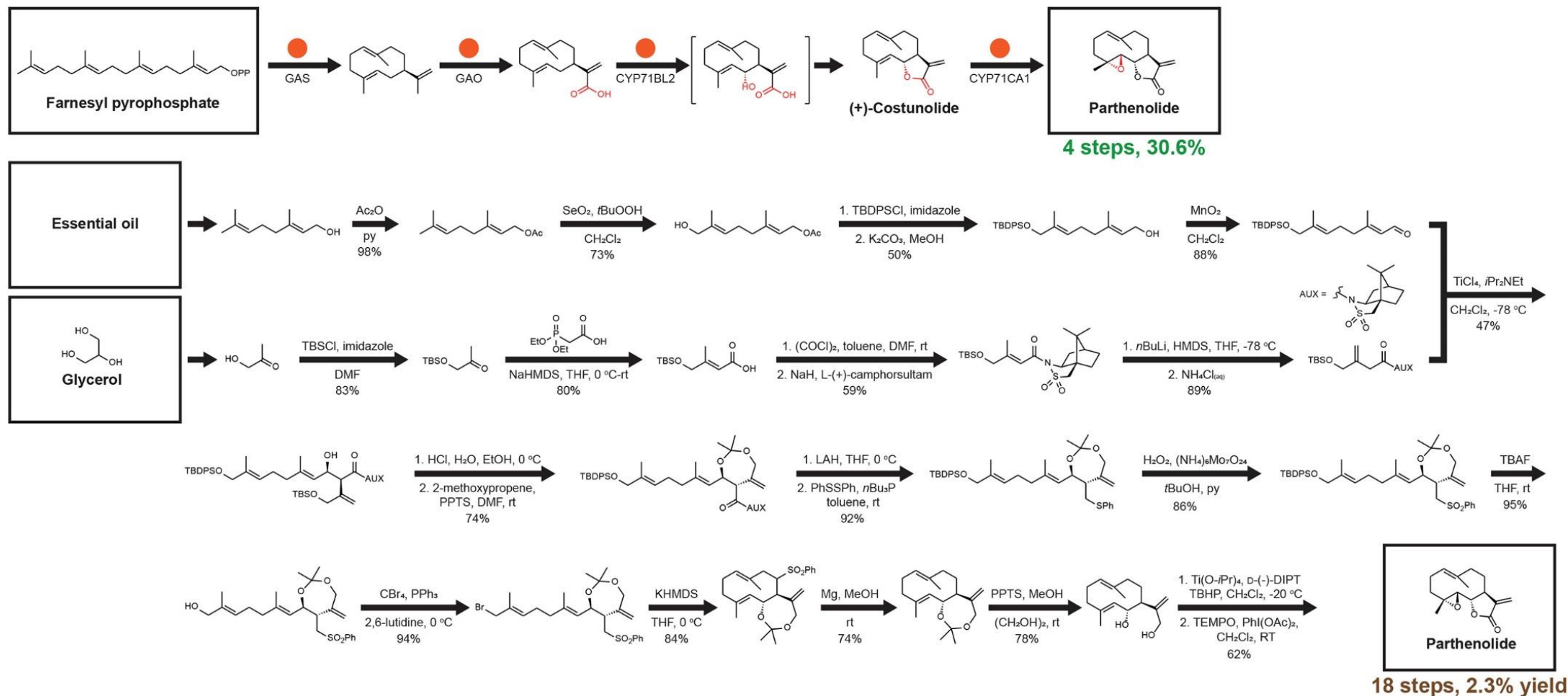

Comparison of metabolic (from FPP) and chemical routes to parthenolide. The pathway has been identified and transferred from its native organism (*Tanacetum parthenium*) to yeast and the theoretical yield of the biosynthetic route is shown (0.306 g/g **glucose**).

a.

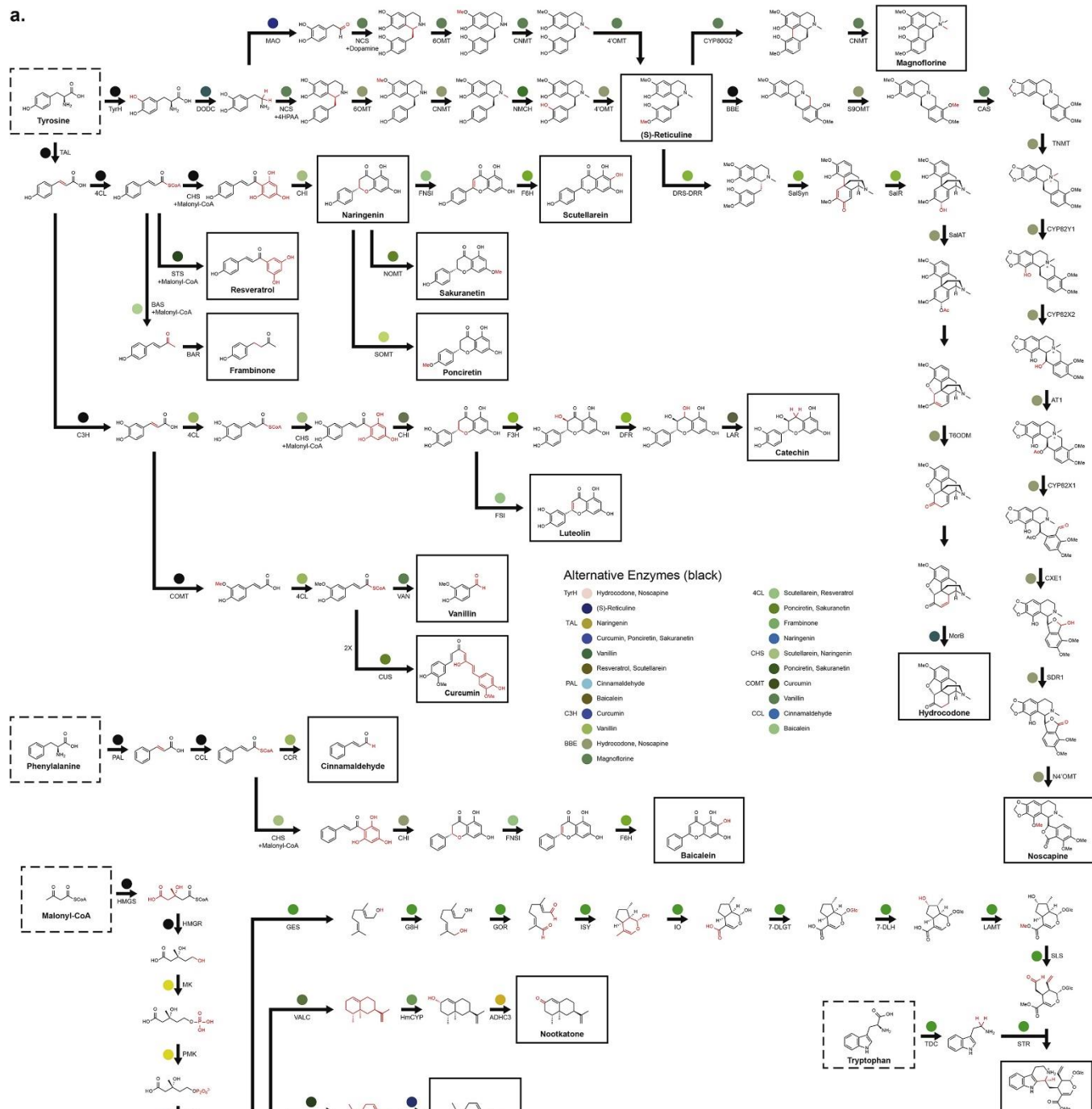

Natural
chemicals
produced in a
heterologous
host

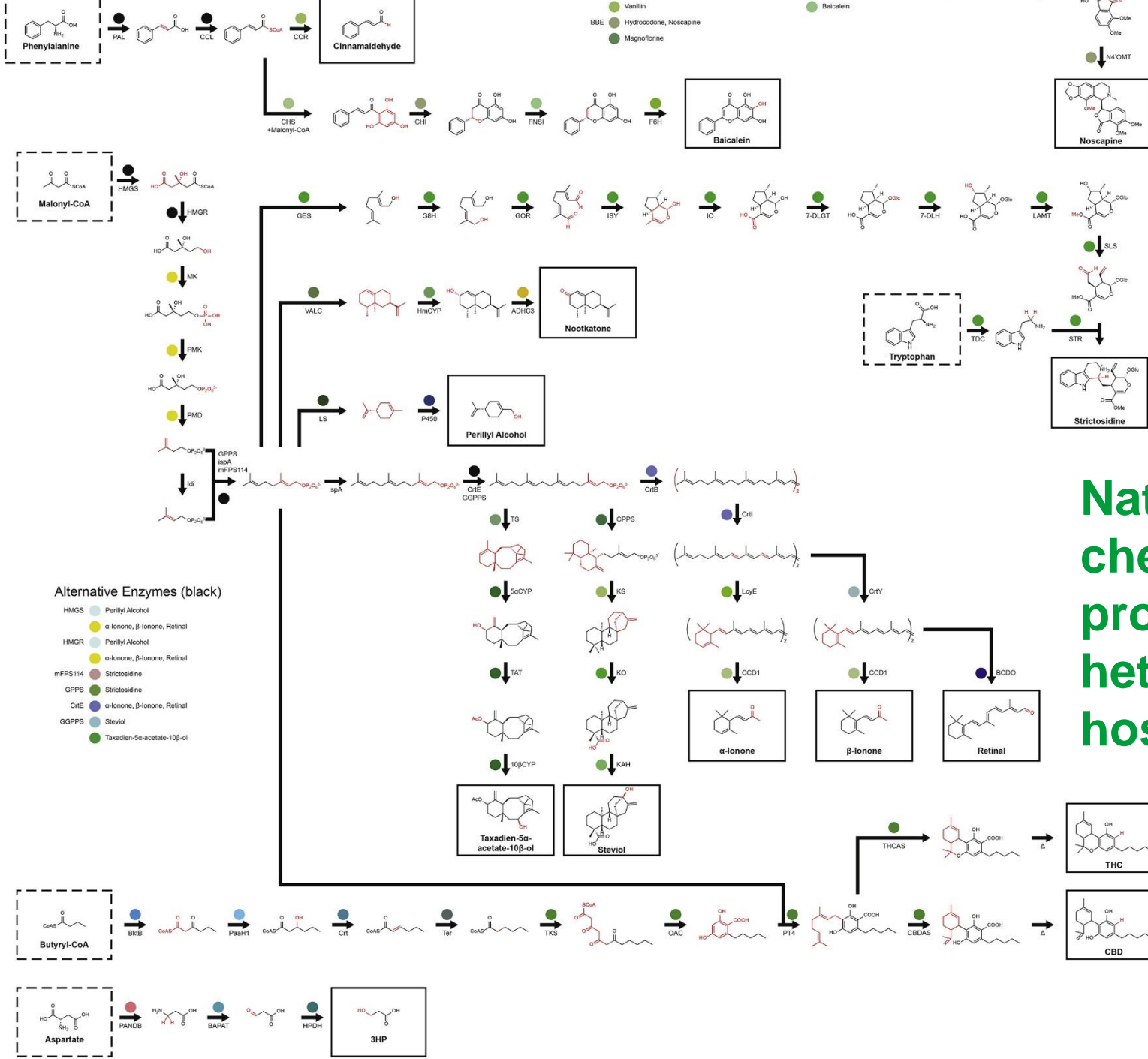

**Natural
chemicals
produced in a
heterologous
host**

Retrosynthesis for xenobiotic compounds, not found in nature

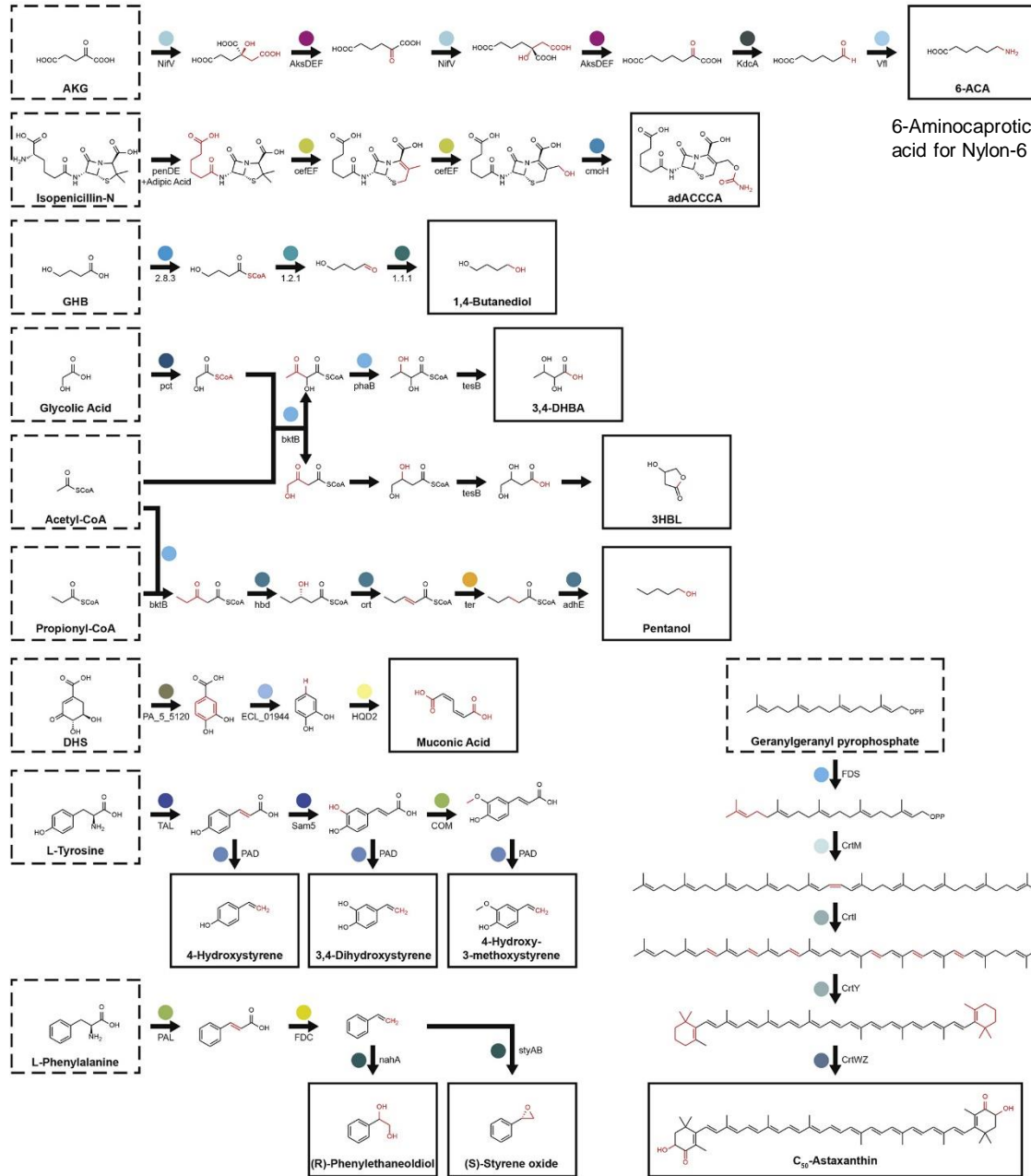

Enzyme Source Organisms

Archea

Methanococcus aeolicus

Fungi

Acremonium chrysogenum
Candida albicans
Pichia pastoris
Podospira anserina
Rhodotorula rubra
Rhodotorula toruloides
Saccharomyces cerevisiae

Bacteria

Acinetobacter calcoaceticus
Azotobacter vinelandii
Bacillus cereus
Bacillus amyloliquefaciens
Brevundimonas sp. SD212
Clostridium acetobutylicum
Clostridium beijerinckii
Cupriavidus necator
Enterobacter cloacae
Erwinia herbicola
Escherichia coli
Geobacillus stearothermophilus
Lactococcus lactis
Marine bacterium HF10_19P19
Megasphaera elsdenii
Micrococcus luteus
Mycobacterium HXN 1500
Pantoea ananatis
Porphyromonas gingivalis
Pseudomonas putida
Pseudomonas sp. VLB120
Ralstonia eutropha
Rhodococcus ruber
Saccharothrix espanaensis
Sphingomonas sp. HXN-200
Staphylococcus aureus
Streptomyces castaneoglobisporus
Streptomyces clavuligerus
Streptomyces coelicolor
Streptomyces maritimus
Synechococcus sp.
Treponema denticola
Vibrio fluvialis

Animals

Gallus gallus
Rattus norvegicus
Tribolium castaneum

Plants

Abies grandis
Arabidopsis thaliana
Camellia sinensis
Cannabis sativa
Catharanthus roseus
Coptis japonica
Cucumis sativus
Cucurbita maxima
Cupressus nootkatensis
Desmodium uncinatum
Eschscholzia californica
Glycine max
Glycyrrhiza echinata
Hyoscyamus muticus
Lactuca sativa
Medicago sativa
Mentha spicata
Nicotiana tabacum
Oryza sativa
Papaver bracteatum
Papaver somniferum
Petroselinum crispum
Petunia hybrida
Populus euramericana
Rubus idaeus
Prunus sp.
Scutellaria baicalensis
Solanum tuberosum
Stevia rebaudiana
Taxus brevifolia
Taxus canadensis
Taxus cuspidata
Vanilla planifolia
Vitis vinifera
Zea mays

Protists

Euglena gracilis

**Synthetic promoters and control circuits
for biotechnology
- VTT example**

SES

Orthogonal Synthetic Expression System for fungi

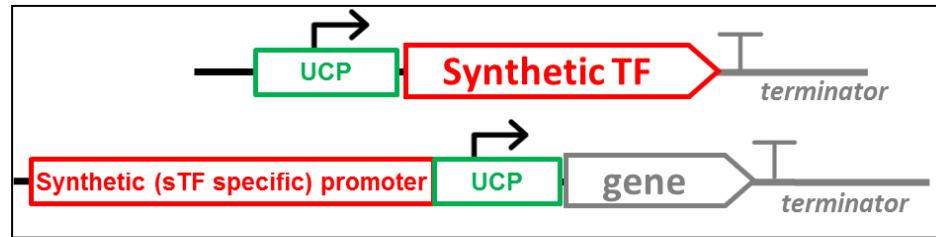

- Tunable controllable promoters, driving different expression levels
 - Constitutive, inducible or repressable
- Orthogonal, not responding to host's background regulation
 - Enables memory
 - Functional over several fungal species

Anssi Rantasalo, Joosu Kuivanen, Jussi Jääntti, Dominik Mojzita /VTT

Current situation

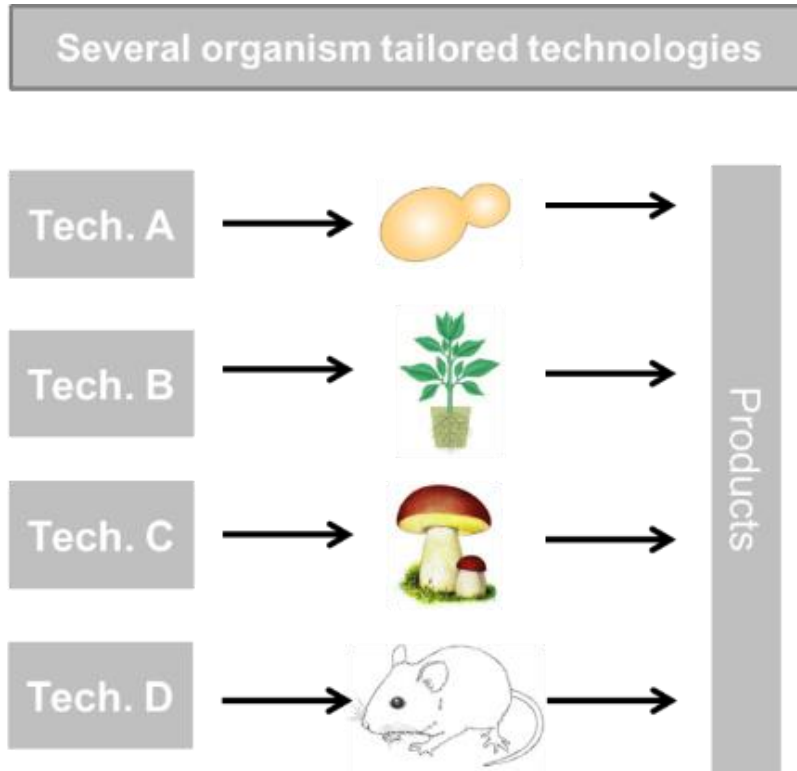

Novel approach

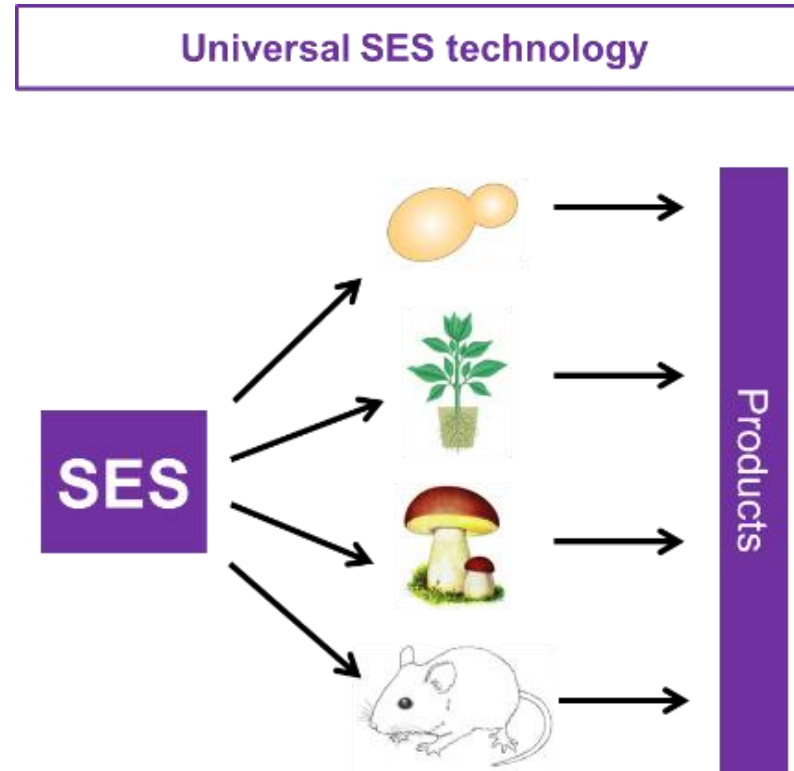

Eukaryotic gene expression

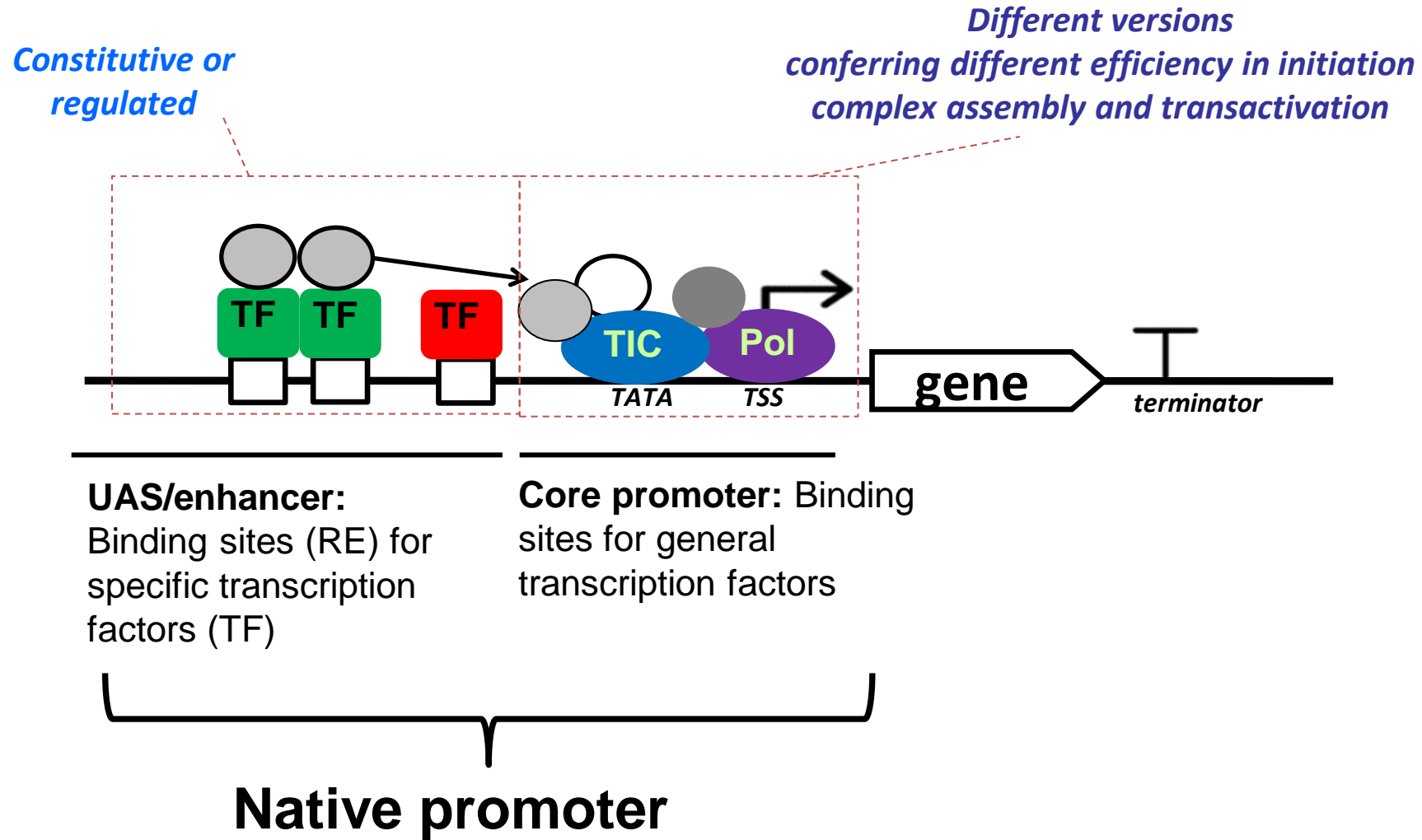

Synthetic gene expression system

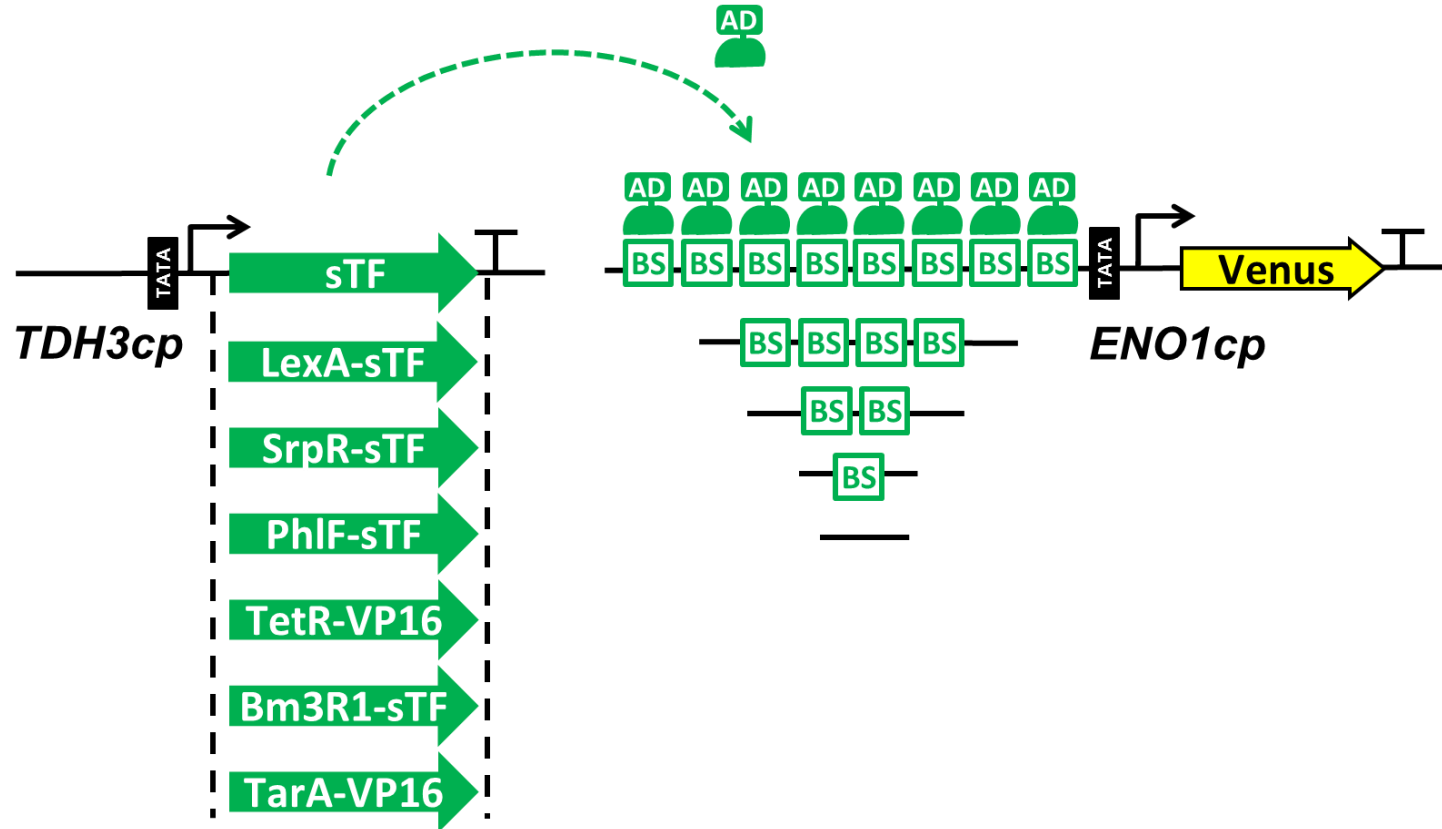

Development of a tunable expression system for *S. cerevisiae*

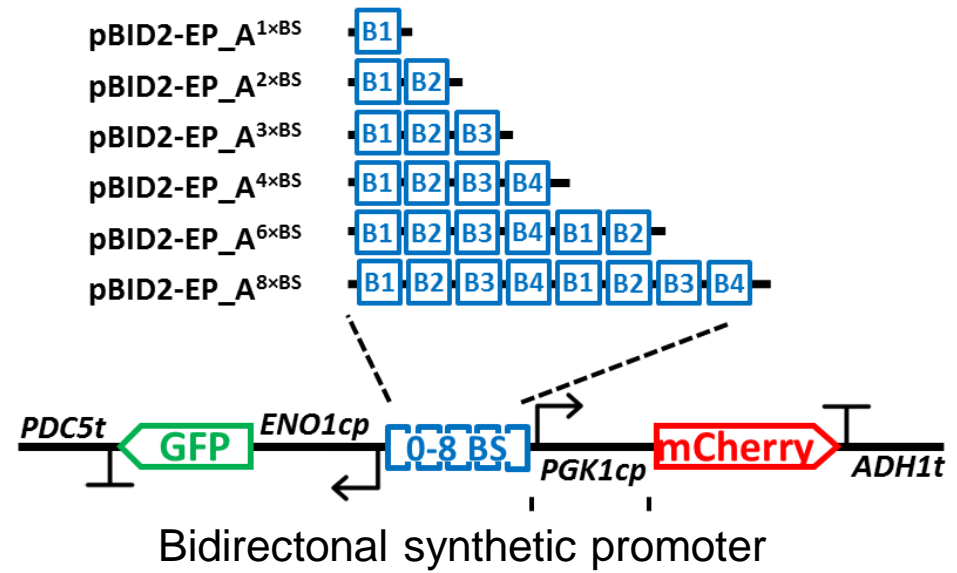
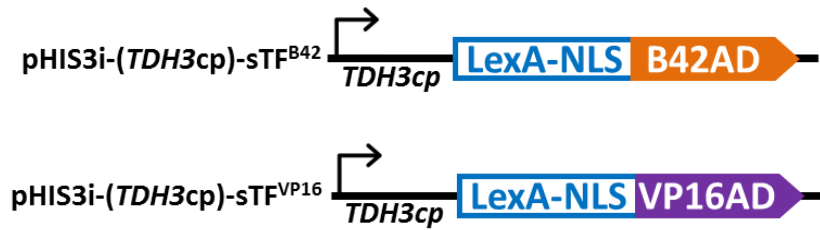

Development of a tunable expression system for *S. cerevisiae*

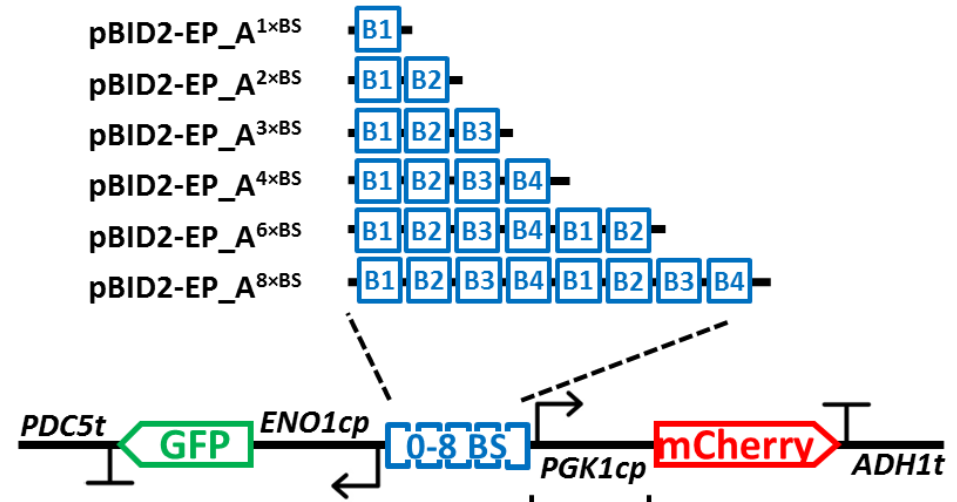
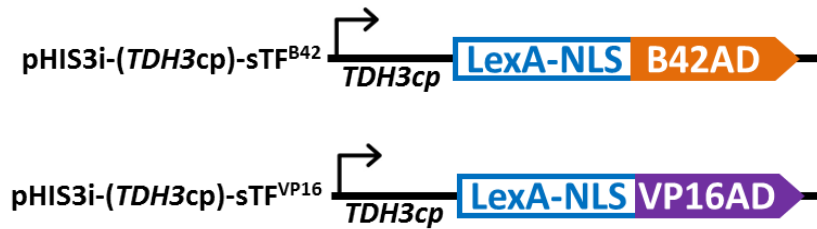

weak constitutive sTF^{B42}

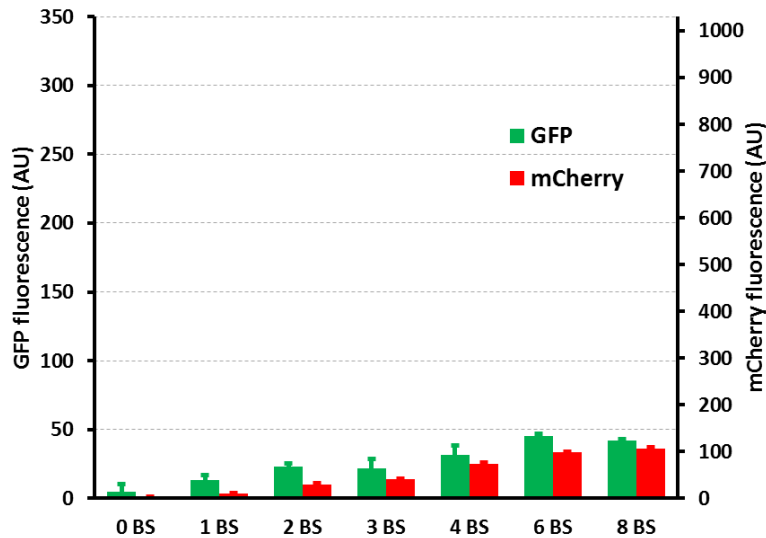

strong constitutive sTF^{VP16}

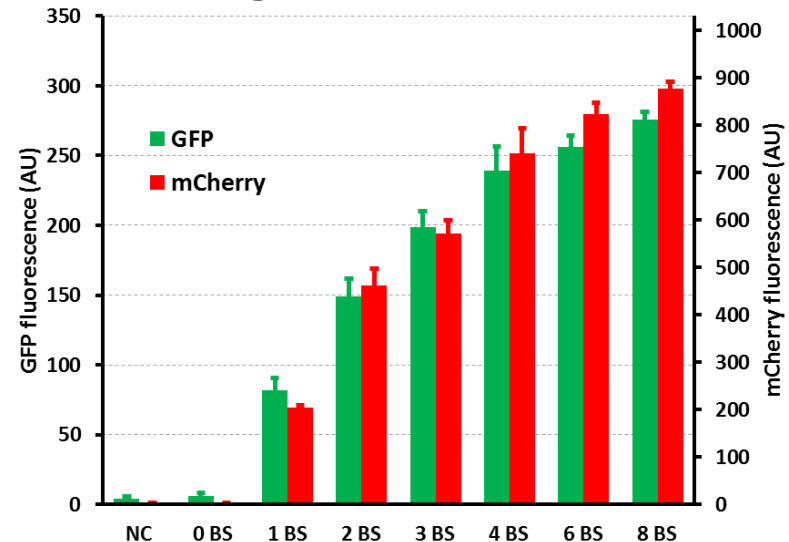

Orthogonality matrix – test of the sTFs' specificity

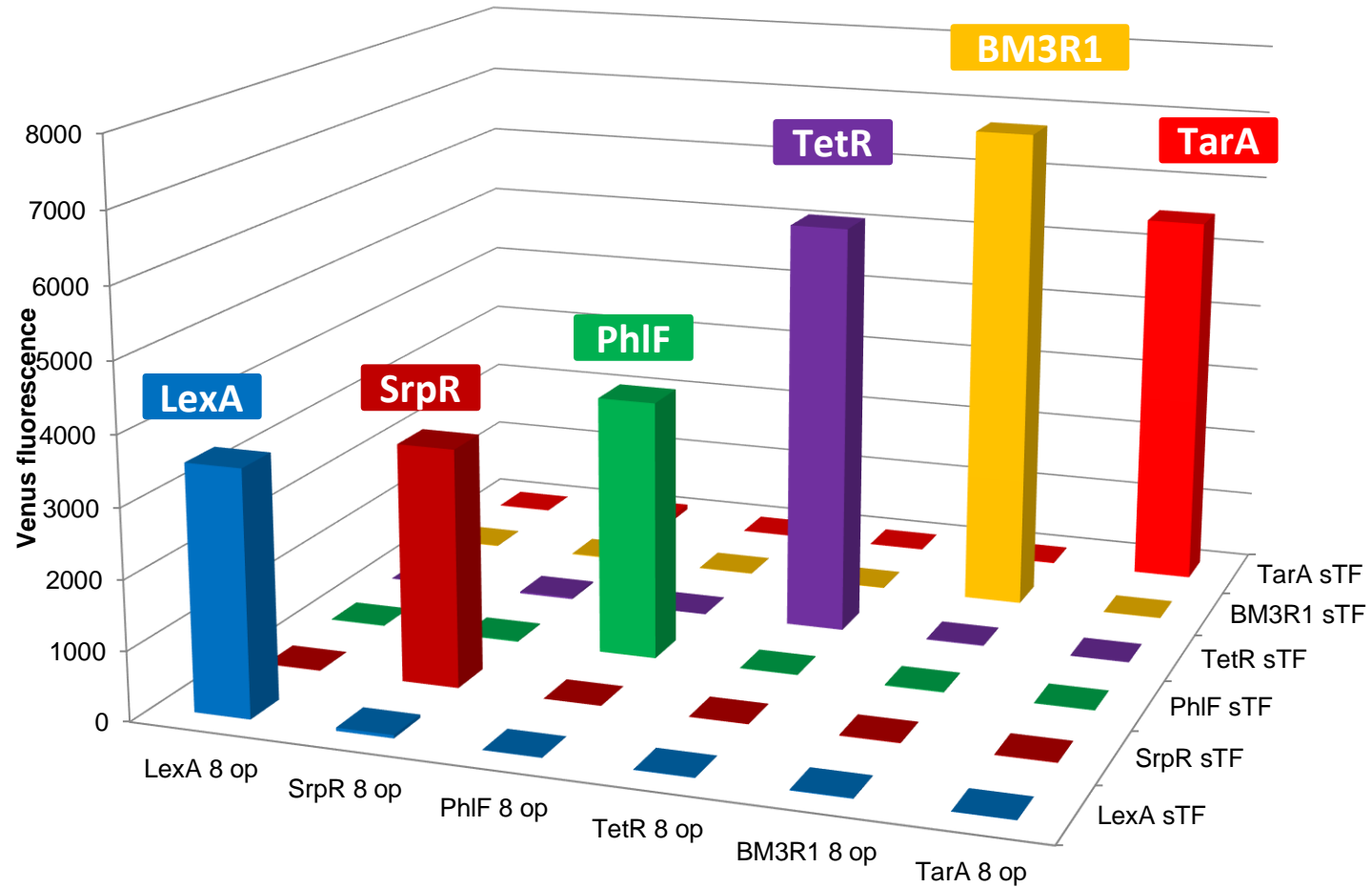

- Mathematical models of the different expression circuits

Universal core promoters for different fungi

- Core promoters of highly expressed genes from various organisms (as gBlocks).
- gBlocks assembled *in vivo* to a CEN-type plasmid in a yeast strain constitutively expressing LexA-based sTF.
- Strains analyzed for red fluorescence.
- A few new strong (universal) core promoters selected.

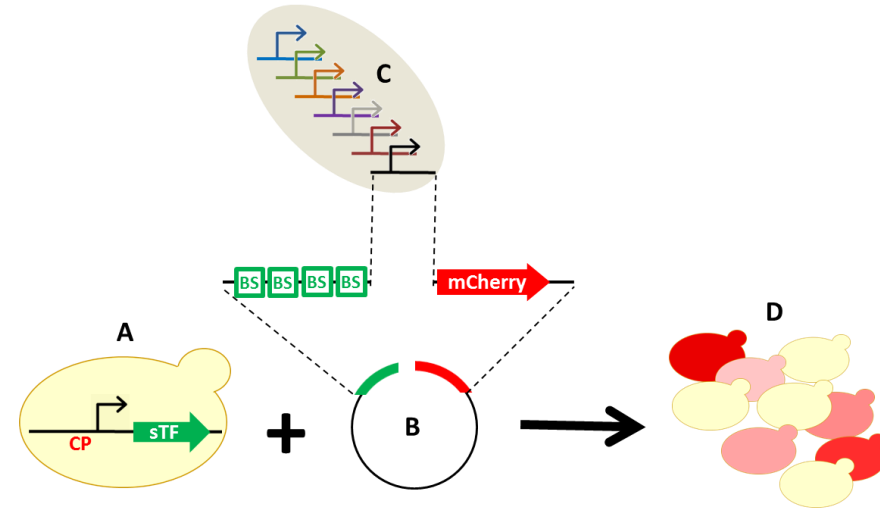

Universal core promoters for different fungi

- Core promoters of highly expressed genes from various organisms (as gBlocks).
- gBlocks assembled *in vivo* to a CEN-type plasmid in a yeast strain constitutively expressing LexA-based sTF.
- Strains analyzed for red fluorescence.
- A few new strong (universal) core promoters selected.

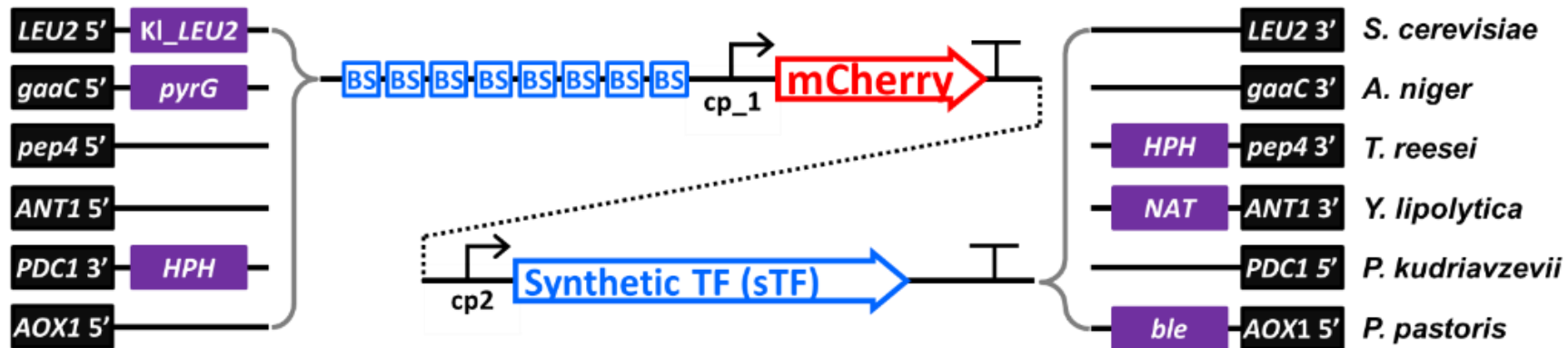
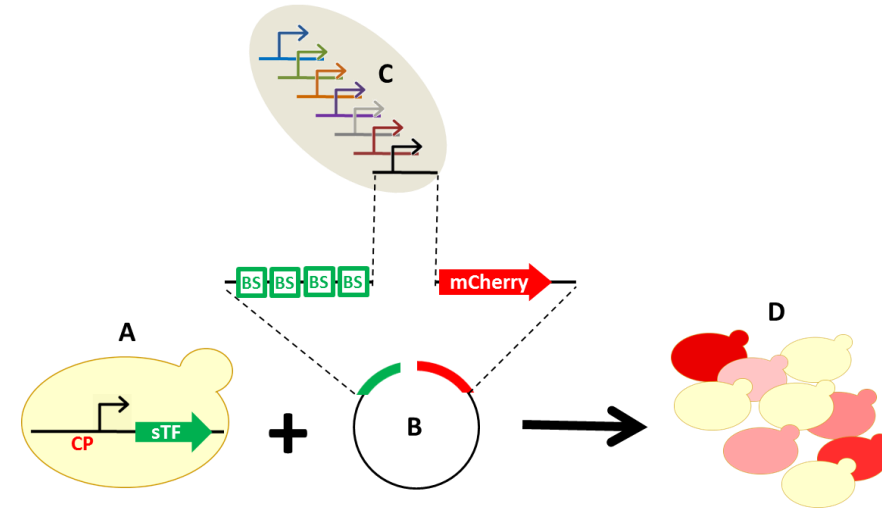

- The best performing core promoters (CP) from the screen used for the construction of transferable expression cassettes
- Two different CPs used for the sTF and mCherry expression

SES is functional in several fungal species

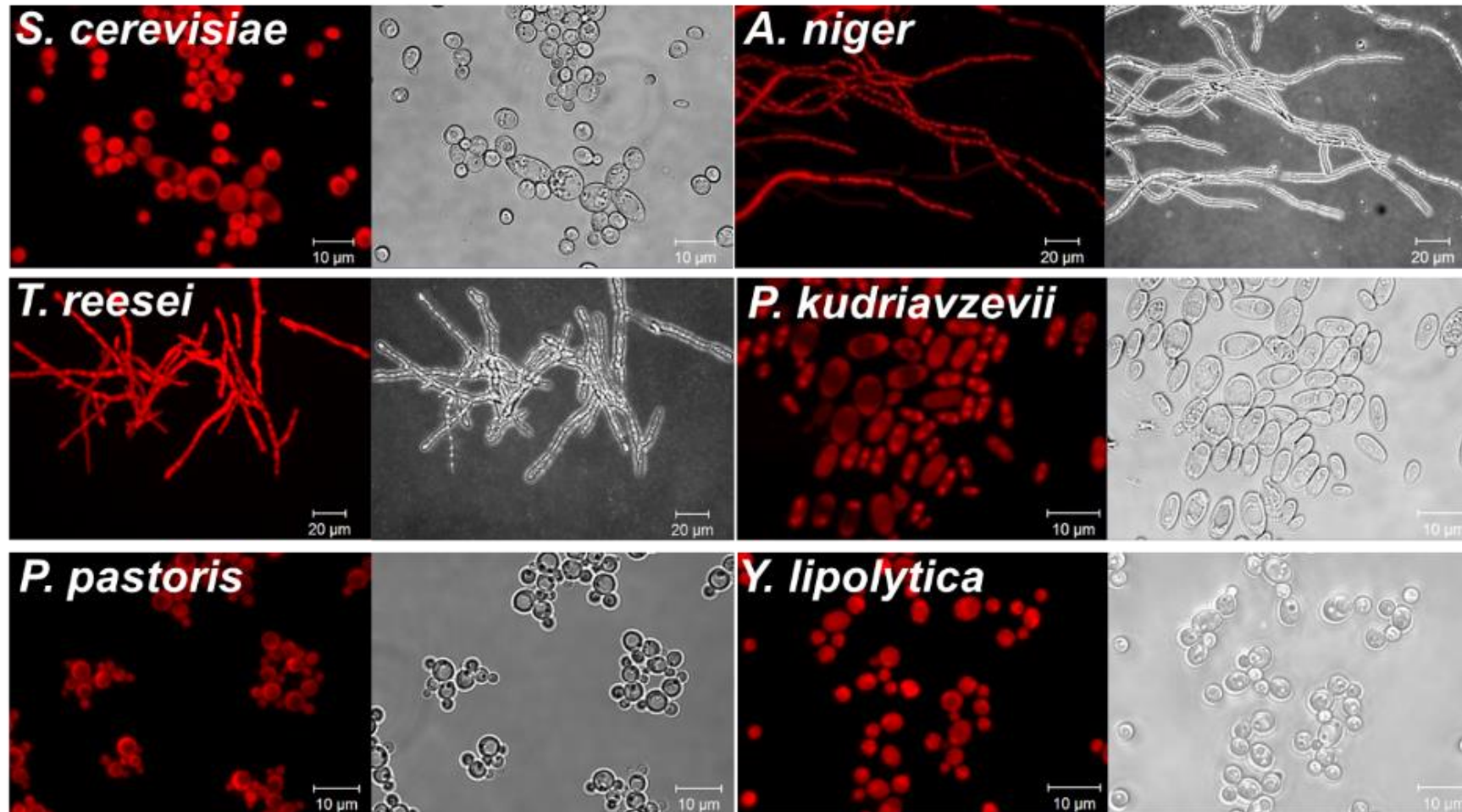

Fluorescence microscopy (mCherry)

Stable and homogenous expression in all cells/species

Tuning expression with SES promoters in *Pichia kurziavzevii*

Tuning mCherry expression in *P. kurziavzevii*

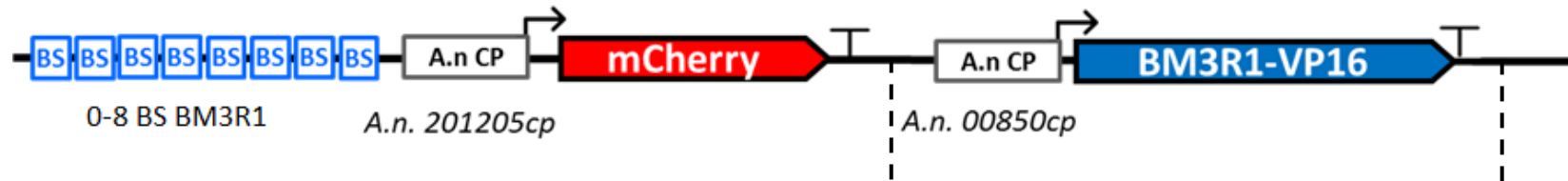
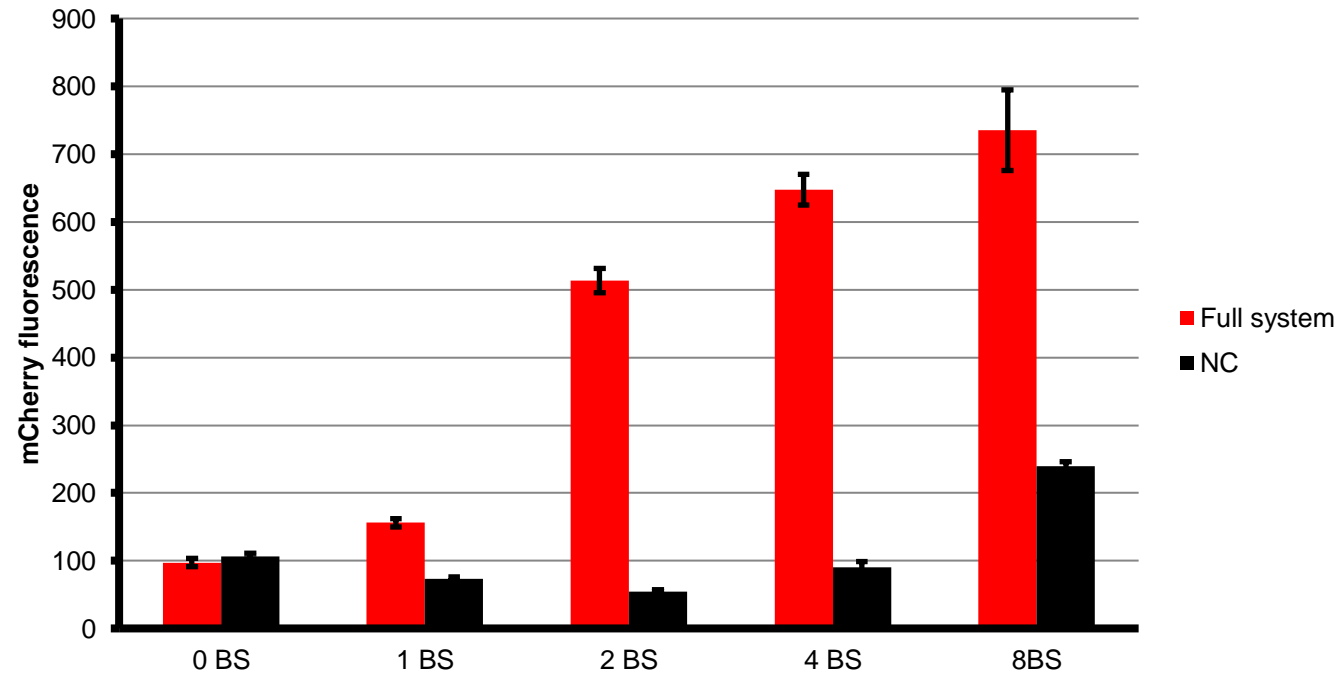

NC = without TF

Downregulation of the synthetic promoter with a synthetic repressor (sRep)

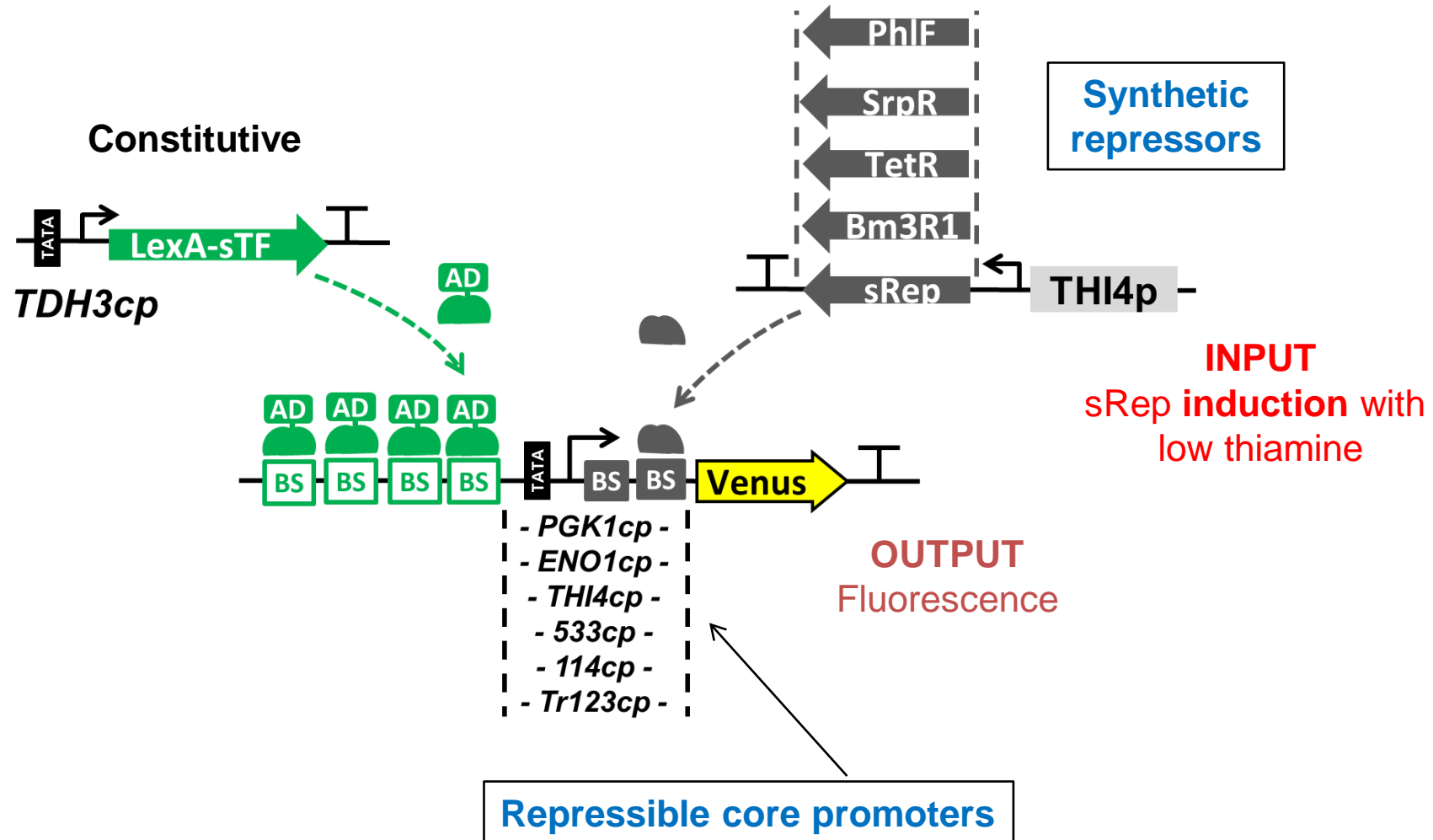

Downregulation of gene expression with synthetic repressor (sRep) in *S.cerevisiae*



Fluorescence

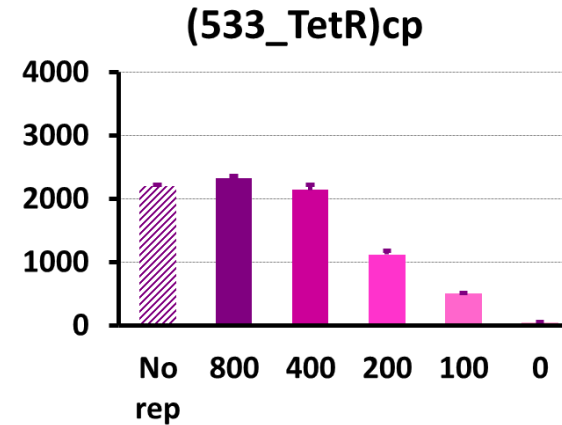
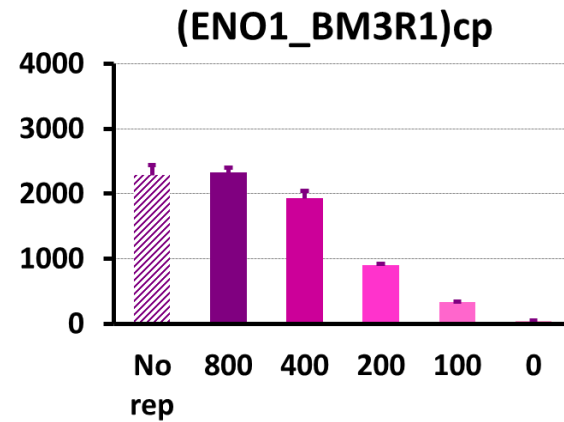

Transcription

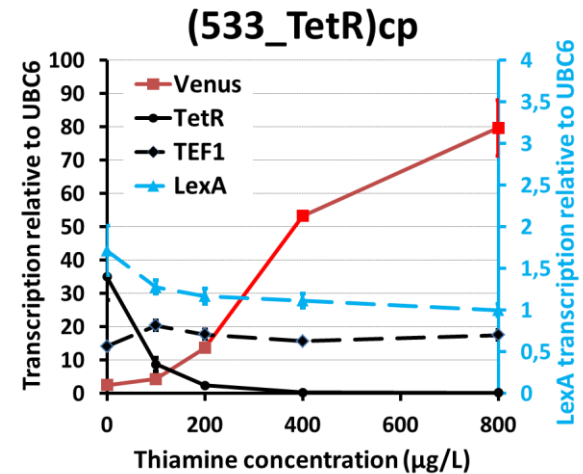
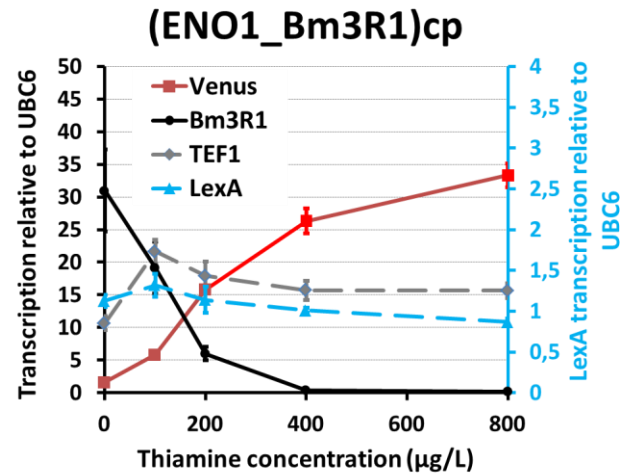

Repression of Venus expression with sRep



Bi-stable switch – Design

based on well-characterized orthogonal DNA parts

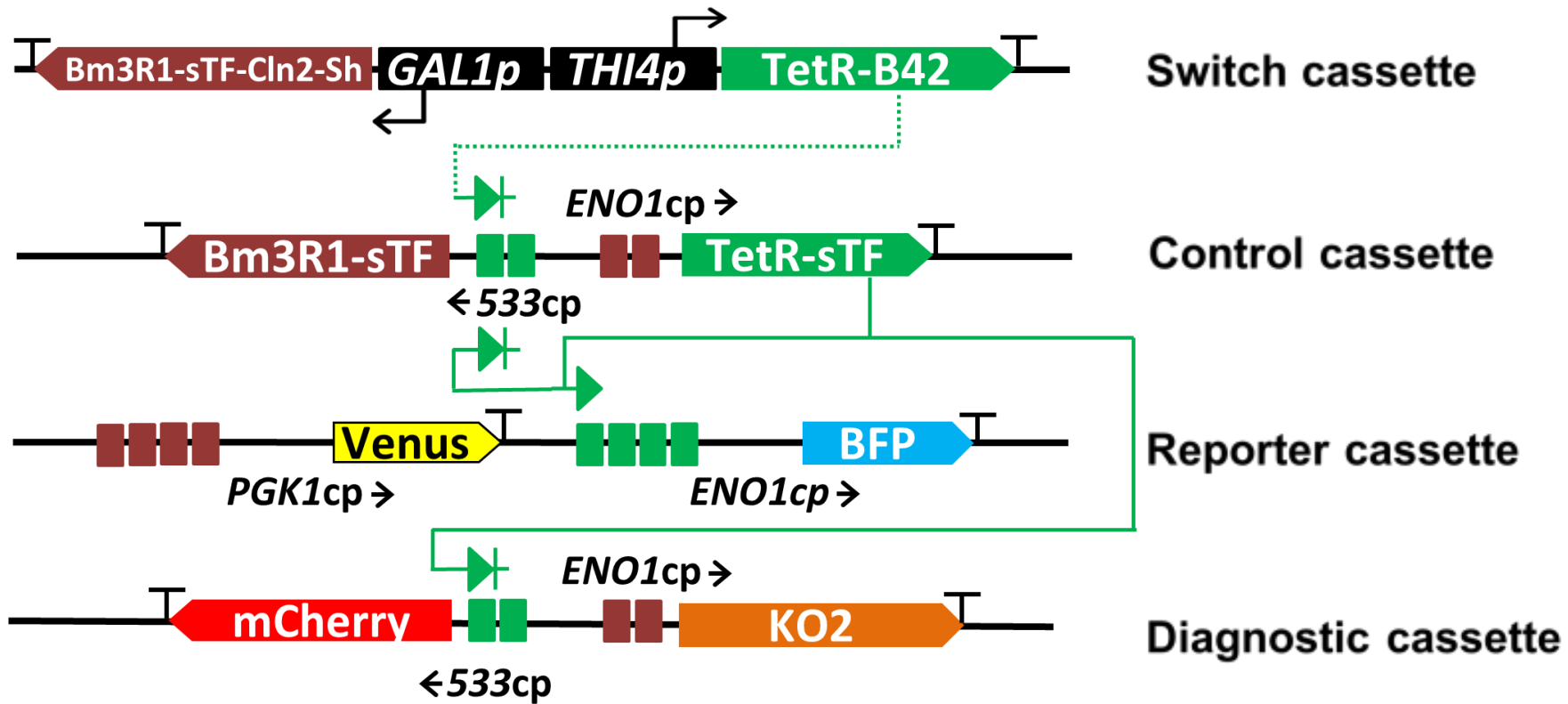

Bi-stable switch – Test

putting the system through series of tests to assess its robustness

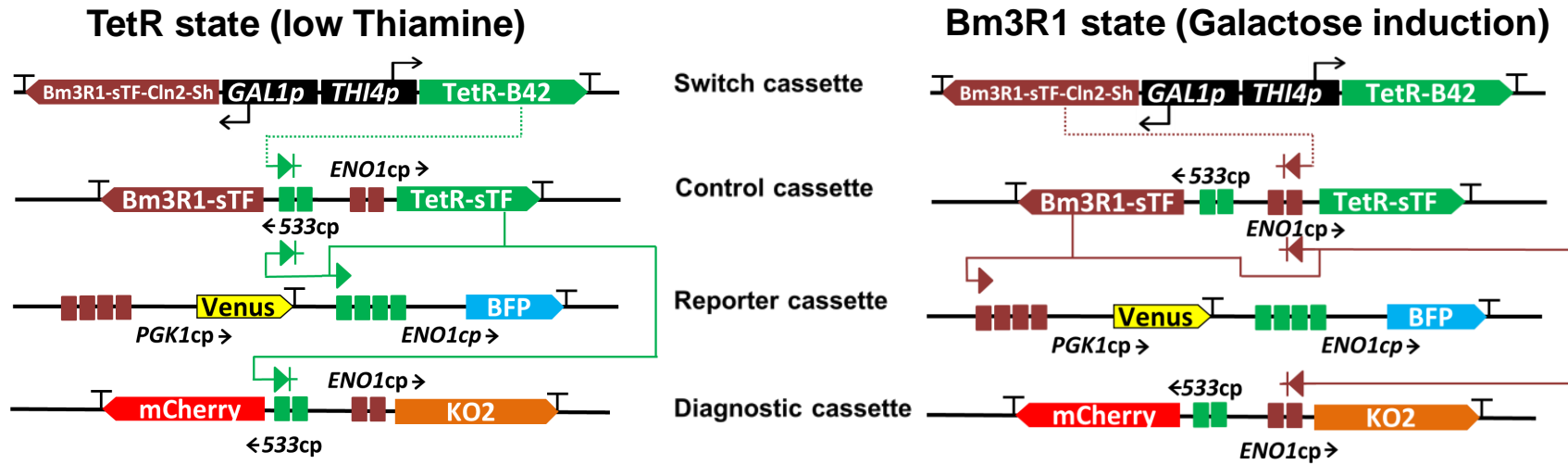

Bi-stable switch – Test

putting the system through series of tests to assess its robustness

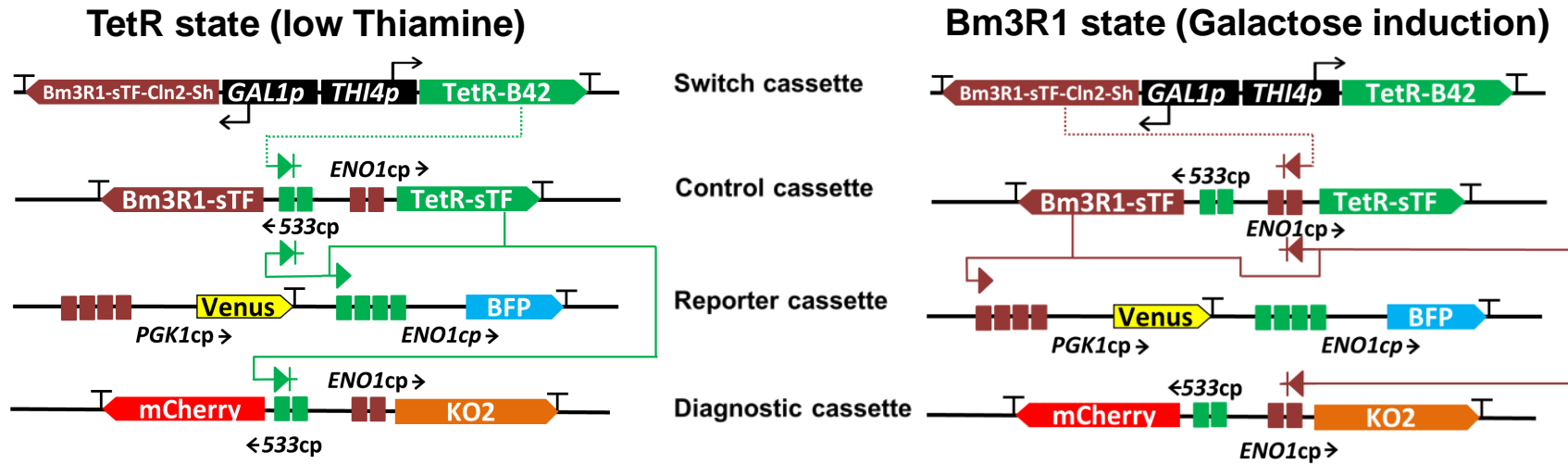

Repeated switches

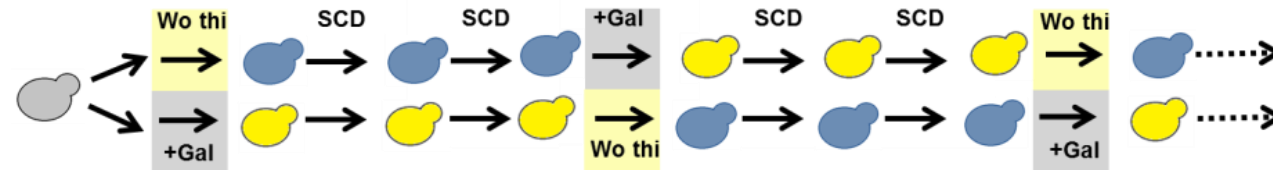

Memory

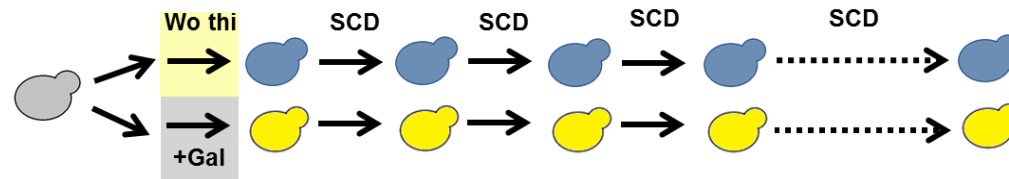

Bi-stable switch – Memory Test

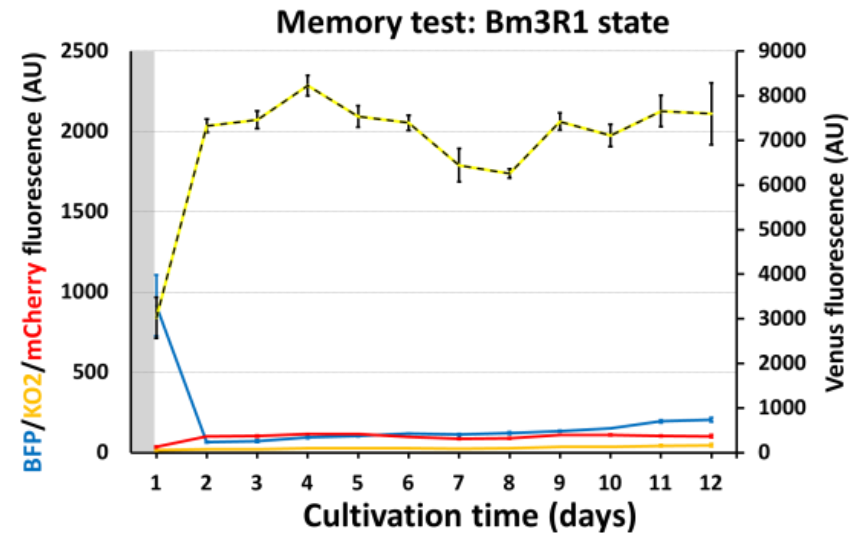
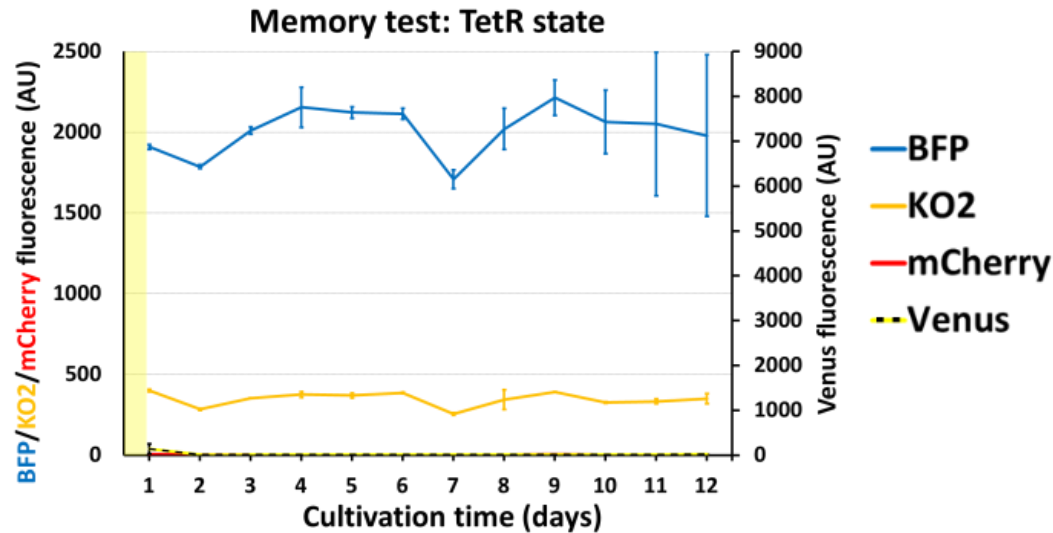
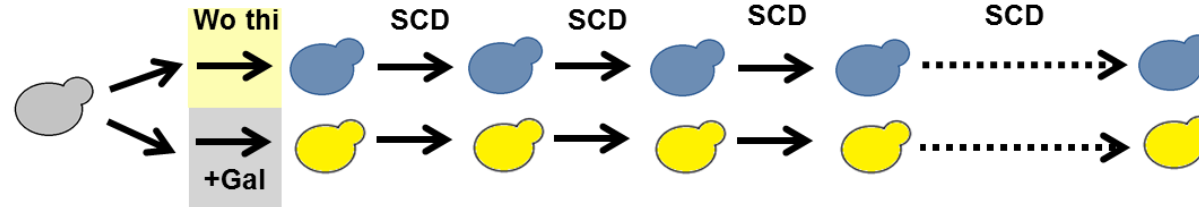

Wo thiamine

With galactose

SCD

Bi-stable circuit for metabolic pathway switching - Violacein pathway in *S.cerevisiae*

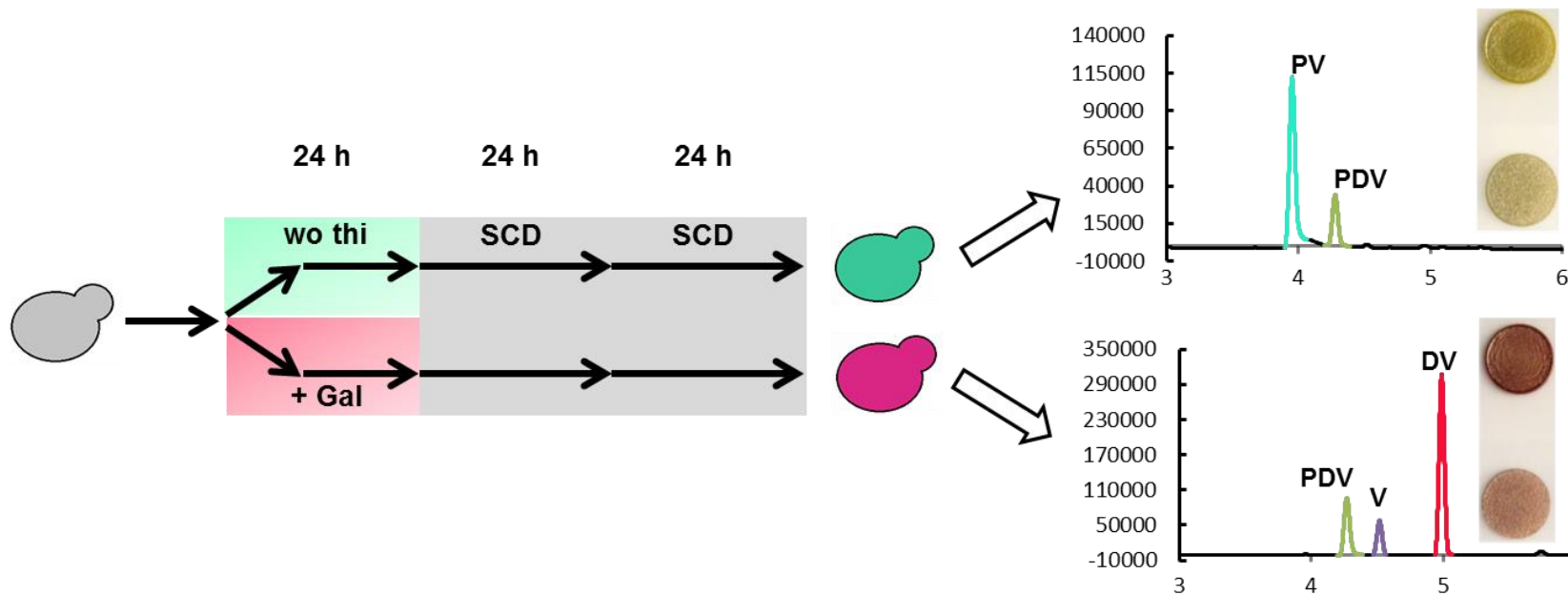
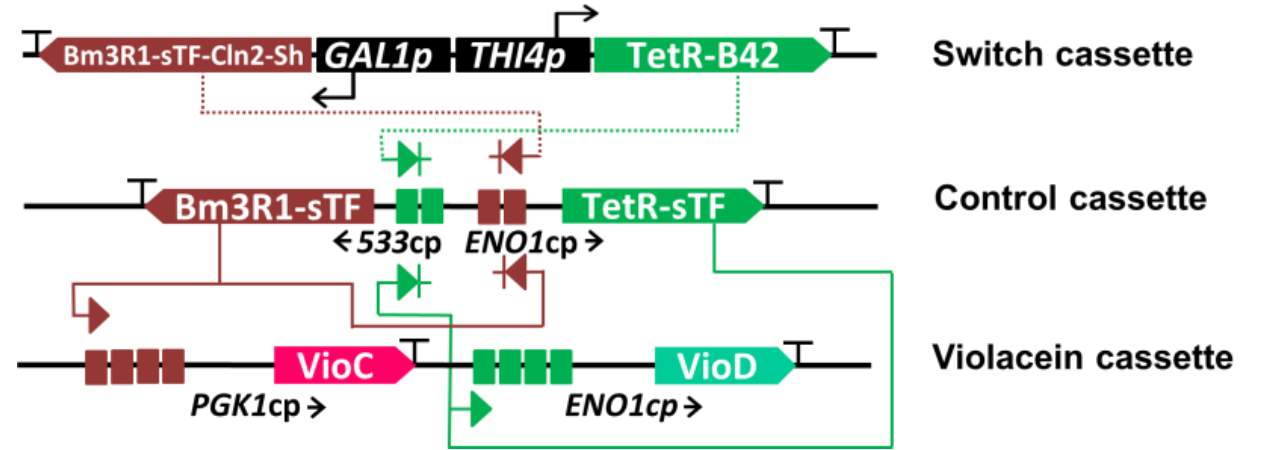
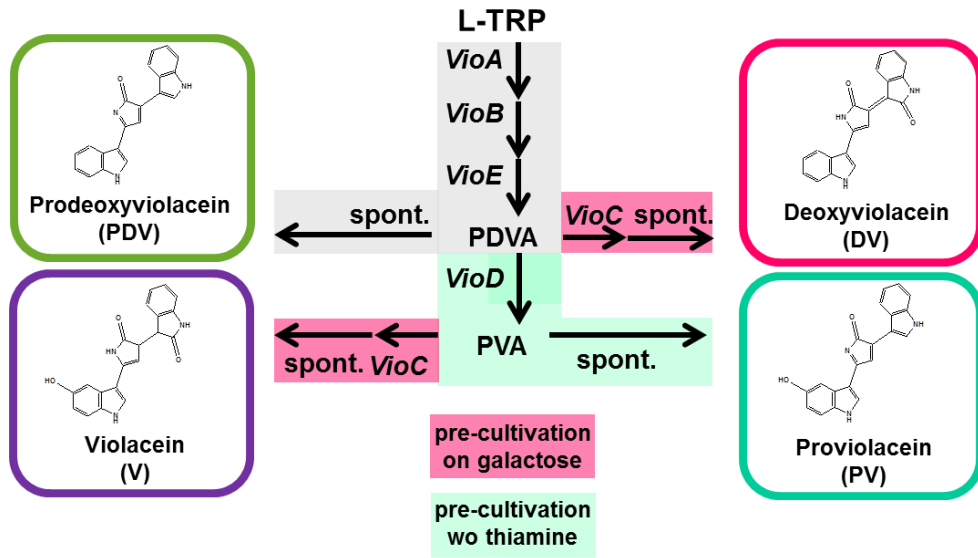

Using SES in protein production in *Trichoderma reesei*

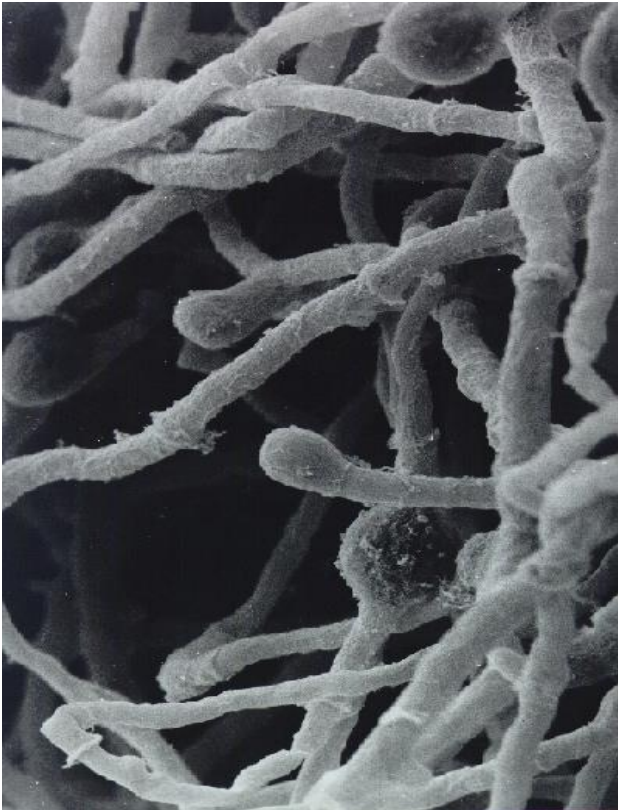

Production on glucose enables a more pure product

Dominik Mojzita, Mari Valkonen, Marika Vitikainen,
Chris Landowski et al, VTT

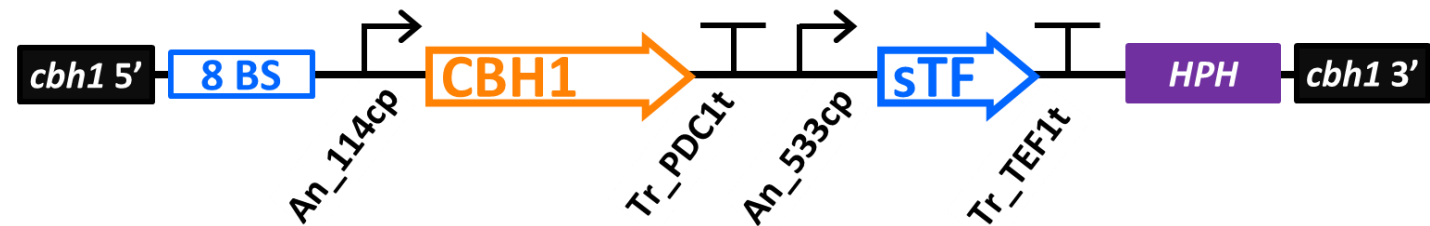

CBHI production in *Trichoderma reesei* with SES

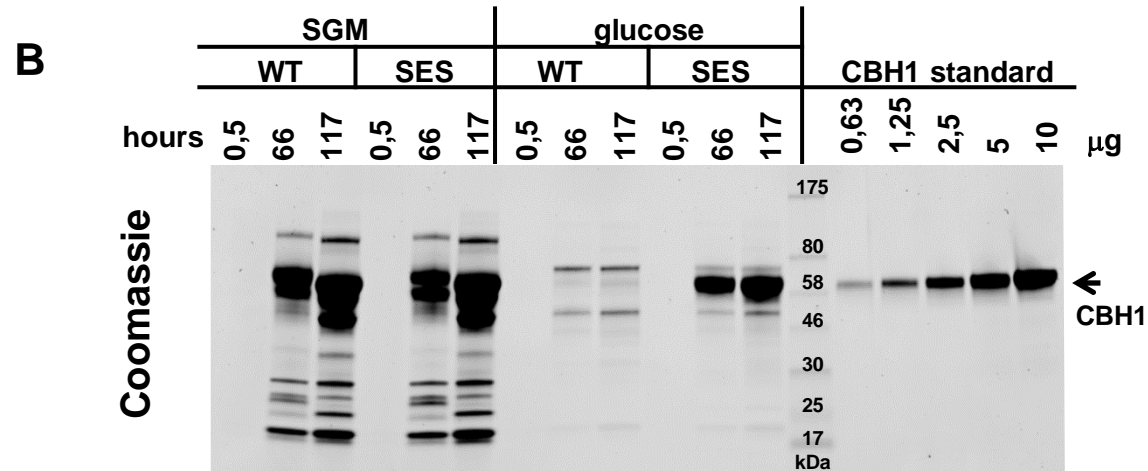
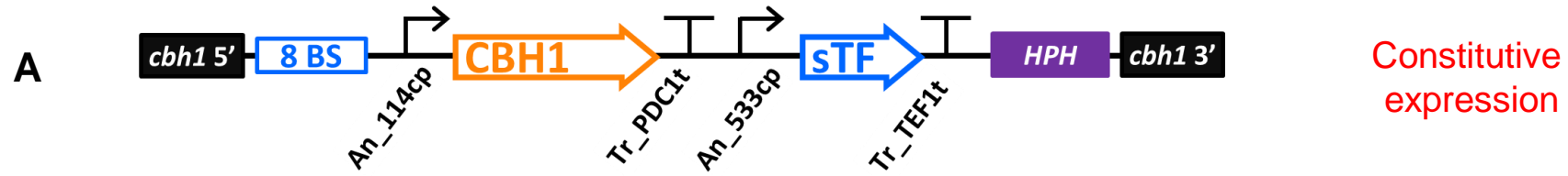

SGM	WT	0,5 h	0,6 g/L
		66 h	9,4 g/L
		117 h	17,8 g/L
SES	SES	0,5 h	0,6 g/L
		66 h	8,4 g/L
		117 h	17,6 g/L
Glucose	WT	0,5 h	<0,5 g/L
		66 h	0,9 g/L
		117 h	1,2 g/L
SES	SES	0,5 h	<0,5 g/L
		66 h	3,7 g/L
		117 h	5,9 g/L

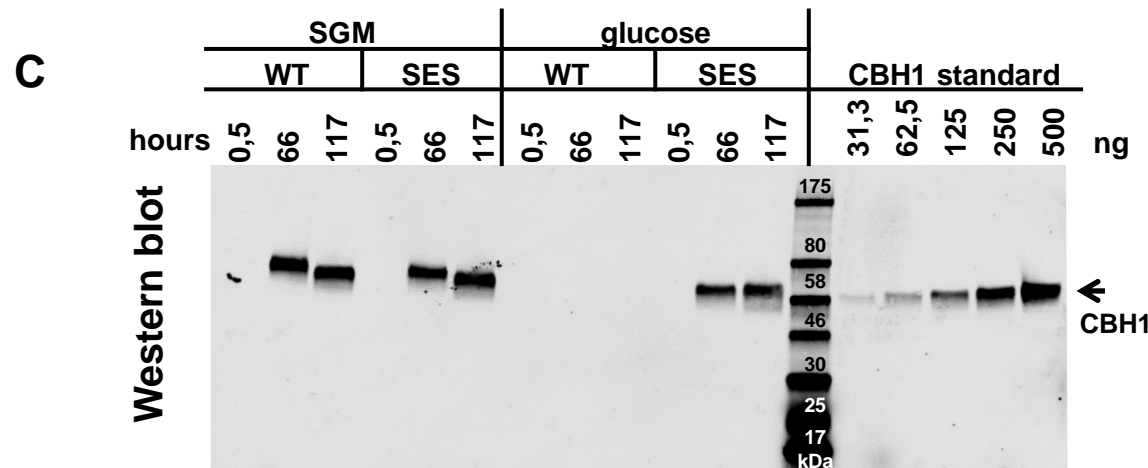

SGM	WT	0,5 h	<0,1 g/L
		66 h	4,9 g/L
		117 h	4,8 g/L
SES	SES	0,5 h	<0,1 g/L
		66 h	4,3 g/L
		117 h	5,4 g/L
Glucose	WT	0,5 h	<0,1 g/L
		66 h	<0,1 g/L
		117 h	<0,1 g/L
SES	SES	0,5 h	<0,1 g/L
		66 h	3,2 g/L
		117 h	4,1 g/L

Synthetic Biology for a Sustainable Bioeconomy – A Roadmap for Finland

Suomeksi

<https://www.vttresearch.com/sites/default/files/julkaisut/muut/2017/syntheticbiologyroadmap.pdf>

In English

https://www.vttresearch.com/sites/default/files/julkaisut/muut/2017/syntheticbiologyroadmap_eng.pdf



*English version
at MyCourses*

