

Lecture 4: Band theory

- Short introduction to quantum chemical materials modelling
- Band theory of solids
 - Molecules vs. solids
 - Band structures
 - Density of states (DOS) and atom-projected DOS
- Analysis of chemical bonding in solids

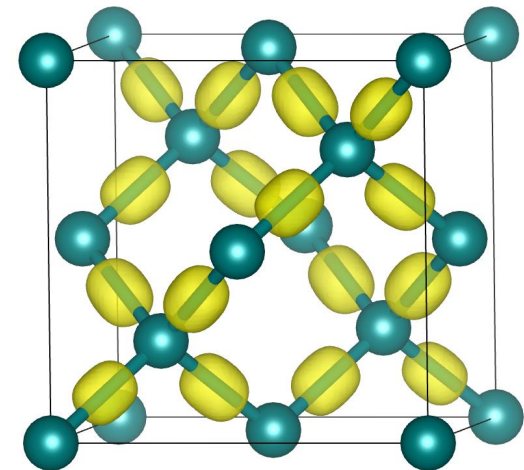
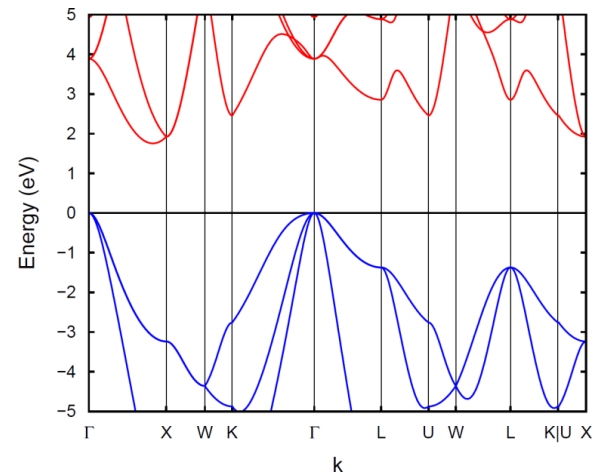

Quantum chemical materials modelling

- Quantum chemical methods allow to study chemical systems at the level of individual electrons.
 - Exact solutions are not feasible, approximate methods needed
 - The most common method: Density Functional Theory (DFT)
 - Powerful computational resources are needed
- Quantum chemical materials modelling techniques can be used to:
 1. Assist in the interpretation and explanation of experimental results
 2. Predict the existence and properties of new materials and molecules

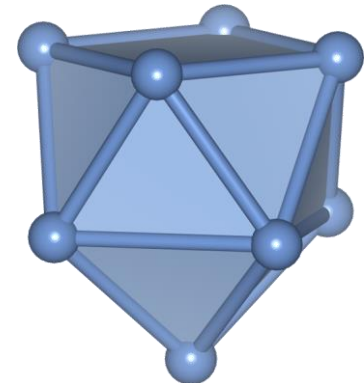
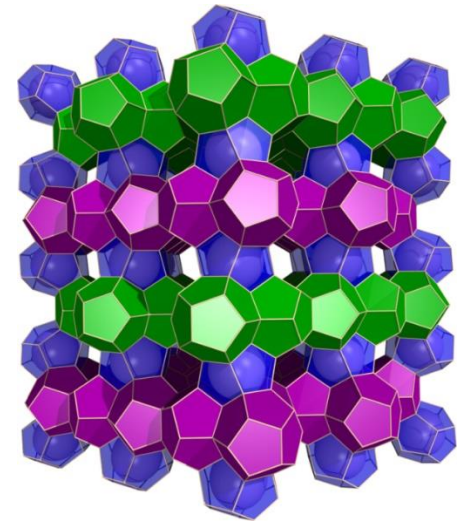

Solid state chemistry with Density Functional Theory (DFT)

- The vast majority of computational solid-state chemistry is currently carried out with Density Functional Theory (**DFT**)
 - Currently the most practical computational approach for solids
 - Typically, $10^1 - 10^2$ atoms in the unit cell, 10^3 and beyond with supercomputers
- **No system-dependent parametrization** required (*ab initio* / first principles)
 - Only the universal physical constants and the unit cell coordinates of the system are required to predict the properties of the system

**Atomic-level structure
(unit cell and atomic positions)**

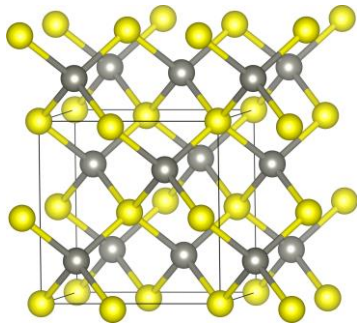
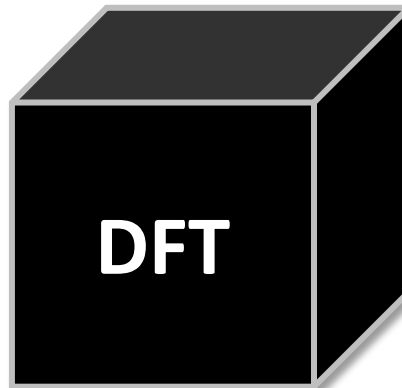

Figure: AJK



**Total energy of
the system**



**Optimized
geometry**



**Properties
(for example,
band structure)**

From molecular orbitals to electronic band structure

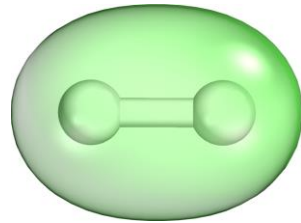

Molecular orbital theory (1)

Molecular orbital diagram of hydrogen molecule H_2

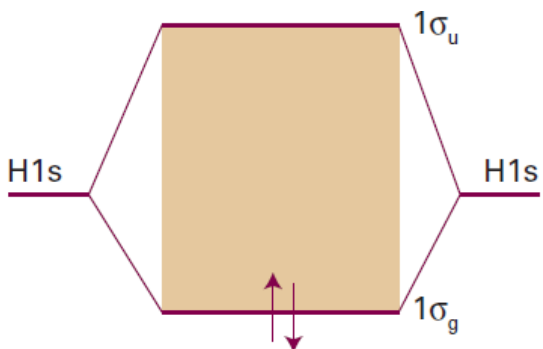

Oxygen molecule O_2

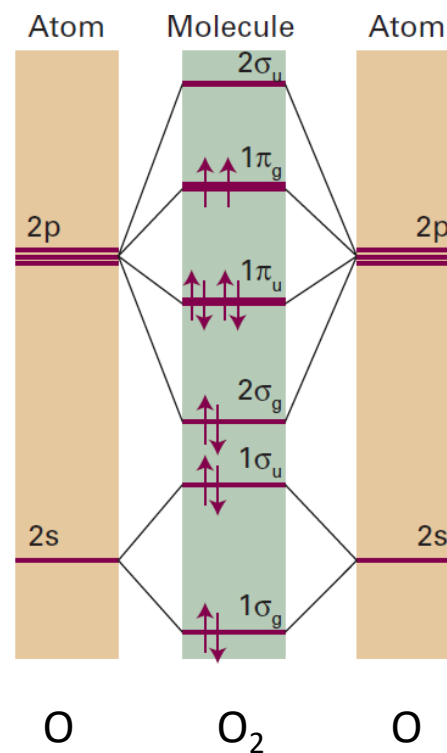

Molecular orbital theory (2)

Molecular orbitals (MO) are constructed from a Linear Combination of Atomic Orbitals (LCAO):

$$\text{MO } \phi_i = \sum_r c_{ri} \text{AO } \chi_r$$

The MO coefficients c_{ri} and the energies of the MOs can be calculated with **quantum chemical methods**.

For a longer introduction on MO theory, see for example Atkins' Physical Chemistry or [LibreTexts](#).

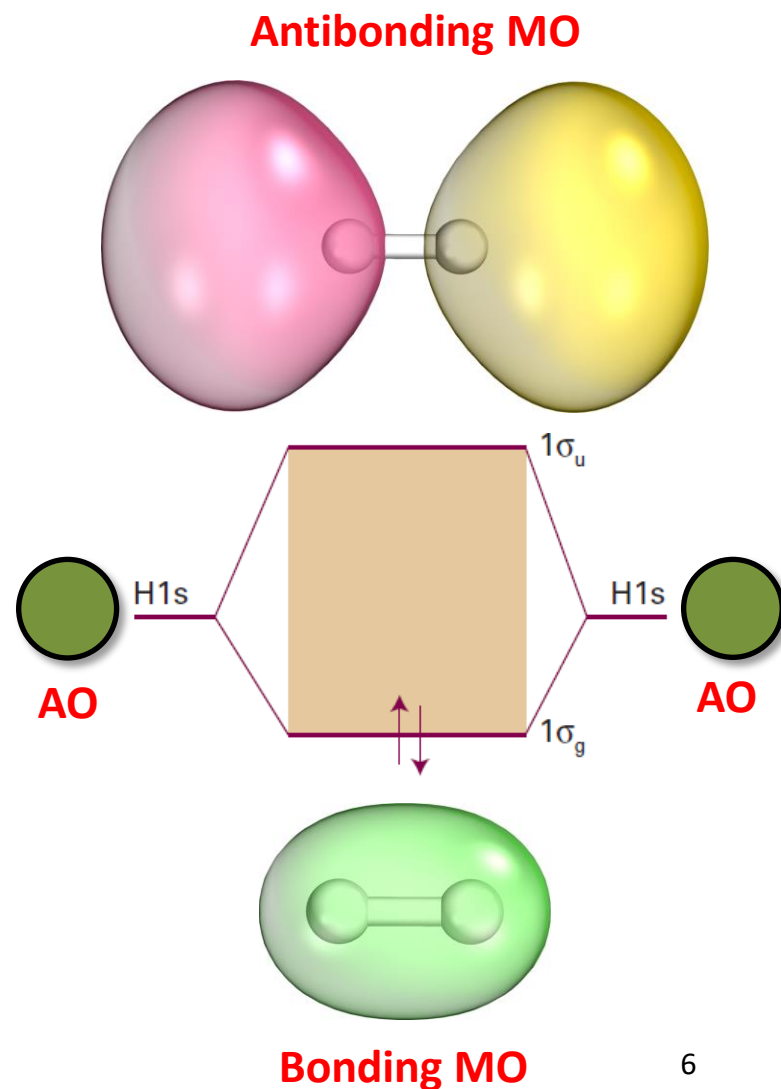

Bonding in Extended Structures

SOLIDS and SURFACES

*A Chemist's View of Bonding
in Extended Structures*

by
Roald Hoffmann



- Short introduction to band structures using two 1D model structures (infinite chains):
 1. Equally spaced H atoms
 2. Stack of square planar PtH_4^{2-}

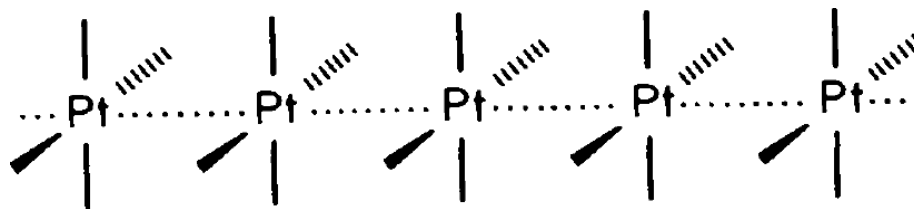
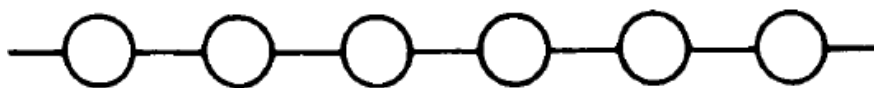
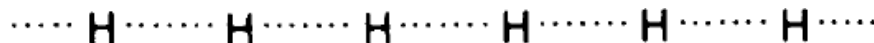

From H₂ to a large ring of H atoms

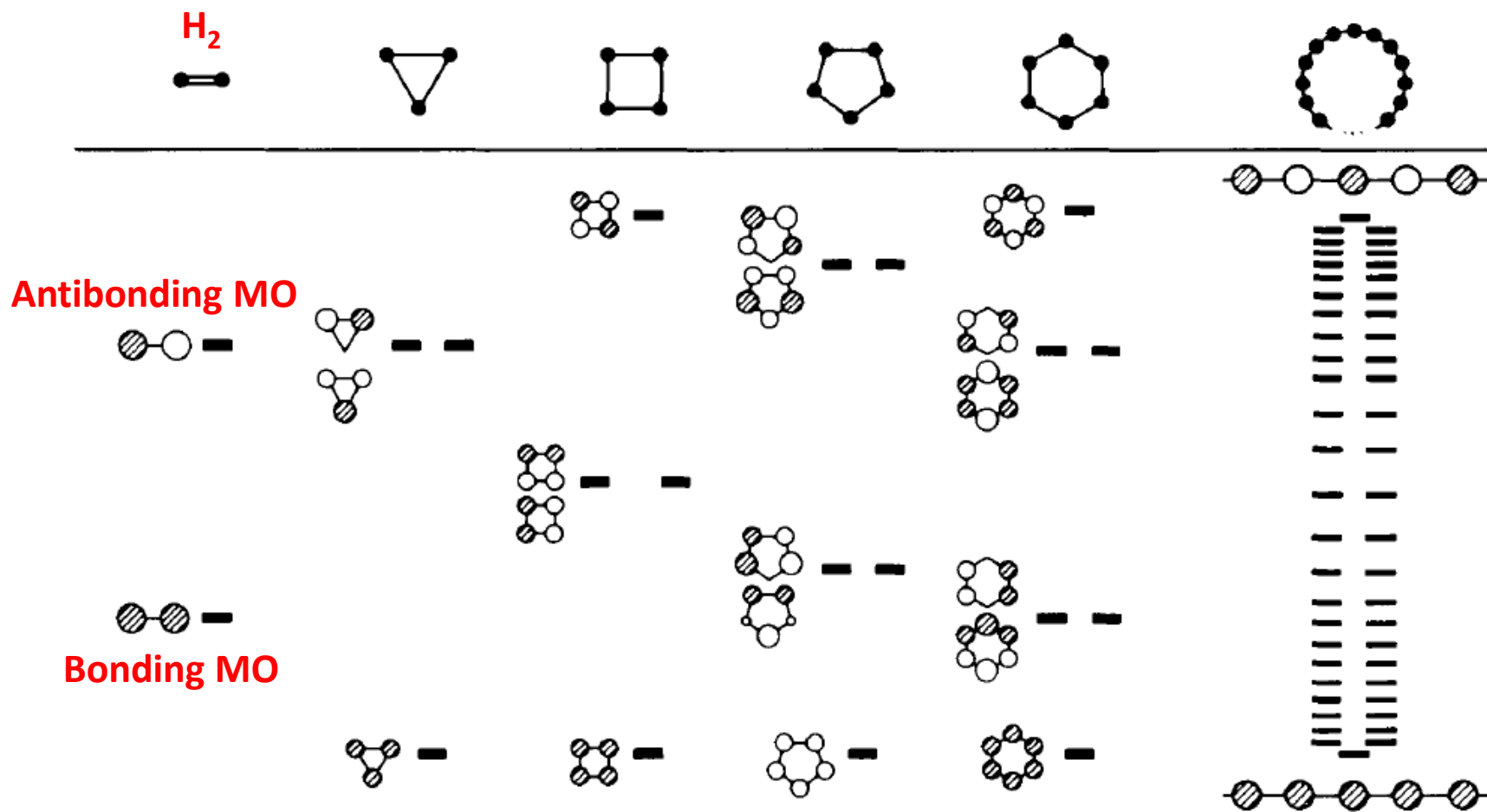

Bloch functions for the H atom chain

Use translational symmetry and write the wave function ψ of the H atom chain as a linear combination of the H(1s) orbitals χ_n

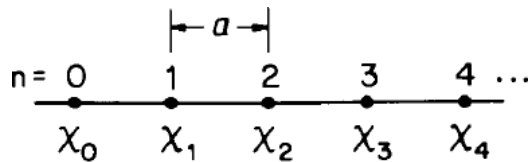

$$\psi_k = \sum_n e^{ikna} \chi_n$$

Bloch function

Phase factor (translation)

The resulting wave functions for two k :

$$\begin{aligned} k=0 \quad \psi_0 &= \sum_n e^{i0} \chi_n = \sum_n \chi_n \\ &= \chi_0 + \chi_1 + \chi_2 + \chi_3 + \dots \end{aligned}$$

$$\begin{aligned} k=\frac{\pi}{a} \quad \psi_{\frac{\pi}{a}} &= \sum_n e^{i\pi n} \chi_n = \sum_n (-1)^n \chi_n \\ &= \chi_0 - \chi_1 + \chi_2 - \chi_3 + \dots \end{aligned}$$

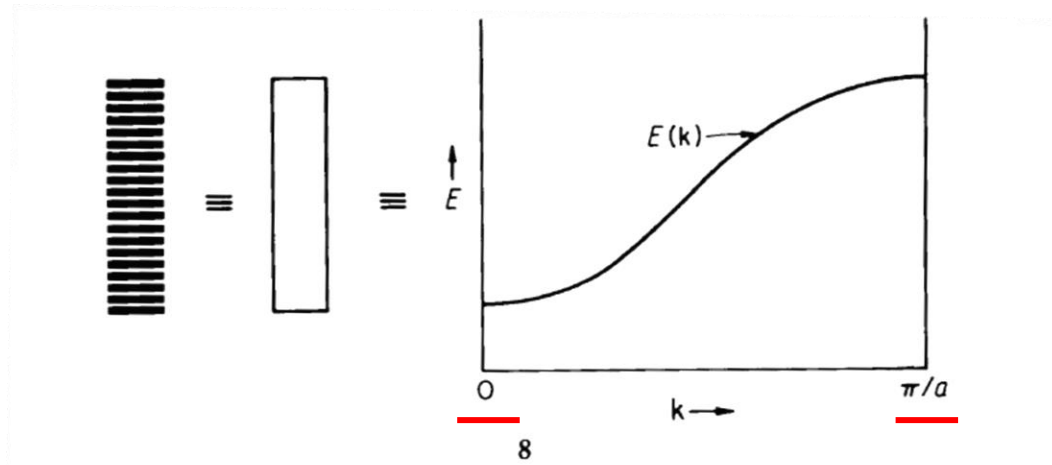

Graphs of $E(k)$ vs. k are called band structures. You can be sure that they can be much more complicated than this simple one. However, no matter how complicated they are, they can still be understood.

Band width or *dispersion*

Wave functions for two k :

$$k = 0 \quad \psi_0 = \sum_n e^{i0n} \chi_n = \sum_n \chi_n$$

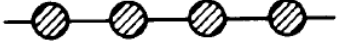
$$= \chi_0 + \chi_1 + \chi_2 + \chi_3 + \dots$$

$$k = \frac{\pi}{a} \quad \psi_{\frac{\pi}{a}} = \sum_n e^{i\pi n} \chi_n = \sum_n (-1)^n \chi_n$$

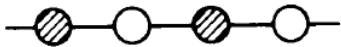
$$= \chi_0 - \chi_1 + \chi_2 - \chi_3 + \dots$$

- Let's vary the lattice parameter a
- The band width is set by **inter- unit cell** overlap. Band width = ***dispersion***
- **Large band width** means that the atoms in a unit cell are interacting with the atoms in neighboring unit cells
- **Small band width** (flat band) means that the atoms in a unit cell are not interacting with the neighboring unit cells

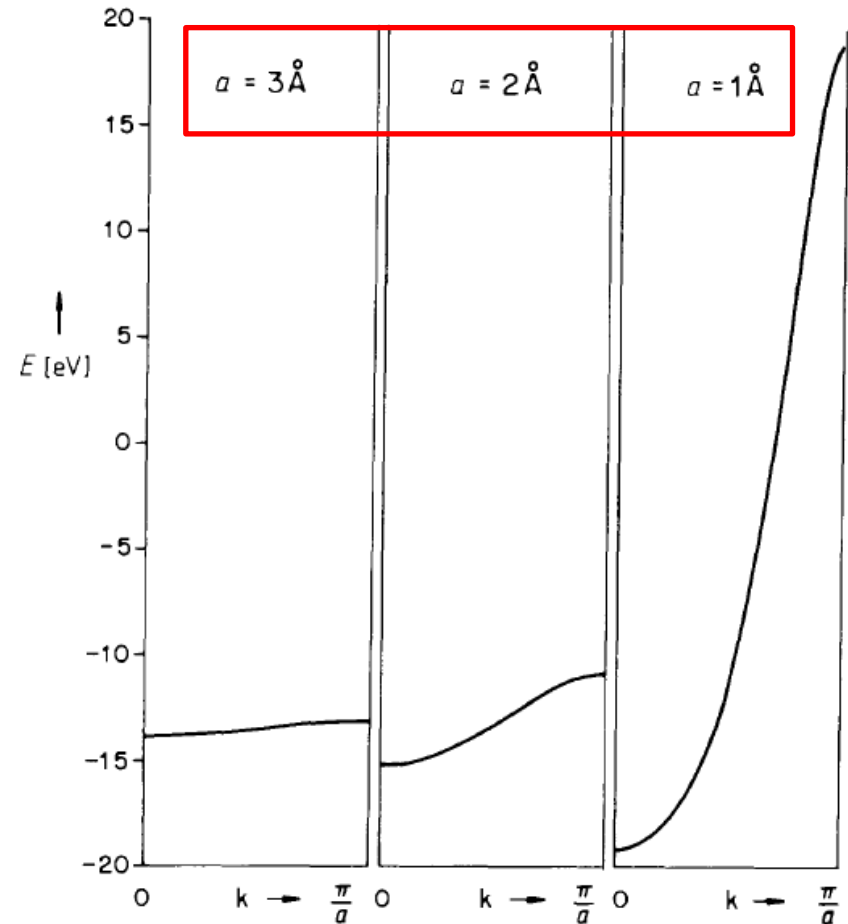
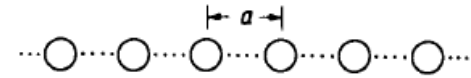

The band structure of a chain of hydrogen atoms spaced 3, 2, and 1 Å apart.

Stack of square planar PtH_4^{2-}

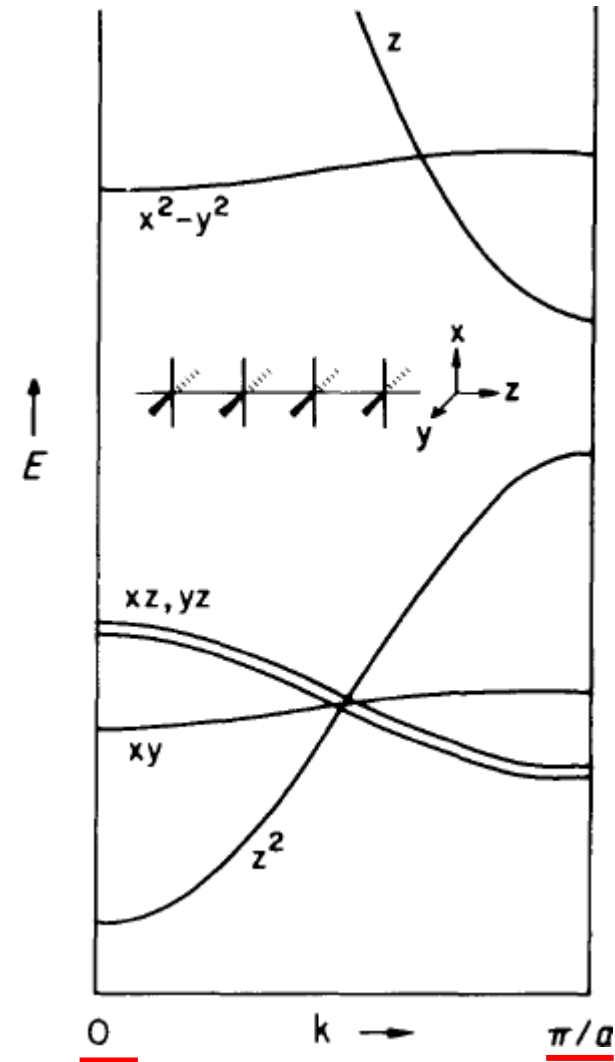
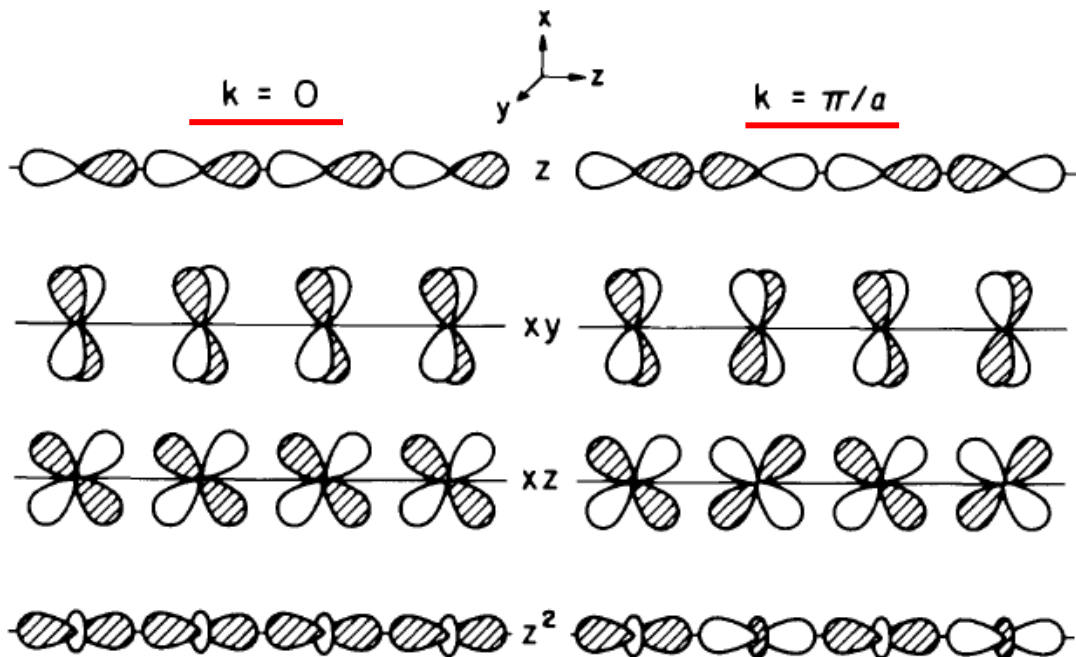
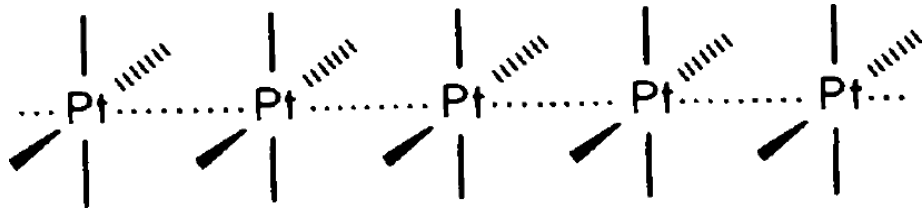

Band structures in real solids

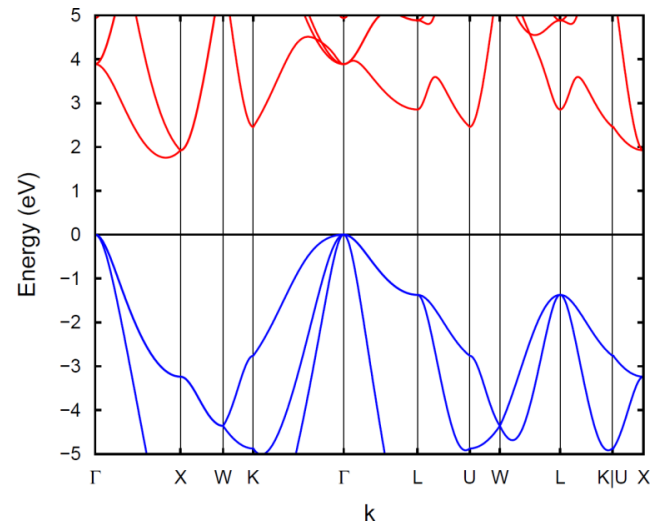

Band structures in real solids

- In the 1D chains discussed above, it was enough to consider the band dispersion curves $E(k)$ for one line ($0 \rightarrow \pi/a$)
- In 3D solids, k is called the **wave vector** and has three components (k_x, k_y, k_z)
- $E(k)$ needs to be considered for several lines within the first **Brillouin zone**
 - Primitive cell in reciprocal space, uniquely defined for all Bravais lattices
- Where do the band energies come from?
 - Quantum chemical calculations (usually **density functional theory, DFT**)
 - They can be measured also experimentally with e.g. electron cyclotron resonance (not that easily, though)

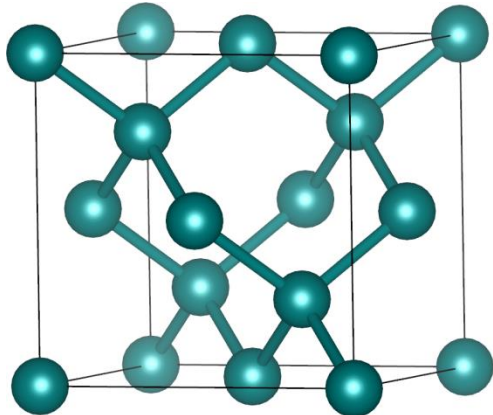

Silicon ($Fd-3m$)

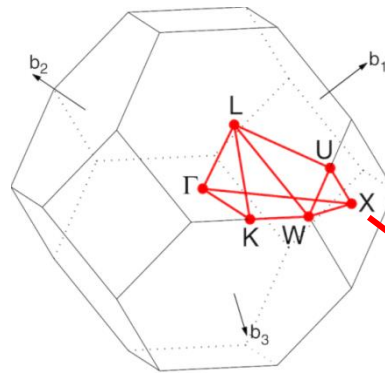

Brillouin zone of an **FCC lattice** (Si)

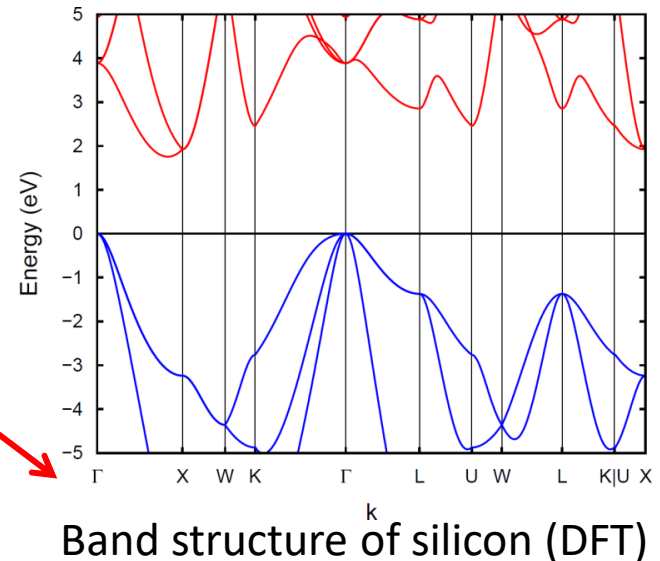

Band structure of silicon (DFT)

Band structure and band gap

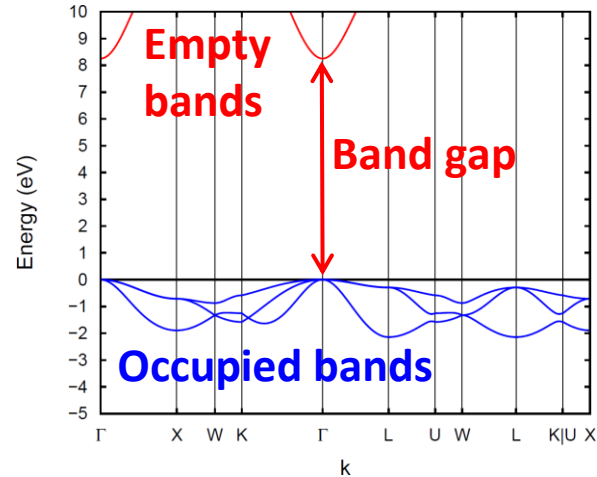

NaCl: **insulator**, large energy gap between occupied and non-occupied bands
 Band gap: 8.75 eV (DFT)

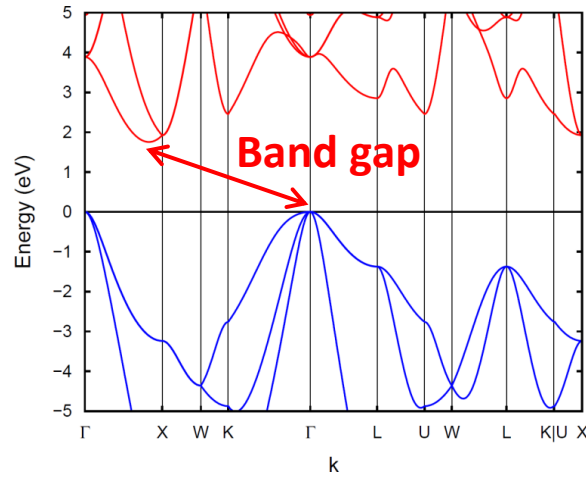

Silicon: **semiconductor**, energy gap between occupied and non-occupied bands. **Indirect** band gap (here ~2 eV in the plot, experimentally ~1.1 eV at room temperature)

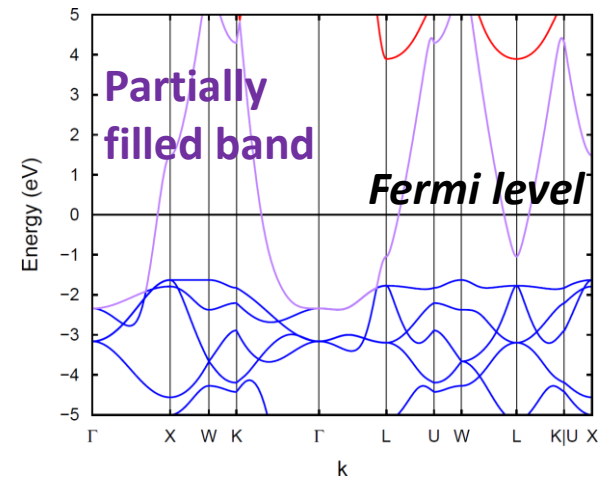

Copper: **metal**, partially filled bands
 No band gap

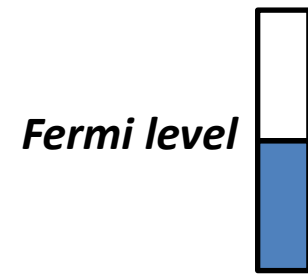
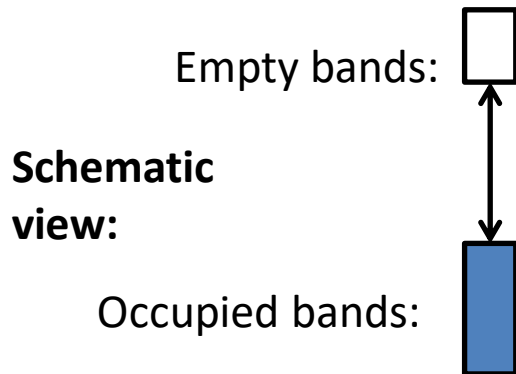

Electronic Density of States

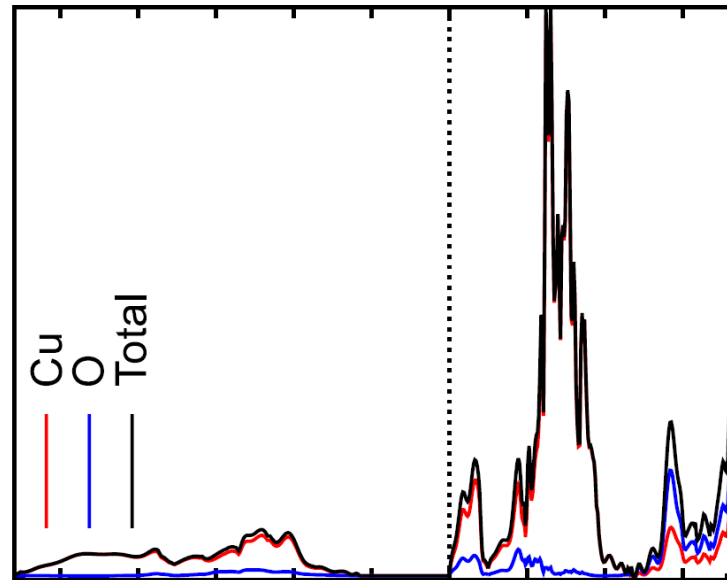

Density of states

- The band structures are a powerful description of the electronic structure of a solid, but often the "spaghetti diagram" does not immediately tell much more than just the nature of the band gap
- A more "chemical" look at the band structure can be obtained with Density of States diagrams (DOS)
- $DOS(E)dE =$ number of levels between E and $E + dE$
- $DOS(E)$ is proportional to the inverse of the slope of $E(k)$ vs. k
 - The flatter the band, the greater the density of states at that energy
 - "Molecular bands" lead into very sharp features in $DOS(E)$

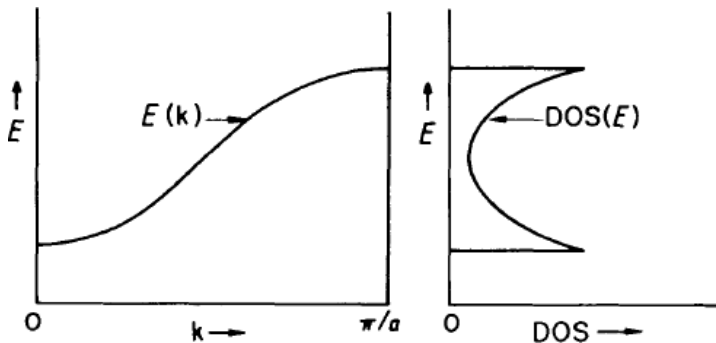

$$k = 0 \quad \psi_0 = \sum_n e^{i0} \chi_n = \sum_n \chi_n$$

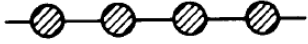
$$= \chi_0 + \chi_1 + \chi_2 + \chi_3 + \dots$$

$$k = \frac{\pi}{a} \quad \psi_{\frac{\pi}{a}} = \sum_n e^{i\pi n} \chi_n = \sum_n (-1)^n \chi_n$$

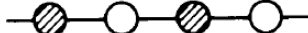
$$= \chi_0 - \chi_1 + \chi_2 - \chi_3 + \dots$$

Density of states for PtH_4^{2-} stack

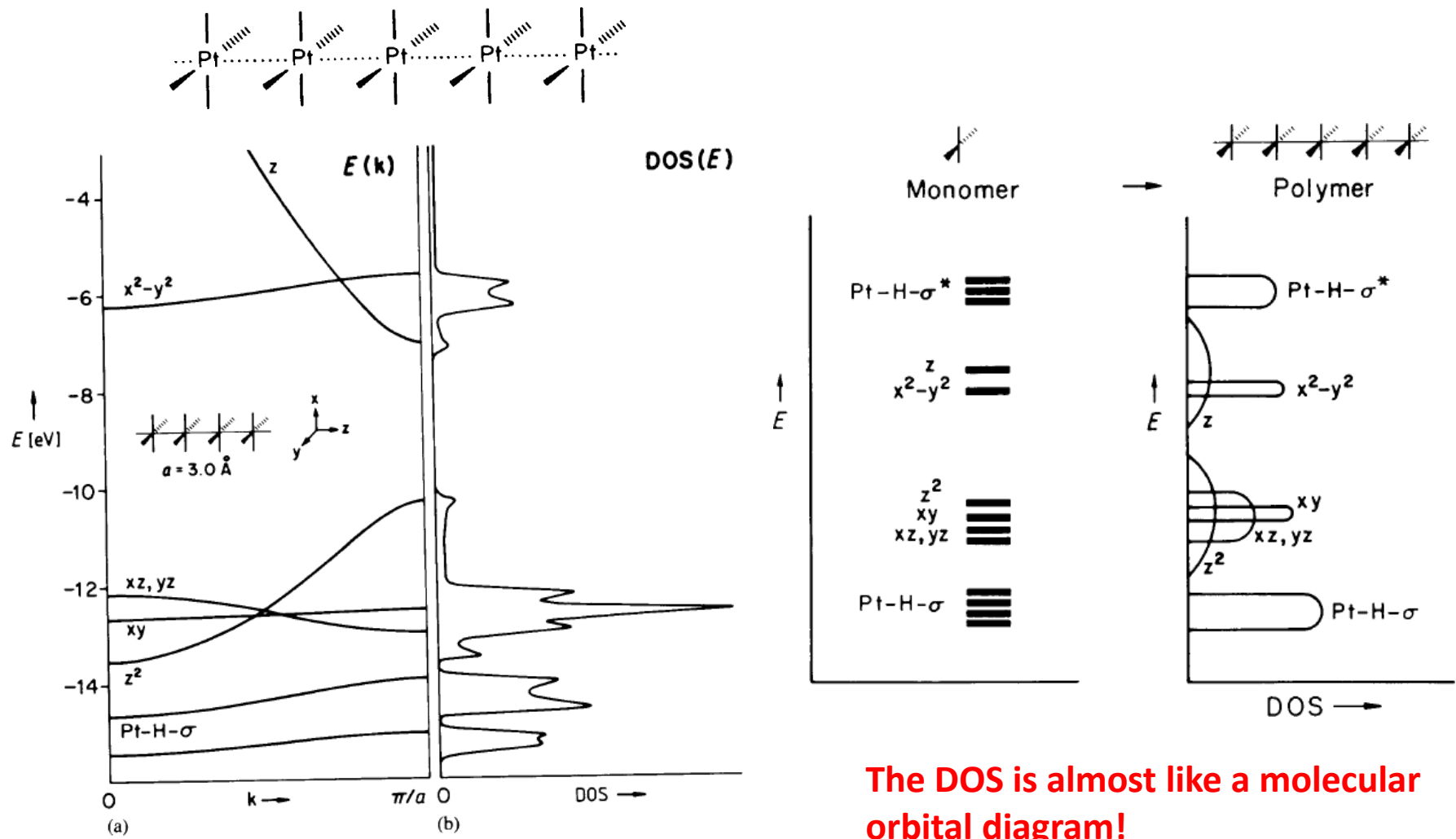

The DOS is almost like a molecular orbital diagram!

Figure 8 Band structure and density of states for an eclipsed PtH_4^{2-} stack. The DOS curves are broadened so that the two-peaked shape of the xy peak in the DOS is not resolved.

Atom-projected DOS

- It is also possible to create atom-projected DOS plots that tell how different atoms are contributing to the band structure at certain energies

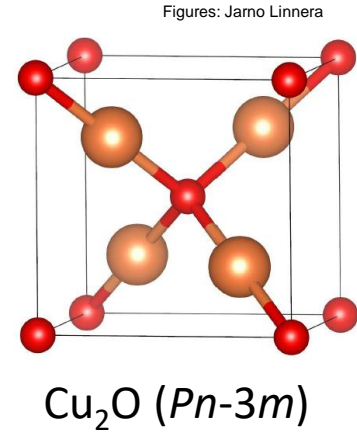
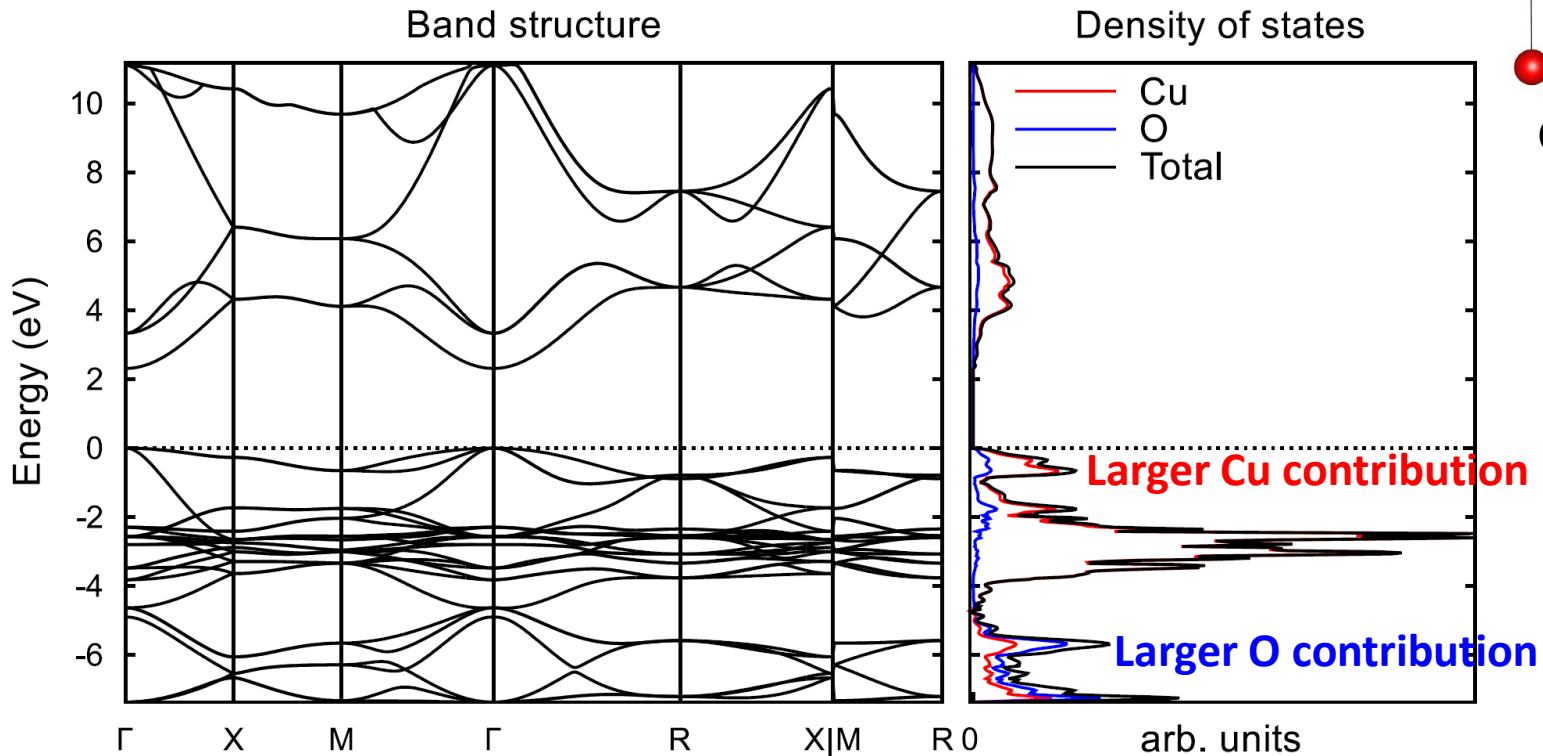

The band structure and atom-projected DOS of Cu_2O

Band structures are reciprocal-space descriptions of the electronic structure
What about real-space views into chemical bonding?

Real-space representations of chemical bonding in solids

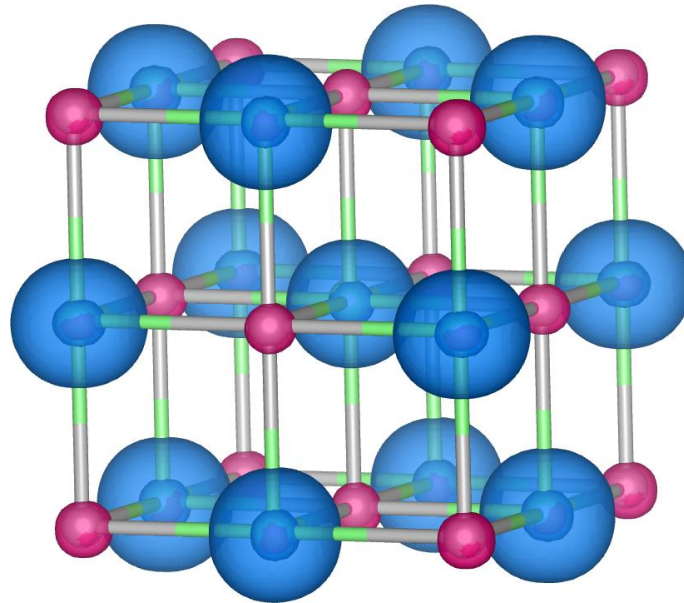

Electron density (ρ)

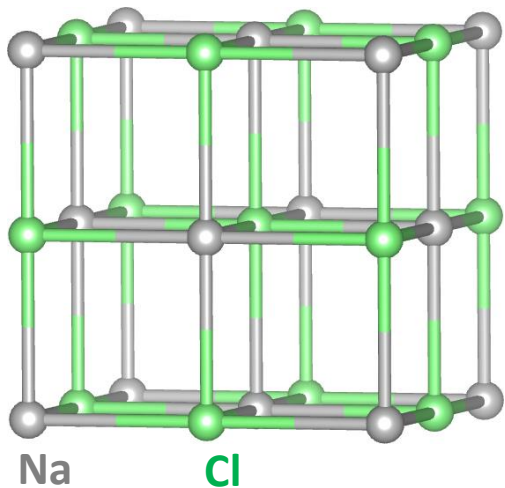

NaCl ($Fm-3m$)

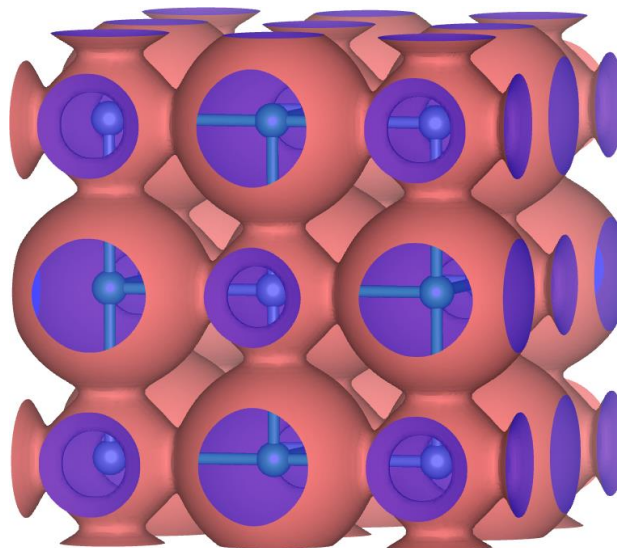

Total electron density
(isovalue 0.008 a.u.).

Not much insight into
bonding

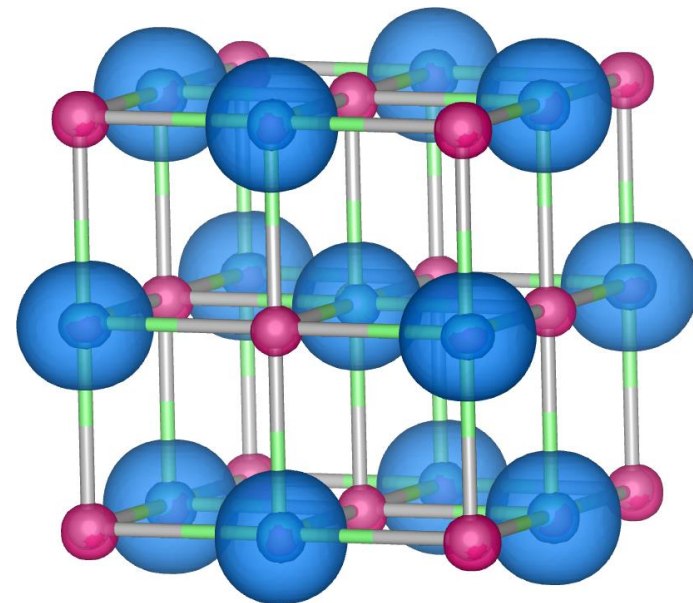

Electron density difference plot
 $\rho(\text{NaCl}) - \rho(\text{non-interacting atoms})$
(isovalue 0.008 a.u.).

ρ has increased in the blue
region and decreased in the red
region compared to a lattice of
isolated Na and Cl atoms. NaCl is
highly ionic.

Selected Crystalline Orbitals (CO) of silicon

HOCO

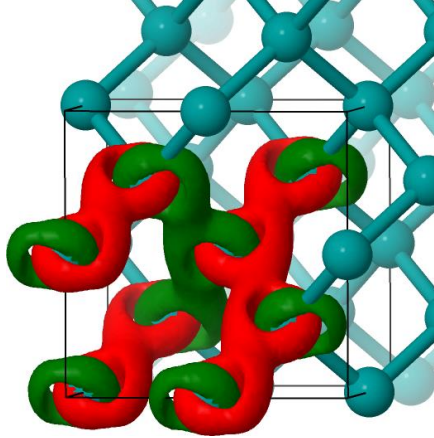

HOCO-1

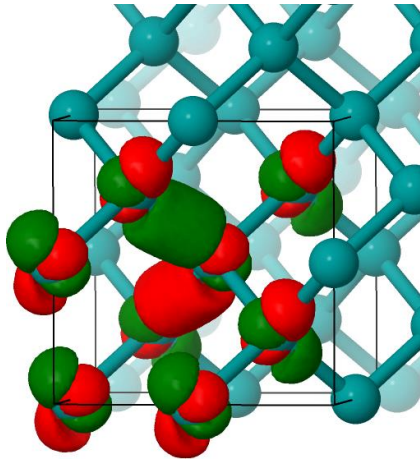

HOCO-2

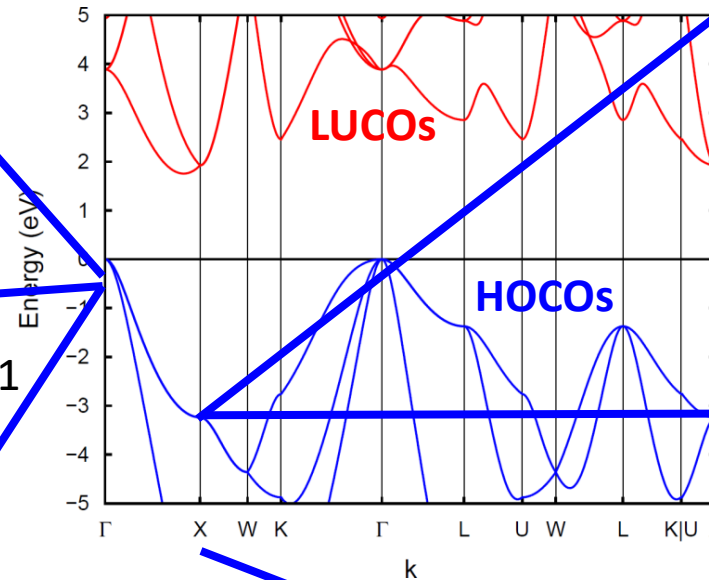
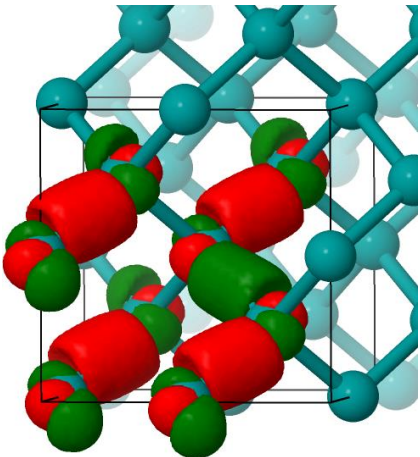

Crystalline orbitals are rather delocalized (by definition).
Orbital plot isovalues 0.012 a.u.

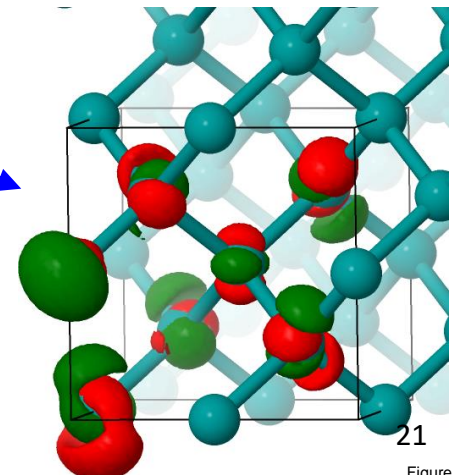
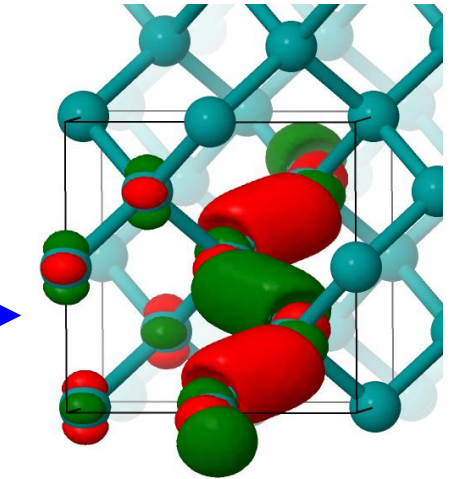
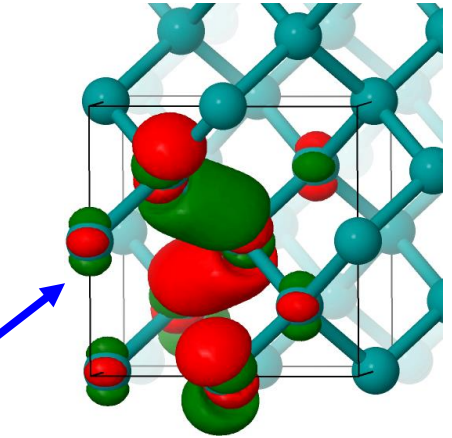

Band-projected electron densities

- Compared to crystalline orbitals, band-projected electron densities often offer a better view into the bonding

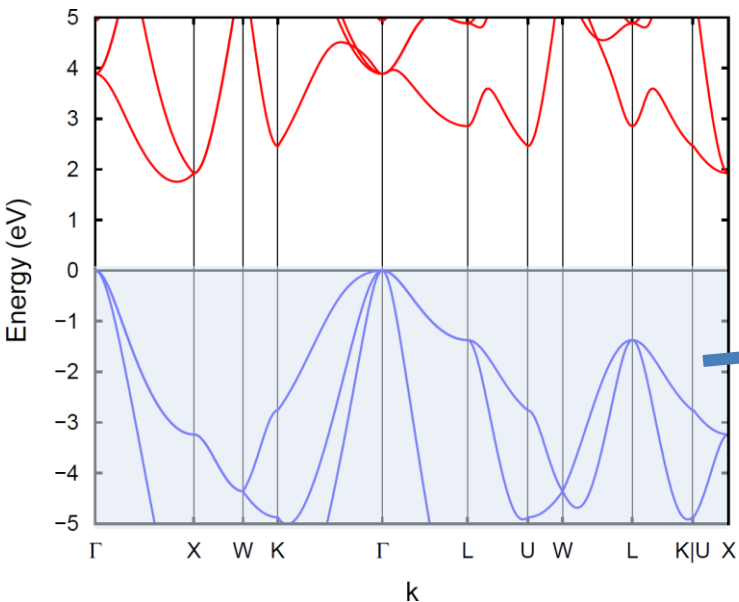

Electronic band structure of silicon (DFT-PBE0)

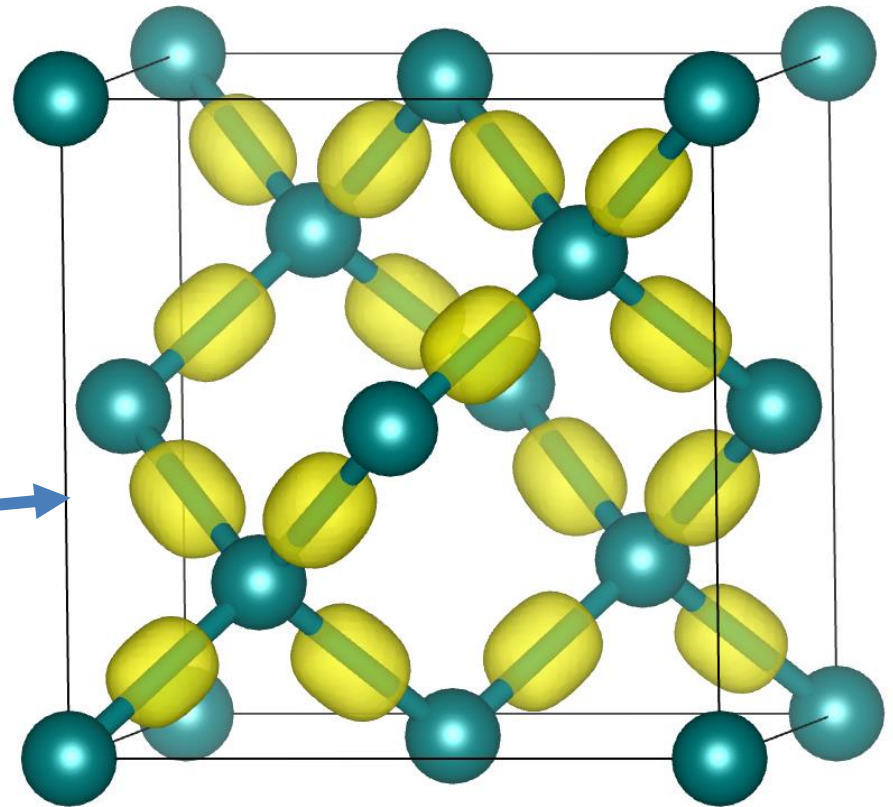

Band-projected electron density for three HOCOs (isovalue 0.0015 a.u.)