



Junos[®] OS

Logical Systems Configuration Guide

Release
12.3



Published: 2012-12-10

Juniper Networks, Inc.
1194 North Mathilda Avenue
Sunnyvale, California 94089
USA
408-745-2000
www.juniper.net

This product includes the Envoy SNMP Engine, developed by Epilogue Technology, an Integrated Systems Company. Copyright © 1986-1997, Epilogue Technology Corporation. All rights reserved. This program and its documentation were developed at private expense, and no part of them is in the public domain.

This product includes memory allocation software developed by Mark Moraes, copyright © 1988, 1989, 1993, University of Toronto.

This product includes FreeBSD software developed by the University of California, Berkeley, and its contributors. All of the documentation and software included in the 4.4BSD and 4.4BSD-Lite Releases is copyrighted by the Regents of the University of California. Copyright © 1979, 1980, 1983, 1986, 1988, 1989, 1991, 1992, 1993, 1994. The Regents of the University of California. All rights reserved.

GateD software copyright © 1995, the Regents of the University. All rights reserved. Gate Daemon was originated and developed through release 3.0 by Cornell University and its collaborators. Gated is based on Kirton's EGP, UC Berkeley's routing daemon (routed), and DCN's HELLO routing protocol. Development of Gated has been supported in part by the National Science Foundation. Portions of the GateD software copyright © 1988, Regents of the University of California. All rights reserved. Portions of the GateD software copyright © 1991, D. L. S. Associates.

This product includes software developed by Maker Communications, Inc., copyright © 1996, 1997, Maker Communications, Inc.

Juniper Networks, Junos, Steel-Belted Radius, NetScreen, and ScreenOS are registered trademarks of Juniper Networks, Inc. in the United States and other countries. The Juniper Networks Logo, the Junos logo, and JunosE are trademarks of Juniper Networks, Inc. All other trademarks, service marks, registered trademarks, or registered service marks are the property of their respective owners.

Juniper Networks assumes no responsibility for any inaccuracies in this document. Juniper Networks reserves the right to change, modify, transfer, or otherwise revise this publication without notice.

Products made or sold by Juniper Networks or components thereof might be covered by one or more of the following patents that are owned by or licensed to Juniper Networks: U.S. Patent Nos. 5,473,599, 5,905,725, 5,909,440, 6,192,051, 6,333,650, 6,359,479, 6,406,312, 6,429,706, 6,459,579, 6,493,347, 6,538,518, 6,538,899, 6,552,918, 6,567,902, 6,578,186, and 6,590,785.

Junos® OS Logical Systems Configuration Guide

12.3

Copyright © 2012, Juniper Networks, Inc.

All rights reserved.

The information in this document is current as of the date on the title page.

YEAR 2000 NOTICE

Juniper Networks hardware and software products are Year 2000 compliant. Junos OS has no known time-related limitations through the year 2038. However, the NTP application is known to have some difficulty in the year 2036.

END USER LICENSE AGREEMENT

The Juniper Networks product that is the subject of this technical documentation consists of (or is intended for use with) Juniper Networks software. Use of such software is subject to the terms and conditions of the End User License Agreement ("EULA") posted at <http://www.juniper.net/support/eula.html>. By downloading, installing or using such software, you agree to the terms and conditions of that EULA.

Table of Contents

	About the Documentation	xi
	Documentation and Release Notes	xi
	Supported Platforms	xi
	Using the Examples in This Manual	xi
	Merging a Full Example	xii
	Merging a Snippet	xii
	Documentation Conventions	xiii
	Documentation Feedback	xv
	Requesting Technical Support	xv
	Self-Help Online Tools and Resources	xv
	Opening a Case with JTAC	xvi
Part 1	Overview	
Chapter 1	Logical Systems Overview	3
	Introduction to Logical Systems	3
	Junos OS Features That Are Supported on Logical Systems	5
	Logical Systems Operations and Restrictions	6
	Comparing Junos OS Device Virtualization Technologies	8
	Logical Systems Applications	9
	Logical Systems Requirements	10
	Logical Systems Terms and Acronyms	11
Part 2	Configuration	
Chapter 2	User Access	15
	Example: Configuring User Access for Logical Systems	15
	Understanding Junos OS Access Privilege Levels	15
	Junos OS Login Class Permission Flags	15
	Allowing or Denying Individual Commands for Junos OS Login Classes	19
	Example: Configuring Logical System Administrators	20
Chapter 3	Interfaces	23
	Examples: Configuring Logical System Interfaces	23
	Understanding Interfaces	23
	Example: Creating an Interface on a Logical System	24
	Example: Connecting a Logical System to a Physical Router	26
	Example: Connecting Logical Systems Within the Same Router Using Logical Tunnel Interfaces	28
	Example: Connecting Logical Systems Within the Same Router Using Logical Tunnel Interfaces on MX Series Routers	32

Chapter 4	Static Routing	37
	Example: Configuring Static Routing on Logical Systems	37
	Understanding Basic Static Routing	37
	Example: Configuring Static Routes Between Logical Systems Within the Same Router	37
Chapter 5	Firewall Filters	45
	Examples: Configuring Standard Firewall Filters on Logical Systems	45
	Understanding How to Use Standard Firewall Filters	45
	Using Standard Firewall Filters to Affect Local Packets	45
	Using Standard Firewall Filters to Affect Data Packets	46
	Example: Configuring a Stateless Firewall Filter to Protect a Logical System Against ICMP Floods	46
	Example: Configuring Filter-Based Forwarding on Logical Systems	49
Chapter 6	Routing Protocols and Policy	61
	Example: Configuring OSPF on Logical Systems	61
	OSPF Overview	62
	OSPF Default Route Preference Values	64
	OSPF Routing Algorithm	64
	OSPF Three-Way Handshake	65
	OSPF Version 3	66
	Example: Configuring OSPF on Logical Systems Within the Same Router	66
	Examples: Configuring OSPF Routing Policy on Logical Systems	73
	Understanding OSPF Routing Policy	73
	Routing Policy Terms	74
	Routing Policy Match Conditions	74
	Routing Policy Actions	75
	Example: Configuring an OSPF Default Route Policy on Logical Systems . . .	75
	Example: Configuring a Conditional OSPF Default Route Policy on Logical Systems	80
	Example: Configuring an OSPF Import Policy on Logical Systems	87
	Examples: Configuring IS-IS on Logical Systems	94
	IS-IS Overview	95
	IS-IS Terminology	95
	ISO Network Addresses	96
	IS-IS Packets	97
	Persistent Route Reachability	98
	IS-IS Support for Multipoint Network Clouds	98
	Installing a Default Route to the Nearest Routing Device That Operates at Both IS-IS Levels	98
	Example: Configuring IS-IS on Logical Systems Within the Same Router . . .	99
	Example: Configuring an IS-IS Default Route Policy on Logical Systems . . .	108
	Examples: Configuring BGP on Logical Systems	113
	Understanding BGP	113
	Autonomous Systems	114
	AS Paths and Attributes	114
	External and Internal BGP	114

	Multiple Instances of BGP	115
	Example: Configuring Internal BGP Peering Sessions on Logical Systems . .	115
	Example: Configuring External BGP on Logical Systems with IPv6 Interfaces	125
	Example: Configuring BFD on Internal BGP Peer Sessions	140
	Example: Configuring EBGP Multihop Sessions on Logical Systems	149
Chapter 7	MPLS	159
	Example: Configuring RSVP-Signaled Point-to-Multipoint LSPs on Logical Systems	159
	Point-to-Multipoint LSPs Overview	159
	Example: Configuring an RSVP-Signaled Point-to-Multipoint LSP on Logical Systems	161
Chapter 8	VPNs and VPLS	183
	Example: Configuring VPNs and VPLS on Logical Systems	183
	Layer 3 VPN Introduction	183
	Introduction to VPLS	183
	Example: Using Logical Systems to Configure Provider Edge and Provider Routers in a Layer 3 VPN and VPLS Scenario	184
Chapter 9	Datacenter	227
	Example: Configuring a Virtualized Data Center	227
	Two-Tiered Virtualized Data Center Solution for Large Enterprise Networks	227
	Network Traffic Segmentation	227
	Flexibility	227
	Security	228
	Access and Availability	228
	Cost-Effective Incremental Scaling	228
	Orchestration and Automation	229
	Requirements of a Two-Tiered Virtualized Data Center for Large Enterprise Networks	229
	Network Traffic Segmentation	229
	Flexibility	229
	Security	230
	Access and Availability	230
	Cost-Effective Incremental Scaling	230
	Orchestration and Automation	230
	Example: Configuring a Two-Tiered Virtualized Data Center for Large Enterprise Networks	231
Chapter 10	Configuration Statements	273
	[edit logical-systems] Hierarchy Level	273

Part 3	Administration	
Chapter 11	Operational Commands	277
	Operational-Mode Commands	277
	Overview of Junos OS CLI Operational Mode Commands	277
	CLI Command Categories	277
	Commonly Used Operational Mode Commands	278
	Example: Running Operational-Mode Commands on Logical Systems . . .	280
	Example: Viewing BGP Trace Files on Logical Systems	281
	Example: Configuring System Logging on Logical Systems	286
Part 4	Index	
	Index	291

List of Figures

Part 1	Overview	
Chapter 1	Logical Systems Overview	3
	Figure 1: Logical Systems Concepts	4
	Figure 2: Junos OS Without Logical Systems	4
	Figure 3: Junos OS With Logical Systems	5
	Figure 4: Applications of Logical Systems	10
Part 2	Configuration	
Chapter 2	User Access	15
	Figure 5: Logical System Administrators	20
Chapter 3	Interfaces	23
	Figure 6: Logical System Connected to a Physical Router	26
	Figure 7: Connecting Two Logical Systems	29
	Figure 8: Connecting Two Logical Systems	33
Chapter 4	Static Routing	37
	Figure 9: Static Routes Between Logical Systems	38
Chapter 5	Firewall Filters	45
	Figure 10: Logical System with a Stateless Firewall	47
	Figure 11: Logical Systems with Filter-Based Forwarding	52
Chapter 6	Routing Protocols and Policy	61
	Figure 12: OSPF Three-Way Handshake	65
	Figure 13: OSPF on Logical Systems	67
	Figure 14: OSPF with a Default Route to an ISP	76
	Figure 15: OSPF with a Conditional Default Route to an ISP	81
	Figure 16: OSPF Import Policy on Logical Systems	88
	Figure 17: Install Default Route to Nearest Routing Device That Operates at Both Level 1 and Level 2	99
	Figure 18: IS-IS on Logical Systems	100
	Figure 19: IS-IS with a Default Route to an ISP	108
	Figure 20: ASs, EBGP, and IBGP	114
	Figure 21: Typical Network with IBGP Sessions	116
	Figure 22: Typical Network with BGP Peer Sessions	127
	Figure 23: Typical Network with IBGP Sessions	142
	Figure 24: Typical Network with EBGP Multihop Sessions	150
Chapter 7	MPLS	159
	Figure 25: Point-to-Multipoint LSPs	160

	Figure 26: RSVP-Signaled Point-to-Multipoint LSP on Logical Systems	162
Chapter 8	VPNs and VPLS	183
	Figure 27: Provider Edge and Provider Logical System Topology Diagram	185
Chapter 9	Datacenter	227
	Figure 28: Virtualized Data Center Physical Topology	232
	Figure 29: Virtualized Data Center Logical Topology	233

List of Tables

	About the Documentation	xi
	Table 1: Notice Icons	xiii
	Table 2: Text and Syntax Conventions	xiii
Part 1	Overview	
Chapter 1	Logical Systems Overview	3
	Table 3: Benefits of Virtual Routers, VRF-Lite, and Logical Systems	9
Part 2	Configuration	
Chapter 2	User Access	15
	Table 4: Login Class Permission Flags	16
Chapter 6	Routing Protocols and Policy	61
	Table 5: Default Route Preference Values for OSPF	64
Part 3	Administration	
Chapter 11	Operational Commands	277
	Table 6: Commonly Used Operational Mode Commands	279

About the Documentation

- Documentation and Release Notes on page xi
- Supported Platforms on page xi
- Using the Examples in This Manual on page xi
- Documentation Conventions on page xiii
- Documentation Feedback on page xv
- Requesting Technical Support on page xv

Documentation and Release Notes

To obtain the most current version of all Juniper Networks® technical documentation, see the product documentation page on the Juniper Networks website at <http://www.juniper.net/techpubs/>.

If the information in the latest release notes differs from the information in the documentation, follow the product Release Notes.

Juniper Networks Books publishes books by Juniper Networks engineers and subject matter experts. These books go beyond the technical documentation to explore the nuances of network architecture, deployment, and administration. The current list can be viewed at <http://www.juniper.net/books>.

Supported Platforms

For the features described in this document, the following platforms are supported:

- T Series
- MX Series
- M Series
- PTX Series

Using the Examples in This Manual

If you want to use the examples in this manual, you can use the **load merge** or the **load merge relative** command. These commands cause the software to merge the incoming configuration into the current candidate configuration. The example does not become active until you commit the candidate configuration.

If the example configuration contains the top level of the hierarchy (or multiple hierarchies), the example is a *full example*. In this case, use the **load merge** command.

If the example configuration does not start at the top level of the hierarchy, the example is a *snippet*. In this case, use the **load merge relative** command. These procedures are described in the following sections.

Merging a Full Example

To merge a full example, follow these steps:

1. From the HTML or PDF version of the manual, copy a configuration example into a text file, save the file with a name, and copy the file to a directory on your routing platform.

For example, copy the following configuration to a file and name the file **ex-script.conf**. Copy the **ex-script.conf** file to the **/var/tmp** directory on your routing platform.

```
system {
  scripts {
    commit {
      file ex-script.xml;
    }
  }
}
interfaces {
  fxp0 {
    disable;
    unit 0 {
      family inet {
        address 10.0.0.1/24;
      }
    }
  }
}
```

2. Merge the contents of the file into your routing platform configuration by issuing the **load merge** configuration mode command:

```
[edit]
user@host# load merge /var/tmp/ex-script.conf
load complete
```

Merging a Snippet

To merge a snippet, follow these steps:

1. From the HTML or PDF version of the manual, copy a configuration snippet into a text file, save the file with a name, and copy the file to a directory on your routing platform.

For example, copy the following snippet to a file and name the file **ex-script-snippet.conf**. Copy the **ex-script-snippet.conf** file to the **/var/tmp** directory on your routing platform.

```
commit {
  file ex-script-snippet.xml; }
```

2. Move to the hierarchy level that is relevant for this snippet by issuing the following configuration mode command:

```
[edit]
user@host# edit system scripts
[edit system scripts]
```

3. Merge the contents of the file into your routing platform configuration by issuing the **load merge relative** configuration mode command:

```
[edit system scripts]
user@host# load merge relative /var/tmp/ex-script-snippet.conf
load complete
```

For more information about the **load** command, see the CLI User Guide.

Documentation Conventions

Table 1 on page xiii defines notice icons used in this guide.

Table 1: Notice Icons





Icon	Meaning	Description
	Informational note	Indicates important features or instructions.
	Caution	Indicates a situation that might result in loss of data or hardware damage.
	Warning	Alerts you to the risk of personal injury or death.
	Laser warning	Alerts you to the risk of personal injury from a laser.

Table 2 on page xiii defines the text and syntax conventions used in this guide.

Table 2: Text and Syntax Conventions

Convention	Description	Examples
Bold text like this	Represents text that you type.	To enter configuration mode, type the configure command: user@host> configure
Fixed-width text like this	Represents output that appears on the terminal screen.	user@host> show chassis alarms No alarms currently active

Table 2: Text and Syntax Conventions (*continued*)

Convention	Description	Examples
<i>Italic text like this</i>	<ul style="list-style-type: none"> Introduces or emphasizes important new terms. Identifies book names. Identifies RFC and Internet draft titles. 	<ul style="list-style-type: none"> A policy <i>term</i> is a named structure that defines match conditions and actions. <i>Junos OS System Basics Configuration Guide</i> RFC 1997, <i>BGP Communities Attribute</i>
<i>Italic text like this</i>	Represents variables (options for which you substitute a value) in commands or configuration statements.	Configure the machine's domain name: [edit] root@# set system domain-name <i>domain-name</i>
Text like this	Represents names of configuration statements, commands, files, and directories; configuration hierarchy levels; or labels on routing platform components.	<ul style="list-style-type: none"> To configure a stub area, include the stub statement at the [edit protocols ospf area area-id] hierarchy level. The console port is labeled CONSOLE.
< > (angle brackets)	Enclose optional keywords or variables.	stub <default-metric metric>;
(pipe symbol)	Indicates a choice between the mutually exclusive keywords or variables on either side of the symbol. The set of choices is often enclosed in parentheses for clarity.	broadcast multicast <i>(string1 string2 string3)</i>
# (pound sign)	Indicates a comment specified on the same line as the configuration statement to which it applies.	rsvp { # Required for dynamic MPLS only
[] (square brackets)	Enclose a variable for which you can substitute one or more values.	community name members [community-ids]
Indentation and braces ({ })	Identify a level in the configuration hierarchy.	[edit] routing-options { static { route default { nexthop <i>address</i> ; retain; } } }
;(semicolon)	Identifies a leaf statement at a configuration hierarchy level.	
J-Web GUI Conventions		
Bold text like this	Represents J-Web graphical user interface (GUI) items you click or select.	<ul style="list-style-type: none"> In the Logical Interfaces box, select All Interfaces. To cancel the configuration, click Cancel.
> (bold right angle bracket)	Separates levels in a hierarchy of J-Web selections.	In the configuration editor hierarchy, select Protocols>Ospf .

Documentation Feedback

We encourage you to provide feedback, comments, and suggestions so that we can improve the documentation. You can send your comments to techpubs-comments@juniper.net, or fill out the documentation feedback form at <https://www.juniper.net/cgi-bin/docbugreport/>. If you are using e-mail, be sure to include the following information with your comments:

- Document or topic name
- URL or page number
- Software release version (if applicable)

Requesting Technical Support

Technical product support is available through the Juniper Networks Technical Assistance Center (JTAC). If you are a customer with an active J-Care or JNASC support contract, or are covered under warranty, and need post-sales technical support, you can access our tools and resources online or open a case with JTAC.

- JTAC policies—For a complete understanding of our JTAC procedures and policies, review the *JTAC User Guide* located at <http://www.juniper.net/us/en/local/pdf/resource-guides/7100059-en.pdf>.
- Product warranties—For product warranty information, visit <http://www.juniper.net/support/warranty/>.
- JTAC hours of operation—The JTAC centers have resources available 24 hours a day, 7 days a week, 365 days a year.

Self-Help Online Tools and Resources

For quick and easy problem resolution, Juniper Networks has designed an online self-service portal called the Customer Support Center (CSC) that provides you with the following features:

- Find CSC offerings: <http://www.juniper.net/customers/support/>
- Search for known bugs: <http://www2.juniper.net/kb/>
- Find product documentation: <http://www.juniper.net/techpubs/>
- Find solutions and answer questions using our Knowledge Base: <http://kb.juniper.net/>
- Download the latest versions of software and review release notes: <http://www.juniper.net/customers/csc/software/>
- Search technical bulletins for relevant hardware and software notifications: <https://www.juniper.net/alerts/>

- Join and participate in the Juniper Networks Community Forum:
<http://www.juniper.net/company/communities/>
- Open a case online in the CSC Case Management tool: <http://www.juniper.net/cm/>

To verify service entitlement by product serial number, use our Serial Number Entitlement (SNE) Tool: <https://tools.juniper.net/SerialNumberEntitlementSearch/>

Opening a Case with JTAC

You can open a case with JTAC on the Web or by telephone.

- Use the Case Management tool in the CSC at <http://www.juniper.net/cm/>.
- Call 1-888-314-JTAC (1-888-314-5822 toll-free in the USA, Canada, and Mexico).

For international or direct-dial options in countries without toll-free numbers, see <http://www.juniper.net/support/requesting-support.html>.

PART 1

Overview

- [Logical Systems Overview on page 3](#)

CHAPTER 1

Logical Systems Overview

- [Introduction to Logical Systems on page 3](#)
- [Junos OS Features That Are Supported on Logical Systems on page 5](#)
- [Logical Systems Operations and Restrictions on page 6](#)
- [Comparing Junos OS Device Virtualization Technologies on page 8](#)
- [Logical Systems Applications on page 9](#)
- [Logical Systems Requirements on page 10](#)
- [Logical Systems Terms and Acronyms on page 11](#)

Introduction to Logical Systems

For many years, engineers have combined power supplies, routing hardware and software, forwarding hardware and software, and physical interfaces into a networking device known as a router. Networking vendors have created large routers and small routers, but all routers have been placed into service as individual devices. As a result, the router has been considered a single physical device for most of its history.

The concept of logical systems breaks with this tradition. With the Junos[®] operating system (Junos OS), you can partition a single router into multiple logical devices that perform independent routing tasks. Because logical systems perform a subset of the tasks once handled by the main router, logical systems offer an effective way to maximize the use of a single routing or switching platform.



NOTE: Beginning with Junos OS Release 9.3, the logical router feature has been renamed logical system.

All configuration statements, operational commands, show command output, error messages, log messages, and SNMP MIB objects that contain the string `logical-router` have been changed to `logical-system`.

Traditionally, service provider network design requires multiple layers of switches and routers. These devices transport packet traffic between customers. As seen on the left side of [Figure 1 on page 4](#), access devices are connected to edge devices, which are in turn connected to core devices.

However, this complexity can lead to challenges in maintenance, configuration, and operation. To reduce such complexity, Juniper Networks supports logical systems. Logical systems perform a subset of the actions of the main router and have their own unique routing tables, interfaces, policies, and routing instances. As shown on the right side of [Figure 1 on page 4](#), a set of logical systems within a single router can handle the functions previously performed by several small routers.

Figure 1: Logical Systems Concepts

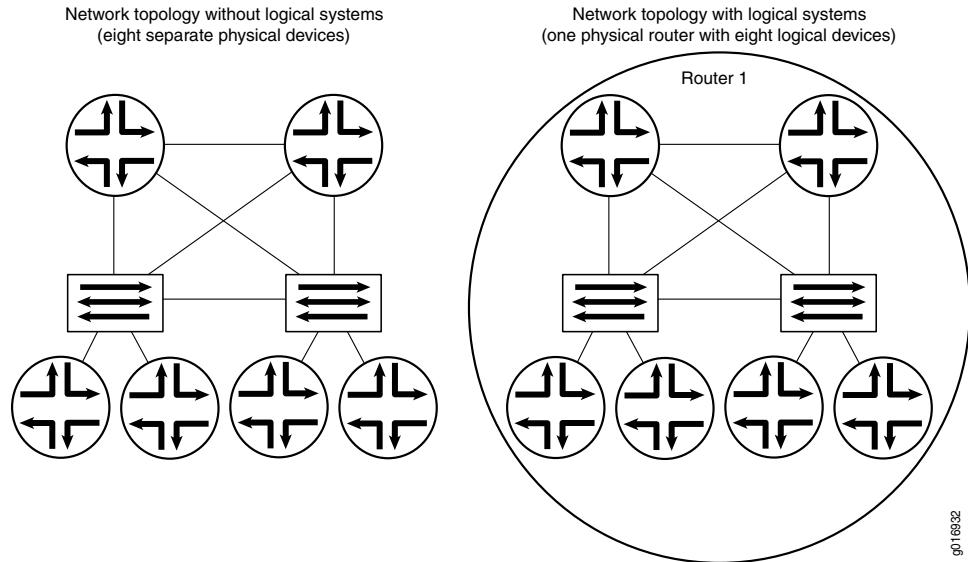

[Figure 2 on page 4](#) shows the Junos OS architecture without logical systems configured. [Figure 3 on page 5](#) shows the Junos OS architecture when logical systems are configured. Note that each logical system runs its own routing protocol process (rpd).

Figure 2: Junos OS Without Logical Systems

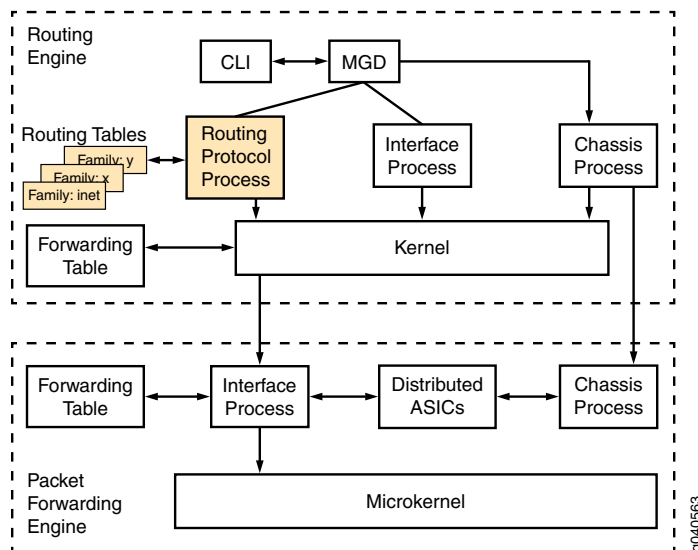
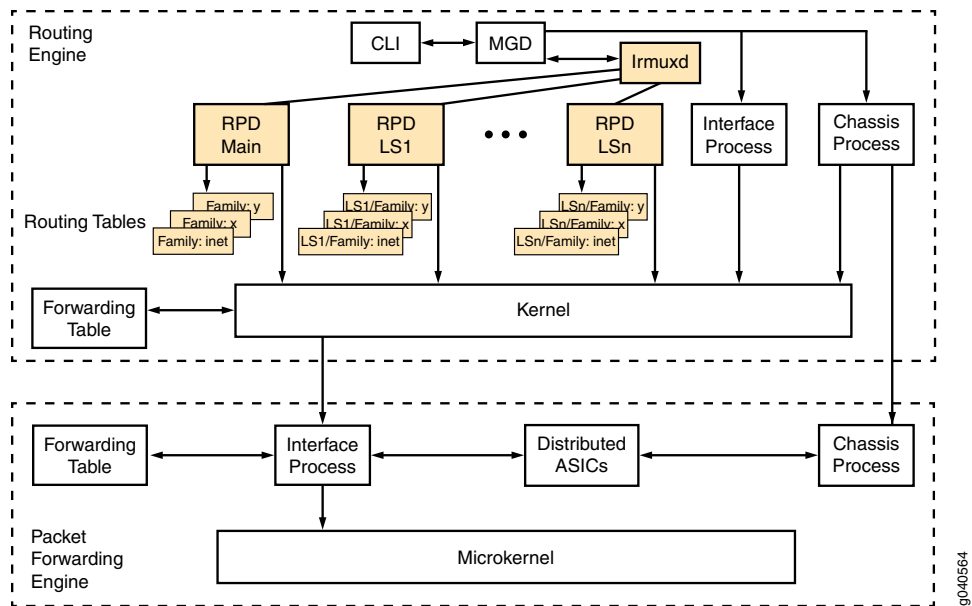

Figure 3: Junos OS With Logical Systems



Related Documentation

- [Logical Systems Operations and Restrictions on page 6](#)
- [Junos OS Features That Are Supported on Logical Systems on page 5](#)

Junos OS Features That Are Supported on Logical Systems

The following protocols and functions are supported on logical systems:

- Open Shortest Path First (OSPF), Intermediate System-to-Intermediate System (IS-IS), Routing Information Protocol (RIP), RIP next generation (RIPng), Border Gateway Protocol (BGP), Resource Reservation Protocol (RSVP), Label Distribution Protocol (LDP), static routes, and Internet Protocol version 4 (IPv4) and version 6 (IPv6).
- Multiprotocol Label Switching (MPLS) provider edge (PE) and core provider router functions, such as Layer 2 virtual private networks (VPNs), Layer 3 VPNs, circuit cross-connect (CCC), Layer 2 circuits, and virtual private LAN service (VPLS).
- Resource Reservation Protocol (RSVP) point-to-multipoint label-switched paths (LSPs).
- Multicast protocols, such as Protocol Independent Multicast (PIM), Distance Vector Multicast Routing Protocol (DVMRP), rendezvous point (RP), and source designated router (DR).
- All policy-related statements available at the **[edit policy-options]** hierarchy level.
- Most routing options statements available at the **[edit routing-options]** hierarchy level.
- Graceful Routing Engine switchover (GRES). Configure graceful Routing Engine switchover on the main router with the **graceful-switchover** statement at the **[edit chassis redundancy]** hierarchy level.

- Graceful restart. Include the **graceful-restart** statement at the **[edit logical-systems logical-system-name routing-options]** hierarchy level.
- You can assign most interface types to a logical system. For a list of unsupported PICs, see [“Logical Systems Operations and Restrictions” on page 6](#).
- Flow aggregation in logical systems is supported starting in Junos OS Release 11.4. In the logical system, sampling based on the Routing Engine is not supported. Only PIC-based sampling is supported. Logical systems support only cflowd version 9. Currently, cflowd version 5 and cflowd version 8 are not supported in logical systems. Flow aggregation in logical systems is slightly different from flow aggregation on the main router in that when you configure flow aggregation in logical systems, the **route-record** statement is not required.
- Port mirroring, source class usage, destination class usage, unicast reverse-path forwarding, class of service, firewall filters, class-based forwarding, and policy-based accounting work with logical systems when you configure these features on the main router.
- The Simple Network Management Protocol (SNMP) has been extended to support logical systems and routing instances. A network management system receives instance-aware information in the following format:

logical-system-name/routing-instance@community

As a result, a network manager can gather statistics for a specific community within a routing instance within a logical system. The SNMP manager for a routing instance can request and manage SNMP data only for that routing instance and other routing instances in the same logical system. By default, the SNMP manager for the default routing instance in the main router (**inet.0**) can access SNMP data from all routing instances. To restrict that manager’s access to the default routing instance only, include the **routing-instance-access** statement at the **[edit snmp]** hierarchy level.
- For SRX platforms only, support for system logging at the **[edit logical-system logical-system-name system syslog]** hierarchy level is introduced in Junos OS Release 11.4.

**Related
Documentation**

- [Introduction to Logical Systems on page 3](#)
- [Logical Systems Operations and Restrictions on page 6](#)

Logical Systems Operations and Restrictions

Logical systems have the following operations and restrictions:

- You can configure a maximum of 15 logical systems plus the master logical system on a router. When a configuration session is in use, users who are tied to the same logical system cannot commit configuration changes.
- The router has only one running configuration database, which contains configuration information for the main router and all associated logical systems. When configuring a logical system, a user has his own candidate configuration database, which does not

become part of the running configuration database until the user issues the **commit** command.

- Configuring the out-of-band management interface, such as **em0** or **fxp0**, in a logical system is not supported.
- Some high availability features are not supported on logical systems. These features include non-stop routing (NSR), non-stop bridging (NSB), and unified in-service software upgrade (unified ISSU). Graceful restart is supported. For a logical system, include the `graceful-restart` statement at the [edit logical-systems logical-system-name routing-options] hierarchy level.
- The following guidelines describe how firewall filters affect the main router, logical systems, and virtual routers. The "default loopback interface" refers to **lo0.0** (associated with the default routing table), the "loopback interface in a logical system" refers to **lo0.n** configured in the logical system, and the "loopback interface in the virtual router" refers to **lo0.n** configured in the virtual router.

If you configure Filter A on the default loopback interface in the main router but do not configure a filter on the loopback interface in a logical system, the logical system does not use a filter.

If you configure Filter A on the default loopback interface in the main router but do not configure a loopback interface in a logical system, the logical system uses Filter A.

If you configure Filter A on the default loopback interface on the main router and Filter B on the loopback interface in a logical system, the logical system uses Filter B. In a special case of this rule, when you also configure a routing instance of type **virtual-router** on the logical system, the following rules apply:

- If you configure Filter C on the loopback interface in the virtual router, traffic belonging to the virtual router uses Filter C.
- If you do not configure a filter on the loopback interface in the virtual router, traffic belonging to the virtual router does not use a filter.
- If you do not configure a loopback interface in the virtual router, traffic belonging to the virtual router uses Filter A.
- If a logical system experiences an interruption of its routing protocol process (**rpd**), the core dump output is placed in `/var/tmp/` in a file called **rpd_logical-system-name.core-tarball.number.tgz**. Likewise, if you issue the **restart routing** command in a logical system, only the routing protocol process (**rpd**) for the logical system is restarted.
- If you configure trace options for a logical system, the output log file is stored in the following location: `/var/log/logical-system-name`. To monitor a log file within a logical system, issue the **monitor start logical-system-name/filename** command.
- The following PICs are not supported with logical systems: Adaptive Services, Multiservices, ES, Monitoring Services, and Monitoring Services II.
- The Multiservices Dense Port Concentrator (MS-DPC) is not supported with logical systems.
- Generalized MPLS (GMPLS), IP Security (IPsec), and sampling are not supported.

- Class of service (CoS) on a logical tunnel (**lt**) or virtual loopback tunnel (**vt**) interface in a logical system is not supported.
- You cannot include the **vrf-table-label** statement on multiple logical systems if the core-facing interfaces are channelized or configured with multiple logical interfaces (Frame Relay DLCIs or Ethernet VLANs).
- The master administrator must configure global interface properties and physical interface properties at the **[edit interfaces]** hierarchy level. Logical system administrators can only configure and verify configurations for the logical systems to which they are assigned.
- You can configure only Frame Relay interface encapsulation on a logical tunnel interface (**lt-**) when it is configured with an IPv6 address.
- IPv6 tunneling is not supported with point-to-multipoint label-switched paths (LSPs) configured on logical systems.
- IGMP snooping is not supported.
- In a VPLS multihoming scenario in which a logical tunnel interface (**lt-**) is used for connecting the dual-home VPLS, Junos OS creates a unique static MAC address for every logical tunnel interface configured. This MAC address is not flushed when a CCC down event occurs on the link and when traffic is switched from the primary link to the backup link (or the reverse). As a result, any traffic that is destined for hosts behind the logical tunnel MAC address does not take the new path.

**Related
Documentation**

- [Introduction to Logical Systems on page 3](#)
- [Junos OS Features That Are Supported on Logical Systems on page 5](#)

Comparing Junos OS Device Virtualization Technologies

The Junos OS supports multiple device virtualization technologies. The technologies have similar names, which can lead to confusion.

The Junos OS device virtualization technologies are:

- Logical systems—Offer routing and management separation. Management separation means multiple user access. Each logical system has its own routing tables.

Logical routers is the old name for logical systems. Beginning with Junos OS Release 9.3, the logical router feature has been renamed logical system. All configuration statements, operational commands, **show** command output, error messages, log messages, and SNMP MIB objects that contain the string logical-router have been changed to logical-system.

- Virtual routers—Offer scalable routing separation. A virtual router does not have the same capabilities as a logical system. A virtual router is a type of simplified routing instance that has a single routing table. By contrast, a logical system is a partition of the main router and can contain multiple routing instances.

- VRF-Lite—Offers routing separation. The functionality of VRF-Lite is similar to virtual routers, but VRF-Lite is for smaller environments.
- Virtual switches—Offer scalable switching separation.

[Table 3 on page 9](#) summarizes the benefits of virtual routers, VRF-Lite, and logical systems.

Table 3: Benefits of Virtual Routers, VRF-Lite, and Logical Systems

Benefits	Virtual Router	VRF-Lite	Logical Systems
Logical platform partitioning	Yes	Yes	Yes
Fault isolation on the routing plane	No	No	Yes
Multiple user access (management separation)	No	No	Yes
Scalable routing separation	Yes	No	Yes

Related Documentation

- [Logical Systems Applications on page 9](#)

Logical Systems Applications

Logical systems are discrete contexts that virtually divide a supported device into multiple devices, isolating one from another and protecting them from faulty conditions outside their own contexts.

The logical systems functionality enables you to partition the device and assign private logical systems to groups or organizations. Logical systems are defined largely by the resources allocated to them, features enabled for the logical context, their routing configurations, and their logical interface assignments. Logical systems segment a physical router to be configured and operated as multiple independent routers within a platform. This isolates routing protocols and interfaces among up to 16 logical systems (including the master logical system). User permissions and access are defined separately for each logical system, enabling different groups to manage the same physical device. Logical systems enable the use of large routers in small router roles and provide flexible segmentation of routing by service type. Multiple service capabilities bring improved asset optimization by consolidating services into one device.

For example, logical systems enable the following services on a single router platform:

- Internet BGP peering
- Core transit

- Edge aggregation and dedicated access
- MPLS provider edge (PE) and provider (P) VPN label-switched routers (LSRs)

Figure 4 on page 10 shows how logical systems can be used for horizontal consolidation, vertical consolidation, and managed services. Horizontal consolidation occurs when you combine router functions of the same layer into a single router. Vertical consolidation occurs when you collapse router functions of different layers into a single router. With managed services, each logical system is a customer router.

Figure 4: Applications of Logical Systems

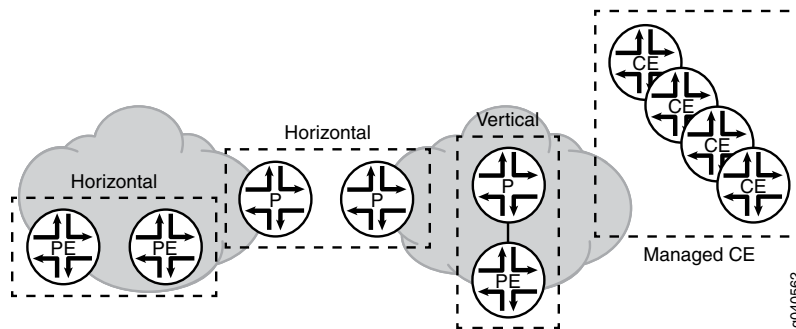

Related Documentation

- [Comparing Junos OS Device Virtualization Technologies on page 8](#)

Logical Systems Requirements

To implement logical systems, your system must meet these minimum requirements:

- Junos OS Release 8.5 or later for logical system administrator support
- Junos OS Release 8.4 or later for SNMP enhancements and limits
- Junos OS Release 8.3 or later for Bidirectional Forwarding Detection (BFD) on logical systems
- Junos OS Release 8.2 or later for support on MX Series routers
- Junos OS Release 7.5 or later for SNMP support within a logical system
- Junos OS Release 7.4 or later for multicast protocol RP and source designated router functionality within a logical system
- Junos OS Release 7.0 or later to implement a logical tunnel (lt) interface on an integrated Adaptive Services Module in an M7i router
- Junos OS Release 6.1 or later, a Tunnel Services PIC, and an Enhanced FPC on M Series or T Series routers to implement a logical tunnel (lt) interface
- Junos OS Release 6.0 or later for basic logical system functionality
- One or more M Series, MX Series, or T Series routers
- On M Series and T Series routers, a variety of PICs to assign interfaces to each logical system

Related Documentation • *Junos OS Logical Systems Configuration Guide for Security Devices*

Logical Systems Terms and Acronyms

A

logical system administrator A user account with configuration and verification privileges for only the logical systems to which that user is assigned.

master administrator A user account with superuser configuration and verification privileges.

L

logical system Segmentation of a system into multiple logical devices. Logical system configuration statements are found at the **[edit logical-systems]** hierarchy level.

M

main router The standard concept of a router. Main router configuration statements are found at the **[edit]** hierarchy level.

PART 2

Configuration

- [User Access on page 15](#)
- [Interfaces on page 23](#)
- [Static Routing on page 37](#)
- [Firewall Filters on page 45](#)
- [Routing Protocols and Policy on page 61](#)
- [MPLS on page 159](#)
- [VPNs and VPLS on page 183](#)
- [Datacenter on page 227](#)
- [Configuration Statements on page 273](#)

CHAPTER 2

User Access

- [Example: Configuring User Access for Logical Systems on page 15](#)

Example: Configuring User Access for Logical Systems

- [Understanding Junos OS Access Privilege Levels on page 15](#)
- [Example: Configuring Logical System Administrators on page 20](#)

Understanding Junos OS Access Privilege Levels

Each top-level command-line interface (CLI) command and each configuration statement have an access privilege level associated with them. Users can execute only those commands and configure and view only those statements for which they have access privileges. The access privileges for each login class are defined by one or more *permission flags*.

For each login class, you can explicitly deny or allow the use of operational and configuration mode commands that would otherwise be permitted or not allowed by a privilege level specified in the **permissions** statement.

The following sections provide additional information about permissions:

- [Junos OS Login Class Permission Flags on page 15](#)
- [Allowing or Denying Individual Commands for Junos OS Login Classes on page 19](#)

Junos OS Login Class Permission Flags

The **permissions** statement specifies one or more of the permission flags listed in [Table 4 on page 16](#). Permission flags are not cumulative, so for each class you must list all the permission flags needed, including **view** to display information and **configure** to enter configuration mode. Two forms of permissions control for individual parts of the configuration are:

- "Plain" form—Provides read-only capability for that permission type. An example is **interface**.
- Form that ends in **-control**—Provides read and write capability for that permission type. An example is **interface-control**.

Table 4 on page 16 lists the Junos[®] operating system (Junos OS) login class permission flags that you can configure by including the **permissions** statement at the **[edit system login class *class-name*]** hierarchy level.

Table 4: Login Class Permission Flags

Permission Flag	Description
access	Can view the access configuration in configuration mode and with the show configuration operational mode command.
access-control	Can view and configure access information at the [edit access] hierarchy level.
admin	Can view user account information in configuration mode and with the show configuration operational mode command.
admin-control	Can view user accounts and configure them at the [edit system login] hierarchy level.
all-control	Can access all operational mode commands and configuration mode commands. Can modify configuration in all the configuration hierarchy levels.
clear	Can clear (delete) information learned from the network that is stored in various network databases by using the clear commands.
configure	Can enter configuration mode by using the configure command.
control	Can perform all control-level operations—all operations configured with the -control permission flags.
field	Can view field debug commands. Reserved for debugging support.
firewall	Can view the firewall filter configuration in configuration mode.
firewall-control	Can view and configure firewall filter information at the [edit firewall] hierarchy level.
floppy	Can read from and write to the removable media.
flow-tap	Can view the flow-tap configuration in configuration mode.
flow-tap-control	Can view the flow-tap configuration in configuration mode and can configure flow-tap configuration information at the [edit services flow-tap] hierarchy level.

Table 4: Login Class Permission Flags (*continued*)

Permission Flag	Description
flow-tap-operation	<p>Can make flow-tap requests to the router or switch. For example, a Dynamic Tasking Control Protocol (DTCP) client must authenticate itself to the Junos OS as an administrative user. That account must have flow-tap-operation permission.</p> <p>NOTE: The flow-tap-operation option is not included in the all-control permissions flag.</p>
idp-profiler-operation	Can view profiler data.
interface	Can view the interface configuration in configuration mode and with the show configuration operational mode command.
interface-control	<p>Can view chassis, class of service (CoS), groups, forwarding options, and interfaces configuration information. Can edit configuration at the following hierarchy levels:</p> <ul style="list-style-type: none"> • [edit chassis] • [edit class-of-service] • [edit groups] • [edit forwarding-options] • [edit interfaces]
maintenance	Can perform system maintenance, including starting a local shell on the router and becoming the superuser in the shell by using the su root command, and can halt and reboot the router by using the request system commands.
network	Can access the network by using the ping , ssh , telnet , and traceroute commands.
pgcp-session-mirroring	Can view the pgcp session mirroring configuration.
pgcp-session-mirroring-control	Can modify the pgcp session mirroring configuration.
reset	Can restart software processes by using the restart command and can configure whether software processes are enabled or disabled at the [edit system processes] hierarchy level.
rollback	Can use the rollback command to return to a previously committed configuration other than the most recently committed one.
routing	Can view general routing, routing protocol, and routing policy configuration information in configuration and operational modes.

Table 4: Login Class Permission Flags (*continued*)

Permission Flag	Description
routing-control	Can view general routing, routing protocol, and routing policy configuration information and can configure general routing at the [edit routing-options] hierarchy level, routing protocols at the [edit protocols] hierarchy level, and routing policy at the [edit policy-options] hierarchy level.
secret	Can view passwords and other authentication keys in the configuration.
secret-control	Can view passwords and other authentication keys in the configuration and can modify them in configuration mode.
security	Can view security configuration in configuration mode and with the show configuration operational mode command.
security-control	Can view and configure security information at the [edit security] hierarchy level.
shell	Can start a local shell on the router or switch by using the start shell command.
snmp	Can view Simple Network Management Protocol (SNMP) configuration information in configuration and operational modes.
snmp-control	Can view SNMP configuration information and can modify SNMP configuration at the [edit snmp] hierarchy level.
system	Can view system-level information in configuration and operational modes.
system-control	Can view system-level configuration information and configure it at the [edit system] hierarchy level.
trace	Can view trace file settings and configure trace file properties.
trace-control	Can modify trace file settings and configure trace file properties.
view	Can use various commands to display current system-wide, routing table, and protocol-specific values and statistics. Cannot view the secret configuration.
view-configuration	Can view all of the configuration excluding secrets, system scripts, and event options. NOTE: Only users with the maintenance permission can view commit script, op script, or event script configuration.

Allowing or Denying Individual Commands for Junos OS Login Classes

By default, all top-level CLI commands have associated access privilege levels. Users can execute only those commands and view only those statements for which they have access privileges. For each login class, you can explicitly deny or allow the use of operational and configuration mode commands that would otherwise be permitted or not allowed by a privilege level specified in the **permissions** statement.

- The **all** login class permission bits take precedence over extended regular expressions when a user with **rollback** permission issues the **rollback** command.
- Expressions used to allow and deny commands for users on RADIUS and TACACS+ servers have been simplified. Instead of a single, long expression with multiple commands (**allow-commands=cmd1 cmd2 ... cmdn**), you can specify each command as a separate expression. This new syntax is valid for **allow-configuration-regexps** and **deny-configuration-regexps**, **allow-commands** and **deny-commands**, and all user permission bits.
- Users cannot issue the **load override** command when specifying an extended regular expression. Users can only issue the **merge**, **replace**, and **patch** configuration commands.
- If you allow and deny the same commands, the **allow-commands** permissions take precedence over the permissions specified by the **deny-commands**. For example, if you include **allow-commands "request system software add"** and **deny-commands "request system software add"**, the login class user is allowed to install software using the **request system software add** command.
- Regular expressions for **allow-commands** and **deny-commands** can also include the **commit**, **load**, **rollback**, **save**, **status**, and **update** commands.
- If you specify a regular expression for **allow-commands** and **deny-commands** with two different variants of a command, the longest match is always executed.

For example, if you specify a regular expression for **allow-commands** with the **commit-synchronize** command and a regular expression for **deny-commands** with the **commit** command, users assigned to such a login class would be able to issue the **commit synchronize** command, but not the **commit** command. This is because **commit-synchronize** is the longest match between **commit** and **commit-synchronize** and it is specified for **allow-commands**.

Likewise, if you specify a regular expression for **allow-commands** with the **commit** command and a regular expression for **deny-commands** with the **commit-synchronize** command, users assigned to such a login class would be able to issue the **commit** command, but not the **commit-synchronize** command. This is because **commit-synchronize** is the longest match between **commit** and **commit-synchronize** and it is specified for **deny-commands**.

Example: Configuring Logical System Administrators

This example shows how to configure logical system administrators.

- [Requirements on page 20](#)
- [Overview on page 20](#)
- [Configuration on page 21](#)
- [Verification on page 21](#)

Requirements

You must be the master administrator to assign system administrators to logical systems.

Overview

The master administrator can assign one or more system administrators to each logical system. Logical system administrators are confined to the context of the logical system to which they are assigned. This means that logical system administrators cannot access any global configuration statements. This also means that command output is restricted to the context to which the logical system administrators are assigned.

Configuring a user account for each logical system helps in navigating the CLI. This enables you to log in to each logical system and be positioned within the root of that logical system as if you were in the root of a physical router.

In this example, **LS1Admin** has full permissions on Logical System LS1.

In this example, **LS2Admin** has the ability to view Logical System LS2 but not to change the configuration.

Diagram

[Figure 5 on page 20](#) shows how logical system administration works.

Figure 5: Logical System Administrators

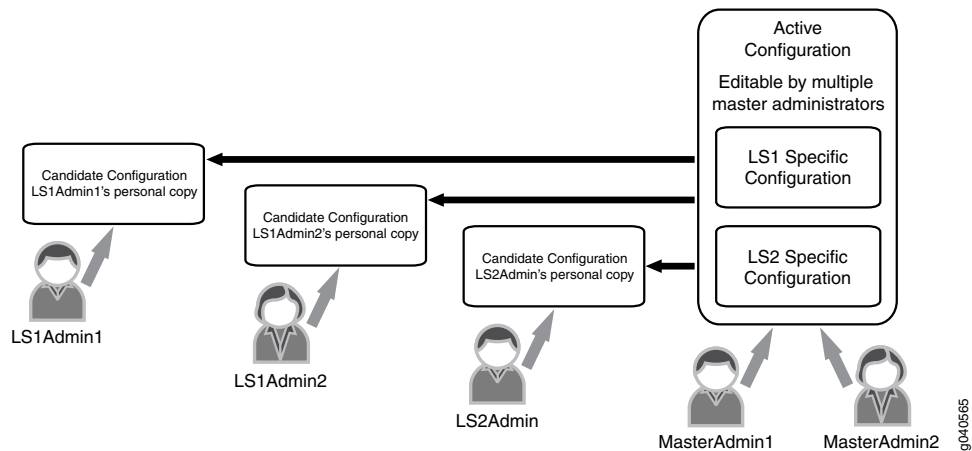

Configuration

CLI Quick Configuration To quickly configure this example, copy the following commands, paste them into a text file, remove any line breaks, change any details necessary to match your network configuration, and then copy and paste the commands into the CLI at the **[edit]** hierarchy level.

```
set logical-systems LS1
set logical-systems LS2
set system login class admin1 logical-system LS1
set system login class admin2 logical-system LS2
set system login class admin1 permissions all
set system login class admin2 permissions view
set system login user LS1Admin class admin1
set system login user LS2Admin class admin2
```

Step-by-Step Procedure The following example requires you to navigate various levels in the configuration hierarchy. For information about navigating the CLI, see Using the CLI Editor in Configuration Mode in the CLI User Guide.

To assign logical system administrators to a logical systems:

1. Configure the logical systems.

```
[edit]
user@host# set logical-systems LS1
user@host# set logical-systems LS2
```

2. Create the login classes and assign logical systems to the classes.

```
[edit]
user@host# set system login class admin1 logical-system LS1
user@host# set system login class admin2 logical-system LS2
```

3. Assign permissions to the login classes.

```
[edit]
user@host# set system login class admin1 permissions all
user@host# set system login class admin2 permissions view
```

4. Assign users to the login classes.

```
[edit]
user@host# set system login user LS1Admin class admin1
user@host# set system login user LS2Admin class admin2
```

5. If you are done configuring the device, commit the configuration.

```
[edit]
user@host# commit
```

Verification

To verify that the configuration is working properly, issue the **show cli authorization** command to view permissions for the current user.

- Related Documentation**
- [Introduction to Logical Systems on page 3](#)

CHAPTER 3

Interfaces

- [Examples: Configuring Logical System Interfaces on page 23](#)

Examples: Configuring Logical System Interfaces

- [Understanding Interfaces on page 23](#)
- [Example: Creating an Interface on a Logical System on page 24](#)
- [Example: Connecting a Logical System to a Physical Router on page 26](#)
- [Example: Connecting Logical Systems Within the Same Router Using Logical Tunnel Interfaces on page 28](#)
- [Example: Connecting Logical Systems Within the Same Router Using Logical Tunnel Interfaces on MX Series Routers on page 32](#)

Understanding Interfaces

Interfaces act as a doorway through which traffic enters and exits a device. Juniper Networks devices support a variety of interface types:

- Network interfaces—Networking interfaces primarily provide traffic connectivity.
- Services interfaces—Services interfaces manipulate traffic before it is delivered to its destination.
- Special interfaces—Special interfaces include management interfaces, the loopback interface, and the discard interface.

Each type of interface uses a particular medium to transmit data. The physical wires and Data Link Layer protocols used by a medium determine how traffic is sent. To configure and monitor interfaces, you need to understand their media characteristics, as well as physical and logical properties such as IP addressing, link-layer protocols, and link encapsulation.



NOTE: Most interfaces are configurable, but some internally generated interfaces are not configurable.

Example: Creating an Interface on a Logical System

This example shows how to create an interface on a logical system.

- [Requirements on page 24](#)
- [Overview on page 24](#)
- [Configuration on page 25](#)
- [Verification on page 26](#)

Requirements

For the interface on the logical system to have connectivity, the corresponding physical interface must be administratively up, and the physical link must be up. You can verify the status of the physical interface by running the **show interfaces terse** command.

Overview

In logical systems, you must treat each interface like a point-to-point connection because you can only connect one logical tunnel interface to another at any given time. Also, you must select an interface encapsulation type, specify a DLCI number or VLAN identifier, configure a corresponding protocol family, and set the logical interface unit number of the peering **lt** interface.

To configure the interface encapsulation type, include the **dlci**, **encapsulation**, **family**, **peer-unit**, and **vlan-id** statements at the following hierarchy levels:

- M Series, MX Series, or T Series router (master administrator only)—**[edit interfaces lt-fpc/pic/O unit unit-number]**
- Logical system—**[edit logical-systems logical-system-name interfaces lt-fpc/pic/O unit unit-number]**

```
[edit]
logical-systems logical-system-name {
  interfaces {
    lt-fpc/pic/O {
      unit unit-number {
        encapsulation (ethernet | ethernet-ccc | ethernet-vpls | frame-relay |
          frame-relay-ccc | vlan | vlan-ccc | vlan-vpls);
        peer-unit number; # The logical unit number of the peering lt interface.
        dlci dlc-number;
        vlan-id vlan-number;
        family (ccc | inet | inet6 | iso | mpls | tcc);
      }
    }
  }
}
```



NOTE: When you configure IPv6 addresses on a logical tunnel interface, you must configure unique IPv6 link-local addresses for any logical interfaces that peer with one another. To configure a link-local address, you must be the master administrator. Include a second IPv6 address with the address statement at the `[edit interfaces lt-fpc/pic/port unit unit-number family inet6]` hierarchy level. Link-local addresses typically begin with the numbers fe80 (such as fe80::1111:1/64).

In this example, you create the **fe-1/1/3** physical interface on the main router. You can also add values for properties that you need to configure on the physical interface, such as physical encapsulation, VLAN tagging (enabling), and link speed.

The example then shows how to assign logical interfaces to a logical system. Once you do this, the logical interfaces are considered part of the logical system.

Any logical interface unit can only be assigned to one system, including the main router. For example, if you configure logical unit 3 in the main router, you cannot configure logical unit 3 in a logical system.

In this example, you create logical unit 0 on Logical System LS1. You can also add values for properties that you need to configure on the logical interface, such as logical interface encapsulation, VLAN ID number, and protocol family.

Configuration

CLI Quick Configuration

To quickly configure this example, copy the following commands, paste them into a text file, remove any line breaks, change any details necessary to match your network configuration, and then copy and paste the commands into the CLI at the **[edit]** hierarchy level.

```
set interfaces fe-1/1/3 description "main router interface"
set logical-systems LS1 interfaces fe-1/1/3 unit 0 description "LS1 interface"
set logical-systems LS1 interfaces fe-1/1/3 unit 0 family inet address 10.11.2.2/24
```

Step-by-Step Procedure

The following example requires you to navigate various levels in the configuration hierarchy. For information about navigating the CLI, see Using the CLI Editor in Configuration Mode in the CLI User Guide.

To configure an interface on a logical system:

1. As the master administrator, configure the physical interface on the main router.

```
[edit]
user@host# set interfaces fe-1/1/3 description "main router interface"
```

2. Create the logical system interface on the logical unit.

```
[edit]
user@host# set logical-systems LS1 interfaces fe-1/1/3 unit 0 description "LS1
interface"
user@host# set logical-systems LS1 interfaces fe-1/1/3 unit 0 family inet address
10.11.2.2/24
```

- If you are done configuring the device, commit the configuration.

```
[edit]
user@host# commit
```

Verification

To verify that the configuration is working properly, issue the **show interfaces** command.

Example: Connecting a Logical System to a Physical Router

This example shows how to configure an interface on a logical system to connect to a separate router. The separate router can be a physical router or a logical system on a physical router.

- [Requirements on page 26](#)
- [Overview on page 26](#)
- [Configuration on page 26](#)
- [Verification on page 27](#)

Requirements

PICs must be installed on the two routers.

Overview

In this example, Logical System LS1 is configured on Router R1. The Logical System LS1 has a direct connection to Router R2.

[Figure 6 on page 26](#) shows the topology used in this example.

Figure 6: Logical System Connected to a Physical Router

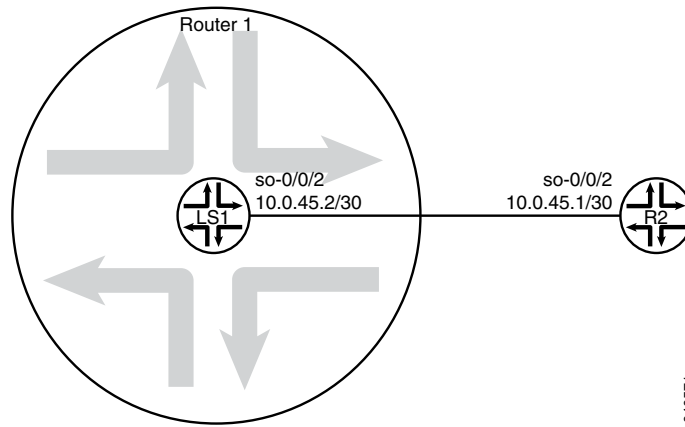

Configuration

CLI Quick Configuration To quickly configure this example, copy the following commands, paste them into a text file, remove any line breaks, change any details necessary to match your network

configuration, and then copy and paste the commands into the CLI at the **[edit]** hierarchy level.

Router R1 `set interfaces so-0/0/2 description "main router interface to R2"`
 `set logical-systems LS1 interfaces so-0/0/2 unit 0 description LS1->R2`
 `set logical-systems LS1 interfaces so-0/0/2 unit 0 family inet address 10.0.45.2/30`

Device R2 `set interfaces so-0/0/2 description R2->LS1`
 `set interfaces so-0/0/2 unit 0 family inet address 10.0.45.1/30`

Step-by-Step Procedure The following example requires you to navigate various levels in the configuration hierarchy. For information about navigating the CLI, see Using the CLI Editor in Configuration Mode in the CLI User Guide.

To connect a logical system to a physical router:

1. On Router R1, configure the interface.

```
[edit]
user@R1# set interfaces so-0/0/2 description "main router interface to R2"
```

2. On Router R1, configure the Logical System LS1 interface.

```
[edit]
user@R1# set logical-systems LS1 interfaces so-0/0/2 unit 0 description LS1->R2
user@R1# set logical-systems LS1 interfaces so-0/0/2 unit 0 family inet address
10.0.45.2/30
```

3. On Device R2, configure the interface to Logical System LS1.

```
[edit]
user@R2# set interfaces so-0/0/2 description R2->LS1
user@R2# set interfaces so-0/0/2 unit 0 family inet address 10.0.45.1/30
```

4. If you are done configuring the devices, commit the configurations.

```
[edit]
user@host# commit
```

Verification

Confirm that the configuration is working properly.

Verifying Connectivity

Purpose Make sure that the devices can ping each other.

```
user@R2> ping 10.0.45.2
PING 10.0.45.2 (10.0.45.2): 56 data bytes
64 bytes from 10.0.45.2: icmp_seq=0 ttl=64 time=3.910 ms
64 bytes from 10.0.45.2: icmp_seq=1 ttl=64 time=3.559 ms
64 bytes from 10.0.45.2: icmp_seq=2 ttl=64 time=3.503 ms
```

```
user@R1> set cli logical-system LS1
Logical system: LS1
```

```
user@R1:LS1> ping 10.0.45.1
```

```
PING 10.0.45.1 (10.0.45.1): 56 data bytes
64 bytes from 10.0.45.1: icmp_seq=0 ttl=64 time=1.217 ms
64 bytes from 10.0.45.1: icmp_seq=1 ttl=64 time=1.183 ms
64 bytes from 10.0.45.1: icmp_seq=2 ttl=64 time=1.121 ms
```

Example: Connecting Logical Systems Within the Same Router Using Logical Tunnel Interfaces

This example shows how to configure logical tunnel interfaces to connect two logical systems that are configured in a single router.

- [Requirements on page 28](#)
- [Overview on page 29](#)
- [Configuration on page 30](#)
- [Verification on page 31](#)

Requirements

On M Series and T Series routers, you can create a logical tunnel interface if you have a Tunnel Services PIC installed on an Enhanced FPC in your routing platform.

On M40e routers, you can create a logical tunnel interface if you have a Tunnel Services PIC. (An Enhanced FPC is not required.)

On an M7i router, logical tunnel interfaces can be created by using the integrated Adaptive Services Module.

On an MX Series router, the master administrator can configure logical tunnel interfaces by including the `tunnel-services` statement at the `[edit chassis fpc slot-number pic number]` hierarchy level.

Overview

To connect two logical systems, you configure a logical tunnel interface on both logical systems. Then you configure a peer relationship between the logical tunnel interfaces, thus creating a point-to-point connection. Logical tunnel interfaces behave like regular interfaces. You can configure them with Ethernet, Frame Relay, or another encapsulation type. You can also configure routing protocols across them. In effect, the logical tunnel (**lt**) interfaces connect two logical systems within the same router. The two logical systems do not share routing tables. This means that you can run dynamic routing protocols between different logical systems within the same router.

You must treat each interface like a point-to-point connection because you can only connect one logical tunnel interface to another at any given time. Also, you must select an interface encapsulation type, configure a corresponding protocol family, and set the logical interface unit number of the peering **lt** interface.

In this example, the logical tunnel interfaces are configured to behave as Ethernet interfaces with the **encapsulation ethernet** statement. The IS-IS Protocol is enabled on the logical tunnel interfaces with the **family iso** statement.

When configuring logical tunnel interfaces, note the following:

- The peering logical interfaces must have the same physical **lt** interface name. For example, a logical unit on **lt-0/1/0** cannot peer with a logical unit on **lt-0/0/10**. The FPC, PIC, and port numbers must match.
- The peering logical interfaces must be derived from the same PIC or module.
- You can configure only one peer unit for each logical interface. For example, unit 0 cannot peer with both unit 1 and unit 2.
- Logical tunnels are not supported with Adaptive Services, MultiServices, or Link Services PICs, but they are supported on the Adaptive Services Module on M7i routers.

Figure 7 on page 29 shows the topology used in this example.

Figure 7: Connecting Two Logical Systems

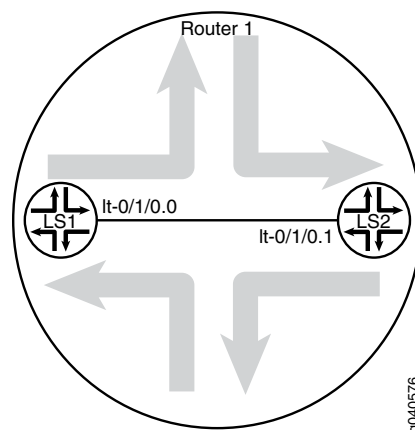

Configuration

CLI Quick Configuration To quickly configure this example, copy the following commands, paste them into a text file, remove any line breaks, change any details necessary to match your network configuration, and then copy and paste the commands into the CLI at the **[edit]** hierarchy level.

```
set logical-systems LS1 interfaces lt-0/1/0 unit 0 description LS1->LS2
set logical-systems LS1 interfaces lt-0/1/0 unit 0 encapsulation ethernet
set logical-systems LS1 interfaces lt-0/1/0 unit 0 peer-unit 1
set logical-systems LS1 interfaces lt-0/1/0 unit 0 family inet address 10.0.8.13/30
set logical-systems LS1 interfaces lt-0/1/0 unit 0 family iso
set logical-systems LS2 interfaces lt-0/1/0 unit 1 description LS2->LS1
set logical-systems LS2 interfaces lt-0/1/0 unit 1 encapsulation ethernet
set logical-systems LS2 interfaces lt-0/1/0 unit 1 peer-unit 0
set logical-systems LS2 interfaces lt-0/1/0 unit 1 family inet address 10.0.8.14/30
set logical-systems LS2 interfaces lt-0/1/0 unit 1 family iso
```

Step-by-Step Procedure The following example requires you to navigate various levels in the configuration hierarchy. For information about navigating the CLI, see Using the CLI Editor in Configuration Mode in the CLI User Guide.

To connect logical system interfaces:

1. Run the **show interfaces terse** command to verify that the router has a logical tunnel (lt) interface.

```
user@host> show interfaces terse
Interface           Admin Link Proto  Local          Remote
so-0/0/0            up    down
so-0/0/1            up    down
so-0/0/2            up    down
so-0/0/3            up    down
gr-0/1/0            up    up
ip-0/1/0            up    up
lt-0/1/0            up    up
...
```

2. Configure the logical tunnel interface on Logical System LS1.

```
[edit]
user@host# set logical-systems LS1 interfaces lt-0/1/0 unit 0 description LS1->LS2
user@host# set logical-systems LS1 interfaces lt-0/1/0 unit 0 encapsulation ethernet
user@host# set logical-systems LS1 interfaces lt-0/1/0 unit 0 peer-unit 1
user@host# set logical-systems LS1 interfaces lt-0/1/0 unit 0 family inet address
10.0.8.13/30
user@host# set logical-systems LS1 interfaces lt-0/1/0 unit 0 family iso
```

3. Configure the logical tunnel interface on Logical System LS2.

```
[edit]
user@host# set logical-systems LS2 interfaces lt-0/1/0 unit 1 description LS2->LS1
user@host# set logical-systems LS2 interfaces lt-0/1/0 unit 1 encapsulation ethernet
user@host# set logical-systems LS2 interfaces lt-0/1/0 unit 1 peer-unit 0
user@host# set logical-systems LS2 interfaces lt-0/1/0 unit 1 family inet address
10.0.8.14/30
user@host# set logical-systems LS2 interfaces lt-0/1/0 unit 1 family iso
```

- If you are done configuring the device, commit the configuration.

```
[edit]
user@host# commit
```

Verification

Confirm that the configuration is working properly.

- [Verifying That the Logical Systems Are Up on page 31](#)
- [Verifying Connectivity Between the Logical Systems on page 31](#)

Verifying That the Logical Systems Are Up

Purpose Make sure that the interfaces are properly configured.

```

Action user@host> show interfaces terse
Interface      Admin Link Proto  Local      Remote
so-0/0/0       up   down
so-0/0/1       up   down
so-0/0/2       up   down
so-0/0/3       up   down
gr-0/1/0       up   up
ip-0/1/0       up   up
lt-0/1/0       up   up
lt-0/1/0.0     up   up   inet   10.0.8.13/30
               up   up   iso
lt-0/1/0.1     up   up   inet   10.0.8.14/30
               up   up   iso
...

```

Verifying Connectivity Between the Logical Systems

Purpose Make sure that the network address appears as directly connected.

```

Action user@host> show route logical-system all
Logical-system: LS1

inet.0: 2 destinations, 2 routes (2 active, 0 holddown, 0 hidden)
+ = Active Route, - = Last Active, * = Both

10.0.8.12/30    *[Direct/0] 00:00:34
                > via lt-0/1/0.0
10.0.8.13/32    *[Local/0] 00:00:34
                Local via lt-0/1/0.0
-----

Logical-system: LS2

inet.0: 2 destinations, 2 routes (2 active, 0 holddown, 0 hidden)
+ = Active Route, - = Last Active, * = Both

10.0.8.12/30    *[Direct/0] 00:00:34
                > via lt-0/1/0.1
10.0.8.14/32    *[Local/0] 00:00:34
                Local via lt-0/1/0.1
...

```

Example: Connecting Logical Systems Within the Same Router Using Logical Tunnel Interfaces on MX Series Routers

This example shows how to configure logical tunnel interfaces to connect two logical systems that are configured in a single MX Series 3D Universal Edge Router.

- [Requirements on page 32](#)
- [Overview on page 32](#)
- [Configuration on page 33](#)
- [Verification on page 34](#)

Requirements

The MX Series router chassis must have a DPC, MPC, or MIC installed and in the online state.

Overview

To connect two logical systems, you configure a logical tunnel interface on both logical systems. Then you configure a peer relationship between the logical tunnel interfaces, thus creating a point-to-point connection. Logical tunnel interfaces behave like regular interfaces. You can configure them with Ethernet, Frame Relay, or another encapsulation type. You can also configure routing protocols across them. In effect, the logical tunnel (**lt**) interfaces connect two logical systems within the same router. The two logical systems do not share routing tables. This means that you can run dynamic routing protocols between different logical systems within the same router.

You must treat each interface like a point-to-point connection because you can only connect one logical tunnel interface to another at any given time. Also, you must select an interface encapsulation type, configure a corresponding protocol family, and set the logical interface unit number of the peering **lt** interface.

In this example, the logical tunnel interfaces are configured to behave as Ethernet interfaces with the **encapsulation ethernet** statement. The IS-IS Protocol is enabled on the logical tunnel interfaces with the **family iso** statement.

When configuring logical tunnel interfaces, note the following:

- The peering logical interfaces must have the same **lt** interface name. For example, a logical unit on **lt-0/1/0** cannot peer with a logical unit on **lt-0/0/10**. The FPC (DPC, MPC, or MIC), PIC, and port numbers must match.
- The peering logical interfaces must be derived from the same module.
- You can configure only one peer unit for each logical interface. For example, unit 0 cannot peer with both unit 1 and unit 2.

[Figure 8 on page 33](#) shows the topology used in this example.

Figure 8: Connecting Two Logical Systems

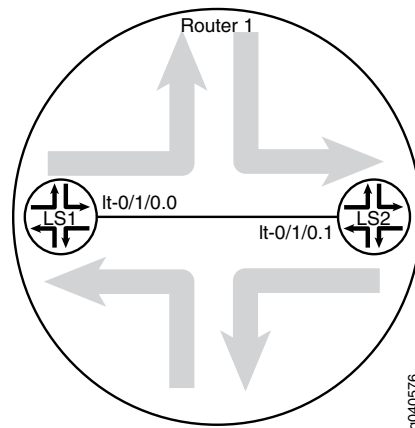

Configuration

CLI Quick Configuration

To quickly configure this example, copy the following commands, paste them into a text file, remove any line breaks, change any details necessary to match your network configuration, and then copy and paste the commands into the CLI at the **[edit]** hierarchy level.

```
set chassis fpc 0 pic 1 tunnel-services bandwidth 1g
set logical-systems LS1 interfaces lt-0/1/0 unit 0 description LS1->LS2
set logical-systems LS1 interfaces lt-0/1/0 unit 0 encapsulation ethernet
set logical-systems LS1 interfaces lt-0/1/0 unit 0 peer-unit 1
set logical-systems LS1 interfaces lt-0/1/0 unit 0 family inet address 10.0.8.13/30
set logical-systems LS1 interfaces lt-0/1/0 unit 0 family iso
set logical-systems LS2 interfaces lt-0/1/0 unit 1 description LS2->LS1
set logical-systems LS2 interfaces lt-0/1/0 unit 1 encapsulation ethernet
set logical-systems LS2 interfaces lt-0/1/0 unit 1 peer-unit 0
set logical-systems LS2 interfaces lt-0/1/0 unit 1 family inet address 10.0.8.14/30
set logical-systems LS2 interfaces lt-0/1/0 unit 1 family iso
```

Step-by-Step Procedure

The following example requires you to navigate various levels in the configuration hierarchy. For information about navigating the CLI, see *Using the CLI Editor in Configuration Mode in the CLI User Guide*.

To connect logical system interfaces:

1. Run the **show chassis fpc** command to verify that the router has a DPC, MPC, or MIC installed and is in the online state.

```
user@host> show chassis fpc
```

Slot	State	Temp (C)	CPU Utilization (%)		Memory Utilization (%)		
			Total	Interrupt	DRAM (MB)	Heap	Buffer
0	Online	31	4	0	1024	14	21
1	Empty						
2	Empty						

This output shows that slot 1 and slot 2 are empty. Slot 0 is online.

2. Configure FPC slot 0 to support logical tunnel (**lt**) interfaces.

[edit]

```
user@host# set chassis fpc 0 pic 1 tunnel-services bandwidth 1g
```

This command creates several tunnel interface types, including **gr**, **ip**, and **lt**. For this example, the important one is the logical tunnel (**lt**) interface.

3. Commit the configuration.

```
[edit]
user@host# commit
```

4. Run the **show interfaces terse** command to verify that the router has a logical tunnel (**lt**) interface.

```
user@host> show interfaces terse
Interface           Admin Link Proto   Local          Remote
...
gr-0/1/0            up    up
ip-0/1/0            up    up
lt-0/1/0            up    up
...
```

5. Configure the logical tunnel interface on Logical System LS1.

```
[edit]
user@host# set logical-systems LS1 interfaces lt-0/1/0 unit 0 description LS1->LS2
user@host# set logical-systems LS1 interfaces lt-0/1/0 unit 0 encapsulation ethernet
user@host# set logical-systems LS1 interfaces lt-0/1/0 unit 0 peer-unit 1
user@host# set logical-systems LS1 interfaces lt-0/1/0 unit 0 family inet address
  10.0.8.13/30
user@host# set logical-systems LS1 interfaces lt-0/1/0 unit 0 family iso
```

6. Configure the logical tunnel interface on Logical System LS2.

```
[edit]
user@host# set logical-systems LS2 interfaces lt-0/1/0 unit 1 description LS2->LS1
user@host# set logical-systems LS2 interfaces lt-0/1/0 unit 1 encapsulation ethernet
user@host# set logical-systems LS2 interfaces lt-0/1/0 unit 1 peer-unit 0
user@host# set logical-systems LS2 interfaces lt-0/1/0 unit 1 family inet address
  10.0.8.14/30
user@host# set logical-systems LS2 interfaces lt-0/1/0 unit 1 family iso
```

7. If you are done configuring the device, commit the configuration.

```
[edit]
user@host# commit
```

Verification

Confirm that the configuration is working properly.

- [Verifying That the Logical Systems Are Up on page 34](#)
- [Verifying Connectivity Between the Logical Systems on page 35](#)

Verifying That the Logical Systems Are Up

Purpose Make sure that the interfaces are properly configured.

```

Action user@host> show interfaces terse
Interface      Admin Link Proto  Local      Remote
so-0/0/0       up   down
so-0/0/1       up   down
so-0/0/2       up   down
so-0/0/3       up   down
gr-0/1/0       up   up
ip-0/1/0       up   up
lt-0/1/0       up   up
lt-0/1/0.0     up   up   inet   10.0.8.13/30
               up   up   iso
lt-0/1/0.1     up   up   inet   10.0.8.14/30
               up   up   iso
...

```

Verifying Connectivity Between the Logical Systems

Purpose Make sure that the network address appears as directly connected.

```

Action user@host> show route logical-system all
logical-system: LS1

inet.0: 2 destinations, 2 routes (2 active, 0 holddown, 0 hidden)
+ = Active Route, - = Last Active, * = Both

10.0.8.12/30    *[Direct/0] 00:00:34
                > via lt-0/1/0.0
10.0.8.13/32    *[Local/0] 00:00:34
                Local via lt-0/1/0.0
-----

logical-system: LS2

inet.0: 2 destinations, 2 routes (2 active, 0 holddown, 0 hidden)
+ = Active Route, - = Last Active, * = Both

10.0.8.12/30    *[Direct/0] 00:00:34
                > via lt-0/1/0.1
10.0.8.14/32    *[Local/0] 00:00:34
                Local via lt-0/1/0.1
...

```

Related Documentation

- [Introduction to Logical Systems on page 3](#)

CHAPTER 4

Static Routing

- [Example: Configuring Static Routing on Logical Systems on page 37](#)

Example: Configuring Static Routing on Logical Systems

- [Understanding Basic Static Routing on page 37](#)
- [Example: Configuring Static Routes Between Logical Systems Within the Same Router on page 37](#)

Understanding Basic Static Routing

Routes that are permanent fixtures in the routing and forwarding tables are often configured as static routes. These routes generally do not change, and often include only one or very few paths to the destination.

To create a static route in the routing table, you must, at minimum, define the route as static and associate a next-hop address with it. The static route in the routing table is inserted into the forwarding table when the next-hop address is reachable. All traffic destined for the static route is transmitted to the next-hop address for transit.

You can specify options that define additional information about static routes that is included with the route when it is installed in the routing table. All static options are optional.

Example: Configuring Static Routes Between Logical Systems Within the Same Router

This example shows how to configure static routes between logical systems. The logical systems are configured in a single physical router and are connected by logical tunnel interfaces.

- [Requirements on page 38](#)
- [Overview on page 38](#)
- [Configuration on page 38](#)
- [Verification on page 41](#)

Requirements

You must connect the logical systems by using logical tunnel (lt) interfaces. See “[Example: Connecting Logical Systems Within the Same Router Using Logical Tunnel Interfaces](#)” on page 28.

Overview

A static route is a hard-coded path in the device that specifies how the route gets to a certain subnet by using a certain path. Routers that are connected to stub networks are often configured to use static routes. A *stub network* is a network with no knowledge of other networks. Stub networks send non-local traffic by way of a single path, with the network aware only of a default route to non-local destinations. In this example, you configure Logical System LS1 with a static route to the 10.10.10.0/30 network and define the next-hop address as 192.168.10.2. You also configure Logical System LS1 with a static route to the 192.168.10.0/30 network and define a next-hop address of 10.10.10.1.

Figure 9 on page 38 shows the sample network.

Figure 9: Static Routes Between Logical Systems

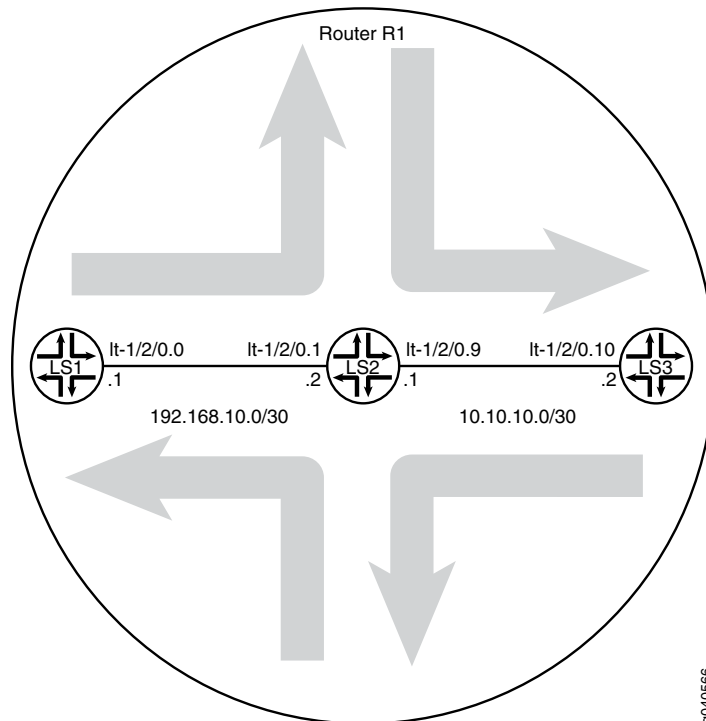

Configuration

CLI Quick Configuration

To quickly configure this example, copy the following commands, paste them into a text file, remove any line breaks, change any details necessary to match your network configuration, and then copy and paste the commands into the CLI at the **[edit]** hierarchy level.

```
set logical-systems LS1 interfaces lt-1/2/0 unit 0 description LS1->LS2
```

```

set logical-systems LS1 interfaces lt-1/2/0 unit 0 encapsulation ethernet
set logical-systems LS1 interfaces lt-1/2/0 unit 0 peer-unit 1
set logical-systems LS1 interfaces lt-1/2/0 unit 0 family inet address 192.168.10.1/30
set logical-systems LS2 interfaces lt-1/2/0 unit 1 description LS2->LS1
set logical-systems LS2 interfaces lt-1/2/0 unit 1 encapsulation ethernet
set logical-systems LS2 interfaces lt-1/2/0 unit 1 peer-unit 0
set logical-systems LS2 interfaces lt-1/2/0 unit 1 family inet address 192.168.10.2/30
set logical-systems LS2 interfaces lt-1/2/0 unit 9 description LS2->LS3
set logical-systems LS2 interfaces lt-1/2/0 unit 9 encapsulation ethernet
set logical-systems LS2 interfaces lt-1/2/0 unit 9 peer-unit 10
set logical-systems LS2 interfaces lt-1/2/0 unit 9 family inet address 10.10.10.1/30
set logical-systems LS3 interfaces lt-1/2/0 unit 10 description LS3->LS2
set logical-systems LS3 interfaces lt-1/2/0 unit 10 encapsulation ethernet
set logical-systems LS3 interfaces lt-1/2/0 unit 10 peer-unit 9
set logical-systems LS3 interfaces lt-1/2/0 unit 10 family inet address 10.10.10.2/30
set logical-systems LS1 routing-options static route 10.10.10.0/30 next-hop 192.168.10.2
set logical-systems LS3 routing-options static route 192.168.10.0/30 next-hop 10.10.10.1

```

Step-by-Step Procedure

The following example requires you to navigate various levels in the configuration hierarchy. For information about navigating the CLI, see *Using the CLI Editor in Configuration Mode in the CLI User Guide*.

To configure static routes between logical systems:

1. Run the **show interfaces terse** command to verify that the router has a logical tunnel (lt) interface.

```

user@host> show interfaces terse
Interface           Admin Link Proto  Local          Remote
so-0/0/0            up    down
so-0/0/1            up    down
so-0/0/2            up    down
so-0/0/3            up    down
gr-1/2/0            up    up
ip-1/2/0            up    up
lt-1/2/0            up    up
...

```

2. Configure the logical tunnel interface on Logical System LS1 connecting to Logical System LS2.

```

[edit]
user@host# set logical-systems LS1 interfaces lt-1/2/0 unit 0 description LS1->LS2
user@host# set logical-systems LS1 interfaces lt-1/2/0 unit 0 encapsulation ethernet
user@host# set logical-systems LS1 interfaces lt-1/2/0 unit 0 peer-unit 1
user@host# set logical-systems LS1 interfaces lt-1/2/0 unit 0 family inet address
192.168.10.1/30

```

3. Configure the logical tunnel interface on Logical System LS2 connecting to Logical System LS1.

```

[edit]
user@host# set logical-systems LS2 interfaces lt-1/2/0 unit 1 description LS2->LS1
user@host# set logical-systems LS2 interfaces lt-1/2/0 unit 1 encapsulation ethernet
user@host# set logical-systems LS2 interfaces lt-1/2/0 unit 1 peer-unit 0
user@host# set logical-systems LS2 interfaces lt-1/2/0 unit 1 family inet address
192.168.10.2/30

```

- Configure the logical tunnel interface on Logical System LS2 connecting to Logical System LS3.

```
[edit]
user@host# set logical-systems LS2 interfaces lt-1/2/0 unit 9 description LS2->LS3
user@host# set logical-systems LS2 interfaces lt-1/2/0 unit 9 encapsulation ethernet
user@host# set logical-systems LS2 interfaces lt-1/2/0 unit 9 peer-unit 10
user@host# set logical-systems LS2 interfaces lt-1/2/0 unit 9 family inet address
10.10.10.1/30
```

- Configure the logical tunnel interface on Logical System LS3 connecting to Logical System LS2.

```
[edit]
user@host# set logical-systems LS3 interfaces lt-1/2/0 unit 10 description LS3->LS2
user@host# set logical-systems LS3 interfaces lt-1/2/0 unit 10 encapsulation
ethernet
user@host# set logical-systems LS3 interfaces lt-1/2/0 unit 10 peer-unit 9
user@host# set logical-systems LS3 interfaces lt-1/2/0 unit 10 family inet address
10.10.10.2/30
```

- Configure the static route on Logical System LS1 connecting to the 10.10.10.0/30 network.

```
[edit]
user@host# set logical-systems LS1 routing-options static route 10.10.10.0/30
next-hop 192.168.10.2
```

- Configure the static route on Logical System LS3 connecting to the 192.168.10.0/30 network.

```
[edit]
user@host# set logical-systems LS3 routing-options static route 192.168.10.0/30
next-hop 10.10.10.1
```

- If you are done configuring the device, commit the configuration.

```
[edit]
user@host# commit
```

Confirm your configuration by issuing the **show logical-systems** command. If the output does not display the intended configuration, repeat the instructions in this example to correct the configuration.

```
user@host# show logical-systems
LS1 {
  interfaces {
    lt-1/2/0 {
      unit 0 {
        description LS1->LS2;
        encapsulation ethernet;
        peer-unit 1;
        family inet {
          address 192.168.10.1/30;
        }
      }
    }
  }
}
```



```

}
routing-options {
  static {
    route 10.10.10.0/30 next-hop 192.168.10.2;
  }
}
}
LS2 {
  interfaces {
    lt-1/2/0 {
      unit 1 {
        description LS2->LS1;
        encapsulation ethernet;
        peer-unit 0;
        family inet {
          address 192.168.10.2/30;
        }
      }
    }
    unit 9 {
      description LS2->LS3;
      encapsulation ethernet;
      peer-unit 10;
      family inet {
        address 10.10.10.1/30;
      }
    }
  }
}
}
LS3 {
  interfaces {
    lt-1/2/0 {
      unit 10 {
        description LS3->LS2;
        encapsulation ethernet;
        peer-unit 9;
        family inet {
          address 10.10.10.2/30;
        }
      }
    }
  }
  routing-options {
    static {
      route 192.168.10.0/30 next-hop 10.10.10.1;
    }
  }
}
}

```

Verification

Confirm that the configuration is working properly.

- [Verifying That the Logical Systems Are Up on page 42](#)
- [Verifying Connectivity Between the Logical Systems on page 42](#)

Verifying That the Logical Systems Are Up

Purpose Make sure that the interfaces are properly configured.

```

Action user@host> show interfaces terse
Interface          Admin Link Proto  Local          Remote
...
lt-1/2/0           up    up
lt-1/2/0.0         up    up    inet    192.168.10.1/30
lt-1/2/0.1         up    up    inet    192.168.10.2/30
lt-1/2/0.9         up    up    inet    10.10.10.1/30
lt-1/2/0.10        up    up    inet    10.10.10.2/30
...

```

Verifying Connectivity Between the Logical Systems

Purpose Make sure that the static routes appear in the routing tables of Logical Systems LS1 and LS3. Also, make sure that the logical systems can ping each other.

```

Action user@host> show route logical-system LS1
inet.0: 3 destinations, 3 routes (3 active, 0 holddown, 0 hidden)
+ = Active Route, - = Last Active, * = Both

10.10.10.0/30      *[Static/5] 18:43:25
                  > to 192.168.10.2 via lt-1/2/0.0
192.168.10.0/30   *[Direct/0] 18:43:25
                  > via lt-1/2/0.0
192.168.10.1/32   *[Local/0] 18:43:25
                  Local via lt-1/2/0.0

```

```

user@host> show route logical-system LS3
inet.0: 3 destinations, 3 routes (3 active, 0 holddown, 0 hidden)
+ = Active Route, - = Last Active, * = Both

10.10.10.0/30     *[Direct/0] 23:11:21
                  > via lt-1/2/0.10
10.10.10.2/32     *[Local/0] 23:11:21
                  Local via lt-1/2/0.10
192.168.10.0/30   *[Static/5] 00:23:31
                  > to 10.10.10.1 via lt-1/2/0.10

```

```

From LS1, Ping LS3 user@host> set cli logical-system LS1

user@host:LS1> ping 10.10.10.2
PING 10.10.10.2 (10.10.10.2): 56 data bytes
64 bytes from 10.10.10.2: icmp_seq=0 ttl=63 time=1.263 ms
64 bytes from 10.10.10.2: icmp_seq=1 ttl=63 time=1.086 ms
64 bytes from 10.10.10.2: icmp_seq=2 ttl=63 time=1.077 ms

```

```

From LS3, Ping LS1 user@host> set cli logical-system LS3

user@host:LS3> ping 192.168.10.1
PING 192.168.10.1 (192.168.10.1): 56 data bytes
64 bytes from 192.168.10.1: icmp_seq=0 ttl=63 time=10.781 ms
64 bytes from 192.168.10.1: icmp_seq=1 ttl=63 time=1.167 ms
64 bytes from 192.168.10.1: icmp_seq=2 ttl=63 time=1.152 ms

```

Related Documentation • [Introduction to Logical Systems on page 3](#)

CHAPTER 5

Firewall Filters

- Examples: Configuring Standard Firewall Filters on Logical Systems on page 45

Examples: Configuring Standard Firewall Filters on Logical Systems

- Understanding How to Use Standard Firewall Filters on page 45
- Example: Configuring a Stateless Firewall Filter to Protect a Logical System Against ICMP Floods on page 46
- Example: Configuring Filter-Based Forwarding on Logical Systems on page 49

Understanding How to Use Standard Firewall Filters

This topic covers the following information:

- Using Standard Firewall Filters to Affect Local Packets on page 45
- Using Standard Firewall Filters to Affect Data Packets on page 46

Using Standard Firewall Filters to Affect Local Packets

On a router, you can configure one physical loopback interface, **lo0**, and one or more addresses on the interface. The loopback interface is the interface to the Routing Engine, which runs and monitors all the control protocols. The loopback interface carries local packets only. Standard firewall filters applied to the loopback interface affect the local packets destined for or transmitted from the Routing Engine.



NOTE: When you create an additional loopback interface, it is important to apply a filter to it so the Routing Engine is protected. We recommend that when you apply a filter to the loopback interface, you include the `apply-groups` statement. Doing so ensures that the filter is automatically inherited on every loopback interface, including `lo0` and other loopback interfaces.

Trusted Sources

The typical use of a standard stateless firewall filter is to protect the Routing Engine processes and resources from malicious or untrusted packets. To protect the processes and resources owned by the Routing Engine, you can use a standard stateless firewall filter that specifies which protocols and services, or applications, are allowed to reach the Routing Engine. Applying this type of filter to the loopback interface ensures that the

local packets are from a trusted source and protects the processes running on the Routing Engine from an external attack.

Flood Prevention

You can create standard stateless firewall filters that limit certain TCP and ICMP traffic destined for the Routing Engine. A router without this kind of protection is vulnerable to TCP and ICMP flood attacks, which are also called denial-of-service (DoS) attacks. For example:

- A TCP flood attack of SYN packets initiating connection requests can overwhelm the device until it can no longer process legitimate connection requests, resulting in denial of service.
- An ICMP flood can overload the device with so many echo requests (ping requests) that it expends all its resources responding and can no longer process valid network traffic, also resulting in denial of service.

Applying the appropriate firewall filters to the Routing Engine protects against these types of attacks.

Using Standard Firewall Filters to Affect Data Packets

Standard firewall filters that you apply to your router's transit interfaces evaluate only the user data packets that transit the router from one interface directly to another as they are being forwarded from a source to a destination. To protect the network as a whole from unauthorized access and other threats at specific interfaces, you can apply firewall filters router transit interfaces .

Example: Configuring a Stateless Firewall Filter to Protect a Logical System Against ICMP Floods

This example shows how to configure a stateless firewall filter that protects against ICMP denial-of-service attacks on a logical system.

- [Requirements on page 46](#)
- [Overview on page 46](#)
- [Configuration on page 47](#)
- [Verification on page 49](#)

Requirements

In this example, no special configuration beyond device initialization is required.

Overview

This example shows a stateless firewall filter called protect-RE that polices ICMP packets. The **icmp-policer** limits the traffic rate of the ICMP packets to 1,000,000 bps and the burst size to 15,000 bytes. Packets that exceed the traffic rate are discarded.

The policer is incorporated into the action of a filter term called **icmp-term**.

In this example, a ping is sent from a directly connected physical router to the interface configured on the logical system. The logical system accepts the ICMP packets if they are received at a rate of up to 1 Mbps (bandwidth-limit). The logical system drops all ICMP packets when this rate is exceeded. The **burst-size-limit** statement accepts traffic bursts up to 15 Kbps. If bursts exceed this limit, all packets are dropped. When the flow rate subsides, ICMP packets are again accepted.

Figure 10 on page 47 shows the topology used in this example.

Figure 10: Logical System with a Stateless Firewall

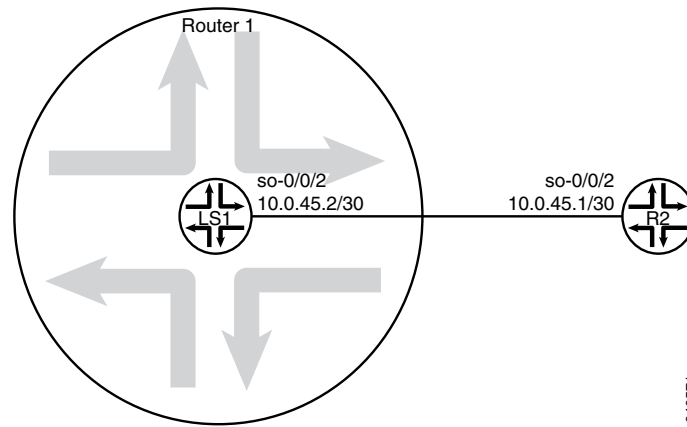

Configuration

CLI Quick Configuration

To quickly configure this example, copy the following commands, paste them into a text file, remove any line breaks, change any details necessary to match your network configuration, and then copy and paste the commands into the CLI at the [edit] hierarchy level.

```
set logical-systems LS1 interfaces so-0/0/2 unit 0 family inet policer input icmp-policer
set logical-systems LS1 interfaces so-0/0/2 unit 0 family inet address 10.0.45.2/30
set logical-systems LS1 firewall family inet filter protect-RE term icmp-term from protocol
icmp
set logical-systems LS1 firewall family inet filter protect-RE term icmp-term then policer
icmp-policer
set logical-systems LS1 firewall family inet filter protect-RE term icmp-term then accept
set logical-systems LS1 firewall policer icmp-policer if-exceeding bandwidth-limit 1m
set logical-systems LS1 firewall policer icmp-policer if-exceeding burst-size-limit 15k
set logical-systems LS1 firewall policer icmp-policer then discard
```

Step-by-Step Procedure

The following example requires you to navigate various levels in the configuration hierarchy. For information about navigating the CLI, see Using the CLI Editor in Configuration Mode in the CLI User Guide.

To configure an ICMP firewall filter on a logical system:

1. Configure the interface on the logical system.

[edit]

```
user@host# set logical-systems LS1 interfaces so-0/0/2 unit 0 family inet address
10.0.45.2/30
```

2. Explicitly enable ICMP packets to be received on the interface.

```
[edit]
user@host# set logical-systems LS1 firewall family inet filter protect-RE term
icmp-term from protocol icmp
user@host# set logical-systems LS1 firewall family inet filter protect-RE term
icmp-term then accept
```

3. Create the policer.

```
[edit]
user@host# set logical-systems LS1 firewall policer icmp-policer if-exceeding
bandwidth-limit 1m
user@host# set logical-systems LS1 firewall policer icmp-policer if-exceeding
burst-size-limit 15k
user@host# set logical-systems LS1 firewall policer icmp-policer then discard
```

4. Apply the policer to a filter term.

```
[edit]
user@host# set logical-systems LS1 firewall family inet filter protect-RE term
icmp-term then policer icmp-policer
```

5. Apply the policer to the logical system interface.

```
[edit]
user@host# set logical-systems LS1 interfaces so-0/0/2 unit 0 family inet policer
input icmp-policer
```

6. If you are done configuring the device, commit the configuration.

```
[edit]
user@host# commit
```

Confirm your configuration by issuing the **show logical-systems LS1** command.

```
user@host# show logical-systems LS1
interfaces {
  so-0/0/2 {
    unit 0 {
      family inet {
        policer {
          input icmp-policer;
        }
        address 10.0.45.2/30;
      }
    }
  }
}
firewall {
  family inet {
    filter protect-RE {
      term icmp-term {
        from {
          protocol icmp;
        }
      }
    }
  }
}
```



```

    }
    then {
        policer icmp-policer;
        accept;
    }
}
}
}
policer icmp-policer {
    if-exceeding {
        bandwidth-limit 1m;
        burst-size-limit 15k;
    }
    then discard;
}
}
}

```

Verification

Confirm that the configuration is working properly.

Verifying That Ping Works Unless the Limits Are Exceeded

Purpose Make sure that the logical system interface is protected against ICMP-based DoS attacks.

Action Log in to a system that has connectivity to the logical system and run the `ping` command.

```

user@R2> ping 10.0.45.2
PING 10.0.45.2 (10.0.45.2): 56 data bytes
64 bytes from 10.0.45.2: icmp_seq=0 ttl=64 time=1.316 ms
64 bytes from 10.0.45.2: icmp_seq=1 ttl=64 time=1.277 ms
64 bytes from 10.0.45.2: icmp_seq=2 ttl=64 time=1.269 ms

user@R2> ping 10.0.45.2 size 20000
PING 10.0.45.2 (10.0.45.2): 20000 data bytes
^C
--- 10.0.45.2 ping statistics ---
4 packets transmitted, 0 packets received, 100% packet loss

```

Meaning When you send a normal ping, the packet is accepted. When you send a ping packet that exceeds the filter limit, the packet is discarded.

Example: Configuring Filter-Based Forwarding on Logical Systems

This example shows how to configure filter-based forwarding within a logical system. The filter classifies packets to determine their forwarding path within the ingress routing device.

- [Requirements on page 50](#)
- [Overview on page 50](#)
- [Configuration on page 52](#)
- [Verification on page 58](#)

Requirements

In this example, no special configuration beyond device initialization is required.

Overview

Filter-based forwarding is supported for IP version 4 (IPv4) and IP version 6 (IPv6).

Use filter-based forwarding for service provider selection when customers have Internet connectivity provided by different ISPs yet share a common access layer. When a shared media (such as a cable modem) is used, a mechanism on the common access layer looks at Layer 2 or Layer 3 addresses and distinguishes between customers. You can use filter-based forwarding when the common access layer is implemented using a combination of Layer 2 switches and a single router.

With filter-based forwarding, all packets received on an interface are considered. Each packet passes through a filter that has match conditions. If the match conditions are met for a filter and you have created a routing instance, filter-based forwarding is applied to a packet. The packet is forwarded based on the next hop specified in the routing instance. For static routes, the next hop can be a specific LSP.



NOTE: Source-class usage filter matching and unicast reverse-path forwarding checks are not supported on an interface configured with filter-based forwarding (FBF).

To configure filter-based forwarding, perform the following tasks:

- Create a match filter on an ingress router. To specify a match filter, include the **filter** *filter-name* statement at the **[edit firewall]** hierarchy level. A packet that passes through the filter is compared against a set of rules to classify it and to determine its membership in a set. Once classified, the packet is forwarded to a routing table specified in the accept action in the filter description language. The routing table then forwards the packet to the next hop that corresponds to the destination address entry in the table.
- Create routing instances that specify the routing table(s) to which a packet is forwarded, and the destination to which the packet is forwarded at the **[edit routing-instances]** or **[edit logical-systems logical-system-name routing-instances]** hierarchy level. For example:

```
[edit]
routing-instances {
  routing-table-name1 {
    instance-type forwarding;
    routing-options {
      static {
        route 0.0.0.0/0 nexthop 10.0.0.1;
      }
    }
  }
  routing-table-name2 {
    instance-type forwarding;
```

```

routing-options {
  static {
    route 0.0.0.0/0 nexthop 10.0.0.2;
  }
}

```

- Create a routing table group that adds interface routes to the forwarding routing instances used in filter-based forwarding (FBF), as well as to the default routing instance `inet.0`. This part of the configuration resolves the routes installed in the routing instances to directly connected next hops on that interface. Create the routing table group at the `[edit routing-options]` or `[edit logical-systems logical-system-name routing-options]` hierarchy level.



NOTE: Specify `inet.0` as one of the routing instances that the interface routes are imported into. If the default instance `inet.0` is not specified, interface routes are not imported into the default routing instance.

This example shows a packet filter that directs customer traffic to a next-hop router in the domains, SP 1 or SP 2, based on the packet's source address.

If the packet has a source address assigned to an SP 1 customer, destination-based forwarding occurs using the `sp1-route-table.inet.0` routing table. If the packet has a source address assigned to an SP 2 customer, destination-based forwarding occurs using the `sp2-route-table.inet.0` routing table. If a packet does not match either of these conditions, the filter accepts the packet, and destination-based forwarding occurs using the standard `inet.0` routing table.

One way to make filter-based forwarding work within a logical system is to configure the firewall filter on the logical system that receives the packets. Another way is to configure the firewall filter on the main router and then reference the logical system in the firewall filter. This example uses the second approach. The specific routing instances are configured within the logical system. Because each routing instance has its own routing table, you have to reference the routing instances in the firewall filter, as well. The syntax looks as follows:

```

[edit firewall filter filter-name term term-name]
user@host# set then logical-system logical-system-name routing-instance
routing-instance-name

```

Figure 11 on page 52 shows the topology used in this example.

On Logical System P1, an input filter classifies packets received from Logical System PE3 and Logical System PE4. The packets are routed based on the source addresses. Packets with source addresses in the 10.1.1.0/24 and 10.1.2.0/24 networks are routed to Logical System PE1. Packets with source addresses in the 10.2.1.0/24 and 10.2.2.0/24 networks are routed to Logical System PE2.

Figure 11: Logical Systems with Filter-Based Forwarding

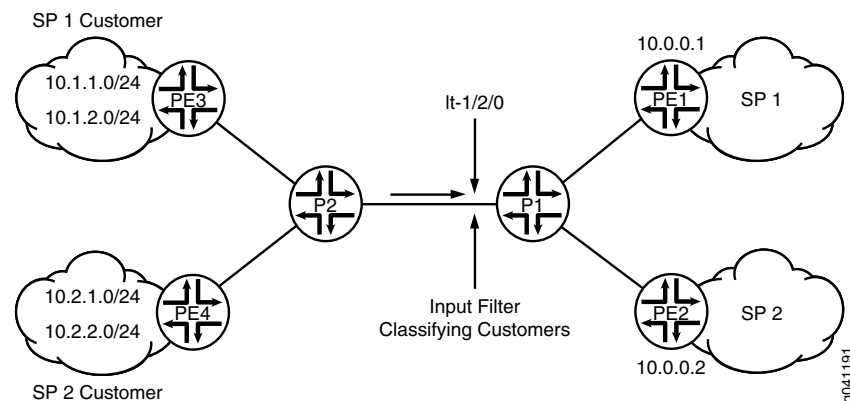

To establish connectivity, OSPF is configured on all of the interfaces. For demonstration purposes, loopback interface addresses are configured on the routing devices to represent networks in the clouds.

The “[CLI Quick Configuration](#)” on page 52 section shows the entire configuration for all of the devices in the topology. The “[Configuring the Routing Instances on the Logical System P1](#)” on page 55 and “[Configuring the Firewall Filter on the Main Router](#)” on page 54 sections shows the step-by-step configuration of the ingress routing device, Logical System P1.

Configuration

CLI Quick Configuration

To quickly configure this example, copy the following commands, paste them into a text file, remove any line breaks, change any details necessary to match your network configuration, and then copy and paste the commands into the CLI at the **[edit]** hierarchy level.

```

set firewall filter classify-customers term sp1-customers from source-address 10.1.1.0/24
set firewall filter classify-customers term sp1-customers from source-address 10.1.2.0/24
set firewall filter classify-customers term sp1-customers then log
set firewall filter classify-customers term sp1-customers then logical-system P1
  routing-instance sp1-route-table
set firewall filter classify-customers term sp2-customers from source-address 10.2.1.0/24
set firewall filter classify-customers term sp2-customers from source-address 10.2.2.0/24
set firewall filter classify-customers term sp2-customers then log
set firewall filter classify-customers term sp2-customers then logical-system P1
  routing-instance sp2-route-table
set firewall filter classify-customers term default then accept
set logical-systems P1 interfaces lt-1/2/0 unit 10 encapsulation ethernet
set logical-systems P1 interfaces lt-1/2/0 unit 10 peer-unit 9
set logical-systems P1 interfaces lt-1/2/0 unit 10 family inet filter input classify-customers
set logical-systems P1 interfaces lt-1/2/0 unit 10 family inet address 172.16.0.10/30
set logical-systems P1 interfaces lt-1/2/0 unit 13 encapsulation ethernet
set logical-systems P1 interfaces lt-1/2/0 unit 13 peer-unit 14
set logical-systems P1 interfaces lt-1/2/0 unit 13 family inet address 172.16.0.13/30
set logical-systems P1 interfaces lt-1/2/0 unit 17 encapsulation ethernet
set logical-systems P1 interfaces lt-1/2/0 unit 17 peer-unit 18
set logical-systems P1 interfaces lt-1/2/0 unit 17 family inet address 172.16.0.17/30
set logical-systems P1 protocols ospf rib-group fbf-group

```

```
set logical-systems P1 protocols ospf area 0.0.0.0 interface all
set logical-systems P1 protocols ospf area 0.0.0.0 interface fxp0.0 disable
set logical-systems P1 routing-instances sp1-route-table instance-type forwarding
set logical-systems P1 routing-instances sp1-route-table routing-options static route
  0.0.0.0/0 next-hop 172.16.0.13
set logical-systems P1 routing-instances sp2-route-table instance-type forwarding
set logical-systems P1 routing-instances sp2-route-table routing-options static route
  0.0.0.0/0 next-hop 172.16.0.17
set logical-systems P1 routing-options rib-groups fbf-group import-rib inet.0
set logical-systems P1 routing-options rib-groups fbf-group import-rib
  sp1-route-table.inet.0
set logical-systems P1 routing-options rib-groups fbf-group import-rib
  sp2-route-table.inet.0
set logical-systems P2 interfaces lt-1/2/0 unit 2 encapsulation ethernet
set logical-systems P2 interfaces lt-1/2/0 unit 2 peer-unit 1
set logical-systems P2 interfaces lt-1/2/0 unit 2 family inet address 172.16.0.2/30
set logical-systems P2 interfaces lt-1/2/0 unit 6 encapsulation ethernet
set logical-systems P2 interfaces lt-1/2/0 unit 6 peer-unit 5
set logical-systems P2 interfaces lt-1/2/0 unit 6 family inet address 172.16.0.6/30
set logical-systems P2 interfaces lt-1/2/0 unit 9 encapsulation ethernet
set logical-systems P2 interfaces lt-1/2/0 unit 9 peer-unit 10
set logical-systems P2 interfaces lt-1/2/0 unit 9 family inet address 172.16.0.9/30
set logical-systems P2 protocols ospf area 0.0.0.0 interface all
set logical-systems P2 protocols ospf area 0.0.0.0 interface fxp0.0 disable
set logical-systems PE1 interfaces lt-1/2/0 unit 14 encapsulation ethernet
set logical-systems PE1 interfaces lt-1/2/0 unit 14 peer-unit 13
set logical-systems PE1 interfaces lt-1/2/0 unit 14 family inet address 172.16.0.14/30
set logical-systems PE1 interfaces lo0 unit 3 family inet address 1.1.1.1/32
set logical-systems PE1 protocols ospf area 0.0.0.0 interface all
set logical-systems PE1 protocols ospf area 0.0.0.0 interface fxp0.0 disable
set logical-systems PE2 interfaces lt-1/2/0 unit 18 encapsulation ethernet
set logical-systems PE2 interfaces lt-1/2/0 unit 18 peer-unit 17
set logical-systems PE2 interfaces lt-1/2/0 unit 18 family inet address 172.16.0.18/30
set logical-systems PE2 interfaces lo0 unit 4 family inet address 2.2.2.2/32
set logical-systems PE2 protocols ospf area 0.0.0.0 interface all
set logical-systems PE2 protocols ospf area 0.0.0.0 interface fxp0.0 disable
set logical-systems PE3 interfaces lt-1/2/0 unit 1 encapsulation ethernet
set logical-systems PE3 interfaces lt-1/2/0 unit 1 peer-unit 2
set logical-systems PE3 interfaces lt-1/2/0 unit 1 family inet address 172.16.0.1/30
set logical-systems PE3 interfaces lo0 unit 1 family inet address 10.1.1.1/32
set logical-systems PE3 interfaces lo0 unit 1 family inet address 10.1.2.1/32
set logical-systems PE3 protocols ospf area 0.0.0.0 interface all
set logical-systems PE3 protocols ospf area 0.0.0.0 interface fxp0.0 disable
set logical-systems PE4 interfaces lt-1/2/0 unit 5 encapsulation ethernet
set logical-systems PE4 interfaces lt-1/2/0 unit 5 peer-unit 6
set logical-systems PE4 interfaces lt-1/2/0 unit 5 family inet address 172.16.0.5/30
set logical-systems PE4 interfaces lo0 unit 2 family inet address 10.2.1.1/32
set logical-systems PE4 interfaces lo0 unit 2 family inet address 10.2.2.1/32
set logical-systems PE4 protocols ospf area 0.0.0.0 interface all
set logical-systems PE4 protocols ospf area 0.0.0.0 interface fxp0.0 disable
```

Configuring the Firewall Filter on the Main Router

Step-by-Step Procedure The following example requires you to navigate various levels in the configuration hierarchy. For information about navigating the CLI, see Using the CLI Editor in Configuration Mode in the CLI User Guide.

To configure the firewall filter on the main router:

1. Configure the source addresses for SP1 customers.

```
[edit firewall filter classify-customers term sp1-customers]
user@host# set from source-address 10.1.1.0/24
user@host# set from source-address 10.1.2.0/24
```

2. Configure the actions that are taken when packets are received with the specified source addresses.

To track the action of the firewall filter, a log action is configured. The sp1-route-table.inet.0 routing table on Logical System P1 routes the packets.

```
[edit firewall filter classify-customers term sp1-customers]
user@host# set then log
user@host# set then logical-system P1 routing-instance sp1-route-table
```

3. Configure the source addresses for SP2 customers.

```
[edit firewall filter classify-customers term sp2-customers]
user@host# set from source-address 10.2.1.0/24
user@host# set from source-address 10.2.2.0/24
```

4. Configure the actions that are taken when packets are received with the specified source addresses.

To track the action of the firewall filter, a log action is configured. The sp2-route-table.inet.0 routing table on Logical System P1 routes the packet.

```
[edit firewall filter classify-customers term sp2-customers]
user@host# set then log
user@host# set then logical-system P1 routing-instance sp2-route-table
```

5. Configure the action to take when packets are received from any other source address.

All of these packets are simply accepted and routed using the default IPv4 unicast routing table, inet.0.

```
[edit firewall filter classify-customers term default]
user@host# set then accept
```

Configuring the Routing Instances on the Logical System P1

Step-by-Step Procedure The following example requires you to navigate various levels in the configuration hierarchy. For information about navigating the CLI, see Using the CLI Editor in Configuration Mode in the CLI User Guide.

To configure the routing instances on a logical system:

1. Configure the interfaces on the logical system.

```
[edit logical-systems P1 interfaces lt-1/2/0]
user@host# set unit 10 encapsulation ethernet
user@host# set unit 10 peer-unit 9
user@host# set unit 10 family inet address 172.16.0.10/30
```

```
user@host# set unit 13 encapsulation ethernet
user@host# set unit 13 peer-unit 14
user@host# set unit 13 family inet address 172.16.0.13/30
```

```
user@host# set unit 17 encapsulation ethernet
user@host# set unit 17 peer-unit 18
user@host# set unit 17 family inet address 172.16.0.17/30
```

2. Assign the **classify-customers** firewall filter to router interface lt-1/2/0.10 as an input packet filter.

```
[edit logical-systems P1 interfaces lt-1/2/0]
user@host# set unit 10 family inet filter input classify-customers
```

3. Configure connectivity, using either a routing protocol or static routing.

As a best practice, disable routing on the management interface.

```
[edit logical-systems P1 protocols ospf area 0.0.0.0]
user@host# set interface all
user@host# set interface fxp0.0 disable
```

4. Create the routing instances.

These routing instances are referenced in the **classify-customers** firewall filter.

The forwarding instance type provides support for filter-based forwarding, where interfaces are not associated with instances. All interfaces belong to the default instance, in this case Logical System P1.

```
[edit logical-systems P1 routing-instances]
user@host# set sp1-route-table instance-type forwarding
```

```
user@host# set sp2-route-table instance-type forwarding
```

5. Resolve the routes installed in the routing instances to directly connected next hops.

```
[edit logical-systems P1 routing-instances]
user@host# set sp1-route-table routing-options static route 0.0.0.0/0 next-hop
172.16.0.13
```

```
user@host# set sp2-route-table routing-options static route 0.0.0.0/0 next-hop
172.16.0.17
```

- Group together the routing tables to form a routing table group.

The first routing table, inet.0, is the primary routing table, and the additional routing tables are the secondary routing tables.

The primary routing table determines the address family of the routing table group, in this case IPv4.

```
[edit logical-systems P1 routing-options]
user@host# set rib-groups fbf-group import-rib inet.0
user@host# set rib-groups fbf-group import-rib sp1-route-table.inet.0
user@host# set rib-groups fbf-group import-rib sp2-route-table.inet.0
```

- Apply the routing table group to OSPF.

This causes the OSPF routes to be installed into all the routing tables in the group.

```
[edit logical-systems P1 protocols ospf]
user@host# set rib-group fbf-group
```

- If you are done configuring the device, commit the configuration.

```
[edit]
user@host# commit
```

Confirm your configuration by issuing the **show firewall** and **show logical-systems P1** commands.

```
user@host# show firewall
filter classify-customers {
  term sp1-customers {
    from {
      source-address {
        10.1.1.0/24;
        10.1.2.0/24;
      }
    }
    then {
      log;
      logical-system P1 routing-instance sp1-route-table;
    }
  }
  term sp2-customers {
    from {
      source-address {
        10.2.1.0/24;
        10.2.2.0/24;
      }
    }
    then {
      log;
      logical-system P1 routing-instance sp2-route-table;
    }
  }
  term default {
```



```
        then accept;
    }
}

user@host# show logical-systems P1
interfaces {
  lt-1/2/0 {
    unit 10 {
      encapsulation ethernet;
      peer-unit 9;
      family inet {
        filter {
          input classify-customers;
        }
        address 172.16.0.10/30;
      }
    }
    unit 13 {
      encapsulation ethernet;
      peer-unit 14;
      family inet {
        address 172.16.0.13/30;
      }
    }
    unit 17 {
      encapsulation ethernet;
      peer-unit 18;
      family inet {
        address 172.16.0.17/30;
      }
    }
  }
}

protocols {
  ospf {
    rib-group fbf-group;
    area 0.0.0.0 {
      interface all;
      interface fxp0.0 {
        disable;
      }
    }
  }
}

routing-instances {
  sp1-route-table {
    instance-type forwarding;
    routing-options {
      static {
        route 0.0.0.0/0 next-hop 172.16.0.13;
      }
    }
  }
  sp2-route-table {
    instance-type forwarding;
    routing-options {
```

```

        static {
            route 0.0.0.0/0 next-hop 172.16.0.17;
        }
    }
}
routing-options {
    rib-groups {
        fbf-group {
            import-rib [ inet.0 sp1-route-table.inet.0 sp2-route-table.inet.0 ];
        }
    }
}

```

Verification

Confirm that the configuration is working properly.

Pinging with Specified Source Addresses

Purpose Send some ICMP packets across the network to test the firewall filter.

Action 1. Log in to Logical System PE3.

```

user@host> set cli logical-system PE3
Logical system: PE3

```

2. Run the **ping** command, pinging the lo0.3 interface on Logical System PE1.

The address configured on this interface is 1.1.1.1.

Specify the source address 10.1.2.1, which is the address configured on the lo0.1 interface on Logical System PE3.

```

user@host:PE3> ping 1.1.1.1 source 10.1.2.1
PING 1.1.1.1 (1.1.1.1): 56 data bytes
64 bytes from 1.1.1.1: icmp_seq=0 ttl=62 time=1.444 ms
64 bytes from 1.1.1.1: icmp_seq=1 ttl=62 time=2.094 ms
^C
--- 1.1.1.1 ping statistics ---
2 packets transmitted, 2 packets received, 0% packet loss
round-trip min/avg/max/stddev = 1.444/1.769/2.094/0.325 ms

```

3. Log in to Logical System PE4.

```

user@host:PE3> set cli logical-system PE4
Logical system: PE4

```

4. Run the **ping** command, pinging the lo0.4 interface on Logical System PE2.

The address configured on this interface is 2.2.2.2.

Specify the source address 10.2.1.1, which is the address configured on the lo0.2 interface on Logical System PE4.

```

user@host:PE4> ping 2.2.2.2 source 10.2.1.1
PING 2.2.2.2 (2.2.2.2): 56 data bytes
64 bytes from 2.2.2.2: icmp_seq=0 ttl=62 time=1.473 ms
64 bytes from 2.2.2.2: icmp_seq=1 ttl=62 time=1.407 ms
^C
--- 2.2.2.2 ping statistics ---

```

2 packets transmitted, 2 packets received, 0% packet loss
 round-trip min/avg/max/stddev = 1.407/1.440/1.473/0.033 ms

Meaning Sending these pings activates the firewall filter actions.

Verifying the Firewall Filter

Purpose Make sure the firewall filter actions take effect.

Action 1. Log in to Logical System P1.

```
user@host> set cli logical-system P1
Logical system: P1
```

2. Run the **show firewall log** command on Logical System P1.

```
user@host:P1> show firewall log
Log :
Time      Filter  Action Interface  Protocol  Src Addr
Dest Addr
13:52:20 pfe      A          1t-1/2/0.10 ICMP      10.2.1.1
2.2.2.2
13:52:19 pfe      A          1t-1/2/0.10 ICMP      10.2.1.1
2.2.2.2
13:51:53 pfe      A          1t-1/2/0.10 ICMP      10.1.2.1
1.1.1.1
13:51:52 pfe      A          1t-1/2/0.10 ICMP      10.1.2.1
1.1.1.1
```

- Related Documentation**
- [Introduction to Logical Systems on page 3](#)
 - [Example: Configuring Multitopology Routing Based on Applications](#)

CHAPTER 6

Routing Protocols and Policy

- Example: Configuring OSPF on Logical Systems on page 61
- Examples: Configuring OSPF Routing Policy on Logical Systems on page 73
- Examples: Configuring IS-IS on Logical Systems on page 94
- Examples: Configuring BGP on Logical Systems on page 113

Example: Configuring OSPF on Logical Systems

- OSPF Overview on page 62
- Example: Configuring OSPF on Logical Systems Within the Same Router on page 66

OSPF Overview

OSPF is an interior gateway protocol (IGP) that routes packets within a single autonomous system (AS). OSPF uses link-state information to make routing decisions, making route calculations using the shortest-path-first (SPF) algorithm (also referred to as the Dijkstra algorithm). Each router running OSPF floods link-state advertisements throughout the AS or area that contain information about that router's attached interfaces and routing metrics. Each router uses the information in these link-state advertisements to calculate the least cost path to each network and create a routing table for the protocol.

Junos OS supports OSPF version 2 (OSPFv2) and OSPF version 3 (OSPFv3), including virtual links, stub areas, and for OSPFv2, authentication. Junos OS does not support type-of-service (ToS) routing.

OSPF was designed for the Transmission Control Protocol/Internet Protocol (TCP/IP) environment and as a result explicitly supports IP subnetting and the tagging of externally derived routing information. OSPF also provides for the authentication of routing updates.

OSPF routes IP packets based solely on the destination IP address contained in the IP packet header. OSPF quickly detects topological changes, such as when router interfaces become unavailable, and calculates new loop-free routes quickly and with a minimum of routing overhead traffic.



NOTE: On SRX Series devices, when only one link-protection is configured under the OSPF interface, the device does not install an alternative route in the forwarding table. When the per-packet load-balancing is enabled as a workaround, the device does not observe both the OSPF metric and sending the traffic through both the interfaces.

An OSPF AS can consist of a single area, or it can be subdivided into multiple areas. In a single-area OSPF network topology, each router maintains a database that describes the topology of the AS. Link-state information for each router is flooded throughout the AS. In a multiarea OSPF topology, each router maintains a database that describes the topology of its area, and link-state information for each router is flooded throughout that area. All routers maintain summarized topologies of other areas within an AS. Within each area, OSPF routers have identical topological databases. When the AS or area topology changes, OSPF ensures that the contents of all routers' topological databases converge quickly.

All OSPFv2 protocol exchanges can be authenticated. OSPFv3 relies on IPsec to provide this functionality. This means that only trusted routers can participate in the AS's routing. A variety of authentication schemes can be used. A single authentication scheme is configured for each area, which enables some areas to use stricter authentication than others.

Externally derived routing data (for example, routes learned from BGP) is passed transparently throughout the AS. This externally derived data is kept separate from the OSPF link-state data. Each external route can be tagged by the advertising router, enabling the passing of additional information between routers on the boundaries of the AS.



NOTE: By default, Junos OS is compatible with RFC 1583, *OSPF Version 2*. In Junos OS Release 8.5 and later, you can disable compatibility with RFC 1583 by including the `no-rfc-1583` statement. For more information, see Example: Disabling OSPFv2 Compatibility with RFC 1583.

This topic describes the following information:

- [OSPF Default Route Preference Values on page 64](#)
- [OSPF Routing Algorithm on page 64](#)
- [OSPF Three-Way Handshake on page 65](#)
- [OSPF Version 3 on page 66](#)

OSPF Default Route Preference Values

The Junos OS routing protocol process assigns a default preference value to each route that the routing table receives. The default value depends on the source of the route. The preference value is from 0 through 4,294,967,295 (232 – 1), with a lower value indicating a more preferred route. [Table 5 on page 64](#) lists the default preference values for OSPF.

Table 5: Default Route Preference Values for OSPF

How Route Is Learned	Default Preference	Statement to Modify Default Preference
OSPF internal route	10	OSPF preference
OSPF AS external routes	150	OSPF external-preference

OSPF Routing Algorithm

OSPF uses the shortest-path-first (SPF) algorithm, also referred to as the Dijkstra algorithm, to determine the route to each destination. All routing devices in an area run this algorithm in parallel, storing the results in their individual topological databases. Routing devices with interfaces to multiple areas run multiple copies of the algorithm. This section provides a brief summary of how the SPF algorithm works.

When a routing device starts, it initializes OSPF and waits for indications from lower-level protocols that the router interfaces are functional. The routing device then uses the OSPF hello protocol to acquire neighbors, by sending hello packets to its neighbors and receiving their hello packets.

On broadcast or nonbroadcast multiaccess networks (physical networks that support the attachment of more than two routing devices), the OSPF hello protocol elects a designated router for the network. This routing device is responsible for sending *link-state advertisements* (LSAs) that describe the network, which reduces the amount of network traffic and the size of the routing devices' topological databases.

The routing device then attempts to form *adjacencies* with some of its newly acquired neighbors. (On multiaccess networks, only the designated router and backup designated

router form adjacencies with other routing devices.) Adjacencies determine the distribution of routing protocol packets. Routing protocol packets are sent and received only on adjacencies, and topological database updates are sent only along adjacencies. When adjacencies have been established, pairs of adjacent routers synchronize their topological databases.

A routing device sends LSA packets to advertise its state periodically and when its state changes. These packets include information about the routing device's adjacencies, which allows detection of nonoperational routing devices.

Using a reliable algorithm, the routing device floods LSAs throughout the area, which ensures that all routing devices in an area have exactly the same topological database. Each routing device uses the information in its topological database to calculate a shortest-path tree, with itself as the root. The routing device then uses this tree to route network traffic.

The description of the SPF algorithm up to this point has explained how the algorithm works within a single area (*intra-area routing*). For internal routers to be able to route to destinations outside the area (*interarea routing*), the area border routers must inject additional routing information into the area. Because the area border routers are connected to the backbone, they have access to complete topological data about the backbone. The area border routers use this information to calculate paths to all destinations outside its area and then advertise these paths to the area's internal routers.

Autonomous system (AS) boundary routers flood information about external autonomous systems throughout the AS, except to stub areas. Area border routers are responsible for advertising the paths to all AS boundary routers.

OSPF Three-Way Handshake

OSPF creates a topology map by flooding LSAs across OSPF-enabled links. LSAs announce the presence of OSPF-enabled interfaces to adjacent OSPF interfaces. The exchange of LSAs establishes bidirectional connectivity between all adjacent OSPF interfaces (neighbors) using a three-way handshake, as shown in [Figure 12 on page 65](#).

Figure 12: OSPF Three-Way Handshake

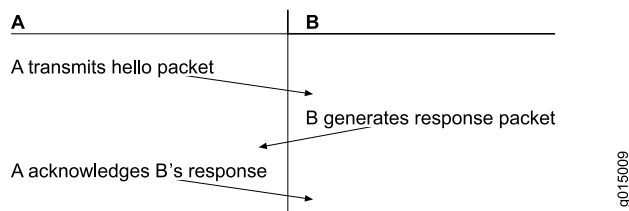

In [Figure 12 on page 65](#), Router A sends hello packets out all its OSPF-enabled interfaces when it comes online. Router B receives the packet, which establishes that Router B can receive traffic from Router A. Router B generates a response to Router A to acknowledge receipt of the hello packet. When Router A receives the response, it establishes that Router B can receive traffic from Router A. Router A then generates a final response packet to inform Router B that Router A can receive traffic from Router B. This three-way handshake ensures bidirectional connectivity.

As new neighbors are added to the network or existing neighbors lose connectivity, the adjacencies in the topology map are modified accordingly through the exchange (or absence) of LSAs. These LSAs advertise only the incremental changes in the network, which helps minimize the amount of OSPF traffic on the network. The adjacencies are shared and used to create the network topology in the topological database.

OSPF Version 3

OSPFv3 is a modified version of OSPF that supports IP version 6 (IPv6) addressing. OSPFv3 differs from OSPFv2 in the following ways:

- All neighbor ID information is based on a 32-bit router ID.
- The protocol runs per link rather than per subnet.
- Router and network link-state advertisements (LSAs) do not carry prefix information.
- Two new LSA types are included: link-LSA and intra-area-prefix-LSA.
- Flooding scopes are as follows:
 - Link-local
 - Area
 - AS
- Link-local addresses are used for all neighbor exchanges except virtual links.
- Authentication is removed. The IPv6 authentication header relies on the IP layer.
- The packet format has changed as follows:
 - Version number 2 is now version number 3.
 - The **db** option field has been expanded to 24 bits.
 - Authentication information has been removed.
 - Hello messages do not have address information.
 - Two new option bits are included: **R** and **V6**.
- Type 3 summary LSAs have been renamed *inter-area-prefix-LSAs*.
- Type 4 summary LSAs have been renamed *inter-area-router-LSAs*.

Example: Configuring OSPF on Logical Systems Within the Same Router

This example shows how to configure an OSPF network using multiple logical systems that are running on a single physical router. The logical systems are connected by logical tunnel interfaces.

- [Requirements on page 67](#)
- [Overview on page 67](#)
- [Configuration on page 67](#)
- [Verification on page 71](#)

Requirements

You must connect the logical systems by using logical tunnel (lt) interfaces. See “[Example: Connecting Logical Systems Within the Same Router Using Logical Tunnel Interfaces](#)” on page 28.

Overview

This example shows the configuration of a single OSPF area with three logical systems running on one physical router. Each logical system has its own routing table. The configuration enables the protocol on all logical system interfaces that participate in the OSPF domain and specifies the area that the interfaces are in.

Figure 13 on page 67 shows the sample network.

Figure 13: OSPF on Logical Systems

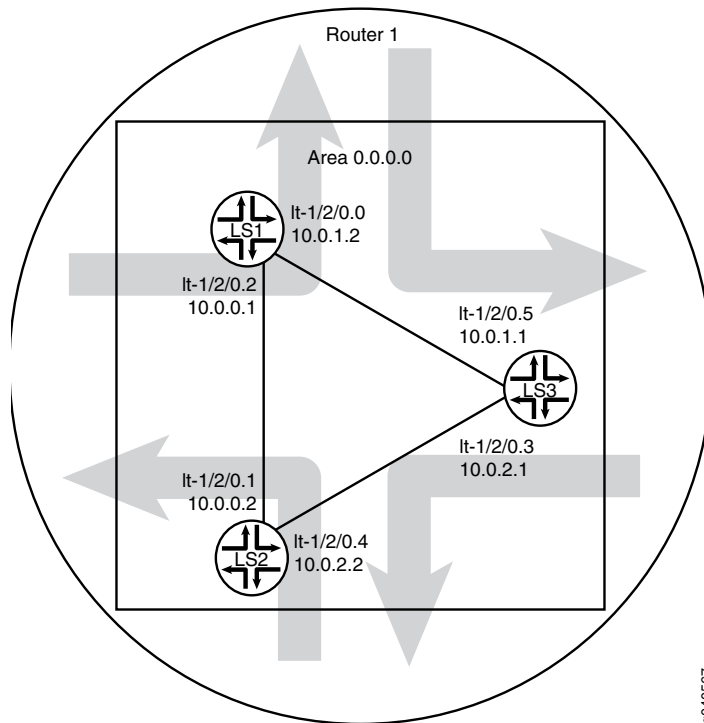

Configuration

CLI Quick Configuration

To quickly configure this example, copy the following commands, paste them into a text file, remove any line breaks, change any details necessary to match your network configuration, and then copy and paste the commands into the CLI at the **[edit]** hierarchy level.

```
set logical-systems LS1 interfaces lt-1/2/0 unit 0 description LS1->LS3
set logical-systems LS1 interfaces lt-1/2/0 unit 0 encapsulation ethernet
set logical-systems LS1 interfaces lt-1/2/0 unit 0 peer-unit 5
set logical-systems LS1 interfaces lt-1/2/0 unit 0 family inet address 10.0.1.2/30
set logical-systems LS1 interfaces lt-1/2/0 unit 2 description LS1->LS2
```

```

set logical-systems LS1 interfaces lt-1/2/0 unit 2 encapsulation ethernet
set logical-systems LS1 interfaces lt-1/2/0 unit 2 peer-unit 1
set logical-systems LS1 interfaces lt-1/2/0 unit 2 family inet address 10.0.0.1/30
set logical-systems LS1 protocols ospf area 0.0.0.0 interface lt-1/2/0.0
set logical-systems LS1 protocols ospf area 0.0.0.0 interface lt-1/2/0.2
set logical-systems LS2 interfaces lt-1/2/0 unit 1 description LS2->LS1
set logical-systems LS2 interfaces lt-1/2/0 unit 1 encapsulation ethernet
set logical-systems LS2 interfaces lt-1/2/0 unit 1 peer-unit 2
set logical-systems LS2 interfaces lt-1/2/0 unit 1 family inet address 10.0.0.2/30
set logical-systems LS2 interfaces lt-1/2/0 unit 4 description LS2->LS3
set logical-systems LS2 interfaces lt-1/2/0 unit 4 encapsulation ethernet
set logical-systems LS2 interfaces lt-1/2/0 unit 4 peer-unit 3
set logical-systems LS2 interfaces lt-1/2/0 unit 4 family inet address 10.0.2.2/30
set logical-systems LS2 protocols ospf area 0.0.0.0 interface lt-1/2/0.1
set logical-systems LS2 protocols ospf area 0.0.0.0 interface lt-1/2/0.4
set logical-systems LS3 interfaces lt-1/2/0 unit 3 description LS3->LS2
set logical-systems LS3 interfaces lt-1/2/0 unit 3 encapsulation ethernet
set logical-systems LS3 interfaces lt-1/2/0 unit 3 peer-unit 4
set logical-systems LS3 interfaces lt-1/2/0 unit 3 family inet address 10.0.2.1/30
set logical-systems LS3 interfaces lt-1/2/0 unit 5 description LS3->LS1
set logical-systems LS3 interfaces lt-1/2/0 unit 5 encapsulation ethernet
set logical-systems LS3 interfaces lt-1/2/0 unit 5 peer-unit 0
set logical-systems LS3 interfaces lt-1/2/0 unit 5 family inet address 10.0.1.1/30
set logical-systems LS3 protocols ospf area 0.0.0.0 interface lt-1/2/0.5
set logical-systems LS3 protocols ospf area 0.0.0.0 interface lt-1/2/0.3

```

Step-by-Step Procedure The following example requires you to navigate various levels in the configuration hierarchy. For information about navigating the CLI, see Using the CLI Editor in Configuration Mode in the CLI User Guide.

To configure OSPF on logical systems:

1. Configure the logical tunnel interface on Logical System LS1 connecting to Logical System LS2.

```

[edit]
user@host# set logical-systems LS1 interfaces lt-1/2/0 unit 2 description LS1->LS2
user@host# set logical-systems LS1 interfaces lt-1/2/0 unit 2 encapsulation ethernet
user@host# set logical-systems LS1 interfaces lt-1/2/0 unit 2 peer-unit 1
user@host# set logical-systems LS1 interfaces lt-1/2/0 unit 2 family inet address
10.0.0.1/30

```

2. Configure the logical tunnel interface on Logical System LS1 connecting to Logical System LS3.

```

[edit]
user@host# set logical-systems LS1 interfaces lt-1/2/0 unit 0 description LS1->LS3
user@host# set logical-systems LS1 interfaces lt-1/2/0 unit 0 encapsulation ethernet
user@host# set logical-systems LS1 interfaces lt-1/2/0 unit 0 peer-unit 5
user@host# set logical-systems LS1 interfaces lt-1/2/0 unit 0 family inet address
10.0.1.2/30

```

3. Configure the logical tunnel interface on Logical System LS2 connecting to Logical System LS1.

```

[edit]
user@host# set logical-systems LS2 interfaces lt-1/2/0 unit 1 description LS2->LS1

```

```

user@host# set logical-systems LS2 interfaces lt-1/2/0 unit 1 encapsulation ethernet
user@host# set logical-systems LS2 interfaces lt-1/2/0 unit 1 peer-unit 2
user@host# set logical-systems LS2 interfaces lt-1/2/0 unit 1 family inet address
10.0.0.2/30

```

4. Configure the logical tunnel interface on Logical System LS2 connecting to Logical System LS3.

```

[edit]
user@host# set logical-systems LS2 interfaces lt-1/2/0 unit 4 description LS2->LS3
user@host# set logical-systems LS2 interfaces lt-1/2/0 unit 4 encapsulation ethernet
user@host# set logical-systems LS2 interfaces lt-1/2/0 unit 4 peer-unit 3
user@host# set logical-systems LS2 interfaces lt-1/2/0 unit 4 family inet address
10.0.2.2/30

```

5. Configure the logical tunnel interface on Logical System LS3 connecting to Logical System LS2.

```

[edit]
user@host# set logical-systems LS3 interfaces lt-1/2/0 unit 3 description LS3->LS2
user@host# set logical-systems LS3 interfaces lt-1/2/0 unit 3 encapsulation ethernet
user@host# set logical-systems LS3 interfaces lt-1/2/0 unit 3 peer-unit 4
user@host# set logical-systems LS3 interfaces lt-1/2/0 unit 3 family inet address
10.0.2.1/30

```

6. Configure the logical tunnel interface on Logical System LS3 connecting to Logical System LS1.

```

[edit]
user@host# set logical-systems LS3 interfaces lt-1/2/0 unit 5 description LS3->LS1
user@host# set logical-systems LS3 interfaces lt-1/2/0 unit 5 encapsulation ethernet
user@host# set logical-systems LS3 interfaces lt-1/2/0 unit 5 peer-unit 0
user@host# set logical-systems LS3 interfaces lt-1/2/0 unit 5 family inet address
10.0.1.1/30

```

7. Configure OSPF on all the interfaces.

```

[edit]
user@host# set logical-systems LS1 protocols ospf area 0.0.0.0 interface lt-1/2/0.0
user@host# set logical-systems LS1 protocols ospf area 0.0.0.0 interface lt-1/2/0.2
user@host# set logical-systems LS2 protocols ospf area 0.0.0.0 interface lt-1/2/0.1
user@host# set logical-systems LS2 protocols ospf area 0.0.0.0 interface lt-1/2/0.4
user@host# set logical-systems LS3 protocols ospf area 0.0.0.0 interface lt-1/2/0.5
user@host# set logical-systems LS3 protocols ospf area 0.0.0.0 interface lt-1/2/0.3

```

8. If you are done configuring the device, commit the configuration.

```

[edit]
user@host# commit

```

Confirm your configuration by issuing the **show logical-systems** command.

```

show logical-systems
LS1 {
  interfaces {
    lt-1/2/0 {
      unit 0 {
        description LS1->LS3;

```

```
        encapsulation ethernet;
        peer-unit 5;
        family inet {
            address 10.0.1.2/30;
        }
    }
    unit 2 {
        description LS1->LS2;
        encapsulation ethernet;
        peer-unit 1;
        family inet {
            address 10.0.0.1/30;
        }
    }
}
}
}
protocols {
    ospf {
        area 0.0.0.0 {
            interface lt-1/2/0.0;
            interface lt-1/2/0.2;
        }
    }
}
}
}
LS2 {
    interfaces {
        lt-1/2/0 {
            unit 1 {
                description LS2->LS1;
                encapsulation ethernet;
                peer-unit 2;
                family inet {
                    address 10.0.0.2/30;
                }
            }
            unit 4 {
                description LS2->LS3;
                encapsulation ethernet;
                peer-unit 3;
                family inet {
                    address 10.0.2.2/30;
                }
            }
        }
    }
    protocols {
        ospf {
            area 0.0.0.0 {
                interface lt-1/2/0.1;
                interface lt-1/2/0.4;
            }
        }
    }
}
}
LS3 {
```

```

interfaces {
  lt-1/2/0 {
    unit 3 {
      description LS3->LS2;
      encapsulation ethernet;
      peer-unit 4;
      family inet {
        address 10.0.2.1/30;
      }
    }
    unit 5 {
      description LS3->LS1;
      encapsulation ethernet;
      peer-unit 0;
      family inet {
        address 10.0.1.1/30;
      }
    }
  }
}
protocols {
  ospf {
    area 0.0.0.0 {
      interface lt-1/2/0.5;
      interface lt-1/2/0.3;
    }
  }
}
}

```

Verification

Confirm that the configuration is working properly.

- [Verifying That the Logical Systems Are Up on page 71](#)
- [Verifying Connectivity Between the Logical Systems on page 72](#)

Verifying That the Logical Systems Are Up

Purpose Make sure that the interfaces are properly configured.

```

Action user@host> show interfaces terse

```

Interface	Admin	Link	Proto	Local	Remote
...					
lt-1/2/0	up	up			
lt-1/2/0.0	up	up	inet	10.0.1.2/30	
lt-1/2/0.1	up	up	inet	10.0.0.2/30	
lt-1/2/0.2	up	up	inet	10.0.0.1/30	
lt-1/2/0.3	up	up	inet	10.0.2.1/30	
lt-1/2/0.4	up	up	inet	10.0.2.2/30	
lt-1/2/0.5	up	up	inet	10.0.1.1/30	
...					

Verifying Connectivity Between the Logical Systems

Purpose Make sure that the OSPF adjacencies are established by checking the OSPF neighbor tables, checking the routing tables, and pinging the logical systems.

```

Action user@host> show ospf neighbor logical-system LS1
Address      Interface      State      ID          Pri  Dead
10.0.1.1     lt-1/2/0.0    Full      10.0.1.1   128  37
10.0.0.2     lt-1/2/0.2    Full      10.0.0.2   128  33

user@host> show ospf neighbor logical-system LS2
Address      Interface      State      ID          Pri  Dead
10.0.0.1     lt-1/2/0.1    Full      10.0.0.1   128  32
10.0.2.1     lt-1/2/0.4    Full      10.0.1.1   128  36

user@host> show ospf neighbor logical-system LS3
Address      Interface      State      ID          Pri  Dead
10.0.2.2     lt-1/2/0.3    Full      10.0.0.2   128  36
10.0.1.2     lt-1/2/0.5    Full      10.0.0.1   128  37

user@host> show route logical-system LS1
inet.0: 6 destinations, 6 routes (6 active, 0 holddown, 0 hidden)
+ = Active Route, - = Last Active, * = Both

10.0.0.0/30    *[Direct/0] 00:28:00
                > via lt-1/2/0.2
10.0.0.1/32    *[Local/0] 00:28:00
                Local via lt-1/2/0.2
10.0.1.0/30    *[Direct/0] 00:28:00
                > via lt-1/2/0.0
10.0.1.2/32    *[Local/0] 00:28:00
                Local via lt-1/2/0.0
10.0.2.0/30    *[OSPF/10] 00:27:05, metric 2
                > to 10.0.1.1 via lt-1/2/0.0
                  to 10.0.0.2 via lt-1/2/0.2
224.0.0.5/32  *[OSPF/10] 00:28:03, metric 1
                MultiRecv

user@host> show route logical-system LS2
inet.0: 6 destinations, 6 routes (6 active, 0 holddown, 0 hidden)
+ = Active Route, - = Last Active, * = Both

10.0.0.0/30    *[Direct/0] 00:28:31
                > via lt-1/2/0.1
10.0.0.2/32    *[Local/0] 00:28:32
                Local via lt-1/2/0.1
10.0.1.0/30    *[OSPF/10] 00:27:38, metric 2
                > to 10.0.0.1 via lt-1/2/0.1
                  to 10.0.2.1 via lt-1/2/0.4
10.0.2.0/30    *[Direct/0] 00:28:32
                > via lt-1/2/0.4
10.0.2.2/32    *[Local/0] 00:28:32
                Local via lt-1/2/0.4
224.0.0.5/32  *[OSPF/10] 00:28:34, metric 1
                MultiRecv

user@host> show route logical-system LS3
inet.0: 6 destinations, 6 routes (6 active, 0 holddown, 0 hidden)
+ = Active Route, - = Last Active, * = Both

```



```

10.0.0.0/30      *[OSPF/10] 00:28:23, metric 2
                 > to 10.0.2.2 via lt-1/2/0.3
                 to 10.0.1.2 via lt-1/2/0.5
10.0.1.0/30     *[Direct/0] 00:29:13
                 > via lt-1/2/0.5
10.0.1.1/32     *[Local/0] 00:29:15
                 Local via lt-1/2/0.5
10.0.2.0/30     *[Direct/0] 00:29:14
                 > via lt-1/2/0.3
10.0.2.1/32     *[Local/0] 00:29:15
                 Local via lt-1/2/0.3
224.0.0.5/32   *[OSPF/10] 00:29:16, metric 1
                 MultiRecv

```

From LS1, Ping LS3 user@host> set cli logical-system LS1

```

user@host:LS1> ping 10.0.2.1
PING 10.0.2.1 (10.0.2.1): 56 data bytes
64 bytes from 10.0.2.1: icmp_seq=0 ttl=64 time=1.215 ms
64 bytes from 10.0.2.1: icmp_seq=1 ttl=64 time=1.150 ms
64 bytes from 10.0.2.1: icmp_seq=2 ttl=64 time=1.134 ms

```

From LS3, Ping LS1 user@host> set cli logical-system LS3

```

user@host:LS3> ping 10.0.0.1
PING 10.0.0.1 (10.0.0.1): 56 data bytes
64 bytes from 10.0.0.1: icmp_seq=0 ttl=64 time=1.193 ms
64 bytes from 10.0.0.1: icmp_seq=1 ttl=64 time=1.114 ms
64 bytes from 10.0.0.1: icmp_seq=2 ttl=64 time=1.190 ms

```

Related Documentation

- [Introduction to Logical Systems on page 3](#)

Examples: Configuring OSPF Routing Policy on Logical Systems

- [Understanding OSPF Routing Policy on page 73](#)
- [Example: Configuring an OSPF Default Route Policy on Logical Systems on page 75](#)
- [Example: Configuring a Conditional OSPF Default Route Policy on Logical Systems on page 80](#)
- [Example: Configuring an OSPF Import Policy on Logical Systems on page 87](#)

Understanding OSPF Routing Policy

Each routing policy is identified by a policy name. The name can contain letters, numbers, and hyphens (-) and can be up to 255 characters long. To include spaces in the name, enclose the entire name in double quotation marks. Each routing policy name must be unique within a configuration. Once a policy is created and named, it must be applied before it is active.

In the **import** statement, you list the name of the routing policy used to filter OSPF external routes from being installed into the routing tables of OSPF neighbors. You can filter the routes, but not link-state address (LSA) flooding. An external route is a route that is outside the OSPF Autonomous System (AS). The import policy does not impact the

OSPF database. This means that the import policy has no impact on the link-state advertisements.

In the **export** statement, you list the name of the routing policy to be evaluated when routes are being exported from the routing table into OSPF.

By default, if a routing device has multiple OSPF areas, learned routes from other areas are automatically installed into area 0 of the routing table.

To specify more than one policy and create a policy chain, you list the policies using a space as a separator. If multiple policies are specified, the policies are evaluated in the order in which they are specified. As soon as an accept or reject action is executed, the policy chain evaluation ends.

This topic describes the following information:

- [Routing Policy Terms on page 74](#)
- [Routing Policy Match Conditions on page 74](#)
- [Routing Policy Actions on page 75](#)

Routing Policy Terms

Routing policies are made up of one or more terms. A term is a named structure in which match conditions and actions are defined. You can define one or more terms. The name can contain letters, numbers, and hyphens (-) and can be up to 255 characters long. To include spaces in the name, enclose the entire name in double quotation marks.

Each term contains a set of match conditions and a set of actions:

- Match conditions are criteria that a route must match before the actions can be applied. If a route matches all criteria, one or more actions are applied to the route.
- Actions specify whether to accept or reject the route, control how a series of policies are evaluated, and manipulate the characteristics associated with a route.

Routing Policy Match Conditions

A match condition defines the criteria that a route must match for an action to take place. You can define one or more match conditions for each term. If a route matches all of the match conditions for a particular term, the actions defined for that term are processed.

Each term can include two statements, **from** and **to**, that define the match conditions:

- In the **from** statement, you define the criteria that an incoming route must match. You can specify one or more match conditions. If you specify more than one, they all must match the route for a match to occur.

The **from** statement is optional. If you omit the **from** and the **to** statements, all routes are considered to match.



NOTE: In export policies, omitting the **from** statement from a routing policy term might lead to unexpected results. For more information, see *Applying Routing Policies and Policy Chains to Routing Protocols in the Routing Policy Configuration Guide*.

- In the **to** statement, you define the criteria that an outgoing route must match. You can specify one or more match conditions. If you specify more than one, they all must match the route for a match to occur.

The order of the match conditions in a term is not important because a route must match all match conditions in a term for an action to be taken.

For a complete list of match conditions, see *Configuring Match Conditions in Routing Policy Terms in the Routing Policy Configuration Guide*.

Routing Policy Actions

An action defines what the routing device does with the route when the route matches all the match conditions in the **from** and **to** statements for a particular term. If a term does not have **from** and **to** statements, all routes are considered to match and the actions apply to all routes.

Each term can have one or more of the following types of actions. The actions are configured under the **then** statement.

- Flow control actions, which affect whether to accept or reject the route and whether to evaluate the next term or routing policy.
- Actions that manipulate route characteristics.
- Trace action, which logs route matches.

The **then** statement is optional. If you omit it, one of the following occurs:

- The next term in the routing policy, if one exists, is evaluated.
- If the routing policy has no more terms, the next routing policy, if one exists, is evaluated.
- If there are no more terms or routing policies, the **accept** or **reject** action specified by the default policy is executed.

For a complete list of routing policy actions, see *Configuring Actions in Routing Policy Terms* Routing Policy Configuration Guide

Example: Configuring an OSPF Default Route Policy on Logical Systems

This example shows how to configure a default route on one logical system and inject the default route into OSPF area 0. In this example, OSPF area 0 contains three logical systems that are configured on a single physical router.

- [Requirements on page 76](#)
- [Overview on page 76](#)

- Configuration on page 77
- Verification on page 78

Requirements

Before you begin:

- Connect the logical systems by using logical tunnel (lt) interfaces. See “Example: Connecting Logical Systems Within the Same Router Using Logical Tunnel Interfaces” on page 28.
- Enable OSPF on the interfaces. See “Example: Configuring OSPF on Logical Systems Within the Same Router” on page 66.

Overview

This example shows a logical system redistributing a default route to other logical systems. All logical systems are running OSPF. A common reason for a default route is to provide a path for sending traffic destined outside the OSPF domain.

In this example, the default route is not used for forwarding traffic. The **no-install** statement prevents the route from being installed in the forwarding table of Logical System LS3. If you configure a route so it is not installed in the forwarding table, the route is still eligible to be exported from the routing table to other protocols. The **discard** statement silently drops packets without notice.

Figure 14 on page 76 shows the sample network.

Figure 14: OSPF with a Default Route to an ISP

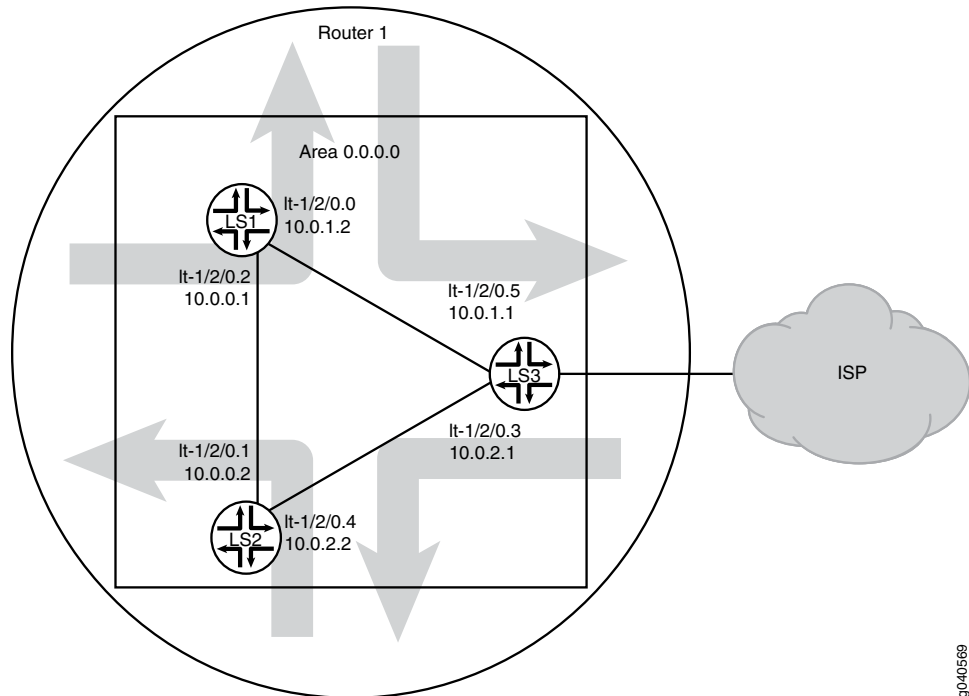

g040589

Configuration

CLI Quick Configuration To quickly configure this example, copy the following commands, paste them into a text file, remove any line breaks, change any details necessary to match your network configuration, and then copy and paste the commands into the CLI at the **[edit]** hierarchy level.

```
set logical-systems LS3 routing-options static route 0.0.0.0/0 discard
set logical-systems LS3 routing-options static route 0.0.0.0/0 no-install
set logical-systems LS3 policy-options policy-statement ospf-default from protocol
static
set logical-systems LS3 policy-options policy-statement ospf-default from route-filter
0.0.0.0/0 exact
set logical-systems LS3 policy-options policy-statement ospf-default then accept
set logical-systems LS3 protocols ospf export ospf-default
```

Step-by-Step Procedure The following example requires you to navigate various levels in the configuration hierarchy. For information about navigating the CLI, see Using the CLI Editor in Configuration Mode in the CLI User Guide.

To configure an OSPF default route policy on logical systems:

1. Change the context to Logical System LS3.

```
[edit]
user@host> set cli logical-system LS3
```

2. Configure the default route on Logical System LS3.

```
[edit]
user@host:LS3# set routing-options static route 0.0.0.0/0 discard
user@host:LS3# set routing-options static route 0.0.0.0/0 no-install
```

3. Configure the policy on Logical System LS3.

```
[edit]
user@host:LS3# set policy-options policy-statement ospf-default from protocol
static
user@host:LS3# set policy-options policy-statement ospf-default from route-filter
0.0.0.0/0 exact
user@host:LS3# set policy-options policy-statement ospf-default then accept
```

4. Apply the export policy to OSPF on Logical System LS3.

```
[edit]
user@host:LS3# set protocols ospf export ospf-default
```

5. If you are done configuring the device, commit the configuration.

```
[edit]
user@host:LS3# commit
```

Confirm your configuration by issuing the **show logical-systems LS3** command.

```
show logical-systems LS3
interfaces {
```

```
lt-1/2/0 {
  unit 3 {
    description LS3->LS2;
    encapsulation ethernet;
    peer-unit 4;
    family inet {
      address 10.0.2.1/30;
    }
  }
  unit 5 {
    description LS3->LS1;
    encapsulation ethernet;
    peer-unit 0;
    family inet {
      address 10.0.1.1/30;
    }
  }
}
protocols {
  ospf {
    export ospf-default;
    area 0.0.0.0 {
      interface lt-1/2/0.5;
      interface lt-1/2/0.3;
    }
  }
}
policy-options {
  policy-statement ospf-default {
    from {
      protocol static;
      route-filter 0.0.0.0/0 exact;
    }
    then accept;
  }
}
routing-options {
  static {
    route 0.0.0.0/0 {
      discard;
      no-install;
    }
  }
}
```

Verification

Confirm that the configuration is working properly.

Verifying That the Static Route Is Redistributed

Purpose Make sure that the OSPF policy is working by checking the routing tables.

```

Action user@host> show route logical-system LS3
inet.0: 7 destinations, 7 routes (7 active, 0 holddown, 0 hidden)
+ = Active Route, - = Last Active, * = Both

0.0.0.0/0      *[Static/5] 01:04:38
               Discard
10.0.0.0/30    *[OSPF/10] 11:53:55, metric 2
               to 10.0.2.2 via lt-1/2/0.3
               > to 10.0.1.2 via lt-1/2/0.5
10.0.1.0/30    *[Direct/0] 11:54:50
               > via lt-1/2/0.5
10.0.1.1/32    *[Local/0] 11:54:54
               Local via lt-1/2/0.5
10.0.2.0/30    *[Direct/0] 11:54:50
               > via lt-1/2/0.3
10.0.2.1/32    *[Local/0] 11:54:54
               Local via lt-1/2/0.3
224.0.0.5/32  *[OSPF/10] 11:56:55, metric 1
               MultiRecv

user@host> show route logical-system LS1
inet.0: 7 destinations, 7 routes (7 active, 0 holddown, 0 hidden)
+ = Active Route, - = Last Active, * = Both

0.0.0.0/0      *[OSPF/150] 01:02:34, metric 0, tag 0
               > to 10.0.1.1 via lt-1/2/0.0
10.0.0.0/30    *[Direct/0] 11:52:46
               > via lt-1/2/0.2
10.0.0.1/32    *[Local/0] 11:52:50
               Local via lt-1/2/0.2
10.0.1.0/30    *[Direct/0] 11:52:46
               > via lt-1/2/0.0
10.0.1.2/32    *[Local/0] 11:52:50
               Local via lt-1/2/0.0
10.0.2.0/30    *[OSPF/10] 11:51:56, metric 2
               > to 10.0.1.1 via lt-1/2/0.0
               to 10.0.0.2 via lt-1/2/0.2
224.0.0.5/32  *[OSPF/10] 11:54:50, metric 1
               MultiRecv

user@host> show route logical-system LS2
inet.0: 7 destinations, 7 routes (7 active, 0 holddown, 0 hidden)
+ = Active Route, - = Last Active, * = Both

0.0.0.0/0      *[OSPF/150] 01:05:20, metric 0, tag 0
               > to 10.0.2.1 via lt-1/2/0.4
10.0.0.0/30    *[Direct/0] 11:55:32
               > via lt-1/2/0.1
10.0.0.2/32    *[Local/0] 11:55:36
               Local via lt-1/2/0.1
10.0.1.0/30    *[OSPF/10] 11:54:37, metric 2
               > to 10.0.0.1 via lt-1/2/0.1
               to 10.0.2.1 via lt-1/2/0.4
10.0.2.0/30    *[Direct/0] 11:55:32
               > via lt-1/2/0.4
10.0.2.2/32    *[Local/0] 11:55:36
               Local via lt-1/2/0.4
224.0.0.5/32  *[OSPF/10] 11:57:36, metric 1
               MultiRecv

```

Meaning The routing table on Logical System LS3 contains the default 0.0.0.0/0 route from protocol **Static**. The routing tables on Logical System LS1 and Logical System LS2 contain the default 0.0.0.0/0 route from protocol **OSPF**. If Logical System LS1 and Logical System LS2 receive packets destined for networks not specified in their routing tables, those packets will be sent to Logical System LS3 for further processing. This configuration assumes that Logical System LS3 has a connection to an ISP or another external network.

Example: Configuring a Conditional OSPF Default Route Policy on Logical Systems

This example shows how to configure a conditional default route on one logical system and inject the default route into OSPF area 0.

- [Requirements on page 80](#)
- [Overview on page 80](#)
- [Configuration on page 81](#)
- [Verification on page 85](#)

Requirements

Before you begin:

- Connect the logical systems by using logical tunnel (**lt**) interfaces. See [“Example: Connecting Logical Systems Within the Same Router Using Logical Tunnel Interfaces” on page 28](#).
- Enable OSPF on the interfaces. See [“Example: Configuring OSPF on Logical Systems Within the Same Router” on page 66](#).

Overview

In this example, OSPF area 0 contains three logical systems that are configured on a single physical router. Logical System LS3 has a BGP session with an external peer, for example, an ISP.

The ISP injects a default static route into BGP, which provides the customer network with a default static route to reach external networks. Logical System LS3 exports the default route into OSPF. The route policy on Logical System LS3 is conditional such that if the connection to the external peer goes down, the default route is no longer active in the routing tables of the logical systems in area 0. This policy prevents blackholing of traffic. Blackholing occurs when packets are dropped without notification.

[Figure 15 on page 81](#) shows the sample network.

Figure 15: OSPF with a Conditional Default Route to an ISP

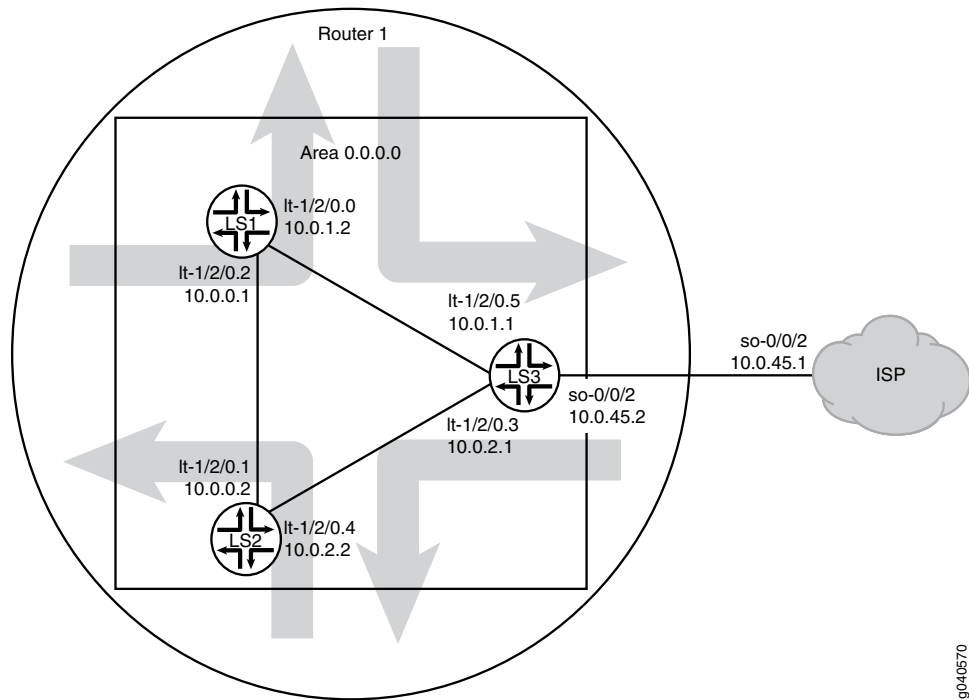

9040570

Configuration

CLI Quick Configuration

To quickly configure this example, copy the following commands, paste them into a text file, remove any line breaks, change any details necessary to match your network configuration, and then copy and paste the commands into the CLI at the [edit] hierarchy level.

Device LS1

```
set logical-systems LS1 interfaces lt-1/2/0 unit 0 description LS1->LS3
set logical-systems LS1 interfaces lt-1/2/0 unit 0 encapsulation ethernet
set logical-systems LS1 interfaces lt-1/2/0 unit 0 peer-unit 5
set logical-systems LS1 interfaces lt-1/2/0 unit 0 family inet address 10.0.1.2/30
set logical-systems LS1 interfaces lt-1/2/0 unit 2 description LS1->LS2
set logical-systems LS1 interfaces lt-1/2/0 unit 2 encapsulation ethernet
set logical-systems LS1 interfaces lt-1/2/0 unit 2 peer-unit 1
set logical-systems LS1 interfaces lt-1/2/0 unit 2 family inet address 10.0.0.1/30
set logical-systems LS1 protocols ospf area 0.0.0.0 interface lt-1/2/0.0
set logical-systems LS1 protocols ospf area 0.0.0.0 interface lt-1/2/0.2
```

Device LS2

```
set logical-systems LS2 interfaces lt-1/2/0 unit 1 description LS2->LS1
set logical-systems LS2 interfaces lt-1/2/0 unit 1 encapsulation ethernet
set logical-systems LS2 interfaces lt-1/2/0 unit 1 peer-unit 2
set logical-systems LS2 interfaces lt-1/2/0 unit 1 family inet address 10.0.0.2/30
set logical-systems LS2 interfaces lt-1/2/0 unit 4 description LS2->LS3
set logical-systems LS2 interfaces lt-1/2/0 unit 4 encapsulation ethernet
set logical-systems LS2 interfaces lt-1/2/0 unit 4 peer-unit 3
set logical-systems LS2 interfaces lt-1/2/0 unit 4 family inet address 10.0.2.2/30
set logical-systems LS2 protocols ospf area 0.0.0.0 interface lt-1/2/0.1
set logical-systems LS2 protocols ospf area 0.0.0.0 interface lt-1/2/0.4
```

```

Device LS3  set logical-systems LS3 interfaces lt-1/2/0 unit 3 description LS3->LS2
            set logical-systems LS3 interfaces lt-1/2/0 unit 3 encapsulation ethernet
            set logical-systems LS3 interfaces lt-1/2/0 unit 3 peer-unit 4
            set logical-systems LS3 interfaces lt-1/2/0 unit 3 family inet address 10.0.2.1/30
            set logical-systems LS3 interfaces lt-1/2/0 unit 5 description LS3->LS1
            set logical-systems LS3 interfaces lt-1/2/0 unit 5 encapsulation ethernet
            set logical-systems LS3 interfaces lt-1/2/0 unit 5 peer-unit 0
            set logical-systems LS3 interfaces lt-1/2/0 unit 5 family inet address 10.0.1.1/30
            set logical-systems LS3 interfaces so-0/0/2 unit 0 description LS3->ISP
            set logical-systems LS3 interfaces so-0/0/2 unit 0 family inet address 10.0.45.2/30
            set logical-systems LS3 protocols bgp group ext type external
            set logical-systems LS3 protocols bgp group ext peer-as 65000
            set logical-systems LS3 protocols bgp group ext neighbor 10.0.45.1
            set logical-systems LS3 protocols ospf export gendefault
            set logical-systems LS3 protocols ospf area 0.0.0.0 interface lt-1/2/0.5
            set logical-systems LS3 protocols ospf area 0.0.0.0 interface lt-1/2/0.3
            set logical-systems LS3 policy-options policy-statement gendefault term upstreamroutes
              from protocol bgp
            set logical-systems LS3 policy-options policy-statement gendefault term upstreamroutes
              from as-path upstream
            set logical-systems LS3 policy-options policy-statement gendefault term upstreamroutes
              from route-filter 0.0.0.0/0 upto /16
            set logical-systems LS3 policy-options policy-statement gendefault term upstreamroutes
              then next-hop 10.0.45.1
            set logical-systems LS3 policy-options policy-statement gendefault term upstreamroutes
              then accept
            set logical-systems LS3 policy-options policy-statement gendefault term end then reject
            set logical-systems LS3 policy-options as-path upstream "^65000 "
            set logical-systems LS3 routing-options generate route 0.0.0.0/0 policy gendefault
            set logical-systems LS3 routing-options autonomous-system 65001

Device ISP  set interfaces so-0/0/2 unit 0 family inet address 10.0.45.1/30
            set protocols bgp group ext type external
            set protocols bgp group ext export advertise-default
            set protocols bgp group ext peer-as 65001
            set protocols bgp group ext neighbor 10.0.45.2
            set policy-options policy-statement advertise-default term 1 from route-filter 0.0.0.0/0
              exact
            set policy-options policy-statement advertise-default term 1 then accept
            set routing-options static route 0.0.0.0/0 discard
            set routing-options autonomous-system 65000

```

Step-by-Step Procedure The following example requires you to navigate various levels in the configuration hierarchy. For information about navigating the CLI, see *Using the CLI Editor in Configuration Mode* in the *CLI User Guide*.

To configure a conditional default route:

1. Configure the interfaces.

```

[edit logical-systems LS3 interfaces]
user@R3# set lt-1/2/0 unit 3 description LS3->LS2
user@R3# set lt-1/2/0 unit 3 encapsulation ethernet
user@R3# set lt-1/2/0 unit 3 peer-unit 4
user@R3# set lt-1/2/0 unit 3 family inet address 10.0.2.1/30

```

```

user@R3# set lt-1/2/0 unit 5 description LS3->LS1
user@R3# set lt-1/2/0 unit 5 encapsulation ethernet
user@R3# set lt-1/2/0 unit 5 peer-unit 0
user@R3# set lt-1/2/0 unit 5 family inet address 10.0.1.1/30
user@R3# set so-0/0/2 unit 0 description LS3->ISP
user@R3# set so-0/0/2 unit 0 encapsulation ethernet
user@R3# set so-0/0/2 unit 0 peer-unit 7
user@R3# set so-0/0/2 unit 0 family inet address 10.0.45.2/30

```

2. Configure the autonomous system (AS) number.

```

[edit logical-systems LS3 routing-options]
user@R3# set autonomous-system 65001

```

3. Configure the BGP session with the ISP device.

```

[edit logical-systems LS3 protocols bgp group ext]
user@R3# set type external
user@R3# set peer-as 65000
user@R3# set neighbor 10.0.45.1

```

4. Configure OSPF.

```

[edit logical-systems LS3 protocols ospf area 0.0.0.0]
user@R3# set interface lt-1/2/0.5
user@R3# set interface lt-1/2/0.3

```

5. Configure the routing policy.

```

[edit logical-systems LS3 policy-options policy-statement gendefault]
user@R3# set term upstreamroutes from protocol bgp
user@R3# set term upstreamroutes from as-path upstream
user@R3# set term upstreamroutes from route-filter 0.0.0.0/0 upto /16
user@R3# set term upstreamroutes then next-hop 10.0.45.1
user@R3# set term upstreamroutes then accept

```

```

user@R3# set term end then reject

```

```

[edit logical-systems LS3 policy-options]
user@R3# set as-path upstream "^65000 "

```

6. Configure the generated route.

```

[edit logical-systems LS3 routing-options]
user@R3# set generate route 0.0.0.0/0 policy gendefault

```

7. Apply the export policy to OSPF.

```

[edit logical-systems LS3 protocols ospf]
user@R3# set export gendefault

```

8. If you are done configuring the device, commit the configuration.

```

[edit]
user@R3# commit

```

Confirm your configuration by issuing the **show logical-systems LS3** command.

```

show logical-systems LS3

```

```
interfaces {
  lt-1/2/0 {
    unit 3 {
      description LS3->LS2;
      encapsulation ethernet;
      peer-unit 4;
      family inet {
        address 10.0.2.1/30;
      }
    }
    unit 5 {
      description LS3->LS1;
      encapsulation ethernet;
      peer-unit 0;
      family inet {
        address 10.0.1.1/30;
      }
    }
    unit 6 {
      description LS3->ISP;
      encapsulation ethernet;
      peer-unit 7;
      family inet {
        address 10.0.45.2/30;
      }
    }
  }
}
protocols {
  bgp {
    group ext {
      type external;
      peer-as 65000;
      neighbor 10.0.45.1;
    }
  }
  ospf {
    export gendefault;
    area 0.0.0.0 {
      interface lt-1/2/0.5;
      interface lt-1/2/0.3;
    }
  }
}
policy-options {
  policy-statement gendefault {
    term upstreamroutes {
      from {
        protocol bgp;
        as-path upstream;
        route-filter 0.0.0.0/0 upto /16;
      }
      then {
        next-hop 10.0.45.1;
        accept;
      }
    }
  }
}
```

```

    }
    term end {
        then reject;
    }
}
as-path upstream "^65000 ";
}
routing-options {
    generate {
        route 0.0.0.0/0 policy gendefault;
    }
    autonomous-system 65001;
}

```

Verification

Confirm that the configuration is working properly.

- [Verifying that the Route to the ISP Is Working on page 85](#)
- [Verifying That the Static Route Is Redistributed on page 85](#)
- [Testing the Policy Condition on page 86](#)

Verifying that the Route to the ISP Is Working

Purpose Make sure connectivity is established between Logical System LS3 and the ISP's router.

Action

```

user@host>set cli logical-system LS3
Logical system: LS3

user@host:LS3>ping 10.0.45.1
PING 10.0.45.1 (10.0.45.1): 56 data bytes
64 bytes from 10.0.45.1: icmp_seq=0 ttl=64 time=1.185 ms
64 bytes from 10.0.45.1: icmp_seq=1 ttl=64 time=1.199 ms
64 bytes from 10.0.45.1: icmp_seq=2 ttl=64 time=1.186 ms

```

Meaning The `ping` command confirms reachability.

Verifying That the Static Route Is Redistributed

Purpose Make sure that the BGP policy is redistributing the static route into Logical System LS3's routing table. Also make sure that the OSPF policy is redistributing the static route into the routing tables of Logical System LS1 and Logical System LS2.

Action

```

user@host> show route logical-system LS3 protocol bgp

inet.0: 9 destinations, 10 routes (9 active, 0 holddown, 1 hidden)
+ = Active Route, - = Last Active, * = Both

0.0.0.0/0          *[BGP/170] 00:00:25, localpref 100
                   AS path: 65000 I
                   > to 10.0.45.1 via so-0/0/2.0

user@host> show route logical-system LS1 protocol ospf

inet.0: 7 destinations, 7 routes (7 active, 0 holddown, 0 hidden)

```

```

+ = Active Route, - = Last Active, * = Both

0.0.0.0/0          *[OSPF/150] 00:03:58, metric 0, tag 0
                  > to 10.0.1.1 via lt-1/2/0.0
10.0.2.0/30       *[OSPF/10] 03:37:45, metric 2
                  to 10.0.1.1 via lt-1/2/0.0
                  > to 10.0.0.2 via lt-1/2/0.2
224.0.0.5/32     *[OSPF/10] 03:38:41, metric 1
                  MultiRecv

user@host> show route logical-system LS2 protocol ospf
inet.0: 7 destinations, 7 routes (7 active, 0 holddown, 0 hidden)
+ = Active Route, - = Last Active, * = Both

0.0.0.0/0          *[OSPF/150] 00:04:04, metric 0, tag 0
                  > to 10.0.2.1 via lt-1/2/0.4
10.0.1.0/30       *[OSPF/10] 03:37:46, metric 2
                  to 10.0.0.1 via lt-1/2/0.1
                  > to 10.0.2.1 via lt-1/2/0.4
224.0.0.5/32     *[OSPF/10] 03:38:47, metric 1
                  MultiRecv

```

Meaning The routing tables contain the default 0.0.0.0/0 route. If Logical System LS1 and Logical System LS2 receive packets destined for networks not specified in their routing tables, those packets will be sent to Logical System LS3 for further processing. If Logical System LS3 receives packets destined for networks not specified in its routing table, those packets will be sent to the ISP for further processing.

Testing the Policy Condition

Purpose Deactivate the interface to make sure that the route is removed from the routing tables if the external network becomes unreachable.

Action user@host> deactivate logical-systems LS3 interfaces so-0/0/2 unit 0 family inet address 10.0.45.2/30
user@host> commit

```

user@host> show route logical-system LS1 protocol ospf

inet.0: 6 destinations, 6 routes (6 active, 0 holddown, 0 hidden)
+ = Active Route, - = Last Active, * = Both

10.0.2.0/30       *[OSPF/10] 03:41:48, metric 2
                  to 10.0.1.1 via lt-1/2/0.0
                  > to 10.0.0.2 via lt-1/2/0.2
224.0.0.5/32     *[OSPF/10] 03:42:44, metric 1
                  MultiRecv

user@host> show route logical-system LS2 protocol ospf
inet.0: 6 destinations, 6 routes (6 active, 0 holddown, 0 hidden)
+ = Active Route, - = Last Active, * = Both

10.0.1.0/30       *[OSPF/10] 03:42:10, metric 2
                  to 10.0.0.1 via lt-1/2/0.1
                  > to 10.0.2.1 via lt-1/2/0.4
224.0.0.5/32     *[OSPF/10] 03:43:11, metric 1
                  MultiRecv

```

Meaning The routing tables on Logical System LS1 and Logical System LS2 do not contain the default 0.0.0.0/0. This verifies that the default route is no longer present in the OSPF domain. To reactivate the `so-0/0/2.0` interface, issue the **activate logical-systems LS3 interfaces so-0/0/2 unit 0 family inet address 10.0.45.2/30** configuration-mode command.

Example: Configuring an OSPF Import Policy on Logical Systems

This example shows how to configure an OSPF import policy on logical systems. OSPF import policies apply to external routes only. An external route is a route that is outside the OSPF AS.

- [Requirements on page 87](#)
- [Overview on page 87](#)
- [Configuration on page 88](#)
- [Verification on page 92](#)

Requirements

This example shows logical systems that are configured within a single physical router. The logical systems connect to each other by using logical tunnel (lt) interfaces. See “[Example: Connecting Logical Systems Within the Same Router Using Logical Tunnel Interfaces](#)” on page 28. Alternatively, you can use multiple physical routers.

Overview

External routes are learned by Autonomous System Border Routers (ASBRs). External routes can be advertised throughout the OSPF domain if you configure the ASBR to redistribute the route into OSPF. An external route might be learned by the ASBR from a routing protocol other than OSPF, or the external route might be a static route that you configure on the ASBR.

OSPF import policy allows you to prevent external routes from being added to the routing tables of OSPF neighbors. The import policy does not impact the OSPF database. This means that the import policy has no impact on the link-state advertisements.

OSPF import policies have practical applications. Suppose, for example, that you are using OSPF to advertise a static route to the devices in your datacenter because you want some of the devices in the datacenter to use the static route. However, you want other devices in the datacenter to ignore the static route. So, you apply the OSPF import policy on the devices that you want to ignore the static route. The filtering is done only on external routes in OSPF. The intra-area and inter-area routes are not considered for filtering. The default action is to accept the route when the route does not match the policy.

[Figure 16 on page 88](#) shows the sample network.

Figure 16: OSPF Import Policy on Logical Systems

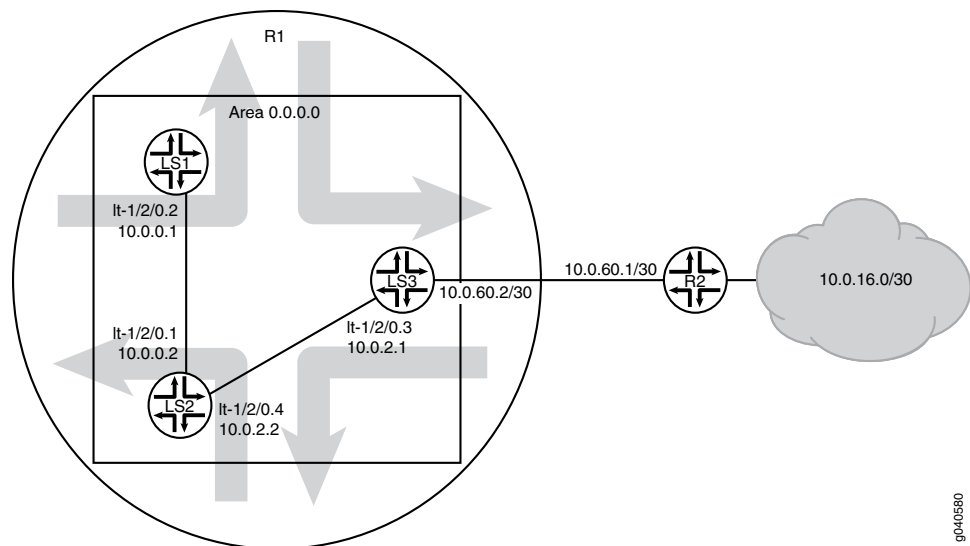

g040560

In this example, the logical systems operate as follows:

1. LS3—Logical System LS3 has a static route to the 10.0.16.0/30 network. The next hop for the static route is 10.0.60.1. LS3 has an OSPF export policy configured. The export policy redistributes static routes from LS3's routing table into LS3's OSPF database. Because the static route is in LS3's OSPF database, the route is advertised in a link state advertisement (LSA) to LS3's OSPF neighbor. LS3's OSPF neighbor is Logical System LS2.
2. LS2—Logical System LS2 receives the route advertisement from LS3. LS2 then installs the route into LS2's OSPF database. LS2 has an OSPF import policy configured that matches the static route to the 10.0.16.0/30 network and prevents the static route from being installed in LS2's routing table. However, because the route is in LS2's OSPF database, LS2 advertises the route to its OSPF neighbor, Logical System LS1.
3. LS1—Logical System LS1 receives the route advertisement from LS2. LS1 then installs the route into LS1's OSPF database. LS1 does not have an OSPF import policy configured that matches the static route to the 10.0.16.0/30 network. Therefore, the route gets installed in LS1's routing table.

Configuration

CLI Quick Configuration

To quickly configure this example, copy the following commands, paste them into a text file, remove any line breaks, change any details necessary to match your network configuration, and then copy and paste the commands into the CLI at the **[edit]** hierarchy level.

```

LS3 set logical-systems LS3 interfaces so-0/0/0 unit 0 family inet address 10.0.60.2/30
set logical-systems LS3 interfaces lt-1/2/0 unit 3 description LS3->LS2
set logical-systems LS3 interfaces lt-1/2/0 unit 3 encapsulation ethernet
set logical-systems LS3 interfaces lt-1/2/0 unit 3 peer-unit 4
set logical-systems LS3 interfaces lt-1/2/0 unit 3 family inet address 10.0.2.1/30
set logical-systems LS3 protocols ospf export export_static
    
```



```

set logical-systems LS3 protocols ospf area 0.0.0.0 interface lt-1/2/0.3
set logical-systems LS3 policy-options policy-statement export_static from protocol
static
set logical-systems LS3 policy-options policy-statement export_static then accept
set logical-systems LS3 routing-options static route 10.0.16.0/30 next-hop 10.0.60.1

```

```

LS2 set logical-systems LS2 interfaces lt-1/2/0 unit 1 description LS2->LS1
set logical-systems LS2 interfaces lt-1/2/0 unit 1 encapsulation ethernet
set logical-systems LS2 interfaces lt-1/2/0 unit 1 peer-unit 2
set logical-systems LS2 interfaces lt-1/2/0 unit 1 family inet address 10.0.0.2/30
set logical-systems LS2 interfaces lt-1/2/0 unit 4 description LS2->LS3
set logical-systems LS2 interfaces lt-1/2/0 unit 4 encapsulation ethernet
set logical-systems LS2 interfaces lt-1/2/0 unit 4 peer-unit 3
set logical-systems LS2 interfaces lt-1/2/0 unit 4 family inet address 10.0.2.2/30
set logical-systems LS2 protocols ospf import filter_routes
set logical-systems LS2 protocols ospf area 0.0.0.0 interface lt-1/2/0.1
set logical-systems LS2 protocols ospf area 0.0.0.0 interface lt-1/2/0.4
set logical-systems LS2 policy-options policy-statement filter_routes from route-filter
10.0.16.0/30 exact
set logical-systems LS2 policy-options policy-statement filter_routes then reject

LS1 set logical-systems LS1 interfaces lt-1/2/0 unit 2 description LS1->LS2
set logical-systems LS1 interfaces lt-1/2/0 unit 2 encapsulation ethernet
set logical-systems LS1 interfaces lt-1/2/0 unit 2 peer-unit 1
set logical-systems LS1 interfaces lt-1/2/0 unit 2 family inet address 10.0.0.1/30
set logical-systems LS1 protocols ospf area 0.0.0.0 interface lt-1/2/0.2

```

Step-by-Step Procedure The following example requires you to navigate various levels in the configuration hierarchy. For information about navigating the CLI, see *Using the CLI Editor in Configuration Mode in the CLI User Guide*.

To configure an OSPF import policy on logical systems:

1. Configure the interfaces.

```

[edit]
user@R1# set logical-systems LS3 interfaces so-0/0/0 unit 0 family inet address
10.0.60.2/30
user@R1# set logical-systems LS3 interfaces lt-1/2/0 unit 3 description LS3->LS2
user@R1# set logical-systems LS3 interfaces lt-1/2/0 unit 3 encapsulation ethernet
user@R1# set logical-systems LS3 interfaces lt-1/2/0 unit 3 peer-unit 4
user@R1# set logical-systems LS3 interfaces lt-1/2/0 unit 3 family inet address
10.0.2.1/30
user@R1# set logical-systems LS2 interfaces lt-1/2/0 unit 1 description LS2->LS1
user@R1# set logical-systems LS2 interfaces lt-1/2/0 unit 1 encapsulation ethernet
user@R1# set logical-systems LS2 interfaces lt-1/2/0 unit 1 peer-unit 2
user@R1# set logical-systems LS2 interfaces lt-1/2/0 unit 1 family inet address
10.0.0.2/30
user@R1# set logical-systems LS2 interfaces lt-1/2/0 unit 4 description LS2->LS3
user@R1# set logical-systems LS2 interfaces lt-1/2/0 unit 4 encapsulation ethernet
user@R1# set logical-systems LS2 interfaces lt-1/2/0 unit 4 peer-unit 3
user@R1# set logical-systems LS2 interfaces lt-1/2/0 unit 4 family inet address
10.0.2.2/30
user@R1# set logical-systems LS1 interfaces lt-1/2/0 unit 2 description LS1->LS2
user@R1# set logical-systems LS1 interfaces lt-1/2/0 unit 2 encapsulation ethernet

```

```

user@R1# set logical-systems LS1 interfaces lt-1/2/0 unit 2 peer-unit 1
user@R1# set logical-systems LS1 interfaces lt-1/2/0 unit 2 family inet address
10.0.0.1/30

```

2. Enable OSPF on the interfaces.

```

[edit]
user@R1# set logical-systems LS3 protocols ospf area 0.0.0.0 interface lt-1/2/0.3
user@R1# set logical-systems LS2 protocols ospf area 0.0.0.0 interface lt-1/2/0.1
user@R1# set logical-systems LS2 protocols ospf area 0.0.0.0 interface lt-1/2/0.4
user@R1# set logical-systems LS1 protocols ospf area 0.0.0.0 interface lt-1/2/0.2

```

3. Configure the static route on Logical System LS3.

```

[edit]
user@R1# set logical-systems LS3 routing-options static route 10.0.16.0/30 next-hop
10.0.60.1

```

4. On Logical System LS3, redistribute the static route into OSPF.

```

[edit]
user@R1# set logical-systems LS3 protocols ospf export export_static
user@R1# set logical-systems LS3 policy-options policy-statement export_static
from protocol static
user@R1# set logical-systems LS3 policy-options policy-statement export_static
then accept

```

5. On Logical System LS2, configure the OSPF import policy.

```

[edit]
user@R1# set logical-systems LS2 protocols ospf import filter_routes
user@R1# set logical-systems LS2 policy-options policy-statement filter_routes
from route-filter 10.0.16.0/30 exact
user@R1# set logical-systems LS2 policy-options policy-statement filter_routes
then reject

```

6. If you are done configuring the device, commit the configuration.

```

[edit]
user@R1# commit

```

Confirm your configuration by issuing the `show logical-systems` command.

```

user@R1# show logical-systems
LS1 {
  interfaces {
    lt-1/2/0 {
      unit 2 {
        description LS1->LS2;
        encapsulation ethernet;
        peer-unit 1;
        family inet {
          address 10.0.0.1/30;
        }
      }
    }
  }
  protocols {

```

```
ospf {
  area 0.0.0.0 {
    interface lt-1/2/0.2;
  }
}
LS2 {
  interfaces {
    lt-1/2/0 {
      unit 1 {
        description LS2->LS1;
        encapsulation ethernet;
        peer-unit 2;
        family inet {
          address 10.0.0.2/30;
        }
      }
      unit 4 {
        description LS2->LS3;
        encapsulation ethernet;
        peer-unit 3;
        family inet {
          address 10.0.2.2/30;
        }
      }
    }
  }
  protocols {
    ospf {
      import filter_routes;
      area 0.0.0.0 {
        interface lt-1/2/0.1;
        interface lt-1/2/0.4;
      }
    }
  }
  policy-options {
    policy-statement filter_routes {
      from {
        route-filter 10.0.16.0/30 exact;
      }
      then reject;
    }
  }
}
LS3 {
  interfaces {
    so-0/0/0 {
      unit 0 {
        family inet {
          address 10.0.60.2/30;
        }
      }
    }
    lt-1/2/0 {
```

```

    unit 3 {
      description LS3->LS2;
      encapsulation ethernet;
      peer-unit 4;
      family inet {
        address 10.0.2.1/30;
      }
    }
  }
}
protocols {
  ospf {
    export export_static;
    area 0.0.0.0 {
      interface lt-1/2/0.3;
    }
  }
}
policy-options {
  policy-statement export_static {
    from protocol static;
    then accept;
  }
}
routing-options {
  static {
    route 10.0.16.0/30 next-hop 10.0.60.1;
  }
}
}

```

Verification

Confirm that the configuration is working properly.

- [Viewing the OSPF Databases of the Logical Systems on page 92](#)
- [Viewing the Routing Tables of the Logical Systems on page 93](#)

Viewing the OSPF Databases of the Logical Systems

Purpose Verify that OSPF is advertising the static route.

Action user@R1> show ospf database logical-system all
 Logical-system: LS2

```

    OSPF database, Area 0.0.0.0
  Type      ID          Adv Rtr      Seq          Age  Opt  Cksum  Len
  Router    10.0.0.1      10.0.0.1    0x8000001f   107  0x22 0x8f59  36
  Router    *10.0.0.2     10.0.0.2    0x80000025   101  0x22 0x4074  48
  Router    10.0.2.1      10.0.2.1    0x80000018   107  0x22 0xab3a  36
  Network   10.0.0.1      10.0.0.1    0x80000001   107  0x22 0x7b94  32
  Network   10.0.2.1      10.0.2.1    0x8000000c   190  0x22 0x53ab  32
  OSPF AS SCOPE link state database
  Type      ID          Adv Rtr      Seq          Age  Opt  Cksum  Len
  Extern    10.0.16.0    10.0.2.1    0x80000007   1785 0x22 0x4147  36
  -----
  
```

```
Logical-system: LS1
```

```
OSPF database, Area 0.0.0.0
Type      ID          Adv Rtr      Seq          Age  Opt  Cksum  Len
Router   *10.0.0.1      10.0.0.1    0x8000001f  107 0x22 0x8f59 36
Router   10.0.0.2      10.0.0.2    0x80000025  103 0x22 0x4074 48
Router   10.0.2.1      10.0.2.1    0x80000018  109 0x22 0xab3a 36
Network  *10.0.0.1      10.0.0.1    0x80000001  107 0x22 0x7b94 32
Network  10.0.2.1      10.0.2.1    0x8000000c  192 0x22 0x53ab 32
```

```
OSPF AS SCOPE link state database
Type      ID          Adv Rtr      Seq          Age  Opt  Cksum  Len
Extern   10.0.16.0    10.0.2.1    0x80000007  1787 0x22 0x4147 36
-----
```

```
Logical-system: LS3
```

```
OSPF database, Area 0.0.0.0
Type      ID          Adv Rtr      Seq          Age  Opt  Cksum  Len
Router   10.0.0.1      10.0.0.1    0x8000001f  109 0x22 0x8f59 36
Router   10.0.0.2      10.0.0.2    0x80000025  103 0x22 0x4074 48
Router   *10.0.2.1      10.0.2.1    0x80000018  107 0x22 0xab3a 36
Network  10.0.0.1      10.0.0.1    0x80000001  109 0x22 0x7b94 32
Network  *10.0.2.1      10.0.2.1    0x8000000c  190 0x22 0x53ab 32
```

```
OSPF AS SCOPE link state database
Type      ID          Adv Rtr      Seq          Age  Opt  Cksum  Len
Extern   *10.0.16.0    10.0.2.1    0x80000007  1785 0x22 0x4147 36
...

```

Meaning The Extern *10.0.16.0 output shows that OSPF is advertising the external route.

Viewing the Routing Tables of the Logical Systems

Purpose Make sure that Logical System LS3 and Logical System LS1 have the route to the 10.0.16.0/30 network installed in their respective routing tables. Make sure that Logical System LS2 does not have the route installed in its routing table.

```
Action user@R1> show route logical-system all
logical-system: LS2

inet.0: 5 destinations, 5 routes (5 active, 0 holddown, 0 hidden)
+ = Active Route, - = Last Active, * = Both

10.0.0.0/30      * [Direct/0] 04:22:19
                 > via lt-1/2/0.1
10.0.0.2/32      * [Local/0] 04:22:19
                 Local via lt-1/2/0.1
10.0.2.0/30      * [Direct/0] 04:22:19
                 > via lt-1/2/0.4
10.0.2.2/32      * [Local/0] 04:22:19
                 Local via lt-1/2/0.4
224.0.0.5/32    * [OSPF/10] 04:22:23, metric 1
                 MultiRecv
-----

logical-system: LS1
```

```
inet.0: 5 destinations, 5 routes (5 active, 0 holddown, 0 hidden)
+ = Active Route, - = Last Active, * = Both
```

```
10.0.0.0/30      *[Direct/0] 04:22:19
                 > via lt-1/2/0.2
10.0.0.1/32     *[Local/0] 04:22:19
                 Local via lt-1/2/0.2
10.0.2.0/30     *[OSPF/10] 00:07:52, metric 2
                 > to 10.0.0.2 via lt-1/2/0.2
10.0.16.0/30    *[OSPF/150] 00:07:52, metric 0, tag 0
                 > to 10.0.0.2 via lt-1/2/0.2
224.0.0.5/32    *[OSPF/10] 04:22:23, metric 1
                 MultiRecv
```

```
-----
```

```
logical-system: LS3
```

```
inet.0: 7 destinations, 7 routes (7 active, 0 holddown, 0 hidden)
+ = Active Route, - = Last Active, * = Both
```

```
10.0.0.0/30     *[OSPF/10] 00:07:57, metric 2
                 > to 10.0.2.2 via lt-1/2/0.3
10.0.2.0/30     *[Direct/0] 04:22:19
                 > via lt-1/2/0.3
10.0.2.1/32     *[Local/0] 04:22:19
                 Local via lt-1/2/0.3
10.0.16.0/30    *[Static/5] 03:51:18
                 > to 10.0.60.1 via so-0/0/0.0
10.0.60.0/30    *[Direct/0] 03:53:52
                 > via so-0/0/0.0
10.0.60.2/32    *[Local/0] 03:53:58
                 Local via so-0/0/0.0
224.0.0.5/32    *[OSPF/10] 04:22:23, metric 1
                 MultiRecv
```

Meaning The route to 10.0.16.0/30 is not installed in Logical System LS2's routing table. The route to 10.0.16.0/30 is installed in Logical System LS1's routing table as a route learned from OSPF. Because it is an OSPF external route, it has a preference value of 150 (instead of 10). By default, routes resulting from OSPF external LSAs are installed with a preference value of 150. The route to 10.0.16.0/30 is installed in Logical System LS3's routing table as a static route.

Related Documentation

- [Introduction to Logical Systems on page 3](#)

Examples: Configuring IS-IS on Logical Systems

- [IS-IS Overview on page 95](#)
- [Example: Configuring IS-IS on Logical Systems Within the Same Router on page 99](#)
- [Example: Configuring an IS-IS Default Route Policy on Logical Systems on page 108](#)

IS-IS Overview

The IS-IS protocol is an interior gateway protocol (IGP) that uses link-state information to make routing decisions.

IS-IS is a link-state IGP that uses the shortest-path-first (SPF) algorithm to determine routes. IS-IS evaluates the topology changes and determines whether to perform a full SPF recalculation or a partial route calculation (PRC). This protocol originally was developed for routing International Organization for Standardization (ISO) Connectionless Network Protocol (CLNP) packets.

Like OSPF routing, IS-IS uses hello packets that allow network convergence to occur quickly when network changes are detected. IS-IS uses the SPF algorithm to determine routes. Using SPF, IS-IS evaluates network topology changes and determines if a full or partial route calculation is required.



NOTE: Because IS-IS uses ISO addresses, the configuration of IP version 6 (IPv6) and IP version 4 (IPv4) implementations of IS-IS is identical.

This section discusses the following topics:

- [IS-IS Terminology on page 95](#)
- [ISO Network Addresses on page 96](#)
- [IS-IS Packets on page 97](#)
- [Persistent Route Reachability on page 98](#)
- [IS-IS Support for Multipoint Network Clouds on page 98](#)
- [Installing a Default Route to the Nearest Routing Device That Operates at Both IS-IS Levels on page 98](#)

IS-IS Terminology

An IS-IS network is a single autonomous system (AS), also called a *routing domain*, that consists of *end systems* and *intermediate systems*. End systems are network entities that send and receive packets. Intermediate systems send and receive packets and relay (forward) packets. (Intermediate system is the Open System Interconnection [OSI] term for a router.) ISO packets are called network PDUs.

In IS-IS, a single AS can be divided into smaller groups called *areas*. Routing between areas is organized hierarchically, allowing a domain to be administratively divided into smaller areas. This organization is accomplished by configuring *Level 1* and *Level 2* intermediate systems. Level 1 systems route within an area; when the destination is outside an area, they route toward a Level 2 system. Level 2 intermediate systems route between areas and toward other ASs. No IS-IS area functions strictly as a backbone.

Level 1 routers share intra-area routing information, and Level 2 routers share interarea information about IP addresses available within each area. Uniquely, IS-IS routers can act as both Level 1 and Level 2 routers, sharing intra-area routes with other Level 1 routers and interarea routes with other Level 2 routers.

The propagation of link-state updates is determined by the level boundaries. All routers within a level maintain a complete link-state database of all other routers in the same level. Each router then uses the Dijkstra algorithm to determine the shortest path from the local router to other routers in the link-state database.

ISO Network Addresses

IS-IS uses ISO network addresses. Each address identifies a point of connection to the network, such as a router interface, and is called a *network service access point (NSAP)*.

IS-IS supports multiple NSAP addresses on the loopback lo0 interface.

An end system can have multiple NSAP addresses, in which case the addresses differ only by the last byte (called the *n-selector*). Each NSAP represents a service that is available at that node. In addition to having multiple services, a single node can belong to multiple areas.

Each network entity also has a special network address called a *network entity title (NET)*. Structurally, an NET is identical to an NSAP address but has an n-selector of 00. Most end systems and intermediate systems have one NET. Intermediate systems that participate in multiple areas can have multiple NETs.

The following ISO addresses illustrate the IS-IS address format:

```
49.0001.00a0.c96b.c490.00
49.0001.2081.9716.9018.00
```

NETs take several forms, depending on your network requirements. NET addresses are hexadecimal and range from 8 octets to 20 octets in length. Generally, the format consists of an authority and format Identifier (AFI), a domain ID, an area ID, a system identifier, and a selector. The simplest format omits the domain ID and is 10 octets long. For example, the NET address 49.0001.1921.6800.1001.00 consists of the following parts:

- 49—AFI
- 0001—Area ID
- 1921.6800.1001—System identifier
- 00—Selector

The system identifier must be unique within the network. For an IP-only network, we recommend using the IP address of an interface on the router. Configuring a loopback NET address with the IP address is helpful when troubleshooting is required on the network.

The first portion of the address is the area number, which is a variable number from 1 through 13 bytes. The first byte of the area number (49) is the authority and format indicator (AFI). The next bytes are the assigned domain (area) identifier, which can be from 0 through 12 bytes. In the examples above, the area identifier is 0001.

The next six bytes form the system identifier. The system identifier can be any six bytes that are unique throughout the entire domain. The system identifier commonly is the media access control (MAC) address (as in the first example, 00a0.c96b.c490) or the

IP address expressed in binary-coded decimal (BCD) (as in the second example, 2081.9716.9018, which corresponds to IP address 208.197.169.18). The last byte (00) is the n-selector.



NOTE: The system identifier cannot be 0000.0000.0000. All 0s is an illegal setting, and the adjacency is not formed with this setting.

To provide help with IS-IS debugging, the Junos[®] operating system (Junos OS) supports dynamic mapping of ISO system identifiers to the hostname. Each system can be configured with a hostname, which allows the system identifier-to-hostname mapping to be carried in a dynamic hostname type, length, and value (TLV) tuple in IS-IS link-state PDUs. This enables intermediate systems in the routing domain to learn about the ISO system identifier of a particular intermediate system.

IS-IS Packets

Each IS-IS PDU shares a common header. IS-IS uses the following PDUs to exchange protocol information:

- IS-IS hello (IIH) PDUs—Broadcast to discover the identity of neighboring IS-IS systems and to determine whether the neighbors are Level 1 or Level 2 intermediate systems.

IS-IS hello PDUs establish adjacencies with other routers and have three different formats: one for point-to-point hello packets, one for Level 1 broadcast links, and one for Level 2 broadcast links. Level 1 routers must share the same area address to form an adjacency, while Level 2 routers do not have this limitation. The request for adjacency is encoded in the Circuit type field of the PDU.

Hello PDUs have a preset length assigned to them. The IS-IS router does not resize any PDU to match the maximum transmission unit (MTU) on a router interface. Each interface supports the maximum IS-IS PDU of 1492 bytes, and hello PDUs are padded to meet the maximum value. When the hello is sent to a neighboring router, the connecting interface supports the maximum PDU size.

- Link-state PDUs—Contain information about the state of adjacencies to neighboring IS-IS systems. Link-state PDUs are flooded periodically throughout an area.

Also included is metric and IS-IS neighbor information. Each link-state PDU must be refreshed periodically on the network and is acknowledged by information within a sequence number PDU.

On point-to-point links, each link-state PDU is acknowledged by a partial sequence number PDU (PSNP), but on broadcast links, a complete sequence number PDU (CSNP) is sent out over the network. Any router that finds newer link-state PDU information in the CSNP then purges the out-of-date entry and updates the link-state database.

Link-state PDUs support variable-length subnet mask addressing.

- Complete sequence number PDUs (CSNPs)—Contain a complete list of all link-state PDUs in the IS-IS database. CSNPs are sent periodically on all links, and the receiving systems use the information in the CSNP to update and synchronize their link-state

PDU databases. The designated router multicasts CSNPs on broadcast links in place of sending explicit acknowledgments for each link-state PDU.

Contained within the CSNP is a link-state PDU identifier, a lifetime, a sequence number, and a checksum for each entry in the database. Periodically, a CSNP is sent on both broadcast and point-to-point links to maintain a correct database. Also, the advertisement of CSNPs occurs when an adjacency is formed with another router. Like IS-IS hello PDUs, CSNPs come in two types: Level 1 and Level 2.

When a device receives a CSNP, it checks the database entries against its own local link-state database. If it detects missing information, the device requests specific link-state PDU details using a partial sequence number PDU (PSNP).

- Partial sequence number PDUs (PSNPs)—Sent multicast by a receiver when it detects that it is missing a link-state PDU (when its link-state PDU database is out of date). The receiver sends a PSNP to the system that transmitted the CSNP, effectively requesting that the missing link-state PDU be transmitted. That routing device, in turn, forwards the missing link-state PDU to the requesting routing device.

A PSNP is used by an IS-IS router to request link-state PDU information from a neighboring router. A PSNP can also explicitly acknowledge the receipt of a link-state PDU on a point-to-point link. On a broadcast link, a CSNP is used as implicit knowledge. Like hello PDUs and CSNPs, the PSNP also has two types: Level 1 and Level 2.

When a device compares a CSNP to its local database and determines that a link-state PDU is missing, the router issues a PSNP for the missing link-state PDU, which is returned in a link-state PDU from the router sending the CSNP. The received link-state PDU is then stored in the local database, and an acknowledgment is sent back to the originating router.

Persistent Route Reachability

IPv4 and IPv6 route reachability information in IS-IS link-state PDUs is preserved when you commit a configuration. IP prefixes are preserved with their original packet fragment upon link-state PDU regeneration.

IS-IS Support for Multipoint Network Clouds

IS-IS does not support multipoint configurations. Therefore, when configuring Frame Relay or Asynchronous Transfer Mode (ATM) networks, you must configure them as collections of point-to-point links, not as multipoint clouds.

Installing a Default Route to the Nearest Routing Device That Operates at Both IS-IS Levels

When a routing device that operates as both a Level 1 and Level 2 router (Router B) determines that it can reach at least one area other than its own (for example, in Area Y), it sets the ATTACHED bit in its Level 1 link-state PDU. Thereafter, the Level 1 router (Router A) introduces a default route pointing to the nearest attached routing device that operates as both a Level 1 and Level 2 router (Router B). See [Figure 17 on page 99](#).

Figure 17: Install Default Route to Nearest Routing Device That Operates at Both Level 1 and Level 2

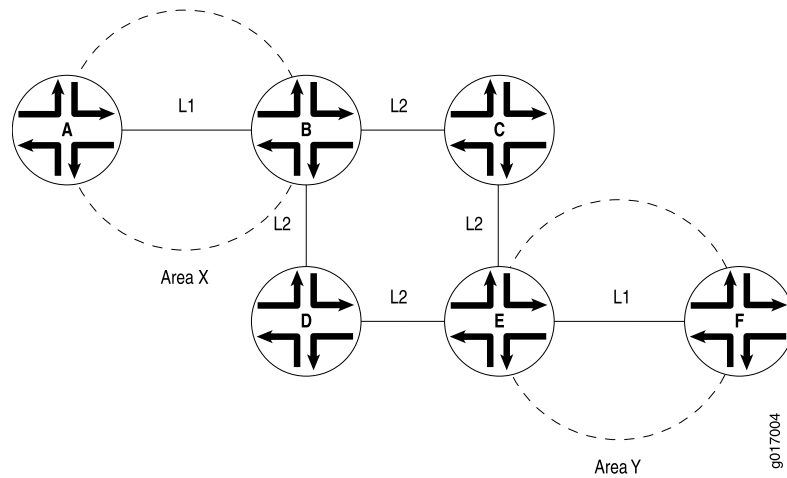

Example: Configuring IS-IS on Logical Systems Within the Same Router

This example shows how to configure an IS-IS network by using multiple logical systems that are running on a single physical router. The logical systems are connected by logical tunnel interfaces.

- [Requirements on page 99](#)
- [Overview on page 99](#)
- [Configuration on page 100](#)
- [Verification on page 105](#)

Requirements

You must connect the logical systems by using logical tunnel (lt) interfaces. See [“Example: Connecting Logical Systems Within the Same Router Using Logical Tunnel Interfaces”](#) on page 28.

Overview

This example shows an IS-IS configuration with three logical systems running on one physical router. Each logical system has its own routing table. The configuration enables the protocol on all logical tunnel interfaces that participate in the IS-IS domain.

[Figure 18 on page 100](#) shows the sample network.

Figure 18: IS-IS on Logical Systems

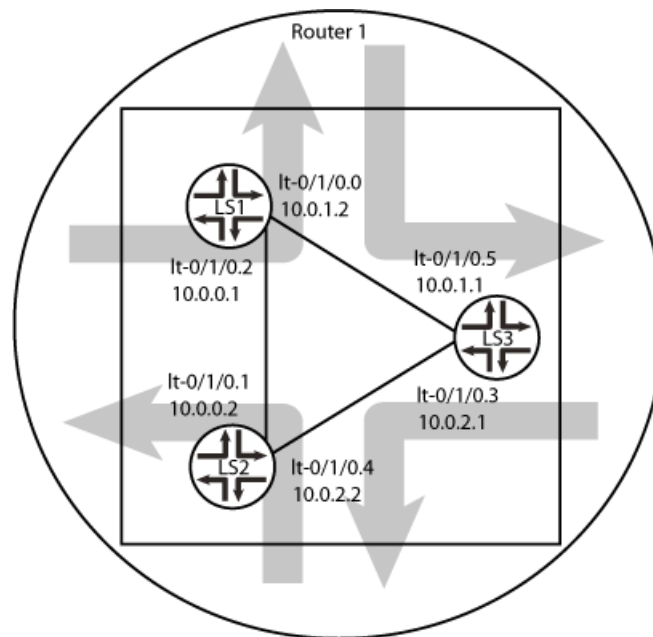

Configuration

CLI Quick Configuration

To quickly configure this example, copy the following commands, paste them into a text file, remove any line breaks, change any details necessary to match your network configuration, and then copy and paste the commands into the CLI at the **[edit]** hierarchy level.

```

set logical-systems LS1 interfaces lt-0/1/0 unit 2 description LS1->LS2
set logical-systems LS1 interfaces lt-0/1/0 unit 2 encapsulation ethernet
set logical-systems LS1 interfaces lt-0/1/0 unit 2 peer-unit 1
set logical-systems LS1 interfaces lt-0/1/0 unit 2 family inet address 10.0.0.1/30
set logical-systems LS1 interfaces lt-0/1/0 unit 2 family iso
set logical-systems LS1 interfaces lt-0/1/0 unit 0 description LS1->LS3
set logical-systems LS1 interfaces lt-0/1/0 unit 0 encapsulation ethernet
set logical-systems LS1 interfaces lt-0/1/0 unit 0 peer-unit 5
set logical-systems LS1 interfaces lt-0/1/0 unit 0 family inet address 10.0.1.2/30
set logical-systems LS1 interfaces lt-0/1/0 unit 0 family iso
set logical-systems LS1 interfaces lo0 unit 1 family iso address 49.0001.1720.1600.1001.00
set logical-systems LS1 protocols isis interface lt-0/1/0.0
set logical-systems LS1 protocols isis interface lt-0/1/0.2
set logical-systems LS1 protocols isis interface lo0.1 passive
set logical-systems LS2 interfaces lt-0/1/0 unit 1 description LS2->LS1
set logical-systems LS2 interfaces lt-0/1/0 unit 1 encapsulation ethernet
set logical-systems LS2 interfaces lt-0/1/0 unit 1 peer-unit 2
set logical-systems LS2 interfaces lt-0/1/0 unit 1 family inet address 10.0.0.2/30
set logical-systems LS2 interfaces lt-0/1/0 unit 1 family iso
set logical-systems LS2 interfaces lt-0/1/0 unit 4 description LS2->LS3
set logical-systems LS2 interfaces lt-0/1/0 unit 4 encapsulation ethernet
set logical-systems LS2 interfaces lt-0/1/0 unit 4 peer-unit 3
set logical-systems LS2 interfaces lt-0/1/0 unit 4 family inet address 10.0.2.2/30
set logical-systems LS2 interfaces lt-0/1/0 unit 4 family iso

```

```

set logical-systems LS2 interfaces lo0 unit 2 family iso address
  49.0001.1720.1600.2002.00
set logical-systems LS2 protocols isis interface lt-0/1/0.1
set logical-systems LS2 protocols isis interface lt-0/1/0.4
set logical-systems LS2 protocols isis interface lo0.2 passive
set logical-systems LS3 interfaces lt-0/1/0 unit 3 description LS3->LS2
set logical-systems LS3 interfaces lt-0/1/0 unit 3 encapsulation ethernet
set logical-systems LS3 interfaces lt-0/1/0 unit 3 peer-unit 4
set logical-systems LS3 interfaces lt-0/1/0 unit 3 family inet address 10.0.2.1/30
set logical-systems LS3 interfaces lt-0/1/0 unit 3 family iso
set logical-systems LS3 interfaces lt-0/1/0 unit 5 description LS3->LS1
set logical-systems LS3 interfaces lt-0/1/0 unit 5 encapsulation ethernet
set logical-systems LS3 interfaces lt-0/1/0 unit 5 peer-unit 0
set logical-systems LS3 interfaces lt-0/1/0 unit 5 family inet address 10.0.1.1/30
set logical-systems LS3 interfaces lt-0/1/0 unit 5 family iso
set logical-systems LS3 interfaces lo0 unit 3 family iso address 49.0001.1234.1600.2231.00
set logical-systems LS3 protocols isis interface lt-0/1/0.5
set logical-systems LS3 protocols isis interface lt-0/1/0.3
set logical-systems LS3 protocols isis interface lo0.3 passive

```

Step-by-Step Procedure The following example requires you to navigate various levels in the configuration hierarchy. For information about navigating the CLI, see *Using the CLI Editor in Configuration Mode in the CLI User Guide*.

To configure IS-IS on logical systems:

1. Configure the logical tunnel interface on Logical System LS1 connecting to Logical System LS2.

```

[edit logical-systems LS1]
user@host# set interfaces lt-0/1/0 unit 2 description LS1->LS2
user@host# set interfaces lt-0/1/0 unit 2 encapsulation ethernet
user@host# set interfaces lt-0/1/0 unit 2 peer-unit 1
user@host# set interfaces lt-0/1/0 unit 2 family inet address 10.0.0.1/30
user@host# set interfaces lt-0/1/0 unit 2 family iso

```

2. Configure the logical tunnel interface on Logical System LS1 connecting to Logical System LS3.

```

[edit logical-systems LS1]
user@host# set interfaces lt-0/1/0 unit 0 description LS1->LS3
user@host# set interfaces lt-0/1/0 unit 0 encapsulation ethernet
user@host# set interfaces lt-0/1/0 unit 0 peer-unit 5
user@host# set interfaces lt-0/1/0 unit 0 family inet address 10.0.1.2/30
user@host# set interfaces lt-0/1/0 unit 0 family iso

```

3. Configure the logical tunnel interface on Logical System LS2 connecting to Logical System LS1.

```

[edit logical-systems LS2]
user@host# set interfaces lt-0/1/0 unit 1 description LS2->LS1
user@host# set interfaces lt-0/1/0 unit 1 encapsulation ethernet
user@host# set interfaces lt-0/1/0 unit 1 peer-unit 2
user@host# set interfaces lt-0/1/0 unit 1 family inet address 10.0.0.2/30
user@host# set interfaces lt-0/1/0 unit 1 family iso

```

4. Configure the logical tunnel interface on Logical System LS2 connecting to Logical System LS3.

```
[edit logical-systems LS2]
user@host# set interfaces lt-0/1/0 unit 4 description LS2->LS3
user@host# set interfaces lt-0/1/0 unit 4 encapsulation ethernet
user@host# set interfaces lt-0/1/0 unit 4 peer-unit 3
user@host# set interfaces lt-0/1/0 unit 4 family inet address 10.0.2.2/30
user@host# set interfaces lt-0/1/0 unit 4 family iso
```

5. Configure the logical tunnel interface on Logical System LS3 connecting to Logical System LS2.

```
[edit logical-systems LS3]
user@host# set interfaces lt-0/1/0 unit 3 description LS3->LS2
user@host# set interfaces lt-0/1/0 unit 3 encapsulation ethernet
user@host# set interfaces lt-0/1/0 unit 3 peer-unit 4
user@host# set interfaces lt-0/1/0 unit 3 family inet address 10.0.2.1/30
user@host# set interfaces lt-0/1/0 unit 3 family iso
```

6. Configure the logical tunnel interface on Logical System LS3 connecting to Logical System LS1.

```
[edit logical-systems LS3]
user@host# set interfaces lt-0/1/0 unit 5 description LS3->LS1
user@host# set interfaces lt-0/1/0 unit 5 encapsulation ethernet
user@host# set interfaces lt-0/1/0 unit 5 peer-unit 0
user@host# set interfaces lt-0/1/0 unit 5 family inet address 10.0.1.1/30
user@host# set interfaces lt-0/1/0 unit 5 family iso
```

7. Configure the ISO address on the loopback interface for the three logical systems.

```
[edit logical-systems LS1]
user@host# set interfaces lo0 unit 1 family iso address 49.0001.1720.1600.1001.00
user@host# set protocols isis interface lo0.1 passive
```

```
[edit logical-systems LS2]
user@host# set interfaces lo0 unit 2 family iso address 49.0001.1720.1600.2002.00
user@host# set protocols isis interface lo0.2 passive
```

```
[edit logical-systems LS3]
user@host# set interfaces lo0 unit 3 family iso address 49.0001.1234.1600.2231.00
user@host# set protocols isis interface lo0.3 passive
```

8. Configure IS-IS on all the interfaces.

```
[edit logical-systems LS1 protocols isis]
user@host# set interface lt-0/1/0.0
user@host# set interface lt-0/1/0.2
```

```
[edit logical-systems LS2 protocols isis]
user@host# set interface lt-0/1/0.1
user@host# set interface lt-0/1/0.4
```

```
[edit logical-systems LS3 protocols isis]
user@host# set interface lt-0/1/0.5
user@host# set interface lt-0/1/0.3
```

9. If you are done configuring the device, commit the configuration.

```
[edit]
```

```
user@host# commit
```

From configuration mode, confirm your configuration by issuing the **show logical-systems** command. If the output does not display the intended configuration, repeat the instructions in this example to correct the configuration.

```
user@host# show logical-systems
LS1 {
  interfaces {
    lt-0/1/0 {
      unit 0 {
        description LS1->LS3;
        encapsulation ethernet;
        peer-unit 5;
        family inet {
          address 10.0.1.2/30;
        }
        family iso;
      }
      unit 2 {
        description LS1->LS2;
        encapsulation ethernet;
        peer-unit 1;
        family inet {
          address 10.0.0.1/30;
        }
        family iso;
      }
    }
    lo0 {
      unit 1 {
        family iso {
          address 49.0001.1720.1600.1001.00;
        }
      }
    }
  }
  protocols {
    isis {
      interface lt-0/1/0.0;
      interface lt-0/1/0.2;
      interface lo0.1 {
        passive;
      }
    }
  }
}
LS2 {
  interfaces {
    lt-0/1/0 {
      unit 1 {
        description LS2->LS1;
        encapsulation ethernet;
        peer-unit 2;
        family inet {
          address 10.0.0.2/30;
        }
        family iso;
      }
      unit 4 {
```

```
        description LS2->LS3;
        encapsulation ethernet;
        peer-unit 3;
        family inet {
            address 10.0.2.2/30;
        }
        family iso;
    }
}
lo0 {
    unit 2 {
        family iso {
            address 49.0001.1720.1600.2002.00;
        }
    }
}
}
protocols {
    isis {
        interface lt-0/1/0.1;
        interface lt-0/1/0.4;
        interface lo0.2 {
            passive;
        }
    }
}
}
LS3 {
    interfaces {
        lt-0/1/0 {
            unit 3 {
                description LS3->LS2;
                encapsulation ethernet;
                peer-unit 4;
                family inet {
                    address 10.0.2.1/30;
                }
                family iso;
            }
            unit 5 {
                description LS3->LS1;
                encapsulation ethernet;
                peer-unit 0;
                family inet {
                    address 10.0.1.1/30;
                }
                family iso;
            }
        }
    }
    lo0 {
        unit 3 {
            family iso {
                address 49.0001.1234.1600.2231.00;
            }
        }
    }
}
}
protocols {
    isis {
        interface lt-0/1/0.3;
```



```

        interface lt-0/1/0.5;
        interface lo0.3 {
            passive;
        }
    }
}

```

Verification

Confirm that the configuration is working properly.

- [Verifying That the Logical Systems Are Up on page 105](#)
- [Verifying Connectivity Between the Logical Systems on page 105](#)

Verifying That the Logical Systems Are Up

Purpose Make sure that the interfaces are properly configured.

```

Action user@host> show interfaces terse
Interface          Admin Link Proto  Local          Remote
...
lt-0/1/0           up    up
lt-0/1/0.0         up    up    inet   10.0.1.2/30
                  iso
lt-0/1/0.1         up    up    inet   10.0.0.2/30
                  iso
lt-0/1/0.2         up    up    inet   10.0.0.1/30
                  iso
lt-0/1/0.3         up    up    inet   10.0.2.1/30
                  iso
lt-0/1/0.4         up    up    inet   10.0.2.2/30
                  iso
lt-0/1/0.5         up    up    inet   10.0.1.1/30
                  iso
...

```

Verifying Connectivity Between the Logical Systems

Purpose Make sure that the IS-IS adjacencies are established by checking the logical system routing entries and by pinging the logical systems.

```

Action user@host> show route logical-system LSI
inet.0: 5 destinations, 5 routes (5 active, 0 holddown, 0 hidden)
+ = Active Route, - = Last Active, * = Both

10.0.0.0/30        *[Direct/0] 3w0d 01:37:52
                  > via lt-0/1/0.2
10.0.0.1/32        *[Local/0] 3w0d 01:37:52
                  Local via lt-0/1/0.2
10.0.1.0/30        *[Direct/0] 3w0d 01:37:52
                  > via lt-0/1/0.0
10.0.1.2/32        *[Local/0] 3w0d 01:37:52
                  Local via lt-0/1/0.0
10.0.2.0/30        *[IS-IS/15] 3w0d 01:37:13, metric 20
                  > to 10.0.1.1 via lt-0/1/0.0
                  to 10.0.0.2 via lt-0/1/0.2

```

```
iso.0: 1 destinations, 1 routes (1 active, 0 holddown, 0 hidden)
+ = Active Route, - = Last Active, * = Both
```

```
49.0001.1720.1600.1001/72
    * [Direct/0] 3w0d 01:37:52
    > via lo0.1
```

```
user@host> show route logical-system LS2
```

```
inet.0: 5 destinations, 5 routes (5 active, 0 holddown, 0 hidden)
+ = Active Route, - = Last Active, * = Both
```

```
10.0.0.0/30      * [Direct/0] 3w0d 01:38:01
                  > via lt-0/1/0.1
10.0.0.2/32      * [Local/0] 3w0d 01:38:01
                  Local via lt-0/1/0.1
10.0.1.0/30      * [IS-IS/15] 3w0d 01:37:01, metric 20
                  to 10.0.0.1 via lt-0/1/0.1
                  > to 10.0.2.1 via lt-0/1/0.4
10.0.2.0/30      * [Direct/0] 3w0d 01:38:01
                  > via lt-0/1/0.4
10.0.2.2/32      * [Local/0] 3w0d 01:38:01
                  Local via lt-0/1/0.4
```

```
iso.0: 1 destinations, 1 routes (1 active, 0 holddown, 0 hidden)
+ = Active Route, - = Last Active, * = Both
```

```
49.0001.1720.1600.2002/72
    * [Direct/0] 3w0d 01:38:01
    > via lo0.2
```

```
user@host> show route logical-system LS3
```

```
inet.0: 5 destinations, 5 routes (5 active, 0 holddown, 0 hidden)
+ = Active Route, - = Last Active, * = Both
```

```
10.0.0.0/30      * [IS-IS/15] 3w0d 01:37:10, metric 20
                  to 10.0.2.2 via lt-0/1/0.3
                  > to 10.0.1.2 via lt-0/1/0.5
10.0.1.0/30      * [Direct/0] 3w0d 01:38:10
                  > via lt-0/1/0.5
10.0.1.1/32      * [Local/0] 3w0d 01:38:11
                  Local via lt-0/1/0.5
10.0.2.0/30      * [Direct/0] 3w0d 01:38:11
                  > via lt-0/1/0.3
10.0.2.1/32      * [Local/0] 3w0d 01:38:11
                  Local via lt-0/1/0.3
```

```
iso.0: 1 destinations, 1 routes (1 active, 0 holddown, 0 hidden)
+ = Active Route, - = Last Active, * = Both
```

```
49.0001.1234.1600.2231/72
    * [Direct/0] 3w0d 01:38:11
    > via lo0.3
```

From LS1, Ping LS3 user@host> set cli logical-system LS1

```
user@host:LS1> ping 10.0.2.1
PING 10.0.2.1 (10.0.2.1): 56 data bytes
64 bytes from 10.0.2.1: icmp_seq=0 ttl=63 time=1.264 ms
64 bytes from 10.0.2.1: icmp_seq=1 ttl=63 time=1.189 ms
64 bytes from 10.0.2.1: icmp_seq=2 ttl=63 time=1.165 ms
```

```

^C
--- 10.0.2.1 ping statistics ---
3 packets transmitted, 3 packets received, 0% packet loss
round-trip min/avg/max/stddev = 1.165/1.206/1.264/0.042 ms

```

From LS3, Ping LS1 user@host> set cli logical-system LS3

```

user@host:LS3> ping 10.0.0.1
PING 10.0.0.1 (10.0.0.1): 56 data bytes
64 bytes from 10.0.0.1: icmp_seq=0 ttl=63 time=1.254 ms
64 bytes from 10.0.0.1: icmp_seq=1 ttl=63 time=1.210 ms
^C
--- 10.0.0.1 ping statistics ---
2 packets transmitted, 2 packets received, 0% packet loss
round-trip min/avg/max/stddev = 1.210/1.232/1.254/0.022 ms

```

From LS1, Ping LS2 user@host> set cli logical-system LS1

```

user@host:LS1> ping 10.0.2.2
PING 10.0.2.2 (10.0.2.2): 56 data bytes
64 bytes from 10.0.2.2: icmp_seq=0 ttl=64 time=1.240 ms
64 bytes from 10.0.2.2: icmp_seq=1 ttl=64 time=1.204 ms
64 bytes from 10.0.2.2: icmp_seq=2 ttl=64 time=1.217 ms
^C
--- 10.0.2.2 ping statistics ---
3 packets transmitted, 3 packets received, 0% packet loss
round-trip min/avg/max/stddev = 1.204/1.220/1.240/0.015 ms

```

From LS2, Ping LS1 user@host> set cli logical-system LS2

```

user@host:LS2> ping 10.0.1.2
PING 10.0.1.2 (10.0.1.2): 56 data bytes
64 bytes from 10.0.1.2: icmp_seq=0 ttl=64 time=1.308 ms
64 bytes from 10.0.1.2: icmp_seq=1 ttl=64 time=1.235 ms
^C
--- 10.0.1.2 ping statistics ---
2 packets transmitted, 2 packets received, 0% packet loss
round-trip min/avg/max/stddev = 1.235/1.272/1.308/0.037 ms

```

From LS2, Ping LS3 user@host> set cli logical-system LS2

```

user@host:LS2> ping 10.0.1.1
PING 10.0.1.1 (10.0.1.1): 56 data bytes
64 bytes from 10.0.1.1: icmp_seq=0 ttl=64 time=1.253 ms
64 bytes from 10.0.1.1: icmp_seq=1 ttl=64 time=1.194 ms
64 bytes from 10.0.1.1: icmp_seq=2 ttl=64 time=1.212 ms
64 bytes from 10.0.1.1: icmp_seq=3 ttl=64 time=1.221 ms
64 bytes from 10.0.1.1: icmp_seq=4 ttl=64 time=1.195 ms
^C
--- 10.0.1.1 ping statistics ---
5 packets transmitted, 5 packets received, 0% packet loss
round-trip min/avg/max/stddev = 1.194/1.215/1.253/0.022 ms

```

From LS3, Ping LS2 user@host> set cli logical-system LS3

```

user@host:LS3> ping 10.0.0.2
PING 10.0.0.2 (10.0.0.2): 56 data bytes
64 bytes from 10.0.0.2: icmp_seq=0 ttl=64 time=1.240 ms
64 bytes from 10.0.0.2: icmp_seq=1 ttl=64 time=1.217 ms
^C
--- 10.0.0.2 ping statistics ---

```

2 packets transmitted, 2 packets received, 0% packet loss
 round-trip min/avg/max/stddev = 1.217/1.228/1.240/0.012 ms

Example: Configuring an IS-IS Default Route Policy on Logical Systems

This example shows logical systems configured on a single physical router and explains how to configure a default route on one logical system.

- [Requirements on page 108](#)
- [Overview on page 108](#)
- [Configuration on page 109](#)
- [Verification on page 111](#)

Requirements

No special configuration beyond device initialization is required before configuring this example.

Overview

This example shows a logical system redistributing a default route to other logical systems. All logical systems are running IS-IS. A common reason for a default route is to provide a path for sending traffic destined outside the IS-IS domain.

In this example, the default route is not used for forwarding traffic. The **no-install** statement prevents the route from being installed in the forwarding table of Logical System LS3. If you configure a route so it is not installed in the forwarding table, the route is still eligible to be exported from the routing table to other protocols. The **discard** statement silently drops packets without notice.

[Figure 19 on page 108](#) shows the sample network.

Figure 19: IS-IS with a Default Route to an ISP

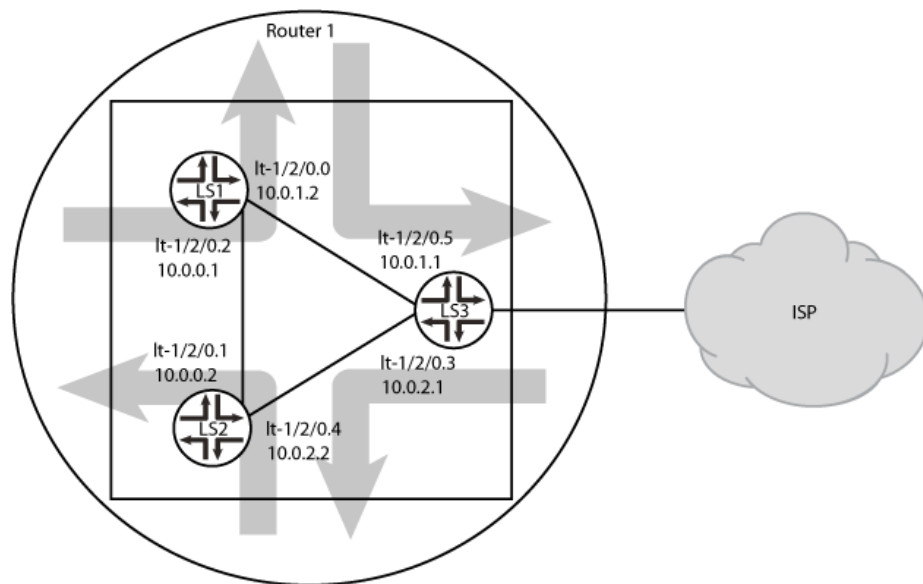

g040918

Configuration

CLI Quick Configuration To quickly configure this example, copy the following commands, paste them into a text file, remove any line breaks, change any details necessary to match your network configuration, and then copy and paste the commands into the CLI at the **[edit]** hierarchy level.

```
set logical-systems LS3 interfaces lt-1/2/0 unit 3 description LS3->LS2
set logical-systems LS3 interfaces lt-1/2/0 unit 3 encapsulation ethernet
set logical-systems LS3 interfaces lt-1/2/0 unit 3 peer-unit 4
set logical-systems LS3 interfaces lt-1/2/0 unit 3 family inet address 10.0.2.1/30
set logical-systems LS3 interfaces lt-1/2/0 unit 3 family iso
set logical-systems LS3 interfaces lt-1/2/0 unit 5 description LS3->LS1
set logical-systems LS3 interfaces lt-1/2/0 unit 5 encapsulation ethernet
set logical-systems LS3 interfaces lt-1/2/0 unit 5 peer-unit 0
set logical-systems LS3 interfaces lt-1/2/0 unit 5 family inet address 10.0.1.1/30
set logical-systems LS3 interfaces lt-1/2/0 unit 5 family iso
set logical-systems LS3 interfaces lo0 unit 3 family iso address 49.0001.1234.1600.2231.00
set logical-systems LS3 protocols isis export isis-default
set logical-systems LS3 protocols isis interface lt-1/2/0.3
set logical-systems LS3 protocols isis interface lt-1/2/0.5
set logical-systems LS3 protocols isis interface lo0.3 passive
set logical-systems LS3 routing-options static route 0.0.0.0/0 discard
set logical-systems LS3 routing-options static route 0.0.0.0/0 no-install
set logical-systems LS3 policy-options policy-statement isis-default from protocol static
set logical-systems LS3 policy-options policy-statement isis-default from route-filter
  0.0.0.0/0 exact
set logical-systems LS3 policy-options policy-statement isis-default then accept
```

Step-by-Step Procedure The following example requires you to navigate various levels in the configuration hierarchy. For information about navigating the CLI, see Using the CLI Editor in Configuration Mode in the CLI User Guide.

To configure an IS-IS default route policy on logical systems:

1. Configure the logical tunnel interfaces.

```
[edit logical-systems LS3 interfaces lt-1/2/0]
user@R1# set unit 3 description LS3->LS2
user@R1# set unit 3 encapsulation ethernet
user@R1# set unit 3 peer-unit 4
user@R1# set unit 3 family inet address 10.0.2.1/30
user@R1# set unit 3 family iso
user@R1# set unit 5 description LS3->LS1
user@R1# set unit 5 encapsulation ethernet
user@R1# set unit 5 peer-unit 0
user@R1# set unit 5 family inet address 10.0.1.1/30
user@R1# set unit 5 family iso
[edit logical-systems LS3 interfaces lo0 unit 3]
user@R1# set family iso address 49.0001.1234.1600.2231.00
```

2. Enable IS-IS on the interfaces.

```
[edit logical-systems LS3 protocols isis]
user@R1# set interface lt-1/2/0.3
```

- ```

user@R1# set interface lt-1/2/0.5
user@R1# set interface lo0.3 passive

```
- Configure the default route on Logical System LS3.

```

[edit logical-systems LS3 routing-options]
user@R1# set static route 0.0.0.0/0 discard
user@R1# set static route 0.0.0.0/0 no-install

```
  - Configure the default route policy on Logical System LS3.

```

[edit logical-systems LS3 policy-options]
user@R1# set policy-statement isis-default from protocol static
user@R1# set policy-statement isis-default from route-filter 0.0.0.0/0 exact
user@R1# set policy-statement isis-default then accept

```
  - Apply the export policy to IS-IS on Logical System LS3.

```

[edit logical-systems LS3 protocols isis]
user@R1# set export isis-default

```
  - If you are done configuring the device, commit the configuration.

```

[edit]
user@R1# commit

```

### Results

From configuration mode, confirm your configuration by issuing the **show logical-systems LS3** command. If the output does not display the intended configuration, repeat the instructions in this example to correct the configuration.

```

user@R1# show logical-systems LS3
interfaces {
 lt-1/2/0 {
 unit 3 {
 description LS3->LS2;
 encapsulation ethernet;
 peer-unit 4;
 family inet {
 address 10.0.2.1/30;
 }
 family iso;
 }
 unit 5 {
 description LS3->LS1;
 encapsulation ethernet;
 peer-unit 0;
 family inet {
 address 10.0.1.1/30;
 }
 family iso;
 }
 }
}
lo0 {
 unit 3 {
 family iso {

```

```

 address 49.0001.1234.1600.2231.00;
 }
}
}
}
protocols {
 isis {
 export isis-default;
 interface lt-1/2/0.3;
 interface lt-1/2/0.5;
 interface lo0.3 {
 passive;
 }
 }
}
policy-options {
 policy-statement isis-default {
 from {
 protocol static;
 route-filter 0.0.0.0/0 exact;
 }
 then accept;
 }
}
routing-options {
 static {
 route 0.0.0.0/0 {
 discard;
 no-install;
 }
 }
}
}
}

```

### Verification

Confirm that the configuration is working properly.

#### *Verifying That the Static Route Is Redistributed*

**Purpose** Make sure that the IS-IS policy is working by checking the routing tables.

**Action**

```

user@R1> show route logical-system LS3
inet.0: 6 destinations, 6 routes (6 active, 0 holddown, 0 hidden)
+ = Active Route, - = Last Active, * = Both

0.0.0.0/0 *[Static/5] 00:00:45
 Discard
10.0.0.0/30 *[IS-IS/15] 1w0d 10:14:14, metric 20
 to 10.0.2.2 via lt-1/2/0.3
 > to 10.0.1.2 via lt-1/2/0.5
10.0.1.0/30 *[Direct/0] 1w0d 10:15:18
 > via lt-1/2/0.5
10.0.1.1/32 *[Local/0] 1w0d 10:15:18
 Local via lt-1/2/0.5
10.0.2.0/30 *[Direct/0] 1w0d 10:15:18
 > via lt-1/2/0.3

```

```

10.0.2.1/32 *[Local/0] 1w0d 10:15:18
 Local via lt-1/2/0.3

iso.0: 1 destinations, 1 routes (1 active, 0 holddown, 0 hidden)
+ = Active Route, - = Last Active, * = Both

49.0001.1234.1600.2231/72
 *[Direct/0] 1w0d 10:17:19
 > via lo0.3

user@R1> show route logical-system LS2
inet.0: 6 destinations, 6 routes (6 active, 0 holddown, 0 hidden)
+ = Active Route, - = Last Active, * = Both

0.0.0.0/0 *[IS-IS/160] 00:01:38, metric 10
 > to 10.0.2.1 via lt-1/2/0.4
10.0.0.0/30 *[Direct/0] 1w0d 10:16:11
 > via lt-1/2/0.1
10.0.0.2/32 *[Local/0] 1w0d 10:16:11
 Local via lt-1/2/0.1
10.0.1.0/30 *[IS-IS/15] 1w0d 10:15:07, metric 20
 > to 10.0.0.1 via lt-1/2/0.1
 to 10.0.2.1 via lt-1/2/0.4
10.0.2.0/30 *[Direct/0] 1w0d 10:16:11
 > via lt-1/2/0.4
10.0.2.2/32 *[Local/0] 1w0d 10:16:11
 Local via lt-1/2/0.4

iso.0: 1 destinations, 1 routes (1 active, 0 holddown, 0 hidden)
+ = Active Route, - = Last Active, * = Both

49.0001.1720.1600.2002/72
 *[Direct/0] 1w0d 10:18:12
 > via lo0.2

user@R1> show route logical-system LS1
inet.0: 6 destinations, 6 routes (6 active, 0 holddown, 0 hidden)
+ = Active Route, - = Last Active, * = Both

0.0.0.0/0 *[IS-IS/160] 00:02:01, metric 10
 > to 10.0.1.1 via lt-1/2/0.0
10.0.0.0/30 *[Direct/0] 1w0d 10:16:34
 > via lt-1/2/0.2
10.0.0.1/32 *[Local/0] 1w0d 10:16:34
 Local via lt-1/2/0.2
10.0.1.0/30 *[Direct/0] 1w0d 10:16:34
 > via lt-1/2/0.0
10.0.1.2/32 *[Local/0] 1w0d 10:16:34
 Local via lt-1/2/0.0
10.0.2.0/30 *[IS-IS/15] 1w0d 10:15:55, metric 20
 to 10.0.1.1 via lt-1/2/0.0
 > to 10.0.0.2 via lt-1/2/0.2

iso.0: 1 destinations, 1 routes (1 active, 0 holddown, 0 hidden)
+ = Active Route, - = Last Active, * = Both

49.0001.1720.1600.1001/72
 *[Direct/0] 1w0d 10:18:35
 > via lo0.1

```



**Meaning** The routing table on Logical System LS3 contains the default 0.0.0.0/0 route from protocol **IS-IS**. The routing tables on Logical System LS1 and Logical System LS2 contain the default 0.0.0.0/0 route from protocol **IS-IS**. If Logical System LS1 and Logical System LS2 receive packets destined for networks not specified in their routing tables, those packets will be sent to Logical System LS3 for further processing. This configuration assumes that Logical System LS3 has a connection to an ISP or another external network.

## Examples: Configuring BGP on Logical Systems

- [Understanding BGP on page 113](#)
- [Example: Configuring Internal BGP Peering Sessions on Logical Systems on page 115](#)
- [Example: Configuring External BGP on Logical Systems with IPv6 Interfaces on page 125](#)
- [Example: Configuring BFD on Internal BGP Peer Sessions on page 140](#)
- [Example: Configuring EBGP Multihop Sessions on Logical Systems on page 149](#)

## Understanding BGP

BGP is an exterior gateway protocol (EGP) that is used to exchange routing information among routers in different autonomous systems (ASs). BGP routing information includes the complete route to each destination. BGP uses the routing information to maintain a database of network reachability information, which it exchanges with other BGP systems. BGP uses the network reachability information to construct a graph of AS connectivity, which enables BGP to remove routing loops and enforce policy decisions at the AS level.

Multiprotocol BGP (MBGP) extensions enable BGP to support IP version 6 (IPv6). MBGP defines the attributes `MP_REACH_NLRI` and `MP_UNREACH_NLRI`, which are used to carry IPv6 reachability information. Network layer reachability information (NLRI) update messages carry IPv6 address prefixes of feasible routes.

BGP allows for policy-based routing. You can use routing policies to choose among multiple paths to a destination and to control the redistribution of routing information.

BGP uses TCP as its transport protocol, using port 179 for establishing connections. Running over a reliable transport protocol eliminates the need for BGP to implement update fragmentation, retransmission, acknowledgment, and sequencing.

The Junos OS routing protocol software supports BGP version 4. This version of BGP adds support for Classless Interdomain Routing (CIDR), which eliminates the concept of network classes. Instead of assuming which bits of an address represent the network by looking at the first octet, CIDR allows you to explicitly specify the number of bits in the network address, thus providing a means to decrease the size of the routing tables. BGP version 4 also supports aggregation of routes, including the aggregation of AS paths.

This section discusses the following topics:

- [Autonomous Systems on page 114](#)
- [AS Paths and Attributes on page 114](#)

- [External and Internal BGP on page 114](#)
- [Multiple Instances of BGP on page 115](#)

## Autonomous Systems

An *autonomous system* (AS) is a set of routers that are under a single technical administration and normally use a single interior gateway protocol and a common set of metrics to propagate routing information within the set of routers. To other ASs, an AS appears to have a single, coherent interior routing plan and presents a consistent picture of what destinations are reachable through it.

## AS Paths and Attributes

The routing information that BGP systems exchange includes the complete route to each destination, as well as additional information about the route. The route to each destination is called the *AS path*, and the additional route information is included in *path attributes*. BGP uses the AS path and the path attributes to completely determine the network topology. Once BGP understands the topology, it can detect and eliminate routing loops and select among groups of routes to enforce administrative preferences and routing policy decisions.

## External and Internal BGP

BGP supports two types of exchanges of routing information: exchanges among different ASs and exchanges within a single AS. When used among ASs, BGP is called *external BGP* (EBGP) and BGP sessions perform *inter-AS routing*. When used within an AS, BGP is called *internal BGP* (IBGP) and BGP sessions perform *intra-AS routing*. [Figure 20 on page 114](#) illustrates ASs, IBGP, and EBGP.

Figure 20: ASs, EBGP, and IBGP

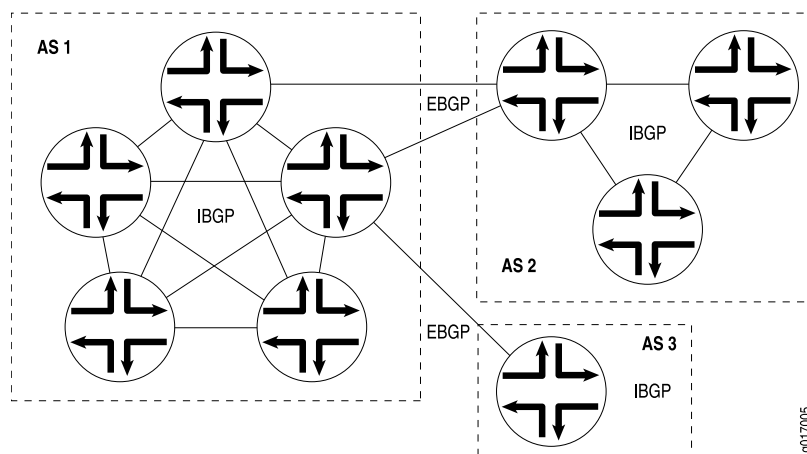

A BGP system shares network reachability information with adjacent BGP systems, which are referred to as *neighbors* or *peers*.

BGP systems are arranged into *groups*. In an IBGP group, all peers in the group—called *internal peers*—are in the same AS. Internal peers can be anywhere in the local AS and do not have to be directly connected to one another. Internal groups use routes from an IGP to resolve forwarding addresses. They also propagate external routes among all

other internal routers running IBGP, computing the next hop by taking the BGP next hop received with the route and resolving it using information from one of the interior gateway protocols.

In an EBGP group, the peers in the group—called *external peers*—are in different ASs and normally share a subnet. In an external group, the next hop is computed with respect to the interface that is shared between the external peer and the local router.

### Multiple Instances of BGP

You can configure multiple instances of BGP at the following hierarchy levels:

- [edit routing-instances *routing-instance-name* protocols]
- [edit logical-systems *logical-system-name* routing-instances *routing-instance-name* protocols]

Multiple instances of BGP are primarily used for Layer 3 VPN support.

IGP peers and external BGP (EBGP) peers (both nonmultihop and multihop) are all supported for routing instances. BGP peering is established over one of the interfaces configured under the **routing-instances** hierarchy.



**NOTE:** When a BGP neighbor sends BGP messages to the local routing device, the incoming interface on which these messages are received must be configured in the same routing instance that the BGP neighbor configuration exists in. This is true for neighbors that are a single hop away or multiple hops away.

Routes learned from the BGP peer are added to the **instance-name.inet.0** table by default. You can configure import and export policies to control the flow of information into and out of the instance routing table.

For Layer 3 VPN support, configure BGP on the provider edge (PE) router to receive routes from the customer edge (CE) router and to send the instances' routes to the CE router if necessary. You can use multiple instances of BGP to maintain separate per-site forwarding tables for keeping VPN traffic separate on the PE router.

You can configure import and export policies that allow the service provider to control and rate-limit traffic to and from the customer.

You can configure an EBGP multihop session for a VRF routing instance. Also, you can set up the EBGP peer between the PE and CE routers by using the loopback address of the CE router instead of the interface addresses.

### Example: Configuring Internal BGP Peering Sessions on Logical Systems

This example shows how to configure internal BGP peer sessions on logical systems.

- [Requirements on page 116](#)
- [Overview on page 116](#)

- [Configuration on page 116](#)
- [Verification on page 123](#)

## Requirements

In this example, no special configuration beyond device initialization is required.

## Overview

In this example, you configure internal BGP (IBGP) peering sessions.

In the sample network, the devices in AS 17 are fully meshed in the group `internal-peers`. The devices have loopback addresses 192.168.6.5, 192.163.6.4, and 192.168.40.4.

[Figure 21 on page 116](#) shows a typical network with internal peer sessions.

**Figure 21: Typical Network with IBGP Sessions**

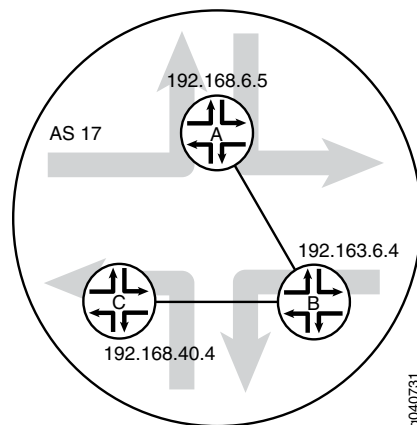

## Configuration

### CLI Quick Configuration

To quickly configure this example, copy the following commands, paste them into a text file, remove any line breaks, change any details necessary to match your network configuration, and then copy and paste the commands into the CLI at the `[edit]` hierarchy level.

```
set logical-systems A interfaces lt-0/1/0 unit 1 description to-B
set logical-systems A interfaces lt-0/1/0 unit 1 encapsulation ethernet
set logical-systems A interfaces lt-0/1/0 unit 1 peer-unit 2
set logical-systems A interfaces lt-0/1/0 unit 1 family inet address 10.10.10.1/30
set logical-systems A interfaces lo0 unit 1 family inet address 192.168.6.5/32
set logical-systems A protocols bgp group internal-peers type internal
set logical-systems A protocols bgp group internal-peers local-address 192.168.6.5
set logical-systems A protocols bgp group internal-peers export send-direct
set logical-systems A protocols bgp group internal-peers neighbor 192.163.6.4
set logical-systems A protocols bgp group internal-peers neighbor 192.168.40.4
set logical-systems A protocols ospf area 0.0.0.0 interface lo0.1 passive
set logical-systems A protocols ospf area 0.0.0.0 interface lt-0/1/0.1
set logical-systems A policy-options policy-statement send-direct term 2 from protocol direct
set logical-systems A policy-options policy-statement send-direct term 2 then accept
```

```

set logical-systems A routing-options router-id 192.168.6.5
set logical-systems A routing-options autonomous-system 17
set logical-systems B interfaces lt-0/1/0 unit 2 description to-A
set logical-systems B interfaces lt-0/1/0 unit 2 encapsulation ethernet
set logical-systems B interfaces lt-0/1/0 unit 2 peer-unit 1
set logical-systems B interfaces lt-0/1/0 unit 2 family inet address 10.10.10.2/30
set logical-systems B interfaces lt-0/1/0 unit 5 description to-C
set logical-systems B interfaces lt-0/1/0 unit 5 encapsulation ethernet
set logical-systems B interfaces lt-0/1/0 unit 5 peer-unit 6
set logical-systems B interfaces lt-0/1/0 unit 5 family inet address 10.10.10.5/30
set logical-systems B interfaces lo0 unit 2 family inet address 192.163.6.4/32
set logical-systems B protocols bgp group internal-peers type internal
set logical-systems B protocols bgp group internal-peers local-address 192.163.6.4
set logical-systems B protocols bgp group internal-peers export send-direct
set logical-systems B protocols bgp group internal-peers neighbor 192.168.40.4
set logical-systems B protocols bgp group internal-peers neighbor 192.168.6.5
set logical-systems B protocols ospf area 0.0.0.0 interface lo0.2 passive
set logical-systems B protocols ospf area 0.0.0.0 interface lt-0/1/0.2
set logical-systems B protocols ospf area 0.0.0.0 interface lt-0/1/0.5
set logical-systems B policy-options policy-statement send-direct term 2 from protocol
 direct
set logical-systems B policy-options policy-statement send-direct term 2 then accept
set logical-systems B routing-options router-id 192.163.6.4
set logical-systems B routing-options autonomous-system 17
set logical-systems C interfaces lt-0/1/0 unit 6 description to-B
set logical-systems C interfaces lt-0/1/0 unit 6 encapsulation ethernet
set logical-systems C interfaces lt-0/1/0 unit 6 peer-unit 5
set logical-systems C interfaces lt-0/1/0 unit 6 family inet address 10.10.10.6/30
set logical-systems C interfaces lo0 unit 3 family inet address 192.168.40.4/32
set logical-systems C protocols bgp group internal-peers type internal
set logical-systems C protocols bgp group internal-peers local-address 192.168.40.4
set logical-systems C protocols bgp group internal-peers export send-direct
set logical-systems C protocols bgp group internal-peers neighbor 192.163.6.4
set logical-systems C protocols bgp group internal-peers neighbor 192.168.6.5
set logical-systems C protocols ospf area 0.0.0.0 interface lo0.3 passive
set logical-systems C protocols ospf area 0.0.0.0 interface lt-0/1/0.6
set logical-systems C policy-options policy-statement send-direct term 2 from protocol
 direct
set logical-systems C policy-options policy-statement send-direct term 2 then accept
set logical-systems C routing-options router-id 192.168.40.4
set logical-systems C routing-options autonomous-system 17

```

### Device A

#### Step-by-Step Procedure

The following example requires you to navigate various levels in the configuration hierarchy. For information about navigating the CLI, see *Using the CLI Editor in Configuration Mode in the CLI User Guide*.

To configure internal BGP peer sessions on Device A:

1. Configure the interfaces.

```

[edit logical-systems A interfaces lt-0/1/0 unit 1]
user@R1# set description to-B
user@R1# set encapsulation ethernet
user@R1# set peer-unit 2

```

```
user@R1# set family inet address 10.10.10.1/30
user@R1# set family inet address 192.168.6.5/32
user@R1# up
user@R1# up
[edit logical-systems A interfaces]
user@R1# set lo0 unit 1 family inet address 192.168.6.5/32
user@R1# exit
[edit]
user@R1# edit logical-systems B interfaces lt-0/1/0
[edit logical-systems B interfaces lt-0/1/0]
user@R1# set unit 2 description to-A
user@R1# set unit 2 encapsulation ethernet
user@R1# set unit 2 peer-unit 1
user@R1# set unit 2 family inet address 10.10.10.2/30
user@R1# set unit 5 description to-C
user@R1# set unit 5 encapsulation ethernet
user@R1# set unit 5 peer-unit 6
user@R1# set family inet address 10.10.10.5/30
user@R1# up
[edit logical-systems B interfaces]
user@R1# set lo0 unit 2 family inet address 192.163.6.4/32
user@R1# exit
[edit]
user@R1# edit logical-systems C interfaces lt-0/1/0 unit 6
[edit logical-systems C interfaces lt-0/1/0 unit 6]
set description to-B
set encapsulation ethernet
set peer-unit 5
set family inet address 10.10.10.6/30
user@R1# up
user@R1# up
[edit logical-systems C interfaces]
set lo0 unit 3 family inet address 192.168.40.4/32
```

2. Configure BGP.

On Logical System A, the **neighbor** statements are included for both Device B and Device C, even though Logical System A is not directly connected to Device C.

```
[edit logical-systems A protocols bgp group internal-peers]
user@R1# set type internal
user@R1# set local-address 192.168.6.5
user@R1# set export send-direct
user@R1# set neighbor 192.163.6.4
user@R1# set neighbor 192.168.40.4
```

```
[edit logical-systems B protocols bgp group internal-peers]
user@R1# set type internal
user@R1# set local-address 192.163.6.4
user@R1# set export send-direct
user@R1# set neighbor 192.168.40.4
user@R1# set neighbor 192.168.6.5
```

```
[edit logical-systems C protocols bgp group internal-peers]
user@R1# set type internal
user@R1# set local-address 192.168.40.4
```

```

user@R1# set export send-direct
user@R1# set neighbor 192.163.6.4
user@R1# set neighbor 192.168.6.5

```

3. Configure OSPF.

```

[edit logical-systems A protocols ospf area 0.0.0.0]
user@R1# set interface lo0.1 passive
user@R1# set interface lt-0/1/0.1

```

```

[edit logical-systems A protocols ospf area 0.0.0.0]
user@R1# set interface lo0.2 passive
user@R1# set interface lt-0/1/0.2
user@R1# set interface lt-0/1/0.5

```

```

[edit logical-systems A protocols ospf area 0.0.0.0]
user@R1# set interface lo0.3 passive
user@R1# set interface lt-0/1/0.6

```

4. Configure a policy that accepts direct routes.

Other useful options for this scenario might be to accept routes learned through OSPF or local routes.

```

[edit logical-systems A policy-options policy-statement send-direct term 2]
user@R1# set from protocol direct
user@R1# set then accept

```

```

[edit logical-systems B policy-options policy-statement send-direct term 2]
user@R1# set from protocol direct
user@R1# set then accept

```

```

[edit logical-systems C policy-options policy-statement send-direct term 2]
user@R1# set from protocol direct
user@R1# set then accept

```

5. Configure the router ID and the autonomous system (AS) number.

```

[edit logical-systems A routing-options]
user@R1# set router-id 192.168.6.5
user@R1# set autonomous-system 17

```

```

[edit logical-systems B routing-options]
user@R1# set router-id 192.163.6.4
user@R1# set autonomous-system 17

```

```

[edit logical-systems C routing-options]
user@R1# set router-id 192.168.40.4
user@R1# set autonomous-system 17

```

**Results** From configuration mode, confirm your configuration by entering the **show logical-systems** command. If the output does not display the intended configuration, repeat the configuration instructions in this example to correct it.

```

user@R1# show logical-systems

```

```
A {
 interfaces {
 lt-0/1/0 {
 unit 1 {
 description to-B;
 encapsulation ethernet;
 peer-unit 2;
 family inet {
 address 10.10.10.1/30;
 }
 }
 }
 lo0 {
 unit 1 {
 family inet {
 address 192.168.6.5/32;
 }
 }
 }
 }
 protocols {
 bgp {
 group internal-peers {
 type internal;
 local-address 192.168.6.5;
 export send-direct;
 neighbor 192.163.6.4;
 neighbor 192.168.40.4;
 }
 }
 ospf {
 area 0.0.0.0 {
 interface lo0.1 {
 passive;
 }
 interface lt-0/1/0.1;
 }
 }
 }
 policy-options {
 policy-statement send-direct {
 term 2 {
 from protocol direct;
 then accept;
 }
 }
 }
 routing-options {
 router-id 192.168.6.5;
 autonomous-system 17;
 }
}
B {
 interfaces {
 lt-0/1/0 {
 unit 2 {
```



```
 description to-A;
 encapsulation ethernet;
 peer-unit 1;
 family inet {
 address 10.10.10.2/30;
 }
 }
 unit 5 {
 description to-C;
 encapsulation ethernet;
 peer-unit 6;
 family inet {
 address 10.10.10.5/30;
 }
 }
}
lo0 {
 unit 2 {
 family inet {
 address 192.163.6.4/32;
 }
 }
}
}
protocols {
 bgp {
 group internal-peers {
 type internal;
 local-address 192.163.6.4;
 export send-direct;
 neighbor 192.168.40.4;
 neighbor 192.168.6.5;
 }
 }
 ospf {
 area 0.0.0.0 {
 interface lo0.2 {
 passive;
 }
 interface lt-0/1/0.2;
 interface lt-0/1/0.5;
 }
 }
}
policy-options {
 policy-statement send-direct {
 term 2 {
 from protocol direct;
 then accept;
 }
 }
}
}
routing-options {
 router-id 192.163.6.4;
 autonomous-system 17;
}
```

```
}
C {
 interfaces {
 lt-0/1/0 {
 unit 6 {
 description to-B;
 encapsulation ethernet;
 peer-unit 5;
 family inet {
 address 10.10.10.6/30;
 }
 }
 }
 lo0 {
 unit 3 {
 family inet {
 address 192.168.40.4/32;
 }
 }
 }
 }
 protocols {
 bgp {
 group internal-peers {
 type internal;
 local-address 192.168.40.4;
 export send-direct;
 neighbor 192.163.6.4;
 neighbor 192.168.6.5;
 }
 }
 ospf {
 area 0.0.0.0 {
 interface lo0.3 {
 passive;
 }
 interface lt-0/1/0.6;
 }
 }
 }
 policy-options {
 policy-statement send-direct {
 term 2 {
 from protocol direct;
 then accept;
 }
 }
 }
 routing-options {
 router-id 192.168.40.4;
 autonomous-system 17;
 }
}
```

If you are done configuring the device, enter **commit** from configuration mode.

## Verification

Confirm that the configuration is working properly.

- [Verifying BGP Neighbors on page 123](#)
- [Verifying BGP Groups on page 124](#)
- [Verifying BGP Summary Information on page 124](#)
- [Verifying That BGP Routes Are Installed in the Routing Table on page 125](#)

### Verifying BGP Neighbors

**Purpose** Verify that BGP is running on configured interfaces and that the BGP session is active for each neighbor address.

**Action** From the operational mode, enter the `show bgp neighbor` command.

```

user@R1> show bgp neighbor logical-system A
Peer: 192.163.6.4+179 AS 17 Local: 192.168.6.5+58852 AS 17
 Type: Internal State: Established Flags: <Sync>
 Last State: OpenConfirm Last Event: RecvKeepAlive
 Last Error: None
 Export: [send-direct]
 Options: <Preference LocalAddress Refresh>
 Local Address: 192.168.6.5 Holdtime: 90 Preference: 170
 Number of flaps: 0
 Peer ID: 192.163.6.4 Local ID: 192.168.6.5 Active Holdtime: 90
 Keepalive Interval: 30 Peer index: 0
 BFD: disabled, down
 NLRI for restart configured on peer: inet-unicast
 NLRI advertised by peer: inet-unicast
 NLRI for this session: inet-unicast
 Peer supports Refresh capability (2)
 Restart time configured on the peer: 120
 Stale routes from peer are kept for: 300
 Restart time requested by this peer: 120
 NLRI that peer supports restart for: inet-unicast
 NLRI that restart is negotiated for: inet-unicast
 NLRI of received end-of-rib markers: inet-unicast
 NLRI of all end-of-rib markers sent: inet-unicast
 Peer supports 4 byte AS extension (peer-as 17)
 Peer does not support Addpath
 Table inet.0 Bit: 10000
 RIB State: BGP restart is complete
 Send state: in sync
 Active prefixes: 0
 Received prefixes: 3
 Accepted prefixes: 3
 Suppressed due to damping: 0
 Advertised prefixes: 2
 Last traffic (seconds): Received 16 Sent 1 Checked 63
 Input messages: Total 15713 Updates 4 Refreshes 0 Octets 298622
 Output messages: Total 15690 Updates 2 Refreshes 0 Octets 298222
 Output Queue[0]: 0

Peer: 192.168.40.4+179 AS 17 Local: 192.168.6.5+56466 AS 17
 Type: Internal State: Established Flags: <Sync>
 Last State: OpenConfirm Last Event: RecvKeepAlive
 Last Error: None

```

```

Export: [send-direct]
Options: <Preference LocalAddress Refresh>
Local Address: 192.168.6.5 Holdtime: 90 Preference: 170
Number of flaps: 0
Peer ID: 192.168.40.4 Local ID: 192.168.6.5 Active Holdtime: 90
Keepalive Interval: 30 Peer index: 1
BFD: disabled, down
NLRI for restart configured on peer: inet-unicast
NLRI advertised by peer: inet-unicast
NLRI for this session: inet-unicast
Peer supports Refresh capability (2)
Restart time configured on the peer: 120
Stale routes from peer are kept for: 300
Restart time requested by this peer: 120
NLRI that peer supports restart for: inet-unicast
NLRI that restart is negotiated for: inet-unicast
NLRI of received end-of-rib markers: inet-unicast
NLRI of all end-of-rib markers sent: inet-unicast
Peer supports 4 byte AS extension (peer-as 17)
Peer does not support Addpath
Table inet.0 Bit: 10000
 RIB State: BGP restart is complete
 Send state: in sync
 Active prefixes: 0
 Received prefixes: 2
 Accepted prefixes: 2
 Suppressed due to damping: 0
 Advertised prefixes: 2
Last traffic (seconds): Received 15 Sent 22 Checked 68
Input messages: Total 15688 Updates 2 Refreshes 0 Octets 298111
Output messages: Total 15688 Updates 2 Refreshes 0 Octets 298184
Output Queue[0]: 0

```

### Verifying BGP Groups

**Purpose** Verify that the BGP groups are configured correctly.

**Action** From the operational mode, enter the **show bgp group** command.

```

user@A> show bgp group logical-system A
Group Type: Internal AS: 17 Local AS: 17
Name: internal-peers Index: 0 Flags: <Export Eval>
Export: [send-direct]
Holdtime: 0
Total peers: 2 Established: 2
192.163.6.4+179
192.168.40.4+179
inet.0: 0/5/5/0

Groups: 1 Peers: 2 External: 0 Internal: 2 Down peers: 0 Flaps: 0
Table Tot Paths Act Paths Suppressed History Damp State Pending
inet.0 5 0 0 0 0 0

```

### Verifying BGP Summary Information

**Purpose** Verify that the BGP configuration is correct.

**Action** From the operational mode, enter the **show bgp summary** command.

```

user@A> show bgp summary logical-system A

```

```

Groups: 1 Peers: 2 Down peers: 0
Table Tot Paths Act Paths Suppressed History Damp State Pending
inet.0 5 0 0 0 0 0 0
Peer AS InPkt OutPkt OutQ Flaps Last Up/Dwn
State|#Active/Received/Accepted/Damped...
192.163.6.4 17 15723 15700 0 0 4d 22:13:15
0/3/3/0 0/0/0/0
192.168.40.4 17 15698 15699 0 0 4d 22:13:11
0/2/2/0 0/0/0/0

```

### Verifying That BGP Routes Are Installed in the Routing Table

**Purpose** Verify that the export policy configuration is working.

**Action** From the operational mode, enter the **show route protocol bgp** command.

```

user@A> show route protocol bgp logical-system A
inet.0: 7 destinations, 12 routes (7 active, 0 holddown, 0 hidden)
+ = Active Route, - = Last Active, * = Both

10.10.10.0/30 [BGP/170] 4d 11:05:55, localpref 100, from 192.163.6.4
 AS path: I
 > to 10.10.10.2 via 1t-0/1/0.1
10.10.10.4/30 [BGP/170] 4d 11:05:55, localpref 100, from 192.163.6.4
 AS path: I
 > to 10.10.10.2 via 1t-0/1/0.1
 [BGP/170] 4d 11:03:10, localpref 100, from 192.168.40.4
 AS path: I
 > to 10.10.10.2 via 1t-0/1/0.1
192.163.6.4/32 [BGP/170] 4d 11:05:55, localpref 100, from 192.163.6.4
 AS path: I
 > to 10.10.10.2 via 1t-0/1/0.1
192.168.40.4/32 [BGP/170] 4d 11:03:10, localpref 100, from 192.168.40.4
 AS path: I
 > to 10.10.10.2 via 1t-0/1/0.1

```

## Example: Configuring External BGP on Logical Systems with IPv6 Interfaces

This example shows how to configure external BGP (EBGP) point-to-point peer sessions on logical systems with IPv6 interfaces.

- [Requirements on page 125](#)
- [Overview on page 125](#)
- [Configuration on page 127](#)
- [Verification on page 136](#)

### Requirements

In this example, no special configuration beyond device initialization is required.

### Overview

Junos OS supports EBGP peer sessions by means of IPv6 addresses. An IPv6 peer session can be configured when an IPv6 address is specified in the **neighbor** statement. This example uses EUI-64 to generate IPv6 addresses that are automatically applied to the

interfaces. An EUI-64 address is an IPv6 address that uses the IEEE EUI-64 format for the interface identifier portion of the address (the last 64 bits).



**NOTE:** Alternatively, you can configure EBGp sessions using manually assigned 128-bit IPv6 addresses.

If you use 128-bit link-local addresses for the interfaces, you must include the `local-interface` statement. This statement is valid only for 128-bit IPv6 link-local addresses and is mandatory for configuring an IPv6 EBGp link-local peer session.

Configuring EBGp peering using link-local addresses is only applicable for directly connected interfaces. There is no support for multihop peering.

After your interfaces are up, you can use the `show interfaces terse` command to view the EUI-64-generated IPv6 addresses on the interfaces. You must use these generated addresses in the BGP `neighbor` statements. This example demonstrates the full end-to-end procedure.

In this example, Frame Relay interface encapsulation is applied to the logical tunnel (`lt`) interfaces. This is a requirement because only Frame Relay encapsulation is supported when IPv6 addresses are configured on the `lt` interfaces.

[Figure 22 on page 127](#) shows a network with BGP peer sessions. In the sample network, Router R1 has five logical systems configured. Device E in autonomous system (AS) 17 has BGP peer sessions to a group of peers called **external-peers**. Peers A, B, and C reside in AS 22. This example shows the step-by-step configuration on Logical System A and Logical System E.

Figure 22: Typical Network with BGP Peer Sessions

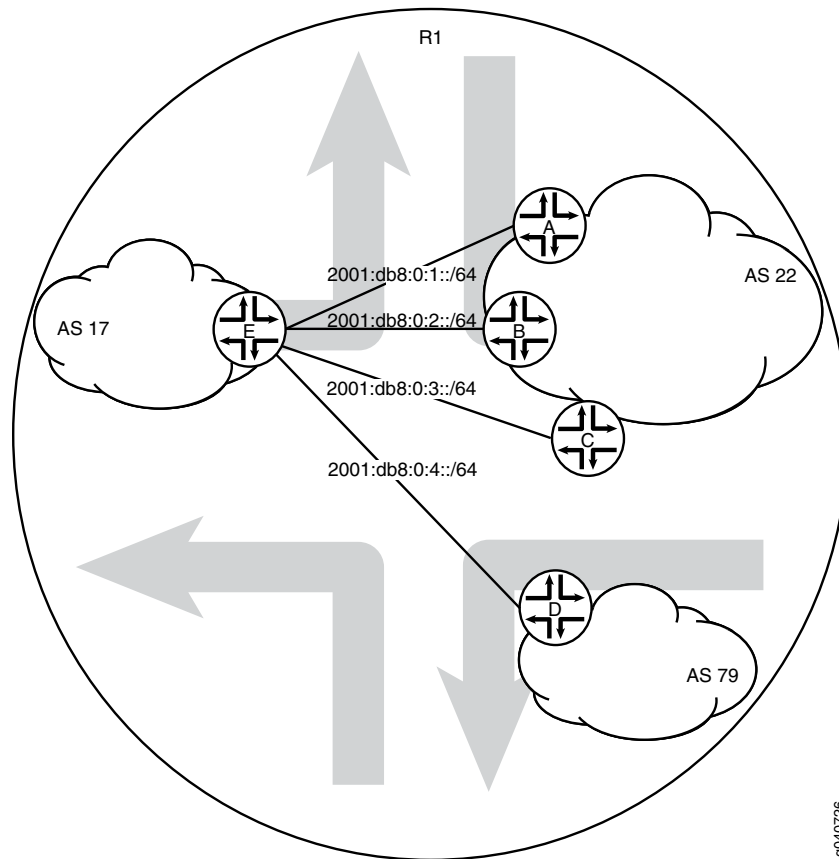

g040726

### Configuration

#### CLI Quick Configuration

To quickly configure this example, copy the following commands, paste them into a text file, remove any line breaks, change any details necessary to match your network configuration, and then copy and paste the commands into the CLI at the **[edit]** hierarchy level.

#### Device A

```
set logical-systems A interfaces lt-0/1/0 unit 1 description to-E
set logical-systems A interfaces lt-0/1/0 unit 1 encapsulation frame-relay
set logical-systems A interfaces lt-0/1/0 unit 1 dlci 1
set logical-systems A interfaces lt-0/1/0 unit 1 peer-unit 25
set logical-systems A interfaces lt-0/1/0 unit 1 family inet6 address 2001:db8:0:1::/64
 eui-64
set logical-systems A interfaces lo0 unit 1 family inet6 address 2001:db8::1/128
set logical-systems A protocols bgp group external-peers type external
set logical-systems A protocols bgp group external-peers peer-as 17
set logical-systems A protocols bgp group external-peers neighbor
 2001:db8:0:1:2a0:a502:0:19da
set logical-systems A routing-options router-id 1.1.1.1
set logical-systems A routing-options autonomous-system 22
```

#### Device B

```
set logical-systems B interfaces lt-0/1/0 unit 6 description to-E
set logical-systems B interfaces lt-0/1/0 unit 6 encapsulation frame-relay
set logical-systems B interfaces lt-0/1/0 unit 6 dlci 6
```

```
set logical-systems B interfaces lt-0/1/0 unit 6 peer-unit 5
set logical-systems B interfaces lt-0/1/0 unit 6 family inet6 address 2001:db8:0:2::/64
 eui-64
set logical-systems B interfaces lo0 unit 2 family inet6 address 2001:db8::2/128
set logical-systems B protocols bgp group external-peers type external
set logical-systems B protocols bgp group external-peers peer-as 17
set logical-systems B protocols bgp group external-peers neighbor
 2001:db8:0:2:2a0:a502:0:5da
set logical-systems B routing-options router-id 2.2.2.2
set logical-systems B routing-options autonomous-system 22
```

Device C

```
set logical-systems C interfaces lt-0/1/0 unit 10 description to-E
set logical-systems C interfaces lt-0/1/0 unit 10 encapsulation frame-relay
set logical-systems C interfaces lt-0/1/0 unit 10 dlci 10
set logical-systems C interfaces lt-0/1/0 unit 10 peer-unit 9
set logical-systems C interfaces lt-0/1/0 unit 10 family inet6 address 2001:db8:0:3::/64
 eui-64
set logical-systems C interfaces lo0 unit 3 family inet6 address 2001:db8::3/128
set logical-systems C protocols bgp group external-peers type external
set logical-systems C protocols bgp group external-peers peer-as 17
set logical-systems C protocols bgp group external-peers neighbor
 2001:db8:0:3:2a0:a502:0:9da
set logical-systems C routing-options router-id 3.3.3.3
set logical-systems C routing-options autonomous-system 22
```

Device D

```
set logical-systems D interfaces lt-0/1/0 unit 7 description to-E
set logical-systems D interfaces lt-0/1/0 unit 7 encapsulation frame-relay
set logical-systems D interfaces lt-0/1/0 unit 7 dlci 7
set logical-systems D interfaces lt-0/1/0 unit 7 peer-unit 21
set logical-systems D interfaces lt-0/1/0 unit 7 family inet6 address 2001:db8:0:4::/64
 eui-64
set logical-systems D interfaces lo0 unit 4 family inet6 address 2001:db8::4/128
set logical-systems D protocols bgp group external-peers type external
set logical-systems D protocols bgp group external-peers peer-as 17
set logical-systems D protocols bgp group external-peers neighbor
 2001:db8:0:4:2a0:a502:0:15da
set logical-systems D routing-options router-id 4.4.4.4
set logical-systems D routing-options autonomous-system 79
```

Device E

```
set logical-systems E interfaces lt-0/1/0 unit 5 description to-B
set logical-systems E interfaces lt-0/1/0 unit 5 encapsulation frame-relay
set logical-systems E interfaces lt-0/1/0 unit 5 dlci 6
set logical-systems E interfaces lt-0/1/0 unit 5 peer-unit 6
set logical-systems E interfaces lt-0/1/0 unit 5 family inet6 address 2001:db8:0:2::/64
 eui-64
set logical-systems E interfaces lt-0/1/0 unit 9 description to-C
set logical-systems E interfaces lt-0/1/0 unit 9 encapsulation frame-relay
set logical-systems E interfaces lt-0/1/0 unit 9 dlci 10
set logical-systems E interfaces lt-0/1/0 unit 9 peer-unit 10
set logical-systems E interfaces lt-0/1/0 unit 9 family inet6 address 2001:db8:0:3::/64
 eui-64
set logical-systems E interfaces lt-0/1/0 unit 21 description to-D
set logical-systems E interfaces lt-0/1/0 unit 21 encapsulation frame-relay
set logical-systems E interfaces lt-0/1/0 unit 21 dlci 7
set logical-systems E interfaces lt-0/1/0 unit 21 peer-unit 7
```



```

set logical-systems E interfaces lt-0/1/0 unit 21 family inet6 address 2001:db8:0:4::/64
 eui-64
set logical-systems E interfaces lt-0/1/0 unit 25 description to-A
set logical-systems E interfaces lt-0/1/0 unit 25 encapsulation frame-relay
set logical-systems E interfaces lt-0/1/0 unit 25 dlci 1
set logical-systems E interfaces lt-0/1/0 unit 25 peer-unit 1
set logical-systems E interfaces lt-0/1/0 unit 25 family inet6 address 2001:db8:0:1::/64
 eui-64
set logical-systems E interfaces lo0 unit 5 family inet6 address 2001:db8::5/128
set logical-systems E protocols bgp group external-peers type external
set logical-systems E protocols bgp group external-peers peer-as 22
set logical-systems E protocols bgp group external-peers neighbor
 2001:db8:0:1:2a0:a502:0:1da
set logical-systems E protocols bgp group external-peers neighbor
 2001:db8:0:2:2a0:a502:0:6da
set logical-systems E protocols bgp group external-peers neighbor
 2001:db8:0:3:2a0:a502:0:ada
set logical-systems E protocols bgp group external-peers neighbor
 2001:db8:0:4:2a0:a502:0:7da peer-as 79
set logical-systems E routing-options router-id 5.5.5.5
set logical-systems E routing-options autonomous-system 17

```

### Step-by-Step Procedure

The following example requires you to navigate various levels in the configuration hierarchy. For information about navigating the CLI, see *Using the CLI Editor in Configuration Mode in the CLI User Guide*.

To configure the BGP peer sessions:

1. Run the **show interfaces terse** command to verify that the physical router has a logical tunnel (lt) interface.

```

user@R1> show interfaces terse
Interface Admin Link Proto Local Remote
...
lt-0/1/0 up up
...

```

2. On Logical System A, configure the interface encapsulation, peer-unit number, and DLCI to reach Logical System E.

```

user@R1> set cli logical-system A
Logical system: A
[edit]
user@R1:A> edit
Entering configuration mode
[edit]
user@R1:A# edit interfaces
[edit interfaces]
user@R1:A# set lt-0/1/0 unit 1 encapsulation frame-relay
user@R1:A# set lt-0/1/0 unit 1 dlci 1
user@R1:A# set lt-0/1/0 unit 1 peer-unit 25

```

3. On Logical System A, configure the network address for the link to Peer E, and configure a loopback interface.

```

[edit interfaces]
user@R1:A# set lt-0/1/0 unit 1 description to-E

```

```

user@R1:A# set lt-0/1/0 unit 1 family inet6 address 2001:db8:0:1::/64 eui-64
user@R1:A# set lo0 unit 1 family inet6 address 2001:db8::1/128

```

- On Logical System E, configure the interface encapsulation, peer-unit number, and DLCI to reach Logical System A.

```

user@R1> set cli logical-system E
Logical system: E
[edit]
user@R1:E> edit
Entering configuration mode
[edit]
user@R1:E# edit interfaces
[edit interfaces]
user@R1:E# set lt-0/1/0 unit 25 encapsulation frame-relay
user@R1:E# set lt-0/1/0 unit 25 dlci 1
user@R1:E# set lt-0/1/0 unit 25 peer-unit 1

```

- On Logical System E, configure the network address for the link to Peer A, and configure a loopback interface.

```

[edit interfaces]
user@R1:E# set lt-0/1/0 unit 25 description to-A
user@R1:E# set lt-0/1/0 unit 25 family inet6 address 2001:db8:0:1::/64 eui-64
user@R1:E# set lo0 unit 5 family inet6 address 2001:db8::5/128

```

- Run the `show interfaces terse` command to see the IPv6 addresses that are generated by EUI-64.

The 2001 addresses are used in this example in the BGP `neighbor` statements.



**NOTE:** The fe80 addresses are link-local addresses and are not used in this example.

```

user@R1:A> show interfaces terse
Interface Admin Link Proto Local Remote
Logical system: A

betsy@tp8:A> show interfaces terse
Interface Admin Link Proto Local Remote
lt-0/1/0
lt-0/1/0.1 up up inet6 2001:db8:0:1:2a0:a502:0:1da/64
 fe80::2a0:a502:0:1da/64

lo0
lo0.1 up up inet6 2001:db8::1
 fe80::2a0:a50f:fc56:1da

user@R1:E> show interfaces terse
Interface Admin Link Proto Local Remote
lt-0/1/0
lt-0/1/0.25 up up inet6 2001:db8:0:1:2a0:a502:0:19da/64

lo0
 fe80::2a0:a502:0:19da/64

```

```

100.5 up up inet6 2001:db8::5
 fe80::2a0:a50f:fc56:1da

```

7. Repeat the interface configuration on the other logical systems.

### *Configuring the External BGP Sessions*

#### **Step-by-Step Procedure**

The following example requires you to navigate various levels in the configuration hierarchy. For information about navigating the CLI, see *Using the CLI Editor in Configuration Mode in the CLI User Guide*.

To configure the BGP peer sessions:

1. On Logical System A, create the BGP group, and add the external neighbor address.
 

```

[edit protocols bgp group external-peers]
user@R1:A# set neighbor 2001:db8:0:1:2a0:a502:0:19da

```
2. On Logical System E, create the BGP group, and add the external neighbor address.
 

```

[edit protocols bgp group external-peers]
user@R1:E# set neighbor 2001:db8:0:1:2a0:a502:0:1da

```
3. On Logical System A, specify the autonomous system (AS) number of the external AS.
 

```

[edit protocols bgp group external-peers]
user@R1:A# set peer-as 17

```
4. On Logical System E, specify the autonomous system (AS) number of the external AS.
 

```

[edit protocols bgp group external-peers]
user@R1:E# set peer-as 22

```
5. On Logical System A, set the peer type to EBGp.
 

```

[edit protocols bgp group external-peers]
user@R1:A# set type external

```
6. On Logical System E, set the peer type to EBGp.
 

```

[edit protocols bgp group external-peers]
user@R1:E# set type external

```
7. On Logical System A, set the autonomous system (AS) number and router ID.
 

```

[edit routing-options]
user@R1:A# set router-id 1.1.1.1
user@R1:A# set autonomous-system 22

```
8. On Logical System E, set the AS number and router ID.
 

```

[edit routing-options]
user@R1:E# set router-id 5.5.5.5
user@R1:E# set autonomous-system 17

```
9. Repeat these steps for Peers A, B, C, and D.

**Results** From configuration mode, confirm your configuration by entering the `show logical-systems` command. If the output does not display the intended configuration, repeat the instructions in this example to correct the configuration.

```
[edit]
user@R1# show logical-systems
A {
 interfaces {
 lt-0/1/0 {
 unit 1 {
 description to-E;
 encapsulation frame-relay;
 dlc1 1;
 peer-unit 25;
 family inet6 {
 address 2001:db8:0:1::/64 {
 eui-64;
 }
 }
 }
 }
 }
 lo0 {
 unit 1 {
 family inet6 {
 address 2001:db8::1/128;
 }
 }
 }
}
protocols {
 bgp {
 group external-peers {
 type external;
 peer-as 17;
 neighbor 2001:db8:0:1:2a0:a502:0:19da;
 }
 }
 routing-options {
 router-id 1.1.1.1;
 autonomous-system 22;
 }
}
B {
 interfaces {
 lt-0/1/0 {
 unit 6 {
 description to-E;
 encapsulation frame-relay;
 dlc1 6;
 peer-unit 5;
 family inet6 {
 address 2001:db8:0:2::/64 {
 eui-64;
 }
 }
 }
 }
 }
}
```

```

 }
 }
 lo0 {
 unit 2 {
 family inet6 {
 address 2001:db8::2/128;
 }
 }
 }
}
protocols {
 bgp {
 group external-peers {
 type external;
 peer-as 17;
 neighbor 2001:db8:0:2:2a0:a502:0:5da;
 }
 }
 routing-options {
 router-id 2.2.2.2;
 autonomous-system 22;
 }
}
C {
 interfaces {
 lt-0/1/0 {
 unit 10 {
 description to-E;
 encapsulation frame-relay;
 dlci 10;
 peer-unit 9;
 family inet6 {
 address 2001:db8:0:3::/64 {
 eui-64;
 }
 }
 }
 }
 }
 lo0 {
 unit 3 {
 family inet6 {
 address 2001:db8::3/128;
 }
 }
 }
}
protocols {
 bgp {
 group external-peers {
 type external;
 peer-as 17;
 neighbor 2001:db8:0:3:2a0:a502:0:9da;
 }
 }
 routing-options {

```

```
 router-id 3.3.3.3;
 autonomous-system 22;
 }
}
D {
 interfaces {
 lt-0/1/0 {
 unit 7 {
 description to-E;
 encapsulation frame-relay;
 dlci 7;
 peer-unit 21;
 family inet6 {
 address 2001:db8:0:4::/64 {
 eui-64;
 }
 }
 }
 }
 lo0 {
 unit 4 {
 family inet6 {
 address 2001:db8::4/128;
 }
 }
 }
 }
 protocols {
 bgp {
 group external-peers {
 type external;
 peer-as 17;
 neighbor 2001:db8:0:4:2a0:a502:0:15da;
 }
 }
 routing-options {
 router-id 4.4.4.4;
 autonomous-system 79;
 }
 }
}
E {
 interfaces {
 lt-0/1/0 {
 unit 5 {
 description to-B;
 encapsulation frame-relay;
 dlci 6;
 peer-unit 6;
 family inet6 {
 address 2001:db8:0:2::/64 {
 eui-64;
 }
 }
 }
 unit 9 {
 description to-C;
 }
 }
 }
}
```

```
encapsulation frame-relay;
dlsi 10;
peer-unit 10;
family inet6 {
 address 2001:db8:0:3::/64 {
 eui-64;
 }
}
}
unit 21 {
 description to-D;
 encapsulation frame-relay;
 dlsi 7;
 peer-unit 7;
 family inet6 {
 address 2001:db8:0:4::/64 {
 eui-64;
 }
 }
}
unit 25 {
 description to-A;
 encapsulation frame-relay;
 dlsi 1;
 peer-unit 1;
 family inet6 {
 address 2001:db8:0:1::/64 {
 eui-64;
 }
 }
}
}
lo0 {
 unit 5 {
 family inet6 {
 address 2001:db8::5/128;
 }
 }
}
}
protocols {
 bgp {
 group external-peers {
 type external;
 peer-as 22;
 neighbor 2001:db8:0:1:2a0:a502:0:1da;
 neighbor 2001:db8:0:2:2a0:a502:0:6da;
 neighbor 2001:db8:0:3:2a0:a502:0:ada;
 neighbor 2001:db8:0:4:2a0:a502:0:7da {
 peer-as 79;
 }
 }
 }
}
}
routing-options {
 router-id 5.5.5.5;
}
```

```

 autonomous-system 17;
 }
}

```

If you are done configuring the device, enter **commit** from configuration mode.

## Verification

Confirm that the configuration is working properly.

- [Verifying BGP Neighbors on page 136](#)
- [Verifying BGP Groups on page 138](#)
- [Verifying BGP Summary Information on page 139](#)
- [Checking the Routing Table on page 139](#)

### Verifying BGP Neighbors

**Purpose** Verify that BGP is running on configured interfaces and that the BGP session is active for each neighbor address.

**Action** From operational mode, run the **show bgp neighbor** command.

```

user@R1:E> show bgp neighbor
Peer: 2001:db8:0:1:2a0:a502:0:1da+54987 AS 22 Local:
2001:db8:0:1:2a0:a502:0:19da+179 AS 17
 Type: External State: Established Flags: <Sync>
 Last State: OpenConfirm Last Event: RecvKeepAlive
 Last Error: Open Message Error
 Options: <Preference PeerAS Refresh>
 Holdtime: 90 Preference: 170
 Number of flaps: 0
 Error: 'Open Message Error' Sent: 20 Recv: 0
 Peer ID: 1.1.1.1 Local ID: 5.5.5.5 Active Holdtime: 90
 Keepalive Interval: 30 Peer index: 0
 BFD: disabled, down
 Local Interface: lt-0/1/0.25
 NLRI for restart configured on peer: inet6-unicast
 NLRI advertised by peer: inet6-unicast
 NLRI for this session: inet6-unicast
 Peer supports Refresh capability (2)
 Stale routes from peer are kept for: 300
 Peer does not support Restarter functionality
 NLRI that restart is negotiated for: inet6-unicast
 NLRI of received end-of-rib markers: inet6-unicast
 NLRI of all end-of-rib markers sent: inet6-unicast
 Peer supports 4 byte AS extension (peer-as 22)
 Peer does not support Addpath
 Table inet6.0 Bit: 10000
 RIB State: BGP restart is complete
 Send state: in sync
 Active prefixes: 0
 Received prefixes: 0
 Accepted prefixes: 0
 Suppressed due to damping: 0
 Advertised prefixes: 0
 Last traffic (seconds): Received 7 Sent 18 Checked 81
 Input messages: Total 1611 Updates 1 Refreshes 0 Octets 30660
 Output messages: Total 1594 Updates 0 Refreshes 0 Octets 30356

```



Output Queue[0]: 0

```
Peer: 2001:db8:0:2:2a0:a502:0:6da+179 AS 22 Local:
2001:db8:0:2:2a0:a502:0:5da+55502 AS 17
 Type: External State: Established Flags: <Sync>
 Last State: OpenConfirm Last Event: RecvKeepAlive
 Last Error: Open Message Error
 Options: <Preference PeerAS Refresh>
 Holdtime: 90 Preference: 170
 Number of flaps: 0
 Error: 'Open Message Error' Sent: 26 Recv: 0
 Peer ID: 2.2.2.2 Local ID: 5.5.5.5 Active Holdtime: 90
 Keepalive Interval: 30 Peer index: 2
 BFD: disabled, down
 Local Interface: lt-0/1/0.5
 NLRI for restart configured on peer: inet6-unicast
 NLRI advertised by peer: inet6-unicast
 NLRI for this session: inet6-unicast
 Peer supports Refresh capability (2)
 Stale routes from peer are kept for: 300
 Peer does not support Restarter functionality
 NLRI that restart is negotiated for: inet6-unicast
 NLRI of received end-of-rib markers: inet6-unicast
 NLRI of all end-of-rib markers sent: inet6-unicast
 Peer supports 4 byte AS extension (peer-as 22)
 Peer does not support Addpath
 Table inet6.0 Bit: 10000
 RIB State: BGP restart is complete
 Send state: in sync
 Active prefixes: 0
 Received prefixes: 0
 Accepted prefixes: 0
 Suppressed due to damping: 0
 Advertised prefixes: 0
 Last traffic (seconds): Received 15 Sent 8 Checked 8
 Input messages: Total 1610 Updates 1 Refreshes 0 Octets 30601
 Output messages: Total 1645 Updates 0 Refreshes 0 Octets 32417
 Output Queue[0]: 0
```

```
Peer: 2001:db8:0:3:2a0:a502:0:ada+55983 AS 22 Local:
2001:db8:0:3:2a0:a502:0:9da+179 AS 17
 Type: External State: Established Flags: <Sync>
 Last State: OpenConfirm Last Event: RecvKeepAlive
 Last Error: None
 Options: <Preference PeerAS Refresh>
 Holdtime: 90 Preference: 170
 Number of flaps: 0
 Peer ID: 3.3.3.3 Local ID: 5.5.5.5 Active Holdtime: 90
 Keepalive Interval: 30 Peer index: 3
 BFD: disabled, down
 Local Interface: lt-0/1/0.9
 NLRI for restart configured on peer: inet6-unicast
 NLRI advertised by peer: inet6-unicast
 NLRI for this session: inet6-unicast
 Peer supports Refresh capability (2)
 Stale routes from peer are kept for: 300
 Peer does not support Restarter functionality
 NLRI that restart is negotiated for: inet6-unicast
 NLRI of received end-of-rib markers: inet6-unicast
 NLRI of all end-of-rib markers sent: inet6-unicast
 Peer supports 4 byte AS extension (peer-as 22)
```

```

Peer does not support Addpath
Table inet6.0 Bit: 10000
 RIB State: BGP restart is complete
 Send state: in sync
 Active prefixes: 0
 Received prefixes: 0
 Accepted prefixes: 0
 Suppressed due to damping: 0
 Advertised prefixes: 0
Last traffic (seconds): Received 21 Sent 21 Checked 67
Input messages: Total 1610 Updates 1 Refreshes 0 Octets 30641
Output messages: Total 1587 Updates 0 Refreshes 0 Octets 30223
Output Queue[0]: 0

```

```

Peer: 2001:db8:0:4:2a0:a502:0:7da+49255 AS 79 Local:
2001:db8:0:4:2a0:a502:0:15da+179 AS 17
 Type: External State: Established Flags: <Sync>
 Last State: OpenConfirm Last Event: RecvKeepAlive
 Last Error: None
 Options: <Preference PeerAS Refresh>
 Holdtime: 90 Preference: 170
 Number of flaps: 0
 Peer ID: 4.4.4.4 Local ID: 5.5.5.5 Active Holdtime: 90
 Keepalive Interval: 30 Peer index: 1
 BFD: disabled, down
 Local Interface: lt-0/1/0.21
 NLRI for restart configured on peer: inet6-unicast
 NLRI advertised by peer: inet6-unicast
 NLRI for this session: inet6-unicast
 Peer supports Refresh capability (2)
 Stale routes from peer are kept for: 300
 Peer does not support Restarter functionality
 NLRI that restart is negotiated for: inet6-unicast
 NLRI of received end-of-rib markers: inet6-unicast
 NLRI of all end-of-rib markers sent: inet6-unicast
 Peer supports 4 byte AS extension (peer-as 79)
 Peer does not support Addpath
Table inet6.0 Bit: 10000
 RIB State: BGP restart is complete
 Send state: in sync
 Active prefixes: 0
 Received prefixes: 0
 Accepted prefixes: 0
 Suppressed due to damping: 0
 Advertised prefixes: 0
Last traffic (seconds): Received 6 Sent 17 Checked 25
Input messages: Total 1615 Updates 1 Refreshes 0 Octets 30736
Output messages: Total 1593 Updates 0 Refreshes 0 Octets 30337
Output Queue[0]: 0

```

**Meaning** IPv6 unicast network layer reachability information (NLRI) is being exchanged between the neighbors.

**Verifying BGP Groups**

**Purpose** Verify that the BGP groups are configured correctly.

**Action** From operational mode, run the **show bgp group** command.

```

user@R1:E> show bgp group
Group Type: External Local AS: 17
Name: external-peers Index: 0 Flags: <>
Holdtime: 0
Total peers: 4 Established: 4
2001:db8:0:1:2a0:a502:0:1da+54987
2001:db8:0:2:2a0:a502:0:6da+179
2001:db8:0:3:2a0:a502:0:ada+55983
2001:db8:0:4:2a0:a502:0:7da+49255
inet6.0: 0/0/0/0

Groups: 1 Peers: 4 External: 4 Internal: 0 Down peers: 0 Flaps: 0
Table Tot Paths Act Paths Suppressed History Damp State Pending
inet6.0 0 0 0 0 0 0 0 0
inet6.2 0 0 0 0 0 0 0 0

```

**Meaning** The group type is external, and the group has four peers.

#### *Verifying BGP Summary Information*

**Purpose** Verify that the BGP that the peer relationships are established.

**Action** From operational mode, run the **show bgp summary** command.

```

user@R1:E> show bgp summary
Groups: 1 Peers: 4 Down peers: 0
Table Tot Paths Act Paths Suppressed History Damp State Pending
inet6.0 0 0 0 0 0 0 0
inet6.2 0 0 0 0 0 0 0
Peer AS InPkt OutPkt OutQ Flaps Last Up/Dwn
State|#Active/Received/Accepted/Damped...
2001:db8:0:1:2a0:a502:0:1da 22 1617 1600 0 0
12:07:00 Establ
inet6.0: 0/0/0/0
2001:db8:0:2:2a0:a502:0:6da 22 1616 1651 0 0
12:06:56 Establ
inet6.0: 0/0/0/0
2001:db8:0:3:2a0:a502:0:ada 22 1617 1594 0 0
12:04:32 Establ
inet6.0: 0/0/0/0
2001:db8:0:4:2a0:a502:0:7da 79 1621 1599 0 0
12:07:00 Establ
inet6.0: 0/0/0/0

```

**Meaning** The Down peers: 0 output shows that the BGP peers are in the established state.

#### *Checking the Routing Table*

**Purpose** Verify that the inet6.0 routing table is populated with local and direct routes.

**Action** From operational mode, run the **show route** command.

```

user@R1:E> show route
inet6.0: 15 destinations, 18 routes (15 active, 0 holddown, 0 hidden)
+ = Active Route, - = Last Active, * = Both

2001:db8::5/128 * [Direct/0] 12:41:18
> via lo0.5

```

```

2001:db8:0:1::/64 *[Direct/0] 14:40:01
> via lt-0/1/0.25
2001:db8:0:1:2a0:a502:0:19da/128
*[Local/0] 14:40:01
Local via lt-0/1/0.25
2001:db8:0:2::/64 *[Direct/0] 14:40:02
> via lt-0/1/0.5
2001:db8:0:2:2a0:a502:0:5da/128
*[Local/0] 14:40:02
Local via lt-0/1/0.5
2001:db8:0:3::/64 *[Direct/0] 14:40:02
> via lt-0/1/0.9
2001:db8:0:3:2a0:a502:0:9da/128
*[Local/0] 14:40:02
Local via lt-0/1/0.9
2001:db8:0:4::/64 *[Direct/0] 14:40:01
> via lt-0/1/0.21
2001:db8:0:4:2a0:a502:0:15da/128
*[Local/0] 14:40:01
Local via lt-0/1/0.21
fe80::/64 *[Direct/0] 14:40:02
> via lt-0/1/0.5
[Direct/0] 14:40:02
> via lt-0/1/0.9
[Direct/0] 14:40:01
> via lt-0/1/0.21
[Direct/0] 14:40:01
> via lt-0/1/0.25
fe80::2a0:a502:0:5da/128
*[Local/0] 14:40:02
Local via lt-0/1/0.5
fe80::2a0:a502:0:9da/128
*[Local/0] 14:40:02
Local via lt-0/1/0.9
fe80::2a0:a502:0:15da/128
*[Local/0] 14:40:01
Local via lt-0/1/0.21
fe80::2a0:a502:0:19da/128
*[Local/0] 14:40:01
Local via lt-0/1/0.25
fe80::2a0:a50f:fc56:1da/128
*[Direct/0] 12:41:18
> via lo0.5

```

**Meaning** The inet6.0 routing table contains local and direct routes. To populate the routing table with other types of routes, you must configure routing policies.

### Example: Configuring BFD on Internal BGP Peer Sessions

This example shows how to configure internal BGP (IBGP) peer sessions with the Bidirectional Forwarding Detection (BFD) protocol to detect failures in a network.

- [Requirements on page 141](#)
- [Overview on page 141](#)
- [Configuration on page 142](#)
- [Verification on page 146](#)

## Requirements

No special configuration beyond device initialization is required before you configure this example.

## Overview

The minimum configuration to enable BFD on IBGP sessions is to include the **bfd-liveness-detection minimum-interval** statement in the BGP configuration of all neighbors participating in the BFD session. The **minimum-interval** statement specifies the minimum transmit and receive intervals for failure detection. Specifically, this value represents the minimum interval after which the local routing device transmits hello packets as well as the minimum interval that the routing device expects to receive a reply from a neighbor with which it has established a BFD session. You can configure a value from 1 through 255,000 milliseconds.

Optionally, you can specify the minimum transmit and receive intervals separately using the **transmit-interval minimum-interval** and **minimum-receive-interval** statements. For information about these and other optional BFD configuration statements, see **bfd-liveness-detection**.



**NOTE:** BFD is an intensive protocol that consumes system resources. Specifying a minimum interval for BFD less than 100 ms for Routing Engine-based sessions and less than 10 ms for distributed BFD sessions can cause undesired BFD flapping.

Depending on your network environment, these additional recommendations might apply:

- For large-scale network deployments with a large number of BFD sessions, specify a minimum interval of 300 ms for Routing Engine-based sessions and 100 ms for distributed BFD sessions.
- For very large-scale network deployments with a large number of BFD sessions, contact Juniper Networks customer support for more information.
- For BFD sessions to remain up during a Routing Engine switchover event when nonstop active routing (NSR) is configured, specify a minimum interval of 2500 ms for Routing Engine-based sessions. For distributed BFD sessions with NSR configured, the minimum interval recommendations are unchanged and depend only on your network deployment.

BFD is supported on the default routing instance (the main router), routing instances, and logical systems. This example shows BFD on logical systems.

Figure 23 on page 142 shows a typical network with internal peer sessions.

Figure 23: Typical Network with IBGP Sessions

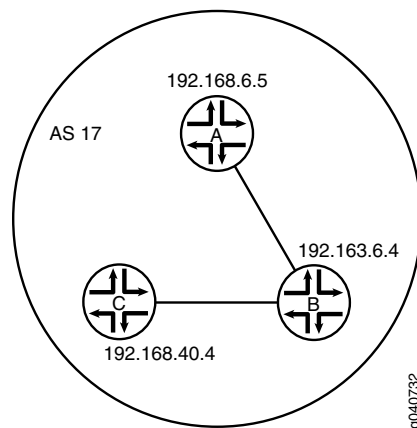

### Configuration

#### CLI Quick Configuration

To quickly configure this example, copy the following commands, paste them into a text file, remove any line breaks, change any details necessary to match your network configuration, and then copy and paste the commands into the CLI at the **[edit]** hierarchy level.

#### Device A

```
set logical-systems A interfaces lt-1/2/0 unit 1 description to-B
set logical-systems A interfaces lt-1/2/0 unit 1 encapsulation ethernet
set logical-systems A interfaces lt-1/2/0 unit 1 peer-unit 2
set logical-systems A interfaces lt-1/2/0 unit 1 family inet address 10.10.10.1/30
set logical-systems A interfaces lo0 unit 1 family inet address 192.168.6.5/32
set logical-systems A protocols bgp group internal-peers type internal
set logical-systems A protocols bgp group internal-peers traceoptions file bgp-bfd
set logical-systems A protocols bgp group internal-peers traceoptions flag bfd detail
set logical-systems A protocols bgp group internal-peers local-address 192.168.6.5
set logical-systems A protocols bgp group internal-peers export send-direct
set logical-systems A protocols bgp group internal-peers bfd-liveness-detection
 minimum-interval 1000
set logical-systems A protocols bgp group internal-peers neighbor 192.163.6.4
set logical-systems A protocols bgp group internal-peers neighbor 192.168.40.4
set logical-systems A protocols ospf area 0.0.0.0 interface lo0.1 passive
set logical-systems A protocols ospf area 0.0.0.0 interface lt-1/2/0.1
set logical-systems A policy-options policy-statement send-direct term 2 from protocol
 direct
set logical-systems A policy-options policy-statement send-direct term 2 then accept
set logical-systems A routing-options router-id 192.168.6.5
set logical-systems A routing-options autonomous-system 17
```

#### Device B

```
set logical-systems B interfaces lt-1/2/0 unit 2 description to-A
set logical-systems B interfaces lt-1/2/0 unit 2 encapsulation ethernet
set logical-systems B interfaces lt-1/2/0 unit 2 peer-unit 1
set logical-systems B interfaces lt-1/2/0 unit 2 family inet address 10.10.10.2/30
set logical-systems B interfaces lt-1/2/0 unit 5 description to-C
set logical-systems B interfaces lt-1/2/0 unit 5 encapsulation ethernet
set logical-systems B interfaces lt-1/2/0 unit 5 peer-unit 6
set logical-systems B interfaces lt-1/2/0 unit 5 family inet address 10.10.10.5/30
set logical-systems B interfaces lo0 unit 2 family inet address 192.163.6.4/32
set logical-systems B protocols bgp group internal-peers type internal
```

```

set logical-systems B protocols bgp group internal-peers local-address 192.163.6.4
set logical-systems B protocols bgp group internal-peers export send-direct
set logical-systems B protocols bgp group internal-peers bfd-liveness-detection
 minimum-interval 1000
set logical-systems B protocols bgp group internal-peers neighbor 192.168.40.4
set logical-systems B protocols bgp group internal-peers neighbor 192.168.6.5
set logical-systems B protocols ospf area 0.0.0.0 interface lo0.2 passive
set logical-systems B protocols ospf area 0.0.0.0 interface lt-1/2/0.2
set logical-systems B protocols ospf area 0.0.0.0 interface lt-1/2/0.5
set logical-systems B policy-options policy-statement send-direct term 2 from protocol
 direct
set logical-systems B policy-options policy-statement send-direct term 2 then accept
set logical-systems B routing-options router-id 192.163.6.4
set logical-systems B routing-options autonomous-system 17

```

**Device C**

```

set logical-systems C interfaces lt-1/2/0 unit 6 description to-B
set logical-systems C interfaces lt-1/2/0 unit 6 encapsulation ethernet
set logical-systems C interfaces lt-1/2/0 unit 6 peer-unit 5
set logical-systems C interfaces lt-1/2/0 unit 6 family inet address 10.10.10.6/30
set logical-systems C interfaces lo0 unit 3 family inet address 192.168.40.4/32
set logical-systems C protocols bgp group internal-peers type internal
set logical-systems C protocols bgp group internal-peers local-address 192.168.40.4
set logical-systems C protocols bgp group internal-peers export send-direct
set logical-systems C protocols bgp group internal-peers bfd-liveness-detection
 minimum-interval 1000
set logical-systems C protocols bgp group internal-peers neighbor 192.163.6.4
set logical-systems C protocols bgp group internal-peers neighbor 192.168.6.5
set logical-systems C protocols ospf area 0.0.0.0 interface lo0.3 passive
set logical-systems C protocols ospf area 0.0.0.0 interface lt-1/2/0.6
set logical-systems C policy-options policy-statement send-direct term 2 from protocol
 direct
set logical-systems C policy-options policy-statement send-direct term 2 then accept
set logical-systems C routing-options router-id 192.168.40.4
set logical-systems C routing-options autonomous-system 17

```

**Configuring Device A****Step-by-Step Procedure**

The following example requires that you navigate various levels in the configuration hierarchy. For information about navigating the CLI, see *Using the CLI Editor in Configuration Mode* in the CLI User Guide.

To configure Device A:

1. Set the CLI to Logical System A.

```
user@host> set cli logical-system A
```

2. Configure the interfaces.

```

[edit interfaces lt-1/2/0 unit 1]
user@host:A# set description to-B
user@host:A# set encapsulation ethernet
user@host:A# set peer-unit 2
user@host:A# set family inet address 10.10.10.1/30

```

```
[edit interfaces lo0 unit 1]
```

```
user@host:A# set family inet address 192.168.6.5/32
```

3. Configure BGP.

The **neighbor** statements are included for both Device B and Device C, even though Device A is not directly connected to Device C.

```
[edit protocols bgp group internal-peers]
user@host:A# set type internal
user@host:A# set local-address 192.168.6.5
user@host:A# set export send-direct
user@host:A# set neighbor 192.163.6.4
user@host:A# set neighbor 192.168.40.4
```

4. Configure BFD.

```
[edit protocols bgp group internal-peers]
user@host:A# set bfd-liveness-detection minimum-interval 1000
```

You must configure the same minimum interval on the connecting peer.

5. (Optional) Configure BFD tracing.

```
[edit protocols bgp group internal-peers]
user@host:A# set traceoptions file bgp-bfd
user@host:A# set traceoptions flag bfd detail
```

6. Configure OSPF.

```
[edit protocols ospf area 0.0.0.0]
user@host:A# set interface lo0.1 passive
user@host:A# set interface lt-1/2/0.1
```

7. Configure a policy that accepts direct routes.

Other useful options for this scenario might be to accept routes learned through OSPF or local routes.

```
[edit policy-options policy-statement send-direct term 2]
user@host:A# set from protocol direct
user@host:A# set then accept
```

8. Configure the router ID and the autonomous system (AS) number.

```
[edit routing-options]
user@host:A# set router-id 192.168.6.5
user@host:A# set autonomous-system 17
```

9. If you are done configuring the device, enter **commit** from configuration mode. Repeat these steps to configure Device B and Device C.

**Results** From configuration mode, confirm your configuration by entering the **show interfaces**, **show policy-options**, **show protocols**, and **show routing-options** commands. If the output does not display the intended configuration, repeat the instructions in this example to correct the configuration.

```
user@host:A# show interfaces
lt-1/2/0 {
 unit 1 {
 description to-B;
```



```
 encapsulation ethernet;
 peer-unit 2;
 family inet {
 address 10.10.10.1/30;
 }
}
lo0 {
 unit 1 {
 family inet {
 address 192.168.6.5/32;
 }
 }
}

user@host:A# show policy-options
policy-statement send-direct {
 term 2 {
 from protocol direct;
 then accept;
 }
}

user@host:A# show protocols
bgp {
 group internal-peers {
 type internal;
 traceoptions {
 file bgp-bfd;
 flag bfd detail;
 }
 local-address 192.168.6.5;
 export send-direct;
 bfd-liveness-detection {
 minimum-interval 1000;
 }
 neighbor 192.163.6.4;
 neighbor 192.168.40.4;
 }
}
ospf {
 area 0.0.0.0 {
 interface lo0.1 {
 passive;
 }
 interface lt-1/2/0.1;
 }
}

user@host:A# show routing-options
router-id 192.168.6.5;
autonomous-system 17;
```

## Verification

Confirm that the configuration is working properly.

- [Verifying That BFD Is Enabled on page 146](#)
- [Verifying That BFD Sessions Are Up on page 146](#)
- [Viewing Detailed BFD Events on page 147](#)
- [Viewing Detailed BFD Events After Deactivating and Reactivating a Loopback Interface on page 148](#)

### *Verifying That BFD Is Enabled*

**Purpose** Verify that BFD is enabled between the IBGP peers.

**Action** From operational mode, enter the **show bgp neighbor** command. You can use the **| match bfd** filter to narrow the output.

```
user@host:A> show bgp neighbor | match bfd
Options: <BfdEnabled>
 BFD: enabled, up
 Trace file: /var/log/A/bgp-bfd size 131072 files 10
Options: <BfdEnabled>
 BFD: enabled, up
 Trace file: /var/log/A/bgp-bfd size 131072 files 10
```

**Meaning** The output shows that Logical System A has two neighbors with BFD enabled. When BFD is not enabled, the output displays **BFD: disabled, down**, and the **<BfdEnabled>** option is absent. If BFD is enabled and the session is down, the output displays **BFD: enabled, down**. The output also shows that BFD-related events are being written to a log file because trace operations are configured.

### *Verifying That BFD Sessions Are Up*

**Purpose** Verify that the BFD sessions are up, and view details about the BFD sessions.

**Action** From operational mode, enter the **show bfd session extensive** command.

```
user@host:A> show bfd session extensive
```

| Address     | State | Interface | Detect Time | Transmit Interval | Multiplier |
|-------------|-------|-----------|-------------|-------------------|------------|
| 192.163.6.4 | Up    |           | 3.000       | 1.000             | 3          |

```
Client BGP, TX interval 1.000, RX interval 1.000
Session up time 00:54:40
Local diagnostic None, remote diagnostic None
Remote state Up, version 1
Logical system 12, routing table index 25
Min async interval 1.000, min slow interval 1.000
Adaptive async TX interval 1.000, RX interval 1.000
Local min TX interval 1.000, minimum RX interval 1.000, multiplier 3
Remote min TX interval 1.000, min RX interval 1.000, multiplier 3
Local discriminator 10, remote discriminator 9
Echo mode disabled/inactive
Multi-hop route table 25, local-address 192.168.6.5
```

Detect Transmit

```

Address State Interface Time Interval Multiplier
192.168.40.4 Up Interface 3.000 1.000 3
 Client BGP, TX interval 1.000, RX interval 1.000
 Session up time 00:48:03
 Local diagnostic None, remote diagnostic None
 Remote state Up, version 1
 Logical system 12, routing table index 25
 Min async interval 1.000, min slow interval 1.000
 Adaptive async TX interval 1.000, RX interval 1.000
 Local min TX interval 1.000, minimum RX interval 1.000, multiplier 3
 Remote min TX interval 1.000, min RX interval 1.000, multiplier 3
 Local discriminator 14, remote discriminator 13
 Echo mode disabled/inactive
 Multi-hop route table 25, local-address 192.168.6.5

2 sessions, 2 clients
Cumulative transmit rate 2.0 pps, cumulative receive rate 2.0 pps

```

**Meaning** The TX interval 1.000, RX interval 1.000 output represents the setting configured with the **minimum-interval** statement. All of the other output represents the default settings for BFD. To modify the default settings, include the optional statements under the **bfd-liveness-detection** statement.

#### *Viewing Detailed BFD Events*

**Purpose** View the contents of the BFD trace file to assist in troubleshooting, if needed.

**Action** From operational mode, enter the **file show /var/log/A/bgp-bfd** command.

```

user@host:A> file show /var/log/A/bgp-bfd
Aug 15 17:07:25 trace_on: Tracing to "/var/log/A/bgp-bfd" started
Aug 15 17:07:26.492190 bgp_peer_init: BGP peer 192.163.6.4 (Internal AS 17) local
 address 192.168.6.5 not found. Leaving peer idled
Aug 15 17:07:26.493176 bgp_peer_init: BGP peer 192.168.40.4 (Internal AS 17) local
 address 192.168.6.5 not found. Leaving peer idled
Aug 15 17:07:32.597979 task_connect: task BGP_17.192.163.6.4+179 addr
 192.163.6.4+179: No route to host
Aug 15 17:07:32.599623 bgp_connect_start: connect 192.163.6.4 (Internal AS 17):
 No route to host
Aug 15 17:07:36.869394 task_connect: task BGP_17.192.168.40.4+179 addr
 192.168.40.4+179: No route to host
Aug 15 17:07:36.870624 bgp_connect_start: connect 192.168.40.4 (Internal AS 17):
 No route to host
Aug 15 17:08:04.599220 task_connect: task BGP_17.192.163.6.4+179 addr
 192.163.6.4+179: No route to host
Aug 15 17:08:04.601135 bgp_connect_start: connect 192.163.6.4 (Internal AS 17):
 No route to host
Aug 15 17:08:08.869717 task_connect: task BGP_17.192.168.40.4+179 addr
 192.168.40.4+179: No route to host
Aug 15 17:08:08.869934 bgp_connect_start: connect 192.168.40.4 (Internal AS 17):
 No route to host
Aug 15 17:08:36.603544 advertising receiving-speaker only capability to neighbor
 192.163.6.4 (Internal AS 17)
Aug 15 17:08:36.606726 bgp_read_message: 192.163.6.4 (Internal AS 17): 0 bytes
 buffered
Aug 15 17:08:36.609119 Initiated BFD session to peer 192.163.6.4 (Internal AS
 17): address=192.163.6.4 ifindex=0 ifname=(none) txivl=1000 rxivl=1000 mult=3
 ver=255
Aug 15 17:08:36.734033 advertising receiving-speaker only capability to neighbor

```

```

192.168.40.4 (Internal AS 17)
Aug 15 17:08:36.738436 Initiated BFD session to peer 192.168.40.4 (Internal AS
17): address=192.168.40.4 ifindex=0 ifname=(none) txivl=1000 rxivl=1000 mult=3
ver=255
Aug 15 17:08:40.537552 BFD session to peer 192.163.6.4 (Internal AS 17) up
Aug 15 17:08:40.694410 BFD session to peer 192.168.40.4 (Internal AS 17) up

```

**Meaning** Before the routes are established, the **No route to host** message appears in the output. After the routes are established, the last two lines show that both BFD sessions come up.

### *Viewing Detailed BFD Events After Deactivating and Reactivating a Loopback Interface*

**Purpose** Check to see what happens after bringing down a router or switch and then bringing it back up. To simulate bringing down a router or switch, deactivate the loopback interface on Logical System B.

**Action** 1. From configuration mode, enter the **deactivate logical-systems B interfaces lo0 unit 2 family inet** command.

```

user@host: A# deactivate logical-systems B interfaces lo0 unit 2 family inet
user@host: A# commit

```

2. From operational mode, enter the **file show /var/log/A/bgp-bfd** command.

```

user@host: A> file show /var/log/A/bgp-bfd
...
Aug 15 17:20:55.995648 bgp_read_v4_message:9747: NOTIFICATION received from
192.163.6.4 (Internal AS 17): code 6 (Cease) subcode 6 (Other Configuration
Change)
Aug 15 17:20:56.004508 Terminated BFD session to peer 192.163.6.4 (Internal
AS 17)
Aug 15 17:21:28.007755 task_connect: task BGP_17.192.163.6.4+179 addr
192.163.6.4+179: No route to host
Aug 15 17:21:28.008597 bgp_connect_start: connect 192.163.6.4 (Internal AS
17): No route to host

```

3. From configuration mode, enter the **activate logical-systems B interfaces lo0 unit 2 family inet** command.

```

user@host: A# activate logical-systems B interfaces lo0 unit 2 family inet
user@host: A# commit

```

4. From operational mode, enter the **file show /var/log/A/bgp-bfd** command.

```

user@host: A> file show /var/log/A/bgp-bfd
...
Aug 15 17:25:53.623743 advertising receiving-speaker only capability to neighbor
192.163.6.4 (Internal AS 17)
Aug 15 17:25:53.631314 Initiated BFD session to peer 192.163.6.4 (Internal AS
17): address=192.163.6.4 ifindex=0 ifname=(none) txivl=1000 rxivl=1000 mult=3
ver=255
Aug 15 17:25:57.570932 BFD session to peer 192.163.6.4 (Internal AS 17) up

```

## Example: Configuring EBGP Multihop Sessions on Logical Systems

This example shows how to configure an external BGP (EBGP) peer that is more than one hop away from the local router. This type of session is called a *multihop* EBGP session.

- [Requirements on page 149](#)
- [Overview on page 149](#)
- [Configuration on page 150](#)
- [Verification on page 157](#)

### Requirements

---

In this example, no special configuration beyond device initialization is required.

### Overview

---

When EBGP peers are not directly connected to each other, they must cross one or more non-BGP routers to reach each other. Configuring multihop EBGP enables the peers to pass through the other routers to form peer relationships and exchange update messages. This type of configuration is typically used when a Juniper Networks routing device needs to run EBGP with a third-party router that does not allow direct connection of the two EBGP peers. EBGP multihop enables a neighbor connection between two EBGP peers that do not have a direct connection.

The configuration to enable multihop EBGP sessions requires connectivity between the two EBGP peers. This example uses static routes to provide connectivity between the devices.

For directly connected EBGP sessions, physical addresses are typically used in the **neighbor** statements. For multihop EBGP, you must use loopback interface addresses, and specify the loopback interface address of the indirectly connected peer. In the use of loopback interfaces addresses, EBGP multihop is similar to internal BGP (IBGP).

Finally, you must add the **multihop** statement. Optionally, you can set a maximum time-to-live (TTL) value with the **ttl** statement. The TTL is carried in the IP header of BGP packets. If you do not specify a TTL value, the system's default maximum TTL value is used. The default TTL value is 64 for multihop EBGP sessions. Another option is to retain the BGP next-hop value for route advertisements by including the **no-next-hop-change** statement.

[Figure 24 on page 150](#) shows a typical EBGP multihop network.

Device C and Device E have an established EBGP session. Device D is not a BGP-enabled device. All of the devices have connectivity via static routes.

Figure 24: Typical Network with EBGP Multihop Sessions

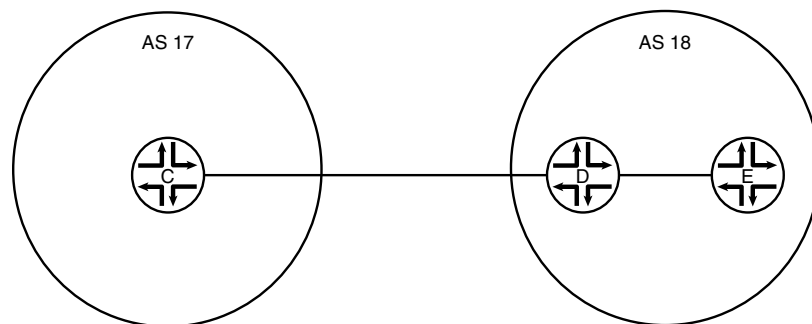

### Configuration

**CLI Quick Configuration** To quickly configure this example, copy the following commands, paste them into a text file, remove any line breaks, change any details necessary to match your network configuration, and then copy and paste the commands into the CLI at the **[edit]** hierarchy level.

**Device C**

```

set logical-systems C interfaces lt-1/2/0 unit 9 description to-D
set logical-systems C interfaces lt-1/2/0 unit 9 encapsulation ethernet
set logical-systems C interfaces lt-1/2/0 unit 9 peer-unit 10
set logical-systems C interfaces lt-1/2/0 unit 9 family inet address 10.10.10.9/30
set logical-systems C interfaces lo0 unit 3 family inet address 192.168.40.4/32
set logical-systems C protocols bgp group external-peers type external
set logical-systems C protocols bgp group external-peers multihop ttl 2
set logical-systems C protocols bgp group external-peers local-address 192.168.40.4
set logical-systems C protocols bgp group external-peers export send-static
set logical-systems C protocols bgp group external-peers peer-as 18
set logical-systems C protocols bgp group external-peers neighbor 192.168.6.7
set logical-systems C policy-options policy-statement send-static term 1 from protocol static
set logical-systems C policy-options policy-statement send-static term 1 then accept
set logical-systems C routing-options static route 10.10.10.14/32 next-hop 10.10.10.10
set logical-systems C routing-options static route 192.168.6.7/32 next-hop 10.10.10.10
set logical-systems C routing-options router-id 192.168.40.4
set logical-systems C routing-options autonomous-system 17

```

**Device D**

```

set logical-systems D interfaces lt-1/2/0 unit 10 description to-C
set logical-systems D interfaces lt-1/2/0 unit 10 encapsulation ethernet
set logical-systems D interfaces lt-1/2/0 unit 10 peer-unit 9
set logical-systems D interfaces lt-1/2/0 unit 10 family inet address 10.10.10.10/30
set logical-systems D interfaces lt-1/2/0 unit 13 description to-E
set logical-systems D interfaces lt-1/2/0 unit 13 encapsulation ethernet
set logical-systems D interfaces lt-1/2/0 unit 13 peer-unit 14
set logical-systems D interfaces lt-1/2/0 unit 13 family inet address 10.10.10.13/30
set logical-systems D interfaces lo0 unit 4 family inet address 192.168.6.6/32
set logical-systems D routing-options static route 192.168.40.4/32 next-hop 10.10.10.9
set logical-systems D routing-options static route 192.168.6.7/32 next-hop 10.10.10.14
set logical-systems D routing-options router-id 192.168.6.6

```

**Device E**

```

set logical-systems E interfaces lt-1/2/0 unit 14 description to-D
set logical-systems E interfaces lt-1/2/0 unit 14 encapsulation ethernet
set logical-systems E interfaces lt-1/2/0 unit 14 peer-unit 13

```

```

set logical-systems E interfaces lt-1/2/0 unit 14 family inet address 10.10.10.14/30
set logical-systems E interfaces lo0 unit 5 family inet address 192.168.6.7/32
set logical-systems E protocols bgp group external-peers multihop ttl 2
set logical-systems E protocols bgp group external-peers local-address 192.168.6.7
set logical-systems E protocols bgp group external-peers export send-static
set logical-systems E protocols bgp group external-peers peer-as 17
set logical-systems E protocols bgp group external-peers neighbor 192.168.40.4
set logical-systems E policy-options policy-statement send-static term 1 from protocol
static
set logical-systems E policy-options policy-statement send-static term 1 then accept
set logical-systems E routing-options static route 10.10.10.8/30 next-hop 10.10.10.13
set logical-systems E routing-options static route 192.168.40.4/32 next-hop 10.10.10.13
set logical-systems E routing-options router-id 192.168.6.7
set logical-systems E routing-options autonomous-system 18

```

### Device C

**Step-by-Step Procedure** The following example requires you to navigate various levels in the configuration hierarchy. For information about navigating the CLI, see *Using the CLI Editor in Configuration Mode in the CLI User Guide*.

To configure Device C:

1. Set the CLI to Logical System C.
2. Configure the interface to the directly-connected device (to-D), and configure the loopback interface.

```

[edit interfaces lt-1/2/0 unit 9]
user@host:C# set description to-D
user@host:C# set encapsulation ethernet
user@host:C# set peer-unit 10
user@host:C# set family inet address 10.10.10.9/30

```

```

[edit interfaces lo0 unit 3]
user@host:C# set family inet address 192.168.40.4/32

```

3. Configure an EBGP session with Logical System E.

The **neighbor** statement points to the loopback interface on Logical System E.

```

[edit protocols bgp group external-peers]
user@host:C# set type external
user@host:C# set local-address 192.168.40.4
user@host:C# set export send-static
user@host:C# set peer-as 18
user@host:C# set neighbor 192.168.6.7

```

4. Configure the multihop statement to enable Logical System C and Logical System E to become EBGP peers.

Because the peers are two hops away from each other, the example uses the **ttl 2** statement.

```

[edit protocols bgp group external-peers]
user@host:C# set multihop ttl 2

```

5. Configure connectivity to Logical System E, using static routes.

You must configure a route to both the loopback interface address and to the address on the physical interface.

```
[edit logical-systems C routing-options]
user@host:C# set static route 10.10.10.14/32 next-hop 10.10.10.10
user@host:C# set static route 192.168.6.7/32 next-hop 10.10.10.10
```

6. Configure the local router ID and the autonomous system (AS) number.

```
[edit routing-options]
user@host:C# set router-id 192.168.40.4
user@host:C# set autonomous-system 17
```

7. Configure a policy that accepts direct routes.

Other useful options for this scenario might be to accept routes learned through OSPF or local routes.

```
[edit policy-options policy-statement send-static term 1]
user@host:C# set from protocol static
user@host:C# set then accept
```

**Results** From configuration mode, confirm your configuration by entering the **show interfaces**, **show protocols**, **show policy-options**, and **show routing-options** commands. If the output does not display the intended configuration, repeat the instructions in this example to correct the configuration.

```
user@host:C# show interfaces
lt-1/2/0 {
 unit 9 {
 description to-D;
 encapsulation ethernet;
 peer-unit 10;
 family inet {
 address 10.10.10.9/30;
 }
 }
}
lo0 {
 unit 3 {
 family inet {
 address 192.168.40.4/32;
 }
 }
}

user@host:C# show protocols
bgp {
 group external-peers {
 type external;
 multihop {
 ttl 2;
 }
 }
 local-address 192.168.40.4;
 export send-static;
```



```

 peer-as 18;
 neighbor 192.168.6.7;
 }
}

user@host:C# show policy-options
policy-statement send-static {
 term 1 {
 from protocol static;
 then accept;
 }
}

user@host:C# show routing-options
static {
 route 10.10.10.14/32 next-hop 10.10.10.10;
 route 192.168.6.7/32 next-hop 10.10.10.10;
}
router-id 192.168.40.4;
autonomous-system 17;

```

If you are done configuring the device, enter **commit** from configuration mode. Repeat these steps for all BFD sessions in the topology.

#### **Device D**

**Step-by-Step Procedure** The following example requires you to navigate various levels in the configuration hierarchy. For information about navigating the CLI, see Using the CLI Editor in Configuration Mode in the CLI User Guide.

To configure Device D:

1. Set the CLI to Logical System D.
 

```
user@host> set cli logical-system D
```
2. Configure the interfaces to the directly-connected devices, and configure a loopback interface.

```

[edit interfaces lt-1/2/0 unit 10]
user@host:D# set description to-C
user@host:D# set encapsulation ethernet
user@host:D# set peer-unit 9
user@host:D# set family inet address 10.10.10.10/30

```

```

[edit interfaces lt-1/2/0 unit 13]
user@host:D# set description to-E
user@host:D# set encapsulation ethernet
user@host:D# set peer-unit 14
user@host:D# set family inet address 10.10.10.13/30

```

```

[edit interfaces lo0 unit 4]
user@host:D# set family inet address 192.168.6.6/32

```

3. Configure connectivity to the other devices using a static routes to the loopback interface addresses.

On Logical System D, you do not need static routes to the physical addresses because Logical System D is directly connected to Logical System C and Logical System E.

```
[edit routing-options]
user@host:D# set static route 192.168.40.4/32 next-hop 10.10.10.9
user@host:D# set static route 192.168.6.7/32 next-hop 10.10.10.14
```

4. Configure the local router ID and the autonomous system (AS) number.

```
[edit routing-options]
user@host:D# set router-id 192.168.6.6
```

**Results** From configuration mode, confirm your configuration by entering the **show interfaces** and **show routing-options** commands. If the output does not display the intended configuration, repeat the instructions in this example to correct the configuration.

```
user@host:D# show interfaces
lt-1/2/0 {
 unit 10 {
 description to-C;
 encapsulation ethernet;
 peer-unit 9;
 family inet {
 address 10.10.10.10/30;
 }
 }
 unit 13 {
 description to-E;
 encapsulation ethernet;
 peer-unit 14;
 family inet {
 address 10.10.10.13/30;
 }
 }
}
lo0 {
 unit 4 {
 family inet {
 address 192.168.6.6/32;
 }
 }
}

user@host:D# show protocols

user@host:D# show routing-options
static {
 route 192.168.40.4/32 next-hop 10.10.10.9;
 route 192.168.6.7/32 next-hop 10.10.10.14;
}
router-id 192.168.6.6;
```

If you are done configuring the device, enter **commit** from configuration mode. Repeat these steps for all BFD sessions in the topology.

**Device E**

**Step-by-Step Procedure** The following example requires you to navigate various levels in the configuration hierarchy. For information about navigating the CLI, see Using the CLI Editor in Configuration Mode in the CLI User Guide.

To configure Device E:

1. Set the CLI to Logical System E.

```
user@host> set cli logical-system E
```

2. Configure the interface to the directly-connected device (to-D), and configure the loopback interface.

```
[edit interfaces lt-1/2/0 unit 14]
user@host:E# set description to-D
user@host:E# set encapsulation ethernet
user@host:E# set peer-unit 13
user@host:E# set family inet address 10.10.10.14/30
```

```
[edit interfaces lo0 unit 5]
user@host:E# set family inet address 192.168.6.7/32
```

3. Configure an EBGP session with Logical System E.

The **neighbor** statement points to the loopback interface on Logical System C.

```
[edit protocols bgp group external-peers]
user@host:E# set local-address 192.168.6.7
user@host:E# set export send-static
user@host:E# set peer-as 17
user@host:E# set neighbor 192.168.40.4
```

4. Configure the **multihop** statement to enable Logical System C and Logical System E to become EBGP peers.

Because the peers are two hops away from each other, the example uses the **ttl 2** statement.

```
[edit protocols bgp group external-peers]
user@host:E# set multihop ttl 2
```

5. Configure connectivity to Logical System E, using static routes.

You must configure a route to both the loopback interface address and to the address on the physical interface.

```
[edit routing-options]
user@host:E# set static route 10.10.10.8/30 next-hop 10.10.10.13
user@host:E# set static route 192.168.40.4/32 next-hop 10.10.10.13
```

6. Configure the local router ID and the autonomous system (AS) number.

```
[edit routing-options]
user@host:E# set router-id 192.168.6.7
user@host:E# set autonomous-system 18
```

7. Configure a policy that accepts direct routes.

Other useful options for this scenario might be to accept routes learned through OSPF or local routes.

```
[edit policy-options policy-statement send-static term 1]
user@host:E# set from protocol static
user@host:E# set send-static then accept
```

**Results** From configuration mode, confirm your configuration by entering the **show interfaces**, **show protocols**, **show policy-options**, and **show routing-options** commands. If the output does not display the intended configuration, repeat the instructions in this example to correct the configuration.

```
user@host:E# show interfaces
lt-1/2/0 {
 unit 14 {
 description to-D;
 encapsulation ethernet;
 peer-unit 13;
 family inet {
 address 10.10.10.14/30;
 }
 }
}
lo0 {
 unit 5 {
 family inet {
 address 192.168.6.7/32;
 }
 }
}

user@host:E# show protocols
bgp {
 group external-peers {
 multihop {
 ttl 2;
 }
 local-address 192.168.6.7;
 export send-static;
 peer-as 17;
 neighbor 192.168.40.4;
 }
}

user@host:E# show policy-options
policy-statement send-static {
 term 1 {
 from protocol static;
 then accept;
 }
}

user@host:E# show routing-options
static {
 route 10.10.10.8/30 next-hop 10.10.10.13;
 route 192.168.40.4/32 next-hop 10.10.10.13;
```

```

}
router-id 192.168.6.7;
autonomous-system 18;

```

If you are done configuring the device, enter **commit** from configuration mode.

### Verification

Confirm that the configuration is working properly.

- [Verifying Connectivity on page 157](#)
- [Verifying the BGP Sessions Are Established on page 157](#)
- [Viewing Advertised Routes on page 158](#)

#### *Verifying Connectivity*

**Purpose** Make sure that Device C can ping Device E, specifying the loopback interface address as the source of the ping request.

The loopback interface address is the source address that BGP will be using.

**Action** From operational mode, enter the **ping 10.10.10.14 source 192.168.40.4** command from Logical System C, and enter the **ping 10.10.10.9 source 192.168.6.7** command from Logical System E.

```
user@host:C> ping 10.10.10.14 source 192.168.40.4
```

```

PING 10.10.10.14 (10.10.10.14): 56 data bytes
64 bytes from 10.10.10.14: icmp_seq=0 ttl=63 time=1.262 ms
64 bytes from 10.10.10.14: icmp_seq=1 ttl=63 time=1.202 ms
^C
--- 10.10.10.14 ping statistics ---
2 packets transmitted, 2 packets received, 0% packet loss
round-trip min/avg/max/stddev = 1.202/1.232/1.262/0.030 ms

```

```
user@host:E> ping 10.10.10.9 source 192.168.6.7
```

```

PING 10.10.10.9 (10.10.10.9): 56 data bytes
64 bytes from 10.10.10.9: icmp_seq=0 ttl=63 time=1.255 ms
64 bytes from 10.10.10.9: icmp_seq=1 ttl=63 time=1.158 ms
^C
--- 10.10.10.9 ping statistics ---
2 packets transmitted, 2 packets received, 0% packet loss
round-trip min/avg/max/stddev = 1.158/1.206/1.255/0.049 ms

```

**Meaning** The static routes are working if the pings work.

#### *Verifying the BGP Sessions Are Established*

**Purpose** Verify that the BGP sessions are up.

**Action** From operational mode, enter the **show bgp summary** command.

```
user@host:C> show bgp summary
```

```
Groups: 1 Peers: 1 Down peers: 0
```

```

Table Tot Paths Act Paths Suppressed History Damp State Pending
inet.0 2 0 0 0 0 0
Peer AS InPkt OutPkt OutQ Flaps Last Up/Dwn
State|#Active/Received/Accepted/Damped...
192.168.6.7 18 147 147 0 1 1:04:27
0/2/2/0 0/0/0/0

```

```
user@host:~# show bgp summary
```

```

Groups: 1 Peers: 1 Down peers: 0
Table Tot Paths Act Paths Suppressed History Damp State Pending
inet.0 2 0 0 0 0 0
Peer AS InPkt OutPkt OutQ Flaps Last Up/Dwn
State|#Active/Received/Accepted/Damped...
192.168.40.4 17 202 202 0 1 1:02:18
0/2/2/0 0/0/0/0

```

**Meaning** The output shows that both devices have one peer each. No peers are down.

### Viewing Advertised Routes

**Purpose** Checking to make sure that routes are being advertised by BGP.

**Action** From operational mode, enter the `show route advertising-protocol bgp neighbor` command.

```
user@host:~# show route advertising-protocol bgp 192.168.6.7
```

```

inet.0: 5 destinations, 7 routes (5 active, 0 holddown, 0 hidden)
 Prefix Nexthop MED Lclpref AS path
* 10.10.10.14/32 Self
* 192.168.6.7/32 Self I

```

```
user@host:~# show route advertising-protocol bgp 192.168.40.4
```

```

inet.0: 5 destinations, 7 routes (5 active, 0 holddown, 0 hidden)
 Prefix Nexthop MED Lclpref AS path
* 10.10.10.8/30 Self
* 192.168.40.4/32 Self I

```

**Meaning** The `send-static` routing policy is exporting the static routes from the routing table into BGP. BGP is advertising these routes between the peers because the BGP peer session is established.

**Related Documentation**

- [Introduction to Logical Systems on page 3](#)

## CHAPTER 7

# MPLS

- [Example: Configuring RSVP-Signaled Point-to-Multipoint LSPs on Logical Systems on page 159](#)

### Example: Configuring RSVP-Signaled Point-to-Multipoint LSPs on Logical Systems

- [Point-to-Multipoint LSPs Overview on page 159](#)
- [Example: Configuring an RSVP-Signaled Point-to-Multipoint LSP on Logical Systems on page 161](#)

#### Point-to-Multipoint LSPs Overview

A point-to-multipoint MPLS LSP is an LSP with a single source and multiple destinations. By taking advantage of the MPLS packet replication capability of the network, point-to-multipoint LSPs avoid unnecessary packet replication at the ingress router. Packet replication takes place only when packets are forwarded to two or more different destinations requiring different network paths.

This process is illustrated in [Figure 25 on page 160](#). Router PE1 is configured with a point-to-multipoint LSP to Routers PE2, PE3, and PE4. When Router PE1 sends a packet on the point-to-multipoint LSP to Routers P1 and P2, Router P1 replicates the packet and forwards it to Routers PE2 and PE3. Router P2 sends the packet to Router PE4.

This feature is described in detail in the Internet drafts [draft-raggarwa-mpls-p2mp-te-02.txt](#) (expired February 2004), *Establishing Point to Multipoint MPLS TE LSPs*, [draft-ietf-mpls-rsvp-te-p2mp-02.txt](#), *Extensions to Resource Reservation Protocol-Traffic Engineering (RSVP-TE) for Point-to-Multipoint TE Label-Switched Paths (LSPs)*, and [draft-ietf-mpls-ldp-p2mp-10.txt](#), *Label Distribution Protocol Extensions for Point-to-Multipoint and Multipoint-to-Multipoint Label Switched Paths*.

Figure 25: Point-to-Multipoint LSPs

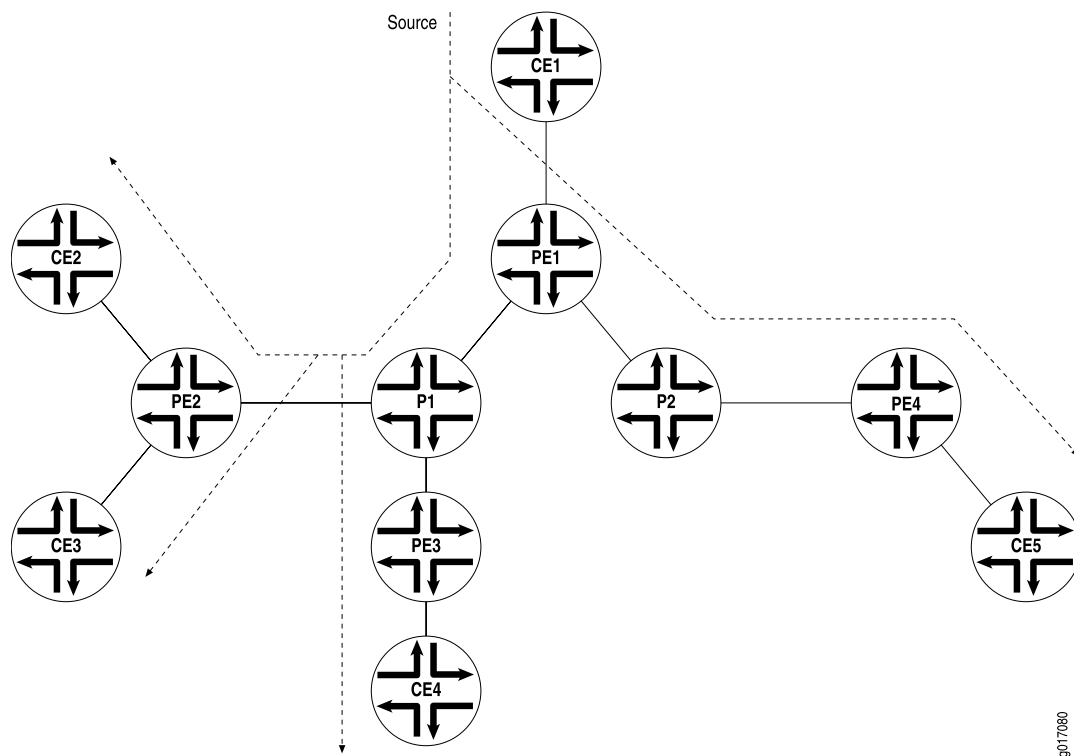

The following are some of the properties of point-to-multipoint LSPs:

- A point-to-multipoint LSP enables you to use MPLS for point-to-multipoint data distribution. This functionality is similar to that provided by IP multicast.
- You can add and remove branch LSPs from a main point-to-multipoint LSP without disrupting traffic. The unaffected parts of the point-to-multipoint LSP continue to function normally.
- You can configure a node to be both a transit and an egress router for different branch LSPs of the same point-to-multipoint LSP.
- You can enable link protection on a point-to-multipoint LSP. Link protection can provide a bypass LSP for each of the branch LSPs that make up the point-to-multipoint LSP. If any of the primary paths fail, traffic can be quickly switched to the bypass.
- You can configure branch LSPs either statically, dynamically, or as a combination of static and dynamic LSPs.
- You can enable graceful Routing Engine switchover (GRES) and graceful restart for point-to-multipoint LSPs at ingress and egress routers. The point-to-multipoint LSPs must be configured using either static routes or circuit cross-connect (CCC). GRES and graceful restart allow the traffic to be forwarded at the Packet Forwarding Engine based on the old state while the control plane recovers. Feature parity for GRES and graceful restart for MPLS point-to-multipoint LSPs on the Junos Trio chipset is supported in Junos OS Releases 11.1R2, 11.2R2, and 11.4.



## Example: Configuring an RSVP-Signaled Point-to-Multipoint LSP on Logical Systems

In this example, multiple logical systems in a physical router act as a collection of paths for an RSVP-signaled point-to-multipoint LSP. The logical systems are chained together and connected internally over a series of logical tunnel (**lt**) interfaces.

- [Requirements on page 161](#)
- [Overview on page 161](#)
- [Configuration on page 162](#)
- [Verification on page 180](#)

### Requirements

This example uses the following hardware and software components:

- One MX Series router running logical systems. You do not need to use an MX Series router for the logical systems. You can use any Juniper Networks router that supports logical systems.
- On the MX Series router, the logical systems are connected using logical tunnel (**lt**) interfaces. For more information, see [“Example: Connecting Logical Systems Within the Same Router Using Logical Tunnel Interfaces on MX Series Routers” on page 32](#) and [“Example: Connecting Logical Systems Within the Same Router Using Logical Tunnel Interfaces” on page 28](#). An alternative to using **lt** interfaces is to create external back-to-back interconnections between ports on the router.
- Four customer-edge (CE) devices running in separate physical devices. You do not need to use routers for the CE devices. For example, the CE devices can be EX Series Ethernet Switches.
- Junos OS Release 12.1 or later running on the MX Series router.

On M Series Multiservice Edge and T Series Core Routers, you can create an **lt** interface if you have a Tunnel Services PIC installed on an Enhanced FPC in your routing platform.

On M40e routers, you can create an **lt** interface if you have a Tunnel Services PIC. (An Enhanced FPC is not required.)

On an M7i router, **lt** interfaces can be created by using the integrated Adaptive Services Module.

On an MX Series router, as is shown in this example, the master administrator can configure **lt** interfaces by including the **tunnel-services** statement at the `[edit chassis fpc slot-number pic number]` hierarchy level.

### Overview

In this example, the logical systems serve as the transit, branch, and leaf nodes of a single point-to-multipoint LSP. Logical system LS1 is the ingress node. The branches go from LS1 to LS5, LS1 to LS7, and LS1 to LS4. Static unicast routes on the ingress node (LS1) point to the egress nodes.

The following topologies are supported:

- A single logical system in a physical router. The logical system is one node in an RSVP-signaled point-to-multipoint LSP.
- Multiple logical systems in a physical router, with each logical system acting as a label-switched router (LSR). The multiple logical systems can be unconnected, connected to each other internally with It interfaces, or connected to each other externally with back-to-back connections.
- One RSVP-signaled point-to-multipoint LSP, with some nodes being logical systems and other nodes being physical routers.

### Topology Diagram

Figure 26 on page 162 shows the topology used in this example.

Figure 26: RSVP-Signaled Point-to-Multipoint LSP on Logical Systems

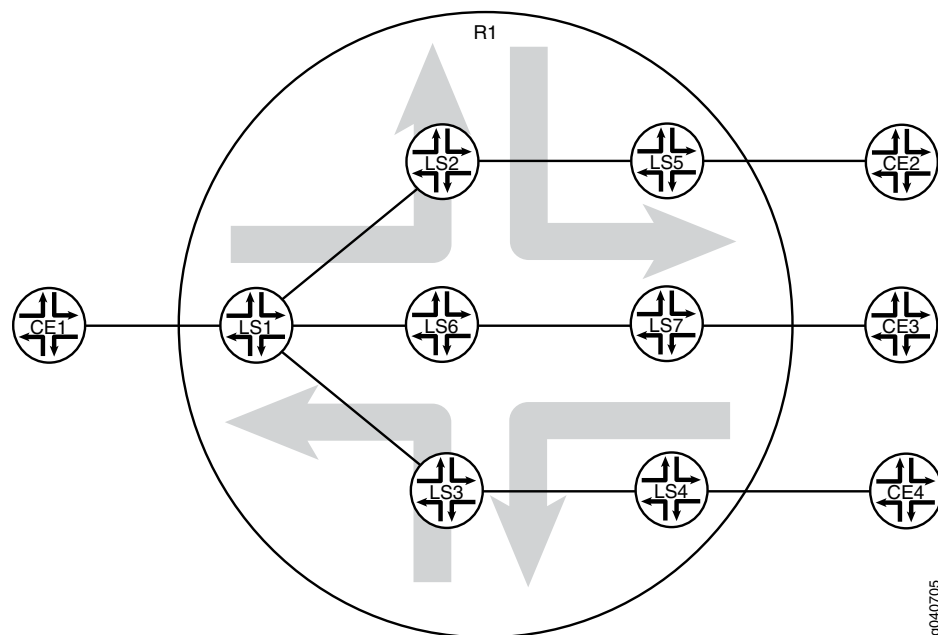

g040705

### Configuration

- [Configuring the MX Series Router to Support Logical Tunnel Interfaces on page 164](#)
- [Configuring the Ingress LSR \(Logical System LS1\) on page 165](#)
- [Configuring the Transit and Egress LSRs \(Logical Systems LS2, LS3, LS4, LS5, LS6, and LS7\) on page 167](#)
- [Configuring Device CE1 on page 177](#)
- [Configuring Device CE2 on page 178](#)
- [Configuring Device CE3 on page 179](#)
- [Configuring Device CE4 on page 179](#)

**CLI Quick Configuration** To quickly configure this example, copy the following commands, paste them into a text file, remove any line breaks, change any details necessary to match your network configuration, and then copy and paste the commands into the CLI at the **[edit]** hierarchy level.

```

Router R1
set logical-systems LS1 interfaces ge-2/0/2 unit 0 description LS1-to-CE1
set logical-systems LS1 interfaces ge-2/0/2 unit 0 family inet address 10.0.244.10/30
set logical-systems LS1 interfaces lt-2/0/10 unit 1 description LS1-to-LS2
set logical-systems LS1 interfaces lt-2/0/10 unit 1 encapsulation ethernet
set logical-systems LS1 interfaces lt-2/0/10 unit 1 peer-unit 2
set logical-systems LS1 interfaces lt-2/0/10 unit 1 family inet address 2.2.2.1/24
set logical-systems LS1 interfaces lt-2/0/10 unit 1 family mpls
set logical-systems LS1 interfaces lt-2/0/10 unit 8 description LS1-to-LS6
set logical-systems LS1 interfaces lt-2/0/10 unit 8 encapsulation ethernet
set logical-systems LS1 interfaces lt-2/0/10 unit 8 peer-unit 6
set logical-systems LS1 interfaces lt-2/0/10 unit 8 family inet address 6.6.6.1/24
set logical-systems LS1 interfaces lt-2/0/10 unit 8 family mpls
set logical-systems LS1 interfaces lt-2/0/10 unit 9 description LS1-to-LS3
set logical-systems LS1 interfaces lt-2/0/10 unit 9 encapsulation ethernet
set logical-systems LS1 interfaces lt-2/0/10 unit 9 peer-unit 3
set logical-systems LS1 interfaces lt-2/0/10 unit 9 family inet address 3.3.3.1/24
set logical-systems LS1 interfaces lt-2/0/10 unit 9 family mpls
set logical-systems LS1 interfaces lo0 unit 1 family inet address 100.10.10.10/32
set logical-systems LS1 protocols rsvp interface lt-2/0/10.1
set logical-systems LS1 protocols rsvp interface lt-2/0/10.8
set logical-systems LS1 protocols rsvp interface lt-2/0/10.9
set logical-systems LS1 protocols rsvp interface lo0.1
set logical-systems LS1 protocols mpls traffic-engineering bgp-igp
set logical-systems LS1 protocols mpls label-switched-path LS1-LS5 to 100.50.50.50
set logical-systems LS1 protocols mpls label-switched-path LS1-LS5 p2mp p2mp1
set logical-systems LS1 protocols mpls label-switched-path LS1-LS7 to 100.70.70.70
set logical-systems LS1 protocols mpls label-switched-path LS1-LS7 p2mp p2mp1
set logical-systems LS1 protocols mpls label-switched-path LS1-LS4 to 100.40.40.40
set logical-systems LS1 protocols mpls label-switched-path LS1-LS4 p2mp p2mp1
set logical-systems LS1 protocols mpls interface lt-2/0/10.1
set logical-systems LS1 protocols mpls interface lt-2/0/10.8
set logical-systems LS1 protocols mpls interface lt-2/0/10.9
set logical-systems LS1 protocols mpls interface lo0.1
set logical-systems LS1 protocols ospf traffic-engineering
set logical-systems LS1 protocols ospf area 0.0.0.0 interface ge-2/0/2.0
set logical-systems LS1 protocols ospf area 0.0.0.0 interface lt-2/0/10.1
set logical-systems LS1 protocols ospf area 0.0.0.0 interface lt-2/0/10.8
set logical-systems LS1 protocols ospf area 0.0.0.0 interface lt-2/0/10.9
set logical-systems LS1 protocols ospf area 0.0.0.0 interface lo0.1
set logical-systems LS1 routing-options static route 5.5.5.0/24 p2mp-lsp-next-hop p2mp1
set logical-systems LS1 routing-options static route 7.7.7.0/24 p2mp-lsp-next-hop p2mp1
set logical-systems LS1 routing-options static route 4.4.4.0/24 p2mp-lsp-next-hop p2mp1
set logical-systems LS1 routing-options router-id 100.10.10.10

Device CE1
set interfaces ge-1/3/2 unit 0 family inet address 10.0.244.9/30
set interfaces ge-1/3/2 unit 0 description CE1-to-LS1
set routing-options static route 10.0.104.8/30 next-hop 10.0.244.10
set routing-options static route 10.0.134.8/30 next-hop 10.0.244.10
set routing-options static route 10.0.224.8/30 next-hop 10.0.244.10

```

**Device CE2**    `set interfaces ge-1/3/3 unit 0 family inet address 10.0.224.9/30`  
`set interfaces ge-1/3/3 unit 0 description CE2-to-LS5`  
`set routing-options static route 10.0.244.8/30 next-hop 10.0.224.10`

**Device CE3**    `set interfaces ge-2/0/1 unit 0 family inet address 10.0.134.9/30`  
`set interfaces ge-2/0/1 unit 0 description CE3-to-LS7`  
`set routing-options static route 10.0.244.8/30 next-hop 10.0.134.10`

**Device CE4**    `set interfaces ge-3/1/3 unit 0 family inet address 10.0.104.10/30`  
`set interfaces ge-3/1/3 unit 0 description CE4-to-LS4`  
`set routing-options static route 10.0.244.8/30 next-hop 10.0.104.9`

### *Configuring the MX Series Router to Support Logical Tunnel Interfaces*

**Step-by-Step Procedure**    The following example requires you to navigate various levels in the configuration hierarchy. For information about navigating the CLI, see *Using the CLI Editor in Configuration Mode in the CLI User Guide*.

This procedure is required for MX Series routers only. If you have an M Series or T Series router, skip this procedure.

To enable **lt** interfaces on the MX Series router:

1. Run the **show chassis fpc** command to verify that the router has a DPC, MPC, or MIC installed and is in the online state.

```
user@host> show chassis fpc
```

| Slot | State  | Temp (C) | CPU Total | Utilization (%) Interrupt | Memory DRAM (MB) | Utilization (%) Heap | Utilization (%) Buffer |
|------|--------|----------|-----------|---------------------------|------------------|----------------------|------------------------|
| 0    | Empty  |          |           |                           |                  |                      |                        |
| 1    | Empty  |          |           |                           |                  |                      |                        |
| 2    | Online | 31       | 3         | 0                         | 1024             | 14                   | 21                     |

This output shows that slot 0 and slot 1 are empty. Slot 2 is online.

2. Configure FPC slot 2 to support **lt** interfaces.

```
[edit]
user@host# set chassis fpc 2 pic 0 tunnel-services bandwidth 1g
```

This command creates several tunnel interface types, including **gr**, **ip**, and **lt**. For this example, the important one is the **lt** interface.

3. Commit the configuration.

```
[edit]
user@host# commit
user@host# exit
```

4. Run the **show interfaces terse** command to verify that the router has an **lt** interface.

```
user@host> show interfaces terse
```

| Interface | Admin | Link | Proto | Local | Remote |
|-----------|-------|------|-------|-------|--------|
| ...       |       |      |       |       |        |
| gr-2/0/10 | up    | up   |       |       |        |
| ip-2/0/10 | up    | up   |       |       |        |
| lt-2/0/10 | up    | up   |       |       |        |
| ...       |       |      |       |       |        |

**Configuring the Ingress LSR (Logical System LS1)****Step-by-Step Procedure**

To configure Logical System LS1:

1. From the main router, configure the logical system.

```
[edit]
user@R1# set logical-systems LS1
```

2. Commit the configuration.

```
[edit]
user@R1# commit
user@R1# exit
```

3. Set the CLI to view the logical system.

```
user@R1> set cli logical-system LS1
Logical system: LS1
```

```
user@R1:LS1>
```

4. Configure the interfaces, interface encapsulation, and protocol families.

```
[edit]
user@R1:LS1# edit interfaces
[edit interfaces]
user@R1:LS1# set ge-2/0/2 unit 0 description R1-to-CE1
user@R1:LS1# set ge-2/0/2 unit 0 family inet address 10.0.244.10/30
user@R1:LS1# set lt-2/0/10 unit 1 description LS1-to-LS2
user@R1:LS1# set lt-2/0/10 unit 1 encapsulation ethernet
user@R1:LS1# set lt-2/0/10 unit 1 peer-unit 2
user@R1:LS1# set lt-2/0/10 unit 1 family inet address 2.2.2.1/24
user@R1:LS1# set lt-2/0/10 unit 1 family mpls
user@R1:LS1# set lt-2/0/10 unit 8 description LS1-to-LS6
user@R1:LS1# set lt-2/0/10 unit 8 encapsulation ethernet
user@R1:LS1# set lt-2/0/10 unit 8 peer-unit 6
user@R1:LS1# set lt-2/0/10 unit 8 family inet address 6.6.6.1/24
user@R1:LS1# set lt-2/0/10 unit 8 family mpls
user@R1:LS1# set lt-2/0/10 unit 9 description LS1-to-LS3
user@R1:LS1# set lt-2/0/10 unit 9 encapsulation ethernet
user@R1:LS1# set lt-2/0/10 unit 9 peer-unit 3
user@R1:LS1# set lt-2/0/10 unit 9 family inet address 3.3.3.1/24
user@R1:LS1# set lt-2/0/10 unit 9 family mpls
user@R1:LS1# set lo0 unit 1 family inet address 100.10.10.10/32
user@R1:LS1# exit
```

5. Enable RSVP, MPLS, and OSPF on the interfaces.

```
[edit]
user@R1:LS1# edit protocols
[edit protocols]
user@R1:LS1# set rsvp interface lt-2/0/10.1
user@R1:LS1# set rsvp interface lt-2/0/10.8
user@R1:LS1# set rsvp interface lt-2/0/10.9
user@R1:LS1# set rsvp interface lo0.1
user@R1:LS1# set mpls interface lt-2/0/10.1
user@R1:LS1# set mpls interface lt-2/0/10.8
user@R1:LS1# set mpls interface lt-2/0/10.9
```

```
user@R1:LS1# set mpls interface lo0.1
user@R1:LS1# set ospf area 0.0.0.0 interface ge-2/0/2.0
user@R1:LS1# set ospf area 0.0.0.0 interface lt-2/0/10.1
user@R1:LS1# set ospf area 0.0.0.0 interface lt-2/0/10.8
user@R1:LS1# set ospf area 0.0.0.0 interface lt-2/0/10.9
user@R1:LS1# set ospf area 0.0.0.0 interface lo0.1
```

6. Configure the MPLS point-to-multipoint LSPs.

```
[edit protocols]
user@R1:LS1# set mpls label-switched-path LS1-LS5 to 100.50.50.50
user@R1:LS1# set mpls label-switched-path LS1-LS5 p2mp p2mp1
user@R1:LS1# set mpls label-switched-path LS1-LS7 to 100.70.70.70
user@R1:LS1# set mpls label-switched-path LS1-LS7 p2mp p2mp1
user@R1:LS1# set mpls label-switched-path LS1-LS4 to 100.40.40.40
user@R1:LS1# set mpls label-switched-path LS1-LS4 p2mp p2mp1
```

7. Enable MPLS to perform traffic engineering for OSPF.

```
[edit protocols]
user@R1:LS1# set mpls traffic-engineering bgp-igp
user@R1:LS1# exit
```

This causes the ingress routes to be installed in the `inet.0` routing table. By default, MPLS performs traffic engineering for BGP only. You need to enable MPLS traffic engineering on the ingress LSR only.

8. Enable traffic engineering for OSPF.

```
[edit protocols]
user@R1:LS1# set ospf traffic-engineering
user@R1:LS1# exit
```

This causes the shortest-path first (SPF) algorithm to take into account the LSPs configured under MPLS.

9. Configure the router ID.

```
[edit]
user@R1:LS1# edit routing-options
[edit routing-options]
user@R1:LS1# set router-id 100.10.10.10
```

10. Configure static IP unicast routes with the point-to-multipoint LSP name as the next hop for each route.

```
[edit routing-options]
user@R1:LS1# set static route 5.5.5.0/24 p2mp-lsp-next-hop p2mp1
user@R1:LS1# set static route 7.7.7.0/24 p2mp-lsp-next-hop p2mp1
user@R1:LS1# set static route 4.4.4.0/24 p2mp-lsp-next-hop p2mp1
user@R1:LS1# exit
```

11. If you are done configuring the device, commit the configuration.

```
[edit]
user@R1:LS1# commit
```

### *Configuring the Transit and Egress LSRs (Logical Systems LS2, LS3, LS4, LS5, LS6, and LS7)*

**Step-by-Step Procedure** To configure the transit and egress LSRs:

1. Configure the interfaces, interface encapsulation, and protocol families.

```
[edit]
user@R1# edit logical-systems
[edit logical-systems]
user@R1# set LS2 interfaces lt-2/0/10 unit 2 description LS2-to-LS1
user@R1# set LS2 interfaces lt-2/0/10 unit 2 encapsulation ethernet
user@R1# set LS2 interfaces lt-2/0/10 unit 2 peer-unit 1
user@R1# set LS2 interfaces lt-2/0/10 unit 2 family inet address 2.2.2.2/24
user@R1# set LS2 interfaces lt-2/0/10 unit 2 family mpls
user@R1# set LS2 interfaces lt-2/0/10 unit 10 description LS2-to-LS5
user@R1# set LS2 interfaces lt-2/0/10 unit 10 encapsulation ethernet
user@R1# set LS2 interfaces lt-2/0/10 unit 10 peer-unit 5
user@R1# set LS2 interfaces lt-2/0/10 unit 10 family inet address 5.5.5.1/24
user@R1# set LS2 interfaces lt-2/0/10 unit 10 family mpls
user@R1# set LS2 interfaces lo0 unit 2 family inet address 100.20.20.20/32
user@R1# set LS3 interfaces lt-2/0/10 unit 3 description LS3-to-LS1
user@R1# set LS3 interfaces lt-2/0/10 unit 3 encapsulation ethernet
user@R1# set LS3 interfaces lt-2/0/10 unit 3 peer-unit 9
user@R1# set LS3 interfaces lt-2/0/10 unit 3 family inet address 3.3.3.2/24
user@R1# set LS3 interfaces lt-2/0/10 unit 3 family mpls
user@R1# set LS3 interfaces lt-2/0/10 unit 12 description LS3-to-LS4
user@R1# set LS3 interfaces lt-2/0/10 unit 12 encapsulation ethernet
user@R1# set LS3 interfaces lt-2/0/10 unit 12 peer-unit 4
user@R1# set LS3 interfaces lt-2/0/10 unit 12 family inet address 4.4.4.1/24
user@R1# set LS3 interfaces lt-2/0/10 unit 12 family mpls
user@R1# set LS3 interfaces lo0 unit 3 family inet address 100.30.30.30/32
user@R1# set LS4 interfaces ge-2/0/0 unit 0 description R1-to-CE4
user@R1# set LS4 interfaces ge-2/0/0 unit 0 family inet address 10.0.104.9/30
user@R1# set LS4 interfaces lt-2/0/10 unit 4 description LS4-to-LS3
user@R1# set LS4 interfaces lt-2/0/10 unit 4 encapsulation ethernet
user@R1# set LS4 interfaces lt-2/0/10 unit 4 peer-unit 12
user@R1# set LS4 interfaces lt-2/0/10 unit 4 family inet address 4.4.4.2/24
user@R1# set LS4 interfaces lt-2/0/10 unit 4 family mpls
user@R1# set LS4 interfaces lo0 unit 4 family inet address 100.40.40.40/32
user@R1# set LS5 interfaces ge-2/0/3 unit 0 description LS1-to-CE1
user@R1# set LS5 interfaces ge-2/0/3 unit 0 family inet address 10.0.224.10/30
user@R1# set LS5 interfaces lt-2/0/10 unit 5 description LS5-to-LS2
user@R1# set LS5 interfaces lt-2/0/10 unit 5 encapsulation ethernet
user@R1# set LS5 interfaces lt-2/0/10 unit 5 peer-unit 10
user@R1# set LS5 interfaces lt-2/0/10 unit 5 family inet address 5.5.5.2/24
user@R1# set LS5 interfaces lt-2/0/10 unit 5 family mpls
user@R1# set LS5 interfaces lo0 unit 5 family inet address 100.50.50.50/32
user@R1# set LS6 interfaces lt-2/0/10 unit 6 description LS6-to-LS1
user@R1# set LS6 interfaces lt-2/0/10 unit 6 encapsulation ethernet
user@R1# set LS6 interfaces lt-2/0/10 unit 6 peer-unit 8
user@R1# set LS6 interfaces lt-2/0/10 unit 6 family inet address 6.6.6.2/24
user@R1# set LS6 interfaces lt-2/0/10 unit 6 family mpls
user@R1# set LS6 interfaces lt-2/0/10 unit 11 description LS6-to-LS7
user@R1# set LS6 interfaces lt-2/0/10 unit 11 encapsulation ethernet
user@R1# set LS6 interfaces lt-2/0/10 unit 11 peer-unit 7
```

```

user@R1# set LS6 interfaces lt-2/0/10 unit 11 family inet address 7.7.7.2/24
user@R1# set LS6 interfaces lt-2/0/10 unit 11 family mpls
user@R1# set LS6 interfaces lo0 unit 6 family inet address 100.60.60.60/32
user@R1# set LS7 interfaces ge-2/0/1 unit 0 description R1-to-CE3
user@R1# set LS7 interfaces ge-2/0/1 unit 0 family inet address 10.0.134.10/30
user@R1# set LS7 interfaces lt-2/0/10 unit 7 description LS7-to-LS6
user@R1# set LS7 interfaces lt-2/0/10 unit 7 encapsulation ethernet
user@R1# set LS7 interfaces lt-2/0/10 unit 7 peer-unit 11
user@R1# set LS7 interfaces lt-2/0/10 unit 7 family inet address 7.7.7.2/24
user@R1# set LS7 interfaces lt-2/0/10 unit 7 family mpls
user@R1# set LS7 interfaces lo0 unit 7 family inet address 100.70.70.70/32

```

2. Enable RSVP, MPLS, and OSPF on the interfaces.

```

[edit]
user@R1# edit logical-systems
[edit logical-systems]
user@R1# set LS2 protocols rsvp interface lt-2/0/10.2
user@R1# set LS2 protocols rsvp interface lt-2/0/10.10
user@R1# set LS2 protocols rsvp interface lo0.2
user@R1# set LS2 protocols mpls interface lt-2/0/10.2
user@R1# set LS2 protocols mpls interface lt-2/0/10.10
user@R1# set LS2 protocols mpls interface lo0.2
user@R1# set LS2 protocols ospf area 0.0.0.0 interface lt-2/0/10.2
user@R1# set LS2 protocols ospf area 0.0.0.0 interface lt-2/0/10.10
user@R1# set LS2 protocols ospf area 0.0.0.0 interface lo0.2
user@R1# set LS3 protocols rsvp interface lt-2/0/10.3
user@R1# set LS3 protocols rsvp interface lt-2/0/10.12
user@R1# set LS3 protocols rsvp interface lo0.3
user@R1# set LS3 protocols mpls interface lt-2/0/10.3
user@R1# set LS3 protocols mpls interface lt-2/0/10.12
user@R1# set LS3 protocols mpls interface lo0.3
user@R1# set LS3 protocols ospf area 0.0.0.0 interface lt-2/0/10.3
user@R1# set LS3 protocols ospf area 0.0.0.0 interface lt-2/0/10.12
user@R1# set LS3 protocols ospf area 0.0.0.0 interface lo0.3
user@R1# set LS4 protocols rsvp interface lt-2/0/10.4
user@R1# set LS4 protocols rsvp interface lo0.4
user@R1# set LS4 protocols mpls interface lt-2/0/10.4
user@R1# set LS4 protocols mpls interface lo0.4
user@R1# set LS4 protocols ospf area 0.0.0.0 interface ge-2/0/0.0
user@R1# set LS4 protocols ospf area 0.0.0.0 interface lt-2/0/10.4
user@R1# set LS4 protocols ospf area 0.0.0.0 interface lo0.4
user@R1# set LS5 protocols rsvp interface lt-2/0/10.5
user@R1# set LS5 protocols rsvp interface lo0.5
user@R1# set LS5 protocols mpls interface lt-2/0/10.5
user@R1# set LS5 protocols mpls interface lo0.5
user@R1# set LS5 protocols ospf area 0.0.0.0 interface ge-2/0/3.0
user@R1# set LS5 protocols ospf area 0.0.0.0 interface lt-2/0/10.5
user@R1# set LS5 protocols ospf area 0.0.0.0 interface lo0.5
user@R1# set LS6 protocols rsvp interface lt-2/0/10.6
user@R1# set LS6 protocols rsvp interface lt-2/0/10.11
user@R1# set LS6 protocols rsvp interface lo0.6
user@R1# set LS6 protocols mpls interface lt-2/0/10.6
user@R1# set LS6 protocols mpls interface lt-2/0/10.11
user@R1# set LS6 protocols mpls interface lo0.6
user@R1# set LS6 protocols ospf area 0.0.0.0 interface lt-2/0/10.6

```



```

user@R1# set LS6 protocols ospf area 0.0.0.0 interface lt-2/0/10.11
user@R1# set LS6 protocols ospf area 0.0.0.0 interface lo0.6
user@R1# set LS7 protocols rsvp interface lt-2/0/10.7
user@R1# set LS7 protocols rsvp interface lo0.7
user@R1# set LS7 protocols mpls interface lt-2/0/10.7
user@R1# set LS7 protocols mpls interface lo0.7
user@R1# set LS7 protocols ospf area 0.0.0.0 interface ge-2/0/1.0
user@R1# set LS7 protocols ospf area 0.0.0.0 interface lt-2/0/10.7
user@R1# set LS7 protocols ospf area 0.0.0.0 interface lo0.7

```

3. Enable traffic engineering for OSPF.

```

[edit logical-systems]
user@R1# set LS2 protocols ospf traffic-engineering
user@R1# set LS3 protocols ospf traffic-engineering
user@R1# set LS4 protocols ospf traffic-engineering
user@R1# set LS5 protocols ospf traffic-engineering
user@R1# set LS6 protocols ospf traffic-engineering
user@R1# set LS7 protocols ospf traffic-engineering

```

This causes the SPF algorithm to take into account the LSPs configured under MPLS.

4. Configure the router IDs.

```

[edit logical-systems]
user@R1# set LS2 routing-options router-id 100.20.20.20
user@R1# set LS3 routing-options router-id 100.30.30.30
user@R1# set LS4 routing-options router-id 100.40.40.40
user@R1# set LS5 routing-options router-id 100.50.50.50
user@R1# set LS6 routing-options router-id 100.60.60.60
user@R1# set LS7 routing-options router-id 100.70.70.70

```

5. If you are done configuring the device, commit the configuration.

```

[edit logical-systems]
user@R1# commit

```

**Results** From configuration mode, confirm your configuration by entering the `show logical-systems` command. If the output does not display the intended configuration, repeat the instructions in this example to correct the configuration.

```

user@R1# show logical-systems
LS1 {
 interfaces {
 ge-2/0/2 {
 unit 0 {
 description R1-to-CE1;
 family inet {
 address 10.0.244.10/30;
 }
 }
 }
 }
 lt-2/0/10 {
 unit 1 {
 description LS1-to-LS2;
 encapsulation ethernet;
 }
 }
}

```

```
 peer-unit 2;
 family inet {
 address 2.2.2.1/24;
 }
 family mpls;
}
unit 8 {
 description LS1-to-LS6;
 encapsulation ethernet;
 peer-unit 6;
 family inet {
 address 6.6.6.1/24;
 }
 family mpls;
}
unit 9 {
 description LS1-to-LS3;
 encapsulation ethernet;
 peer-unit 3;
 family inet {
 address 3.3.3.1/24;
 }
 family mpls;
}
}
lo0 {
 unit 1 {
 family inet {
 address 100.10.10.10/32;
 }
 }
}
}
protocols {
 rsvp {
 interface lt-2/0/10.1;
 interface lt-2/0/10.8;
 interface lt-2/0/10.9;
 interface lo0.1;
 }
 mpls {
 traffic-engineering bgp-igp;
 label-switched-path LS1-to-LS5 {
 to 100.50.50.50;
 p2mp p2mp1;
 }
 label-switched-path LS1-to-LS7 {
 to 100.70.70.70;
 p2mp p2mp1;
 }
 label-switched-path LS1-to-LS4 {
 to 100.40.40.40;
 p2mp p2mp1;
 }
 }
 interface lt-2/0/10.1;
 interface lt-2/0/10.8;
```

```
 interface lt-2/0/10.9;
 interface lo0.1;
 }
 ospf {
 traffic-engineering;
 area 0.0.0.0 {
 interface ge-2/0/2.0;
 interface lt-2/0/10.1;
 interface lt-2/0/10.8;
 interface lt-2/0/10.9;
 interface lo0.1;
 }
 }
}
routing-options {
 static {
 route 5.5.5.0/24 {
 p2mp-lsp-next-hop p2mp1;
 }
 route 7.7.7.0/24 {
 p2mp-lsp-next-hop p2mp1;
 }
 route 4.4.4.0/24 {
 p2mp-lsp-next-hop p2mp1;
 }
 }
}
router-id 100.10.10.10;
}
}
LS2 {
 interfaces {
 lt-2/0/10 {
 unit 2 {
 description LS2-to-LS1;
 encapsulation ethernet;
 peer-unit 1;
 family inet {
 address 2.2.2.2/24;
 }
 family mpls;
 }
 unit 10 {
 description LS2-to-LS5;
 encapsulation ethernet;
 peer-unit 5;
 family inet {
 address 5.5.5.1/24;
 }
 family mpls;
 }
 }
 }
 lo0 {
 unit 2 {
 family inet {
 address 100.20.20.20/32;
 }
 }
 }
}
```

```
 }
 }
}
protocols {
 rsvp {
 interface lt-2/0/10.2;
 interface lt-2/0/10.10;
 interface lo0.2;
 }
 mpls {
 interface lt-2/0/10.2;
 interface lt-2/0/10.10;
 interface lo0.2;
 }
 ospf {
 traffic-engineering;
 area 0.0.0.0 {
 interface lt-2/0/10.2;
 interface lt-2/0/10.10;
 interface lo0.2;
 }
 }
}
routing-options {
 router-id 100.20.20.20;
}
}
LS3 {
 interfaces {
 lt-2/0/10 {
 unit 3 {
 description LS3-to-LS1;
 encapsulation ethernet;
 peer-unit 9;
 family inet {
 address 3.3.3.2/24;
 }
 family mpls;
 }
 unit 12 {
 description LS3-to-LS4;
 encapsulation ethernet;
 peer-unit 4;
 family inet {
 address 4.4.4.1/24;
 }
 family mpls;
 }
 }
 }
 lo0 {
 unit 3 {
 family inet {
 address 100.30.30.30/32;
 }
 }
 }
}
```

```

}
protocols {
 rsvp {
 interface lt-2/0/10.3;
 interface lt-2/0/10.12;
 interface lo0.3;
 }
 mpls {
 interface lt-2/0/10.3;
 interface lt-2/0/10.12;
 interface lo0.3;
 }
 ospf {
 traffic-engineering;
 area 0.0.0.0 {
 interface lt-2/0/10.3;
 interface lt-2/0/10.12;
 interface lo0.3;
 }
 }
}
routing-options {
 router-id 100.30.30.30;
}
}
LS4 {
 interfaces {
 ge-2/0/0 {
 unit 0 {
 description R1-to-CE4;
 family inet {
 address 10.0.104.9/30;
 }
 }
 }
 lt-2/0/10 {
 unit 4 {
 description LS4-to-LS3;
 encapsulation ethernet;
 peer-unit 12;
 family inet {
 address 4.4.4.2/24;
 }
 family mpls;
 }
 }
 }
 lo0 {
 unit 4 {
 family inet {
 address 100.40.40.40/32;
 }
 }
 }
}
protocols {
 rsvp {

```

```
 interface lt-2/0/10.4;
 interface lo0.4;
 }
 mpls {
 interface lt-2/0/10.4;
 interface lo0.4;
 }
 ospf {
 traffic-engineering;
 area 0.0.0.0 {
 interface ge-2/0/0.0;
 interface lt-2/0/10.4;
 interface lo0.4;
 }
 }
}
routing-options {
 router-id 100.40.40.40;
}
}
LS5 {
 interfaces {
 ge-2/0/3 {
 unit 0 {
 description LS1-to-CE1;
 family inet {
 address 10.0.224.10/30;
 }
 }
 }
 lt-2/0/10 {
 unit 5 {
 description LS5-to-LS2;
 encapsulation ethernet;
 peer-unit 10;
 family inet {
 address 5.5.5.2/24;
 }
 family mpls;
 }
 }
 lo0 {
 unit 5 {
 family inet {
 address 100.50.50.50/32;
 }
 }
 }
 }
}
protocols {
 rsvp {
 interface lt-2/0/10.5;
 interface lo0.5;
 }
 mpls {
 interface lt-2/0/10.5;
 }
}
```

```
 interface lo0.5;
 }
 ospf {
 traffic-engineering;
 area 0.0.0.0 {
 interface ge-2/0/3.0;
 interface lt-2/0/10.5;
 interface lo0.5;
 }
 }
}
routing-options {
 router-id 100.50.50.50;
}
}
LS6 {
 interfaces {
 lt-2/0/10 {
 unit 6 {
 description LS6-to-LS1;
 encapsulation ethernet;
 peer-unit 8;
 family inet {
 address 6.6.6.2/24;
 }
 family mpls;
 }
 unit 11 {
 description LS6-to-LS7;
 encapsulation ethernet;
 peer-unit 7;
 family inet {
 address 7.7.7.1/24;
 }
 family mpls;
 }
 }
 lo0 {
 unit 6 {
 family inet {
 address 100.60.60.60/32;
 }
 }
 }
 }
}
protocols {
 rsvp {
 interface lt-2/0/10.6;
 interface lt-2/0/10.11;
 interface lo0.6;
 }
 mpls {
 interface lt-2/0/10.6;
 interface lt-2/0/10.11;
 interface lo0.6;
 }
}
```

```
 ospf {
 traffic-engineering;
 area 0.0.0.0 {
 interface lt-2/0/10.6;
 interface lt-2/0/10.11;
 interface lo0.6;
 }
 }
 }
 routing-options {
 router-id 100.60.60.60;
 }
}
LS7 {
 interfaces {
 ge-2/0/1 {
 unit 0 {
 description R1-to-CE3;
 family inet {
 address 10.0.134.10/30;
 }
 }
 }
 lt-2/0/10 {
 unit 7 {
 description LS7-to-LS6;
 encapsulation ethernet;
 peer-unit 11;
 family inet {
 address 7.7.7.2/24;
 }
 family mpls;
 }
 }
 lo0 {
 unit 7 {
 family inet {
 address 100.70.70.70/32;
 }
 }
 }
 }
}
protocols {
 rsvp {
 interface lt-2/0/10.7;
 interface lo0.7;
 }
 mpls {
 interface lt-2/0/10.7;
 interface lo0.7;
 }
 ospf {
 traffic-engineering;
 area 0.0.0.0 {
 interface ge-2/0/1.0;
 interface lt-2/0/10.7;
 }
 }
}
```



```

 interface lo0.7;
 }
 }
}
routing-options {
 router-id 100.70.70.70;
}
}

```

### Configuring Device CE1

**Step-by-Step Procedure** To configure Device CE1:

1. Configure an interface to Logical System LS1.

```

[edit]
user@CE1# edit interfaces
[edit interfaces]
user@CE1# set ge-1/3/2 unit 0 family inet address 10.0.244.9/30
user@CE1# set ge-1/3/2 unit 0 description CE1-to-LS1
user@CE1# exit

```

2. Configure static routes from Device CE1 to the three other customer networks, with Logical System LS1 as the next hop.

```

[edit]
user@CE1# edit routing-options
[edit routing-options]
set static route 10.0.104.8/30 next-hop 10.0.244.10
set static route 10.0.134.8/30 next-hop 10.0.244.10
set static route 10.0.224.8/30 next-hop 10.0.244.10
user@CE1# exit

```

3. If you are done configuring the device, commit the configuration.

```

[edit]
user@CE1# commit

```

**Results** From configuration mode, confirm your configuration by entering the **show interfaces** and **show routing-options** commands. If the output does not display the intended configuration, repeat the instructions in this example to correct the configuration.

```

user@CE1# show interfaces
interfaces {
 ge-1/3/2 {
 unit 0 {
 family inet {
 address 10.0.244.9/30;
 description CE1-to-LS1;
 }
 }
 }
}

user@CE1# show routing-options
routing-options {
 static {

```

```

route 10.0.104.8/30 next-hop 10.0.244.10;
route 10.0.134.8/30 next-hop 10.0.244.10;
route 10.0.224.8/30 next-hop 10.0.244.10;
}
}

```

### Configuring Device CE2

**Step-by-Step Procedure** To configure Device CE2:

1. Configure an interface to Logical System LS5.

```

[edit]
user@CE2# edit interfaces
[edit interfaces]
user@CE2# set ge-1/3/3 unit 0 family inet address 10.0.224.9/30
user@CE2# set ge-1/3/3 unit 0 description CE2-to-LS5
user@CE2# exit

```

2. Configure a static route from Device CE2 to CE1, with Logical System LS5 as the next hop.

```

[edit]
user@CE2# edit routing-options
[edit routing-options]
user@CE2# set static route 10.0.244.8/30 next-hop 10.0.224.10
user@CE2# exit

```

3. If you are done configuring the device, commit the configuration.

```

[edit]
user@CE2# commit

```

**Results** From configuration mode, confirm your configuration by entering the **show interfaces** and **show routing-options** commands. If the output does not display the intended configuration, repeat the instructions in this example to correct the configuration.

```

user@CE2# show interfaces
interfaces {
 ge-1/3/3 {
 unit 0 {
 family inet {
 address 10.0.224.9/30;
 description CE2-to-LS5;
 }
 }
 }
}

user@CE2# show routing-options
routing-options {
 static {
 route 10.0.244.8/30 next-hop 10.0.224.10;
 }
}

```

**Configuring Device CE3****Step-by-Step Procedure**

To configure Device CE3:

1. Configure an interface to Logical System LS7.

```
[edit]
user@CE3# edit interfaces
[edit interfaces]
user@CE3# set ge-2/0/1 unit 0 family inet address 10.0.134.9/30
user@CE3# set ge-2/0/1 unit 0 description CE3-to-LS7
user@CE3# exit
```

2. Configure a static route from Device CE3 to CE1, with Logical System LS7 as the next hop.

```
[edit]
user@CE3# edit routing-options
[edit routing-options]
user@CE3# set static route 10.0.244.8/30 next-hop 10.0.134.10
user@CE3# exit
```

3. If you are done configuring the device, commit the configuration.

```
[edit]
user@CE3# commit
```

**Results**

From configuration mode, confirm your configuration by entering the **show interfaces** and **show routing-options** commands. If the output does not display the intended configuration, repeat the instructions in this example to correct the configuration.

```
user@CE3# show interfaces
interfaces {
 ge-2/0/1 {
 unit 0 {
 family inet {
 address 10.0.134.9/30;
 description CE3-to-LS7;
 }
 }
 }
}

user@CE3# show routing-options
routing-options {
 static {
 route 10.0.244.8/30 next-hop 10.0.134.10;
 }
}
```

**Configuring Device CE4****Step-by-Step Procedure**

To configure Device CE4:

1. Configure an interface to Logical System LS4.

```
[edit]
```

```

user@CE4# edit interfaces
[edit interfaces]
user@CE4# set ge-3/1/3 unit 0 family inet address 10.0.104.10/30
user@CE4# set ge-3/1/3 unit 0 description CE4-to-LS4

```

2. Configure a static route from Device CE4 to CE1, with Logical System LS4 as the next hop.

```

[edit]
user@CE4# edit routing-options
[edit routing-options]
user@CE4# set static route 10.0.244.8/30 next-hop 10.0.104.9
user@CE4# exit

```

3. If you are done configuring the device, commit the configuration.

```

[edit]
user@CE4# commit

```

**Results** From configuration mode, confirm your configuration by entering the **show interfaces** and **show routing-options** commands. If the output does not display the intended configuration, repeat the instructions in this example to correct the configuration.

```

user@CE4# show interfaces
interfaces {
 ge-3/1/3 {
 unit 0 {
 family inet {
 address 10.0.104.10/30;
 description CE4-to-LS4;
 }
 }
 }
}

user@CE4# show routing-options
routing-options {
 static {
 route 10.0.244.8/30 next-hop 10.0.104.9;
 }
}

```

### Verification

Confirm that the configuration is working properly.

- [Verifying Connectivity on page 180](#)
- [Verifying the State of the Point-to-Multipoint LSP on page 181](#)
- [Checking the Forwarding Table on page 182](#)

#### Verifying Connectivity

**Purpose** Make sure that the devices can ping each other.

**Action** Run the **ping** command from CE1 to the interface on CE2 connecting to LS5.

```

user@CE1> ping 10.0.224.9
PING 10.0.224.9 (10.0.224.9): 56 data bytes
64 bytes from 10.0.224.9: icmp_seq=0 ttl=61 time=1.387 ms
64 bytes from 10.0.224.9: icmp_seq=1 ttl=61 time=1.394 ms
64 bytes from 10.0.224.9: icmp_seq=2 ttl=61 time=1.506 ms
^C
--- 10.0.224.9 ping statistics ---
3 packets transmitted, 3 packets received, 0% packet loss
round-trip min/avg/max/stddev = 1.387/1.429/1.506/0.055 ms

```

Run the **ping** command from CE1 to the interface on CE3 connecting to LS7.

```

user@CE1> ping 10.0.134.9
PING 10.0.134.9 (10.0.134.9): 56 data bytes
64 bytes from 10.0.134.9: icmp_seq=0 ttl=61 time=1.068 ms
64 bytes from 10.0.134.9: icmp_seq=1 ttl=61 time=1.062 ms
64 bytes from 10.0.134.9: icmp_seq=2 ttl=61 time=1.053 ms
^C
--- 10.0.134.9 ping statistics ---
3 packets transmitted, 3 packets received, 0% packet loss
round-trip min/avg/max/stddev = 1.053/1.061/1.068/0.006 ms

```

Run the **ping** command from CE1 to the interface on CE4 connecting to LS4.

```

user@CE1> ping 10.0.104.10
PING 10.0.104.10 (10.0.104.10): 56 data bytes
64 bytes from 10.0.104.10: icmp_seq=0 ttl=61 time=1.079 ms
64 bytes from 10.0.104.10: icmp_seq=1 ttl=61 time=1.048 ms
64 bytes from 10.0.104.10: icmp_seq=2 ttl=61 time=1.070 ms
^C
--- 10.0.104.10 ping statistics ---
3 packets transmitted, 3 packets received, 0% packet loss
round-trip min/avg/max/stddev = 1.048/1.066/1.079/0.013 ms

```

### Verifying the State of the Point-to-Multipoint LSP

**Purpose** Make sure that the ingress, transit, and egress LSRs are in the Up state.



**NOTE:** For this example, the `show rsvp session` command displays the same output as the `show mpls lsp p2mp` command.

**Action** Run the `show mpls lsp p2mp` command on all of the LSRs. Only the ingress LSR is shown here.

```

user@R1> set cli logical-system LS1
Logical system: LS1

user@R1:LS1> show mpls lsp p2mp
Ingress LSP: 1 sessions
P2MP name: p2mp1, P2MP branch count: 3
To From State Rt P ActivePath LSPName
100.40.40.40 100.10.10.10 Up 0 * LS1-LS4
100.70.70.70 100.10.10.10 Up 0 * LS1-LS7
100.50.50.50 100.10.10.10 Up 0 * LS1-LS5
Total 3 displayed, Up 3, Down 0
...

```

**Checking the Forwarding Table**

**Purpose** Make sure that the routes are set up as expected by running the **show route forwarding-table** command. Only the routes to the remote customer networks are shown here.

**Action** user@R1:LS1> show route forwarding-table  
 Routing table: default.inet

```
Internet:
Destination Type RtRef Next hop Type Index NhRef Netif
...
10.0.104.8/30 user 0 3.3.3.2 ucst 1006 6 1t-2/0/10.9
10.0.134.8/30 user 0 6.6.6.2 ucst 1010 6 1t-2/0/10.8
10.0.224.8/30 user 0 2.2.2.2 ucst 1008 6 1t-2/0/10.1
...
```

## CHAPTER 8

# VPNs and VPLS

- [Example: Configuring VPNs and VPLS on Logical Systems on page 183](#)

### Example: Configuring VPNs and VPLS on Logical Systems

---

- [Layer 3 VPN Introduction on page 183](#)
- [Introduction to VPLS on page 183](#)
- [Example: Using Logical Systems to Configure Provider Edge and Provider Routers in a Layer 3 VPN and VPLS Scenario on page 184](#)

### Layer 3 VPN Introduction

In Junos OS, Layer 3 VPNs are based on RFC 4364. RFC 4364 defines a mechanism by which service providers can use their IP backbones to provide VPN services to their customers. A Layer 3 VPN is a set of sites that share common routing information and whose connectivity is controlled by a collection of policies. The sites that make up a Layer 3 VPN are connected over a provider's existing public Internet backbone.

RFC 4364 VPNs are also known as BGP/MPLS VPNs because BGP is used to distribute VPN routing information across the provider's backbone, and MPLS is used to forward VPN traffic across the backbone to remote VPN sites.

Customer networks, because they are private, can use either public addresses or private addresses, as defined in RFC 1918, *Address Allocation for Private Internets*. When customer networks that use private addresses connect to the public Internet infrastructure, the private addresses might overlap with the same private addresses used by other network users. MPLS/BGP VPNs solve this problem by adding a VPN identifier prefix to each address from a particular VPN site, thereby creating an address that is unique both within the VPN and within the public Internet. In addition, each VPN has its own VPN-specific routing table that contains the routing information for that VPN only.

### Introduction to VPLS

VPLS is an Ethernet-based point-to-multipoint Layer 2 VPN. It allows you to connect geographically dispersed Ethernet local area networks (LAN) sites to each other across an MPLS backbone. For customers who implement VPLS, all sites appear to be in the same Ethernet LAN even though traffic travels across the service provider's network.

VPLS, in its implementation and configuration, has much in common with a Layer 2 VPN. In VPLS, a packet originating within a service provider customer's network is sent first to a customer edge (CE) device (for example, a router or Ethernet switch). It is then sent to a provider edge (PE) router within the service provider's network. The packet traverses the service provider's network over a MPLS label-switched path (LSP). It arrives at the egress PE router, which then forwards the traffic to the CE device at the destination customer site.

The difference is that for VPLS, packets can traverse the service provider's network in point-to-multipoint fashion, meaning that a packet originating from a CE device can be broadcast to all the PE routers participating in a VPLS routing instance. In contrast, a Layer 2 VPN forwards packets in point-to-point fashion only.

The paths carrying VPLS traffic between each PE router participating in a routing instance are called pseudowires. The pseudowires are signaled using either BGP or LDP.

### Example: Using Logical Systems to Configure Provider Edge and Provider Routers in a Layer 3 VPN and VPLS Scenario

This example provides step-by-step procedures to configure provider edge (PE) and provider (P) routers in a VPN and VPLS scenario using logical systems.

- [Requirements on page 184](#)
- [Overview on page 184](#)
- [Configuration on page 186](#)
- [Verification on page 213](#)

#### Requirements

---

In this example, no special configuration beyond device initialization is required.

#### Overview

---

In this example, VPNs are used to separate customer traffic across a provider backbone.

#### Topology

[Figure 27 on page 185](#) shows four pairs of CE routers that are connected across an MPLS backbone:

- Routers CE1 and CE5 are part of the red VPN.
- Routers CE2 and CE6 are in the blue VPN.
- Routers CE3 and CE7 belong to a VPLS domain.
- Routers CE4 and CE8 are connected with standard protocols.

Two logical systems are configured on PE routers PE1 and PE2 and provider core Router P0. Each of these three routers has two logical systems: LS1 and LS2. To illustrate the concept of a logical system, both VPNs are part of Logical System LS1, the VPLS instance belongs to Logical System LS2, and the remaining routers use the main router portion of routers PE1, P0, and PE2.



Figure 27: Provider Edge and Provider Logical System Topology Diagram

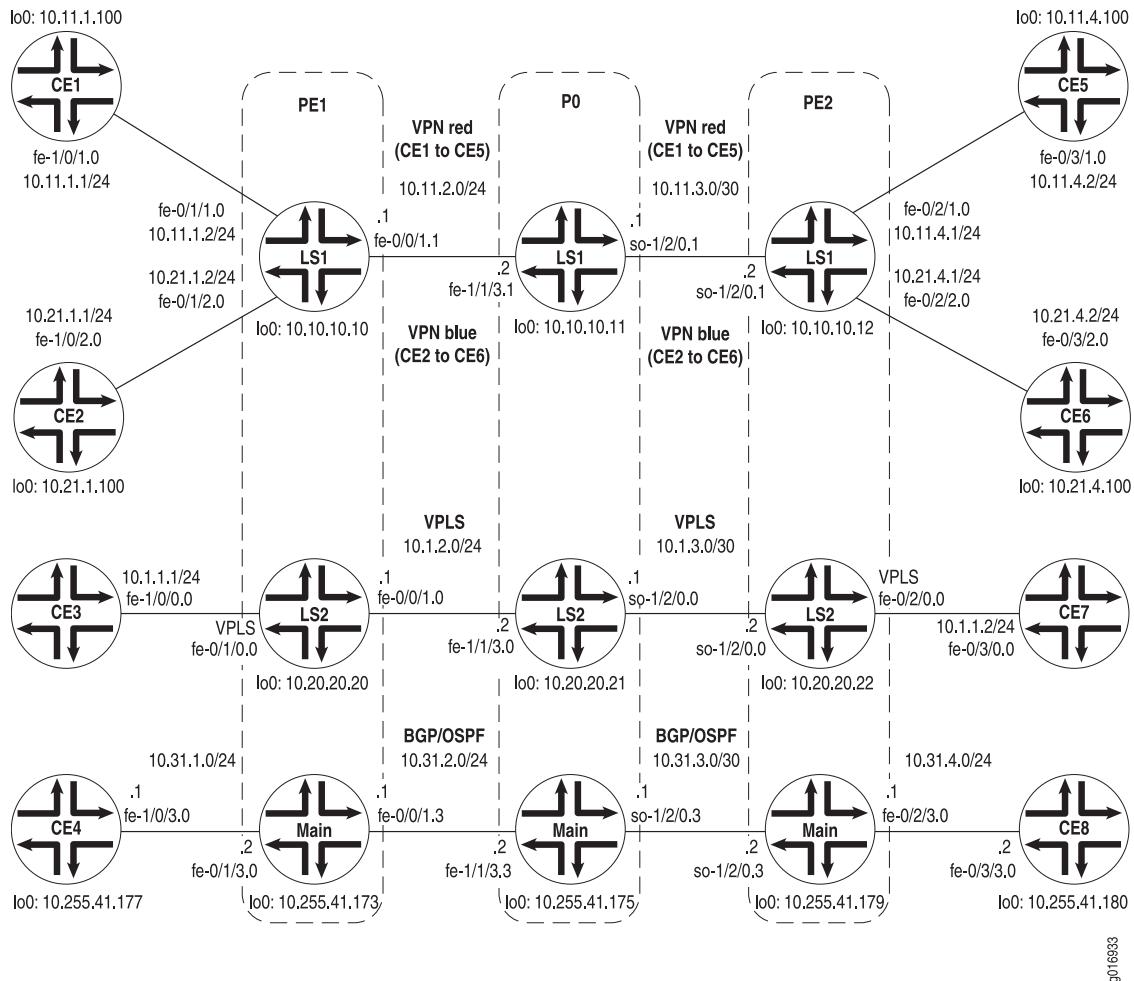

On Router PE1, two VPN routing and forwarding (VRF) routing instances are created in Logical System LS1. The routing instances are called red and blue. The example configures the customer edge (CE)-facing logical interfaces so that traffic from Router CE1 is placed in the red VPN, and traffic from Router CE2 is placed in the blue VPN. A logical interface at **fe-0/0/1.1** connects to Logical System LS1 on Router P0. A VPLS routing instance is in Logical System LS2. The logical interface is configured so that traffic from Router CE3 is sent into the VPLS domain. This logical interface connects to Logical System LS2 on Router P0. The example also contains an administrator for Logical System LS1. The logical system administrator is responsible for the maintenance of this logical system. Finally, the example shows how to configure a logical interface to interconnect Router CE4 with the main router portion of Router PE1.

Router PE2 has the two VRF routing instances in Logical System LS1: red and blue. The CE-facing logical interfaces enable traffic from Router CE5 to be placed in the red VPN, and traffic from Router CE6 in the blue VPN. One logical interface on **so-1/2/0.1** connects to Logical System LS1 on Router P0. The VPLS routing instance is configured in Logical System LS2. A logical interface enables traffic from Router CE7 to be sent into the VPLS domain and connects to Logical System LS2 on Router P0. The example shows how to

configure a logical interface to interconnect Router CE8 with the main router portion of Router P0. Finally, you can optionally create a logical system administrator that has configuration privileges for Logical System LS1 and viewing privileges for Logical System LS2.

On Router P0, the example shows how to configure Logical Systems LS1, LS2, and the main router. You must configure physical interface properties at the main router **[edit interfaces]** hierarchy level. Next, the example shows how to configure protocols (such as RSVP, MPLS, BGP, and IS-IS), routing options, and policy options for the logical systems. Last, the example shows how to configure the same administrator for Logical System LS1 that is configured on Router PE1. This system administrator for Logical System LS2 has permission to view the LS2 configuration, but not change the configuration for Logical System LS2.

Logical System LS1 transports traffic for the red VPN that exists between routers CE1 and CE5. Logical System LS1 also connects the blue VPN that exists between routers CE2 and CE6. Logical System LS2 transports VPLS traffic between routers CE3 and CE7. For the main router on Router P0, you can configure the router as usual. The main router transports traffic between routers CE4 and CE8. The example shows how to configure the interfaces and routing protocols (OSPF, BGP) to connect to the main router portion of routers PE1 and PE2.

## Configuration

To configure the PE and P routers in logical systems involves performing the following tasks:

- [Configuring Interfaces on the Customer Edge Devices on page 186](#)
- [Configuring Router PE1 on page 188](#)
- [Configuring Router PE2 on page 191](#)
- [Configuring Router P0 on page 193](#)
- [Results on page 195](#)

### *Configuring Interfaces on the Customer Edge Devices*

#### **Step-by-Step Procedure**

The following example requires you to navigate various levels in the configuration hierarchy. For information about navigating the CLI, see *Using the CLI Editor in Configuration Mode in the CLI User Guide*.

1. On Router CE1, configure OSPF to connect to the red VPN in Logical System LS1 on Router PE1.

```
user@CE1# set interfaces fe-1/0/1 vlan-tagging
user@CE1# set interfaces fe-1/0/1 unit 0 description "routing-instance red CE"
user@CE1# set interfaces fe-1/0/1 unit 0 vlan-id 101
user@CE1# set interfaces fe-1/0/1 unit 0 family inet address 10.11.1/24
user@CE1# set interfaces lo0 unit 0 family inet address 10.11.1.100/32
user@CE1# set protocols ospf area 0.0.0.0 interface fe-1/0/1.0
user@CE1# set protocols ospf area 0.0.0.0 interface lo0.0
```

2. On Router CE2, configure BGP to connect to the blue VPN in Logical System LS1 on Router PE1.

```

user@CE2# set interfaces fe-1/0/2 vlan-tagging
user@CE2# set interfaces fe-1/0/2 unit 0 description "routing-instance blue CE"
user@CE2# set interfaces fe-1/0/2 unit 0 vlan-id 102
user@CE2# set interfaces fe-1/0/2 unit 0 family inet address 10.21.1.1/24
user@CE2# set interfaces lo0 unit 0 family inet address 10.21.1.100/32
user@CE2# set policy-options policy-statement export_loopback from route-filter
10.21.1.100/32 exact
user@CE2# set policy-options policy-statement export_loopback then accept
user@CE2# set protocols bgp export export_loopback
user@CE2# set protocols bgp group to_PE type external
user@CE2# set protocols bgp group to_PE local-address 10.21.1.1
user@CE2# set protocols bgp group to_PE peer-as 100
user@CE2# set protocols bgp group to_PE neighbor 10.21.1.2
user@CE2# set routing-options autonomous-system 200

```

3. On Router CE3, configure the Fast Ethernet interface in VLAN 600 to connect with the VPLS routing instance in Logical System LS2 on Router PE1.

```

user@CE3# set interfaces fe-1/0/0 vlan-tagging
user@CE3# set interfaces fe-1/0/0 unit 0 description "vpls interface"
user@CE3# set interfaces fe-1/0/0 unit 0 vlan-id 600
user@CE3# set interfaces fe-1/0/0 unit 0 family inet address 10.1.1.1/24

```

4. On Router CE4, configure the Fast Ethernet interface to connect with the main router at Router PE1.

```

user@CE4# set interfaces fe-1/0/3 vlan-tagging
user@CE4# set interfaces fe-1/0/3 unit 0 description "main router interface"
user@CE4# set interfaces fe-1/0/3 unit 0 vlan-id 103
user@CE4# set interfaces fe-1/0/3 unit 0 family inet address 10.31.1.1/24
user@CE4# set interfaces lo0 unit 0 family inet address 10.255.41.177/32

```

5. On Router CE5, configure OSPF to connect to the red VPN in Logical System LS1 on Router PE2.

```

user@CE5# set interfaces fe-0/3/1 vlan-tagging
user@CE5# set interfaces fe-0/3/1 unit 0 description "routing-instance red CE"
user@CE5# set interfaces fe-0/3/1 unit 0 vlan-id 101
user@CE5# set interfaces fe-0/3/1 unit 0 family inet address 10.11.4.2/24
user@CE5# set interfaces lo0 unit 0 family inet address 10.11.4.100/32
user@CE5# set protocols ospf area 0.0.0.0 interface fe-0/3/1.0
user@CE5# set protocols ospf area 0.0.0.0 interface lo0.0
user@CE5# set system login class LS1admin logical-system LS1
user@CE5# set system login class LS1admin permissions all
user@CE5# set system login class LS1onlooker logical-system LS2
user@CE5# set system login class LS1onlooker permissions view
user@CE5# set system login user LS1admin class LS1admin

```

6. On Router CE6, configure BGP to connect to the blue VPN in Logical System LS1 on Router PE2.

```

user@CE6# set interfaces fe-0/3/2 vlan-tagging
user@CE6# set interfaces fe-0/3/2 unit 0 description "routing-instance blue CE"
user@CE6# set interfaces fe-0/3/2 unit 0 vlan-id 102
user@CE6# set interfaces fe-0/3/2 unit 0 family inet address 10.21.4.2/24
user@CE6# set interfaces lo0 unit 0 family inet address 10.21.4.100/32
user@CE6# set routing-options autonomous-system 300
user@CE6# set protocols bgp export export_loopback

```

```

user@CE6# set protocols bgp group to_PE type external
user@CE6# set protocols bgp group to_PE local-address 10.21.4.2
user@CE6# set protocols bgp group to_PE peer-as 100
user@CE6# set protocols bgp group to_PE neighbor 10.21.4.1
user@CE6# set policy-options policy-statement export_loopback from route-filter
10.21.4.100/32 exact
user@CE6# set policy-options policy-statement export_loopback then accept

```

7. On Router CE7, configure the Fast Ethernet interface in VLAN 600 to connect with the VPLS routing instance in Logical System LS2 on Router PE2.

```

user@CE7# set interfaces fe-0/3/0 vlan-tagging
user@CE7# set interfaces fe-0/3/0 unit 0 description "vpls interface"
user@CE7# set interfaces fe-0/3/0 unit 0 vlan-id 600
user@CE7# set interfaces fe-0/3/0 unit 0 family inet address 10.1.1.2/24

```

8. On Router CE8, configure the Fast Ethernet interface to connect with the main router at Router PE2.

```

user@CE8# set interfaces fe-0/3/3 vlan-tagging
user@CE8# set interfaces fe-0/3/3 unit 0 description "main router interface"
user@CE8# set interfaces fe-0/3/3 unit 0 vlan-id 103
user@CE8# set interfaces fe-0/3/3 unit 0 family inet address 10.31.4.2/24
user@CE8# set interfaces lo0 unit 0 family inet address 10.255.41.180/32

```

### Configuring Router PE1

#### Step-by-Step Procedure

1. Configure the main router on Router PE1.

```

user@PE1# set interfaces fe-0/0/1 vlan-tagging
user@PE1# set interfaces fe-0/0/1 unit 3 description "main router to P0"
user@PE1# set interfaces fe-0/0/1 unit 3 vlan-id 103
user@PE1# set interfaces fe-0/0/1 unit 3 family inet address 10.31.2.1/24
user@PE1# set interfaces fe-0/0/1 unit 3 family iso
user@PE1# set interfaces fe-0/0/1 unit 3 family mpls
user@PE1# set interfaces fe-0/1/0 vlan-tagging
user@PE1# set interfaces fe-0/1/0 encapsulation vlan-vpls
user@PE1# set interfaces fe-0/1/1 vlan-tagging
user@PE1# set interfaces fe-0/1/2 vlan-tagging
user@PE1# set interfaces fe-0/1/3 vlan-tagging
user@PE1# set interfaces fe-0/1/3 unit 0 description "main router to CE4"
user@PE1# set interfaces fe-0/1/3 unit 0 vlan-id 103
user@PE1# set interfaces fe-0/1/3 unit 0 family inet address 10.31.1.2/24
user@PE1# set interfaces lo0 unit 0 description "main router loopback"
user@PE1# set interfaces lo0 unit 0 family inet address 10.255.41.173/32
user@PE1# set protocols bgp group to_main_ls type internal
user@PE1# set protocols bgp group to_main_ls local-address 10.255.41.173
user@PE1# set protocols bgp group to_main_ls export export_address
user@PE1# set protocols bgp group to_main_ls neighbor 10.255.41.179
user@PE1# set protocols bgp group to_main_ls neighbor 10.255.41.175
user@PE1# set protocols ospf area 0.0.0.0 interface lo0.0
user@PE1# set protocols ospf area 0.0.0.0 interface fe-0/0/1.3
user@PE1# set routing-options static route 10.255.41.177/32 next-hop 10.31.1.1
user@PE1# set routing-options autonomous-system 500
user@PE1# set policy-options policy-statement export_address from route-filter
10.255.41.177/32 exact
user@PE1# set policy-options policy-statement export_address then accept

```

```

user@PE1# set system login class LS1-admin logical-system LS1
user@PE1# set system login class LS1-admin permissions all
user@PE1# set system login user LS1-admin class LS1-admin
user@PE1# set system login user LS1-admin authentication plain-text-password
New password:
Retype new password:

```

2. Configure Logical System LS1 on Router PE1.

```

user@PE1# set logical-systems LS1 interfaces fe-0/0/1 unit 1 description "LS1
interface"
user@PE1# set logical-systems LS1 interfaces fe-0/0/1 unit 1 vlan-id 101
user@PE1# set logical-systems LS1 interfaces fe-0/0/1 unit 1 family inet address
10.11.2.1/24
user@PE1# set logical-systems LS1 interfaces fe-0/0/1 unit 1 family iso
user@PE1# set logical-systems LS1 interfaces fe-0/0/1 unit 1 family mpls
user@PE1# set logical-systems LS1 interfaces fe-0/1/1 unit 0 description
"routing-instance red interface"
user@PE1# set logical-systems LS1 interfaces fe-0/1/1 unit 0 vlan-id 101
user@PE1# set logical-systems LS1 interfaces fe-0/1/1 unit 0 family inet address
10.11.1.2/24
user@PE1# set logical-systems LS1 interfaces fe-0/1/2 unit 0 description
"routing-instance blue interface"
user@PE1# set logical-systems LS1 interfaces fe-0/1/2 unit 0 vlan-id 102
user@PE1# set logical-systems LS1 interfaces fe-0/1/2 unit 0 family inet address
10.21.1.2/24
user@PE1# set logical-systems LS1 interfaces lo0 unit 1 description "LS1 loopback"
user@PE1# set logical-systems LS1 interfaces lo0 unit 1 family inet address
10.10.10.10/32
user@PE1# set logical-systems LS1 interfaces lo0 unit 1 family iso address
47.1111.1111.1111.00
user@PE1# set logical-systems LS1 protocols rsvp interface all
user@PE1# set logical-systems LS1 protocols mpls label-switched-path to_10.10.10.12
to 10.10.10.12
user@PE1# set logical-systems LS1 protocols mpls interface all
user@PE1# set logical-systems LS1 protocols bgp group to_other_PE type internal
user@PE1# set logical-systems LS1 protocols bgp group to_other_PE local-address
10.10.10.10
user@PE1# set logical-systems LS1 protocols bgp group to_other_PE family inet-vpn
any
user@PE1# set logical-systems LS1 protocols bgp group to_other_PE neighbor
10.10.10.12
user@PE1# set logical-systems LS1 protocols isis interface all
user@PE1# set logical-systems LS1 policy-options policy-statement
from_bgp_to_ospf then accept
user@PE1# set logical-systems LS1 routing-instances blue instance-type vrf
user@PE1# set logical-systems LS1 routing-instances blue interface fe-0/1/2.0
user@PE1# set logical-systems LS1 routing-instances blue route-distinguisher
10.10.10.10:200
user@PE1# set logical-systems LS1 routing-instances blue vrf-target target:20:20
user@PE1# set logical-systems LS1 routing-instances blue protocols bgp group
to_CE type external
user@PE1# set logical-systems LS1 routing-instances blue protocols bgp group
to_CE local-address 10.21.1.2
user@PE1# set logical-systems LS1 routing-instances blue protocols bgp group
to_CE peer-as 200

```

```

user@PE1# set logical-systems LS1 routing-instances blue protocols bgp group
to_CE neighbor 10.21.1.1
user@PE1# set logical-systems LS1 routing-instances red instance-type vrf
user@PE1# set logical-systems LS1 routing-instances red interface fe-0/1/1.0
user@PE1# set logical-systems LS1 routing-instances red route-distinguisher
10.10.10.10:100
user@PE1# set logical-systems LS1 routing-instances red vrf-target target:10:10
user@PE1# set logical-systems LS1 routing-instances red protocols ospf export
from_bgp_to_ospf
user@PE1# set logical-systems LS1 routing-instances red protocols ospf area 0.0.0.0
interface all
user@PE1# set logical-systems LS1 routing-options autonomous-system 100

```

### 3. Configure Logical System LS2 on Router PE1.

```

user@PE1# set logical-systems LS2 interfaces fe-0/0/1 unit 0 description
"core-facing LS2 interface"
user@PE1# set logical-systems LS2 interfaces fe-0/0/1 unit 0 vlan-id 100
user@PE1# set logical-systems LS2 interfaces fe-0/0/1 unit 0 family inet address
10.1.2.1/24
user@PE1# set logical-systems LS2 interfaces fe-0/0/1 unit 0 family iso
user@PE1# set logical-systems LS2 interfaces fe-0/0/1 unit 0 family mpls
user@PE1# set logical-systems LS2 interfaces fe-0/1/0 unit 0 description "vpls
interface to ce3"
user@PE1# set logical-systems LS2 interfaces fe-0/1/0 unit 0 encapsulation
vlan-vpls
user@PE1# set logical-systems LS2 interfaces fe-0/1/0 unit 0 vlan-id 600
user@PE1# set logical-systems LS2 interfaces fe-0/1/0 unit 0 family vpls
user@PE1# set logical-systems LS2 interfaces lo0 unit 2 description "LS2 loopback"
user@PE1# set logical-systems LS2 interfaces lo0 unit 2 family inet address
10.20.20.20/32
user@PE1# set logical-systems LS2 interfaces lo0 unit 2 family iso address
47.2222.2222.2222.00
user@PE1# set logical-systems LS2 protocols rsvp interface all
user@PE1# set logical-systems LS2 protocols mpls label-switched-path
to_10.20.20.22 to 10.20.20.22
user@PE1# set logical-systems LS2 protocols mpls interface all
user@PE1# set logical-systems LS2 protocols bgp group to_VPLS_PE type internal
user@PE1# set logical-systems LS2 protocols bgp group to_VPLS_PE local-address
10.20.20.20
user@PE1# set logical-systems LS2 protocols bgp group to_VPLS_PE family l2vpn
signaling
user@PE1# set logical-systems LS2 protocols bgp group to_VPLS_PE neighbor
10.20.20.22
user@PE1# set logical-systems LS2 protocols isis interface fe-0/0/1.0
user@PE1# set logical-systems LS2 protocols isis interface lo0.2
user@PE1# set logical-systems LS2 routing-instances new instance-type vpls
user@PE1# set logical-systems LS2 routing-instances new interface fe-0/1/0.0
user@PE1# set logical-systems LS2 routing-instances new route-distinguisher
10.20.20.20:100
user@PE1# set logical-systems LS2 routing-instances new vrf-target target:30:30
user@PE1# set logical-systems LS2 routing-instances new protocols vpls site-range
10
user@PE1# set logical-systems LS2 routing-instances new protocols vpls site newPE
site-identifier 1
user@PE1# set logical-systems LS2 routing-options autonomous-system 400

```

**Configuring Router PE2****Step-by-Step  
Procedure**

1. Configure the main router on Router PE2.

```

user@PE2# set interfaces fe-0/2/0 vlan-tagging
user@PE2# set interfaces fe-0/2/0 encapsulation vlan-vpls
user@PE2# set interfaces fe-0/2/1 vlan-tagging
user@PE2# set interfaces fe-0/2/2 vlan-tagging
user@PE2# set interfaces fe-0/2/3 vlan-tagging
user@PE2# set interfaces fe-0/2/3 unit 0 description "main router to CE8"
user@PE2# set interfaces fe-0/2/3 unit 0 vlan-id 103
user@PE2# set interfaces fe-0/2/3 unit 0 family inet address 10.31.4.1/24
user@PE2# set interfaces so-1/2/0 encapsulation frame-relay
user@PE2# set interfaces so-1/2/0 unit 3 description "main router to P0"
user@PE2# set interfaces so-1/2/0 unit 3 dlci 103
user@PE2# set interfaces so-1/2/0 unit 3 family inet address 10.31.3.2/24
user@PE2# set interfaces so-1/2/0 unit 3 family iso
user@PE2# set interfaces so-1/2/0 unit 3 family mpls
user@PE2# set interfaces lo0 unit 0 description "main router loopback"
user@PE2# set interfaces lo0 unit 0 family inet address 10.155.41.179/32
user@PE2# set protocols bgp group to_main_ls type internal
user@PE2# set protocols bgp group to_main_ls local-address 10.255.41.179
user@PE2# set protocols bgp group to_main_ls export export_address
user@PE2# set protocols bgp group to_main_ls neighbor 10.255.41.173
user@PE2# set protocols bgp group to_main_ls neighbor 10.255.41.175
user@PE2# set protocols ospf area 0.0.0.0 interface so-1/2/0.3
user@PE2# set protocols ospf area 0.0.0.0 interface fe-0/2/3.0
user@PE2# set protocols ospf area 0.0.0.0 interface lo0.0
user@PE2# set routing-options static route 10.255.41.180/32 next-hop 10.31.4.2
user@PE2# set routing-options autonomous-system 500
user@PE2# set policy-options policy-statement export_address from route-filter
 10.255.41.180/32 exact
user@PE2# set policy-options policy-statement export_address then accept
user@PE2# set system login class LS1-admin logical-system LS1
user@PE2# set system login class LS1-admin permissions all
user@PE2# set system login class LS1-onlooker logical-system LS2
user@PE2# set system login class LS1-onlooker permissions view
user@PE2# set system login user LS1-admin class LS1-admin

```

2. Configure Logical System LS1 on Router PE2.

```

user@PE2# set logical-systems LS1 interfaces fe-0/2/0 unit 1 description
 "routing-instance red interface connects to Router CE5"
user@PE2# set logical-systems LS1 interfaces fe-0/2/0 unit 1 vlan-id 101
user@PE2# set logical-systems LS1 interfaces fe-0/2/0 unit 1 family inet address
 10.11.4.1/24
user@PE2# set logical-systems LS1 interfaces fe-0/2/0 unit 2 description
 "routing-instance blue interface connects to Router CE6"
user@PE2# set logical-systems LS1 interfaces fe-0/2/0 unit 2 vlan-id 102
user@PE2# set logical-systems LS1 interfaces fe-0/2/0 unit 2 family inet address
 10.21.4.1/24
user@PE2# set logical-systems LS1 interfaces so-1/2/0 unit 1 description "core-facing
 LS1 interface"
user@PE2# set logical-systems LS1 interfaces so-1/2/0 unit 1 dlci 101
user@PE2# set logical-systems LS1 interfaces so-1/2/0 unit 1 family inet address
 10.11.3.2/24

```

```

user@PE2# set logical-systems LS1 interfaces so-1/2/0 unit 1 family iso
user@PE2# set logical-systems LS1 interfaces so-1/2/0 unit 1 family mpls
user@PE2# set logical-systems LS1 interfaces lo0 unit 1 description "LS1 loopback"
user@PE2# set logical-systems LS1 interfaces lo0 unit 1 family inet address
 10.10.10.12/32
user@PE2# set logical-systems LS1 interfaces lo0 unit 1 family iso address
 47.1111.1111.1111.1113.00
user@PE2# set logical-systems LS1 protocols rsvp interface all
user@PE2# set logical-systems LS1 protocols mpls label-switched-path
 to_10.10.10.10 to 10.10.10.10
user@PE2# set logical-systems LS1 protocols mpls interface all
user@PE2# set logical-systems LS1 protocols bgp group to_other_PE type internal
user@PE2# set logical-systems LS1 protocols bgp group to_other_PE local-address
 10.10.10.12
user@PE2# set logical-systems LS1 protocols bgp group to_other_PE family inet
 any
user@PE2# set logical-systems LS1 protocols bgp group to_other_PE family inet-vpn
 any
user@PE2# set logical-systems LS1 protocols bgp group to_other_PE neighbor
 10.10.10.10
user@PE2# set logical-systems LS1 protocols isis interface all
user@PE2# set logical-systems LS1 policy-options policy-statement
 from_bgp_to_ospf then accept
user@PE2# set logical-systems LS1 routing-instances blue instance-type vrf
user@PE2# set logical-systems LS1 routing-instances blue interface fe-0/2/2.0
user@PE2# set logical-systems LS1 routing-instances blue route-distinguisher
 10.10.10.12:200
user@PE2# set logical-systems LS1 routing-instances blue vrf-target target:20:20
user@PE2# set logical-systems LS1 routing-instances blue protocols bgp group
 to_CE local-address 10.21.4.1
user@PE2# set logical-systems LS1 routing-instances blue protocols bgp group
 to_CE peer-as 300
user@PE2# set logical-systems LS1 routing-instances blue protocols bgp group
 to_CE neighbor 10.21.4.2
user@PE2# set logical-systems LS1 routing-instances red instance-type vrf
user@PE2# set logical-systems LS1 routing-instances red interface fe-0/2/1.0
user@PE2# set logical-systems LS1 routing-instances red route-distinguisher
 10.10.10.12:100
user@PE2# set logical-systems LS1 routing-instances red vrf-target target:10:10
user@PE2# set logical-systems LS1 routing-instances red protocols ospf export
 from_bgp_to_ospf
user@PE2# set logical-systems LS1 routing-instances red protocols ospf area 0.0.0.0
 interface all
user@PE2# set logical-systems LS1 routing-options autonomous-system 100

```

3. Configure Logical System LS2 on Router PE2.

```

user@PE2# set logical-systems LS2 interfaces fe-0/2/0 unit 0 description "vpls
 interface connects to Router CE7"
user@PE2# set logical-systems LS2 interfaces fe-0/2/0 unit 0 encapsulation
 vlan-vpls
user@PE2# set logical-systems LS2 interfaces fe-0/2/0 unit 0 vlan-id 600
user@PE2# set logical-systems LS2 interfaces fe-0/2/0 unit 0 family vpls
user@PE2# set logical-systems LS2 interfaces so-1/2/0 unit 0 description
 "core-facing LS2 interface"
user@PE2# set logical-systems LS2 interfaces so-1/2/0 unit 0 dlci 100

```



```

user@PE2# set logical-systems LS2 interfaces so-1/2/0 unit 0 family inet address
10.1.3.2/24
user@PE2# set logical-systems LS2 interfaces so-1/2/0 unit 0 family iso
user@PE2# set logical-systems LS2 interfaces so-1/2/0 unit 0 family mpls
user@PE2# set logical-systems LS2 interfaces lo0 unit 2 description "LS2 loopback"
user@PE2# set logical-systems LS2 interfaces lo0 unit 2 family inet address
10.20.20.22/32
user@PE2# set logical-systems LS2 interfaces lo0 unit 2 family iso address
47.2222.2222.2222.2224.00
user@PE2# set logical-systems LS2 protocols rsvp interface all
user@PE2# set logical-systems LS2 protocols mpls label-switched-path
to_10.20.20.20 to 10.20.20.20
user@PE2# set logical-systems LS2 protocols mpls interface all
user@PE2# set logical-systems LS2 protocols bgp group to_VPLS_PE type internal
user@PE2# set logical-systems LS2 protocols bgp group to_VPLS_PE local-address
10.20.20.22
user@PE2# set logical-systems LS2 protocols bgp group to_VPLS_PE family l2vpn
signaling
user@PE2# set logical-systems LS2 protocols bgp group to_VPLS_PE neighbor
10.20.20.20
user@PE2# set logical-systems LS2 protocols isis interface so-1/2/0.0
user@PE2# set logical-systems LS2 protocols isis interface lo0.2
user@PE2# set logical-systems LS2 routing-instances new instance-type vpls
user@PE2# set logical-systems LS2 routing-instances new interface fe-0/2/0.0
user@PE2# set logical-systems LS2 routing-instances new route-distinguisher
10.20.20.22:100
user@PE2# set logical-systems LS2 routing-instances new vrf-target target:30:30
user@PE2# set logical-systems LS2 routing-instances new protocols vpls site-range
10
user@PE2# set logical-systems LS2 routing-instances new protocols vpls site newPE
site-identifier 2
user@PE2# set logical-systems LS2 routing-options autonomous-system 400

```

### Configuring Router P0

#### Step-by-Step Procedure

1. Configure the main router on Router P0.

```

user@P0# set interfaces fe-1/1/3 vlan-tagging
user@P0# set interfaces fe-1/1/3 unit 3 description "connects to the main router on
pe1"
user@P0# set interfaces fe-1/1/3 unit 3 vlan-id 103
user@P0# set interfaces fe-1/1/3 unit 3 family inet address 10.31.2.2/24
user@P0# set interfaces fe-1/1/3 unit 3 family iso
user@P0# set interfaces fe-1/1/3 unit 3 family mpls
user@P0# set interfaces so-1/2/0 dce
user@P0# set interfaces so-1/2/0 encapsulation frame-relay
user@P0# set interfaces so-1/2/0 unit 3 description "connects to the main router
on pe2"
user@P0# set interfaces so-1/2/0 unit 3 dlci 103
user@P0# set interfaces so-1/2/0 unit 3 family inet address 10.31.3.1/24
user@P0# set interfaces so-1/2/0 unit 3 family iso
user@P0# set interfaces so-1/2/0 unit 3 family mpls
user@P0# set interfaces lo0 unit 0 description "main router loopback"
user@P0# set interfaces lo0 unit 0 family inet address 10.255.41.175/32
user@P0# set routing-options autonomous-system 500
user@P0# set protocols bgp group to_main_ls type internal

```

```
user@P0# set protocols bgp group to_main_ls local-address 10.255.41.175
user@P0# set protocols bgp group to_main_ls neighbor 10.255.41.179
user@P0# set protocols bgp group to_main_ls neighbor 10.255.41.173
user@P0# set protocols ospf area 0.0.0.0 interface lo0.0
user@P0# set protocols ospf area 0.0.0.0 interface fe-1/1/3.3
user@P0# set protocols ospf area 0.0.0.0 interface so-1/2/0.3
user@P0# set system login class LS1-admin logical-system LS1
user@P0# set system login class LS1-admin permissions all
user@P0# set system login class LS1-onlooker logical-system LS2
user@P0# set system login class LS1-onlooker permissions view
user@P0# set system login user LS1-admin class LS1-admin
```

2. Configure Logical System LS1 on Router P0.

```
user@P0# set logical-systems LS1 interfaces fe-1/1/3 unit 1 description "LS1 interface
connects to LS1 on pe1"
user@P0# set logical-systems LS1 interfaces fe-1/1/3 unit 1 vlan-id 101
user@P0# set logical-systems LS1 interfaces fe-1/1/3 unit 1 family inet address
10.11.2.2/24
user@P0# set logical-systems LS1 interfaces fe-1/1/3 unit 1 family iso
user@P0# set logical-systems LS1 interfaces fe-1/1/3 unit 1 family mpls
user@P0# set logical-systems LS1 interfaces so-1/2/0 unit 1 description "LS1
interface connects to LS1 on pe2"
user@P0# set logical-systems LS1 interfaces so-1/2/0 unit 1 dlc1 101
user@P0# set logical-systems LS1 interfaces so-1/2/0 unit 1 family inet address
10.11.3.1/24
user@P0# set logical-systems LS1 interfaces so-1/2/0 unit 1 family iso
user@P0# set logical-systems LS1 interfaces so-1/2/0 unit 1 family mpls
user@P0# set logical-systems LS1 interfaces lo0 unit 1 description "LS1 loopback"
user@P0# set logical-systems LS1 interfaces lo0 unit 1 family inet address
10.10.10.11/32
user@P0# set logical-systems LS1 interfaces lo0 unit 1 family iso address
47.1111.1111.1111.1112.00
user@P0# set logical-systems LS1 protocols rsvp interface all
user@P0# set logical-systems LS1 protocols mpls interface all
user@P0# set logical-systems LS1 protocols isis interface all
```

3. Configure Logical System LS2 on Router P0.

```
user@P0# set logical-systems LS2 interfaces fe-1/1/3 unit 0 description "LS2
interface connects to LS2 on pe1"
user@P0# set logical-systems LS2 interfaces fe-1/1/3 unit 0 vlan-id 100
user@P0# set logical-systems LS2 interfaces fe-1/1/3 unit 0 family inet address
10.1.2.2/24
user@P0# set logical-systems LS2 interfaces fe-1/1/3 unit 0 family iso
user@P0# set logical-systems LS2 interfaces fe-1/1/3 unit 0 family mpls
user@P0# set logical-systems LS2 interfaces so-1/2/0 unit 0 description "LS2
interface connects to LS2 on pe2"
user@P0# set logical-systems LS2 interfaces so-1/2/0 unit 0 dlc1 100
user@P0# set logical-systems LS2 interfaces so-1/2/0 unit 0 family inet address
10.1.3.1/24
user@P0# set logical-systems LS2 interfaces so-1/2/0 unit 0 family iso
user@P0# set logical-systems LS2 interfaces so-1/2/0 unit 0 family mpls
user@P0# set logical-systems LS2 interfaces lo0 unit 2 description "LS2 loopback"
user@P0# set logical-systems LS2 interfaces lo0 unit 2 family inet address
10.20.20.21/32
```

```

user@P0# set logical-systems LS2 interfaces lo0 unit 2 family iso address
47.2222.2222.2222.2223.00
user@P0# set logical-systems LS2 protocols rsvp interface all
user@P0# set logical-systems LS2 protocols mpls interface all
user@P0# set logical-systems LS2 protocols isis interface fe-1/1/3.0
user@P0# set logical-systems LS2 protocols isis interface so-1/2/0.0
user@P0# set logical-systems LS2 protocols isis interface lo0.2

```

On Router CE1, configure OSPF to connect to the red VPN in Logical System LS1 on Router PE1:

```

Router CE1 [edit]
interfaces {
 fe-1/0/1 {
 vlan-tagging;
 unit 0 {
 description "routing-instance red CE";
 vlan-id 101;
 family inet {
 address 10.11.1.1/24;
 }
 }
 }
 lo0 {
 unit 0 {
 family inet {
 address 10.11.1.100/32;
 }
 }
 }
}
protocols {
 ospf {
 area 0.0.0.0 {
 interface fe-1/0/1.0;
 interface lo0.0;
 }
 }
}

```

On Router CE2, configure BGP to connect to the blue VPN in Logical System LS1 on Router PE1:

```

Router CE2 [edit]
interfaces {
 fe-1/0/2 {
 vlan-tagging;
 unit 0 {
 description "routing-instance blue CE";
 vlan-id 102;
 family inet {
 address 10.21.1.1/24;
 }
 }
 }
 lo0 {

```

```

 unit 0 {
 family inet {
 address 10.21.1.100/32;
 }
 }
 }
routing-options {
 autonomous-system 200;
}
protocols {
 bgp {
 export export_loopback;
 group to_PE {
 type external;
 local-address 10.21.1.1;
 peer-as 100;
 neighbor 10.21.1.2;
 }
 }
}
policy-options {
 policy-statement export_loopback {
 from {
 route-filter 10.21.1.100/32 exact;
 }
 then accept;
 }
}
}

```

On Router CE3, configure the Fast Ethernet interface in VLAN 600 to connect with the VPLS routing instance in Logical System LS2 on Router PE1:

```

Router CE3 [edit]
interfaces {
 fe-1/0/0 {
 vlan-tagging;
 unit 0 {
 description "vpls interface";
 vlan-id 600;
 family inet {
 address 10.1.1.1/24;
 }
 }
 }
}

```

On Router CE4, configure the Fast Ethernet interface to connect with the main router at Router PE1:

```

Router CE4 [edit]
interfaces {
 fe-1/0/3 {
 vlan-tagging;
 unit 0 {
 description "main router interface";

```

```

 vlan-id 103;
 family inet {
 address 10.31.1.1/24;
 }
}
}
lo0 {
 unit 0 {
 family inet {
 address 10.255.41.177/32;
 }
 }
}
}
}

```

On Router PE1, create two VPN routing and forwarding (VRF) routing instances in Logical System LS1: red and blue. Configure the CE-facing logical interfaces so that traffic from Router CE1 is placed in the red VPN, and traffic from Router CE2 is placed in the blue VPN. Next, create a logical interface at **fe-0/0/1.1** to connect to Logical System LS1 on Router P0.

Also on Router PE1, create a VPLS routing instance in Logical System LS2. Configure a logical interface so that traffic from Router CE3 is sent into the VPLS domain and connects to Logical System LS2 on Router P0.

Create an administrator for Logical System LS1. The logical system administrator can be responsible for the maintenance of this logical system.

Finally, configure a logical interface to interconnect Router CE4 with the main router portion of Router P0.

```

Router PE1 [edit]
logical-systems {
 LS1 { # The configuration for the first logical system begins here.
 interfaces {
 fe-0/0/1 {
 unit 1 { # This is the core-facing interface for Logical System LS1.
 description "LS1 interface";
 vlan-id 101;
 family inet {
 address 10.11.2.1/24;
 }
 family iso;
 family mpls;
 }
 }
 fe-0/1/1 {
 unit 0 { # This logical interface connects to Router CE1.
 description "routing-instance red interface";
 vlan-id 101;
 family inet {
 address 10.11.1.2/24;
 }
 }
 }
 }
 }
}

```

```
fe-0/1/2 {
 unit 0 { # This logical interface connects to Router CE2.
 description "routing-instance blue interface";
 vlan-id 102;
 family inet {
 address 10.21.1.2/24;
 }
 }
}
lo0 {
 unit 1 {
 description "LS1 loopback";
 family inet {
 address 10.10.10.10/32;
 }
 family iso {
 address 47.1111.1111.1111.00;
 }
 }
}
}
protocols { # You configure RSVP, MPLS, IS-IS, and BGP for Logical System LS1.
 rsvp {
 interface all;
 }
 mpls {
 label-switched-path to_10.10.10.12 {
 to 10.10.10.12;
 }
 interface all;
 }
 bgp {
 group to_other_PE {
 type internal;
 local-address 10.10.10.10;
 family inet-vpn {
 any;
 }
 neighbor 10.10.10.12;
 }
 }
 isis {
 interface all;
 }
}
policy-options {
 policy-statement from_bgp_to_ospf {
 then accept;
 }
}
}
routing-instances {
 blue {
 instance-type vrf; # You configure instance blue within Logical System LS1.
 interface fe-0/1/2.0;
 route-distinguisher 10.10.10.200;
 vrf-target target:20:20;
 }
}
```

```

protocols {
 bgp { #BGP connects the blue instance with Router CE2.
 group to_CE {
 type external;
 local-address 10.21.1.2;
 peer-as 200;
 neighbor 10.21.1.1;
 }
 }
}
red {
 instance-type vrf; # You configure instance red within Logical System LS1.
 interface fe-0/1/1.0;
 route-distinguisher 10.10.10.10:100;
 vrf-target target:10:10;
 protocols {
 ospf {#OSPF connects the red instance with Router CE1.
 export from_bgp_to_ospf;
 area 0.0.0.0 {
 interface all;
 }
 }
 }
}
routing-options {
 autonomous-system 100;
}
}
LS2 { # The configuration for the second logical system begins here.
 interfaces {
 fe-0/0/1 {
 unit 0 { # This is the core-facing interface for Logical System LS2.
 description "LS2 interface";
 vlan-id 100;
 family inet {
 address 10.1.2.1/24;
 }
 family iso;
 family mpls;
 }
 }
 fe-0/1/0 {
 unit 0 { # This logical interface connects to Router CE3.
 description "vpls interface";
 encapsulation vlan-vpls;
 vlan-id 600;
 family vpls;
 }
 }
 }
 lo0 {
 unit 2 {
 description "LS2 loopback";
 family inet {
 address 10.20.20.20/32;
 }
 }
 }
}

```





```

unit 3 { # This is the core-facing interface for the main router of PE1.
 description "main router to PO";
 vlan-id 103;
 family inet {
 address 10.31.2.1/24;
 }
 family iso;
 family mpls;
}
}
fe-0/1/3 {
 vlan-tagging;
 unit 0 { # This logical interface in the main router of PE1 connects to CE4.
 description "main router to CE4";
 vlan-id 103;
 family inet {
 address 10.31.1.2/24;
 }
 }
}
fe-0/1/0 { # You must always configure physical interface statements for
 vlan-tagging; # logical system interfaces at the [edit interfaces] hierarchy level.
 encapsulation vlan-vpls;
}
fe-0/1/1 {
 vlan-tagging;
}
fe-0/1/2 {
 vlan-tagging;
}
lo0 {
 unit 0 {
 description "main router loopback";
 family inet {
 address 10.255.41.173/32;
 }
 }
}
}
routing-options {
 static {
 route 10.255.41.177/32 next-hop 10.31.1.1;
 }
 autonomous-system 500;
}
protocols {
 bgp { # The main router uses BGP as the exterior gateway protocol.
 group to_main_ls {
 type internal;
 local-address 10.255.41.173;
 export export_address;
 neighbor 10.255.41.179;
 neighbor 10.255.41.175;
 }
 }
 ospf { # The main router uses OSPF as the interior gateway protocol.

```

```

 area 0.0.0.0 {
 interface lo0.0;
 interface fe-0/0/1.3;
 }
 }
}
policy-options {
 policy-statement export_address {
 from {
 route-filter 10.255.41.177/32 exact;
 }
 then accept;
 }
}
system {
 login {
 class LS1-admin {
 permissions all;
 logical-system LS1;
 }
 user LS1-admin {
 class LS1-admin;
 authentication plain-text password;
 New password: password
 Retype new password: password
 }
 }
}
}

```

On Router P0, configure Logical Systems LS1, LS2, and the main router. For the logical system, you must configure physical interface properties at the main router **[edit interfaces]** hierarchy level and assign the logical interfaces to the logical systems. Next, you must configure protocols (such as RSVP, MPLS, BGP, and IS-IS), routing options, and policy options for the logical systems. Last, configure the same administrator for Logical System LS1 that you configured on Router PE1. Configure this same administrator for Logical System LS2 to have permission to view the LS2 configuration, but not change the configuration for LS2.

In this example, Logical System LS1 transports traffic for the red VPN that exists between routers CE1 and CE5. Logical System LS1 also connects the blue VPN that exists between routers CE2 and CE6. Logical System LS2 transports VPLS traffic between routers CE3 and CE7.

For the main router on Router P0, you can configure the router as usual. In this example, the main router transports traffic between routers CE4 and CE8. As a result, configure the interfaces and routing protocols (OSPF, BGP) to connect to the main router portion of routers PE1 and PE2.

```

Router P0 [edit]
logical-systems {
 LS1 { # The configuration for the first logical system begins here.
 interfaces {
 fe-1/1/3 {
 unit 1 { # This logical interface connects to LS1 on Router PE1.

```

```

 description "LS1 interface";
 vlan-id 101;
 family inet {
 address 10.11.2.2/24;
 }
 family iso;
 family mpls;
 }
}
so-1/2/0 {
 unit 1 { # This logical interface connects to LS1 on Router PE2.
 description "LS1 interface";
 dlc1 101;
 family inet {
 address 10.11.3.1/24;
 }
 family iso;
 family mpls;
 }
}
lo0 {
 unit 1 {
 description "LS1 loopback";
 family inet {
 address 10.10.10.11/32;
 }
 family iso {
 address 47.1111.1111.1111.1112.00;
 }
 }
}
}
protocols { # You configure RSVP, MPLS, and IS-IS for Logical System LS1.
 rsvp {
 interface all;
 }
 mpls {
 interface all;
 }
 isis {
 interface all;
 }
}
}
LS2 { # The configuration for the second logical system begins here.
 interfaces {
 fe-1/1/3 {
 unit 0 { # This logical interface connects to LS2 on Router PE1.
 description "LS2 interface";
 vlan-id 100;
 family inet {
 address 10.1.2.2/24;
 }
 family iso;
 family mpls;
 }
 }
 }
}

```

```
}
so-1/2/0 {
 unit 0 { # This logical interface connects to LS2 on Router PE2.
 description "LS2 interface";
 dlcid 100;
 family inet {
 address 10.1.3.1/24;
 }
 family iso;
 family mpls;
 }
}
lo0 {
 unit 2 {
 description "LS2 loopback";
 family inet {
 address 10.20.20.21/32;
 }
 family iso {
 address 47.2222.2222.2222.00;
 }
 }
}
}
}
protocols { # You configure RSVP, MPLS, and IS-IS for Logical System LS2.
 rsvp {
 interface all;
 }
 mpls {
 interface all;
 }
 isis {
 interface fe-1/1/3.0;
 interface so-1/2/0.0;
 interface lo0.2;
 }
}
}
}
interfaces {
 fe-1/1/3 {
 vlan-tagging;
 unit 3 { # This logical interface connects to the main router on Router PE1.
 description "main router interface";
 vlan-id 103;
 family inet {
 address 10.31.2.2/24;
 }
 family iso;
 family mpls;
 }
 }
}
}
so-1/2/0 {
 dce; # You must configure all physical interface statements for logical
 encapsulation frame-relay; # routers at the [edit interfaces] hierarchy level.
 unit 3 { # This logical interface connects to the main router on Router PE2.
```

```

 description "main router interface";
 dlc1 103;
 family inet {
 address 10.31.3.1/24;
 }
 family iso;
 family mpls;
 }
}
lo0 {
 unit 0 {
 description "main router loopback";
 family inet {
 address 10.255.41.175/32;
 }
 }
}
}
routing-options {
 autonomous-system 500;
}
protocols { # You configure BGP and OSPF for the main router.
 bgp {
 group to_main_ls {
 type internal;
 local-address 10.255.41.175
 neighbor 10.255.41.179;
 neighbor 10.255.41.173;
 }
 }
 ospf {
 area 0.0.0.0 {
 interface lo0.0;
 interface fe-1/1/3.3;
 interface so-1/2/0.3;
 }
 }
}
system {
 login {
 class LS1-admin {
 permissions all;
 logical-system LS1;
 }
 class LS1-onlooker {
 permissions view;
 logical-system LS2;
 }
 user LS1-admin {
 class LS1-admin;
 }
 }
}
}

```

On Router PE2, create two VRF routing instances in Logical System LS1: red and blue. Configure the CE-facing logical interfaces so that traffic from Router CE5 is placed in the

red VPN and traffic from Router CE6 is placed in the blue VPN. Next, create one logical interface on `so-1/2/0.1` to connect to Logical System LS1 on Router P0.

Also on Router PE2, create a VPLS routing instance in Logical System LS2. Configure a logical interface so that traffic from Router CE7 is sent into the VPLS domain and connects to Logical System LS2 on Router P0.

Configure a logical interface to interconnect Router CE8 with the main router portion of Router P0.

Finally, you can optionally create a logical system administrator that has configuration privileges for Logical System LS1 and viewing privileges for Logical System LS2.

```
Router PE2 [edit]
logical-systems {
 LS1 { # The configuration for the first logical system begins here.
 interfaces {
 fe-0/2/0 {
 unit 1 { # This logical interface connects to Router CE5.
 description "routing-instance red interface";
 vlan-id 101;
 family inet {
 address 10.11.4.1/24;
 }
 }
 unit 2 { # This logical interface connects to Router CE6.
 description "routing-instance blue interface";
 vlan-id 102;
 family inet {
 address 10.21.4.1/24;
 }
 }
 }
 }
 so-1/2/0 {
 unit 1 { # This is the core-facing interface for Logical System LS1.
 description "LS1 interface";
 dlc1 101;
 family inet {
 address 10.11.3.2/24;
 }
 family iso;
 family mpls;
 }
 }
 lo0 {
 unit 1 {
 description "LS1 loopback";
 family inet {
 address 10.10.10.12/32;
 }
 family iso {
 address 47.1111.1111.1111.1113.00;
 }
 }
 }
 }
}
```

```

}
protocols {
 rsvp {# You configure RSVP, MPLS, IS-IS, and BGP for Logical System LS1.
 interface all;
 }
 mpls {
 label-switched-path to_10.10.10.10 {
 to 10.10.10.10;
 }
 interface all;
 }
 bgp {
 group to_other_PE {
 type internal;
 local-address 10.10.10.12;
 family inet {
 any;
 }
 family inet-vpn {
 any;
 }
 neighbor 10.10.10.10;
 }
 }
 isis {
 interface all;
 }
}
policy-options {
 policy-statement from_bgp_to_ospf {
 then accept;
 }
}
routing-instances {
 blue {
 instance-type vrf; # You configure instance blue within Logical System LS1.
 interface fe-0/2/2.0;
 route-distinguisher 10.10.10.12:200;
 vrf-target target:20:20;
 protocols {
 bgp { # BGP connects the blue instance with Router CE6.
 group to_CE {
 local-address 10.21.4.1;
 peer-as 300;
 neighbor 10.21.4.2;
 }
 }
 }
 }
 red {
 instance-type vrf; # You configure instance red within Logical System LS1.
 interface fe-0/2/1.0;
 route-distinguisher 10.10.10.12:100;
 vrf-target target:10:10;
 protocols {
 ospf { # OSPF connects the red instance with Router CE5.

```





```

bgp {
 group to_VPLS_PE {
 type internal;
 local-address 10.20.20.22;
 family l2vpn {
 signaling;
 }
 neighbor 10.20.20.20;
 }
}
isis {
 interface so-1/2/0.0;
 interface lo0.2;
}
}
routing-instances {
 new {
 instance-type vpls; # You configure VPLS within Logical System LS2.
 interface fe-0/2/0.0;
 route-distinguisher 10.20.20.22:100;
 vrf-target target:30:30;
 protocols {
 vpls {
 site-range 10;
 site newPE {
 site-identifier 2;
 }
 }
 }
 }
}
routing-options {
 autonomous-system 400;
}
}
interfaces {
 fe-0/2/0 { # You must always configure physical interface statements for the
 vlan-tagging; # logical system interfaces at the [edit interfaces] hierarchy level.
 encapsulation vlan-vpls;
 }
 fe-0/2/1 {
 vlan-tagging;
 }
 fe-0/2/2 {
 vlan-tagging;
 }
 fe-0/2/3 {
 vlan-tagging;
 unit 0 { # This logical interface in the main router of PE2 connects to CE8.
 description "main router to CE8";
 vlan-id 103;
 family inet {
 address 10.31.4.1/24;
 }
 }
 }
}
}

```

```
so-1/2/0 {
 encapsulation frame-relay;
 unit 3 { # This is the core-facing interface for the main router of PE2.
 description "main router to PO";
 dlc1 103;
 family inet {
 address 10.31.3.2/24;
 }
 family iso;
 family mpls;
 }
}
lo0 {
 unit 0 {
 description "main router loopback";
 family inet {
 address 10.155.41.179/32;
 }
 }
}
}
routing-options {
 static {
 route 10.255.41.180/32 next-hop 10.31.4.2;
 }
 autonomous-system 500;
}
protocols {
 bgp {# The main router uses BGP as the exterior gateway protocol.
 group to_main_ls {
 type internal;
 local-address 10.255.41.179;
 export export_address;
 neighbor 10.255.41.173;
 neighbor 10.255.41.175;
 }
 }
 ospf {# The main router uses OSPF as the interior gateway protocol.
 area 0.0.0.0 {
 interface so-1/2/0.3;
 interface fe-0/2/3.0;
 interface lo0.0;
 }
 }
}
policy-options {
 policy-statement export_address {
 from {
 route-filter 10.255.41.180/32 exact;
 }
 then accept;
 }
}
}
system {
 login {
```

```

class LS1-admin {
 permissions all;
 logical-system LS1;
}
class LS1-onlooker {
 permissions view;
 logical-system LS2;
}
user LS1-admin {
 class LS1-admin;
}
}
}

```

On Router CE5, configure OSPF to connect to the red VPN in Logical System LS1 on Router PE2:

```

Router CE5 [edit]
interfaces {
 fe-0/3/1 {
 vlan-tagging;
 unit 0 {
 description "routing-instance red CE";
 vlan-id 101;
 family inet {
 address 10.11.4.2/24;
 }
 }
 }
 lo0 {
 unit 0 {
 family inet {
 address 10.11.4.100/32;
 }
 }
 }
}
protocols {
 ospf {
 area 0.0.0.0 {
 interface fe-0/3/1.0;
 interface lo0.0;
 }
 }
}
system {
 login {
 class LS1-admin {
 permissions all;
 logical-system LS1;
 }
 class LS1-onlooker {
 permissions view;
 logical-system LS2;
 }
 user LS1-admin {

```

```

 class LS1-admin;
 }
}

```

On Router CE6, configure BGP to connect to the blue VPN in Logical System LS1 on Router PE2:

```

Router CE6 [edit]
interfaces {
 fe-0/3/2 {
 vlan-tagging;
 unit 0 {
 description "routing-instance blue CE";
 vlan-id 102;
 family inet {
 address 10.21.4.2/24;
 }
 }
 }
 lo0 {
 unit 0 {
 family inet {
 address 10.21.4.100/32;
 }
 }
 }
}
routing-options {
 autonomous-system 300;
}
protocols {
 bgp {
 export export_loopback;
 group to_PE {
 type external;
 local-address 10.21.4.2;
 peer-as 100;
 neighbor 10.21.4.1;
 }
 }
}
policy-options {
 policy-statement export_loopback {
 from {
 route-filter 10.21.4.100/32 exact;
 }
 then accept;
 }
}

```

On Router CE7, configure the Fast Ethernet interface in VLAN 600 to connect with the VPLS routing instance in Logical System LS2 on Router PE2:

```

Router CE7 [edit]
interfaces {

```

```

fe-0/3/0 {
 vlan-tagging;
 unit 0 {
 description "vpls interface";
 vlan-id 600;
 family inet {
 address 10.1.1.2/24;
 }
 }
}

```

On Router CE8, configure the Fast Ethernet interface to connect with the main router at Router PE2:

```

Router CE8 [edit]
interfaces {
 fe-0/3/3 {
 vlan-tagging;
 unit 0 {
 description "main router interface";
 vlan-id 103;
 family inet {
 address 10.31.4.2/24;
 }
 }
 }
}
lo0 {
 unit 0 {
 family inet {
 address 10.255.41.180/32;
 }
 }
}

```

### Verification

Confirm that the configuration is working properly by running these commands:

- `show bgp summary (logical-system logical-system-name)`
- `show isis adjacency (logical-system logical-system-name)`
- `show mpls lsp (logical-system logical-system-name)`
- `show (ospf | ospf3) neighbor (logical-system logical-system-name)`
- `show route (logical-system logical-system-name)`
- `show route protocol (logical-system logical-system-name)`
- `show rsvp session (logical-system logical-system-name)`

The following sections show the output of commands used with the configuration example:

- [Router CE1 Status on page 214](#)
- [Router CE2 Status on page 214](#)
- [Router CE3 Status on page 215](#)
- [Router PE1 Status: Main Router on page 215](#)
- [Router PE1 Status: Logical System LS1 on page 216](#)
- [Router PE1 Status: Logical System LS2 on page 217](#)
- [Router P0 Status: Main Router on page 218](#)
- [Router P0 Status: Main Router on page 218](#)
- [Router P0 Status: Logical System LS1 on page 218](#)
- [Router P0 Status: Logical System LS2 on page 219](#)
- [Router PE2 Status: Main Router on page 219](#)
- [Router PE2 Status: Logical System LS1 on page 220](#)
- [Router PE2 Status: Logical System LS2 on page 222](#)
- [Router CE5 Status on page 223](#)
- [Router CE6 Status on page 223](#)
- [Router CE7 Status on page 224](#)
- [Logical System Administrator Verification Output on page 224](#)

### ***Router CE1 Status***

**Purpose** Verify connectivity.

**Action** user@CE1> **show route table**  
 inet.0: 6 destinations, 6 routes (6 active, 0 holddown, 0 hidden)  
 + = Active Route, - = Last Active, \* = Both

```

10.11.1.0/24 * [Direct/0] 00:20:20
 > via fe-1/0/1.0
10.11.1.1/32 * [Local/0] 00:20:24
 Local via fe-1/0/1.0
10.11.1.100/32 * [Direct/0] 00:21:53
 > via lo0.0
10.11.4.0/24 * [OSPF/150] 00:18:30, metric 0, tag 3489661028
 > to 10.11.1.2 via fe-1/0/1.0
10.11.4.100/32 * [OSPF/10] 00:18:30, metric 2
 > to 10.11.1.2 via fe-1/0/1.0
224.0.0.5/32 * [OSPF/10] 00:21:58, metric 1
 MultiRecv

```

### ***Router CE2 Status***

**Purpose** Verify connectivity.

**Action** user@CE2> **show route table**  
 inet.0: 5 destinations, 5 routes (5 active, 0 holddown, 0 hidden)  
 + = Active Route, - = Last Active, \* = Both

```

10.21.1.0/24 *[Direct/0] 00:20:30
 > via fe-1/0/2.0
10.21.1.1/32 *[Local/0] 00:20:34
 Local via fe-1/0/2.0
10.21.1.100/32 *[Direct/0] 00:22:03
 > via lo0.0
10.21.4.0/24 *[BGP/170] 00:18:43, localpref 100
 AS path: 100 I
 > to 10.21.1.2 via fe-1/0/2.0
10.21.4.100/32 *[BGP/170] 00:18:43, localpref 100
 AS path: 100 300 I
 > to 10.21.1.2 via fe-1/0/2.0

```

### Router CE3 Status

**Purpose** Verify connectivity.

**Action** user@CE3> **show route table**  
inet.0: 2 destinations, 2 routes (2 active, 0 holddown, 0 hidden)  
+ = Active Route, - = Last Active, \* = Both

```

10.1.1.0/24 *[Direct/0] 00:20:13
 > via fe-1/0/0.0
10.1.1.1/32 *[Local/0] 00:20:17
 Local via fe-1/0/0.0

```

### Router PE1 Status: Main Router

**Purpose** Verify BGP operation.

**Action** user@PE1> **show bgp summary**

```

Groups: 1 Peers: 2 Down peers: 0
Table Tot Paths Act Paths Suppressed History Damp State Pending
inet.0 1 0 0 0 0 0
Peer AS InPkt OutPkt OutQ Flaps Last
Up/DwnState|#Active/Received/Damped...
10.255.41.175 500 5 8 0 0 2:31 0/0/0
 0/0/0
10.255.41.179 500 6 9 0 0 2:35 0/1/0
 0/0/0

```

user@PE1> **show route protocol bgp**  
inet.0: 20 destinations, 21 routes (20 active, 0 holddown, 0 hidden)  
+ = Active Route, - = Last Active, \* = Both  
10.255.41.180/32 [BGP/170] 00:02:48, localpref 100, from 10.255.41.179  
AS path: I  
> to 10.31.2.2 via fe-0/0/1.3  
iso.0: 1 destinations, 1 routes (1 active, 0 holddown, 0 hidden)  
inet6.0: 2 destinations, 2 routes (2 active, 0 holddown, 0 hidden)

user@PE1> **show ospf neighbor**

| Address   | Interface  | State | ID            | Pri | Dead |
|-----------|------------|-------|---------------|-----|------|
| 10.31.2.2 | fe-0/0/1.3 | Full  | 10.255.41.175 | 128 | 32   |

```
user@PE1> show isis adjacency
IS-IS instance is not running
```

### Router PE1 Status: Logical System LS1

**Purpose** Verify BGP operation.

**Action** user@PE1> show bgp summary logical-system LS1

```
Groups: 2 Peers: 2 Down peers: 0
Table Tot Paths Act Paths Suppressed History Damp State Pending
bgp.l3vpn.0 4 4 0 0 0
bgp.l3vpn.2 0 0 0 0 0
Peer AS InPkt OutPkt OutQ Flaps Last
Up/DwnState|#Active/Received/Damped...
10.10.10.12 100 13 14 0 0 2:50 Establ
 bgp.l3vpn.0: 4/4/0
 bgp.l3vpn.2: 0/0/0
 blue.inet.0: 2/2/0
 red.inet.0: 2/2/0
10.21.1.1 200 13 14 0 0 4:33 Establ
 blue.inet.0: 1/1/0
```

**Red VPN** The master administrator or logical system administrator can issue the following command to view the output for a specific logical system.

```
user@PE1> show route logical-system LS1 table red
red.inet.0: 6 destinations, 6 routes (6 active, 0 holddown, 0 hidden)
+ = Active Route, - = Last Active, * = Both

10.11.1.0/24 * [Direct/0] 00:04:51
> via fe-0/1/1.0
10.11.1.2/32 * [Local/0] 00:05:45
Local via fe-0/1/1.0
10.11.1.100/32 * [OSPF/10] 00:04:02, metric 1
> to 10.11.1.1 via fe-0/1/1.0
10.11.4.0/24 * [BGP/170] 00:03:05, localpref 100, from 10.10.10.12
AS path: I
> to 10.11.2.2 via fe-0/0/1.1, label-switched-path
to_10.10.10.12
10.11.4.100/32 * [BGP/170] 00:03:05, MED 1, localpref 100, from 10.10.10.12
AS path: I
> to 10.11.2.2 via fe-0/0/1.1, label-switched-path
to_10.10.10.12
224.0.0.5/32 * [OSPF/10] 00:07:02, metric 1
MultiRecv
```

**Blue VPN** The master administrator or logical system administrator can issue the following command to view the output for a specific logical system.

```
user@PE1> show route logical-system LS1 table blue
blue.inet.0: 5 destinations, 5 routes (5 active, 0 holddown, 0 hidden)
+ = Active Route, - = Last Active, * = Both

10.21.1.0/24 * [Direct/0] 00:05:29
> via fe-0/1/2.0
10.21.1.2/32 * [Local/0] 00:06:23
Local via fe-0/1/2.0
10.21.1.100/32 * [BGP/170] 00:05:26, localpref 100
AS path: 200 I
```



```

> to 10.21.1.1 via fe-0/1/2.0
10.21.4.0/24 * [BGP/170] 00:03:43, localpref 100, from 10.10.10.12
AS path: I
> to 10.11.2.2 via fe-0/0/1.1, label-switched-path
to_10.10.10.12
10.21.4.100/32 * [BGP/170] 00:03:43, localpref 100, from 10.10.10.12
AS path: 300 I
> to 10.11.2.2 via fe-0/0/1.1, label-switched-path
to_10.10.10.12

```

```
user@PE1> show route logical-system LS1 table inet.0
```

```
inet.0: 6 destinations, 6 routes (6 active, 0 holddown, 0 hidden)
+ = Active Route, - = Last Active, * = Both
```

```

10.10.10.10/32 * [Direct/0] 00:08:05
> via lo0.1
10.10.10.11/32 * [IS-IS/15] 00:05:07, metric 10
> to 10.11.2.2 via fe-0/0/1.1
10.10.10.12/32 * [IS-IS/15] 00:04:58, metric 20
> to 10.11.2.2 via fe-0/0/1.1
10.11.2.0/24 * [Direct/0] 00:05:38
> via fe-0/0/1.1
10.11.2.1/32 * [Local/0] 00:06:51
Local via fe-0/0/1.1
10.11.3.0/24 * [IS-IS/15] 00:05:07, metric 20
> to 10.11.2.2 via fe-0/0/1.1

```

```
user@PE1> ping logical-system LS1 routing-instance red 10.11.4.100
```

```

PING 10.11.4.100 (10.11.4.100): 56 data bytes
64 bytes from 10.11.4.100: icmp_seq=0 ttl=251 time=1.055 ms
^C
--- 10.11.4.100 ping statistics ---
1 packets transmitted, 1 packets received, 0% packet loss
round-trip min/avg/max/stddev = 1.055/1.055/1.055/0.000 ms

```

### Router PE1 Status: Logical System LS2

**Purpose** Verify VPLS operation.

**Action** user@PE1> show vpls connections logical-system LS2

```
Layer-2 VPN Connections:
```

```
Legend for connection status (St)
```

```

OR -- out of range WE -- intf encaps != instance encaps
EI -- encapsulation invalid Dn -- down
EM -- encapsulation mismatch VC-Dn -- Virtual circuit down
CM -- control-word mismatch -> -- only outbound conn is up
CN -- circuit not provisioned <- -- only inbound conn is up
OL -- no outgoing label Up -- operational
NC -- intf encaps not CCC/TCC XX -- unknown
NP -- intf h/w not present

```

```
Legend for interface status
```

```

Up -- operational
Dn -- down

```

```
Instance: new
```

```
Local site: newPE (1)
```

| connection-site | Type | St | Time last up         | # Up trans |
|-----------------|------|----|----------------------|------------|
| 2               | rmt  | Up | Jul 16 14:05:25 2003 | 1          |

Local interface: vt-1/2/0.49152, Status: Up, Encapsulation: VPLS  
 Remote PE: 10.20.20.22, Negotiated control-word: No  
 Incoming label: 800001, Outgoing label: 800000

**Router P0 Status: Main Router**

**Purpose** Verify connectivity.

**Action** user@P0> show interfaces terse lo0

| Interface | Admin | Link | Proto | Local                                              | Remote             |
|-----------|-------|------|-------|----------------------------------------------------|--------------------|
| lo0       | up    | up   |       |                                                    |                    |
| lo0.0     | up    | up   | inet  | 10.255.41.175<br>127.0.0.1                         | --> 0/0<br>--> 0/0 |
|           |       |      | iso   | 47.0005.80ff.f800.0000.0108.0003.0102.5501.4175.00 |                    |
|           |       |      | inet6 | fe80::2a0:a5ff:fe12:2b09<br>feee::10:255:14:175    |                    |
| lo0.1     | up    | up   | inet  | 10.10.10.11                                        | --> 0/0            |
|           |       |      | iso   | 47.1111.1111.1111.1112.00                          |                    |
| lo0.2     | up    | up   | inet  | 10.20.20.21                                        | --> 0/0            |
|           |       |      | iso   | 47.2222.2222.2222.2223.00                          |                    |
| lo0.16383 | up    | up   | inet  |                                                    |                    |

user@P0> show ospf neighbor

| Address   | Interface  | State | ID            | Pri | Dead |
|-----------|------------|-------|---------------|-----|------|
| 10.31.2.1 | fe-1/1/3.3 | Full  | 10.255.41.173 | 128 | 34   |
| 10.31.3.2 | so-1/2/0.3 | Full  | 10.255.41.179 | 128 | 37   |

**Router P0 Status: Main Router**

**Purpose** Verify routing protocols operation.

**Action** user@P0> show interfaces terse lo0

| Interface | Admin | Link | Proto | Local                                              | Remote             |
|-----------|-------|------|-------|----------------------------------------------------|--------------------|
| lo0       | up    | up   |       |                                                    |                    |
| lo0.0     | up    | up   | inet  | 10.255.41.175<br>127.0.0.1                         | --> 0/0<br>--> 0/0 |
|           |       |      | iso   | 47.0005.80ff.f800.0000.0108.0003.0102.5501.4175.00 |                    |
|           |       |      | inet6 | fe80::2a0:a5ff:fe12:2b09<br>feee::10:255:14:175    |                    |
| lo0.1     | up    | up   | inet  | 10.10.10.11                                        | --> 0/0            |
|           |       |      | iso   | 47.1111.1111.1111.1112.00                          |                    |
| lo0.2     | up    | up   | inet  | 10.20.20.21                                        | --> 0/0            |
|           |       |      | iso   | 47.2222.2222.2222.2223.00                          |                    |
| lo0.16383 | up    | up   | inet  |                                                    |                    |

user@P0> show ospf neighbor

| Address   | Interface  | State | ID            | Pri | Dead |
|-----------|------------|-------|---------------|-----|------|
| 10.31.2.1 | fe-1/1/3.3 | Full  | 10.255.41.173 | 128 | 34   |
| 10.31.3.2 | so-1/2/0.3 | Full  | 10.255.41.179 | 128 | 37   |

**Router P0 Status: Logical System LS1**

**Purpose** Verify routing protocols operation.

**Action** user@P0> show isis adjacency logical-system LS1

| Interface  | System | L State | Hold (secs) | SNPA          |
|------------|--------|---------|-------------|---------------|
| fe-1/1/3.1 | PE1    | 2 Up    | 21          | 0:90:69:9:4:1 |

```

fe-1/1/3.1 PE1 1 Up 24 0:90:69:9:4:1
so-1/2/0.1 PE2 3 Up 25

```

```

user@P0> show bgp summary logical-system LS1
BGP is not running

```

```

user@P0> show route protocol isis logical-system LS1
inet.0: 7 destinations, 7 routes (7 active, 0 holddown, 0 hidden)
+ = Active Route, - = Last Active, * = Both
10.10.10.10/32 *[IS-IS/15] 00:09:15, metric 10
 > to 10.11.2.1 via fe-1/1/3.1
10.10.10.12/32 *[IS-IS/15] 00:09:39, metric 10
 > to 10.11.3.2 via so-1/2/0.1

```

```

iso.0: 1 destinations, 1 routes (1 active, 0 holddown, 0 hidden)

```

```

mpls.0: 7 destinations, 7 routes (7 active, 0 holddown, 0 hidden)

```

### Router P0 Status: Logical System LS2

**Purpose** Verify routing protocols operation.

**Action** user@P0> show bgp summary logical-system LS2  
BGP is not running

```

user@P0> show isis adjacency logical-system LS2
Interface System L State Hold (secs) SNPA
fe-1/1/3.0 PE1 2 Up 24 0:90:69:9:4:1
fe-1/1/3.0 PE1 1 Up 23 0:90:69:9:4:1
so-1/2/0.0 PE2 3 Up 24

```

```

user@P0> show route protocol isis logical-system LS2

```

```

inet.0: 7 destinations, 7 routes (7 active, 0 holddown, 0 hidden)
+ = Active Route, - = Last Active, * = Both

```

```

10.20.20.20/32 *[IS-IS/15] 00:09:44, metric 10
 > to 10.1.2.1 via fe-1/1/3.0
10.20.20.22/32 *[IS-IS/15] 00:09:45, metric 10
 > to 10.1.3.2 via so-1/2/0.0

```

```

iso.0: 1 destinations, 1 routes (1 active, 0 holddown, 0 hidden)

```

```

mpls.0: 7 destinations, 7 routes (7 active, 0 holddown, 0 hidden)

```

### Router PE2 Status: Main Router

**Purpose** Verify routing protocols operation.

**Action** user@PE2> show ospf neighbor

| Address   | Interface  | State | ID            | Pri | Dead |
|-----------|------------|-------|---------------|-----|------|
| 10.31.4.2 | fe-0/2/3.0 | Full  | 10.255.41.180 | 128 | 38   |
| 10.31.3.1 | so-1/2/0.3 | Full  | 10.255.41.175 | 128 | 36   |

```

user@PE2> show interfaces terse lo0

```

| Interface | Admin | Link | Proto | Local         | Remote  |
|-----------|-------|------|-------|---------------|---------|
| lo0       | up    | up   |       |               |         |
| lo0.0     | up    | up   | inet  | 10.255.41.179 | --> 0/0 |
|           |       |      |       | 127.0.0.1     | --> 0/0 |
|           |       |      | iso   |               |         |

```

47.0005.80ff.f800.0000.0108.0003.0102.5501.4179.00
 inet6 fe80::2a0:a5ff:fe12:29ff
 feee::10:255:14:179
lo0.1 up up inet 10.10.10.12 --> 0/0
 iso 47.1111.1111.1111.1113.00
lo0.2 up up inet 10.20.20.22 --> 0/0
 iso 47.2222.2222.2222.2224.00
lo0.16383 up up inet

user@PE2> show bgp summary
Groups: 1 Peers: 2 Down peers: 0
Table Tot Paths Act Paths Suppressed History Damp State Pending
inet.0 1 1 1 0 0 0 0
Peer AS InPkt OutPkt OutQ Flaps Last
Up/DwnState|#Active/Received/Damped...
10.255.41.175 500 24 27 0 0 11:46 0/0/0
 0/0/0
10.255.41.173 500 25 25 0 0 11:11 1/1/0
 0/0/0

user@PE2> show route protocol ospf

inet.0: 20 destinations, 22 routes (19 active, 0 holddown, 1 hidden)
+ = Active Route, - = Last Active, * = Both

10.255.41.175/32 *[OSPF/10] 00:00:20, metric 1
> via so-1/2/0.3
10.255.41.180/32 [OSPF/10] 00:00:20, metric 1
> to 10.31.4.2 via fe-0/2/3.0
10.255.41.173/32 *[OSPF/10] 00:00:20, metric 2
> via so-1/2/0.3
10.31.2.0/24 *[OSPF/10] 00:00:20, metric 2
> via so-1/2/0.3
10.31.3.0/24 [OSPF/10] 00:00:20, metric 1
> via so-1/2/0.3
224.0.0.5/32 *[OSPF/10] 00:13:46, metric 1
MultiRecv

iso.0: 1 destinations, 1 routes (1 active, 0 holddown, 0 hidden)

inet6.0: 2 destinations, 2 routes (2 active, 0 holddown, 0 hidden)

user@PE2> show route protocol bgp

inet.0: 20 destinations, 22 routes (19 active, 0 holddown, 1 hidden)
+ = Active Route, - = Last Active, * = Both

10.255.41.177/32 *[BGP/170] 00:11:23, localpref 100, from 10.255.41.173
AS path: I
> via so-1/2/0.3

iso.0: 1 destinations, 1 routes (1 active, 0 holddown, 0 hidden)

inet6.0: 2 destinations, 2 routes (2 active, 0 holddown, 0 hidden)

```

**Router PE2 Status: Logical System LSI**

**Purpose** Verify routing protocols operation.

```

Action user@PE2> show bgp summary logical-system LS1
Groups: 2 Peers: 2 Down peers: 0
Table Tot Paths Act Paths Suppressed History Damp State Pending
inet.0 0 0 0 0 0 0 0
inet.2 0 0 0 0 0 0 0
bgp.l3vpn.0 4 4 0 0 0 0 0
bgp.l3vpn.2 0 0 0 0 0 0 0
Peer AS InPkt OutPkt OutQ Flaps Last Up/Dwn
State|#Active/Received/Damped...
10.10.10.10 100 29 31 0 0 11:25 Establ
 bgp.l3vpn.0: 4/4/0
 bgp.l3vpn.2: 0/0/0
 blue.inet.0: 2/2/0
 red.inet.0: 2/2/0
10.21.4.2 300 27 28 0 0 11:40 Establ
 blue.inet.0: 1/1/0

```

```

Red VPN user@PE2> show route logical-system LS1 table red
red.inet.0: 6 destinations, 6 routes (6 active, 0 holddown, 0 hidden)
+ = Active Route, - = Last Active, * = Both
10.11.1.0/24 * [BGP/170] 00:12:02, localpref 100, from 10.10.10.10
 AS path: I
 > via so-1/2/0.1, label-switched-path to_10.10.10.10
10.11.1.100/32 * [BGP/170] 00:12:02, MED 1, localpref 100, from 10.10.10.10
 AS path: I
 > via so-1/2/0.1, label-switched-path to_10.10.10.10
10.11.4.0/24 * [Direct/0] 00:13:22
 > via fe-0/2/1.0
10.11.4.1/32 * [Local/0] 00:13:29
 Local via fe-0/2/1.0
10.11.4.100/32 * [OSPF/10] 00:12:35, metric 1
 > to 10.11.4.2 via fe-0/2/1.0
224.0.0.5/32 * [OSPF/10] 00:15:02, metric 1
 MultiRecv

```

```

Blue VPN user@PE2> show route logical-system LS1 table blue
blue.inet.0: 5 destinations, 5 routes (5 active, 0 holddown, 0 hidden)
+ = Active Route, - = Last Active, * = Both
10.21.1.0/24 * [BGP/170] 00:13:12, localpref 100, from 10.10.10.10
 AS path: I
 > via so-1/2/0.1, label-switched-path to_10.10.10.10
10.21.1.100/32 * [BGP/170] 00:13:12, localpref 100, from 10.10.10.10
 AS path: 200 I
 > via so-1/2/0.1, label-switched-path to_10.10.10.10
10.21.4.0/24 * [Direct/0] 00:14:32
 > via fe-0/2/2.0
10.21.4.1/32 * [Local/0] 00:14:39
 Local via fe-0/2/2.0
10.21.4.100/32 * [BGP/170] 00:13:27, localpref 100
 AS path: 300 I
 > to 10.21.4.2 via fe-0/2/2.0

```

```

user@PE2> show mpls lsp logical-system LS1
Ingress LSP: 1 sessions
To From State Rt ActivePath P LSPname
10.10.10.10 10.10.10.12 Up 0 * to_10.10.10.10
Total 1 displayed, Up 1, Down 0
Egress LSP: 1 sessions
To From State Rt Style Labelin Labelout LSPname
10.10.10.12 10.10.10.10 Up 0 1 FF 3 - to_10.10.10.12
Total 1 displayed, Up 1, Down 0

```

```
Transit LSP: 0 sessions
Total 0 displayed, Up 0, Down 0
```

```
user@PE2> show rsvp session logical-system LS1
Ingress RSVP: 1 sessions
To From State Rt Style Labelin Labelout LSPname
10.10.10.10 10.10.10.12 Up 0 1 FF - 100000 to_10.10.10.10
Total 1 displayed, Up 1, Down 0
Egress RSVP: 1 sessions
To From State Rt Style Labelin Labelout LSPname
10.10.10.12 10.10.10.10 Up 0 1 FF 3 - to_10.10.10.12
Total 1 displayed, Up 1, Down 0
Transit RSVP: 0 sessions
Total 0 displayed, Up 0, Down 0
```

**Router PE2 Status: Logical System LS2**

**Purpose** Verify routing protocols operation.

**Action** user@PE2> show vpls connections logical-system LS2  
Layer-2 VPN Connections:

```
Legend for connection status (St)
OR -- out of range WE -- intf encaps != instance encaps
EI -- encapsulation invalid Dn -- down
EM -- encapsulation mismatch VC-Dn -- Virtual circuit down
CM -- control-word mismatch -> -- only outbound conn is up
CN -- circuit not provisioned <- -- only inbound conn is up
OL -- no outgoing label Up -- operational
NC -- intf encaps not CCC/TCC XX -- unknown
NP -- intf h/w not present

Legend for interface status
Up -- operational
Dn -- down

Instance: new
Local site: newPE (2)
 connection-site Type St Time last up # Up trans
 1 rmt Up Jul 16 14:05:25 2003 1
 Local interface: vt-1/1/0.40960, Status: Up, Encapsulation: VPLS
 Remote PE: 10.20.20.20, Negotiated control-word: No
 Incoming label: 800000, Outgoing label: 800001
```

```
user@PE2> show bgp summary logical-system LS2
Groups: 1 Peers: 1 Down peers: 0
Table Tot Paths Act Paths Suppressed History Damp State Pending
bgp.12vpn.0 1 1 0 0 0 0 0
Peer AS InPkt OutPkt OutQ Flaps Last
Up/DwnState|#Active/Received/Damped...
10.20.20.20 400 29 31 0 0 13:29 Establ
 bgp.12vpn.0: 1/1/0
 new.12vpn.0: 1/1/0
```

```
user@PE2> show mpls lsp logical-system LS2
Ingress LSP: 1 sessions
To From State Rt ActivePath P LSPname
10.20.20.20 10.20.20.22 Up 0 * to_10.20.20.20
Total 1 displayed, Up 1, Down 0
```

```
Egress LSP: 1 sessions
To From State Rt Style Labelin Labelout LSPname
10.20.20.22 10.20.20.20 Up 0 1 FF 3 - to_10.20.20.22
Total 1 displayed, Up 1, Down 0
```

```
Transit LSP: 0 sessions
Total 0 displayed, Up 0, Down 0
```

```
user@PE2> show rsvp session logical-system LS2
```

```
Ingress RSVP: 1 sessions
To From State Rt Style Labelin Labelout LSPname
10.20.20.20 10.20.20.22 Up 0 1 FF - 100016 to_10.20.20.20
Total 1 displayed, Up 1, Down 0
```

```
Egress RSVP: 1 sessions
To From State Rt Style Labelin Labelout LSPname
10.20.20.22 10.20.20.20 Up 0 1 FF 3 - to_10.20.20.22
Total 1 displayed, Up 1, Down 0
```

```
Transit RSVP: 0 sessions
Total 0 displayed, Up 0, Down 0
```

### Router CE5 Status

**Purpose** Verify connectivity.

```
user@CE5> show route table
inet.0: 6 destinations, 6 routes (6 active, 0 holddown, 0 hidden)
+ = Active Route, - = Last Active, * = Both
10.11.1.0/24 *[OSPF/150] 00:19:47, metric 0, tag 3489661028
 > to 10.11.4.1 via fe-0/3/1.0
10.11.1.100/32 *[OSPF/10] 00:19:47, metric 2
 > to 10.11.4.1 via fe-0/3/1.0
10.11.4.0/24 *[Direct/0] 00:21:12
 > via fe-0/3/1.0
10.11.4.2/32 *[Local/0] 00:21:24
 Local via fe-0/3/1.0
10.11.4.100/32 *[Direct/0] 00:22:37
 > via lo0.0
224.0.0.5/32 *[OSPF/10] 00:22:44, metric 1
 MultiRecv
```

### Router CE6 Status

**Purpose** Verify connectivity.

```
user@CE6> show route table
inet.0: 5 destinations, 5 routes (5 active, 0 holddown, 0 hidden)
+ = Active Route, - = Last Active, * = Both
10.21.1.0/24 *[BGP/170] 00:19:53, localpref 100
 AS path: 100 I
 > to 10.21.4.1 via fe-0/3/2.0
10.21.1.100/32 *[BGP/170] 00:19:53, localpref 100
 AS path: 100 200 I
 > to 10.21.4.1 via fe-0/3/2.0
10.21.4.0/24 *[Direct/0] 00:21:16
 > via fe-0/3/2.0
```

```

10.21.4.2/32 *[Local/0] 00:21:28
 Local via fe-0/3/2.0
10.21.4.100/32 *[Direct/0] 00:22:41
 > via lo0.0

```

### ***Router CE7 Status***

**Purpose** Verify connectivity.

**Action** user@CE7> show route table

```

inet.0: 2 destinations, 2 routes (2 active, 0 holddown, 0 hidden)
+ = Active Route, - = Last Active, * = Both

```

```

10.1.1.0/24 *[Direct/0] 00:21:03
 > via fe-0/3/0.0
10.1.1.2/32 *[Local/0] 00:21:15
 Local via fe-0/3/0.0

```

### ***Logical System Administrator Verification Output***

**Purpose** Because logical system administrators only have access to the configuration information of the logical systems to which they are assigned, the verification output is limited to these logical systems as well. The following output shows what the logical system administrator **LS1-admin** in this example configuration would see.

To verify that each pair of CE routers has end-to-end connectivity, issue the **ping** command on Routers CE1, CE2, and CE3:

**Action** From CE1, ping CE5 (the Red VPN).

From CE2, ping CE6 (the Blue VPN).

From CE3, ping CE7 (the VPLS).

```

user@CE1> ping 10.11.4.100
PING 10.11.4.100 (10.11.4.100): 56 data bytes
64 bytes from 10.11.4.100: icmp_seq=0 ttl=252 time=1.216 ms
64 bytes from 10.11.4.100: icmp_seq=1 ttl=252 time=1.052 ms
^C
--- 10.11.4.100 ping statistics ---
2 packets transmitted, 2 packets received, 0% packet loss
round-trip min/avg/max/stddev = 1.052/1.134/1.216/0.082 ms

```

```

user@CE2> ping 10.21.4.100
PING 10.21.4.100 (10.21.4.100): 56 data bytes
64 bytes from 10.21.4.100: icmp_seq=0 ttl=252 time=1.205 ms
64 bytes from 10.21.4.100: icmp_seq=1 ttl=252 time=1.021 ms
^C
--- 10.21.4.100 ping statistics ---
2 packets transmitted, 2 packets received, 0% packet loss
round-trip min/avg/max/stddev = 1.021/1.113/1.205/0.092 ms

```

```

user@CE3> ping 10.1.1.2
PING 10.1.1.2 (10.1.1.2): 56 data bytes
64 bytes from 10.1.1.2: icmp_seq=0 ttl=255 time=1.186 ms
64 bytes from 10.1.1.2: icmp_seq=1 ttl=255 time=1.091 ms
64 bytes from 10.1.1.2: icmp_seq=2 ttl=255 time=1.081 ms

```



```
^C
--- 10.1.1.2 ping statistics ---
3 packets transmitted, 3 packets received, 0% packet loss
round-trip min/avg/max/stddev = 1.081/1.119/1.186/0.047 ms
```

**Related Documentation**

- [Introduction to Logical Systems on page 3](#)



# Datacenter

- [Example: Configuring a Virtualized Data Center on page 227](#)

## Example: Configuring a Virtualized Data Center

---

- [Two-Tiered Virtualized Data Center Solution for Large Enterprise Networks on page 227](#)
- [Requirements of a Two-Tiered Virtualized Data Center for Large Enterprise Networks on page 229](#)
- [Example: Configuring a Two-Tiered Virtualized Data Center for Large Enterprise Networks on page 231](#)

## Two-Tiered Virtualized Data Center Solution for Large Enterprise Networks

The following describes a Juniper Networks two-tiered, high-speed, multiservice virtualized data center (VDC). A two-tiered architecture meets the low latency requirements of a virtualized server environment and supports the overlying security mandate to maintain controlled segmentation between various business units.

### Network Traffic Segmentation

---

Juniper Networks VDC design uses virtualization technologies such as virtual LANs (VLANs), virtual routers, virtual route forwarders, inter-virtual route forwarding, and logical systems to provide flexible traffic isolation.

A fully redundant two-tiered data center design consists of Juniper Networks EX Series Ethernet Switches at the access layer for server connectivity, MX Series 3D Universal Edge Routers as a collapsed LAN aggregation/core layer, and clustered SRX Series Services Gateways to provide firewall security services across the data center trust boundaries.

### Flexibility

---

The Juniper Networks VDC design uses 802.1Q VLANs, MPLS, BGP, Virtual Router Redundancy Protocol (VRRP), Traffic Engineering, and Fast Reroute to provide design flexibility while maintaining a standards-based approach. The design can also support a virtual private LAN service (VPLS).

## Security

---

The Juniper Networks VDC design uses security zones to implement the policy enforcement points. The SRX cluster is responsible for all stateful packet inspection for traffic that crosses business unit trust boundaries as well as all ingress and egress traffic for the data center.

The Juniper Networks Junos operating system is configured with different administrator accounts for each logical system that supports confined access to network resources and can be customized for individual business units.

## Access and Availability

---

In the Juniper Networks VDC design, described in [“Example: Configuring a Two-Tiered Virtualized Data Center for Large Enterprise Networks”](#) on page 231, top-of-rack (TOR) EX Series switches provide access to the servers and provide redundancy.

All uplinks from the TOR switches are 802.1Q trunk links that are terminated directly into each of the MX Series devices that make up the Point of Delivery (POD) at the aggregation/core layer.

A VRRP instance is defined on each VLAN within the MX Series device to act as the default router for all server hosts in a given VLAN. To allow for VRRP to work properly, each bridge domain is extended between each MX Series device through an interconnection link. The MX Series device uses an integrated routing and bridging (IRB) interface as the Layer 3 interface for each bridge domain, with VRRP configured for redundancy.

A pair of 802.3ad aggregated Ethernet bundles are used between the MX Series devices. Each MX Series device is divided into a number of Logical Systems. Logical systems in the MX Series device are used to define logical trust boundaries within the data center itself and between respective business units.

A clustered pair of SRX Series devices acting as firewalls provide security services across the data center trust boundaries. Virtual routers on the SRX Series devices act as customer edge (CE) routers for each business unit.

A single redundancy group for the data plane is defined on the SRX Series Services Gateways with two redundant Ethernet interfaces as member interfaces. This redundancy group handles the data plane failover of the SRX Series firewall and is configured such that any loss of either northbound or southbound SRX Series interfaces forces a full failover to the secondary node. This failover is essentially a Layer 1 failover, which means that it occurs quickly and does not disrupt the routing topology above it.

## Cost-Effective Incremental Scaling

---

The Juniper Networks VDC design supports incremental scaling of the network. This allows the VDC to be created with minimum cost to meet the current need.

The access layer can be expanded by adding EX Series switches at the top of rack.

The aggregation/core layer can be expanded by adding additional MX Series devices within a given POD.

The security services can be expanded by adding 4-port 10-Gigabit Ethernet I/O cards (IOCs) and services processing cards (SPCs) in the SRX Series devices. The addition of IOCs increases the 10-Gigabit Ethernet port density. The addition of each SPC card to the chassis adds another 10 Gbps (5 Gbps Internet mix (IMIX)), 2 million sessions, and 100,000 connections per second (CPS) up to a maximum rated capacity for the platform of 150 Gbps (47.5 Gbps IMIX), 10 million sessions, and 350,000 CPS (as measured in Junos OS Release 10.2).

### Orchestration and Automation

---

The Juniper Networks VDC design uses the Juniper Networks Junos Space management platform. Junos Space includes a portfolio of applications for scaling services, simplifying network operations, and automating support for complex network environments.

In addition, the network devices are configured to support background Secure Copy Protocol (SCP) file transfers, commit scripts, and a file archive site.

## Requirements of a Two-Tiered Virtualized Data Center for Large Enterprise Networks

Large enterprises have certain specific needs for the hosting environment that the design of their data center must meet. This section describes the requirements of a company that operates as a service provider to its individual business units (BUs).

One of the primary requirements of a virtualized data center (VDC) for a large enterprise is the ability to segment the network by business unit. This includes traffic segmentation and administrative control segmentation.

Other requirements include security controls between business units, security controls between the company and the outside world, flexibility to grow and adapt the network, and a robust and cost-effective way to manage the entire network.

### Network Traffic Segmentation

---

The requirement described here is for network resources to be isolated in several ways. Traffic must be segmented by business units. Traffic flows between network segments must be prohibited except where specifically allowed. Traffic isolation must be controlled at designated policy enforcement points. Network resources must be dedicated to a segment, but the network must have the flexibility to change the allocation of resources.

Segmented resources must be logically grouped according to policies. For example, test traffic must be isolated from production traffic. Traffic must also be isolated according to business entities, contractual requirements, legal or regulatory requirements, risk rating, and corporate standards.

The network segmentation design must not be disruptive to the business, must be integrated with the larger data center and cloud network design, must allow business units to access network resources globally, and must support new business capabilities.

### Flexibility

---

The network design must be flexible enough to react to business and environment changes with minimal design and re-engineering efforts. The VDC design must be flexible in terms of isolating business unit workloads from other business units and general data center

services and applications. The network solution must ensure that the business is minimally impacted when network and segmentation changes take place.

The VDC must be flexible enough to be implemented:

- Within a single data center
- Within a data hall
- Across two or more data centers
- Across two or more data halls within or between data centers
- Between a data center and an external cloud service provider

### Security

---

The network design must allow business units to be isolated within the hosting environment. In the event of a network security incident, business units must be isolated from the hosting environment and other business units.

Traffic flow between business unit segments must be denied by default and must be explicitly permitted only at policy enforcement points owned and controlled by the data center service provider.

The policy enforcement point must include access control capabilities and might include threat protection capabilities.

### Access and Availability

---

The VDC must provide access to common data center services such as computation, storage, security, traffic management, operations, and applications. The network must operate across multiple global service providers and must deliver optimal, predictable, and consistent performance across the network. The VDC must be implemented across data center business units.

The network solution must meet business unit availability requirements as defined in service-level agreements.

### Cost-Effective Incremental Scaling

---

The VDC design must be cost effective for the business to run and must enable new business capabilities. It must be possible to implement the network solution in an incremental manner with minimal impact to the business.

### Orchestration and Automation

---

The VDC design must include a management system that supports automation for provisioning, availability and workload monitoring, and reporting. Workload and availability reports must be available by business unit.

## Example: Configuring a Two-Tiered Virtualized Data Center for Large Enterprise Networks

This example provides a step-by-step procedure for configuring a two-tiered virtualized data center for large enterprise networks.

- [Requirements on page 231](#)
- [Configuring a Two-Tiered Virtualized Data Center Overview on page 231](#)
- [Configuring the Access Layer on page 234](#)
- [Configuring the Aggregation Layer in the Trusted Logical Systems on page 238](#)
- [Configuring the Core Layer in the Untrusted Logical Systems on page 246](#)
- [Configuring the Security Device on page 251](#)

### Requirements

---

This example uses the following hardware and software components:

- Two MX Series 3D Universal Edge Routers running Junos OS Release 10.2 or later
- Six EX Series Ethernet Switches running Junos OS Release 10.2 or later
- Two SRX Series Services Gateways running Junos OS Release 10.4 or later

### Configuring a Two-Tiered Virtualized Data Center Overview

---

This example provides a step-by-step procedure for configuring a two-tiered virtualized data center for large enterprises. The steps in the example follow the data path from an interface connected to a server in BU2 using VLAN 17, to Logical System Trust1, through Virtual Router MX-VR2, through Virtual Router SRX-VR2, through VRF2 in the Logical System Untrust, and out to the core network.

The core network in this example simultaneously supports IP-based routing and MPLS-based label switching. The virtual routers on the SRX Series device perform the functions of customer edge (CE) routers. The VPN routing and forwarding (VRF) routing instances on the MX Series devices perform the functions of service provider edge (PE) routers. The OSPF protocol serves as the interior gateway protocol to carry routes to the PE router loopback addresses that are used as the BGP next-hop address for the IP-based and MPLS-based networks supported by this example.



**NOTE:** The steps in this example are representative of the entire network configuration. The example does not show every step for every virtual device.

The physical connections used in this example are shown in [Figure 28 on page 232](#).

Figure 28: Virtualized Data Center Physical Topology

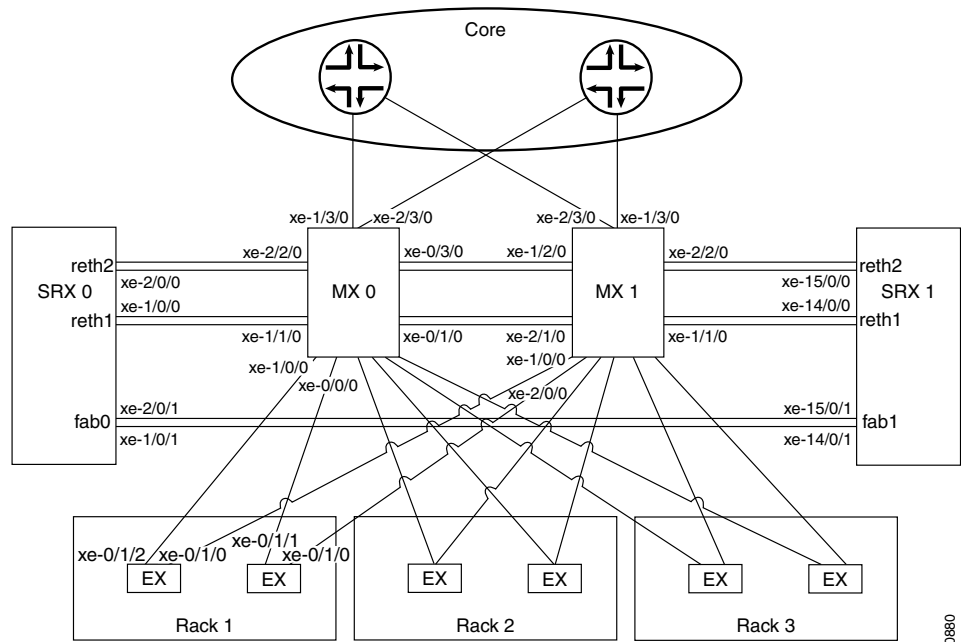

The logical connections used in this example are shown in [Figure 29 on page 233](#).



Figure 29: Virtualized Data Center Logical Topology

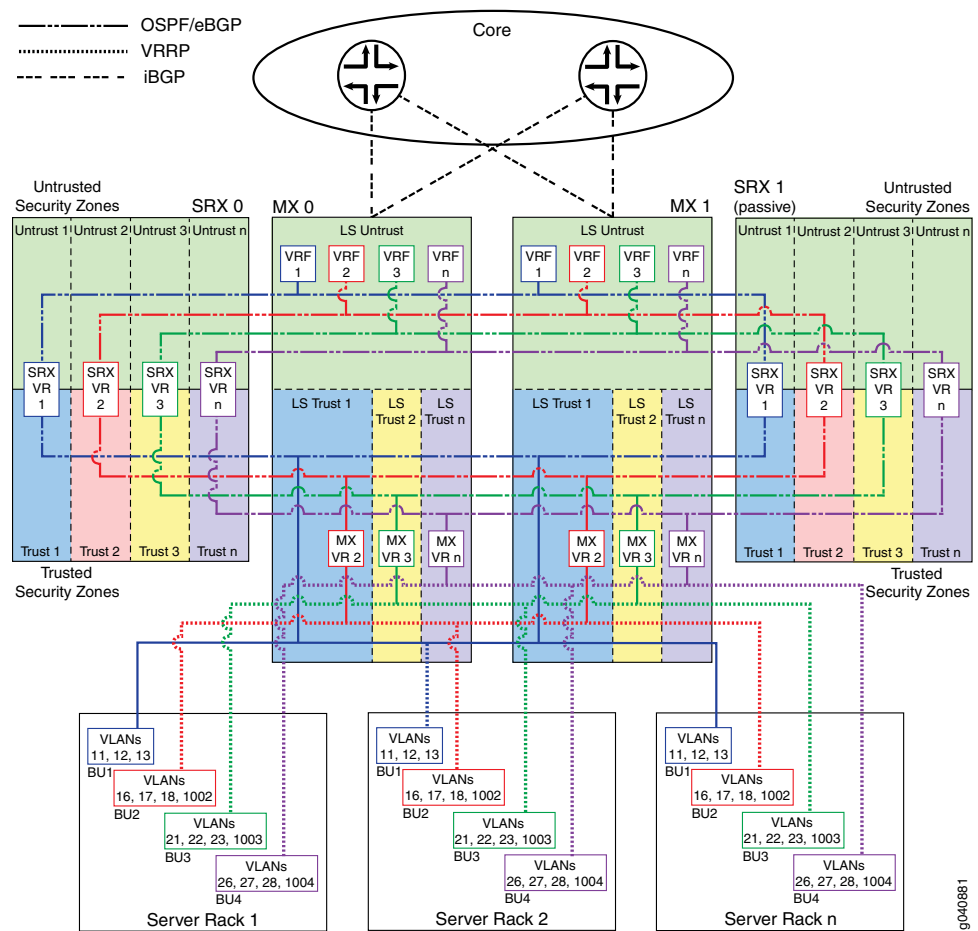

In the logical topology illustration:

- Users access the data center across the enterprise core network shown at the top.
- Virtual routers configured in Logical System Untrust on the MX Series devices forward the traffic to separate virtual routers configured in the Untrusted security zone on the SRX Series devices. These virtual routers act as edge routers for the various business units.
- Virtual routers configured on the active SRX Series device forward the traffic to the Trusted security zones.
- Virtual routers configured in separate logical systems on the MX Series devices forward the traffic to a bridge domain of VLANs configured on the EX Series devices.
- Business unit 1 requires additional separation. In this case, the virtual router (VR) configured on the SRX Series device forwards the traffic directly to the bridge domain on the EX Series devices.
- The EX Series devices switch the traffic to the data center server.

- The SRX Series devices apply security policy to all traffic traversing the untrust to trust boundary and all traffic forwarded between logical systems.
- The SRX Series devices are configured in an active/passive cluster so that only one node in the cluster is active on the data forwarding plane at a time.
- The SRX Series devices are configured with a single redundancy group for the data plane. The redundancy group uses two Ethernet interfaces (**reth1** and **reth2** in [Figure 28 on page 232](#)) as member interfaces.

### Configuring the Access Layer

Configure the access layer by doing the following:

- [Configuring Interfaces on page 234](#)
- [Configuring VLANs in the Access Layer on page 235](#)
- [Configuring a Redundant Trunk Group and Disabling the Spanning Tree Protocol for the Trunk Interfaces on page 236](#)
- [Configuring Management Automation on page 237](#)

#### Configuring Interfaces

#### Step-by-Step Procedure

This procedure explains how to configure the physical, logical, and network management interfaces for the access layer devices. This procedure shows a representative sample of the configuration. The example does not show the configuration for every interface.

1. Configure the access layer server-facing 10-Gigabit Ethernet interfaces.

This example configures the **ge-0/0/17** interface with VLAN ID 17.

Include the **member** statement and specify VLAN ID 17 at the **[edit interfaces ge-0/0/17 unit 0 family ethernet-switching vlan]** hierarchy level.

```
[edit interfaces ge-0/0/17 unit 0]
user@ex# set family ethernet-switching vlan members 17
```

Repeat this step for every server-facing interface by using the appropriate interface name and VLAN number.

2. Configure the 10-Gigabit Ethernet trunk interfaces from the EX Series device to the two MX Series devices.

This example configures the **xe-0/1/2** and **xe-0/1/0** interfaces.

Include the **port-mode** statement and specify the **trunk** option at the **[edit interfaces xe-0/1/2 unit 0 family ethernet-switching]** and **[edit interfaces xe-0/1/0 unit 0 family ethernet-switching]** hierarchy levels.

Include the **members** statement and specify the **all** option at the **[edit interfaces xe-0/1/2 unit 0 family ethernet-switching vlan]** and **[edit interfaces xe-0/1/0 unit 0 family ethernet-switching]** hierarchy levels.

```
[edit interfaces xe-0/1/2 unit 0]
user@ex# set family ethernet-switching port-mode trunk
user@ex# set family ethernet-switching vlan members all
```

```
[edit interfaces xe-0/1/0 unit 0]
```

```

user@ex# set family ethernet-switching port-mode trunk
user@ex# set family ethernet-switching vlan members all

```

Repeat this step for every 10-Gigabit Ethernet trunk interface by using the appropriate interface name.

3. Enable the IPv4 address family for the loopback logical interface.

Include the **family** statement and specify the **inet** option to enable IPv4 at the **[edit interfaces lo0 unit 0]** hierarchy level.

```

[edit interfaces lo0 unit 0]
user@ex# set family inet

```

Repeat this step for every EX Series device by using the appropriate address for that device.

4. Configure the EX Series device management Ethernet interface.

This example configures the **unit 0** logical interface.

Include the **family** statement and specify the **inet** option at the **[edit me0 unit 0]** hierarchy level.

Include the **address** statement and specify **10.8.108.19/24** as the IPv4 address at the **[edit interfaces me0 unit 0 family inet]** hierarchy level.

```

[edit interfaces me0 unit 0]
user@ex# set family inet address 10.8.108.19/24

```

Repeat this step for every EX Series device by using the appropriate management interface address for that device.

### *Configuring VLANs in the Access Layer*

#### **Step-by-Step Procedure**

This procedure explains how to configure the VLAN names and tag IDs and associate trunk interfaces with one of the access layer devices. This procedure shows a representative sample of the configuration. The example does not show the configuration for every VLAN.

1. Configure the VLAN name and tag ID (number) for each VLAN on the EX Series device.

This example configures a VLAN with the name **vlan17** and tag ID **17**.

Include the **vlan-id** statement and specify **17** as the VLAN tag ID at the **[edit vlans vlan17]** hierarchy level.

```

[edit vlans vlan17]
user@ex# set vlan-id 17

```

Repeat this step for every VLAN on each EX Series device by using the appropriate VLAN names and tag IDs.

2. Associate the logical trunk interfaces with each VLAN on the EX Series device.

This example associates logical interfaces **xe-0/1/0.0** and **xe-0/1/2.0** with **vlan17**.

Include the **interface** statement and specify **xe-0/1/0.0** at the **[edit vlans vlan17]** hierarchy level.

Include the **interface** statement and specify **xe-0/1/2.0** at the **[edit vlans vlan17]** hierarchy level.

```
[edit vlans vlan17]
user@ex# set interface xe-0/1/0.0
user@ex# set interface xe-0/1/2.0
```

Repeat this step for every VLAN on each EX Series device by using the appropriate trunk interface names.

### ***Configuring a Redundant Trunk Group and Disabling the Spanning Tree Protocol for the Trunk Interfaces***

**Step-by-Step Procedure** This procedure explains how to configure a redundant trunk group and disable the Rapid Spanning Tree Protocol (RSTP) on the trunk interfaces.

1. Configure the trunk interfaces as a redundant trunk group.

This example configures the **xe-0/1/0.0** and **xe-0/1/2.0** trunk interfaces in a redundant trunk group named **rtgroup1**.

Include the **interface** statement at the **[edit ethernet-switching-options redundant-trunk-group group rtgroup1]** hierarchy level and specify each trunk interface name.

Include the **primary** statement at the **[edit ethernet-switching-options redundant-trunk-group group rtgroup1 xe-0/1/2.0]** hierarchy level.

```
[edit ethernet-switching-options redundant-trunk-group group rtgroup1]
user@ex# set interface xe-0/1/0.0
user@ex# set interface xe-0/1/2.0 primary
```

Repeat this step for every redundant trunk group by using the appropriate interface names.

2. Disable RSTP on the trunk interfaces.

On an EX Series device, RSTP is enabled by default. RSTP cannot be enabled on the same interface as routing.

This example disables RSTP on the **xe-0/1/0.0** and **xe-0/1/2.0** trunk interfaces.

Include the **disable** statement at the **[edit protocols rstp interface xe-0/1/0.0]** and **[edit protocols rstp interface xe-0/1/2.0]** hierarchy levels.

```
[edit protocols rstp]
user@ex# set interface xe-0/1/0.0 disable
user@ex# set interface xe-0/1/2.0 disable
```

Repeat this step for every core-facing trunk interface by using the appropriate interface name.

### Configuring Management Automation

**Step-by-Step Procedure** This procedure explains how to configure static routes to the management network, a known host to support background Secure Copy Protocol (SCP) file transfers, a commit script, and an event archive site.

1. Configure static routes so the Ethernet management interface can reach the management network.

Include the **route** statement, and specify **10.8.0.0/16** as the IPv4 subnet address of the management network at the **[edit routing-options static]** hierarchy level.

Include the **next-hop** statement, and specify the IPv4 host address of the next-hop router at the **[edit routing-options static route 10.8.0.0/16]** hierarchy level.

```
[edit routing-options static]
user@ex# set route 10.8.0.0/16 next-hop 10.8.108.254
```

Repeat this step for every Ethernet management interface on the EX Series devices.

2. Configure an SSH known host.

Include the **host** statement, and specify the IPv4 address and RSA host key options for trusted servers at the **[edit security ssh-known-hosts]** hierarchy level. In this example, the RSA host key is truncated to make it easier to read.

```
[edit security ssh-known-hosts]
user@ex# set host 127.0.0.1 rsa-key AAAAB3NzaC1yc2
```

Repeat this step for every EX Series device.

3. Configure outbound SSH to support Juniper Message Bundle (JMB) transfers to Juniper Support Systems (JSS).

In this example, the client ID is configured as **00187D0B670D**.

Include the **client** statement, specify **00187D0B670D** as the client ID, and specify **10.8.7.32** as the IPv4 address at the **[edit system services outbound-ssh]** hierarchy level.

Include the **port** statement and specify **7804** as the TCP port at the **[edit system services outbound-ssh client 00187D0B670D 10.8.7.32]** hierarchy level.

Include the **device-id** statement and specify **FA022D** as the device ID at the **[edit system services outbound-ssh client 00187D0B670D]** hierarchy level.

Include the **secret** statement at the **[edit system services outbound-ssh client 00187D0B670D ]** hierarchy level.

Include the **services** statement and specify **netconf** as the available service at the **[edit system services outbound-ssh client 00187D0B670D ]** hierarchy level.

```
[edit system services outbound-ssh client 00187D0B670D]
user@ex# set 10.8.7.32 port 7804
user@ex# set device-id FA022D
user@ex# set secret "9-9w4aik.QznDj9A0BEhrlKMxN"
user@ex# set services netconf
```

Repeat this step for every EX Series device.

4. Configure a commit script.

In this example the script file name is **jais-activate-scripts.slax**.

Include the **allow-transients** statement at the **[edit system scripts commit]** hierarchy level.

Include the **optional** statement at the **[edit system scripts commit file jais-activate-scripts.slax]** hierarchy level.

```
[edit system scripts commit]
user@ex# set allow-transients
user@ex# set file jais-activate-scripts.slax optional
```

Repeat this step for every EX Series devices.

5. Configure an event archive site.

In this example, the archive URL is the local **/var/tmp/** directory, and the name given to the destination is **juniper-aim**.

Include the **archive-sites** statement and specify the archive URL at the **[edit event-options destinations juniper-aim]** hierarchy level.

```
[edit event-options destinations juniper-aim]
user@ex# set archive-sites "scp://admin@127.0.0.1:/var/tmp" password "12345"
```

Repeat this step for every EX Series device.

## Configuring the Aggregation Layer in the Trusted Logical Systems

Configure the aggregation layer by doing the following:

- [Configuring Interfaces in the Trusted Logical Systems on page 238](#)
- [Configuring VLANs in the Aggregation Layer on page 241](#)
- [Configuring the Virtual Router Routing Instance on page 242](#)
- [Configuring Management Interfaces on page 243](#)
- [Configuring Logical System Administrator Accounts on page 244](#)
- [Configuring Management Automation on page 245](#)

### Configuring Interfaces in the Trusted Logical Systems

#### Step-by-Step Procedure

This procedure explains how to configure the physical, logical, and Layer 3 routing interfaces for the logical system in the trusted security zone of the aggregation layer. This procedure shows a representative sample of the configuration. The example does not show the configuration for every interface.

1. Enable flexible VLAN tagging on the physical interfaces.

This example configures physical interface **xe-1/0/0**.

Include the **encapsulation** statement and specify the **flexible-ethernet-services** option at the **[edit interfaces xe-1/0/0]** hierarchy level.

Include the **flexible-vlan-tagging** statement at the **[edit interfaces xe-1/0/0]** hierarchy level.

```
[edit interfaces xe-1/0/0]
user@mx# set encapsulation flexible-ethernet-services
user@mx# set flexible-vlan-tagging
```

Repeat this step for every physical interface connected to the EX series, SRX Series, and MX Series devices using the appropriate interface name.

2. Configure the 10-Gigabit Ethernet interfaces connected to the EX Series access layer device.

This example configures logical interface 17 on the **xe-1/0/0** interface under the logical system named **Trust1**.

Include the **encapsulation** statement and specify the **vlan-bridge** option at the **[edit logical-systems Trust1 interfaces xe-1/0/0 unit 17]** hierarchy level.

Include the **vlan-id** statement and specify **17** as the VLAN ID at the **[edit logical-systems Trust1 interfaces xe-1/0/0 unit 17]** hierarchy level.

```
[edit logical-systems Trust1 interfaces xe-1/0/0 unit 17]
user@mx# set encapsulation vlan-bridge
user@mx# set vlan-id 17
```

Repeat this step for every interface connected to the access layer devices by using the appropriate interface name, logical interface number, VLAN ID, and logical system name.

3. Configure the 10-Gigabit Ethernet interfaces connected to the other MX Series device shown in [Figure 28 on page 232](#).

This example configures logical interface 17 on the **xe-0/1/0** interface.

Include the **encapsulation** statement and specify the **vlan-bridge** option at the **[edit logical-systems Trust1 interfaces xe-0/1/0 unit 17]** hierarchy level.

Include the **vlan-id** statement and specify **17** as the VLAN tag ID at the **[edit logical-systems Trust1 interfaces xe-0/1/0 unit 17]** hierarchy level.

```
[edit logical-systems Trust1 interfaces xe-0/1/0 unit 17]
user@mx# set encapsulation vlan-bridge
user@mx# set vlan-id 17
```

Repeat this step for every interface connected to the other MX Series device shown in [Figure 28 on page 232](#) by using the appropriate interface name, logical interface number, VLAN ID, and logical system name.

4. Configure the 10-Gigabit Ethernet interface connected to the SRX Series device.

This example configures logical interface 15 on the **xe-1/1/0** interface. Include the **encapsulation** statement and specify the **vlan-bridge** option at the **[edit logical-systems Trust1 interfaces xe-1/1/0 unit 15]** hierarchy level.

Include the **vlan-id** statement and specify **15** as the VLAN tag ID at the **[edit logical-systems Trust1 interfaces xe-1/1/0 unit 15]** hierarchy level.

```
[edit logical-systems Trust1 interfaces xe-1/1/0 unit 15]
user@mx# set encapsulation vlan-bridge
user@mx# set vlan-id 15
```

Repeat this step for every interface connected to the SRX Series device by using the appropriate interface name, logical interface number, VLAN ID, and logical system name.

5. Configure the Layer 3 integrated routing and bridging (IRB) interface address.

This example configures the **unit 17** logical interface with **10.17.2.2/24** as the IPv4 address under the logical system named **Trust1**. Include the **address** statement and specify **10.17.2.2/24** as the IPv4 address at the **[edit logical-systems Trust1 interfaces irb unit 17 family inet]** hierarchy level.

```
[edit logical-systems Trust1 interfaces irb unit 17 family inet]
user@mx# set address 10.17.2.2/24
```

Repeat this step for every Layer 3 IBR by using the appropriate logical interface name and IPv4 address.

6. Configure the IRB interface to participate in Virtual Router Redundancy Protocol (VRRP).

This example configures the **unit 17** logical interface with **17** as the VRRP group name.

Include the **virtual-address** statement and specify **10.17.2.1** as the IPv4 address of the virtual router at the **[edit logical-systems Trust1 interfaces irb unit 17 family inet address 10.17.2.2/24 vrrp-group 17]** hierarchy level.

Include the **accept-data** statement at the **[edit logical-systems Trust1 interfaces irb unit 17 family inet address 10.17.2.2/24 vrrp-group 17]** hierarchy level so the interface will accept packets destined for the virtual IP address.

Include the **priority** statement and specify **200** as the router's priority at the **[edit logical-systems Trust1 interfaces irb unit 17 family inet address 10.17.2.2/24 vrrp-group 17]** hierarchy level.

Include the **fast-interval** statement and specify **200** as the interval between VRRP advertisements at the **[edit logical-systems Trust1 interfaces irb unit 17 family inet address 10.17.2.2/24 vrrp-group 17]** hierarchy level.

Include the **preempt** statement at the **[edit logical-systems Trust1 interfaces irb unit 17 family inet address 10.17.2.2/24 vrrp-group 17]** hierarchy level.

```
[edit logical-systems Trust1 interfaces irb unit 17 family inet address 10.17.2.2/24
 vrrp-group 17]
user@mx# set virtual-address 10.17.2.1
user@mx# set accept-data
user@mx# set priority 200
user@mx# set fast-interval 200
user@mx# set preempt
```

Repeat this step for every Layer 3 IBR interface by using the appropriate logical interface name, IPv4 address, VRRP group name, and priority.



### Configuring VLANs in the Aggregation Layer

#### Step-by-Step Procedure

This procedure explains how to configure the VLAN names and tag IDs and associate trunk interfaces and Layer 3 routing interfaces with each VLAN. This procedure shows a representative sample of the configuration. The example does not show the configuration for every VLAN.

1. Configure the VLAN name and tag ID (number) for each VLAN on the MX Series device.

This example configures a VLAN with the name `vlan17` and tag ID `17` in the Logical System `Trust1`. Include the `vlan-id` statement and specify `17` as the VLAN ID at the `[edit logical-systems Trust1 bridge-domains vlan17]` hierarchy level.

```
[edit logical-systems Trust1 bridge-domains vlan17]
user@mx# set vlan-id 17
```

Repeat this step for every VLAN on each MX Series device by using the appropriate VLAN names and tag IDs.

2. Associate the logical trunk interfaces with each VLAN on the MX Series device.

This example associates logical interface `xe-1/0/0.17` that is connected to the EX Series device and logical interface `xe-0/1/0.17` that is connected to the other MX Series device with `vlan17`.

Include the `interface` statement and specify `xe-1/0/0.17` at the `[edit logical-systems Trust1 bridge-domains vlan17]` hierarchy level.

Include the `interface` statement and specify `xe-0/1/0.17` at the `[edit logical-systems Trust1 bridge-domains vlan17]` hierarchy level.

```
[edit logical-systems Trust1 bridge-domains vlan17]
user@mx# set interface xe-1/0/0.17
user@mx# set interface xe-0/1/0.17
```

Repeat this step for every server-facing VLAN on each MX Series device by using the appropriate trunk interface names.

3. Associate a Layer 3 interface with each VLAN on the MX Series device.

This example associates the `irb.17` interface with `vlan17`.

Include the `routing-interface` statement and specify `irb.17` at the `[edit logical-systems Trust1 bridge-domains vlan17]` hierarchy level.

```
[edit logical-systems Trust1 bridge-domains vlan17]
user@mx# set routing-interface irb.17
```

Repeat this step for every server-facing VLAN on each MX Series device by using the appropriate Layer 3 interface name.

4. Associate the logical interfaces with each interconnection VLAN on the MX Series device.

This example associates logical interface `xe-1/1/0.15` that is connected to the SRX Series device and logical interface `xe-0/1/0.15` that is connected to the other MX Series device with `vlan15`.

Include the **interface** statement and specify **xe-1/1/0.15** at the **[edit logical-systems Trust1 bridge-domains vlan15]** hierarchy level.

Include the **interface** statement and specify **xe-0/1/0.15** at the **[edit logical-systems Trust1 bridge-domains vlan15]** hierarchy level.

```
[edit logical-systems Trust1 bridge-domains vlan15]
user@mx# set interface xe-1/1/0.15
user@mx# set interface xe-0/1/0.15
```

Repeat this step for every interconnect VLAN on each MX Series device by using the appropriate interconnect interface names.

5. Associate a Layer 3 interface with each interconnection VLAN on the MX Series device to support active participation in the OSPF protocol.

This example associates the **irb.15** interface with **vlan15**.

Include the **routing-interface** statement and specify **irb.15** at the **[edit logical-systems Trust1 bridge-domains vlan15]** hierarchy level.

```
[edit logical-systems Trust1 bridge-domains vlan15]
user@mx# set routing-interface irb.15
```

Repeat this step for every server-facing VLAN on each MX Series device by using the appropriate Layer 3 interface name.

### ***Configuring the Virtual Router Routing Instance***

#### **Step-by-Step Procedure**

This procedure explains how to configure a single virtual router routing instance. This procedure shows a representative sample of the example configuration. The example does not show the configuration for every device.

1. Configure the routing instance type.

This example configures the routing instance with the name **MX-VR2**. Include the **instance-type** statement and specify **virtual-router** as the type at the **[edit logical-systems Trust1 routing-instances MX-VR2]** hierarchy level.

```
[edit logical-systems Trust1 routing-instances MX-VR2]
user@mx# set instance-type virtual-router
```

Repeat this step for every virtual router in each MX Series device by using the appropriate virtual router name.

2. Add the IRB interfaces used by the virtual router routing instance.

Include the **interface** statement and specify the name of each IRB interface at the **[edit routing-instances MX-VR2]** hierarchy level.

```
[edit logical-systems Trust1 routing-instances MX-VR2]
user@mx# set interface irb.15
user@mx# set interface irb.16
user@mx# set interface irb.17
user@mx# set interface irb.18
user@mx# set interface irb.1002
```

Repeat this step for every virtual router in each MX Series device by using the appropriate interface names.

3. Configure the IGP protocol active interface used by the virtual router routing instance so the routing tables can be populated with the routes to the servers.

This example configures one IRB interface to actively participate in the OSPF protocol area **0.0.0.0**.

Include the **interface** statement and specify the name of the IRB interface at the **[edit logical-systems Trust1 routing-instances MX-VR2 protocols ospf area 0.0.0.0]** hierarchy level.

```
[edit routing-instances MX-VR2 protocols ospf area 0.0.0.0]
user@mx# set interface irb.15
```

Repeat this step for every virtual router in each MX Series device by using the appropriate virtual router name.

4. Configure the interior gateway protocol passive interfaces that are associated with each VLAN within the virtual router routing instance.

This example configures the IRB interfaces to passively participate in the OSPF protocol area **0.0.0.0**.

Include the **passive** statement at the **[edit logical-systems Trust1 routing-instances MX-VR2 protocols ospf area 0.0.0.0 interface *irb-name*]** hierarchy level.

```
[edit logical-systems Trust1 routing-instances MX-VR2 protocols ospf area 0.0.0.0]
user@mx# set interface irb.16 passive
user@mx# set interface irb.17 passive
user@mx# set interface irb.18 passive
user@mx# set interface irb.1002 passive
```

Repeat this step for every virtual router in each MX Series device by using the appropriate virtual router name.

5. Configure the logical system router identifier.

Include the **router-id** statement and specify **10.200.11.101** as the router identifier at the **[edit logical-systems Trust1 routing-instances MX-VR2 routing-options]** hierarchy level.

```
[edit logical-systems Trust1 routing-instances MX-VR2 routing-options]
user@mx# set router-id 10.200.11.101
```

Repeat this step for every virtual router in each MX Series device by using the appropriate router identifier.

### ***Configuring Management Interfaces***

#### **Step-by-Step Procedure**

This procedure explains how to configure static routes to the management network and the IPv4 address family for the loopback logical interface. This procedure shows a representative sample of the configuration. The example does not show the configuration for every interface.

1. Configure static routes so the Ethernet management interface can reach the management network.

Include the **route** statement and specify **10.0.0.0/8** as the IPv4 subnet address of the management network at the **[edit routing-options static]** hierarchy level.

Include the **next-hop** statement, and specify the IPv4 host address of the next-hop router at the **[edit routing-options static route 10.0.0.0/8]** hierarchy level.

Include the **retain** and **no-readvertise** statements at the **[edit routing-options static route 10.0.0.0/8]** hierarchy level.

```
[edit routing-options static]
user@mx# set route 10.0.0.0/8 next-hop 10.8.3.254
user@mx# set route 10.0.0.0/8 retain
user@mx# set route 10.0.0.0/8 no-readvertise
```

Repeat this step for every MX Series device.

2. Configure the MX Series device management Ethernet interface. This example configures the **unit 0** logical interface.

Include the **family** statement and specify the **inet** option at the **[edit fxp0 unit 0]** hierarchy level.

Include the **address** statement and specify **10.8.3.212/24** as the IPv4 address at the **[edit interfaces fxp0 unit 0]** hierarchy level.

```
[edit interfaces fxp0 unit 0]
user@mx# set family inet address 10.8.3.212/24
```

Repeat this step for every MX Series device by using the appropriate management interface address for that device.

3. Configure the loopback logical interface.

Include the **family** statement and specify the **inet** option at the **[edit interfaces lo0 unit 0]** hierarchy level.

```
[edit interfaces lo0 unit 0]
user@mx# set family inet
```

Repeat this step for every MX Series device.

### *Configuring Logical System Administrator Accounts*

**Step-by-Step Procedure** This procedure explains how to configure administrator account classes that are confined to the context of the logical system to which they are assigned and administrator accounts for each logical system.

1. Create administrator account classes.

In this example, the **trust1-admin** user class is created with **all** permissions for the **Trust1** logical system.

Include the **class** statement and specify **trust1-admin** as the class name at the **[edit system login]** hierarchy level.

Include the **logical-system** statement and specify **Trust1** as the logical system name at the **[edit system login class trust1-admin]** hierarchy level.

Include the **permissions** statement and specify the **all** option at the **[edit system login class trust1-admin]** hierarchy level.

```
[edit system]
```

```
user@mx# set login class trust1-admin logical-system Trust1
user@mx# set login class trust1-admin permissions all
```

Repeat this step for the trust2-admin and untrust-admin classes on each MX Series device by using the appropriate logical-system name.

2. Create administrator accounts that correspond to each logical system in the MX Series device.

In this example, the **trust1** user account is created and assigned the **trust1-admin** class.

Include the **class** statement and specify **trust1-admin** as the user class at the **[edit system login user trust1]** hierarchy level.

Include the **encrypted-password** statement and enter the encrypted password string at the **[edit system login user trust1 authentication]** hierarchy level.

```
[edit system]
user@mx# set login user trust1 class trust1-admin
user@mx# set login user trust1 authentication encrypted-password 12345
```

Repeat this step for the trust2 and untrust user accounts on each MX Series device.

### *Configuring Management Automation*

**Step-by-Step Procedure** This procedure explains how to configure a known host to support background SCP file transfers, a commit script, and an archive site.

1. Configure a commit script.

In this example, the script file name is **jais-activate-scripts.slax**.

Include the **allow-transients** statement at the **[edit system scripts commit]** hierarchy level.

Include the **optional** statement at the **[edit system scripts commit file jais-activate-scripts.slax]** hierarchy level.

```
[edit system scripts commit]
user@mx# set allow-transients
user@mx# set file jais-activate-scripts.slax optional
```

2. Configure an event archive site.

In this example the archive URL is the local **/var/tmp/** directory, and the name given to the destination is **juniper-aim**.

Include the **archive-sites** statement and specify the archive URL at the **[edit event-options destinations juniper-aim]** hierarchy level.

```
[edit event-options destinations juniper-aim]
user@mx# set archive-sites "scp://admin@127.0.0.1://var/tmp" password "12345"
```

## Configuring the Core Layer in the Untrusted Logical Systems

Configure the core layer by doing the following:

- [Configuring Interfaces in the Untrusted Logical Systems on page 246](#)
- [Configuring VLANs in the Core Layer on page 247](#)
- [Configuring Protocols in the Untrusted Logical System on page 248](#)

### Configuring Interfaces in the Untrusted Logical Systems

#### Step-by-Step Procedure

This procedure explains how to configure the physical, logical, and Layer 3 routing interfaces for the logical system in the untrusted security zone of the core layer. This procedure shows a representative sample of the configuration. The example does not show the configuration for every interface.

1. Configure the 10-Gigabit redundant Ethernet interfaces connected to the other MX Series device shown in [Figure 28 on page 232](#).

This example configures logical interface **19** on the **xe-0/3/0** interface under the logical system named **Untrust** to participate in VLAN 19. Include the **encapsulation** statement and specify the **vlan-bridge** option at the **[edit logical-systems Untrust interfaces xe-0/3/0 unit 19]** hierarchy level.

Include the **vlan-id** statement and specify **19** as the VLAN tag ID at the **[edit logical-systems Untrust interfaces xe-0/3/0 unit 19]** hierarchy level.

```
[edit logical-systems Untrust interfaces xe-0/3/0 unit 19]
user@mx# set encapsulation vlan-bridge
user@mx# set vlan-id 19
```

Repeat this step for every redundant Ethernet interface connected to the other MX Series device by using the appropriate interface name, logical interface number, VLAN ID, and logical system name.

2. Configure the 10-Gigabit Ethernet interfaces connected to the SRX Series device.

This example configures logical interface **19** on the **xe-2/2/0** interface under the logical system named **Untrust** to participate in VLAN 19.

Include the **encapsulation** statement and specify the **vlan-bridge** option at the **[edit logical-systems Untrust interfaces xe-2/2/0 unit 19]** hierarchy level.

Include the **vlan-id** statement and specify **19** as the VLAN tag ID at the **[edit logical-systems Untrust interfaces xe-2/2/0 unit 19]** hierarchy level.

```
[edit logical-systems Untrust interfaces xe-2/2/0 unit 19]
user@mx# set encapsulation vlan-bridge
user@mx# set vlan-id 19
```

Repeat this step for every redundant Ethernet interface connected to the SRX Series device by using the appropriate interface name, logical interface number, VLAN ID, and logical system name.

3. Configure the 10-Gigabit Ethernet interfaces connected to the IP-based/MPLS-based core network.

This example configures logical interface **0** on the **xe-1/3/0** interface under the logical system named **Untrust**.

Include the **address** statement and specify **10.200.4.1/30** as the IPv4 address at the **[edit logical-systems Untrust interfaces xe-1/3/0 unit 0 family inet]** hierarchy level.

Include the **family** statement and specify the **mpls** option at the **[edit logical-systems Untrust interfaces xe-1/3/0 unit 0]** hierarchy level.

```
[edit logical-systems Untrust interfaces xe-1/3/0 unit 0]
user@mx# set family inet address 10.200.4.1/30
user@mx# set family mpls
```

Repeat this step for every 10-Gigabit Ethernet interface connected to the service provider network by using the appropriate interface name, logical interface number, IPv4 address, and logical system name.

4. Configure the Layer 3 IRB interface address.

This example configures the **unit 19** logical interface that participates in VLAN 19 with **10.19.2.1/24** as the IPv4 address under the logical system named **Untrust**.

Include the **address** statement and specify **10.19.2.1/24** as the IPv4 address at the **[edit logical-systems Untrust interfaces irb unit 19 family inet]** hierarchy level.

```
[edit logical-systems Untrust interfaces irb unit 19 family inet]
user@mx# set address 10.19.2.1/24
```

Repeat this step for every Layer 3 IRB interface by using the appropriate logical interface name and IPv4 address.

5. Configure an IP address for the loopback logical interface of the Logical System **Untrust**.

Include the **address** statement and specify **10.200.11.1/32** as the IPv4 address at the **[edit logical-systems Untrust interfaces lo0 unit 1 family inet]** hierarchy level.

```
[edit logical-systems Untrust interfaces lo0 unit 1 family inet]
user@mx# set address 10.200.11.1/32
```

Repeat this step for every MX Series device by using the appropriate IPv4 address.

### *Configuring VLANs in the Core Layer*

#### **Step-by-Step Procedure**

This procedure explains how to configure the VLAN names and tag IDs and associate interfaces and Layer 3 routing interfaces with each core interconnect VLAN. This procedure shows a representative sample of the configuration. The example does not show the configuration for every VLAN.

1. Configure the VLAN name and tag ID (number) for each core interconnect VLAN on the MX Series device.

This example configures a VLAN with the name **vlan14** and tag ID **14** in the Logical System **Untrust**.

Include the **vlan-id** statement and specify **14** as the VLAN ID at the **[edit logical-systems Untrust bridge-domains vlan14]** hierarchy level.

```
[edit logical-systems Untrust bridge-domains vlan14]
user@mx# set vlan-id 14
```

Repeat this step for every VLAN on each MX Series device by using the appropriate VLAN names and tag IDs.

- Associate the logical interfaces with each VLAN on the MX Series device.

This example associates logical interface **xe-0/3/0.14** that is connected to the other MX Series device and **xe-2/2/0.14** that is connected to the SRX Series device with **vlan14**.

Include the **interface** statement and specify **xe-0/3/0.14** at the **[edit logical-systems Untrust bridge-domains vlan14]** hierarchy level.

Include the **interface** statement and specify **xe-2/2/0.14** at the **[edit logical-systems Untrust bridge-domains vlan14]** hierarchy level.

```
[edit logical-systems Untrust bridge-domains vlan14]
user@mx# set interface xe-0/3/0.14
user@mx# set interface xe-2/2/0.14
```

Repeat this step for every core interconnect VLAN on each MX Series device by using the appropriate interface names.

- Associate a Layer 3 interface with each VLAN on the MX Series device.

This example associates the **irb.14** interface with **vlan14**.

Include the **routing-interface** statement and specify **irb.14** at the **[edit logical-systems Untrust bridge-domains vlan14]** hierarchy level.

```
[edit logical-systems Untrust bridge-domains vlan14]
user@mx# set routing-interface irb.14
```

Repeat this step for every core interconnect VLAN on each MX Series device by using the appropriate Layer 3 interface name.

### *Configuring Protocols in the Untrusted Logical System*

#### **Step-by-Step Procedure**

This procedure explains how to configure the BGP, MPLS, RSVP, and OSPF protocols for the Logical System Untrust. This procedure shows a representative sample of the configuration. The example does not show the configuration for every device.

- Add interfaces to the OSPF protocol on the MX Series device.

This example adds logical interfaces **xe-1/3/0.0** and **lo0.1** to the OSPF protocol used in the core network.

Include the **interface** statement and specify the **xe-1/3/0.0** and **lo0.1** interfaces at the **[edit logical-systems Untrust protocols ospf area 0.0.0.0]** hierarchy level.

```
[edit logical-systems Untrust protocols ospf area 0.0.0.0]
user@mx# set interface xe-1/3/0.0
user@mx# set interface lo0.1
```

Repeat this step for every 10-Gigabit Ethernet interface connected to the core layer devices by using the appropriate interface name.



2. Configure the Generic Router Encapsulation (GRE) tunnel.

This example enables a dynamic GRE tunnel named **GRE1**.

Include the **gre** statement to specify the tunnel type at the **[edit logical-systems Untrust routing-options dynamic-tunnel GRE1]** hierarchy level.

Include the **source-address** statement and specify **10.200.11.1** as the IPv4 source address at the **[edit logical-systems Untrust routing-options dynamic-tunnel GRE1]** hierarchy level.

Include the **destination-networks** statement and specify **0.0.0.0/0** as the destination prefix at the **[edit logical-systems Untrust routing-options dynamic-tunnel GRE1]** hierarchy level.

```
[edit logical-systems Untrust routing-options dynamic-tunnel GRE1]
user@mx# set source-address 10.200.11.1
user@mx# set gre
user@mx# set destination-networks 0.0.0.0/0
```

Repeat this step for each MX Series device by using the appropriate source address.

3. Configure the Logical System local autonomous system number and router identifier.

Include the **autonomous-system** statement and specify **65000** as the autonomous system number at the **[edit logical-systems Untrust routing-options]** hierarchy level.

Include the **router-id** statement and specify **10.200.11.101** as the router identifier at the **[edit logical-systems Untrust routing-options]** hierarchy level.

```
[edit logical-systems Untrust]
user@mx# set routing-options autonomous-system 65000
user@mx# set routing-options router-id 10.200.11.101
```

Repeat this step for each MX Series device by using the appropriate router identifier and autonomous system number 65000.

4. Configure the internal BGP peer group.

Include the **type** statement and specify the **internal** option at the **[edit logical-systems Untrust protocols bgp group int]** hierarchy level.

Include the **local-address** statement and specify the router ID (10.200.11.1) of Logical System Untrust as the local address at the **[edit logical-systems Untrust protocols bgp group int]** hierarchy level.

Include the **unicast** statement at the **[edit logical-systems Untrust protocols bgp group int family inet]** and **[edit logical-systems Untrust protocols bgp group int family inet-vpn]** hierarchy levels.

Include the **local-as** statement and specify **65000** as the local autonomous system number at the **[edit logical-systems Untrust protocols bgp group int]** hierarchy level.

Include the **peer-as** statement and specify **65000** as the peer autonomous system number at the **[edit logical-systems Untrust protocols bgp group int]** hierarchy level.

Include the **neighbor** statement and specify the neighbor IPv4 addresses at the **[edit logical-systems Untrust protocols bgp group int]** hierarchy level.

The neighbor addresses are the router ID addresses of the other MX Series device in the local data center, MX Series devices in a remote data center, and routers located in the IP-based/MPLS-based core network.

```
[edit logical-systems Untrust protocols bgp group int]
user@mx# set type internal
user@mx# set local-address 10.200.11.1
user@mx# set family inet unicast
user@mx# set family inet-vpn unicast
user@mx# set local-as 65000
user@mx# set peer-as 65000
user@mx# set neighbor 10.200.11.2
user@mx# set neighbor 10.200.11.3
user@mx# set neighbor 10.200.11.4
```

Repeat this step for every MX Series device.

5. Add interfaces to the MPLS protocol used in the service provider core network.

This example adds the **xe-1/3/0.0** and **xe-2/3/0.0** interfaces that are connected to the service provider core network.

Include the **interface** statement and specify the **xe-1/3/0.0** and **xe-2/3/0.0** interfaces at the **[edit logical-systems Untrust protocols mpls]** hierarchy level.

```
[edit logical-systems Untrust protocols mpls]
user@mx# set interface xe-1/3/0.0
user@mx# set interface xe-2/3/0.0
```

Repeat this step for every MX Series device.

6. Create an MPLS LSP to the router that is located in the MPLS-based core network.

This example creates an LSP named **to-core-router**.

Include the **to** statement and specify **10.200.11.3** as the IPv4 address of the core router at the **[edit logical-systems Untrust protocols mpls label-switched-path to-core-router]** hierarchy level.

Include the **no-cspf** statement at the **[edit logical-systems Untrust protocols mpls]** hierarchy level.

```
[edit logical-systems Untrust protocols mpls]
user@mx# set label-switched-path to-core-router to 10.200.11.3
user@mx# set no-cspf
```

Repeat this step for every MX Series device.

7. Add interfaces to the RSVP protocol used in the MPLS-based core network.

Include the **interface** statement and specify the **xe-1/3/0.0** and **xe-2/3/0.0** interfaces at the **[edit logical-systems Untrust protocols rsvp]** hierarchy level.

```
[edit logical-systems Untrust protocols rsvp]
user@mx# set interface xe-1/3/0.0
user@mx# set interface xe-2/3/0.0
```

Repeat this step for every MX Series device.

## Configuring the Security Device

The following procedures explain how to configure the redundant Ethernet interfaces, node cluster, security zones, security policies, and routing policies for the trusted security zone of the access layer.

- [Configuring the Redundant Ethernet Interface Link Aggregation Group on page 251](#)
- [Configuring the SRX Series Cluster on page 252](#)
- [Creating Security Zones and Configuring the In-Bound Traffic Policy Action on page 253](#)
- [Configuring the Security Zone Policies on page 254](#)
- [Creating the Routing Policies on page 256](#)
- [Configuring the Virtual Router Routing Instance on page 258](#)
- [Results on page 261](#)

### *Configuring the Redundant Ethernet Interface Link Aggregation Group*

#### Step-by-Step Procedure

This procedure explains how to configure the redundant Ethernet interface link aggregation group. This procedure shows a representative sample of the configuration. The example does not show the configuration for every interface.

1. Configure the number of aggregated Ethernet interfaces supported on the node.

This example enables support for two interfaces.

Include the **device-count** statement and specify **2** as the number of interfaces supported at the **[edit chassis aggregated-devices ethernet]** hierarchy level.

```
[edit chassis aggregated-devices ethernet]
user@srx# set device-count 2
```

Repeat this step for every SRX Series device by using the appropriate device count.

2. Assign 10-Gigabit Ethernet child interfaces to the redundant Ethernet (reth) parent interface.

This example assigns the **xe-1/0/0** 10-Gigabit Ethernet child interface to the **reth1** parent interface on Node0.

Include the **redundant-parent** statement and specify **reth1** as the parent interface at the **[edit interfaces xe-1/0/0 gigether-options]** hierarchy level.

```
[edit interfaces xe-1/0/0 gigether-options]
user@srx# set redundant-parent reth1
```

Repeat this step for every redundant Ethernet interface by using the appropriate interface name and redundant parent name.

3. Configure the redundant Ethernet parent interface options.

This example configures the **reth1** redundant parent interface.

Include the **redundancy-group** statement and specify **1** as the group number at the **[edit interfaces reth1 redundant-ether-options]** hierarchy level.

Include the **vlan-tagging** statement at the **[edit interfaces reth1]** hierarchy level.

```
[edit interfaces reth1]
user@srx# set redundant-ether-options redundancy-group 1
user@srx# set vlan-tagging
```

Repeat this step for every redundant parent interface by using the appropriate redundant parent name and redundancy group number.

4. Configure the redundant Ethernet parent logical interfaces.

This example configures the **unit 15** logical interface.

Include the **address** statement and specify **10.15.2.2/24** as the IPv4 address at the **[edit interfaces reth1 unit 15 family inet]** hierarchy level.

Include the **vlan-id** statement and specify **15** as the VLAN identifier at the **[edit interfaces reth1 unit 15]** hierarchy level.

```
[edit interfaces reth1 unit 15]
user@srx# set family inet address 10.15.2.2/24
user@srx# set vlan-id 15
```

Repeat this step for every redundant parent interface by using the appropriate redundant parent name, IPv4 address, and VLAN identifier.

### *Configuring the SRX Series Cluster*

#### **Step-by-Step Procedure**

This procedure explains how to configure fabric connections between the nodes in the cluster. This procedure shows a representative sample of the configuration. The example does not show the configuration for every interface.

1. Configure the 10-Gigabit Ethernet interface to serve as the fabric between the cluster nodes.

This example configures **xe-1/0/1** as the child fabric interface and **fab0** as the parent fabric interface. The connection is from SRX0 to SRX1.

Include the **member-interfaces** statement and specify the **xe-1/0/1** interface at the **[edit interfaces fab0 fabric-options]** hierarchy level.

```
[edit interfaces fab0 fabric-options]
user@srx# set member-interfaces xe-1/0/1
```

Repeat this step for every 10-Gigabit Ethernet interface that is part of the cluster fabric by using the appropriate child interface name and parent interface name.

2. Configure the number of redundant Ethernet interfaces that the cluster supports.

This example configures **4** as the number of interfaces.

Include the **reth-count** statement and specify **4** as the number of interfaces at the **[edit chassis cluster]** hierarchy level.

```
[edit chassis cluster]
user@srx# set reth-count 4
```

Repeat this step for every SRX Series device in the cluster.

3. Configure the node priority for the redundancy group to determine which node is primary and which is secondary.

This example configures **node 0** with a higher priority.

Include the **priority** statement and specify **200** at the **[edit chassis cluster redundancy-group 1 node 0]** hierarchy level.

Include the **priority** statement and specify **100** at the **[edit chassis cluster redundancy-group 1 node 1]** hierarchy level.

```
[edit chassis cluster redundancy-group 1]
user@srx# set node 0 priority 200
user@srx# set node 1 priority 100
```

Repeat this step for every redundancy group on every SRX Series device in the cluster.

4. Allow a node with a higher priority to initiate a failover to become the primary node for the redundancy group.

Include the **preempt** statement at the **[edit chassis cluster redundancy-group 1]** hierarchy level.

```
[edit chassis cluster redundancy-group 1]
user@srx# set preempt
```

Repeat this step for every redundancy group on every SRX Series device in the cluster.

5. Enable control link recovery to be done automatically.

Include the **control-link-recovery** statement at the **[edit chassis cluster]** hierarchy level.

```
[edit chassis cluster]
user@srx# set control-link-recovery
```

Repeat this step for every redundancy group on every SRX Series device in the cluster.

6. Enable interface monitoring to monitor the health of the interfaces and trigger redundancy group failover.

This example configures the **xe-1/0/0** interface with a weight of **255**.

Include the **weight** statement at the **[edit chassis cluster redundancy-group 1 interface-monitor xe-1/0/0]** hierarchy level.

```
[edit chassis cluster redundancy-group 1 interface-monitor xe-1/0/0]
user@srx# set weight 255
```

Repeat this step for every redundancy group interface on every SRX Series device in the cluster.

### ***Creating Security Zones and Configuring the In-Bound Traffic Policy Action***

#### **Step-by-Step Procedure**

This procedure explains how to configure the trusted and untrusted security zones on the SRX Series device. This procedure shows a representative sample of the configuration. The example does not show the configuration for every zone.

1. Assign a redundant Ethernet logical interface to a trusted zones.

This example assigns the **reth1.15** interface to the **Trust2** zone.

Include the **interfaces** statement and specify **reth1.15** as the interface in the zone at the **[edit security zones security-zone Trust2]** hierarchy level.

```
[edit security zones security-zone Trust2]
user@srx# set interfaces reth1.15
```

Repeat this step for every trusted security zone by using the appropriate zone name and redundant Ethernet logical interface name.

2. Assign a redundant Ethernet logical interface to the untrusted zones.

This example assigns the **reth2.19** interface to the **Untrust2** zone.

Include the **interfaces** statement and specify **reth2.19** as the interface in the zone at the **[edit security zones security-zone Untrust2]** hierarchy level.

```
[edit security zones security-zone Untrust2]
user@srx# set interfaces reth2.19
```

Repeat this step for every untrusted security zone by using the appropriate zone name and redundant Ethernet logical interface name.

3. Enable all inbound system services traffic in the trusted security zone.

This example enables all services for the **Trust2** zone.

Include the **system-services** statement and specify the **all** option at the **[edit security zones security-zone Trust2 host-inbound-traffic]** hierarchy level.

```
[edit security zones security-zone Trust2 host-inbound-traffic]
user@srx# set system-services all
```

Repeat this step for every security zone on the SRX Series device where system services are allowed.

4. Enable all protocols for inbound traffic in the trusted security zone.

This example enables all protocols for the **Trust2** zone.

Include the **protocols** statement and specify the **all** option at the **[edit security zones security-zone Trust2 host-inbound-traffic]** hierarchy level.

```
[edit security zones security-zone Trust2 host-inbound-traffic]
user@srx# set protocols all
```

Repeat this step for every security zone on the SRX Series device where all protocols are allowed for inbound traffic.

### **Configuring the Security Zone Policies**

#### **Step-by-Step Procedure**

This procedure explains how to configure the security zone policies on the SRX Series device. This procedure shows a representative sample of the configuration. The example does not show the configuration for every policy.

1. Define which zone traffic is coming from and which zone traffic is going to for the policy being created.

This example defines the from zone as **Trust2** and the to zone as **Untrust2**.

On a single command line, include the **from-zone** statement and specify **Trust2**, include the **to-zone** statement and specify **Untrust2**, include the **policy** statement and specify **denyftp** as the policy name, and included the **match** statement at the **[edit security policies]** hierarchy level.

```
[edit security policies]
user@srx# set from-zone Trust2 to-zone Untrust2 policy denyftp match
```

Repeat this step for every policy that controls traffic between zones.

2. Configure the policy match criteria for denying traffic.

This example matches the Junos OS FTP application from any source to any destination address in a policy named **denyftp**.

Include the **source-address** statement and specify **any** as the IPv4 address at the **[edit security policies from-zone Trust2 to-zone Untrust2 policy denyftp match]** hierarchy level.

Include the **destination-address** statement and specify **any** as the IPv4 address at the **[edit security policies from-zone Trust2 to-zone Untrust2 policy denyftp match]** hierarchy level.

Include the **application** statement and specify **junos-ftp** as the application at the **[edit security policies from-zone Trust2 to-zone Untrust2 policy denyftp match]** hierarchy level.

```
[edit security policies from-zone Trust2 to-zone Untrust2 policy denyftp match]
user@srx# set source-address any
user@srx# set destination-address any
user@srx# set application junos-ftp
```

Repeat this step for every protocol matching policy by using the correct protocol.

3. Block specific applications from passing from the Trust2 zone to the Untrust2 zone.

This example denies the Junos OS FTP application from the **Trust2** zone to the **Untrust2** zone.

Include the **deny** statement at the **[edit security policies from-zone Trust2 to-zone Untrust2 policy denyftp then]** hierarchy level.

```
[edit security policies from-zone Trust2 to-zone Untrust2 policy denyftp then]
user@srx# set deny
```

Repeat this step for every deny policy.

4. Configure the policy match criteria for allowing traffic.

This example matches any application from any source to any destination address in a policy named **allow\_all**.

Include the **source-address** statement and specify **any** as the IPv4 address at the **[edit security policies from-zone Trust2 to-zone Untrust2 policy allow\_all match]** hierarchy level.

Include the **destination-address** statement and specify **any** as the IPv4 address at the **[edit security policies from-zone Trust2 to-zone Untrust2 policy allow\_all match]** hierarchy level.

Include the **application** statement and specify **any** as the application at the **[edit security policies from-zone Trust2 to-zone Untrust2 policy allow\_all match]** hierarchy level.

```
[edit security policies from-zone Trust2 to-zone Untrust2 policy allow_all match]
user@srx# set source-address any
user@srx# set destination-address any
user@srx# set application any
```

Repeat this step for every application matching policy.

5. Permit any application traffic to pass from the Trust2 zone to the Untrust2 zone.

This example allows any application traffic from the **Trust2** zone to the **Untrust2** zone.

Include the **permit** statement at the **[edit security policies from-zone Trust2 to-zone Untrust2 policy allow\_all then]** hierarchy level.

```
[edit security policies from-zone Trust2 to-zone Untrust2 policy allow_all then]
user@srx# set permit
```

Repeat this step for every permit policy.

### *Creating the Routing Policies*

#### **Step-by-Step Procedure**

This procedure explains how to create the routing policies on the SRX Series device that can be applied to the appropriate routing instances. This procedure shows a representative sample of the configuration. The example does not show the configuration for every policy.

1. Create a policy to set the local preference for BGP routes to 120.

This example creates a policy named **local-pref-120** that sets the BGP local preference value for received routes advertised by BGP to 120.

Include the **protocol** statement and specify **bgp** as the value at the **[edit policy-options policy-statement local-pref-120 term term1 from]** hierarchy level.

Include the **local-preference** statement and specify **120** as the value at the **[edit policy-options policy-statement local-pref-120 term term1 then]** hierarchy level.

```
[edit policy-options policy-statement local-pref-120]
user@srx# set term term1 from protocol bgp
user@srx# set term term1 then local-preference 120
```

Repeat this step for each SRX Series device.

2. Configure the match criteria for a policy named **default-ospf** to accept all aggregate (generated) routes.

Include the **protocol** statement and specify **aggregate** as the protocol to match at the **[edit policy-options policy-statement default-ospf term term1 from]** hierarchy level.

Include the **route-filter** statement and specify **0.0.0.0/0 exact** as the match criteria at the **[edit policy-options policy-statement default-ospf term term1 from]** hierarchy level.



```
[edit policy-options policy-statement default-ospf term term1 from]
user@srx# set protocol aggregate
user@srx# set route-filter 0.0.0.0/0 exact
```

Repeat this step for each SRX Series device.

3. Configure the action for a policy to set the metric to **0**, and set the external route type to **1**.

This example configures a policy named **default-ospf** that sets the metric to **0**, sets the external route to type **1**, and accepts aggregate routes into the routing table.

Include the **metric** statement and specify **0** as the external type at the **[edit policy-options policy-statement default-ospf term term1 then]** hierarchy level.

Include the **type** statement and specify **1** as the external route type at the **[edit policy-options policy-statement default-ospf term term1 then external]** hierarchy level.

Include the **accept** statement at the **[edit policy-options policy-statement default-ospf term term1 then]** hierarchy level.

```
[edit policy-options policy-statement default-ospf term term1 then]
user@srx# set metric 0
user@srx# set external type 1
user@srx# set accept
```

Repeat this step for each SRX Series device.

4. Create a policy that accepts OSPF routes with specified prefixes.

This example creates a policy named **trust2-ebgp-out** that accepts OSPF routes with the route prefixes that correspond to the subnets for each trust VLAN.

Include the **protocol** statement and specify **ospf** as the protocol at the **[edit policy-options policy-statement trust2-ebgp-out term term1 from]** hierarchy level.

Include the **route-filter** statement and specify the VLAN subnet addresses and the **exact** match keyword at the **[edit policy-options policy-statement trust2-ebgp-out term term1 from]** hierarchy level.

Include the **accept** statement at the **[edit policy-options policy-statement trust2-ebgp-out term term1 then]** hierarchy level.

```
[edit policy-options policy-statement trust2-ebgp-out term term1]
user@srx# set from protocol ospf
user@srx# set from route-filter 10.16.2.0/24 exact
user@srx# set from route-filter 10.17.2.0/24 exact
user@srx# set from route-filter 10.18.2.0/24 exact
user@srx# set then accept
```

Repeat this step for each SRX Series device.

5. Create a policy that accepts BGP routes if the route type is external.

This example creates a policy named **check-bgp-routes** that accepts BGP routes only if the route type is external.

Include the **protocol** statement and specify **bgp** as the protocol at the **[edit policy-options policy-statement check-bgp-routes term term1 from]** hierarchy level.

Include the **route-type** statement and specify the **external** option at the **[edit policy-options policy-statement check-bgp-routes term term1 from]** hierarchy level.

Include the **accept** statement at the **[edit policy-options policy-statement check-bgp-routes term term1 then]** hierarchy level.

```
[edit policy-options policy-statement check-bgp-routes term term1]
user@srx# set from protocol bgp
user@srx# set from route-type external
user@srx# set then accept
```

Repeat this step for each SRX Series device.

6. Create a policy that accepts routes from other virtual router routing instances.

This example creates a policy named **from\_srx\_vr1** that accepts routes from routing instance **SRX-VR1**.

Include the **instance** statement and specify **SRX-VR1** as the routing instance name at the **[edit policy-options policy-statement from\_srx\_vr1 term term1 from]** hierarchy level.

Include the **accept** statement at the **[edit policy-options policy-statement from\_srx\_vr1 term term1 then]** hierarchy level.

```
[edit policy-options policy-statement from_srx_vr1 term term1]
user@srx# set from instance SRX-VR1
user@srx# set then accept
```

Repeat this step for each virtual router in each SRX Series device.

### *Configuring the Virtual Router Routing Instance*

#### **Step-by-Step Procedure**

This procedure explains how to configure a single virtual router routing instance. This procedure shows a representative sample of the example configuration. The example does not show the configuration for every virtual router routing instance.

1. Configure the routing instance type.

This example configures the routing instance with the name **SRX-VR2**.

Include the **instance-type** statement and specify **virtual-router** as the type at the **[edit routing-instances SRX-VR2]** hierarchy level.

```
[edit routing-instances SRX-VR2]
user@srx# set instance-type virtual-router
```

Repeat this step for every virtual router in each SRX Series device by using the appropriate virtual router name.

2. Add the redundant Ethernet interfaces used by the virtual router routing instance.

This example adds **reth1.15** and **reth2.19** interfaces to the **SRX-VR2** routing instance.

Include the **interface** statement and specify the name of the redundant Ethernet interface at the **[edit routing-instances SRX-VR2]** hierarchy level.

```
[edit routing-instances SRX-VR2]
user@srx# set interface reth1.15
```

```
user@srx# set interface reth2.19
```

Repeat this step for every virtual router in each SRX Series device by using the appropriate virtual router name and interface names.

3. Configure the routing options used by the virtual router routing instance.

This example configures the autonomous system number and enables the graceful restart feature on the **SRX-VR2** routing instance.

Include the **autonomous-system** statement and specify **65019** as the autonomous system number at the **[edit routing-instances SRX-VR2 routing-options]** hierarchy level.

Include the **graceful-restart** statement at the **[edit routing-instances SRX-VR2 routing-options]** hierarchy level.

```
[edit routing-instances SRX-VR2 routing-options]
user@srx# set autonomous-system 65019
user@srx# set graceful-restart
```

Repeat this step for every virtual router in each SRX Series device by using the appropriate virtual router name and interface names.

4. Apply the routing policy that accepts external BGP routes and uses them as generated routes for the routing instance.

This example applies the policy named **check-bgp-routes** to the **SRX-VR2** routing instance.

Include the **policy** statement and specify **check-bgp-routes** at the **[edit routing-instances SRX-VR2 routing-options generate route 0.0.0.0/0]** hierarchy level.

Include the **graceful-restart** statement at the **[edit routing-instances SRX-VR2 routing-options]** hierarchy level.

```
[edit routing-instances SRX-VR2 routing-options]
user@srx# set generate route 0.0.0.0/0 policy
user@srx# set graceful-restart
```

Repeat this step for every virtual router in each SRX Series device by using the appropriate virtual router name and interface names.

5. Apply the routing policy that accepts routes from other routing instances.

This example applies the policy named **from\_srx\_vr1** to the **SRX-VR2** routing instance.

Include the **instance-import** statement and specify **from\_srx\_vr1** at the **[edit routing-instances SRX-VR2 routing-options]** hierarchy level.

```
[edit routing-instances SRX-VR2 routing-options]
user@srx# set instance-import from_srx_vr1
```

Repeat this step for every virtual router in each SRX Series device except the **SRX-VR1** instance.

6. Configure the IGP protocol export policy used by the virtual router routing instance in the trusted security zone.

This example configures the **default-ospf** policy.

Include the **export** statement and specify **default-ospf** as the policy name at the **[edit routing-instances SRX-VR2 protocols ospf]** hierarchy level.

```
[edit routing-instances SRX-VR2 protocols ospf]
user@srx# set export default-ospf
```

Repeat this step for every virtual router in each SRX Series device by using the appropriate virtual router name and policy name.

7. Configure the IGP protocol active and passive interfaces used by the virtual router routing instance in the trusted security zone.

This example configures the **reth1.15** redundant Ethernet interface to actively participate in the OSPF protocol area 0.0.0.0, and the **reth2.19** redundant Ethernet interface to passively participate.

Include the **interface** statement and specify **reth1.15** at the **[edit routing-instances SRX-VR2 protocols ospf area 0.0.0.0]** hierarchy level.

Include the **interface** statement and specify **reth2.19** at the **[edit routing-instances SRX-VR2 protocols ospf area 0.0.0.0]** hierarchy level.

Include the **passive** statement at the **[edit routing-instances SRX-VR2 protocols ospf area 0.0.0.0 reth2.19]** hierarchy level.

```
[edit routing-instances SRX-VR2 protocols ospf area 0.0.0.0]
user@srx# set interface reth1.15
user@srx# set interface reth2.19 passive
```

Repeat this step for every virtual router in each SRX Series device by using the appropriate virtual router name and interface names.

8. Configure the BGP protocol peer groups used by the virtual router routing instance in the untrusted security zone.

Include the **type** statement and specify the **external** option at the **[edit routing-instances SRX-VR2 protocols bgp group MX0-vrf]** hierarchy level.

Include the **peer-as** statement and specify **65000** as the peer autonomous system number at the **[edit routing-instances SRX-VR2 protocols bgp group MX0-vrf]** hierarchy level.

Include the **neighbor** statement and specify **10.19.2.1** as the IPv4 neighbor address at the **[edit routing-instances SRX-VR2 protocols bgp group MX0-vrf]** hierarchy level. The neighbor address is the IRB Logical interface address of the VRF routing instance on the MX Series device.

```
[edit routing-instances SRX-VR2 protocols bgp group MX0-vrf]
user@srx# set type external
user@srx# set peer-as 65000
user@srx# set neighbor 10.19.2.1
```

Repeat this step for every virtual router in each SRX Series device by using the appropriate virtual router name, instance type, neighbor address, and peer AS number.

9. Configure the BGP protocol peer groups export and import policies used by the virtual router routing instance in the untrusted security zone.

Include the **export** statement and specify **trust2-ebgp-out** as the export policy name at the **[edit routing-instances SRX-VR2 protocols bgp group MX0-vrf]** hierarchy level.

Include the **import** statement and specify **local-pref-120** as the import policy name at the **[edit routing-instances SRX-VR2 protocols bgp group MX0-vrf]** hierarchy level.

```
[edit routing-instances SRX-VR2 protocols bgp group MX0-vrf]
user@srx# set export trust2-ebgp-out
user@srx# set import local-pref-120
```

Repeat this step for every virtual router in each SRX Series device by using the appropriate virtual router name, export policy, and import policy.

The configuration steps of this example have been completed. The following section is for your reference.

The relevant sample configuration for the EX Series device follows.

```
EX Series Device system {
 scripts {
 commit {
 allow-transients;
 file jais-activate-scripts.slax {
 optional;
 }
 }
 }
 services {
 ftp;
 ssh;
 telnet;
 outbound-ssh {
 client 00187D0B670D {
 device-id FA022D;
 secret "9-9w4aik.QznDj9A0BEhrlKMxN"; ## SECRET-DATA
 services netconf;
 10.8.7.32 port 7804;
 }
 }
 }
 }
 interfaces {
 ge-0/0/17 {
 unit 0 {
 family ethernet-switching {
 vlan {
 members 17;
 }
 }
 }
 }
 }
 xe-0/1/0 {
 unit 0 {
 family ethernet-switching {
 port-mode trunk;
 vlan {
```

```
 members all;
 }
}
}
xe-0/1/2 {
 unit 0 {
 enable;
 family ethernet-switching {
 port-mode trunk;
 vlan {
 members all;
 }
 }
 }
}
lo0 {
 unit 0 {
 family inet {
 address 127.0.0.1/32;
 }
 }
}
me0 {
 unit 0 {
 family inet {
 address 10.8.108.19/24;
 }
 }
}
}
event-options {
 destinations {
 juniper-aim {
 archive-sites {
 "scp://admin@127.0.0.1://var/tmp" password "9u3KW0EcrevL7-eKaZ"; ##
 SECRET-DATA
 }
 }
 }
}
routing-options {
 static {
 route 10.8.0.0/16 next-hop 10.8.108.254;
 }
}
protocols {
 rstp {
 interface xe-0/1/0.0 {
 disable;
 }
 interface xe-0/1/2.0 {
 disable;
 }
 }
}
}
```

```

security {
 ssh-known-hosts {
 host 127.0.0.1 {
 rsa-key AAAAB3NzaC1yc2;
 }
 }
}
ethernet-switching-options {
 redundant-trunk-group {
 group rtgroup1 {
 interface xe-0/1/0.0;
 interface xe-0/1/2.0 {
 primary;
 }
 }
 }
}
vlangs {
 vlan17 {
 vlan-id 17;
 interface {
 xe-0/1/0.0;
 xe-0/1/2.0;
 }
 }
}

```

The relevant sample configuration for the MX Series device follows.

```

MX Series Device groups {
 re0 {
 system {
 host-name MX0;
 }
 }
 re1 {
 system {
 host-name MX0re1;
 }
 }
 }
 apply-groups [re0 re1];
 system {
 scripts {
 commit {
 allow-transients;
 file jais-activate-scripts.slax {
 optional;
 }
 }
 }
 }
 login {
 class trust1-admin {
 logical-system Trust1;
 permissions all;
 }
 }

```

```
user trust1 {
 uid 2000;
 class trust1-admin;
 authentication {
 encrypted-password 12345; ## SECRET-DATA
 }
}
}
}
logical-systems {
 Trust1 {
 interfaces {
 xe-0/1/0 {
 unit 17 {
 encapsulation vlan-bridge;
 vlan-id 17;
 }
 }
 xe-1/0/0 {
 unit 17 {
 encapsulation vlan-bridge;
 vlan-id 17;
 }
 }
 xe-1/1/0 {
 unit 15 {
 encapsulation vlan-bridge;
 vlan-id 15;
 }
 }
 }
 irb {
 unit 15 {
 family inet {
 address 10.15.2.3/24;
 }
 }
 unit 17 {
 family inet {
 address 10.17.2.2/24 {
 vrrp-group 17 {
 virtual-address 10.17.2.1;
 priority 200;
 fast-interval 200;
 preempt;
 accept-data;
 }
 }
 }
 }
 }
 }
}
routing-instances {
 MX-VR2 {
 instance-type virtual-router;
 interface irb.15;
 interface irb.16;
 }
}
```



```

interface irb.17;
interface irb.18;
interface irb.1002;
protocols {
 ospf {
 area 0.0.0.0 {
 interface irb.16 {
 passive;
 }
 interface irb.17 {
 passive;
 }
 interface irb.18 {
 passive;
 }
 interface irb.1002 {
 passive;
 }
 }
 }
}
bridge-domains {
 vlan15 {
 vlan-id 15;
 interface xe-1/1/0.15;
 interface xe-0/1/0.15; ## 'xe-0/1/0.15' is not defined
 routing-interface irb.15;
 }
 vlan17 {
 vlan-id 17;
 interface xe-1/0/0.17;
 interface xe-0/1/0.17;
 routing-interface irb.17;
 }
}
Untrust {
 interfaces {
 xe-0/3/0 {
 unit 19 {
 encapsulation vlan-bridge;
 vlan-id 19;
 }
 }
 xe-1/3/0 {
 unit 0 {
 family inet {
 address 10.200.4.1/30;
 }
 family mpls;
 }
 }
 xe-2/2/0 {
 unit 19 {

```

```
 encapsulation vlan-bridge;
 vlan-id 19;
 }
}
irb {
 unit 19 {
 family inet {
 address 10.19.2.1/24;
 }
 }
}
lo0 {
 unit 1 {
 family inet {
 address 10.200.11.1/32;
 }
 }
}
}
protocols {
 rsvp {
 interface xe-1/3/0.0;
 interface xe-2/3/0.0;
 }
 mpls {
 no-cspf;
 label-switched-path to-core-router {
 to 10.200.11.3;
 }
 interface xe-1/3/0.0;
 interface xe-2/3/0.0;
 }
 bgp {
 group int {
 type internal;
 local-address 10.200.11.1;
 family inet {
 unicast;
 }
 family inet-vpn {
 unicast;
 }
 peer-as 65000;
 local-as 65000;
 neighbor 10.200.11.2;
 neighbor 10.200.11.3;
 neighbor 10.200.11.4;
 }
 }
 ospf {
 area 0.0.0.0 {
 interface xe-1/3/0.0;
 interface lo0.1;
 }
 }
}
}
```

```
routing-options {
 router-id 10.200.11.101;
 autonomous-system 65000;
 dynamic-tunnels {
 GRE1 {
 source-address 10.200.11.1;
 gre;
 destination-networks {
 0.0.0.0/0;
 }
 }
 }
}
bridge-domains {
 vlan14 {
 vlan-id 14;
 interface xe-0/3/0.14;
 interface xe-2/2/0.14;
 routing-interface irb.14;
 }
}
}
}
interfaces {
 xe-0/1/0 {
 flexible-vlan-tagging;
 encapsulation flexible-ethernet-services;
 }
 xe-0/3/0 {
 flexible-vlan-tagging;
 encapsulation flexible-ethernet-services;
 }
 xe-1/0/0 {
 flexible-vlan-tagging;
 encapsulation flexible-ethernet-services;
 }
 xe-1/1/0 {
 flexible-vlan-tagging;
 encapsulation flexible-ethernet-services;
 }
 xe-2/2/0 {
 flexible-vlan-tagging;
 encapsulation flexible-ethernet-services;
 }
 fxp0 {
 unit 0 {
 family inet {
 address 10.8.3.212/24;
 }
 }
 }
}
lo0 {
 unit 0 {
 family inet;
 }
}
}
```

```

}
event-options {
 destinations {
 juniper-aim {
 archive-sites {
 "scp://admin@127.0.0.1://var/tmp" password "9DyimfQFnCpOF3re"; ##
 SECRET-DATA
 }
 }
 }
}
routing-options {
 static {
 route 10.0.244.8/30 next-hop 10.0.134.10;
 route 10.0.0.0/8 {
 next-hop 10.8.3.254;
 retain;
 no-readvertise;
 }
 }
}
}

```

The relevant sample configuration for the SRX Series device follows.

```

SRX Series Device system {
 host-name srx0;
 chassis {
 cluster {
 control-link-recovery;
 reth-count 4;
 redundancy-group 1 {
 node 0 priority 200;
 node 1 priority 100;
 preempt;
 interface-monitor {
 xe-1/0/0 weight 255;
 }
 }
 }
 }
 }
 interfaces {
 xe-1/0/0 {
 gigger-options {
 redundant-parent reth1;
 }
 }
 fab0 {
 fabric-options {
 member-interfaces {
 xe-1/0/1;
 }
 }
 }
 lo0 {
 unit 0 {

```

```
 family inet {
 address 127.0.0.1/32;
 }
 }
}
reth1 {
 vlan-tagging;
 redundant-ether-options {
 redundancy-group 1;
 }
 unit 15 {
 family inet {
 address 10.15.2.2/24;
 }
 vlan-id 15;
 }
}
}
policy-options {
 policy-statement check-bgp-routes {
 term term1 {
 from {
 protocol bgp;
 route-type external;
 }
 then accept;
 }
 }
 policy-statement default-ospf {
 term term1 {
 from {
 protocol aggregate;
 route-filter 0.0.0.0/0 exact;
 }
 then {
 metric 0;
 external {
 type 1;
 }
 }
 accept;
 }
 }
}
 policy-statement from_srx_vr1 {
 term term1 {
 from instance SRX-VR1;
 then accept;
 }
 }
}
 policy-statement local-pref-120 {
 term term1 {
 from protocol bgp;
 then {
 local-preference 120;
 }
 }
 }
}
```

```
}
policy-statement trust2-ebgp-out {
 term term1 {
 from {
 protocol ospf;
 route-filter 10.16.2.0/24 exact;
 route-filter 10.17.2.0/24 exact;
 route-filter 10.18.2.0/24 exact;
 }
 then accept;
 }
}
}
}
security {
 policies {
 from-zone Trust2 to-zone Untrust2 {
 policy denyftp {
 match {
 source-address any;
 destination-address any;
 application junos-ftp;
 }
 then {
 deny;
 }
 }
 policy allow_all {
 match {
 source-address any;
 destination-address any;
 application any;
 }
 then {
 permit;
 }
 }
 }
 }
}
zones {
 security-zone Trust2 {
 host-inbound-traffic {
 system-services {
 all;
 }
 protocols {
 all;
 }
 }
 interfaces {
 reth1.15;
 }
 }
 security-zone Untrust2 {
 interfaces reth2.19;
 }
}
}
```

```
}
routing-instances {
 SRX-VR2 {
 instance-type virtual-router;
 interface reth1.15;
 interface reth2.19;
 routing-options {
 graceful-restart;
 autonomous-system 65019;
 instance-import from_srx_vr1;
 }
 protocols {
 bgp {
 group MX0-vrf {
 import local-pref-120;
 export trust2-ebgp-out;
 }
 }
 ospf {
 export default-ospf;
 area 0.0.0.0 {
 interface reth1.15;
 interface reth2.19 {
 passive;
 }
 }
 }
 }
 }
}
}
```

**Related Documentation**

- [Introduction to Logical Systems on page 3](#)





# Configuration Statements

- [\[edit logical-systems\] Hierarchy Level on page 273](#)

## [\[edit logical-systems\] Hierarchy Level](#)

---

As indicated in the following hierarchy, you can include at this hierarchy level several of the hierarchies that can be included at the **[edit]** hierarchy level. However, some statements in a subhierarchy are not valid for logical systems. To learn which statements can be included under **[edit logical-systems logical-system-name]** on your device, issue the **set ?** command at the hierarchy level of interest.

```

logical-systems {
 logical-system-name {
 access {
 address-assignment {
 ... same statements as in the address-assignment subhierarchy in [edit access]
 Hierarchy Level ...
 }
 }
 access-profile profile-name;
 bridge-domains {
 ... (MX Series only) same statements as in [edit bridge-domains] Hierarchy Level ...
 }
 bridge-domains {
 ... (MX Series only) same statements as in [edit bridge-domains] Hierarchy Level ...
 }
 firewall {
 ... same statements as in several subhierarchies in [edit firewall] Hierarchy Level ...
 }
 forwarding-options {
 ... same statements as in [edit forwarding-options dhcp-relay] Hierarchy Level ...
 }
 interfaces {
 interface-name {
 unit logical-unit-number {
 ... some of the statements in the unit subhierarchy in [edit interfaces] Hierarchy
 Level ...
 }
 }
 }
 policy-options {
 ... same statements as in [edit policy-options] Hierarchy Level ...
 }
 }
}

```



## PART 3

# Administration

- [Operational Commands on page 277](#)



# Operational Commands

- [Operational-Mode Commands on page 277](#)

## Operational-Mode Commands

---

- [Overview of Junos OS CLI Operational Mode Commands on page 277](#)
- [Example: Running Operational-Mode Commands on Logical Systems on page 280](#)
- [Example: Viewing BGP Trace Files on Logical Systems on page 281](#)
- [Example: Configuring System Logging on Logical Systems on page 286](#)

## Overview of Junos OS CLI Operational Mode Commands

This topic provides an overview of Junos OS CLI operational mode commands and contains the following sections:

- [CLI Command Categories on page 277](#)
- [Commonly Used Operational Mode Commands on page 278](#)

### CLI Command Categories

---

When you log in to a device running Junos OS and the CLI starts, there are several broad groups of CLI commands:

- **Commands for controlling the CLI environment**—Some set commands in the **set** hierarchy configure the CLI display screen. For information about these commands, see *Understanding the Junos OS CLI Modes, Commands, and Statement Hierarchies*.
- **Commands for monitoring and troubleshooting**—The following commands display information and statistics about the software and test network connectivity. Detailed command descriptions are provided in the *Junos OS Interfaces Command Reference*.
  - **clear**—Clear statistics and protocol database information.
  - **mtrace**—Trace mtrace packets from source to receiver.
  - **monitor**—Perform real-time debugging of various software components, including the routing protocols and interfaces.
  - **ping**—Determine the reachability of a remote network host.

- **show**—Display the current configuration and information about interfaces, routing protocols, routing tables, routing policy filters, system alarms, and the chassis.
- **test**—Test the configuration and application of policy filters and autonomous system (AS) path regular expressions.
- **traceroute**—Trace the route to a remote network host.
- Commands for connecting to other network systems—The **ssh** command opens Secure Shell connections, and the **telnet** command opens telnet sessions to other hosts on the network. For information about these commands, see the Junos OS Operational Mode Commands.
- Commands for copying files—The **copy** command copies files from one location on the router or switch to another, from the router or switch to a remote system, or from a remote system to the router or switch. For information about these commands, see the Junos OS Operational Mode Commands.
- Commands for restarting software processes—The commands in the **restart** hierarchy restart the various Junos OS processes, including the routing protocol, interface, and SNMP. For information about these commands, see the Junos OS Operational Mode Commands.
- A command—**request**—for performing system-level operations, including stopping and rebooting the router or switch and loading Junos OS images. For information about this command, see the Junos OS Operational Mode Commands.
- A command—**start**—to exit the CLI and start a UNIX shell. For information about this command, see the Junos OS Operational Mode Commands.
- A command—**configure**—for entering configuration mode, which provides a series of commands that configure Junos OS, including the routing protocols, interfaces, network management, and user access. For information about the CLI configuration commands, see Understanding Junos OS CLI Configuration Mode.
- A command—**quit**—to exit the CLI. For information about this command, see the Junos OS Operational Mode Commands.
- For more information about the CLI operational mode commands, see the Junos OS Operational Mode Commands and the Junos OS Operational Mode Commands.

### Commonly Used Operational Mode Commands

Table 6 on page 279 lists some operational commands you may find useful for monitoring router or switch operation. For a complete description of operational commands, see the Junos OS command references.



**NOTE:** The QFX3500 switch does not support the IS-IS, OSPF, BGP, MPLS, and RSVP protocols.

Table 6: Commonly Used Operational Mode Commands

| Items to Check               | Description                                                                               | Command                               |
|------------------------------|-------------------------------------------------------------------------------------------|---------------------------------------|
| Software version             | Versions of software running on the router or switch                                      | <b>show version</b>                   |
| Log files                    | Contents of the log files                                                                 | <b>monitor</b>                        |
|                              | Log files and their contents and recent user logins                                       | <b>show log</b>                       |
| Remote systems               | Host reachability and network connectivity                                                | <b>ping</b>                           |
|                              | Route to a network system                                                                 | <b>tracert</b>                        |
| Configuration                | Current system configuration                                                              | <b>show configuration</b>             |
| Manipulate files             | List of files and directories on the router or switch                                     | <b>file list</b>                      |
|                              | Contents of a file                                                                        | <b>file show</b>                      |
| Interface information        | Detailed information about interfaces                                                     | <b>show interfaces</b>                |
| Chassis                      | Chassis alarm status                                                                      | <b>show chassis alarms</b>            |
|                              | Information currently on craft display                                                    | <b>show chassis craft-interface</b>   |
|                              | Router or switch environment information                                                  | <b>show chassis environment</b>       |
|                              | Hardware inventory                                                                        | <b>show chassis hardware</b>          |
| Routing table information    | Information about entries in the routing tables                                           | <b>show route</b>                     |
| Forwarding table information | Information about data in the kernel's forwarding table                                   | <b>show route forwarding-table</b>    |
| IS-IS                        | Adjacent routers or switches                                                              | <b>show isis adjacency</b>            |
| OSPF                         | Display standard information about OSPF neighbors                                         | <b>show ospf neighbor</b>             |
| BGP                          | Display information about BGP neighbors                                                   | <b>show bgp neighbor</b>              |
| MPLS                         | Status of interfaces on which MPLS is running                                             | <b>show mpls interface</b>            |
|                              | Configured LSPs on the router or switch, as well as all ingress, transit, and egress LSPs | <b>show mpls lsp</b>                  |
|                              | Routes that form a label-switched path                                                    | <b>show route label-switched-path</b> |

Table 6: Commonly Used Operational Mode Commands (*continued*)

| Items to Check | Description                                   | Command                     |
|----------------|-----------------------------------------------|-----------------------------|
| RSVP           | Status of interfaces on which RSVP is running | <b>show rsvp interface</b>  |
|                | Currently active RSVP sessions                | <b>show rsvp session</b>    |
|                | RSVP packet and error counters                | <b>show rsvp statistics</b> |

### Example: Running Operational-Mode Commands on Logical Systems

This example shows how to set the CLI to a specified logical system view, run operational-mode commands for the logical system, and then return to the main router view.

- [Requirements on page 280](#)
- [Overview on page 280](#)
- [Configuration on page 280](#)

#### Requirements

You must have the **view** privilege for the logical system.

#### Overview

For some operational-mode commands, you can include a **logical-system** option to narrow the output of the command or to limit the operation of the command to the specified logical system. For example, the **show route** command has a **logical-system** option. To run this command on a logical system called LS3, you can use **show route logical-system LS3**. However, some commands, such as **show interfaces**, do not have a **logical-system** option. For commands like this, you need another approach.

You can place yourself into the context of a specific logical system. To configure a logical system context, issue the **set cli logical-system *logical-system-name*** command.

When the CLI is in logical system context mode and you enter an operational-mode command, the output of the command displays information related to the logical system only.

#### Configuration

##### Step-by-Step Procedure

The following example requires you to navigate various levels in the configuration hierarchy. For information about navigating the CLI, see Using the CLI Editor in Configuration Mode in the CLI User Guide.

To set the CLI to a specific logical system context:

1. From the main router, configure the logical system.

```
[edit]
user@host# set logical-systems LS3
```



- If you are done configuring the device, commit the configuration.

```
[edit]
user@host# commit
user@host# exit
```

- Set the CLI to view the logical system.

```
user@host> set cli logical-system LS3
Logical system: LS3
```

```
user@host:LS3>
```

- Run an operational-mode command.

```
user@host:LS3> show interfaces terse
Interface Admin Link Proto Local Remote
1t-1/2/0
1t-1/2/0.3 up up inet 10.0.2.1/30
```

- Enter configuration mode to edit the logical system configuration.

```
user@host:LS3> edit
Entering configuration mode
```

```
user@host:LS3#
```

- Exit configuration mode to return to operational mode.

```
user@host:LS3# exit
Exiting configuration mode
```

- Clear the logical system view to return to the main router view.

```
user@host:LS3> clear cli logical-system
Cleared default logical system
```

```
user@host>
```

- To achieve the same effect when using a Junos XML protocol client application, include the `<set-logical-system>` tag.

```
<rpc>
<set-logical-system>
<logical-system>LS1</logical-system>
</set-logical-system>
</rpc>
```

## Example: Viewing BGP Trace Files on Logical Systems

This example shows how to list and view files that are stored on a logical system.

- [Requirements on page 281](#)
- [Overview on page 282](#)
- [Configuration on page 282](#)
- [Verification on page 286](#)

### Requirements

- You must have the **view** privilege for the logical system.
- Configure a network, such as the BGP network shown in “[Example: Configuring Internal BGP Peering Sessions on Logical Systems](#)” on page 115.

## Overview

Logical systems have their individual directory structure created in the `/var/logical-systems/logical-system-name` directory. It contains the following subdirectories:

- `/config`—Contains the active configuration specific to the logical system.
- `/log`—Contains system log and tracing files specific to the logical system.

To maintain backward compatibility for the log files with previous versions of Junos OS, a symbolic link (symlink) from the `/var/logs/logical-system-name` directory to the `/var/logical-systems/logical-system-name` directory is created when a logical system is configured.

- `/tmp`—Contains temporary files specific to the logical system.

The file system for each logical system enables logical system users to view trace logs and modify logical system files. Logical system administrators have full access to view and modify all files specific to the logical system.

Logical system users and administrators can save and load configuration files at the logical-system level using the `save` and `load` configuration mode commands. In addition, they can also issue the `show log`, `monitor`, and `file` operational mode commands at the logical-system level.

This example shows how to configure and view a BGP trace file on a logical system. The steps can be adapted to apply to trace operations for any Junos OS hierarchy level that supports trace operations.



**TIP:** To view a list of hierarchy levels that support tracing operations, enter the `help apropos traceoptions` command in configuration mode.

## Configuration

- [Configuring Trace Operations on page 283](#)
- [Viewing the Trace File on page 283](#)
- [Deactivating and Reactivating Trace Logging on page 285](#)
- [Results on page 286](#)

### CLI Quick Configuration

To quickly configure this example, copy the following commands, paste them into a text file, remove any line breaks, change any details necessary to match your network configuration, and then copy and paste the commands into the CLI at the `[edit]` hierarchy level.

```
set logical-systems A protocols bgp group internal-peers traceoptions file bgp-log
set logical-systems A protocols bgp group internal-peers traceoptions file size 10k
set logical-systems A protocols bgp group internal-peers traceoptions file files 2
set logical-systems A protocols bgp group internal-peers traceoptions flag update detail
```

### Configuring Trace Operations

**Step-by-Step Procedure** The following example requires you to navigate various levels in the configuration hierarchy. For information about navigating the CLI, see Using the CLI Editor in Configuration Mode in the CLI User Guide.

To configure the trace operations:

1. Configure trace operations on the logical system.

```
[edit logical-systems A protocols bgp group internal-peers]
user@host# set traceoptions file bgp-log
user@host# set traceoptions file size 10k
user@host# set traceoptions file files 2
user@host# set traceoptions flag update detail
```

2. If you are done configuring the device, commit the configuration.

```
[edit]
user@host# commit
```

### Viewing the Trace File

**Step-by-Step Procedure** To view the trace file:

1. In operational mode on the main router, list the directories on the logical system.

```
user@host> file list /var/logical-systems/A
/var/logical-systems/A:
config/
log/
tmp/
```

2. In operational mode on the main router, list the log files on the logical system.

```
user@host> file list /var/logical-systems/A/log/
/var/logical-systems/A/log:
bgp-log
```

3. View the contents of the **bgp-log** file.

```
user@host> file show /var/logical-systems/A/log/bgp-log
Aug 10 17:12:01 trace_on: Tracing to "/var/log/A/bgp-log" started
Aug 10 17:14:22.826182 bgp_peer_mgmt_clear:5829: NOTIFICATION sent to
192.163.6.4 (Internal AS 17): code 6 (Cease) subcode 4 (Administratively
Reset), Reason: Management session cleared BGP neighbor
Aug 10 17:14:22.826445 bgp_send: sending 21 bytes to 192.163.6.4 (Internal
AS 17)
Aug 10 17:14:22.826499
Aug 10 17:14:22.826499 BGP SEND 192.168.6.5+64965 -> 192.163.6.4+179
Aug 10 17:14:22.826559 BGP SEND message type 3 (Notification) length 21
Aug 10 17:14:22.826598 BGP SEND Notification code 6 (Cease) subcode 4
(Administratively Reset)
Aug 10 17:14:22.831756 bgp_peer_mgmt_clear:5829: NOTIFICATION sent to
192.168.40.4 (Internal AS 17): code 6 (Cease) subcode 4 (Administratively
Reset), Reason: Management session cleared BGP neighbor
Aug 10 17:14:22.831851 bgp_send: sending 21 bytes to 192.168.40.4 (Internal
AS 17)
Aug 10 17:14:22.831901
Aug 10 17:14:22.831901 BGP SEND 192.168.6.5+53889 -> 192.168.40.4+179
```

```
Aug 10 17:14:22.831959 BGP SEND message type 3 (Notification) length 21
Aug 10 17:14:22.831999 BGP SEND Notification code 6 (Cease) subcode 4
(Administratively Reset)
...
```

4. Filter the output of the log file.

```
user@host> file show /var/logical-systems/A/log/bgp-log | match "flags 0x40"
Aug 10 17:14:54.867460 BGP SEND flags 0x40 code Origin(1): IGP
Aug 10 17:14:54.867595 BGP SEND flags 0x40 code ASPath(2) length 0: <null>
Aug 10 17:14:54.867650 BGP SEND flags 0x40 code NextHop(3): 192.168.6.5
Aug 10 17:14:54.867692 BGP SEND flags 0x40 code LocalPref(5): 100
Aug 10 17:14:54.884529 BGP RECV flags 0x40 code Origin(1): IGP
Aug 10 17:14:54.884581 BGP RECV flags 0x40 code ASPath(2) length 0: <null>
Aug 10 17:14:54.884628 BGP RECV flags 0x40 code NextHop(3): 192.163.6.4
Aug 10 17:14:54.884667 BGP RECV flags 0x40 code LocalPref(5): 100
Aug 10 17:14:54.911377 BGP RECV flags 0x40 code Origin(1): IGP
Aug 10 17:14:54.911422 BGP RECV flags 0x40 code ASPath(2) length 0: <null>
Aug 10 17:14:54.911466 BGP RECV flags 0x40 code NextHop(3): 192.168.40.4
Aug 10 17:14:54.911507 BGP RECV flags 0x40 code LocalPref(5): 100
Aug 10 17:14:54.916008 BGP SEND flags 0x40 code Origin(1): IGP
Aug 10 17:14:54.916054 BGP SEND flags 0x40 code ASPath(2) length 0: <null>
Aug 10 17:14:54.916100 BGP SEND flags 0x40 code NextHop(3): 192.168.6.5
Aug 10 17:14:54.916143 BGP SEND flags 0x40 code LocalPref(5): 100
Aug 10 17:14:54.920304 BGP RECV flags 0x40 code Origin(1): IGP
Aug 10 17:14:54.920348 BGP RECV flags 0x40 code ASPath(2) length 0: <null>
Aug 10 17:14:54.920393 BGP RECV flags 0x40 code NextHop(3): 10.0.0.10
Aug 10 17:14:54.920434 BGP RECV flags 0x40 code LocalPref(5): 100
```

5. View the tracing operations in real time.

```
user@host> clear bgp neighbor logical-system A
Cleared 2 connections
```



**CAUTION:** Clearing the BGP neighbor table is disruptive in a production environment.

6. Run the **monitor start** command with an optional **match** condition.

```
user@host> monitor start A/bgp-log | match 0.0.0.0/0
Aug 10 19:21:40.773467 BGP RECV 0.0.0.0/0
Aug 10 19:21:40.773685 bgp_rcv_nlrri: 0.0.0.0/0
Aug 10 19:21:40.773778 bgp_rcv_nlrri: 0.0.0.0/0 belongs to meshgroup
Aug 10 19:21:40.773832 bgp_rcv_nlrri: 0.0.0.0/0 qualified bnp->ribact 0x0
12afcb 0x0
```

7. Pause the **monitor** command by pressing Esc-Q.  
To unpause the output, press Esc-Q again.
8. Halt the **monitor** command by pressing Enter and typing **monitor stop**.

```
[Enter]
user@host> monitor stop
```

9. When you are finished troubleshooting, consider deactivating trace logging to avoid any unnecessary impact to system resources.

```
[edit protocols bgp group internal-peers]
user@host:A# deactivate traceoptions
user@host:A# commit
```

When configuration is deactivated, it appears in the configuration with the **inactive** tag. To reactivate trace operations, use the **activate** configuration-mode statement.

```
[edit protocols bgp group internal-peers]
user@host:A# show

type internal;
inactive: traceoptions {
 file bgp-log size 10k files 2;
 flag update detail;
 flag all;
}
local-address 192.168.6.5;
export send-direct;
neighbor 192.163.6.4;
neighbor 192.168.40.4;
```

- To reactivate trace operations, use the **activate** configuration-mode statement.

```
[edit protocols bgp group internal-peers]
user@host:A# activate traceoptions
user@host:A# commit
```

### *Deactivating and Reactivating Trace Logging*

#### **Step-by-Step Procedure**

To deactivate and reactivate the trace file:

- When you are finished troubleshooting, consider deactivating trace logging to avoid an unnecessary impact to system resources.

```
[edit protocols bgp group internal-peers]
user@host:A# deactivate traceoptions
user@host:A# commit
```

When configuration is deactivated, the statement appears in the configuration with the **inactive** tag.

```
[edit protocols bgp group internal-peers]
user@host:A# show

type internal;
inactive: traceoptions {
 file bgp-log size 10k files 2;
 flag update detail;
 flag all;
}
local-address 192.168.6.5;
export send-direct;
neighbor 192.163.6.4;
neighbor 192.168.40.4;
```

- To reactivate logging, use the **activate** configuration-mode statement.

```
[edit protocols bgp group internal-peers]
user@host:A# activate traceoptions
user@host:A# commit
```

From configuration mode, confirm your configuration by entering the **show logical-systems A protocols bgp group internal-peers** command. If the output does not display the intended configuration, repeat the instructions in this example to correct the configuration.

```
user@host# show logical-systems A protocols bgp group internal-peers
traceoptions {
 file bgp-log size 10k files 2;
 flag update detail;
}
```

### Verification

---

Confirm that the configuration is working properly.

#### *Verifying That the Trace Log File Is Operating*

**Purpose** Make sure that events are being written to the log file.

**Action** user@host:A> **show log bgp-log**  
Aug 12 11:20:57 trace\_on: Tracing to "/var/log/A/bgp-log" started

## Example: Configuring System Logging on Logical Systems

This example shows how to configure system logging on logical systems and how to view the logs.

- [Requirements on page 286](#)
- [Overview on page 287](#)
- [Configuration on page 287](#)
- [Verification on page 288](#)

### Requirements

---

This example has the following requirements:

- You must have the **view** privilege for the logical system.
- Junos OS Release 11.4 or later.

## Overview

Each logical system has its individual directory structure created in the `/var/logical-systems/logical-system-name` directory. This directory contains the following subdirectories:

- `/config`—Contains the active configuration specific to the logical system.
- `/log`—Contains system log and tracing files specific to the logical system.

To maintain backward compatibility for the log files with previous versions of Junos OS, a symbolic link (symlink) from the `/var/log/logical-system-name` directory to the `/var/logical-systems/logical-system-name` directory is created when a logical system is configured.

- `/tmp`—Contains temporary files specific to the logical system.

The file system for each logical system enables logical system users to view trace logs and modify logical system files. Logical system administrators have full access to view and modify all files specific to the logical system.

Logical system users and administrators can save and load configuration files at the logical system level using the `save` and `load` configuration mode commands. In addition, they can issue the `show log`, `monitor`, and `file` operational mode commands at the logical system level.

This example shows how to configure system logging on a logical system.

## Configuration

### CLI Quick Configuration

To quickly configure this example, copy the following commands, paste them into a text file, remove any line breaks, change any details necessary to match your network configuration, and then copy and paste the commands into the CLI at the `[edit]` hierarchy level.

```
set logical-systems lsys1 system syslog host 10.209.10.69 ftp critical
set logical-systems lsys1 system syslog allow-duplicates
set logical-systems lsys1 system syslog file lsys1-file1 daemon error
set logical-systems lsys1 system syslog file lsys1-file1 firewall critical
```

### Step-by-Step Procedure

The following example requires you to navigate various levels in the configuration hierarchy. For information about navigating the CLI, see *Using the CLI Editor in Configuration Mode* in the *CLI User Guide*.

To configure system logging:

1. Configure trace operations on the logical system.

```
[edit logical-systems lsys1 system syslog]
user@host# set host 10.209.10.69 ftp critical
user@host# set allow-duplicates
user@host# set file lsys1-file1 daemon error
user@host# set file lsys1-file1 firewall critical
```

- If you are done configuring the device, commit the configuration.

```
[edit]
user@host# commit
user@host# exit
```

From configuration mode, confirm your configuration by entering the **show logical-systems** command. If the output does not display the intended configuration, repeat the instructions in this example to correct the configuration.

```
user@host# show logical-systems
lsys1 {
 system {
 syslog {
 host 10.209.10.69 {
 ftp critical;
 }
 allow-duplicates;
 file lsys1-file1 {
 daemon error;
 firewall critical;
 }
 }
 }
}
```

## Verification

Confirm that the configuration is working properly.

### *Verifying That the System Log File Is Operating*

**Purpose** Make sure that events are being written to the log file.

**Action**



**TIP:** To make entries in the system log, you can use the **start shell** command and then use the **logger** shell command. For example: **logger -e "firewall\_crit" -p firewall.crit -l lsys1 TEST**

```
user@host> show log lsys1/lsys1-file1
Sep 7 14:15:46 host clear-log[2752]: logfile cleared
Sep 7 14:19:04 host logger: % -: firewall_crit: TEST
...
```

```
user@host> file show /var/logical-systems/lsys1/log/lsys1-file1
Sep 7 14:19:04 host logger: % -: firewall_crit: TEST
...
```

**Related Documentation**

- [Introduction to Logical Systems on page 3](#)



PART 4

# Index

- [Index on page 291](#)



# Index

## Symbols

#, comments in configuration statements.....	xiv
( ), in syntax descriptions.....	xiv
< >, in syntax descriptions.....	xiv
[ ], in configuration statements.....	xiv
{ }, in configuration statements.....	xiv
(pipe), in syntax descriptions.....	xiv

## A

access privilege levels	
login classes.....	15
actions	
routing policy.....	75
administrators	
configuring on logical systems.....	20
logical system.....	8, 11, 20
master.....	8, 11, 20
allow-commands statement	
usage guidelines.....	19
allow-configuration-regexps statement	
usage guidelines.....	19
allowing commands to login classes.....	19
applications	
of logical systems.....	9

## B

BFD	
protocol.....	140
with IBGP.....	140
bfd-liveness-detection statement	
BGP	
usage guidelines.....	140
BGP	
BFD.....	140
configuring on logical systems.....	184
EBGP IPv6 peering.....	125
external (EBGP).....	114
internal (IBGP).....	114
IPv6	
logical systems.....	125
neighbors BGP, peers See BGP, peers	

overview.....	113
peers.....	114
TCP.....	113
version supported.....	113
with BFD.....	140
BGP (Border Gateway Protocol)	
point-to-point internal peer session	
logical systems.....	115
BGP peers	
internal.....	115
BGP sessions	
internal.....	115
Border Gateway Protocol See BGP	
braces, in configuration statements.....	xiv
brackets	
angle, in syntax descriptions.....	xiv
square, in configuration statements.....	xiv

## C

CLNP (Connectionless Network Protocol).....	95
commands	
allowing or denying to login classes.....	19
running on logical systems.....	280
comments, in configuration statements.....	xiv
complete sequence number PDUs, IS-IS.....	97
configure command	
usage guidelines.....	278
conventions	
text and syntax.....	xiii
copy command	
usage guidelines.....	278
curly braces, in configuration statements.....	xiv
customer support.....	xv
contacting JTAC.....	xv

## D

default route	
configuring on logical systems.....	75, 80, 108
deny-commands statement	
usage guidelines.....	19
deny-configuration-regexps statement	
usage guidelines.....	19
denying commands to login classes.....	19
documentation	
comments on.....	xv

## E

EBGP See BGP	
EBGP IPv6 peering, BGP.....	125

**F**

FBF, configuring.....49

file command

- logical systems.....281
- usage guidelines.....278

filter-based forwarding

- configuring on logical systems.....49

firewall filters

- configuring on logical systems.....46

flags

- login class.....15
- user permissions.....15

font conventions.....xiii

**H**

hello packets

- IS-IS.....97

**I**

IBGP *See* BGP

interfaces

- configuring on logical systems.....24
- overview.....23

*See also* ATM-over-ADSL interfaces;  
ATM-over-SHDSDL interfaces;  
channelized interfaces; ISDN interfaces;  
link services interface; loopback  
interface; management interfaces;  
network interfaces; ports; special  
interfaces

IPv6

- EBGP link-local peering.....125
- logical systems.....125

IS-IS

- addresses.....96
- complete sequence number PDUs.....97
- configuring on logical systems.....99, 108
- hello

  - PDUs.....97

- link-state PDUs.....97
- network PDUs.....95
- NSAP.....96
- partial sequence number PDUs.....97
- PDUs.....97

ISO

- addresses.....96
- system identifier.....96

**L**

link services.....23

- See also* link services interface; lsq-0/0/0

link-state PDUs.....97

local-interface statement

- usage guidelines.....125

log files

- logical systems

  - .....286

logical system administrators.....8, 11, 20

logical systems

- applications.....9
- configuring administrators.....20
- configuring BGP.....184
- configuring default route.....75, 80, 108
- configuring filter-based forwarding.....49
- configuring firewall filters.....46
- configuring interfaces.....24
- configuring IS-IS.....99, 108
- configuring OSPF.....66, 75, 80, 87
- configuring routing policy.....75, 80, 108
- configuring static routes on.....37
- configuring VPLS.....184
- configuring VPNs.....184
- connecting to a physical router.....26
- connecting within the same router.....28, 32
- EBGP

  - with IPv6 interfaces.....125

- internal BGP.....115
- options

  - selective view for operational mode.....280

- overview.....3

  - supported features.....5

- restrictions.....6
- running commands on.....280
- system logging.....286
- system requirements.....10
- viewing system files on.....281
- with RSVP-signaled point-to-multipoint  
LSPs.....161

logical tunnel interfaces

- configuring on logical systems.....28, 32

login classes

- access privilege levels.....15
- commands, allowing or denying.....19

**M**

manuals

- comments on.....xv

- master administrators.....8, 11, 20
  - match conditions
    - routing policy.....74
  - media types supported.....23
  - minimum-interval
    - usage guidelines.....140
  - minimum-receive-interval statement
    - BFD (BGP)
      - usage guidelines.....140
  - multihop statement
    - usage guidelines.....149
  - multiplier statement
    - BFD (BGP)
      - usage guidelines.....140
- N**
- neighbors
    - BGP.....114
  - network interfaces
    - media types.....23
  - network PDUs.....95
  - network service access point.....96
  - no-adaptation
    - BFD (BGP)
      - usage guidelines.....140
  - NPDUs.....95
  - NSAP.....96
- O**
- Open Shortest Path First *See* OSPF
  - OSPF
    - configuring on logical systems.....66, 75, 80
    - import policy
      - configuring on logical systems.....87
    - route preference.....64
    - routing algorithm.....64
    - SPF.....64
    - topological database.....62
  - OSPFv3
    - overview.....66
- P**
- p2mp-lsp-next-hop statement
    - RSVP
      - usage guidelines.....161
  - parentheses, in syntax descriptions.....xiv
  - partial sequence number PDUs.....97
  - PDUs.....97
  - permanent routes, adding.....37
  - permission flags
    - login class.....15
    - user.....15
  - permissions statement
    - usage guidelines.....15
  - point-to-multipoint LSPs
    - graceful restart.....160
    - GRES.....160
    - overview.....159
    - with RSVP signaling.....161
  - ports
    - interfaces overview.....23
      - See also* ATM-over-ADSL interfaces;
      - ATM-over-SHDSL interfaces; ISDN
      - interfaces; link services interface;
      - loopback interface; management
      - interfaces; network interfaces; special
      - interfaces
  - PSNP IS-IS.....97
- Q**
- quit command.....278
- R**
- request command
    - usage guidelines.....278
  - requirements
    - logical systems.....10
  - restart command
    - usage guidelines.....278
  - restrictions
    - logical systems.....6
  - routing
    - static *See* static routing
  - routing policy
    - actions.....75
    - configuring on logical systems.....75, 80, 108
    - match conditions.....74
    - terms.....74
  - RSVP
    - for point-to-multipoint LSPs.....161
- S**
- services interfaces, overview.....23
    - See also* link services interface; multilink
    - services
  - Shortest Path First *See* SPF algorithm

special interfaces

- services interfaces.....23
- See also* link services interface; multilink services

SPF algorithm

- overview.....64

ssh command

- usage guidelines.....278

stateless firewall filters

- basic use

  - filtering data packets.....45
  - filtering local packets.....45

- filtering router transit traffic

  - overview.....45

- filtering Routing Engine traffic

  - overview.....45

static routes

- configuring on logical systems.....37

static routing

- overview.....37
- See also* static routes

support, technical *See* technical support

syntax conventions.....xiii

syslog statement

- logical systems.....286

system identifier.....96

system requirements

- logical systems.....10

**T**

technical support

- contacting JTAC.....xv

telnet command

- usage guidelines.....278

terms

- routing policy.....74

threshold statement

- BFD (BGP)

  - usage guidelines.....140

trace files

- logical systems

  - .....281

traffic-engineering statement

- usage guidelines.....161

**U**

user permission flags.....15

**V**

verification

- filter-based forwarding.....58
- IS-IS policy.....111
- network interfaces.....26, 27, 31, 34, 180
- OSPF.....71, 92
- OSPF policy.....49, 78, 85
- static route.....41
- tracing.....286, 288

version statement

- BFD (BGP)

  - usage guidelines.....140

virtualization

- Junos OS.....8

VPLS

- configuring on logical systems.....184

VPNs

- configuring on logical systems.....184