

Speech recognition

- For graduate and post-graduate students
- Home page: <https://mycourses.aalto.fi> > **ELEC-E5510**
- Registration at Oodi
- **Lectures: Mikko Kurimo**
- **Exercises: Juho Leinonen, Aku Rouhe, Katja Voskoboinik**
- **Project works: Katja & Juho, Aku, Anja, Mittul, Hemant, Tamas, Dejan, Anand**

Goals

- Become familiar with speech recognition methods and current applications
- Learn the structure of a typical speech recognition system
- Learn to construct one in practice

Discussion (in breakout groups):

- What is your name – where do you come from?
- What is your goal – why are you here?

Content today

- ⇒ **1. General organization of the course**
- 2. What is automatic speech recognition (ASR)?
- 3. Speech as an acoustic signal
- 4. GMMs and DNNs
- 5. Home exercise 1:
 - Build a system to classify speech features into phonemes
- 6. Kick-start of the group works

Content of the course

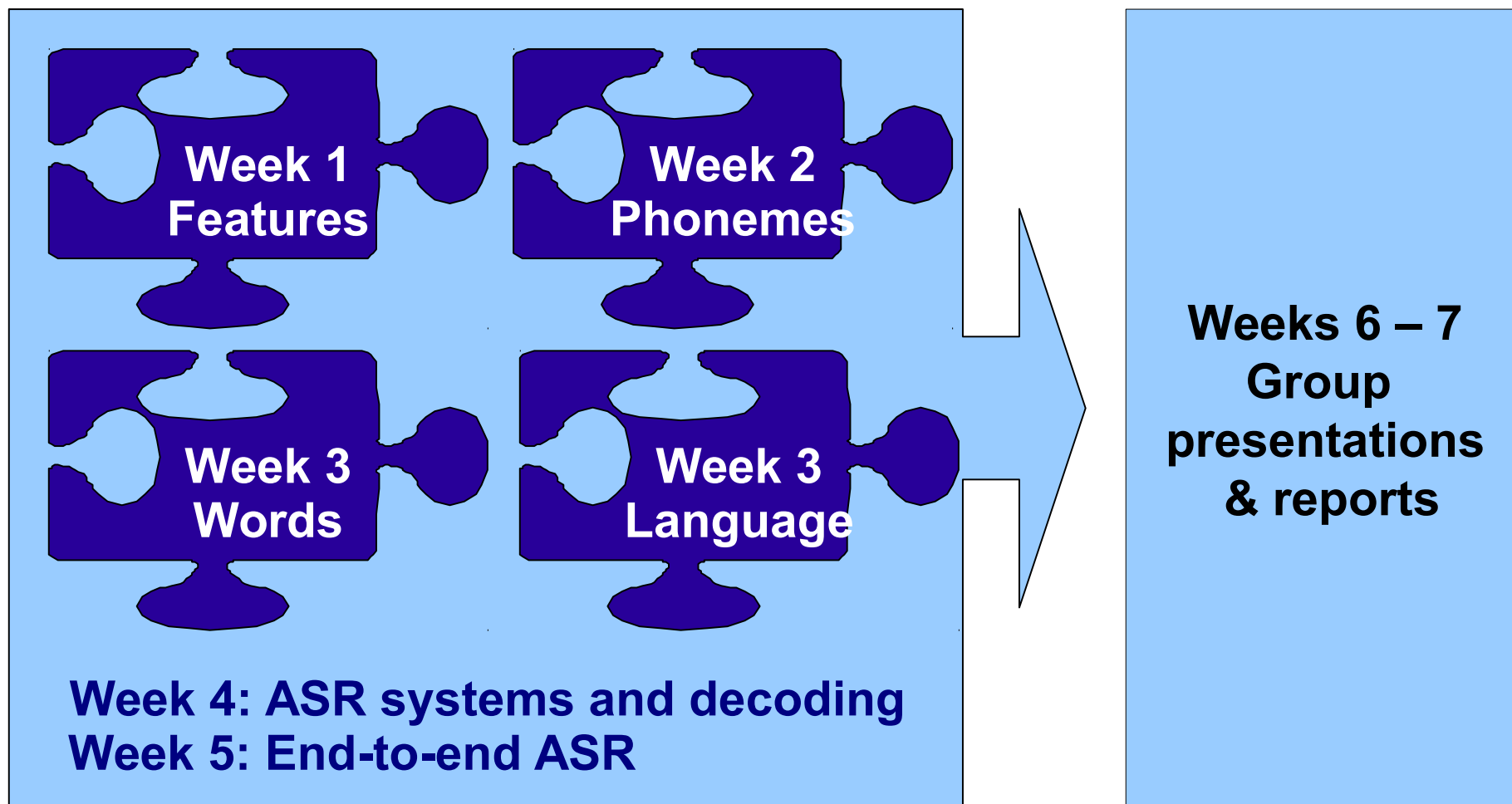

Course Format

"Hour pie": 130h

meetings exercises project

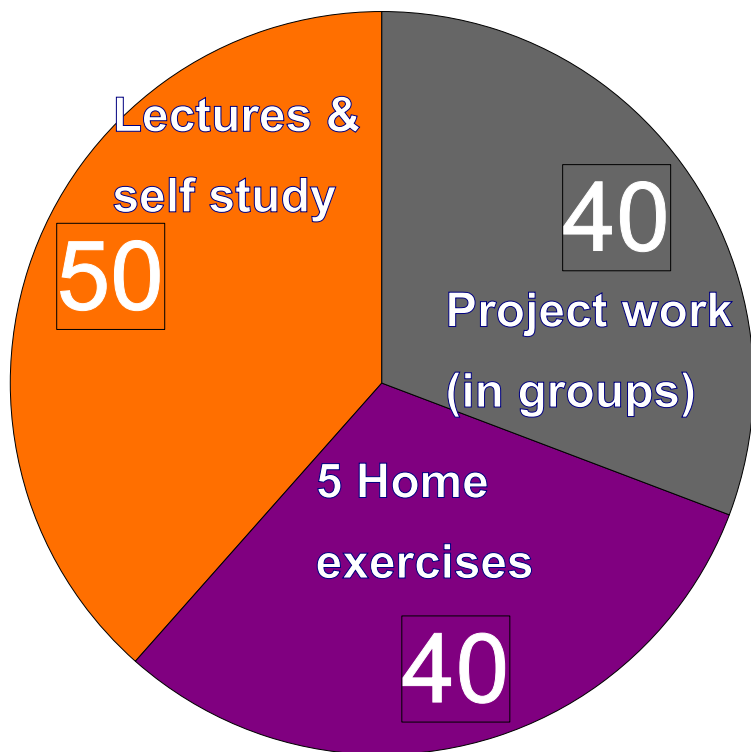

"Grade pie": 1..5

meetings exercises project

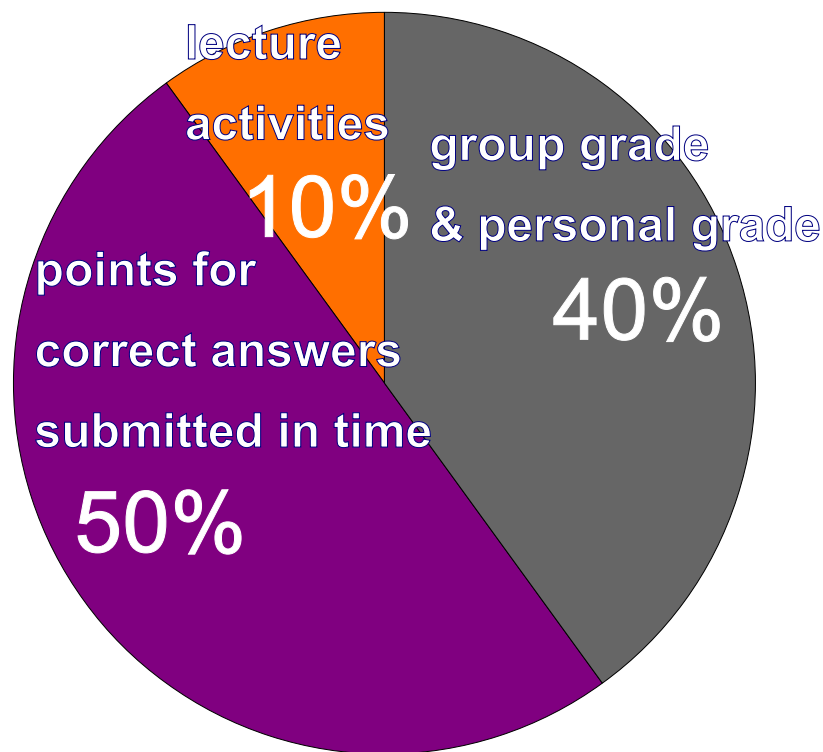

Meetings

- 14 meetings during 7 weeks:
 - 5 general lectures on Wed (Oct 28 - Nov 25)
 - Lecture 09:15 - 11:00 + project meeting 11:15 - 12
 - 5 meetings for computer work (Oct 29 - Nov 27)
 - (Thu 10:15 – 12 or) Fri 14:15 – 16
 - Duplicate sessions on Thu Oct 29 and continue if needed
 - 4 seminar meetings for project results (Dec 2 - Dec 11)
 - Wed 09:15 - 12 and Fri 14:15 - 16

Timeline in the course

	Meetings Wednesdays	Thursdays or Fridays	Home exercises	Project work status
Week1	Speech features	Classification	Feature classifier	Literature study
Oct 28-30	entry test			Meet tutors Oct 28
Week2	Phoneme modeling	Recognition	Word recognizer	Work plan
Nov 4-6				Meet tutors Nov 4
Week3	Lexicon and language	Language model	Text predictor	Analysis
Nov 11-13				Meet tutors Nov 11
Week4	Continuous speech	LVCSR	Speech recognizer	Experimentation
Nov 18-20	advanced search			Meet tutors Nov 18
Week5	End-to-end ASR	End-to-end	End-to-end recognizer	Preparing reports
Nov 25-27				Meet tutors Nov 25
Week6	Projects1	Projects2		Presentations
Dec 2-4				
Week7	Projects3	Projects4		Report submission
Dec 9-11		Conclusion		

Timeline in the course

	Meetings Wednesdays	Thursdays or Fridays	Home exercises	Project work status
Week1	Speech features	Classification	Feature classifier	Literature study
Oct 28-30	entry test			Meet tutors Oct 28
Week2	Phoneme modeling	Recognition	Word recognizer	Work plan
Nov 4-6				Meet tutors Nov 4
Week3	Lexicon and language	Language model	Text predictor	Analysis
Nov 11-13				Meet tutors Nov 11
Week4	Continuous speech	LVCSR	Speech recognizer	Experimentation
Nov 18-20	advanced search			Meet tutors Nov 18
Week5	End-to-end ASR	End-to-end	End-to-end recognizer	Preparing reports
Nov 25-27				Meet tutors Nov 25
Week6	Projects1	Projects2		Presentations
Dec 2-4				
Week7	Projects3	Projects4		Report submission
Dec 9-11		Conclusion		

Timeline in the course

	Meetings Wednesdays	Thursdays or Fridays	Home exercises	Project work status
Week1	Speech signal	Classification	Feature classifier	Literature study
Oct 28-30	entry test			Meet tutors Oct 28
Week2	Phoneme modeling	Recognition	Word recognizer	Work plan
Nov 4-6				Meet tutors Nov 4
Week3	Lexicon and language	Language model	Text predictor	Analysis
Nov 11-13				Meet tutors Nov 11
Week4	Continuous speech	LVCSR	Speech recognizer	Experimentation
Nov 18-20	advanced search			Meet tutors Nov 18
Week5	DNNs and adaptation	End-to-end	End-to-end recognizer	Preparing reports
Nov 25-27				Meet tutors Nov 25
Week6	Projects1	Projects2		Presentations
Dec 2-4				
Week7	Projects3	Projects4		Report submission
Dec 9-11		Conclusion		

Timeline in the course

	Meetings Wednesdays	Thursdays or Fridays	Home exercises	Project work status
Week1	Speech signal	Classification	Feature classifier	Literature study
Oct 28-30	entry test			Meet tutors Oct 28
Week2	Phoneme modeling	Recognition	Word recognizer	Work plan
Nov 4-6				Meet tutors Nov 4
Week3	Lexicon and language	Language model	Text predictor	Analysis
Nov 11-13				Meet tutors Nov 11
Week4	Continuous speech	LVCSR	Speech recognizer	Experimentation
Nov 18-20	advanced search			Meet tutors Nov 18
Week5	DNNs and adaptation	End-to-end	End-to-end recognizer	Preparing reports
Nov 25-27				Meet tutors Nov 25
Week6	Projects1	Projects2		Presentations
Dec 2-4				
Week7	Projects3	Projects4		Report submission
Dec 9-11		Conclusion		

The main text book

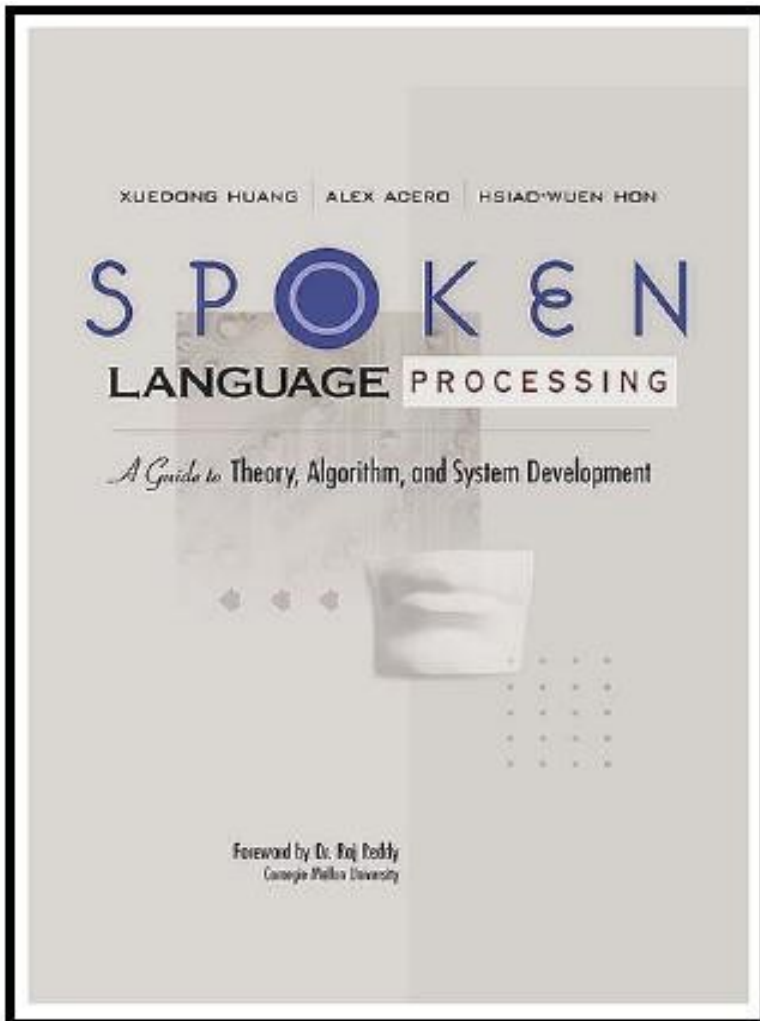

- You may survive without one, but this is recommended
- Huang, Acero: *Spoken Language Processing*
- Prentice Hall, 2001 ISBN: 0-13-022616-5

A new text book

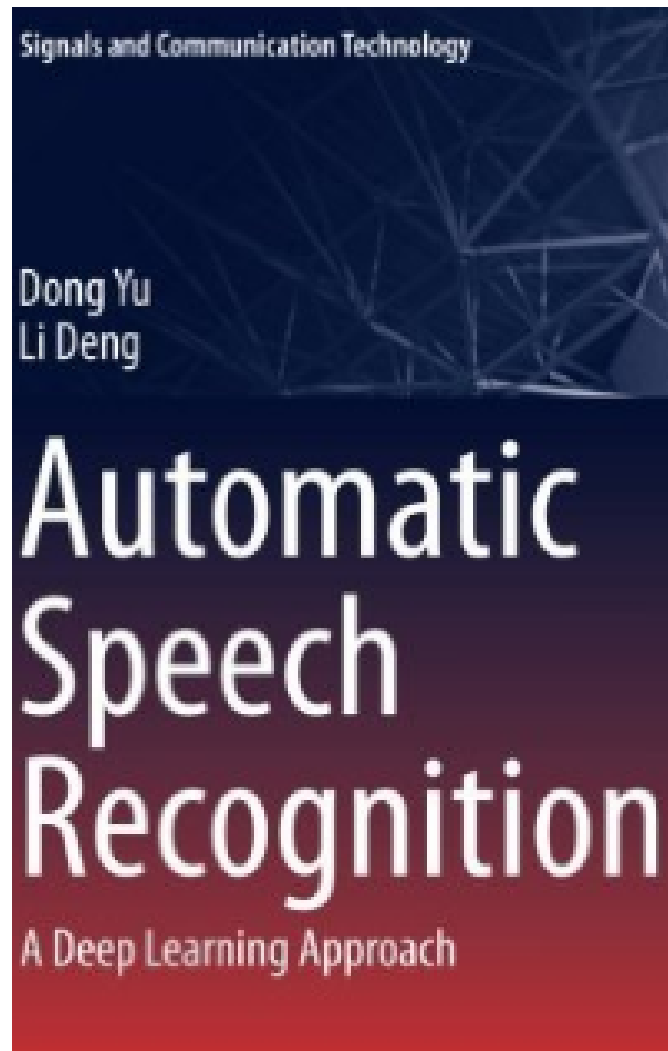

- This is very advanced level, but worth studying to understand the latest trends
- Yu, Deng: *Automatic Speech Recognition A Deep Learning Approach*
- Springer, 2015 ISBN: 978-1-4471-5779-3

Other useful text books

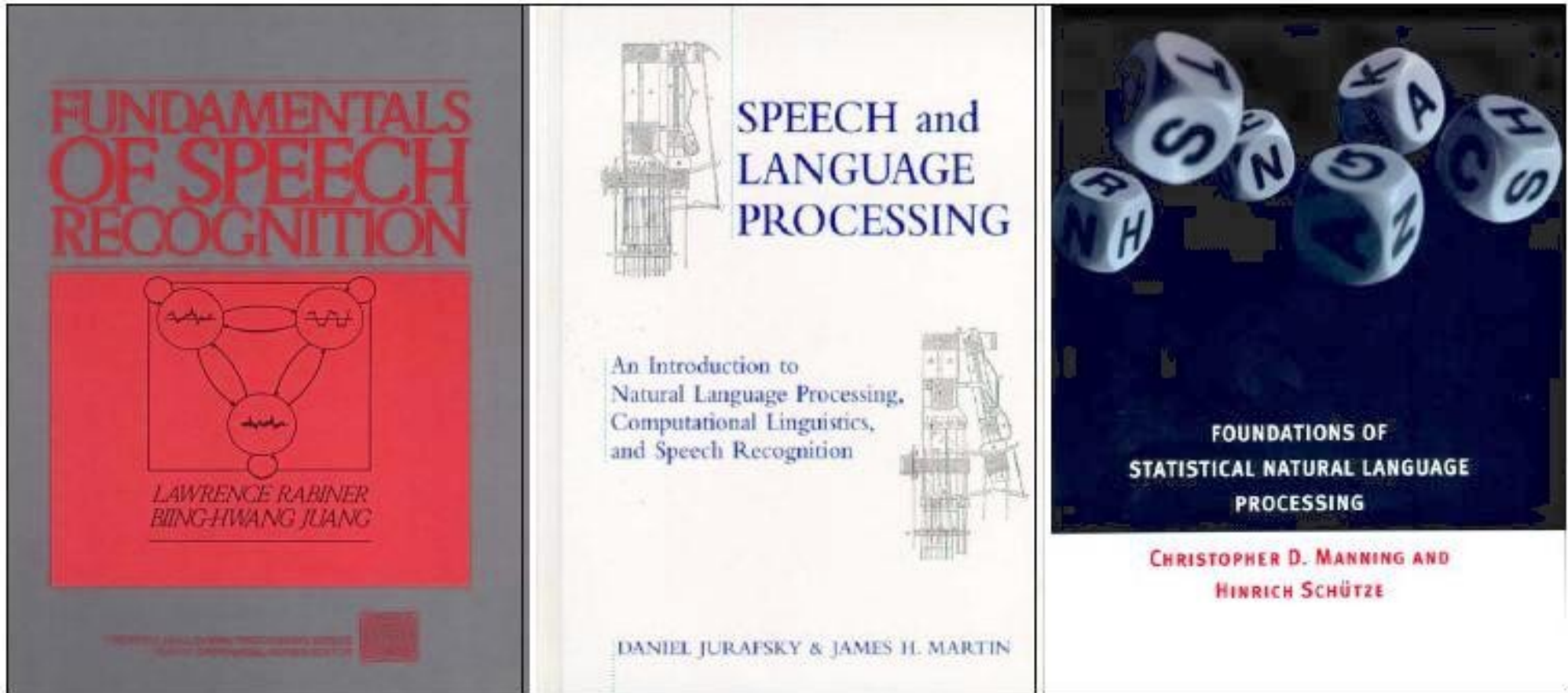

Lectures mapped to pages of Jurafsky & Martin, see:
MyCourses > Materials > (last item in the list)

Some useful online resources

- **Gales, Young: HMMs applications in ASR (book):**
<http://dx.doi.org/10.1561/20000000004>
- **Cambridge: HTK Book (detailed manual):**
<http://htk.eng.cam.ac.uk/docs/docs.shtml>
- Slides from **MIT** open course: **6.345 ASR** (2003)
<http://ocw.mit.edu/courses/electrical-engineering-and-computer-science/6-345-automatic-speech-recognition-spring-2003/>
<http://ocw.mit.edu/courses/electrical-engineering-and-computer-science/6-345-automatic-speech-recognition-spring-2003/>

Useful software

- Software used in this course:
 - Python, PyTorch
 - Cambridge HMM toolkit (HTK)
 - SRI language modeling toolkit (SRILM)
- Other useful software for ASR:
 - **Kaldi**, Aachen RWTH, KTH Snack, OGI speech, Nagoya's Julius
 - CMU Sphinx-II ASR, ESPNET, SpeechBrain
 - AaltoASR tools, Aalto Professor tools
 - TensorFlow
 - NIST ASR scoring utilities
 - CMU / Cambridge language model toolkit

Content today

1. General organization of the course

→ **2. What is automatic speech recognition?**

3. Speech as an acoustic signal

4. GMMs and DNNs

5. Home exercise 1:

- Build a system to classify speech features into phonemes

6. Kick-start of the group works

All these are needed to build ASR systems!

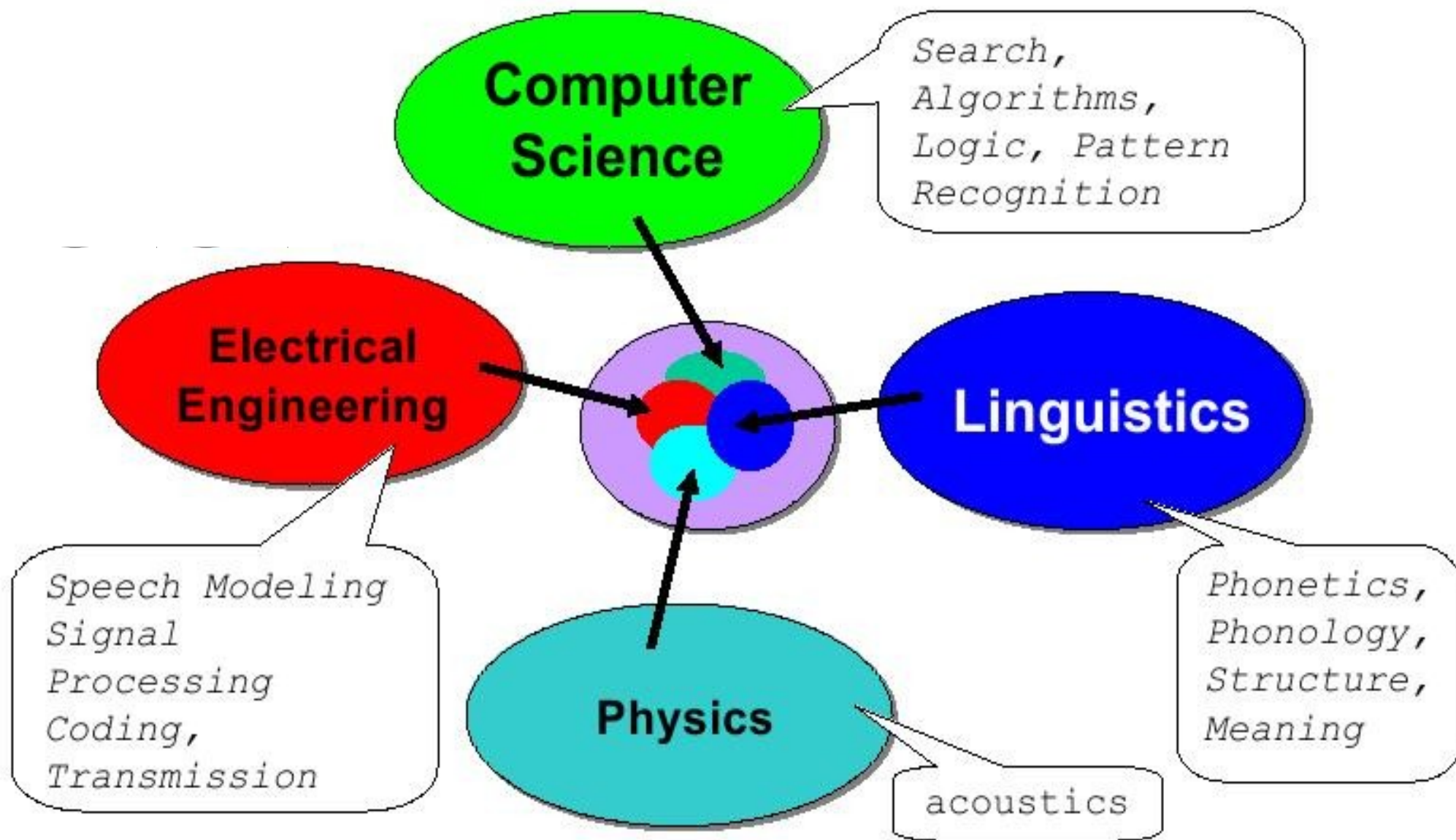

Milestones for ASR systems

- **1952** Bell Labs Digit Recognizer
- **1976** CMU Harpy 1000-word connected recognizer with constrained grammar
- **1980 TKK**: 1000-word LSM recognizer (separate words w/o grammar)
- **1988 TKK**: phonetic typewriter
- **1993** Read texts (WSJ news)
- **1998** Broadcast news, telephone conversations
- **1998** Speech retrieval from broadcast news

Milestones for ASR systems (2)

- **2002** Rich transcription of meetings
- **2004 TKK**: Finnish online dictation for unlimited vocabulary
- **2006** Machine translation of broadcast speech
- **2006** Voice interface in Windows Vista
 - <https://www.youtube.com/watch?v=kX8oYoYy2Gc&feature=related>
- **2008** Google voice search
- **2009 Aalto**: Cross-lingual speaker adaptation by speech recognition
 - <https://www.youtube.com/watch?v=wqv7uYAyAQ0>
- **2011** Siri voice assistant
- **2013** Big performance boost by applying deep learning

Performance depends on: 1. Speaking environment, microphone, speaker

1. Office, headset, close-talking
2. Telephone speech, mobile
3. Noise, outside, microphone far away
4. Voice, accents

Acoustic modeling



2. Style of speaking and language

Language modeling

1. Isolated words, small vocabulary
2. Continuous speech, read or planned, large vocabulary
3. Spontaneous speech, open vocabulary, hesitations



Useful entry skills

- linear algebra (basic matrix operations)
- probability and statistics
- signal processing and natural language processing
- programming
 - perl/python for text processing
 - shell scripts, C/C++ for running/modifying programs
 - matlab
- familiarity with Linux

Test of your skill level

Individual test for everyone, now:

1. Go to <https://kahoot.it> with your phone/laptop
2. Type in the number you see in the chat
3. Give your (sur)name (this will give you a point)
4. Answer the questions by selecting **only one** of the options
 - There may be several right answers, but just pick one
 - About 1 min time per question
 - This first test is not graded, everyone will get one point

Useful skills - 1

- linear algebra (basic matrix operations)
 - multiplication, determinant, transpose, inverse

$$f(X = x | \mu, \Sigma) = \frac{1}{(2\pi)^{n/2} |\Sigma|^{1/2}} \exp\left[-\frac{1}{2}(x - \mu)^T \Sigma^{-1}(x - \mu)\right]$$

The diagram shows the multivariate Gaussian distribution formula. Four arrows point from the text labels below to the corresponding parts of the formula: x , μ , $|\Sigma|$, and Σ^{-1} .

- Determinant of covariance matrix** (points to $|\Sigma|$)
- Distribution covariance matrix** (points to Σ^{-1})
- Distribution mean vector** (points to μ)
- Observed vector of random variables (features)** (points to x)

Useful skills - 2

- probability and statistics

Bayes' Rule allows us to update prior beliefs with new evidence,

$$P(W_i) \left[\frac{\overset{\text{Likelihood}}{\downarrow} P(O | W_i)}{\sum_j P(O | W_j) P(W_j)} \right] = P(W_i | O)$$

Prior Probability *Evidence P(O)* *Posterior Probability*

Useful skills – 3

- signal processing and natural language processing
- Examples:
 - Spectrum and spectrogram of a signal
 - count the frequency of all word pairs in text

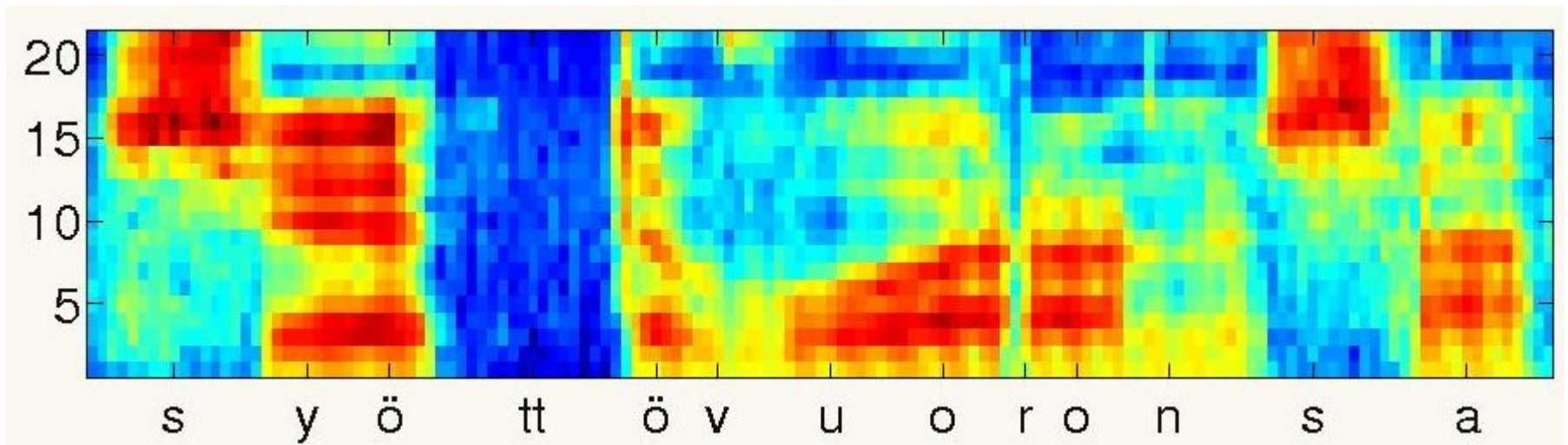

Useful skills - 4

- programming
 - Matlab
 - Linux
 - shell scripts, C/C++, perl/python
- example tasks:
 - Use Matlab toolboxes to compute a spectrum
 - Run programs in Linux and store their output in a file
 - Make a script to run commands many times in loop using increasing parameter values
 - Make a simple program to compute the error rate between the speech recognition result (a string) and the reference text

Content today

1. General organization of the course

2. What is automatic speech recognition?

→ **3. Speech as an acoustic signal**

4. GMMs and DNNs

5. Home exercise 1:

- Build a system to classify speech features into phonemes

6. Kick-start of the group works

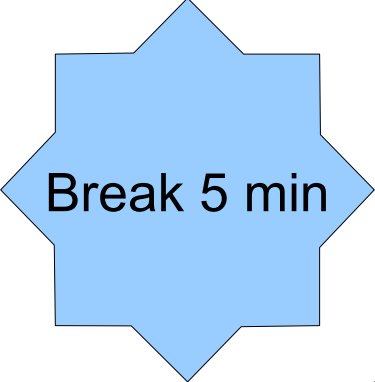

Break 5 min

What is speech recognition?

- **Find the most likely word or word sequence given the acoustic signal and our models!**
- **Language model** defines words and how likely they occur together
- **Lexicon** defines how words are formed from sound units
- **Acoustic model** defines the sound units independent of speaker and recording conditions

What is speech recognition?

- Find the most likely word or word sequence given the acoustic signal and our models!
- **Language model** defines words and how likely they occur together
- **Lexicon** defines how words are formed from sound units
- **Acoustic model** defines the sound units independent of speaker and recording conditions

Speech recording

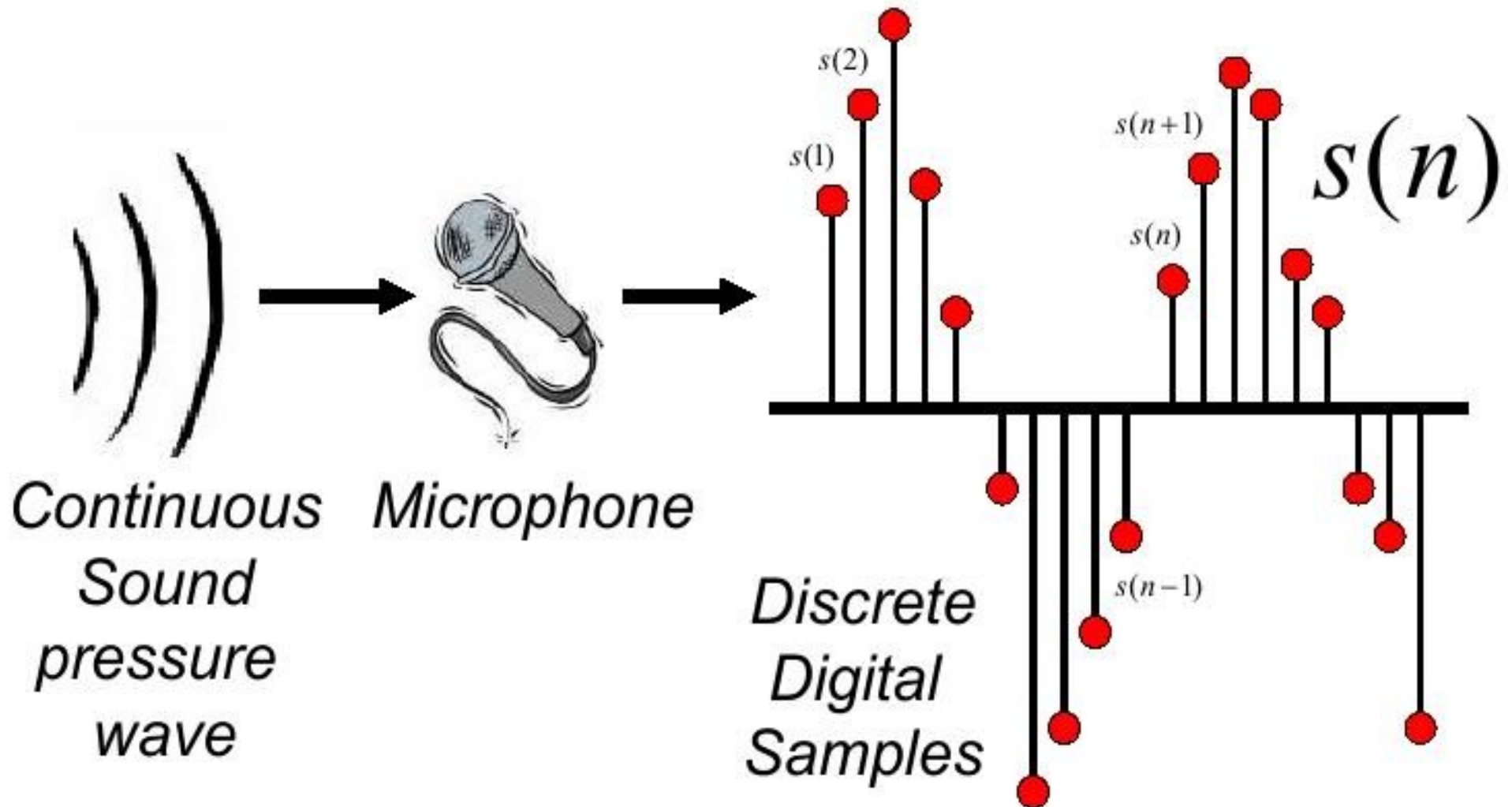

A sample of speech waveform

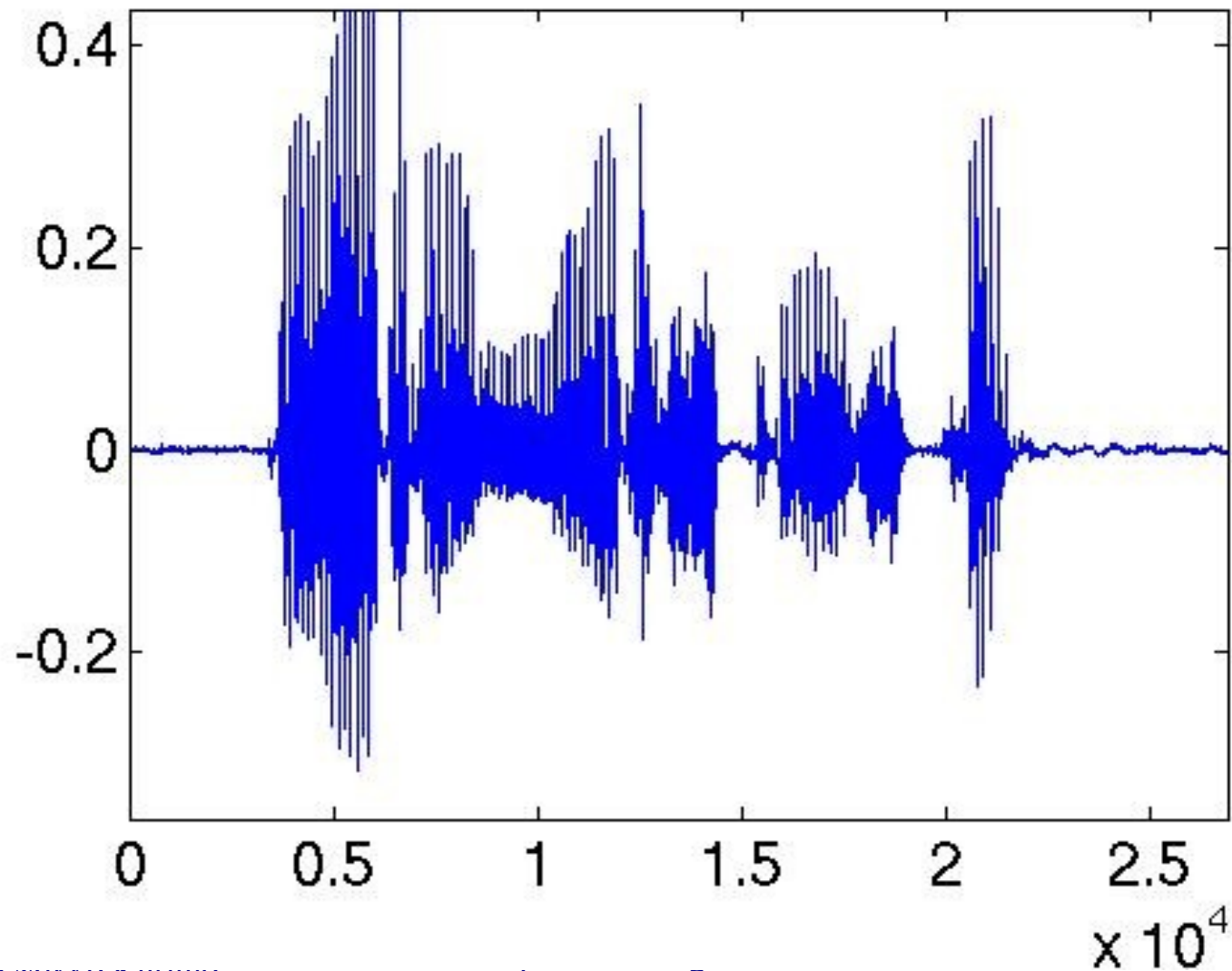

Guess what these 5 recordings contain!

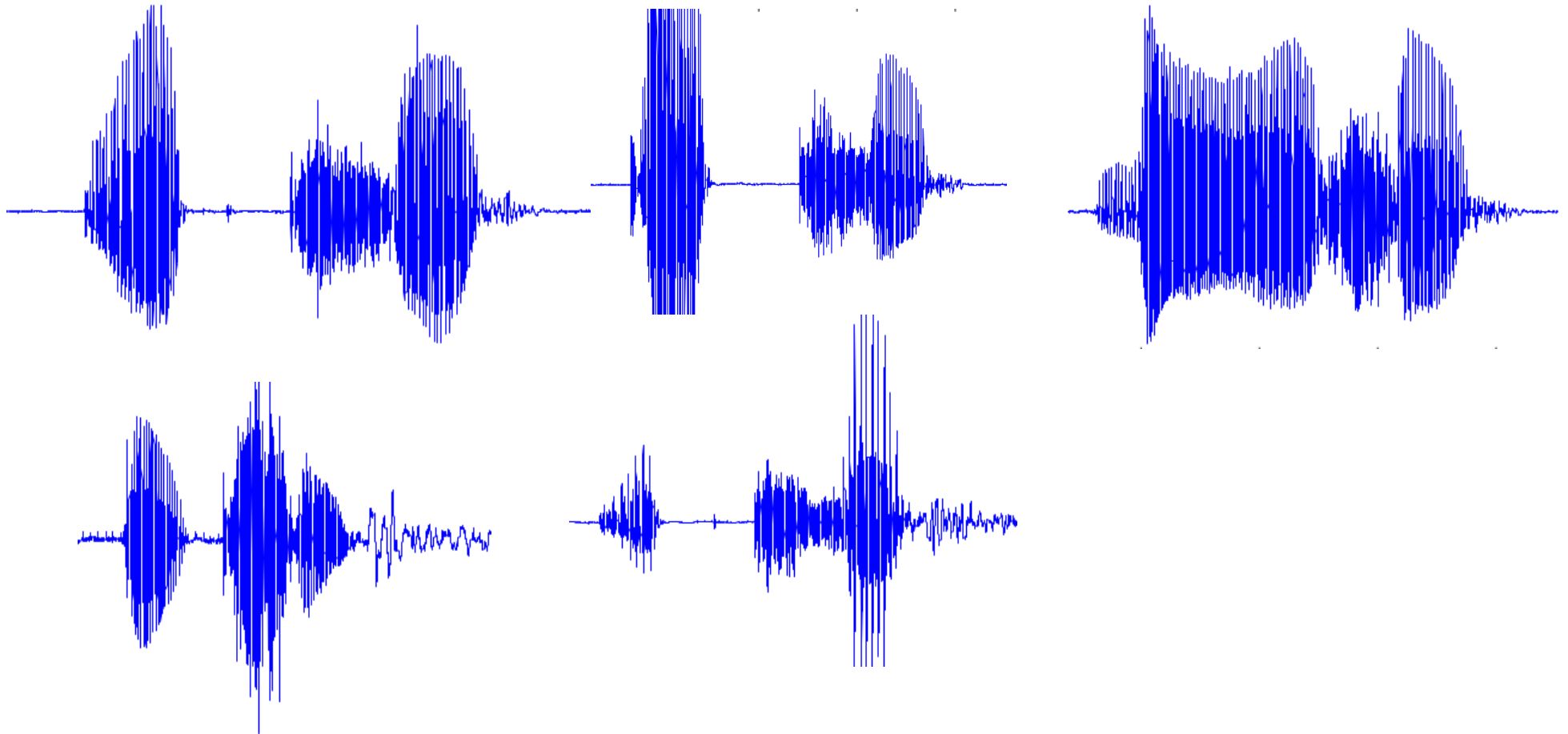

This is only one word

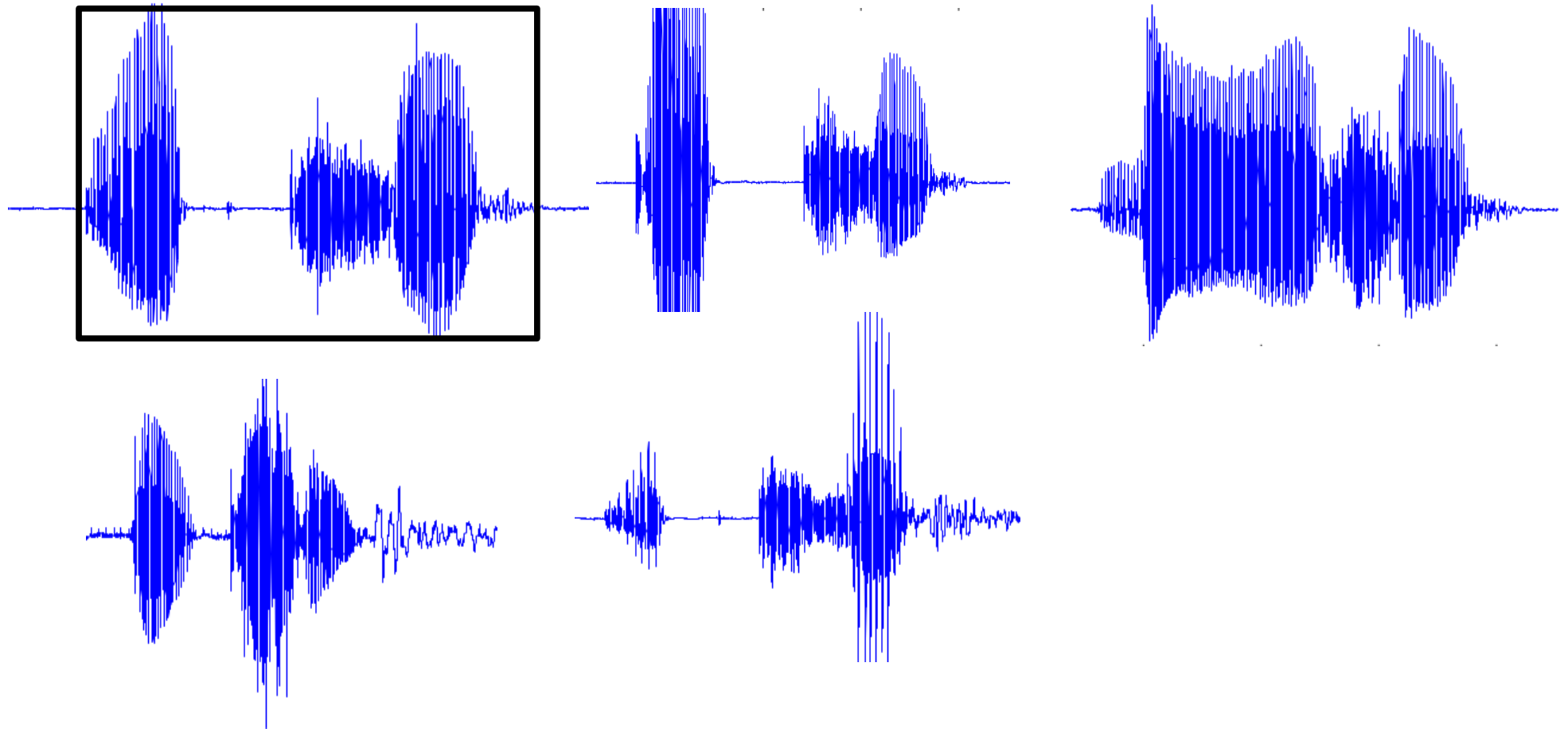



This is only one word

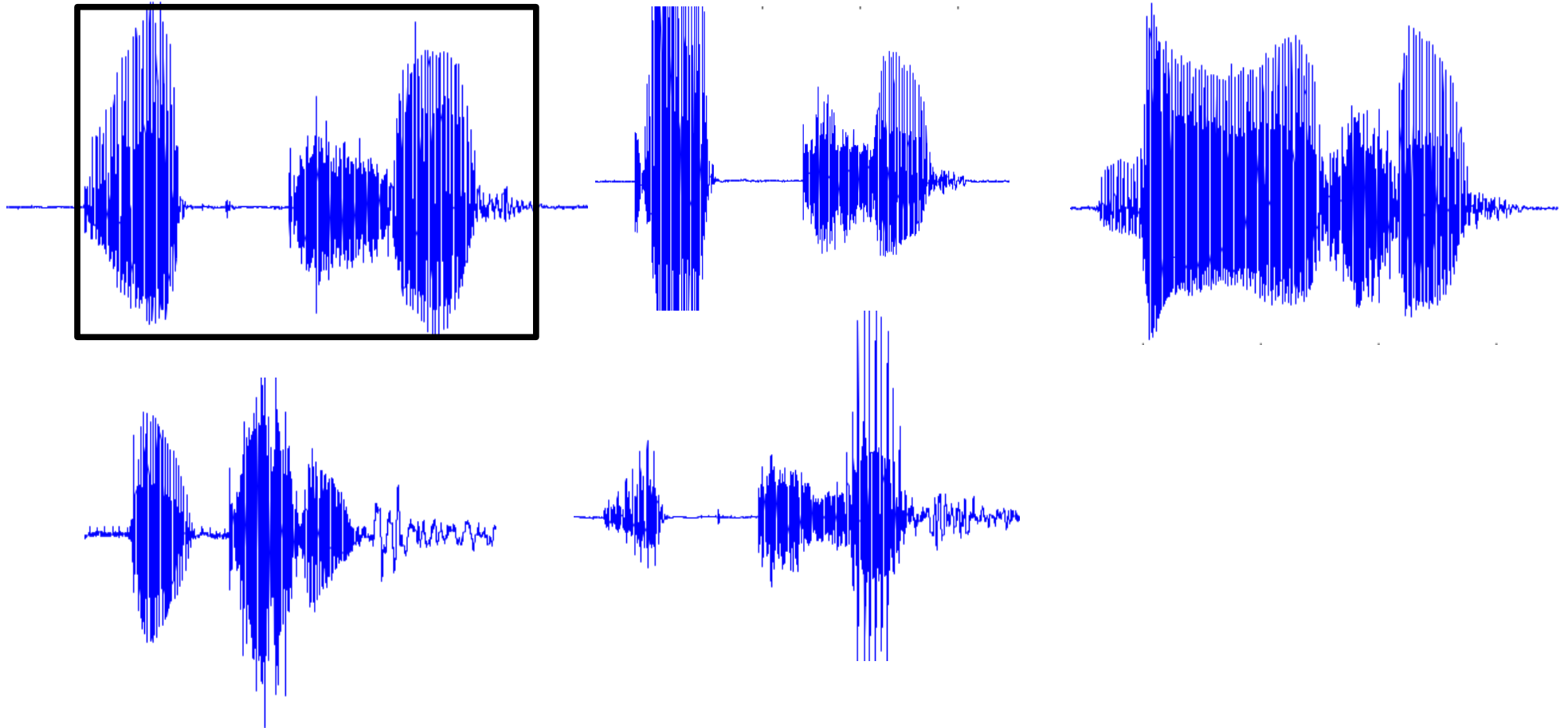

Another word, same speaker

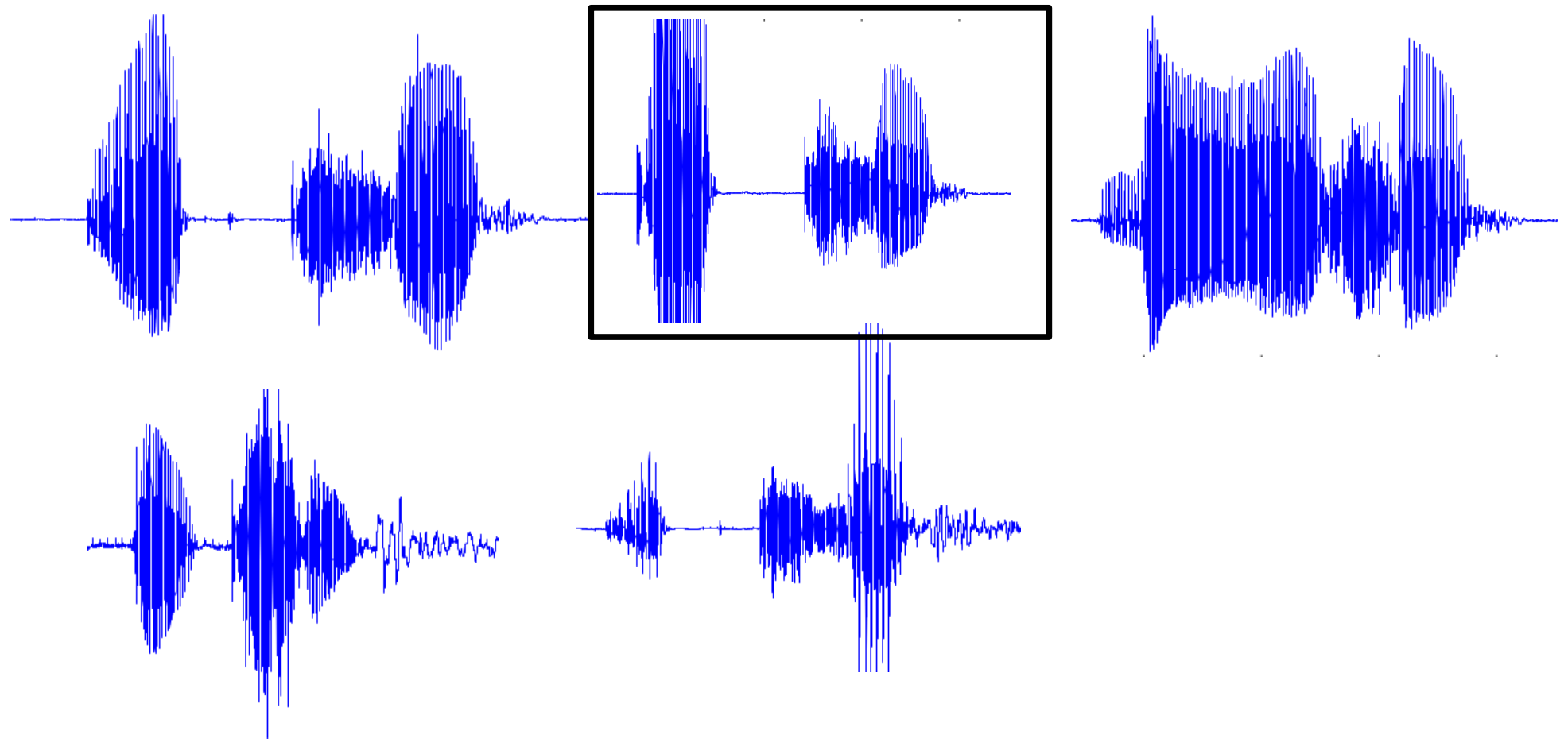



Another word, same speaker

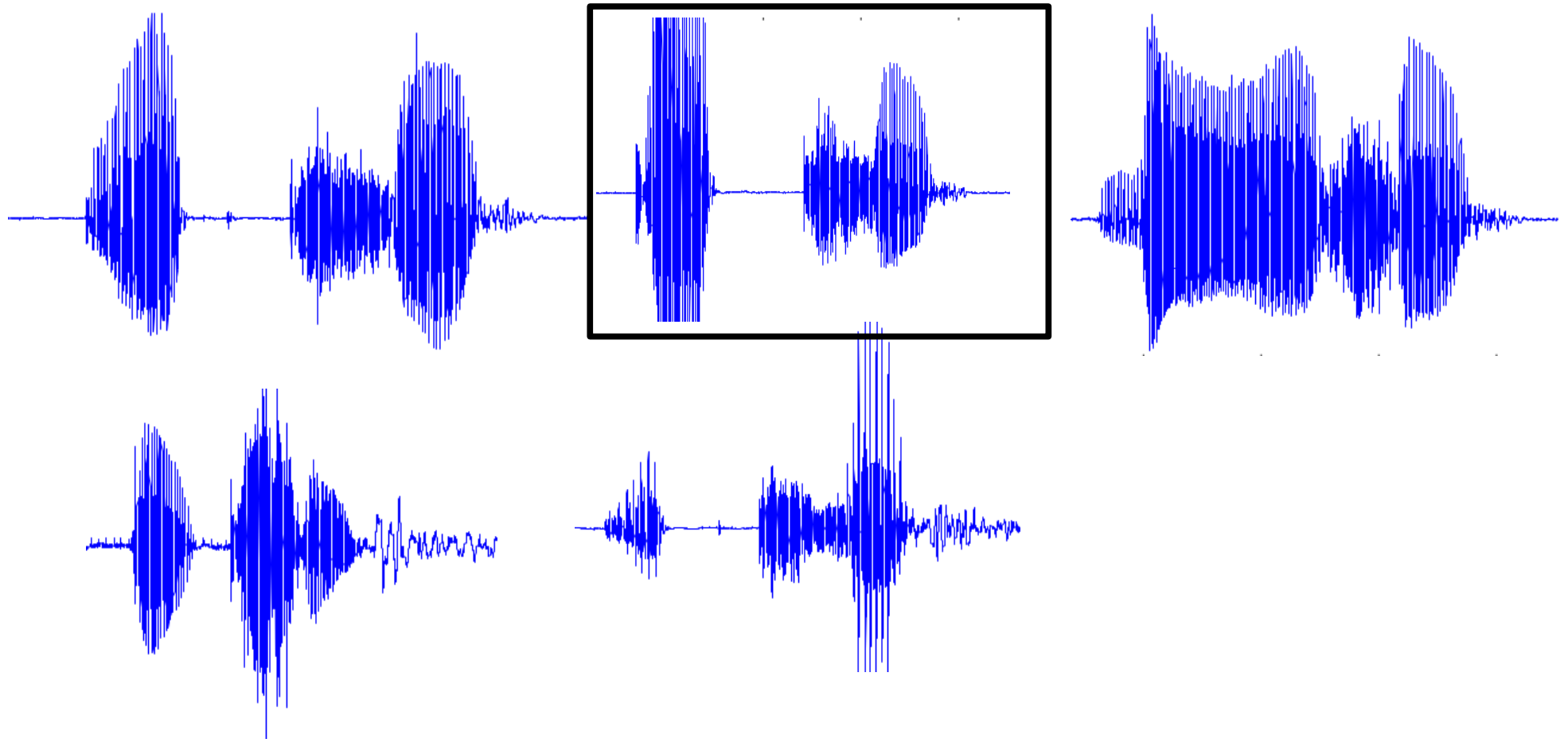

Another word, same speaker

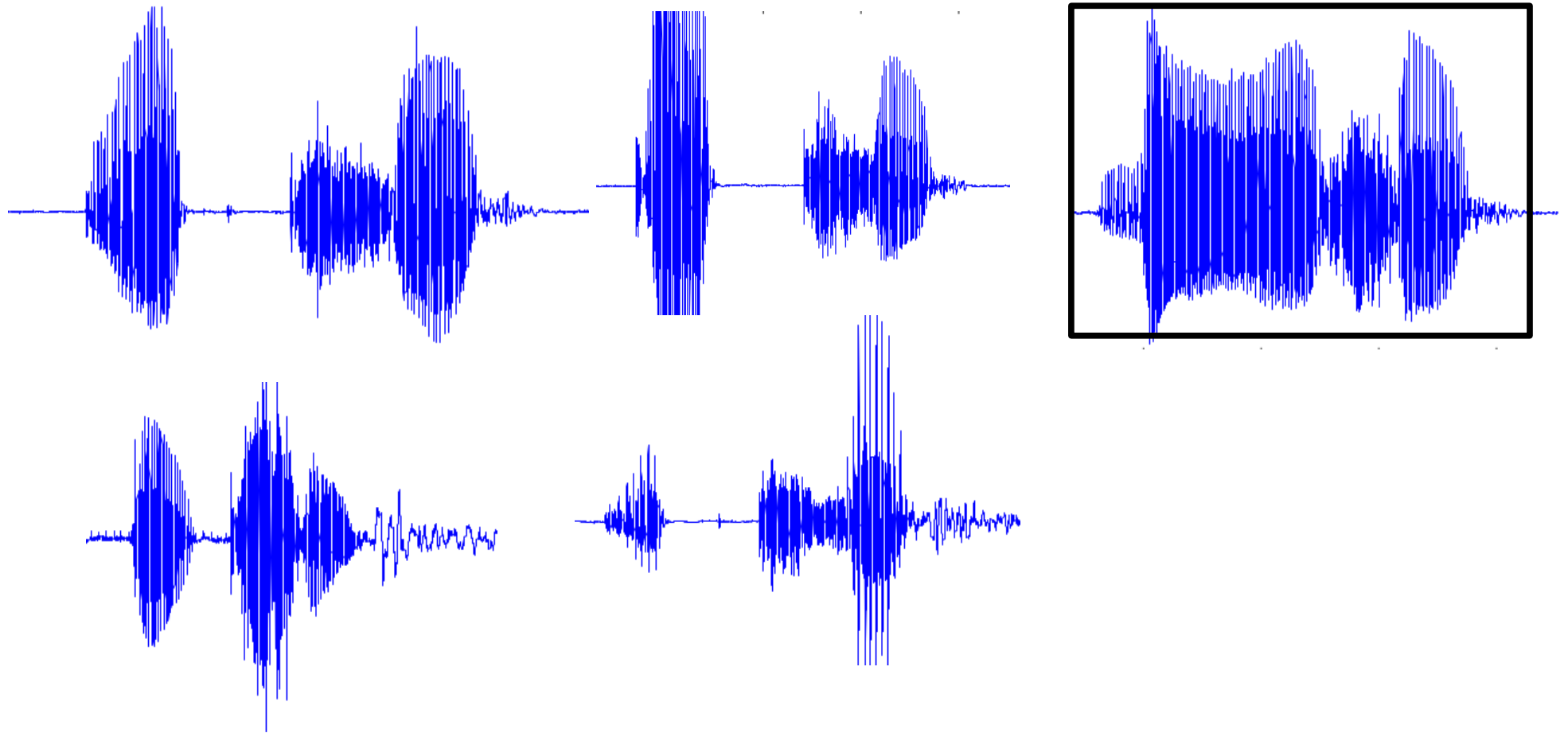



Another word, same speaker

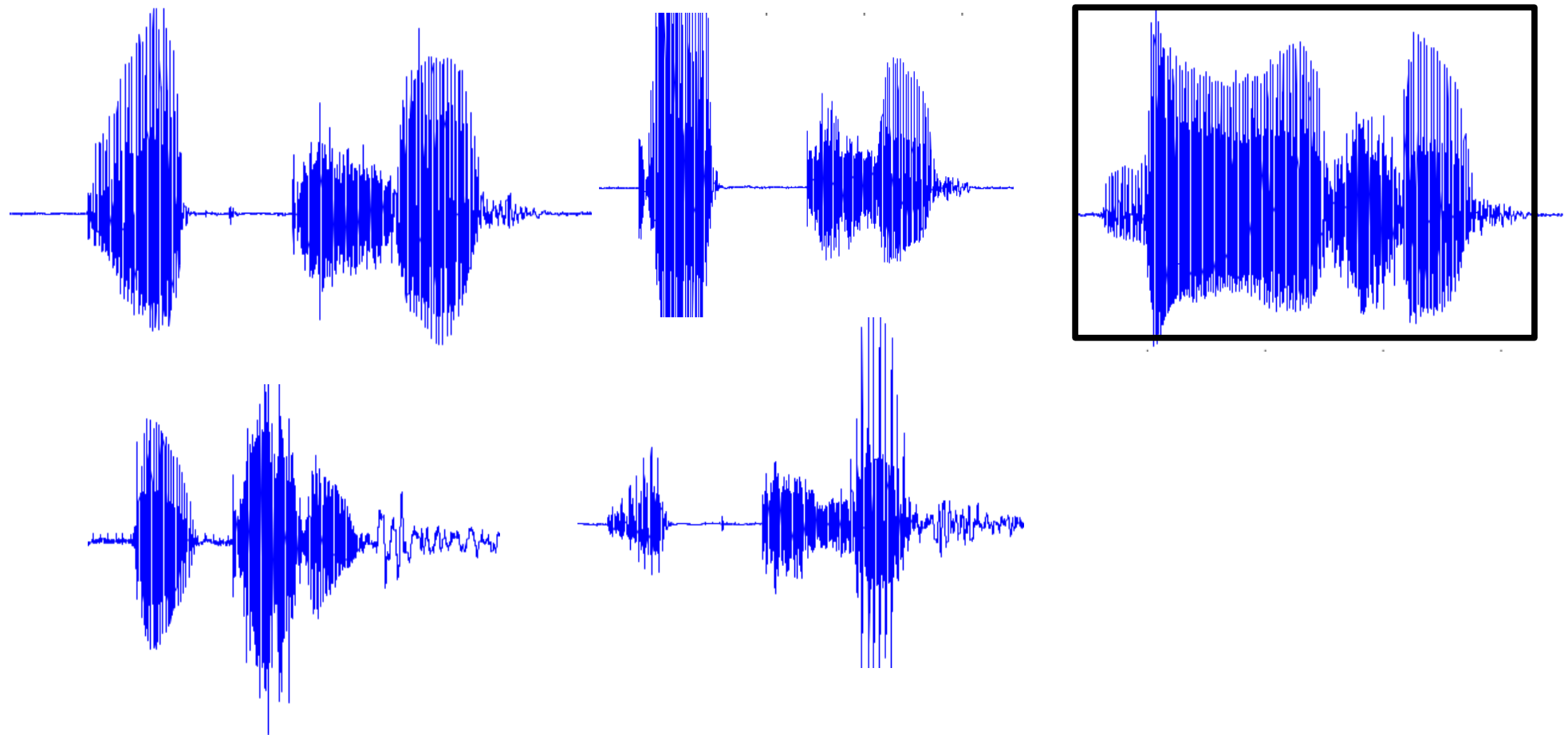

Original word, different speaker

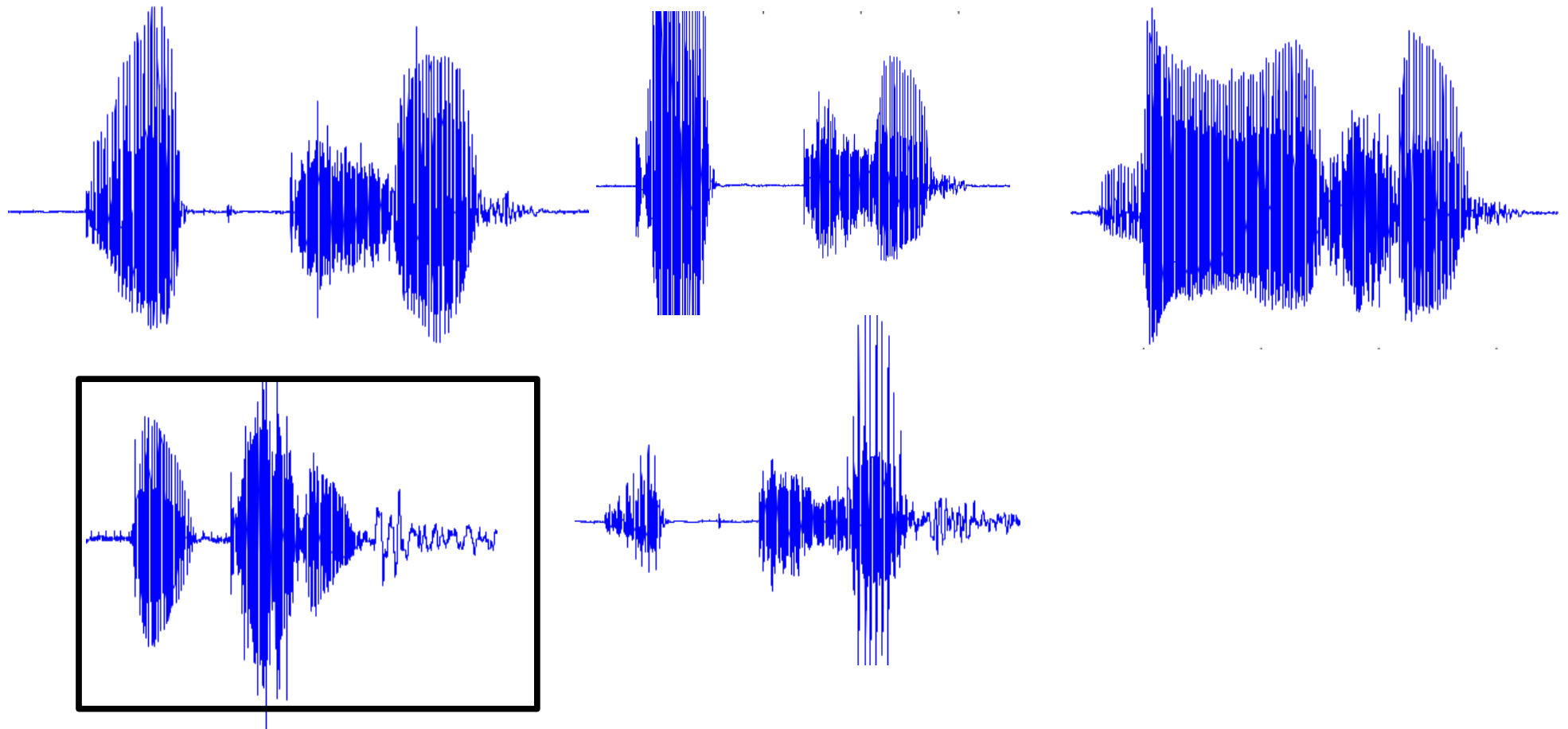



Original word, different speaker

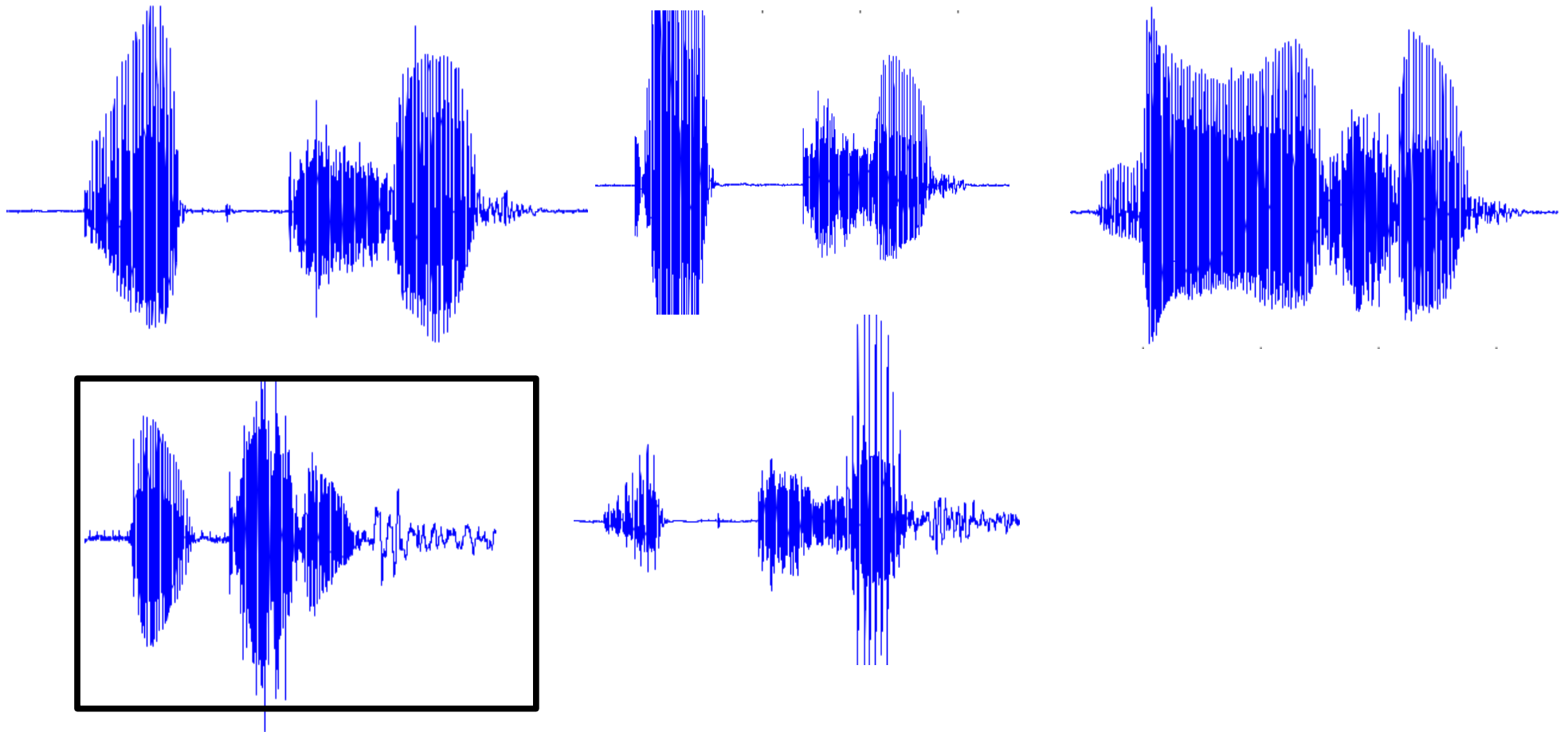

Original word, different speaker

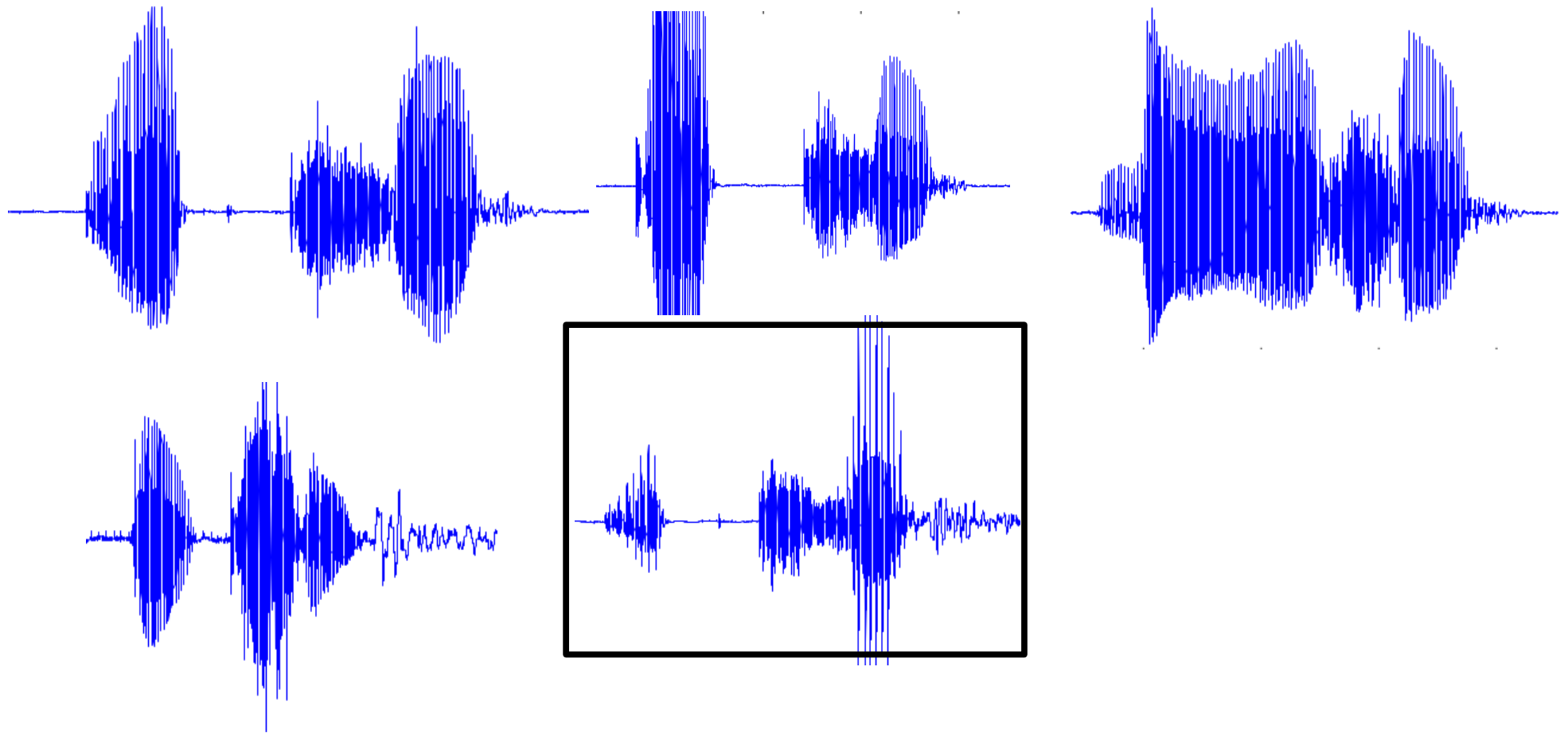



Original word, different speaker

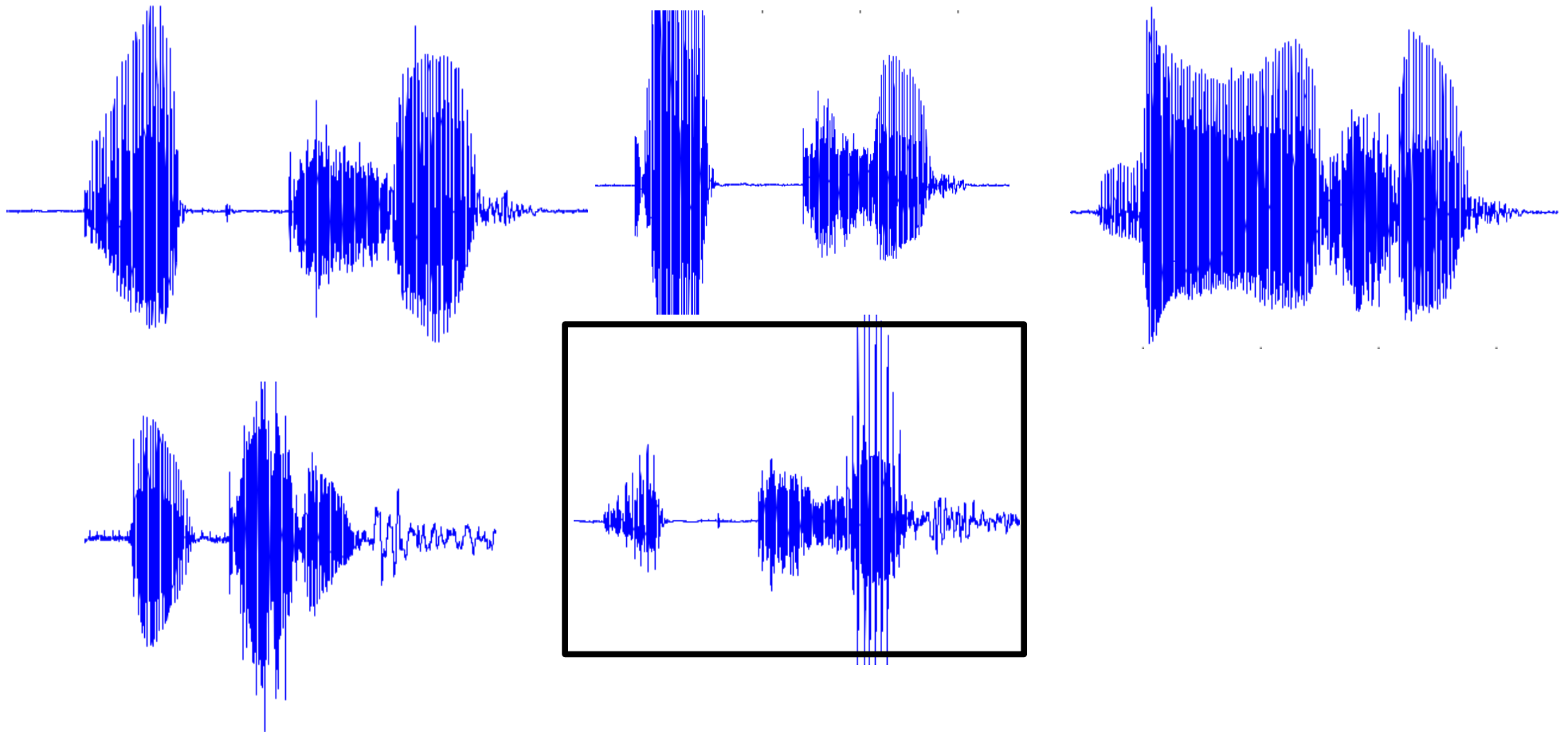

Other words, other speakers

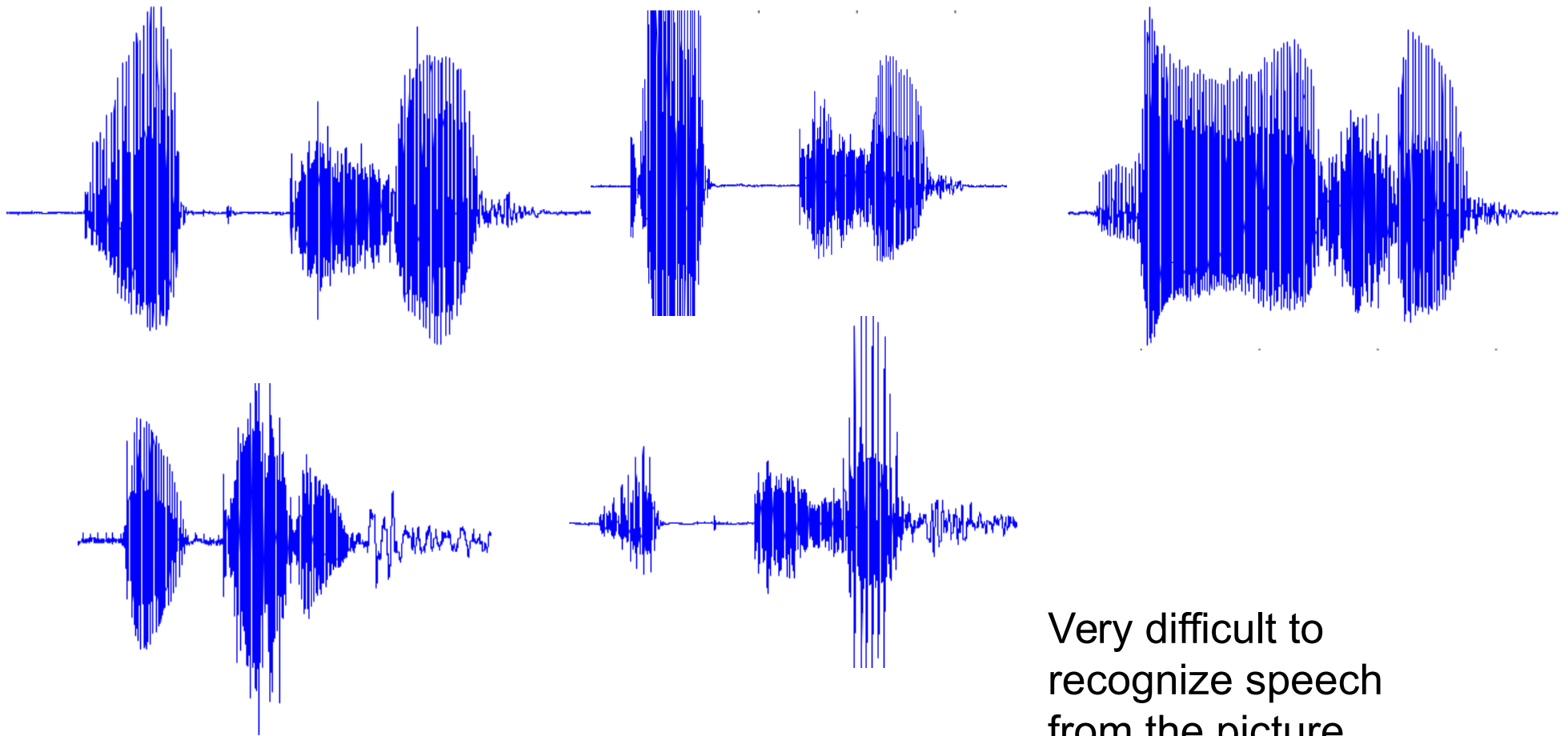

Modelling the speech signal

Discussion: What separates speech from all the other sounds that the microphone has recorded?

- computer noise, car noise, human movements, other sounds from the mouth, ...
- so, what is special in speech and common in all speaking situations

*Why these discussions?
Learning happens, when:
+ brains are active and alert
+ new knowledge contradicts
your old beliefs*



How to recognize speech?

A simple procedure:

- Measure some **characteristic features** of the signal and estimate statistical models for them

Good features should be:

- ?
- ?
- ?
- ?

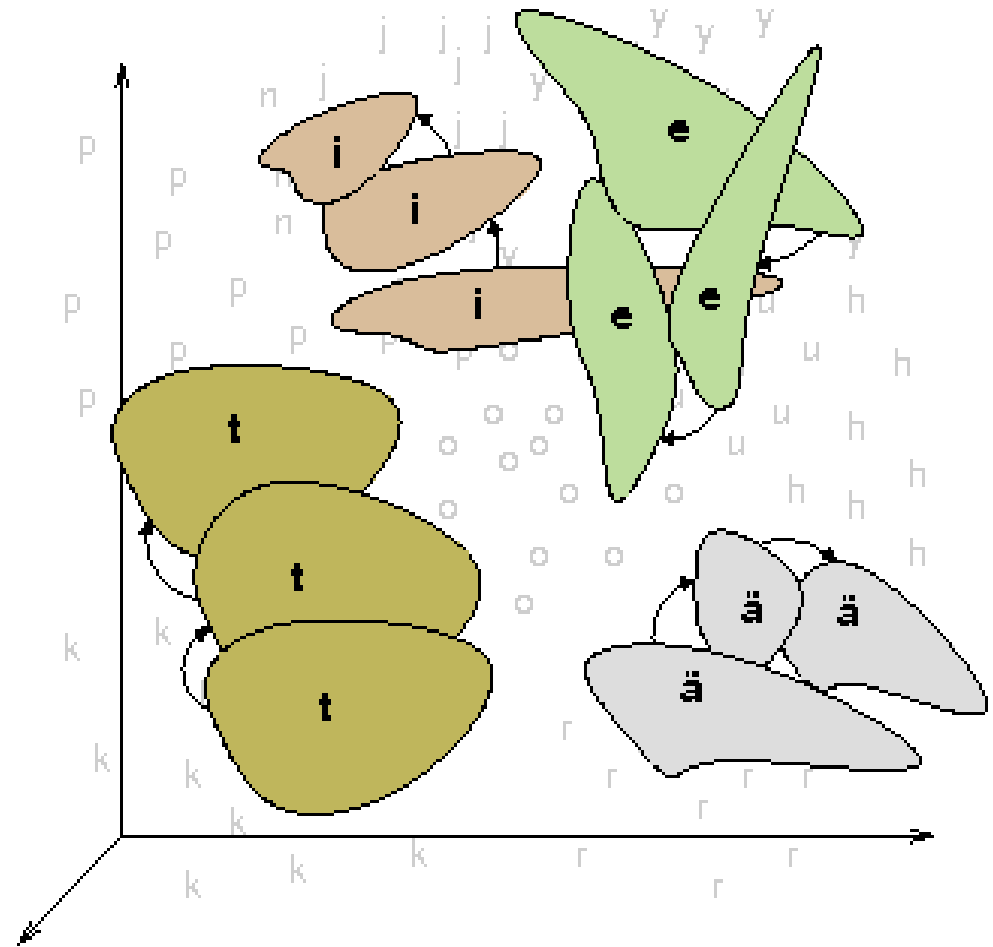

How to recognize speech?

A simple procedure:

- Measure some **characteristic features** of the signal and estimate statistical models for them

Good features should be:

- Compact
- Discriminative for speech sounds
- Fast to compute
- Robust for noise

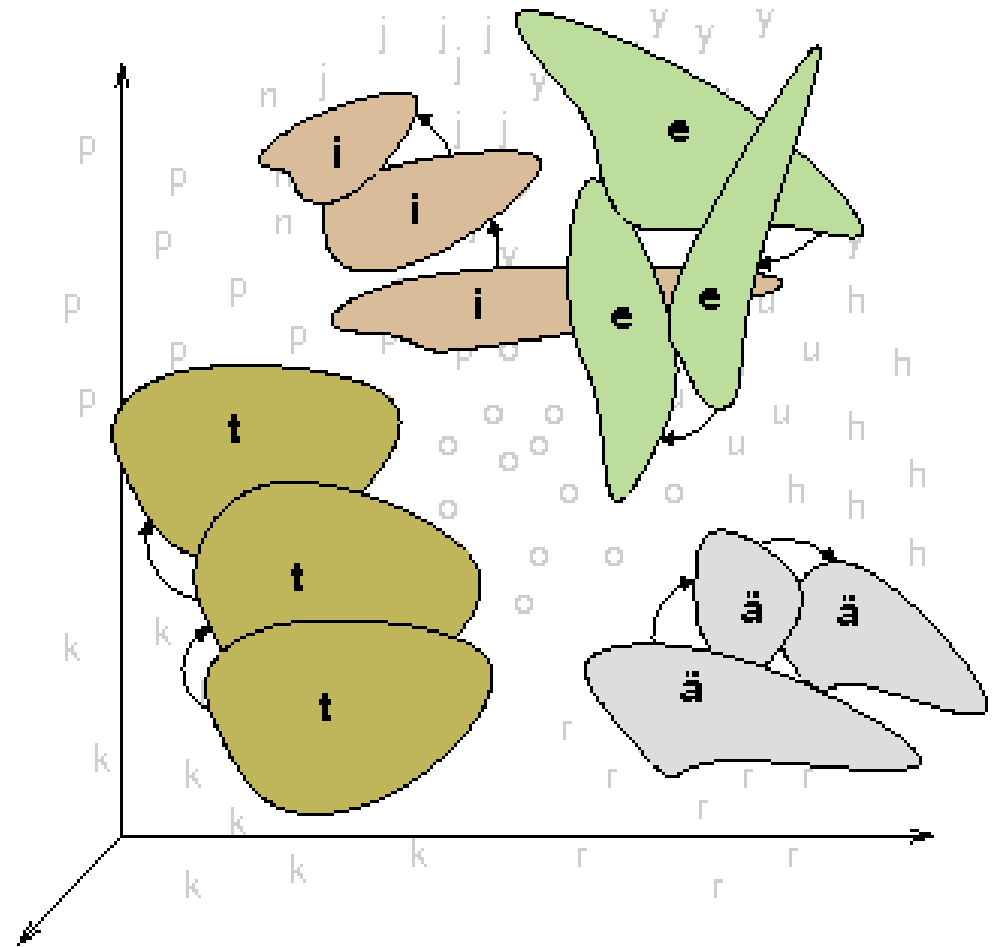

Frequency analysis

Calculate the spectrum in short time intervals

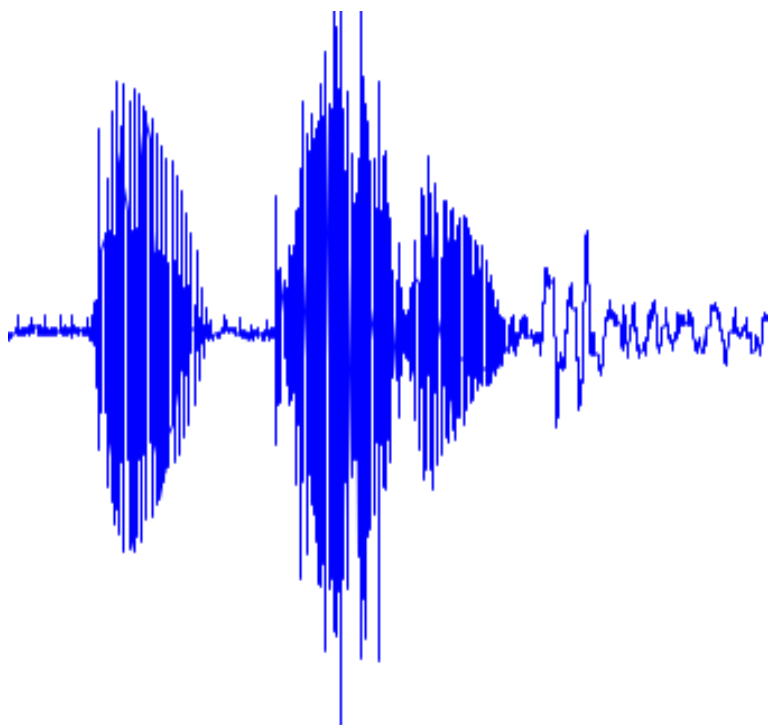

Frequency analysis

Calculate the spectrum in short time intervals

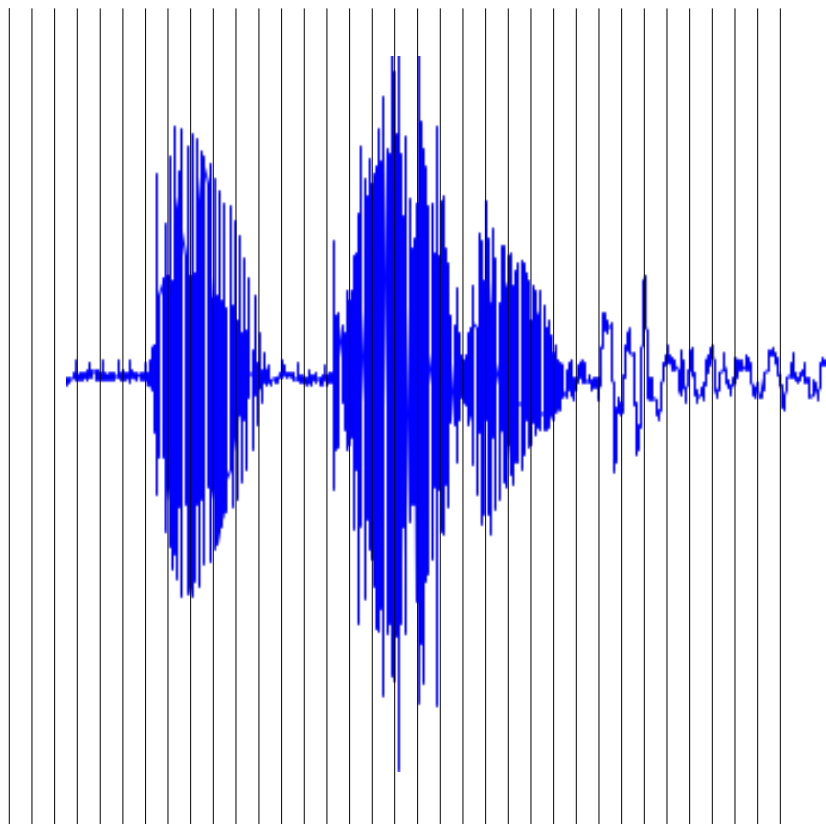

Frequency analysis

Calculate the spectrum in short time intervals

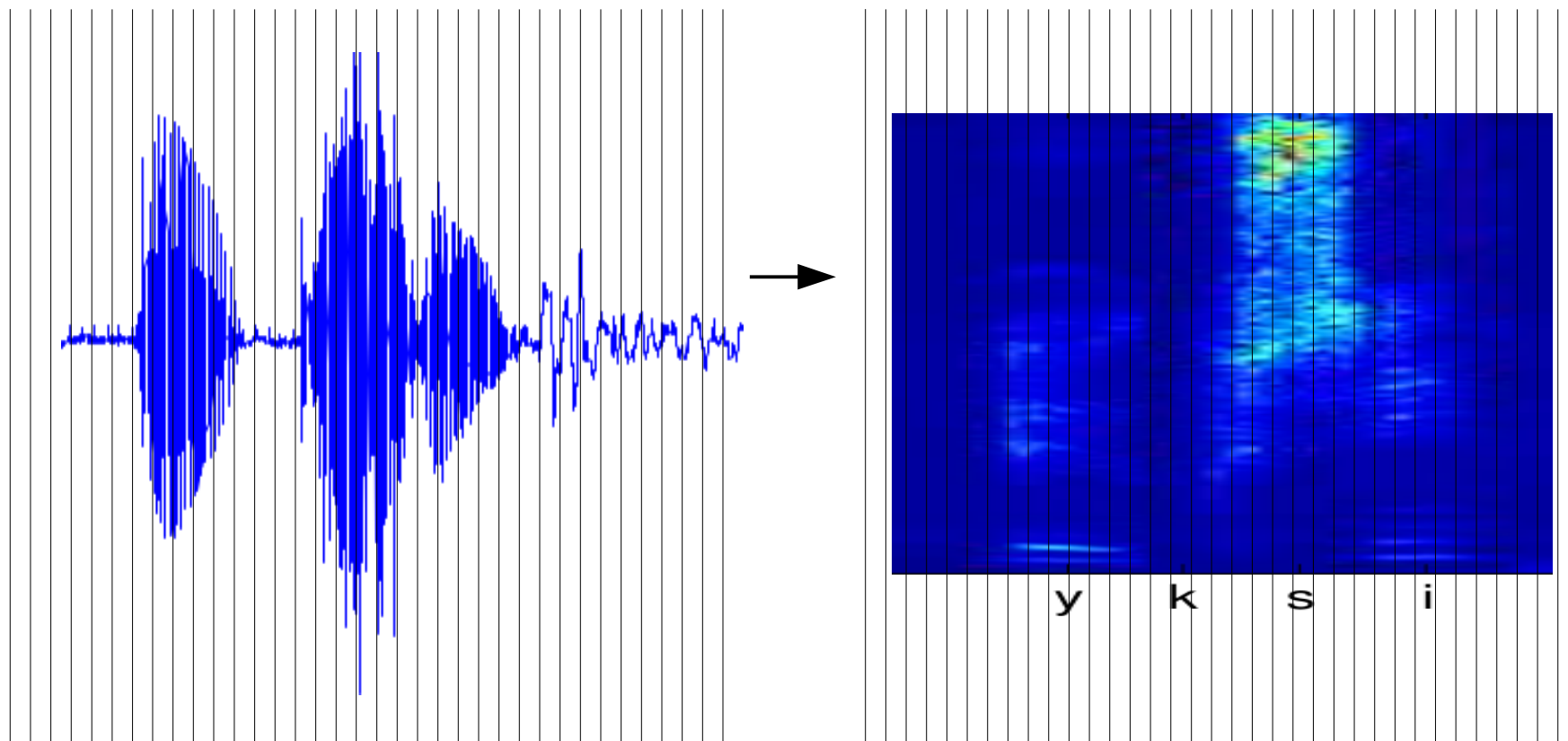

Mel scale

Approximation of **human**
perception of speech

*“Divide the frequency scale into
perceptually equal intervals”:*

Linear below 1 kHz, logarithmic
above 1 kHz

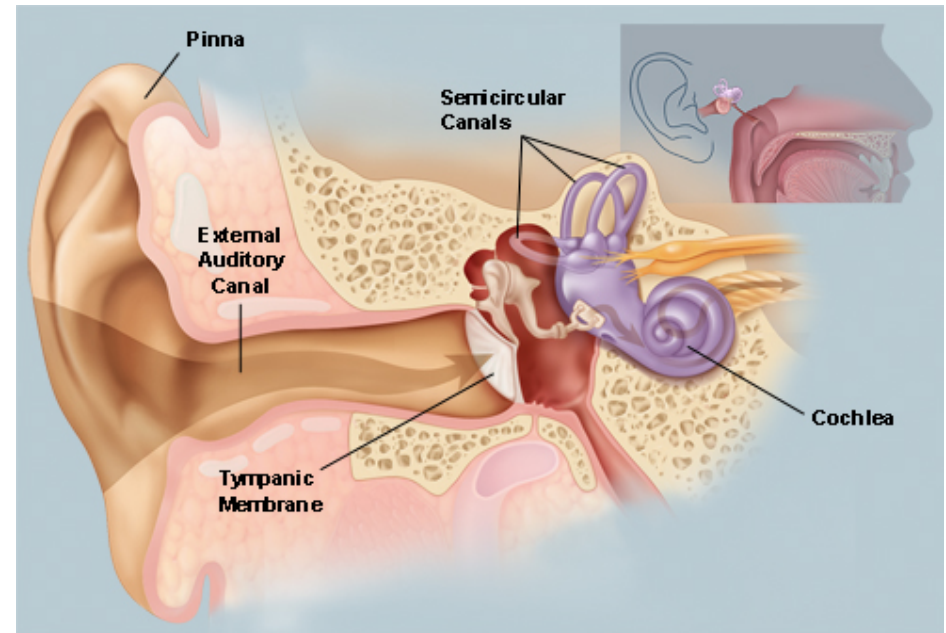

Computation of MFCC

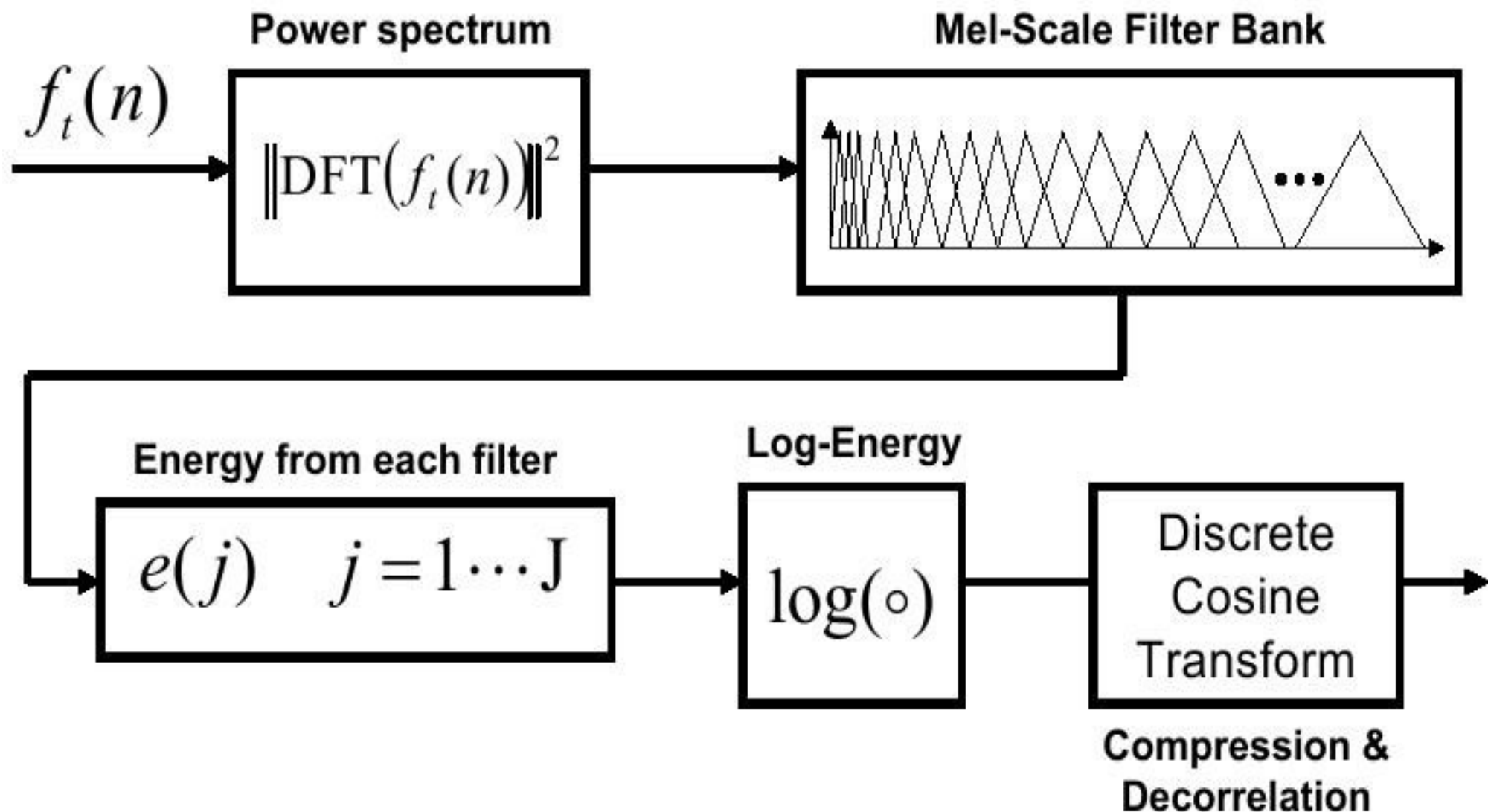

In Matlab: computation of MFCC

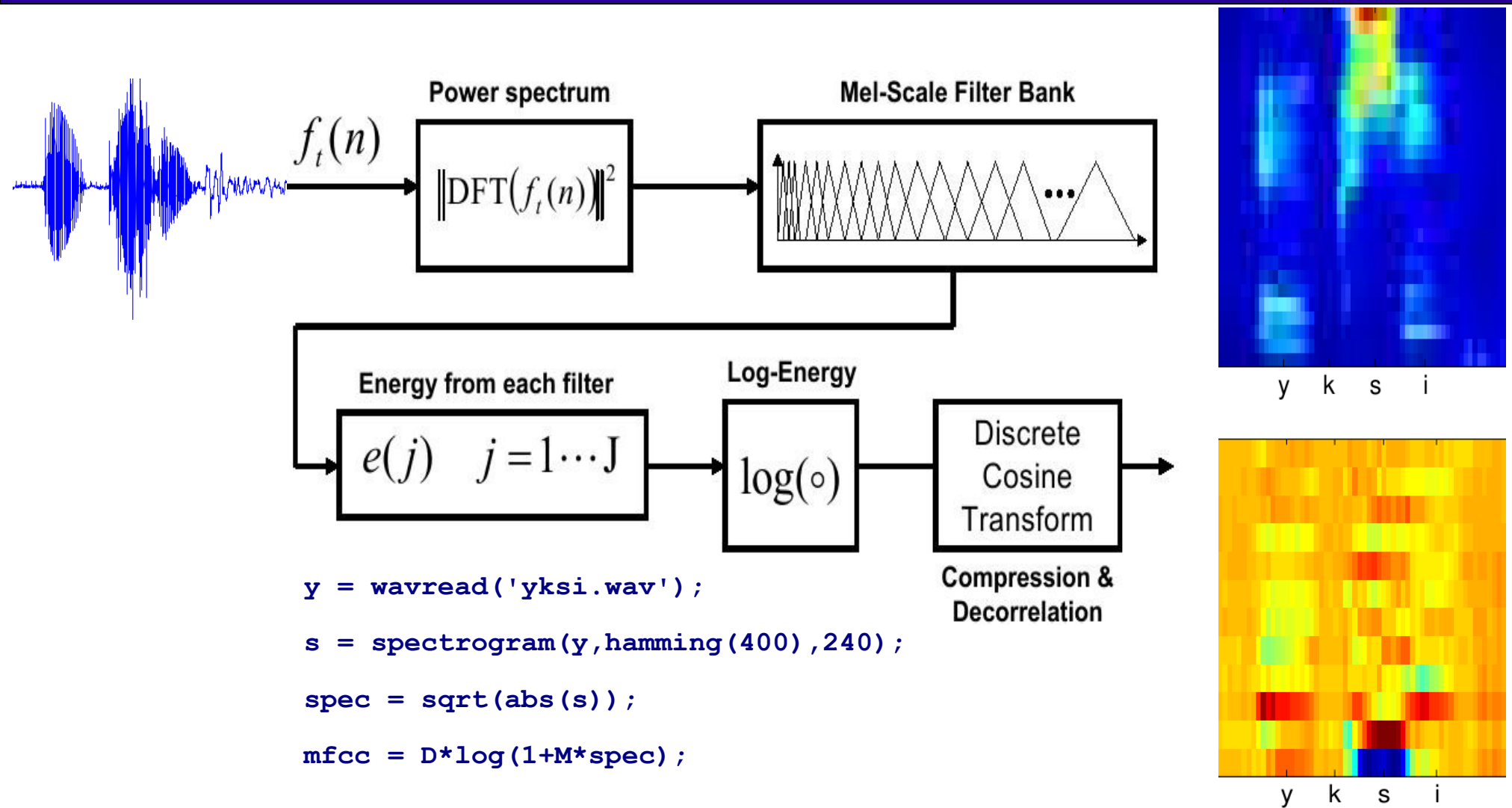

Cepstrum

Cepstrum is essentially “a spectrum of a spectrum”:

- Analysis in frequency scale (vertical direction)

MFCC = Mel-Frequency Cepstral Coefficients

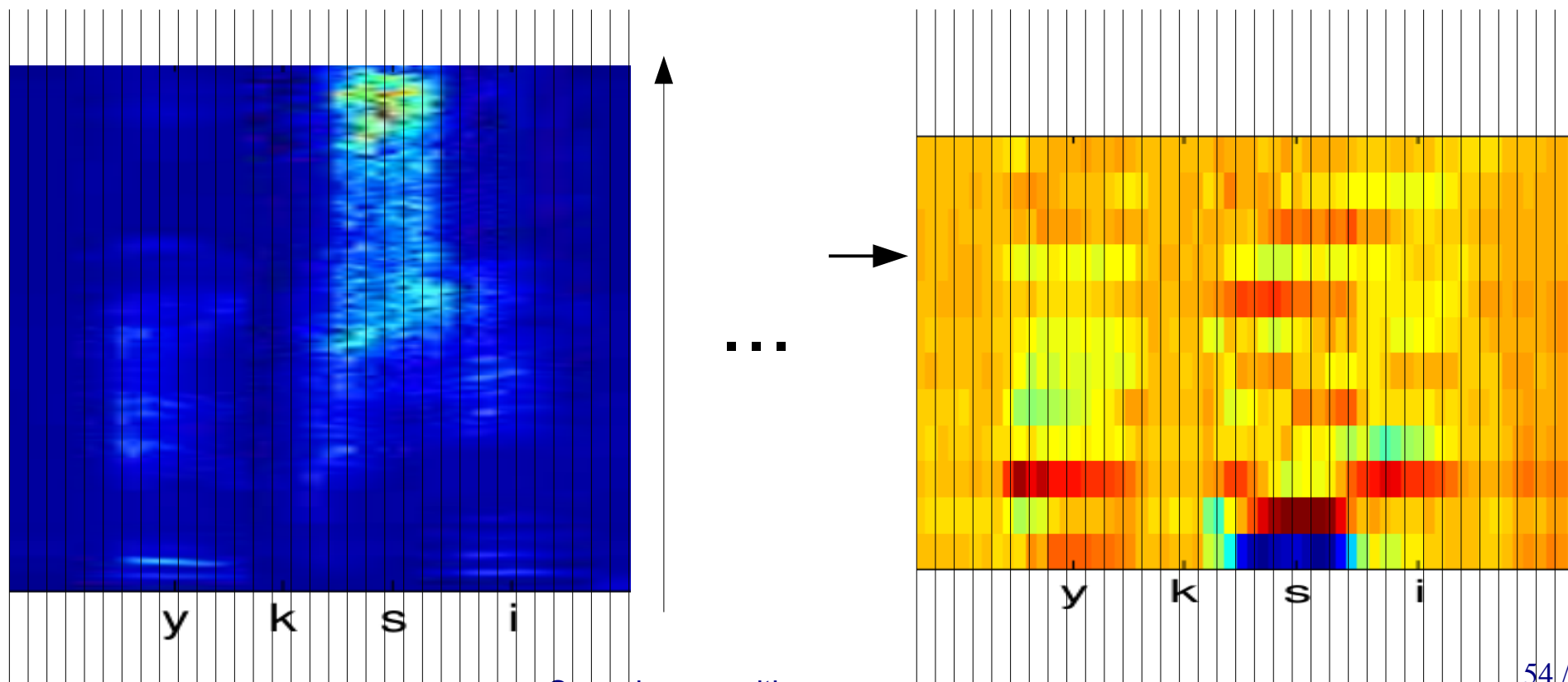

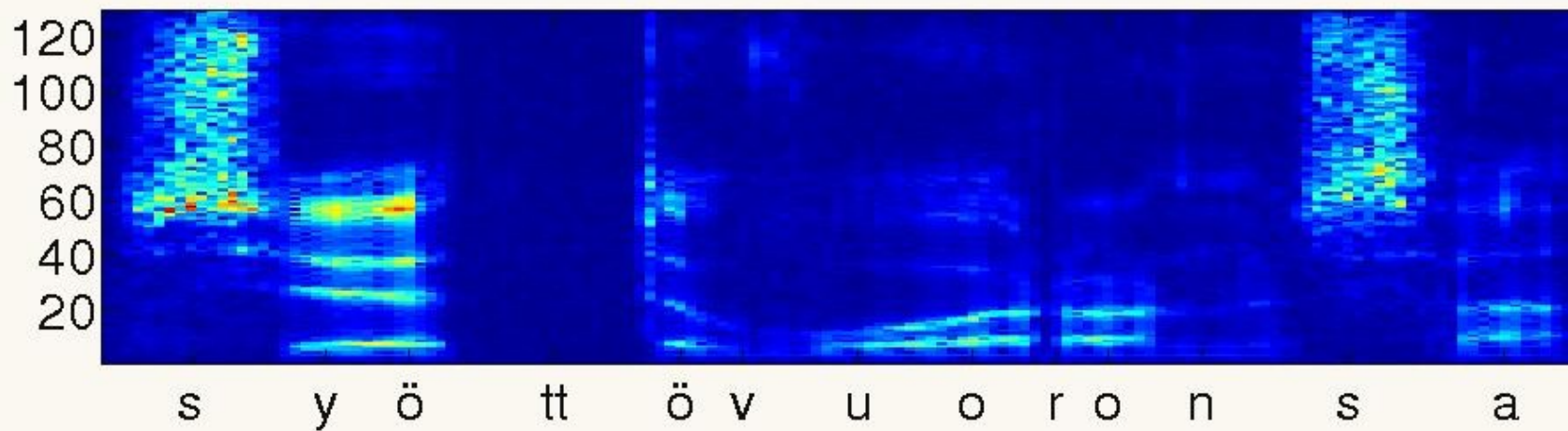

1. Frames: short 10ms windows
2. FFT: power spectrum **spectrogram**

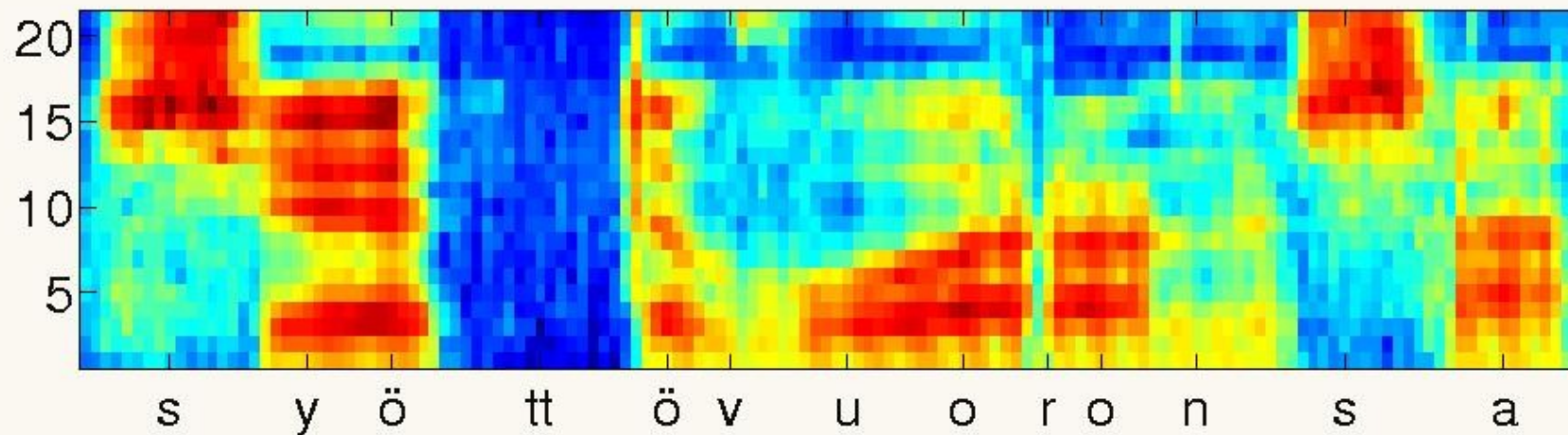

3. Filtering: mel filter motivated by human ear "essential data"

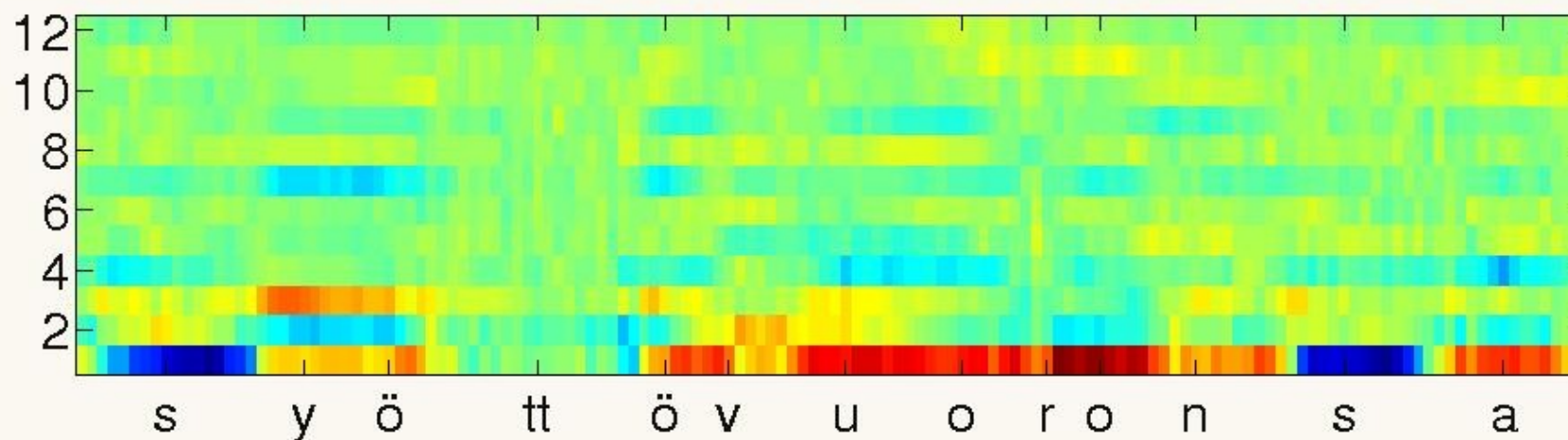

4. Features: DCT transform mel cepstrum MFCC -less features -less correlation

The same 5 samples again

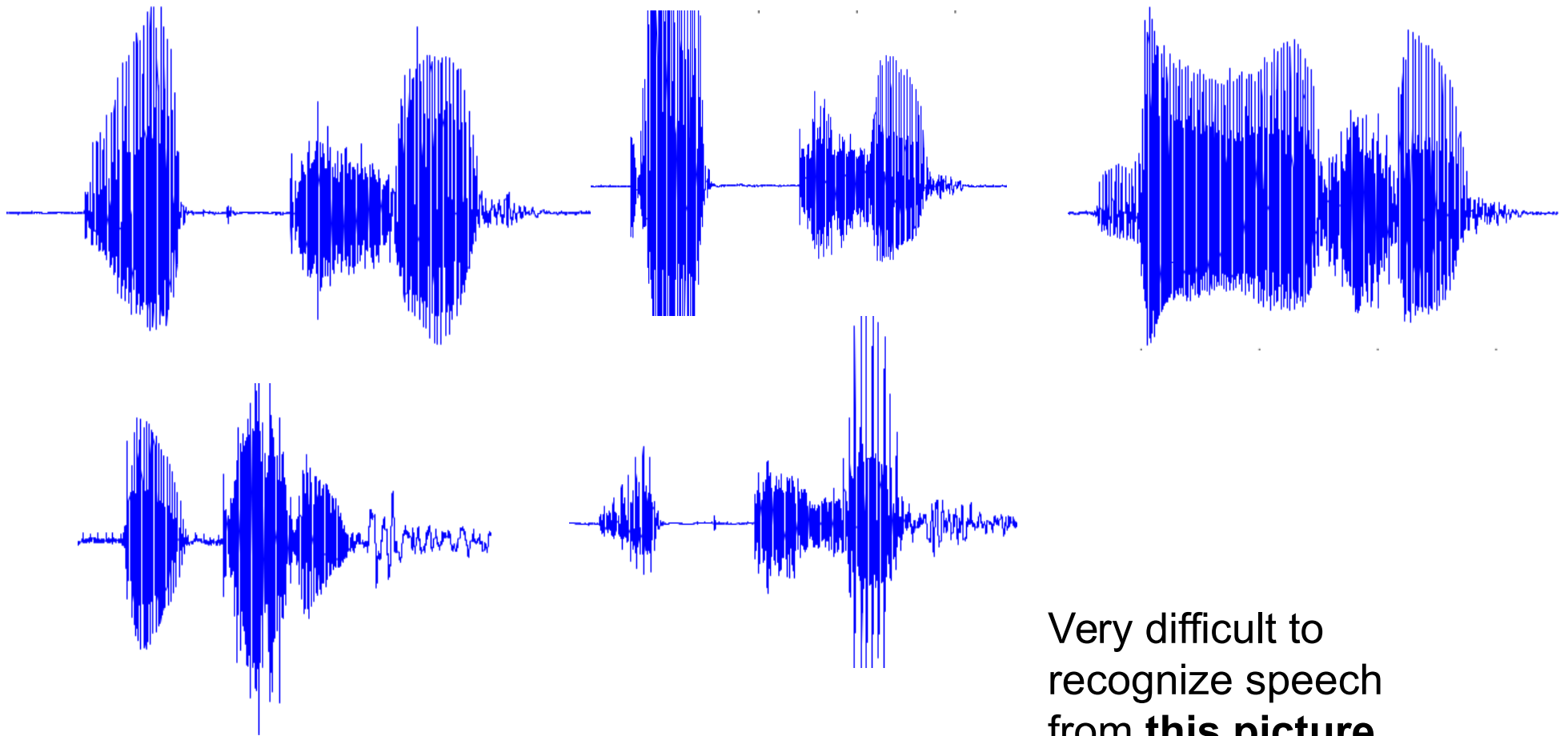

Very difficult to recognize speech from **this picture...**

Power spectrogram

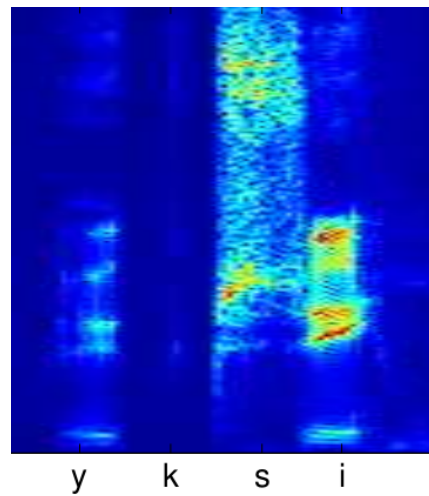
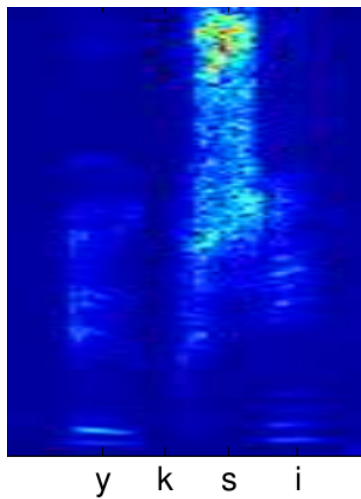
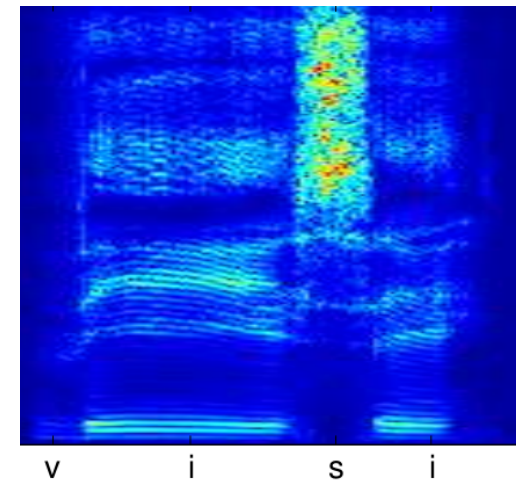
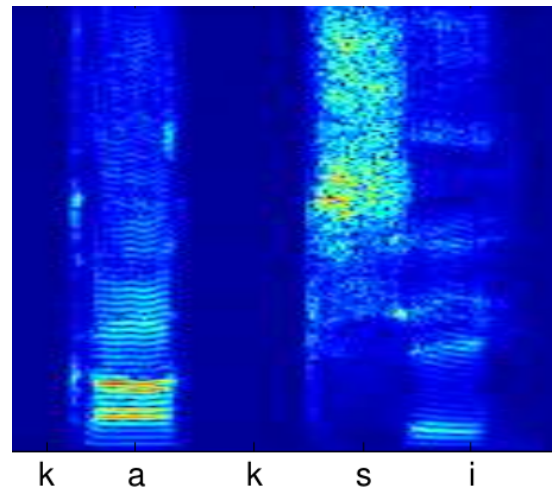
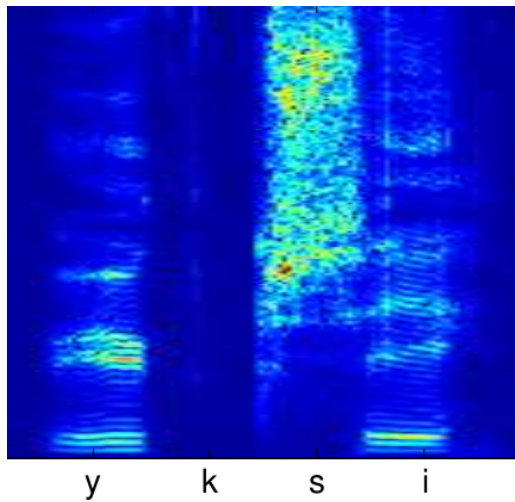

- Speech recognition possible
- Lot of data
- Lot of redundancy
- Lot of noise

Mel spectrogram

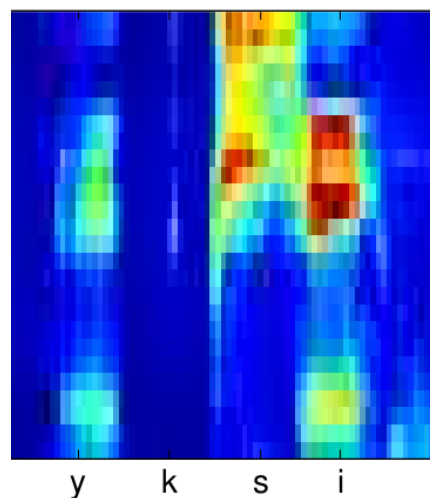
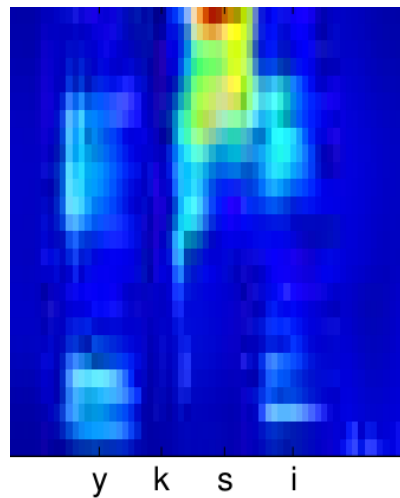
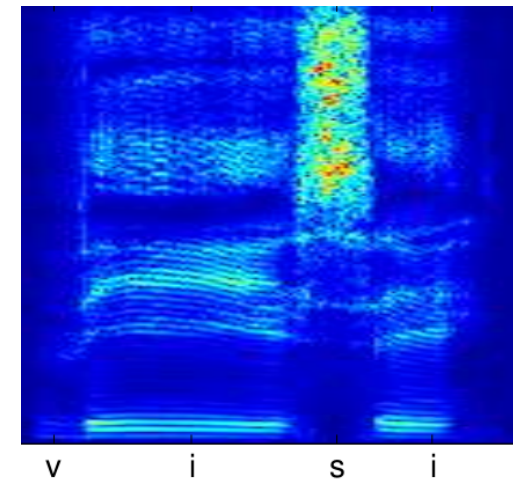
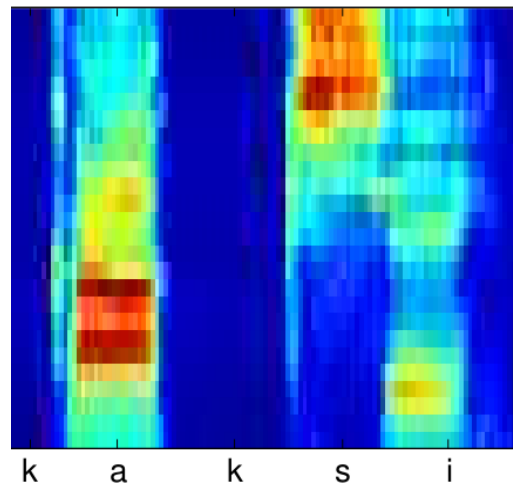
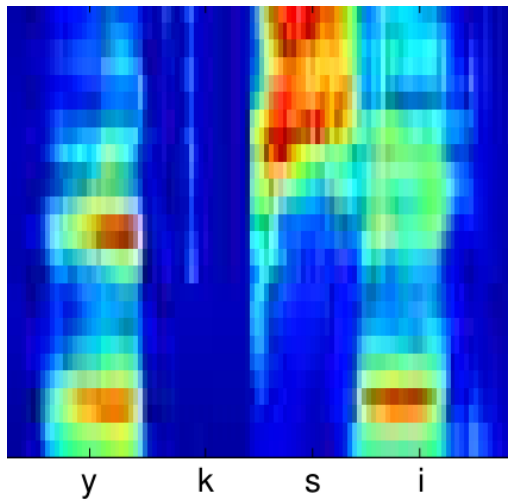

- Speech recognition maybe easier?
- 10 x less data
- Less redundancy
- Less noise

Mel-frequency cepstral coefficients (MFCC)

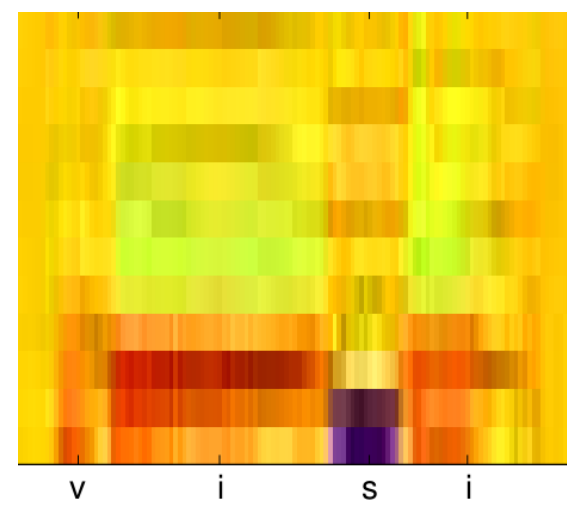
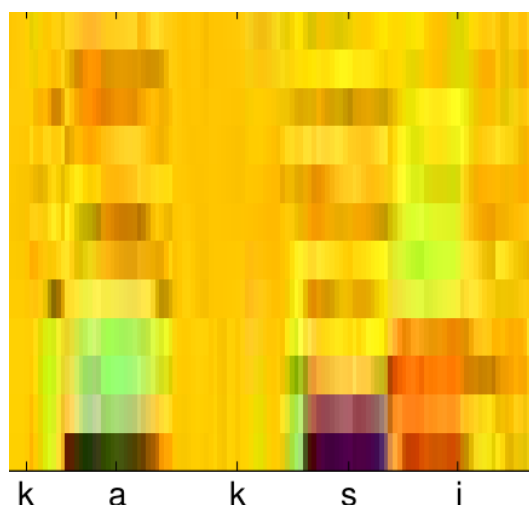
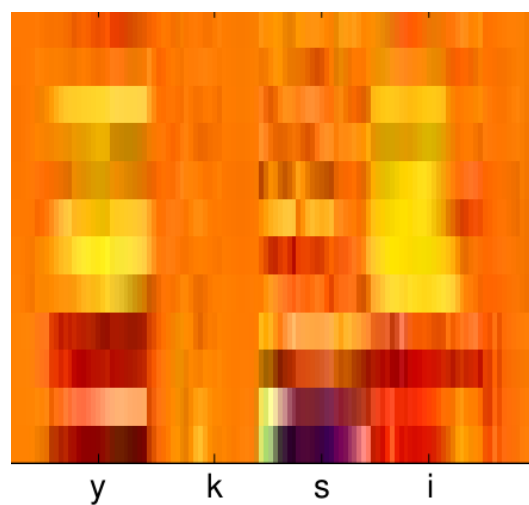

- Even more compact
- Less correlation
- Less noise?

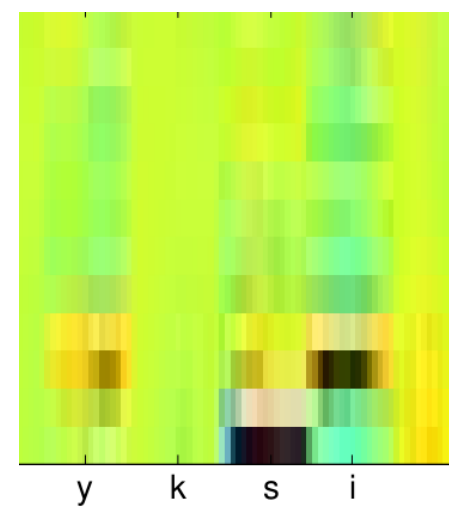
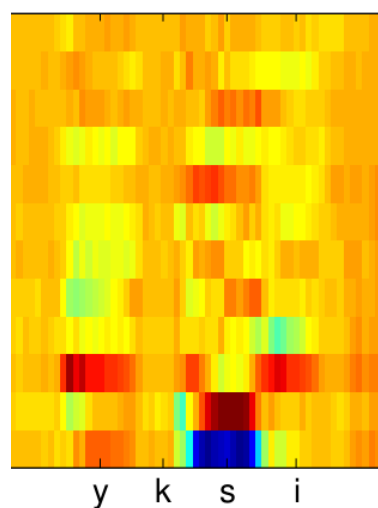

Background noise?

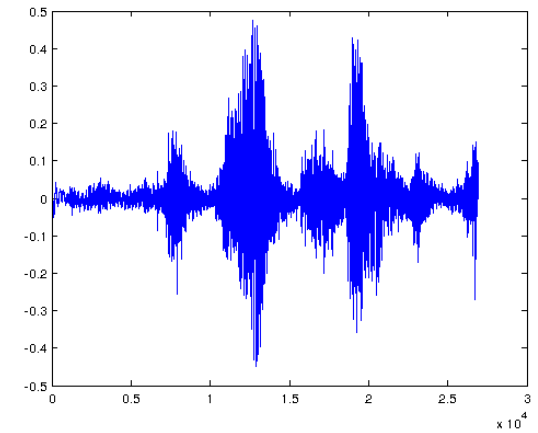
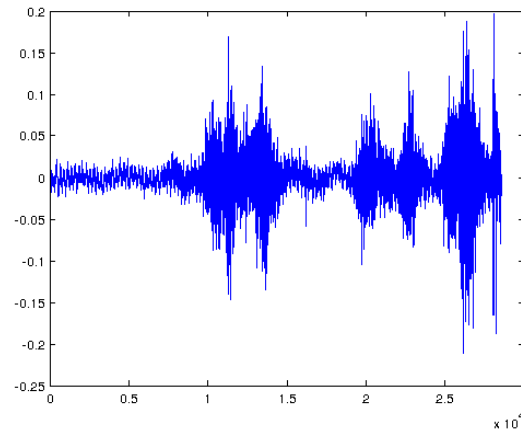
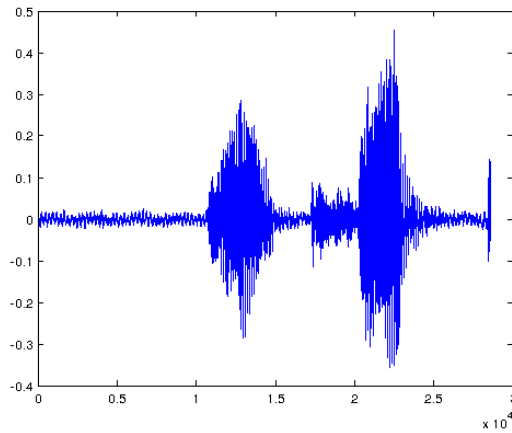

Background noise?

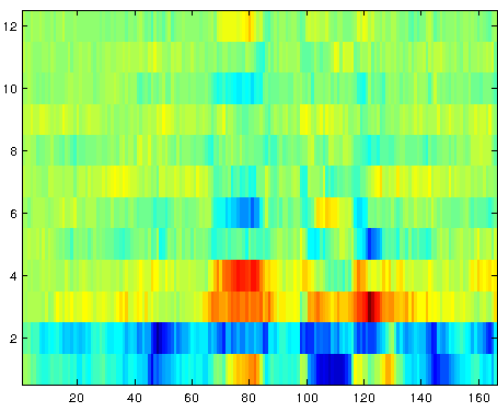
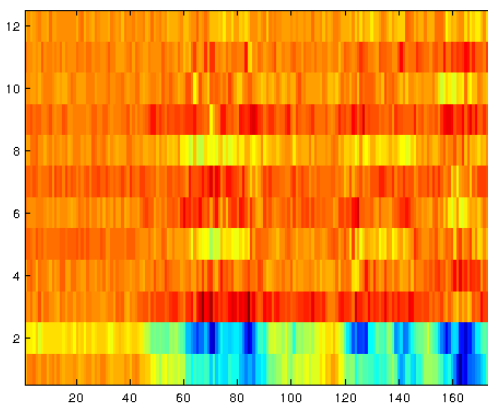
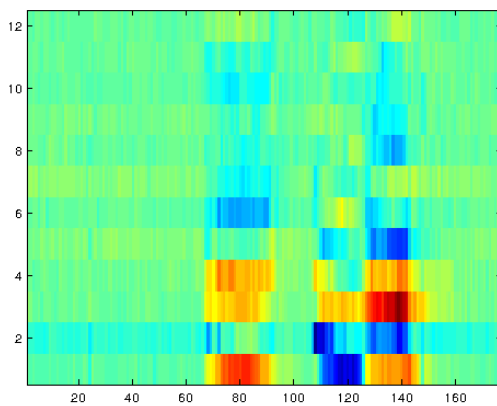
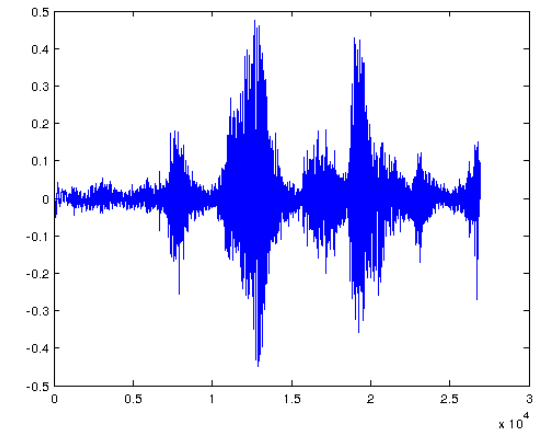
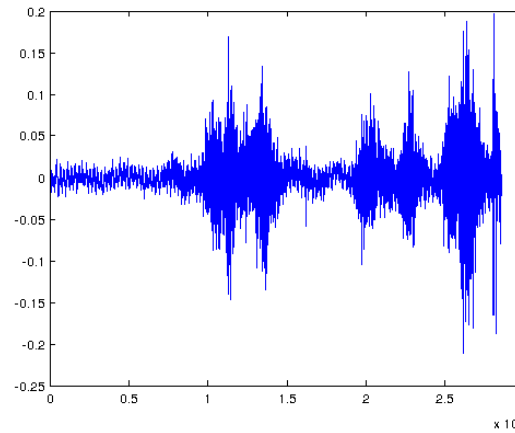
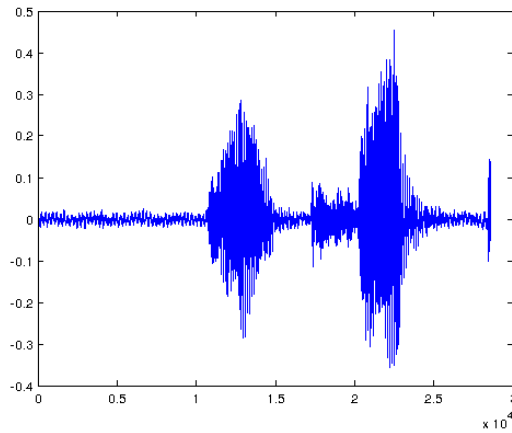

Background noise?

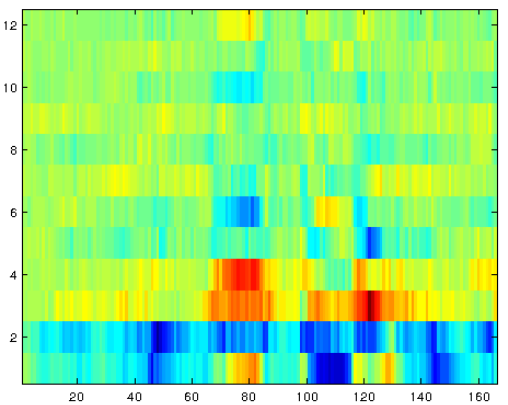
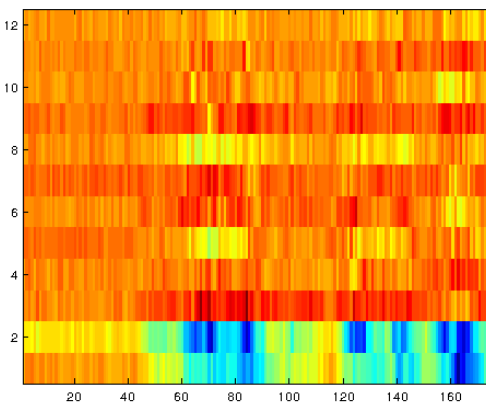
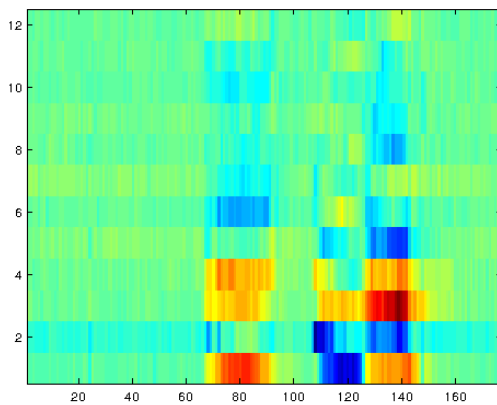
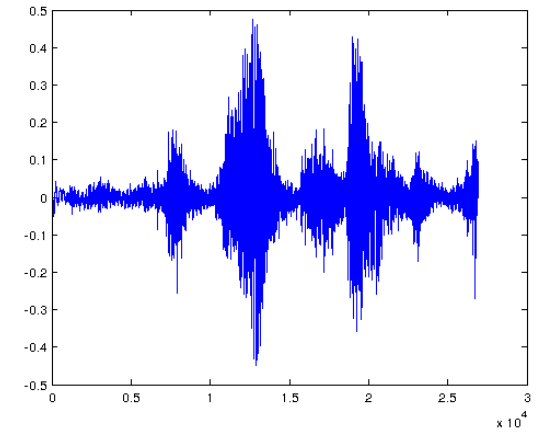
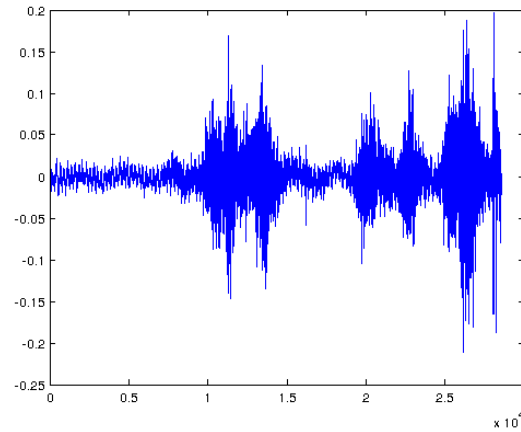
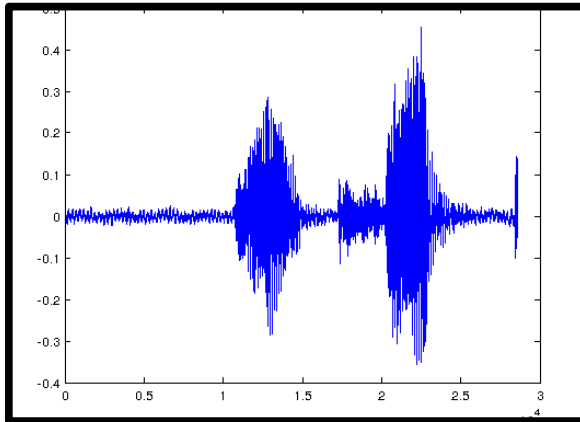



Background noise?

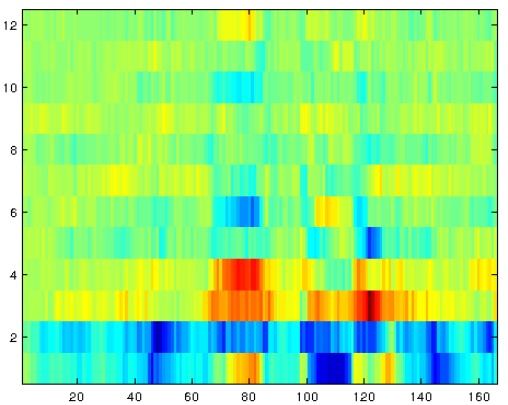
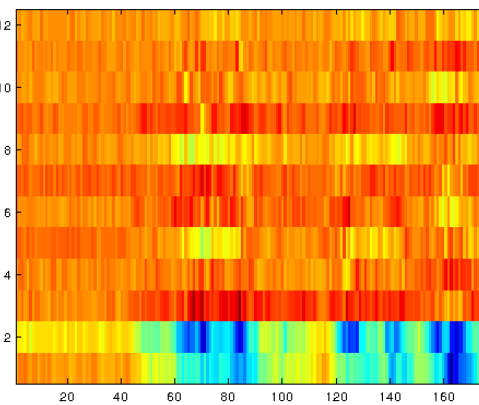
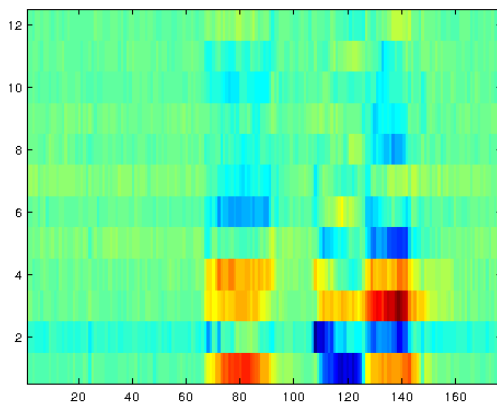
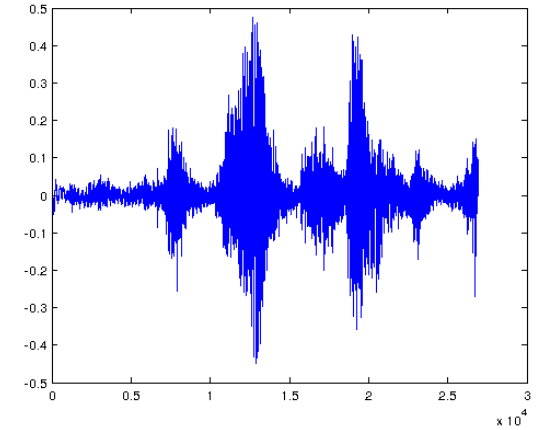
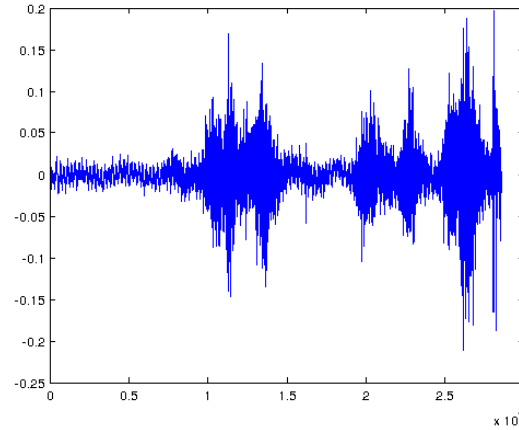
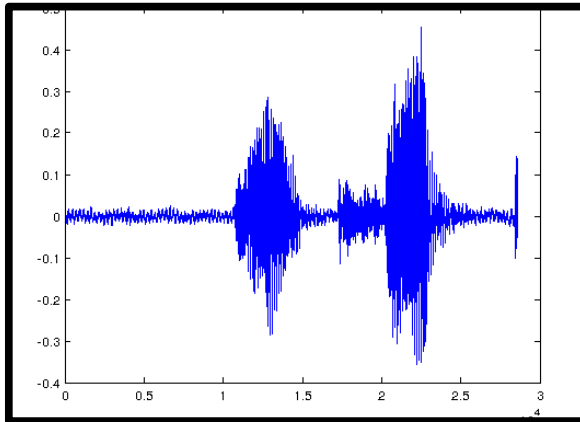

Background noise?

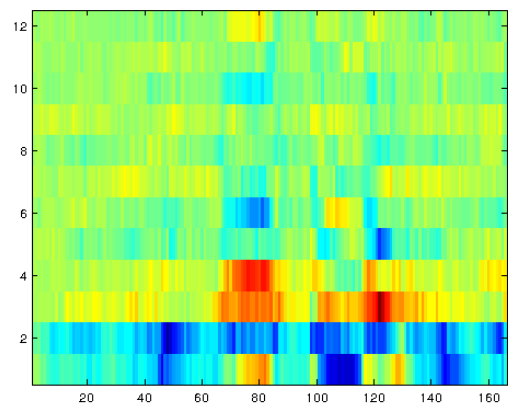
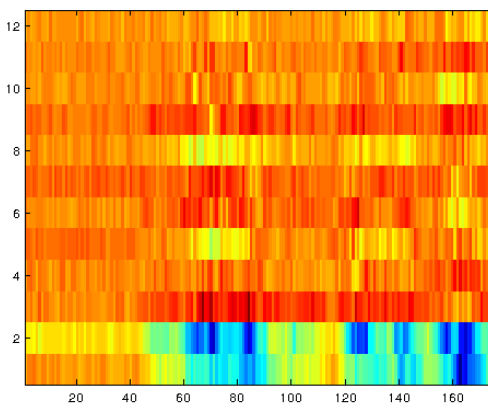
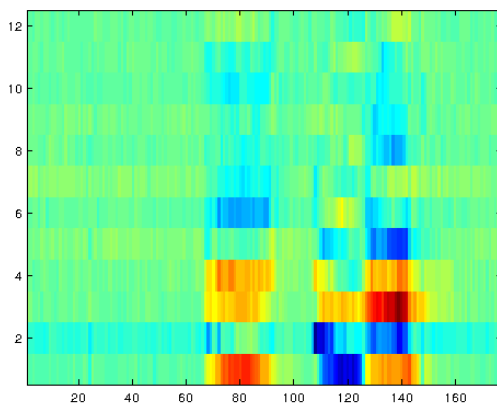
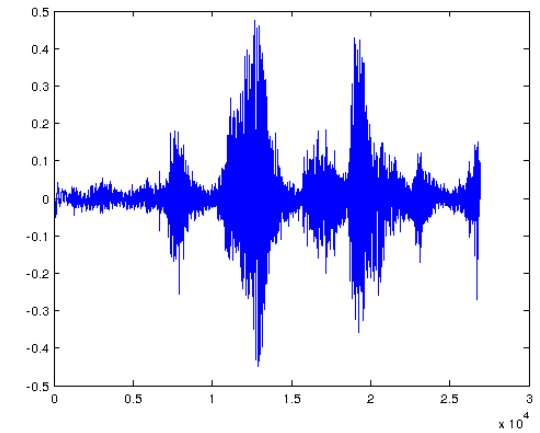
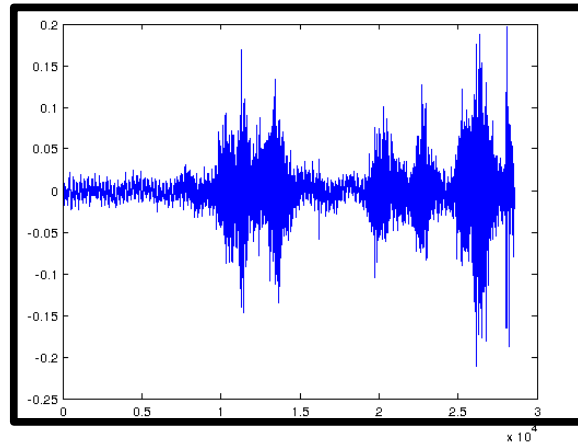
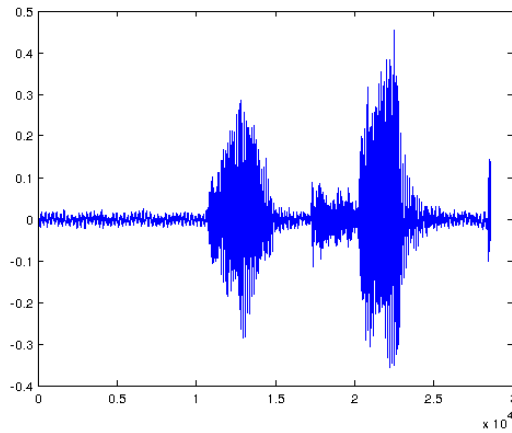



Background noise?

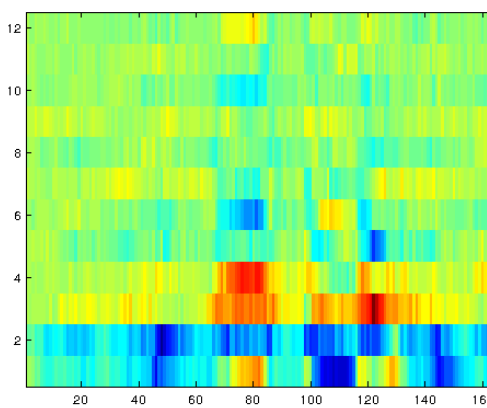
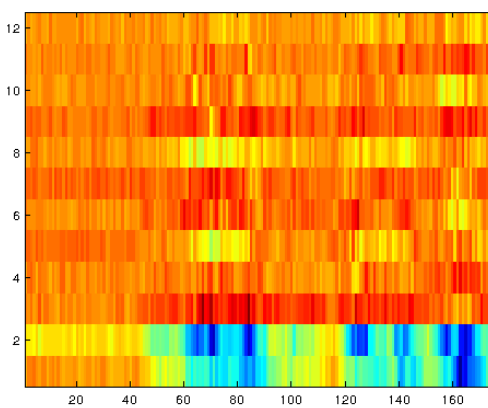
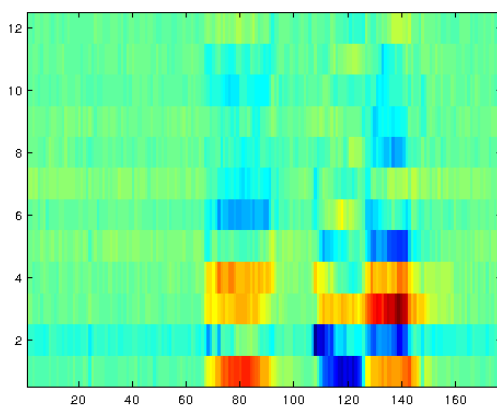
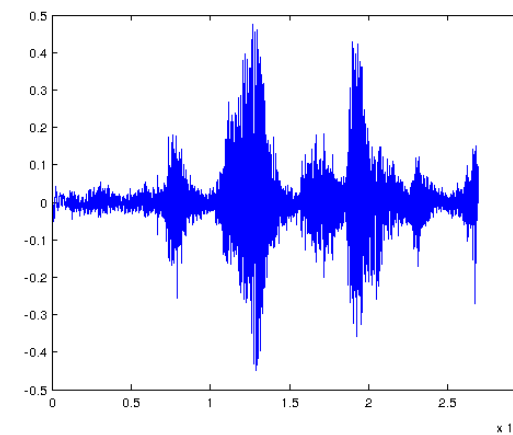
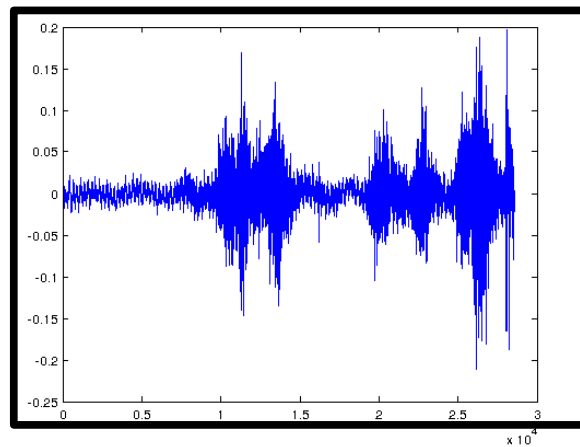
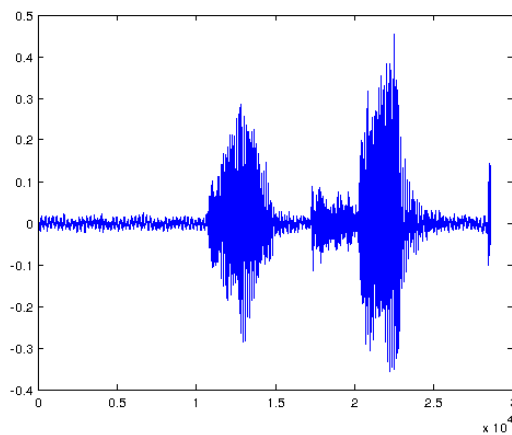

Background noise?

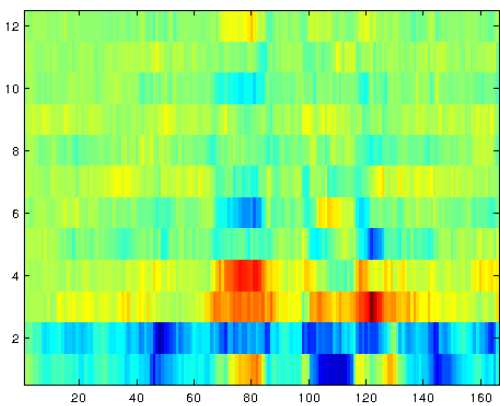
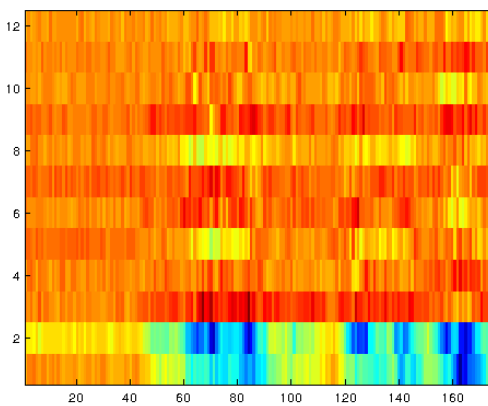
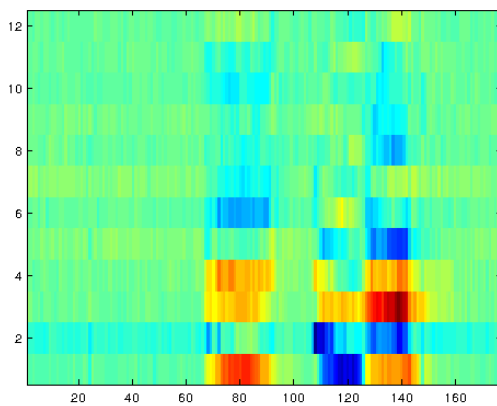
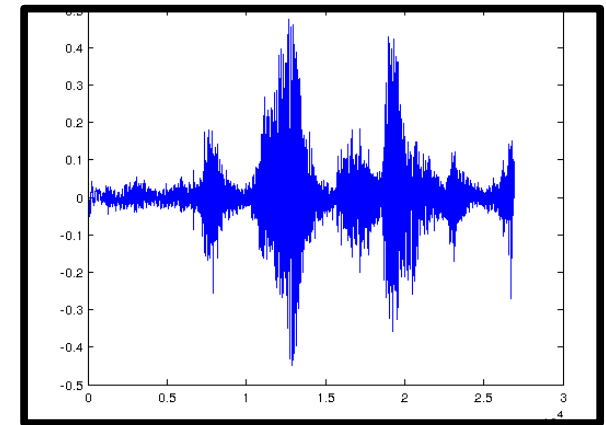
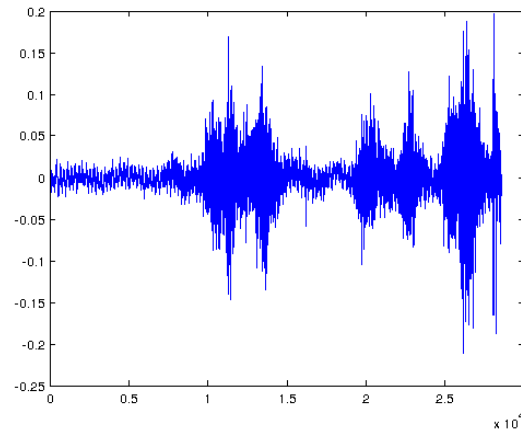
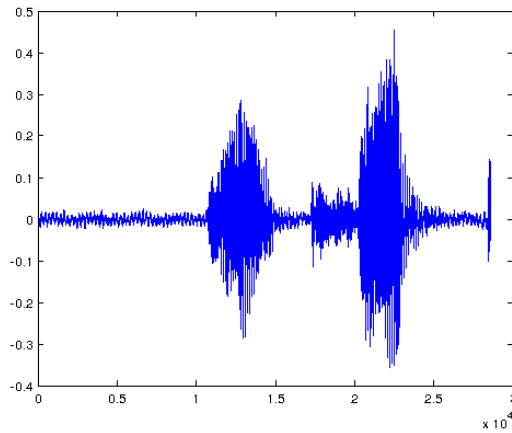



Background noise?

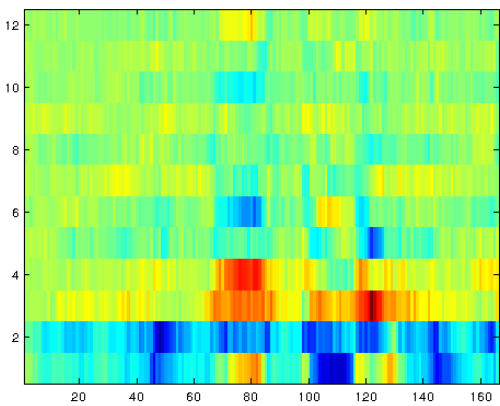
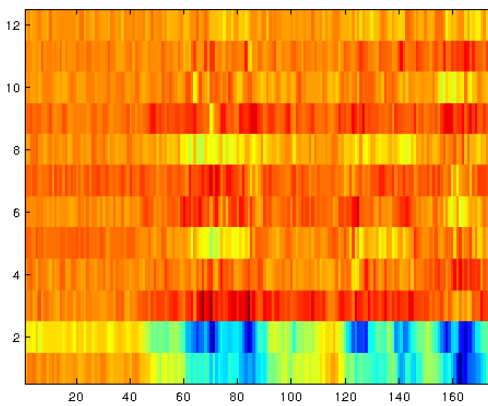
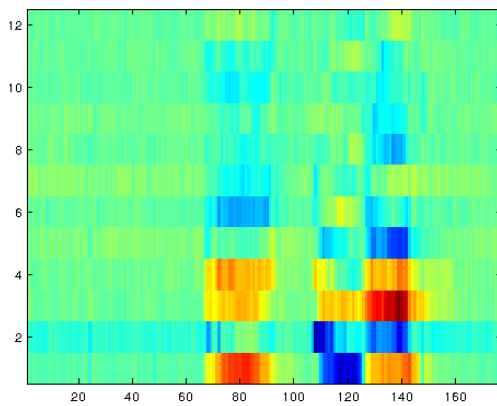
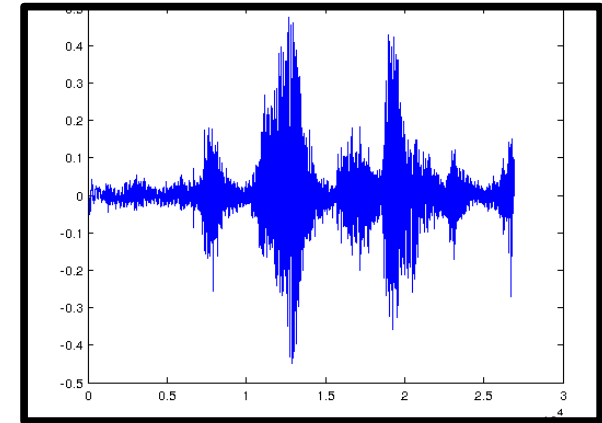
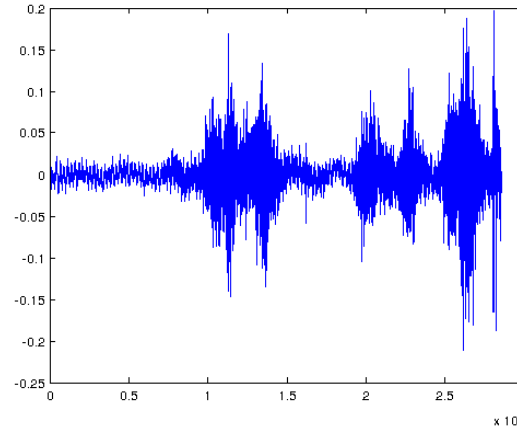
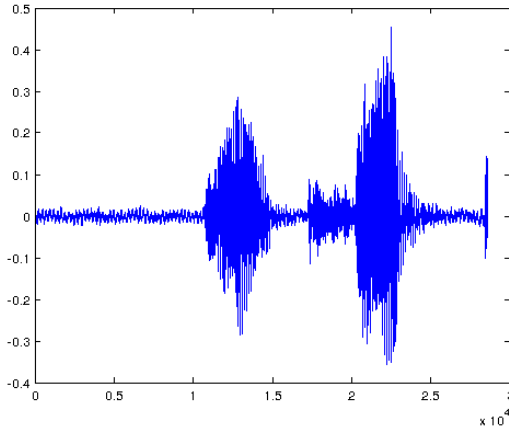

Content today

1. General organization of the course

2. What is automatic speech recognition?

3. Speech as an acoustic signal

→ **4. GMMs and DNNs**

5. Home exercise 1:

- Build a system to classify speech features into phonemes

6. Kick-start of the group works



Break 5 min

To classify sounds by features?

Training

1. Extract MFCC from samples of each sound (e.g. phoneme)
2. Train a statistical model (mean and variance)

Testing

1. Record new samples and extract MFCC
2. Choose the best-matching model to be the class

Classification by features

- Use, for example, a Gaussian mixture model (GMM)
- estimate a set of statistical models (mean and variance parameters) using samples of each sound source
- choose the best-matching statistical model to be the class of an unknown sample

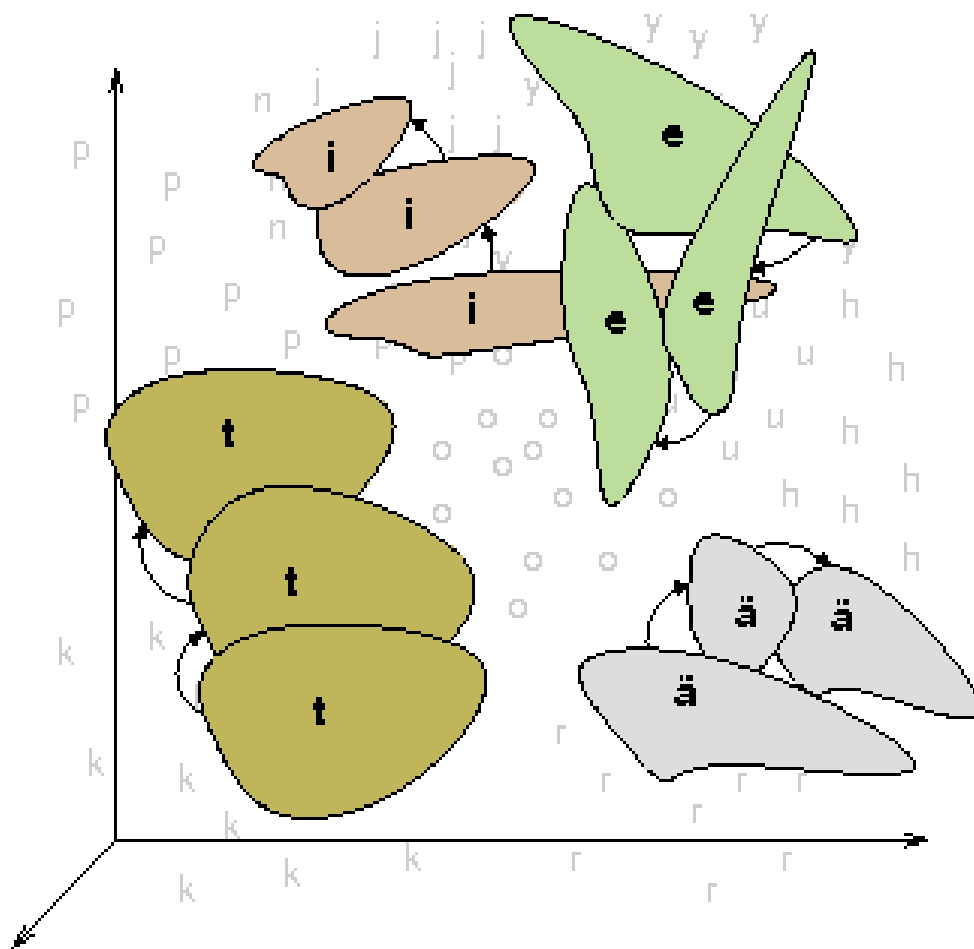

Normal (Gaussian) distribution

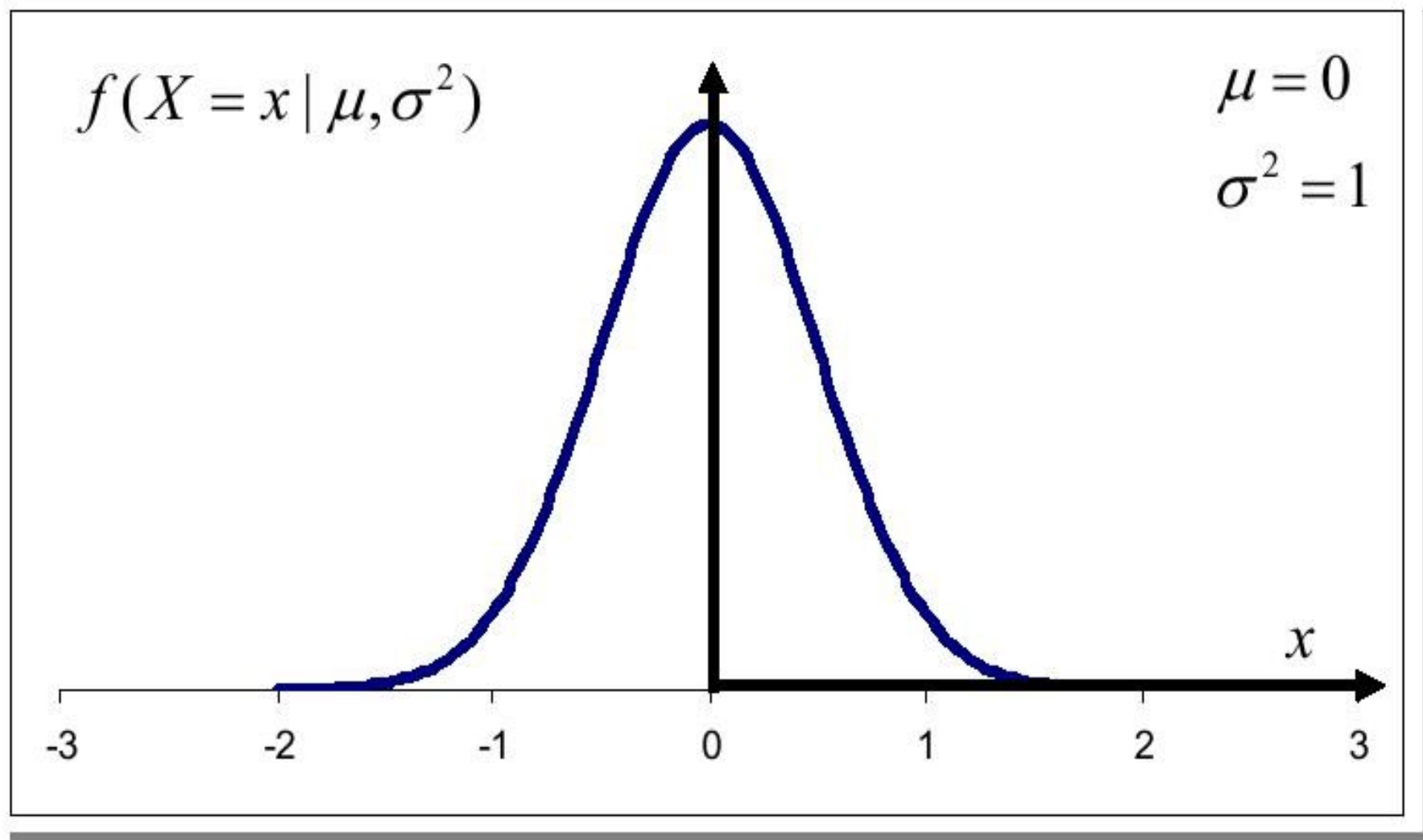

1dim. Gaussian distribution

$$f(X = x | \mu, \sigma^2) = \frac{1}{\sqrt{2\pi\sigma}} \exp\left[-\frac{(x - \mu)^2}{2\sigma^2}\right]$$

$$\mu = E[x] = \frac{1}{N} \sum_{n=1}^N x_n$$

$$\sigma^2 = E(X^2) - [E(X)]^2 = \frac{1}{N} \sum_{n=1}^N x_n^2 - \left[\frac{1}{N} \sum_{n=1}^N x_n \right]^2$$

GMM example

- 1-dim, 1-mixture, GMM model:

mean = 100 , variance = 1

- Observed feature **x = 102**, or **x = 99**, then **f(x | 100, 1) =**

- **f (102) =**

- **f (99) =**

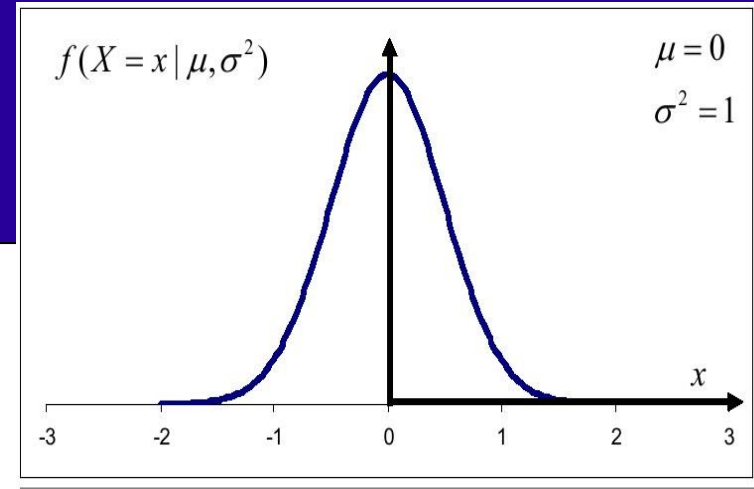

$$f(X=x | \mu, \sigma^2) = \frac{1}{\sqrt{2\pi}\sigma} \exp\left[-\frac{(x-\mu)^2}{2\sigma^2}\right]$$

Exp (-2) = 0.14
Exp (-1) = 0.37
Exp (-0.5) = 0.61
1/sqrt(2*pi) = 0.40

GMM example

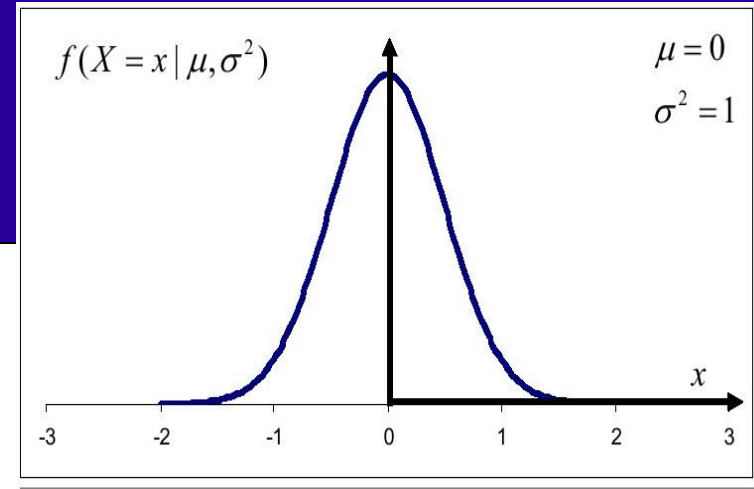

- 1-dim, 1-mixture, GMM model:
mean = 100 , variance = 1
- Observed feature **$x = 102$** , or **$x = 99$** , then **$f(x | 100, 1) =$**
- **$f(102) = 1 / (2 * \pi) ** (1/2) * \exp(-1/2 * (102-100) ** 2)$**
 $= 0.40 * \exp(-0.5 * 4) = 0.40 * 0.14 = 0.054$
- **$f(99) = 1 / (2 * \pi) ** (1/2) * \exp(-1/2 * (99-100) ** 2)$**
 $= 0.40 * \exp(-0.5 * 1) = 0.40 * 0.61 = 0.24$

$$f(X=x | \mu, \sigma^2) = \frac{1}{\sqrt{2\pi\sigma}} \exp\left[-\frac{(x-\mu)^2}{2\sigma^2}\right]$$

Exp (-2) = 0.14
Exp (-1) = 0.37
Exp (-0.5) = 0.61
1/sqrt(2*pi) = 0.40

Multidim. Gaussian distribution

$$f(X = x | \mu, \Sigma) = \frac{1}{(2\pi)^{n/2} |\Sigma|^{1/2}} \exp\left[-\frac{1}{2}(x - \mu)^T \Sigma^{-1}(x - \mu)\right]$$

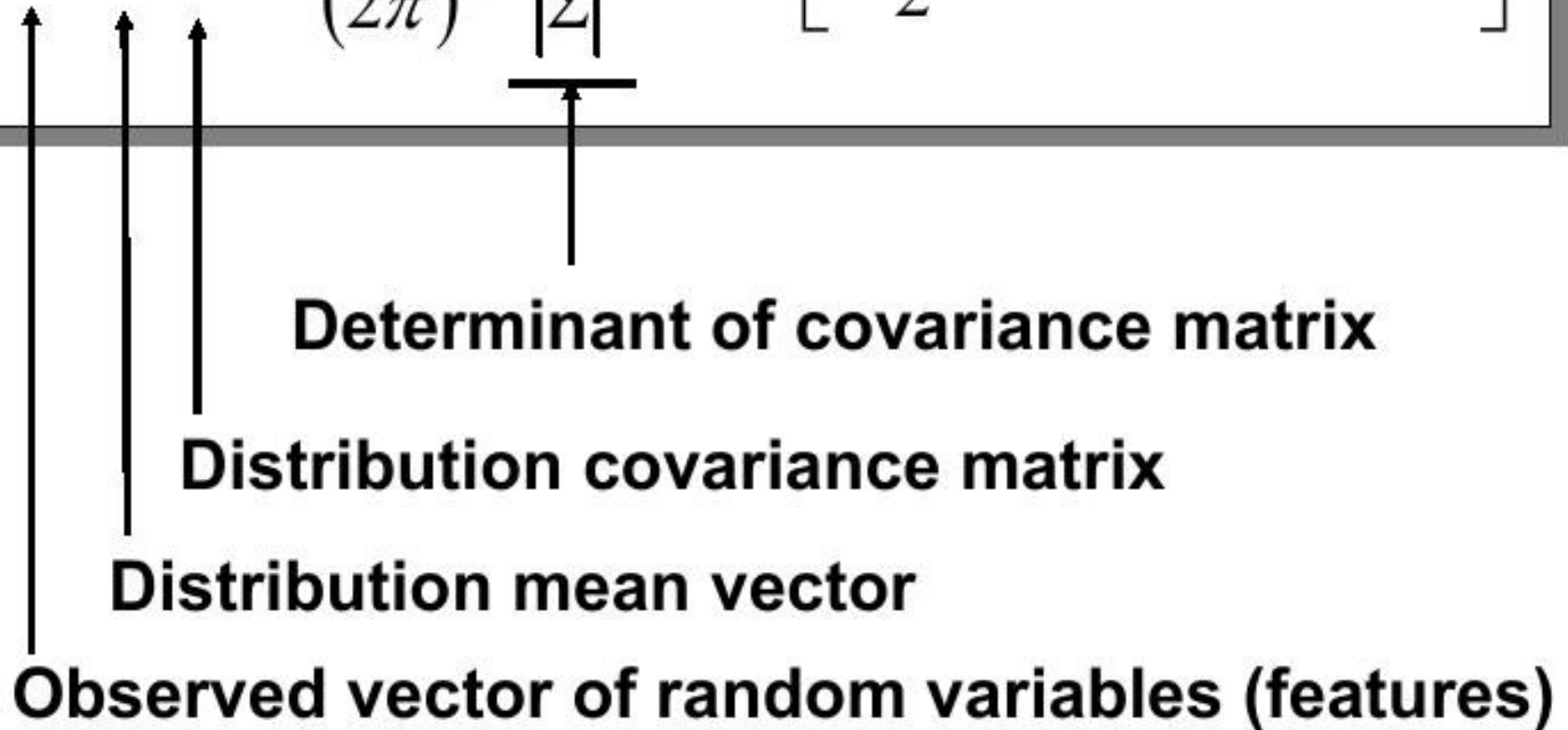

Diagonal Gaussian

- Most speech recognition systems assume diagonal covariance matrices
- Data sparseness issue:

$$\Sigma = \begin{bmatrix} \sigma_{11}^2 & 0 & 0 & 0 \\ 0 & \sigma_{22}^2 & 0 & 0 \\ 0 & 0 & \sigma_{33}^2 & 0 \\ 0 & 0 & 0 & \sigma_{44}^2 \end{bmatrix} \longrightarrow \boxed{|\Sigma| = \prod_{n=1}^d \sigma_{nn}^2}$$

Inverse of the covariance matrix

- Inverting a diagonal matrix involves simply inverting the elements along the diagonal:

$$\Sigma^{-1} = \begin{bmatrix} \frac{1}{\sigma_{11}^2} & 0 & 0 & 0 \\ 0 & \frac{1}{\sigma_{22}^2} & 0 & 0 \\ 0 & 0 & \frac{1}{\sigma_{33}^2} & 0 \\ 0 & 0 & 0 & \frac{1}{\sigma_{44}^2} \end{bmatrix}$$

1dim. Gaussian mixture model

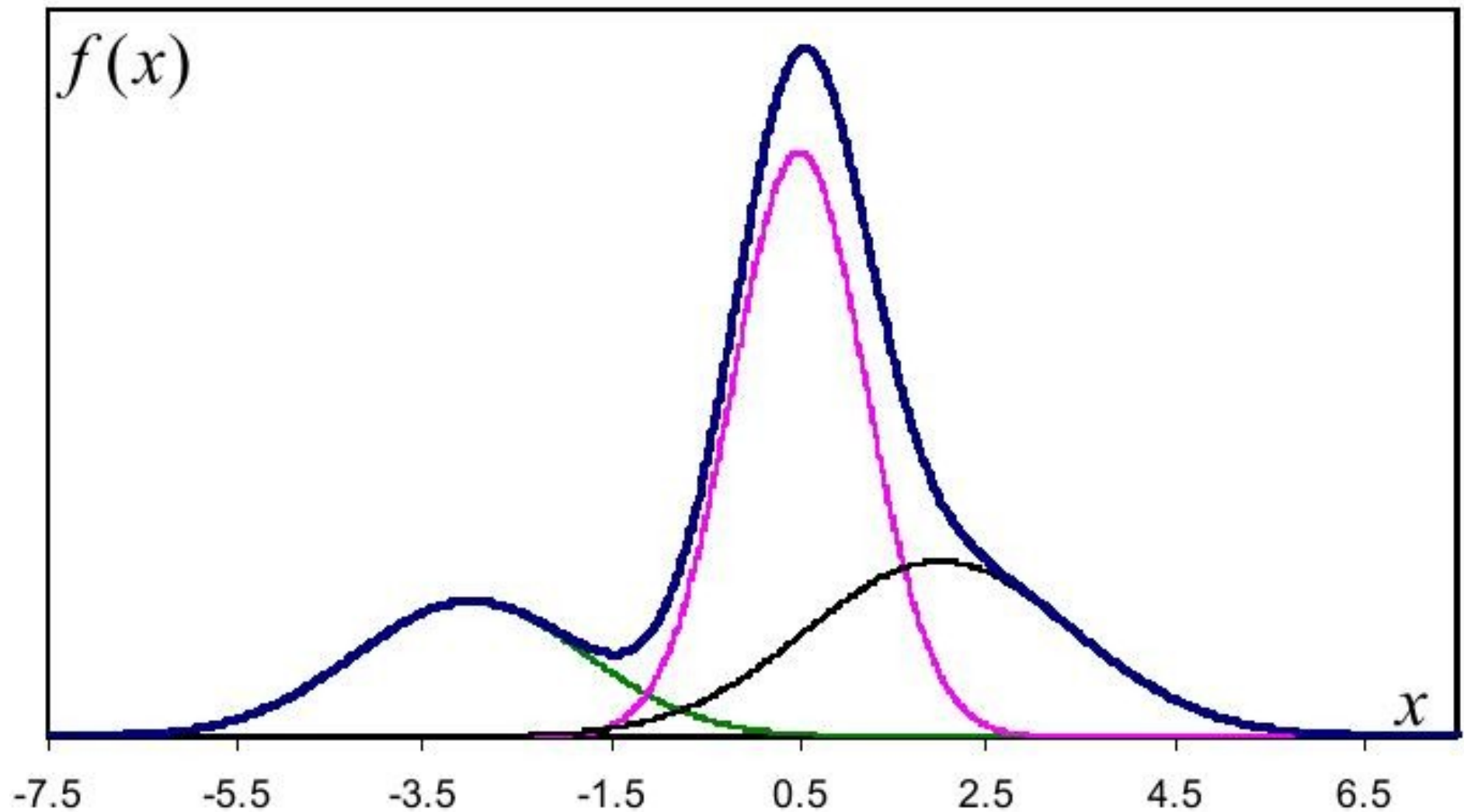

Gaussian mixture model GMM

- Distribution is governed by several Gaussian density functions,
- Sum of Gaussians (w_m = mixture weight)

$$f(x) = \sum_{m=1}^M w_m \mathbf{N}_m(x; \mu_m, \Sigma_m)$$
$$= \sum_{m=1}^M \frac{w_m}{(2\pi)^{n/2} |\Sigma_m|^{1/2}} \exp\left[-\frac{1}{2}(x - \mu_m)^T \Sigma_m^{-1} (x - \mu_m)\right]$$

Other classifiers

- Probability density functions (such as **GMM**) that model the distribution of the data
- Methods such as **K-nearest neighbors** that directly use the data
- Methods such as **K-means** that learn the clusters in the data
- Discriminative models that directly learn to optimize the classification accuracy
 - Linear: Support Vector Machine (**SVM**)
 - Non-linear: Multilayer Perceptron and other **Deep Neural Networks (DNN)**

A simple 1-layer NN

- Outputs the **probability of classes** $y(t)$ given the observation $x(t)$
- **Input layer** is the feature vector $x(t)$ of the current frame
- **Hidden layer** has a linear transform $h(t) = Ax(t) + b$ to compute a representation of **linear distributional features** or factors
- **Output layer** maps the values by $y(t) = \text{softmax}(h(t))$ to range $(0,1)$ that add up to 1
- Resembles a simple linear classifier

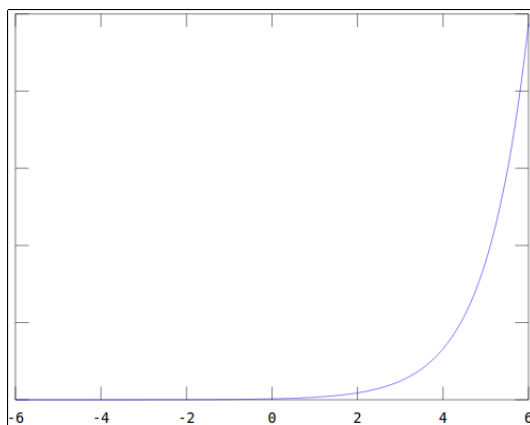

Softmax:

$$\sigma(\mathbf{z})_j = \frac{e^{z_j}}{\sum_{k=1}^K e^{z_k}} \quad \text{for } j = 1, \dots, K.$$

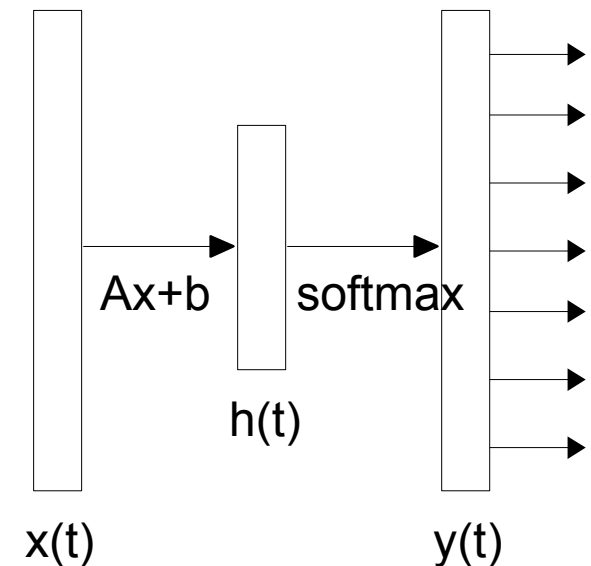

A non-linear 1-layer NN

- The only difference to the simple NN is that the hidden layer $h(t)$ now includes a non-linear function $h(t) = U(Ax(t) + b)$
- Can learn more complex feature representations
- Common examples of non-linear functions U :

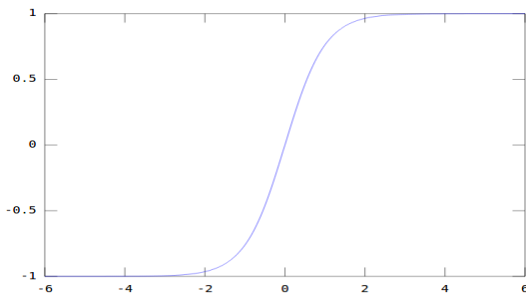

$$U(t) = \tanh(t)$$

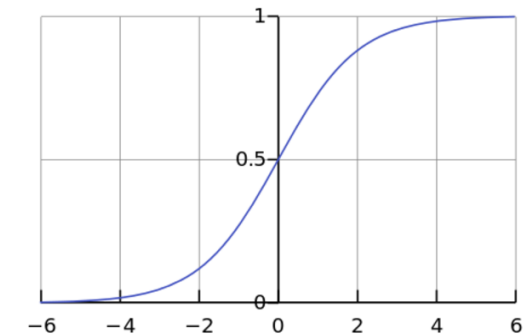

Sigmoid

$$U(t) = \frac{1}{1 + e^{-t}}$$

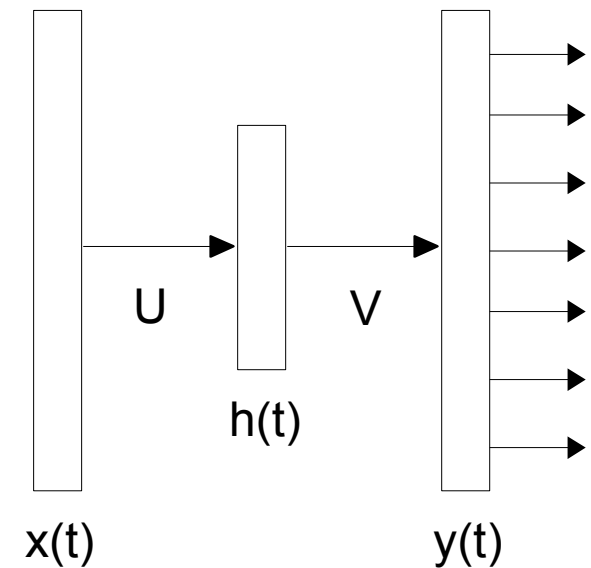

Linear and non-linear classifiers

- Find a **linear** transformation $\mathbf{h} = \mathbf{Ax} + \mathbf{b}$ to map the input coordinates to a new space where the classes are easier to separate
- Find a more complex **non-linear** transformation $\mathbf{h} = \mathbf{U}(\mathbf{Ax} + \mathbf{b})$ to map the input coordinates into a new space for classification

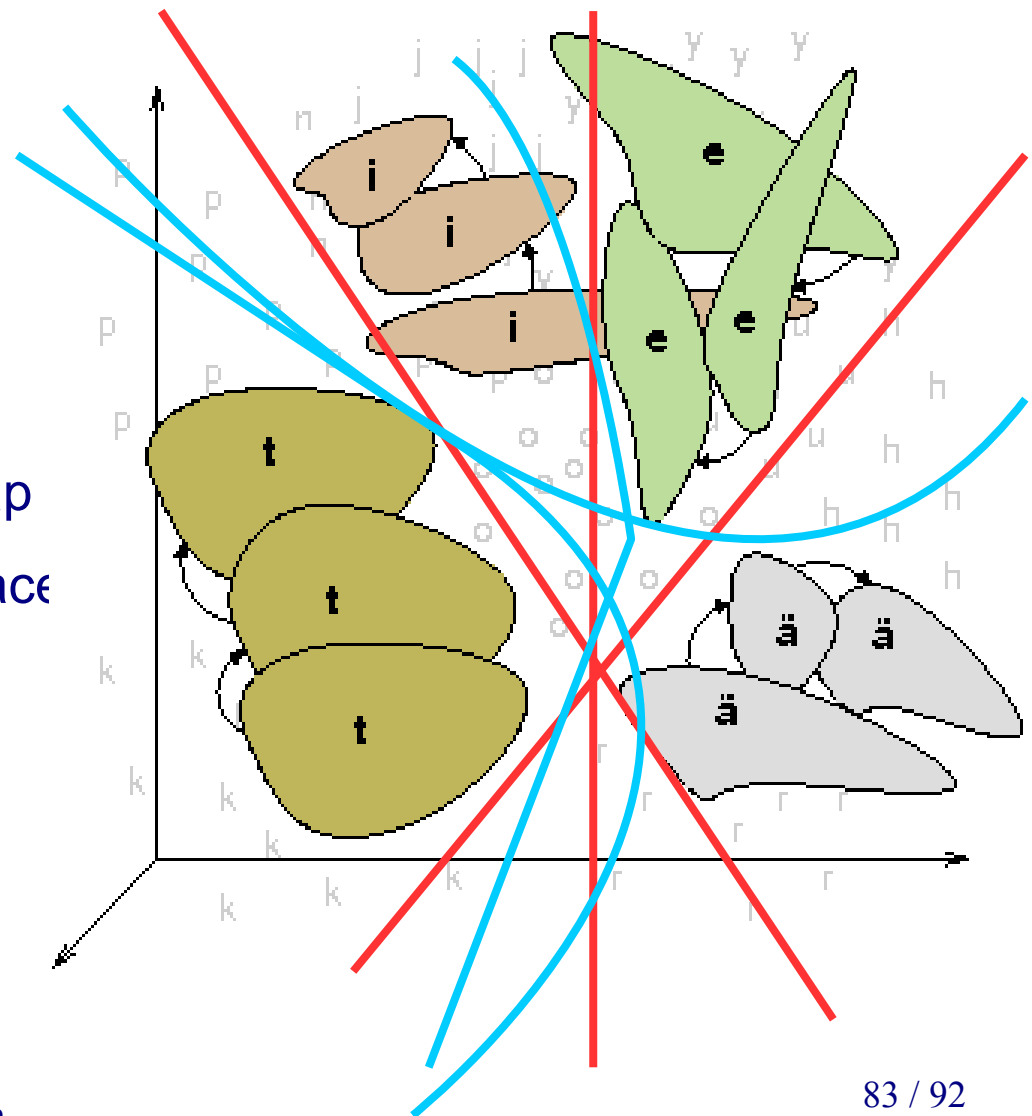

Common NN extensions

- **Input layer** is expanded over several previous frames $x(t-1)$, $x(t-2)$, .. to learn richer representations
- Deep neural networks have several **hidden layers** h_1 , h_2 , .. to learn to represent information at several hierarchical levels
- Can compute probabilities for thousands of context-dependent speech units by extending the **output layer** $y(t)$

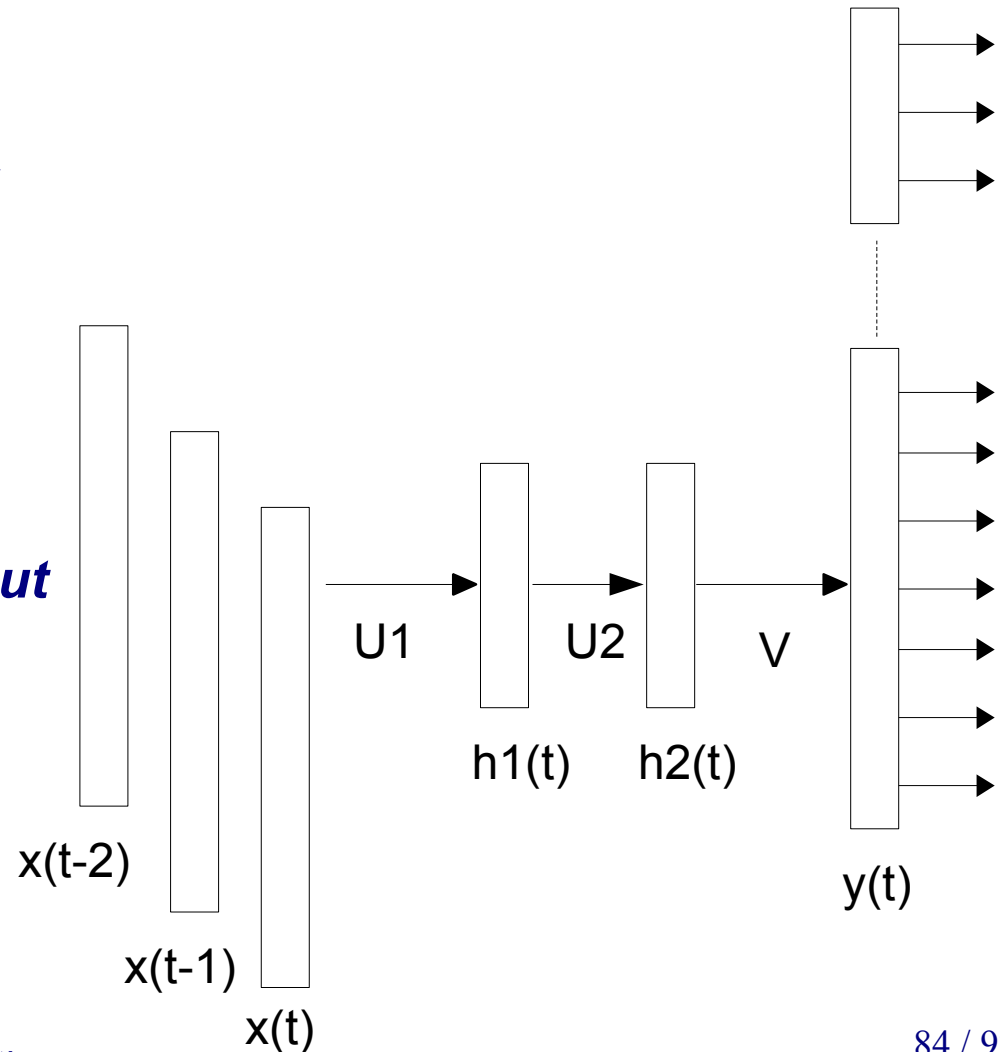

NN training

- Supervised training minimizes the **output errors** by training the weights for V by *stochastic gradient descend*
 - Tunes the weights to the direction of giving 1 to correct class and 0 to others
- Propagate the output **error to hidden layer** to train the weights for U
 - Tunes the weights based on how much they contributed to the output
- In practice, deep NNs will require more complex training procedures, since the gradients *vanish* quickly
 - After some propagation steps the individual contributions to the output become roughly equal

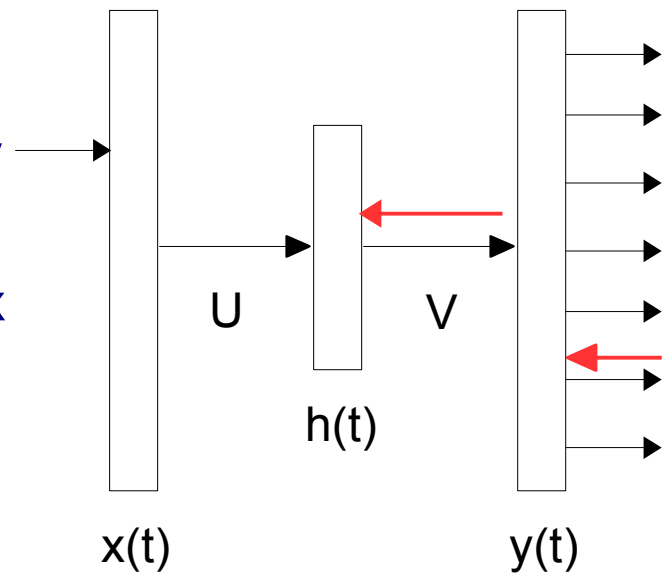

Analysis of DNNs in acoustic models

3 key improvements:

1. Processing in many hierarchical layers
2. Input from many frames
3. Output for context-dependent phones

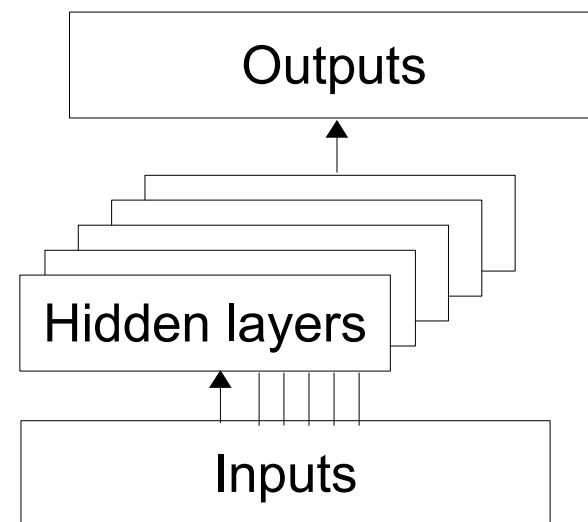

Other significant improvements: speedups, pre-training, sequence discriminative training, multitask learning, various NN architectures (CNN, RNN, LSTM, Highways)

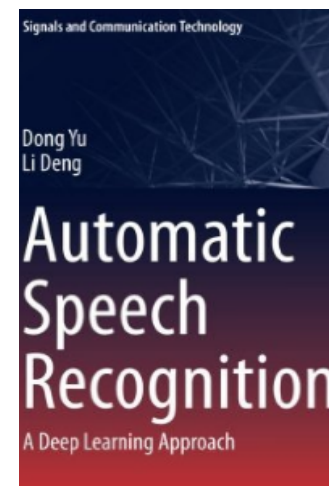

D.Yu, L.Deng. Automatic Speech Recognition A Deep Learning Approach. Springer 2015.

Home exercise 1

- Build a **classifier** to classify speech features into phonemes !
- Details, instructions and help given in Thursday/Friday meeting this week
- To be returned by Wednesday **next week**

Feedback

Now: Go to MyCourses > Lectures and fill in the feedback form:

- Write down questions from today's lecture that troubled your mind
- Comments and suggestions are welcome, too.
- What was missing today, and what too much?

Idea's taken from last years' feedback:

- Tutors to join the first project meetings
- Pre-assign groups, topics, and the first meeting date
- Show videos on ASR applications
- Add a simple GMM example

Next meeting

- Thu 10.15 – 12 or Fri 14.15 – 16
- Speech data and support provided for practical experiments
- Organized by Aku Rouhe
- Get your AALTO account ready!
- Python and Jupyter Notebooks used, links to guides available on request
 - There is an old substitute in Matlab if someone prefers
- Support for Home exercise 1 provided only in the computer sessions of this week (!)

Summary of today

- Course organization, project works
- History
- What is ASR?
- Speech signal
- Acoustic features
- Gaussian mixture model
- Deep neural network
- *on Friday: Classification*
- *Next week: Phonemes and hidden Markov models*

Content today

1. General organization of the course
2. What is automatic speech recognition?
3. Speech as an acoustic signal
4. GMMs and DNNs
5. Home exercise 1:
 - Build a system to classify speech features into phonemes
- ➔ **6. Kick-start of the group works**

Project work receipt

1. Form a group (3 persons)

Done
already?

2. Get a topic

3. Get reading material from *MyCourses* or your group tutor

4. 1st meeting: Specify the topic, start literature study (DL Nov 4)

This
week

5. 2nd meeting: Write a work plan (DL Nov 11)

6. 3rd - 5th meetings: Perform analysis, experiments, and write a report

7. Book your presentation time for weeks 6 - 7 (DL Nov 27)

8. Prepare and keep your 20 min presentation

9. Return the report (DL Dec 11)

Check **MyCourses > Projects** to see your group, topic and tutor