



**ARK-A3001 Design of Structures_Basics
Form & Force**

Toni Kotnik

Professor of Design of Structures

Aalto University
Department of Architecture
Department of Civil Engineering

- Load cases**
 - dead load
 - live load
 - environmental load
- distributed load**
- point load**
- equilibrium**
- location plan**
- force plan**
- resultant force**
- lever principle**



ARK-A3001 Design of Structures_Basics
Equilibrium

Toni Kotnik

Professor of Design of Structures
Aalto University
Department of Architecture
Department of Civil Engineering

Basic Operation with Forces

two forces can be **added** into one resulting force

one force can be **separated** into two force



- Load cases**
- dead load
- live load
- environmental load

resultant force

distribute forces to specific points

basic idea: building structure as a possibility to guide forces in space according to design interest

location plan

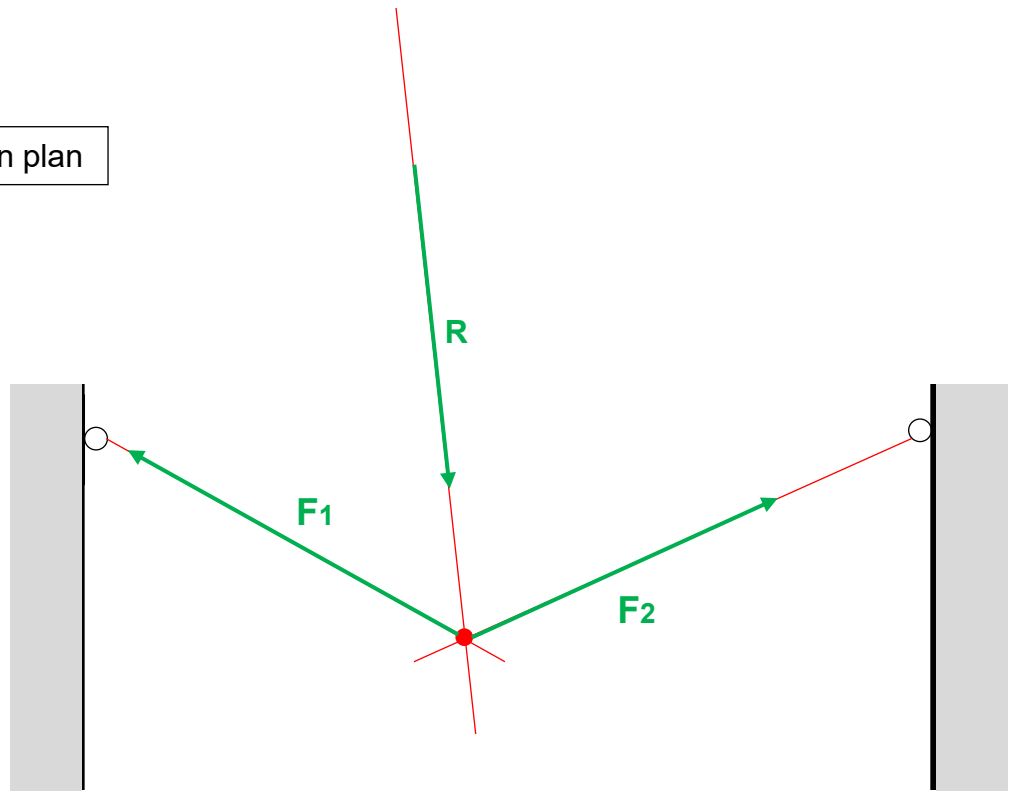

force plan

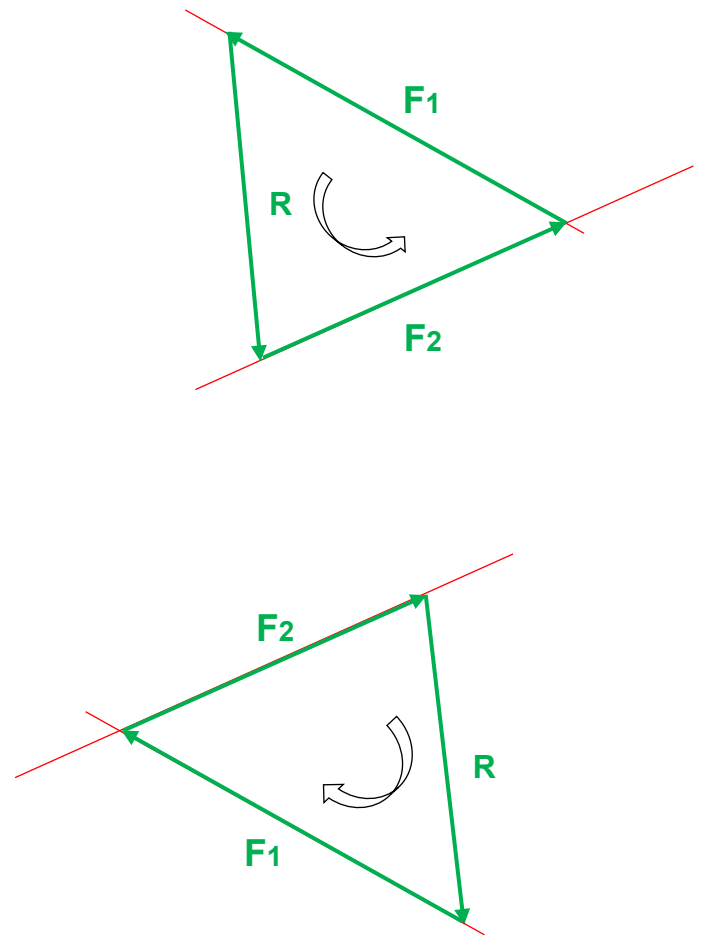

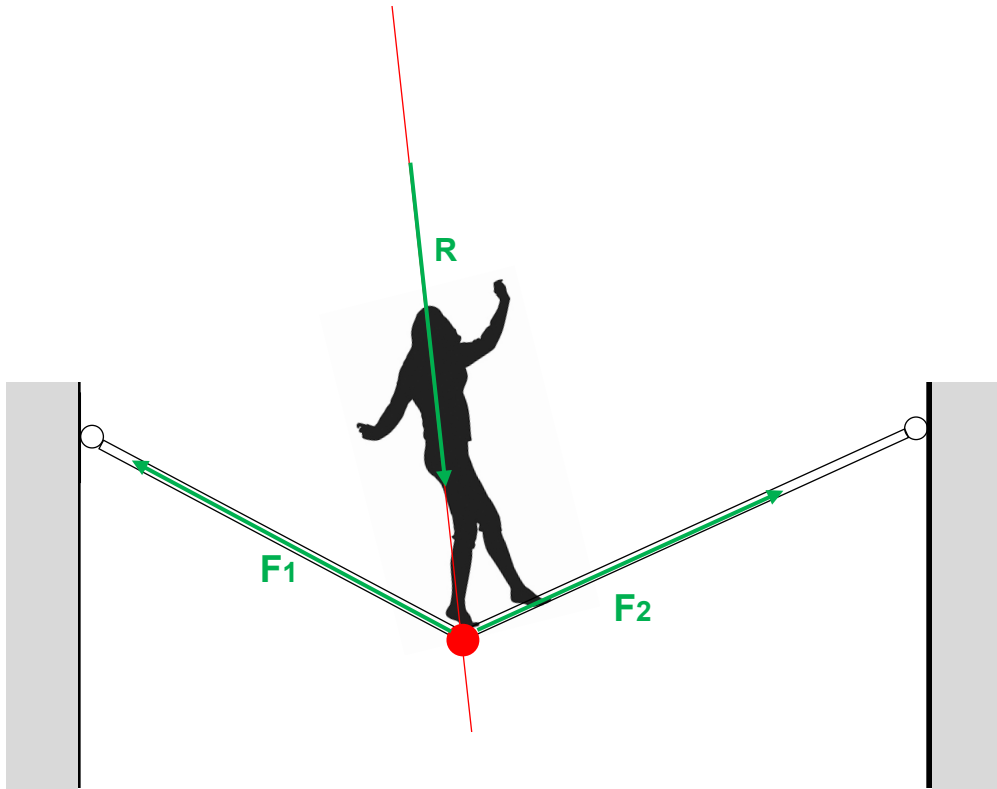

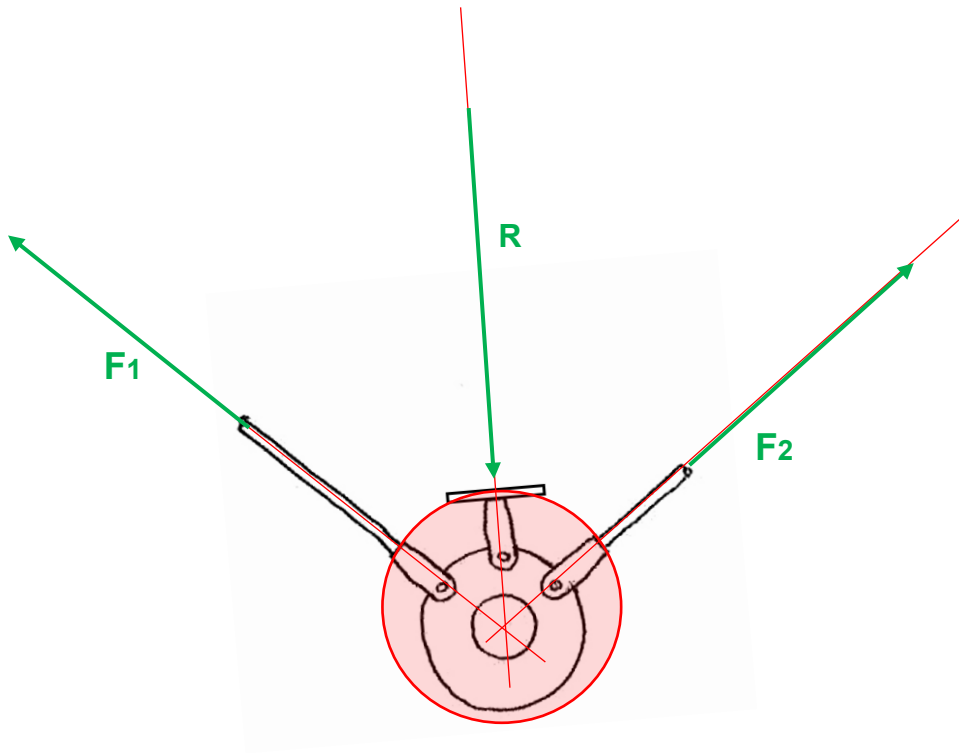

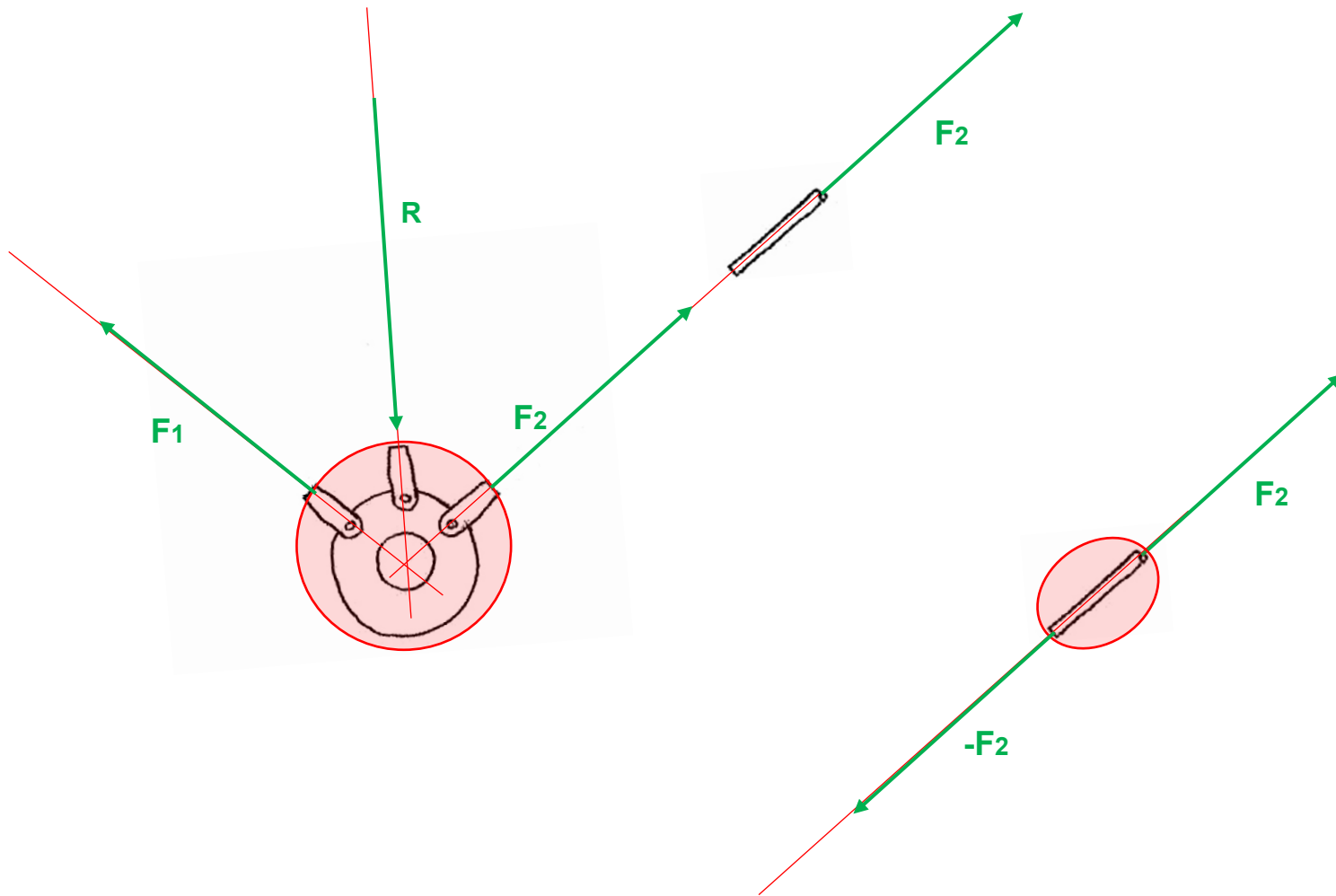

the forces add up to zero
 the line of action of the forces intersect in one point

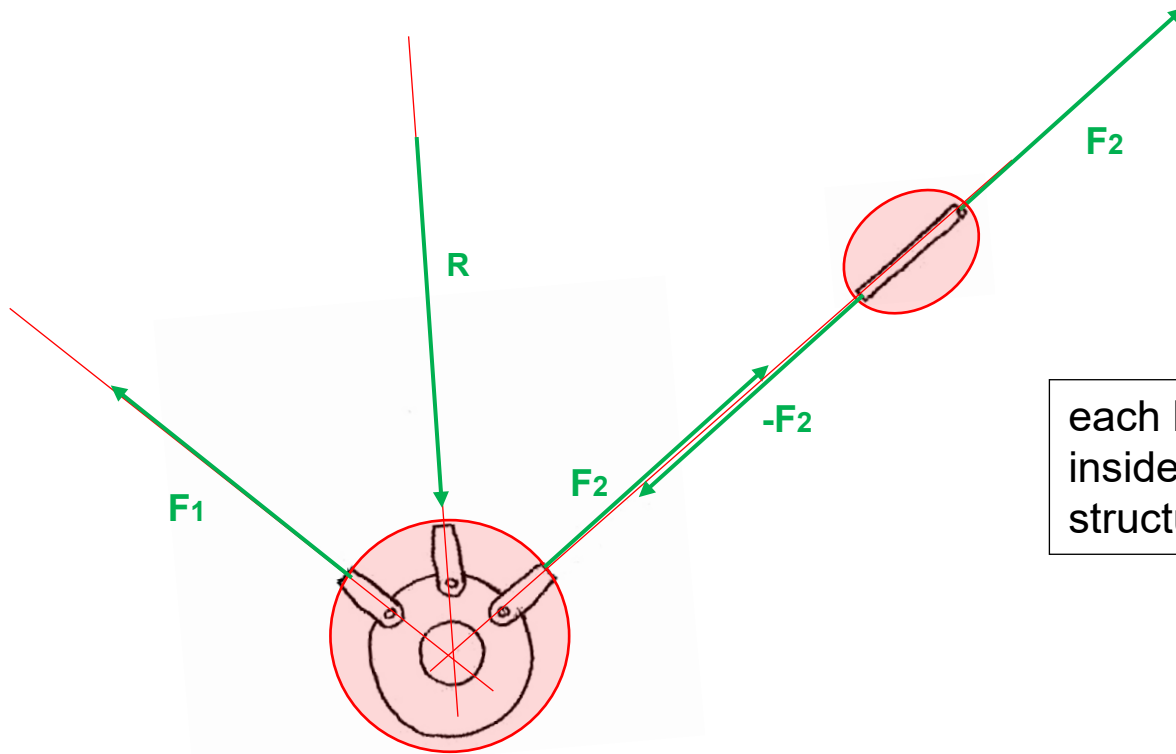

each load is producing forces inside the material of the structure, so-called **inner forces**

For a building structure to be in equilibrium means that every part of the structure is in equilibrium

Inner Force

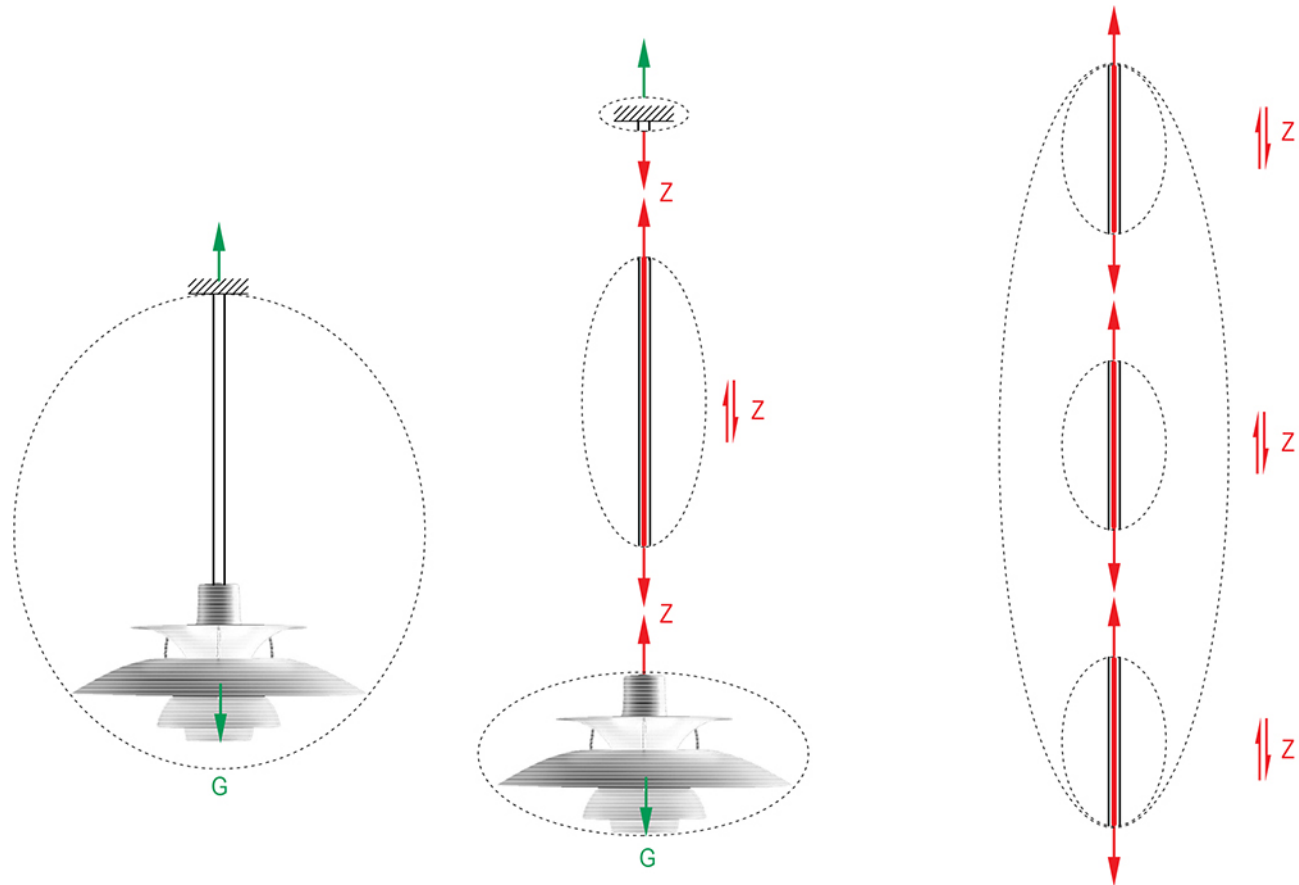

tension
force pulling away from subsystem

Inner Force

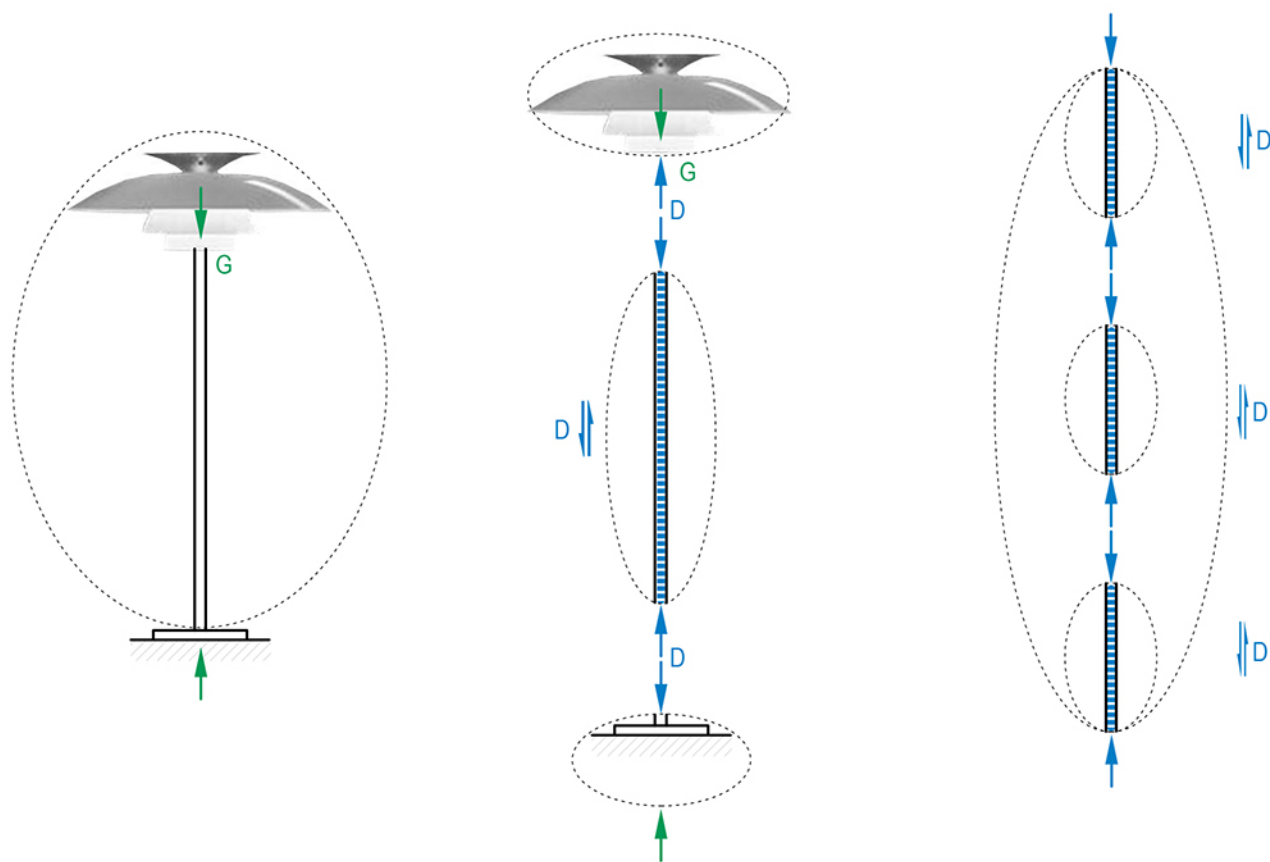

compression
force pushing towards the subsystem

Inner Force

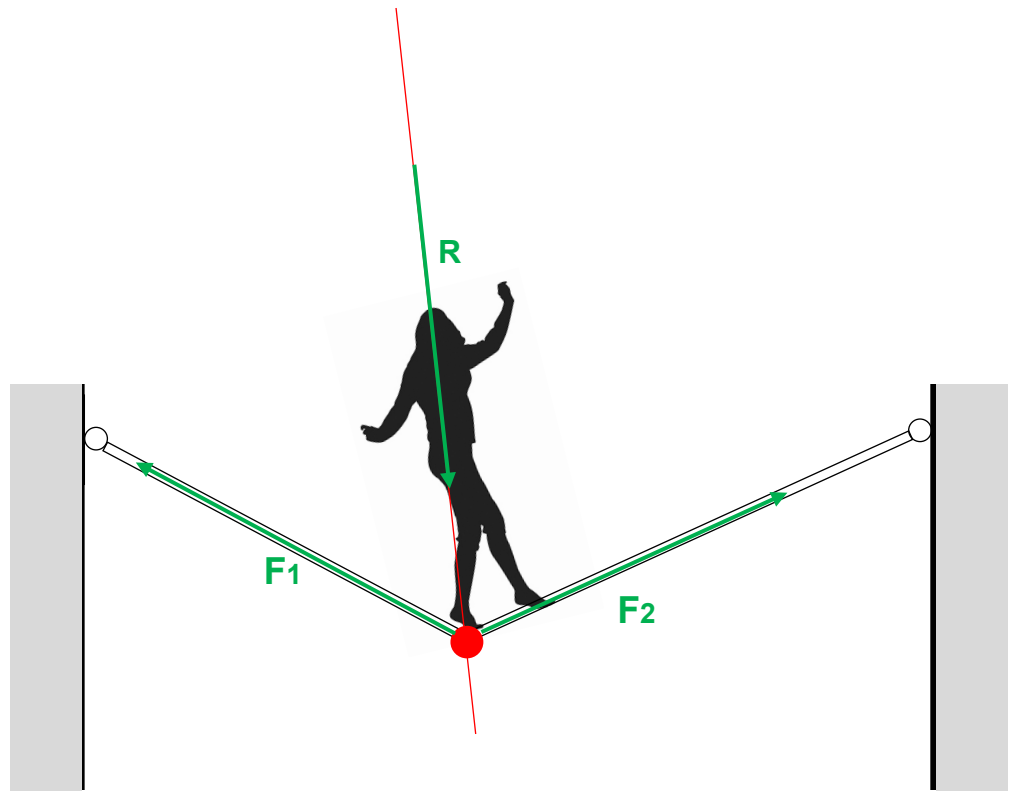

each load is producing forces inside the material of the structure, so-called **inner forces**

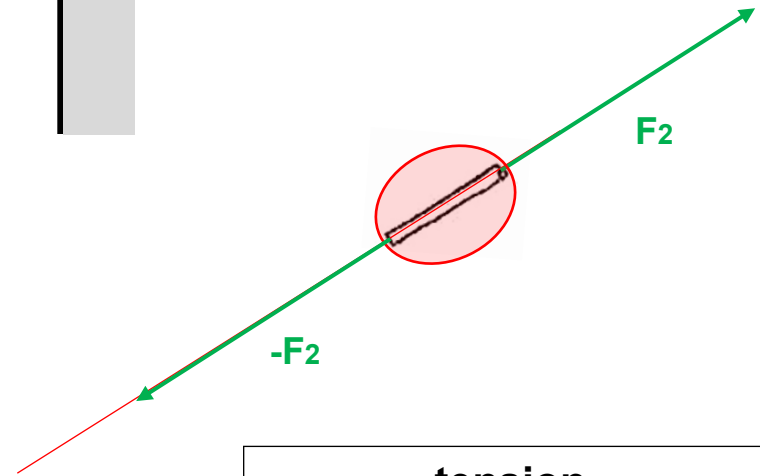

tension
force pulling away from subsystem

Inner Force

location plan

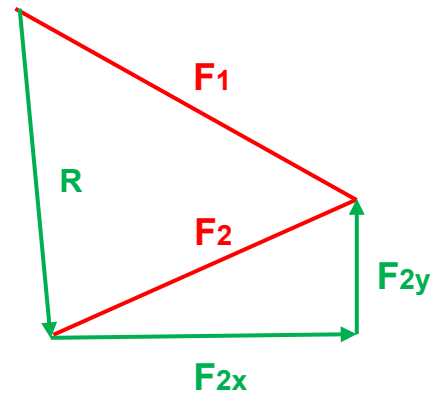
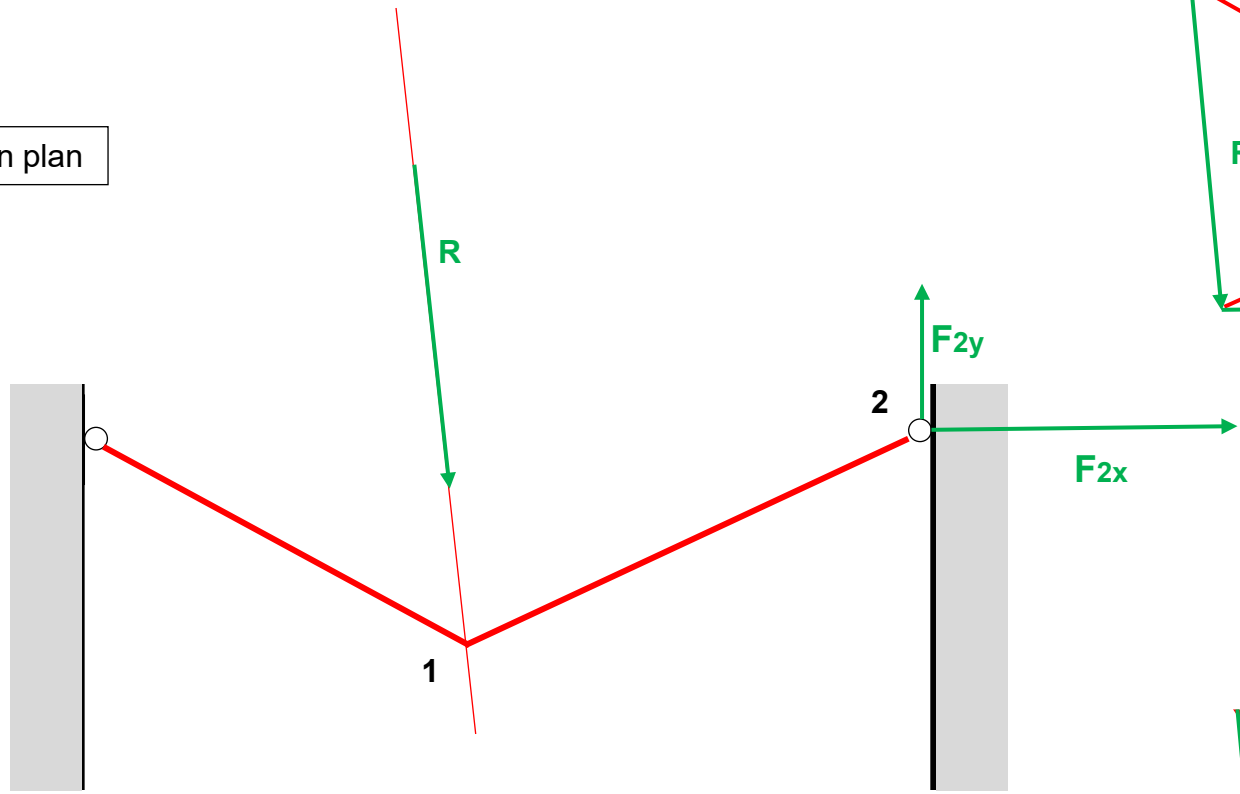

force plan

at 1

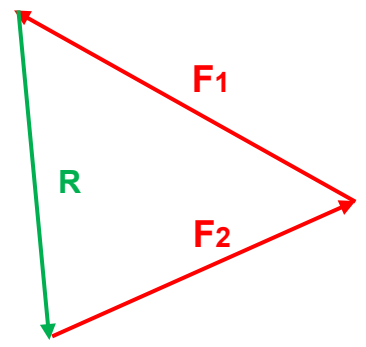

at 2

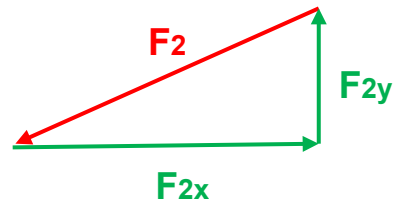

Equilibrium

cable

single / double load

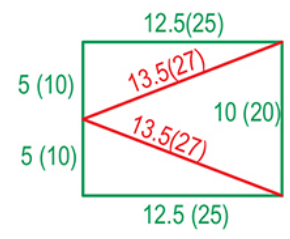
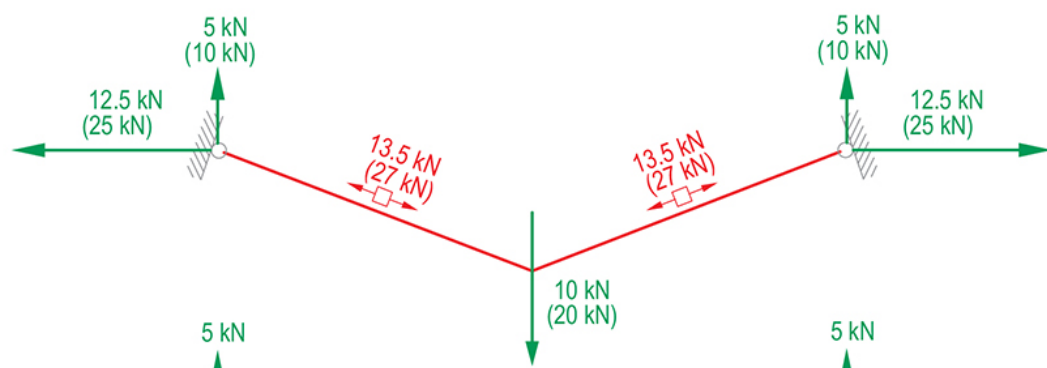

single / double deviation

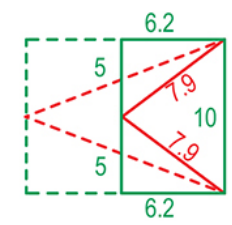
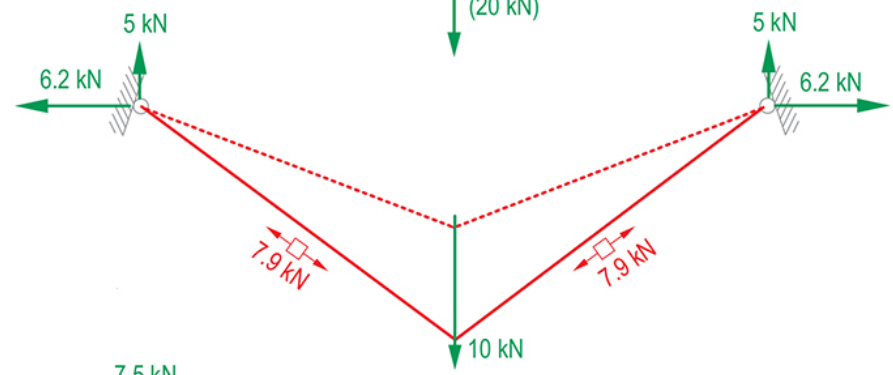

uneven load condition

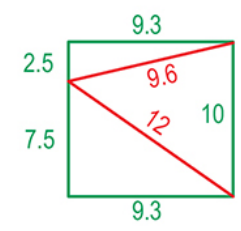
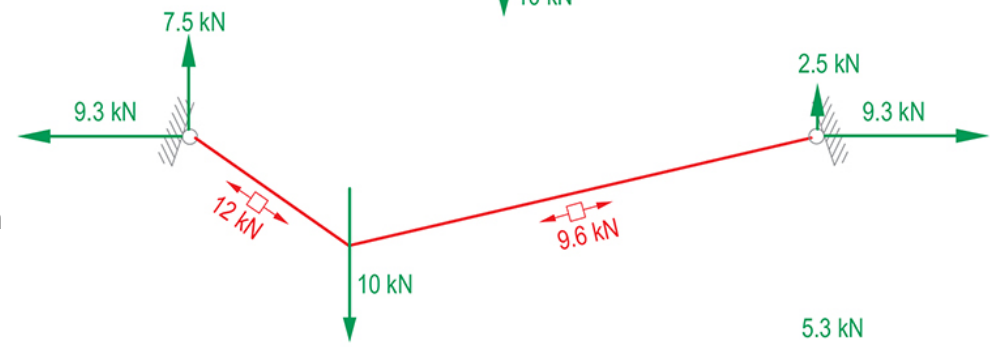

The form of a building structure is closely tight to the magnitude and direction of forces in the structure.

Equilibrium

cable

force plan

location plan

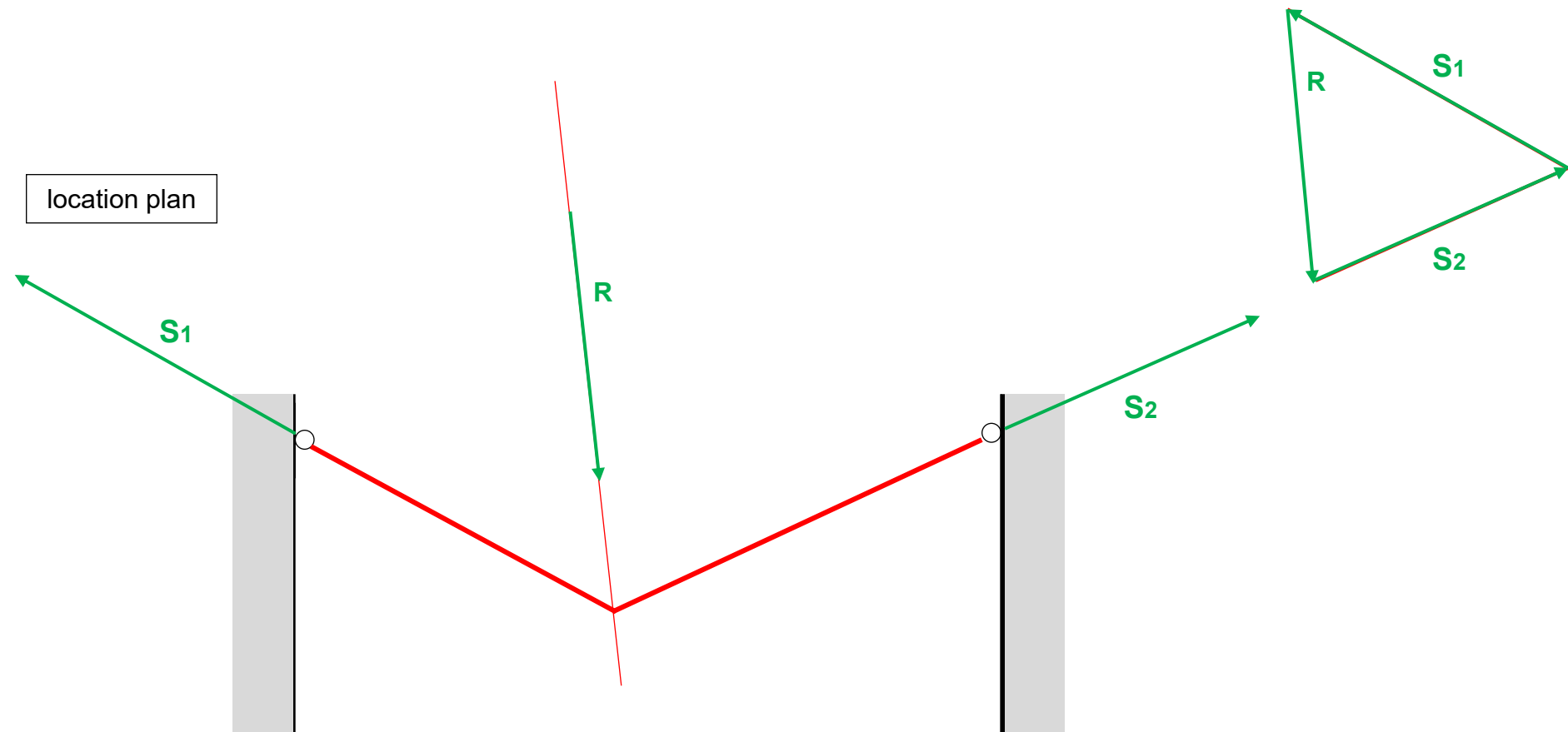

Equilibrium cable

force plan

location plan

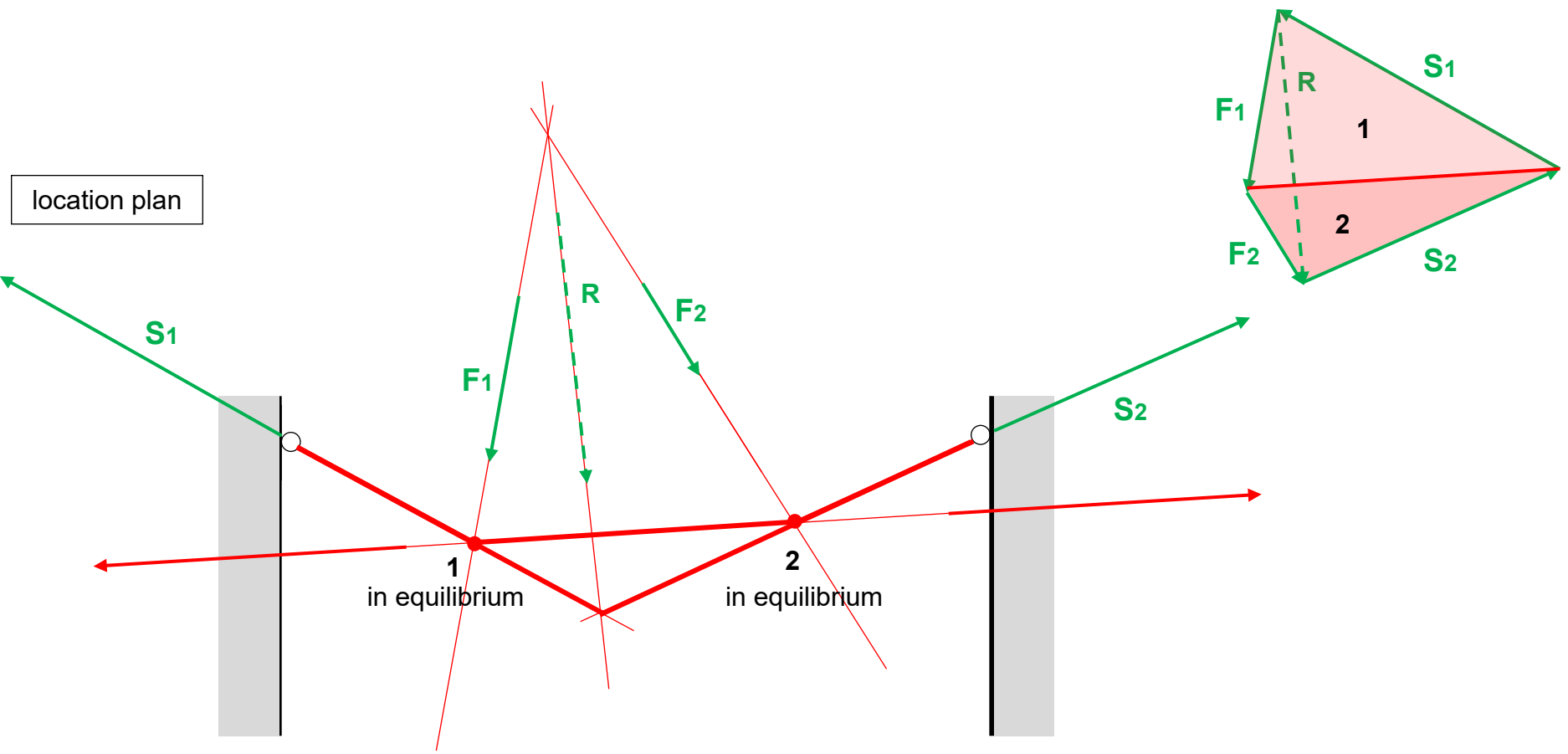

Equilibrium cable

force plan

location plan

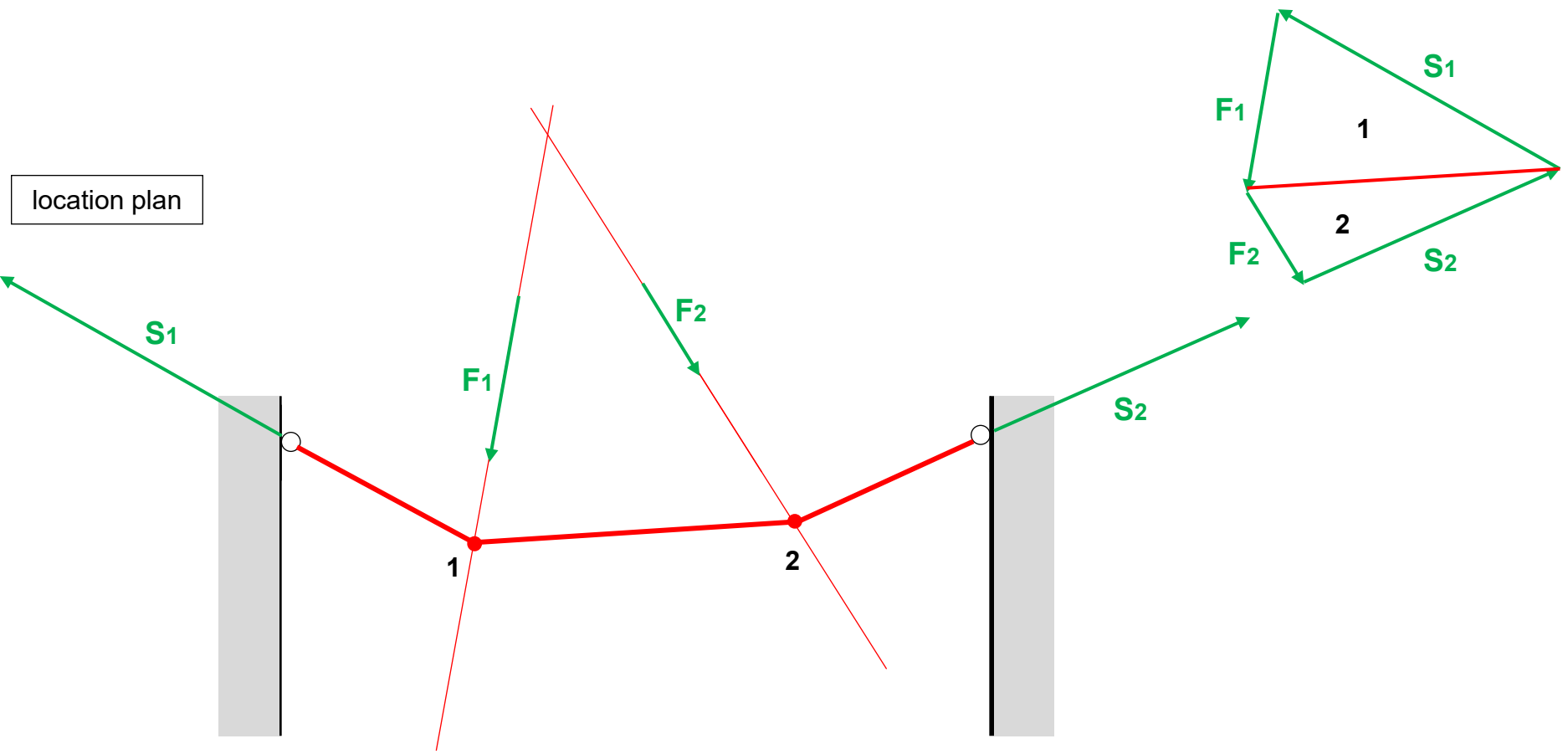

Equilibrium

cable

force plan

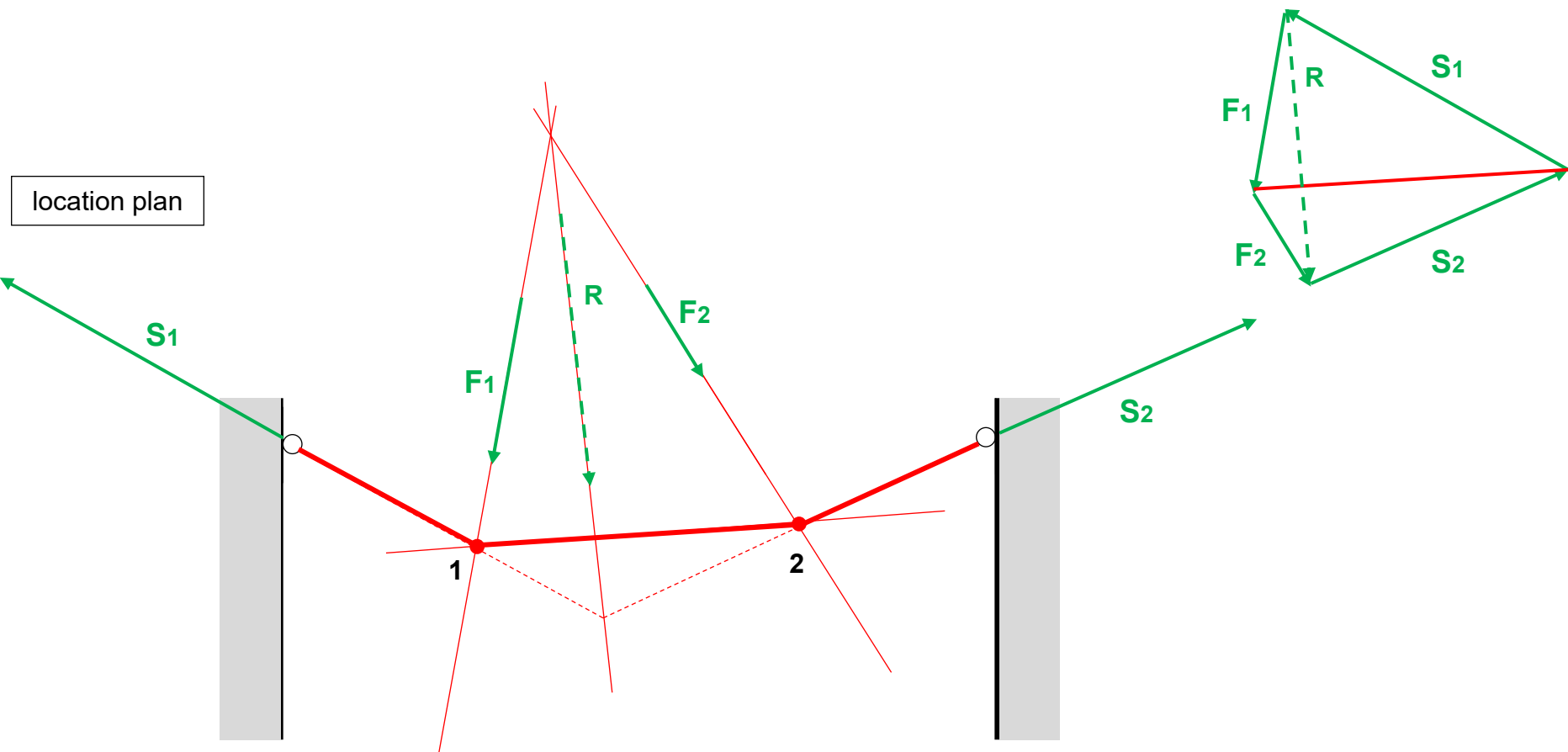

Step 1: construct R in force plan and location plan

Step 2: construct support forces S_1 & S_2

Step 3: construct inner forces in force plan

Step 4: use this inner forces to construct inflection points

Step 5: use inflection points to construct cable

Equilibrium cable

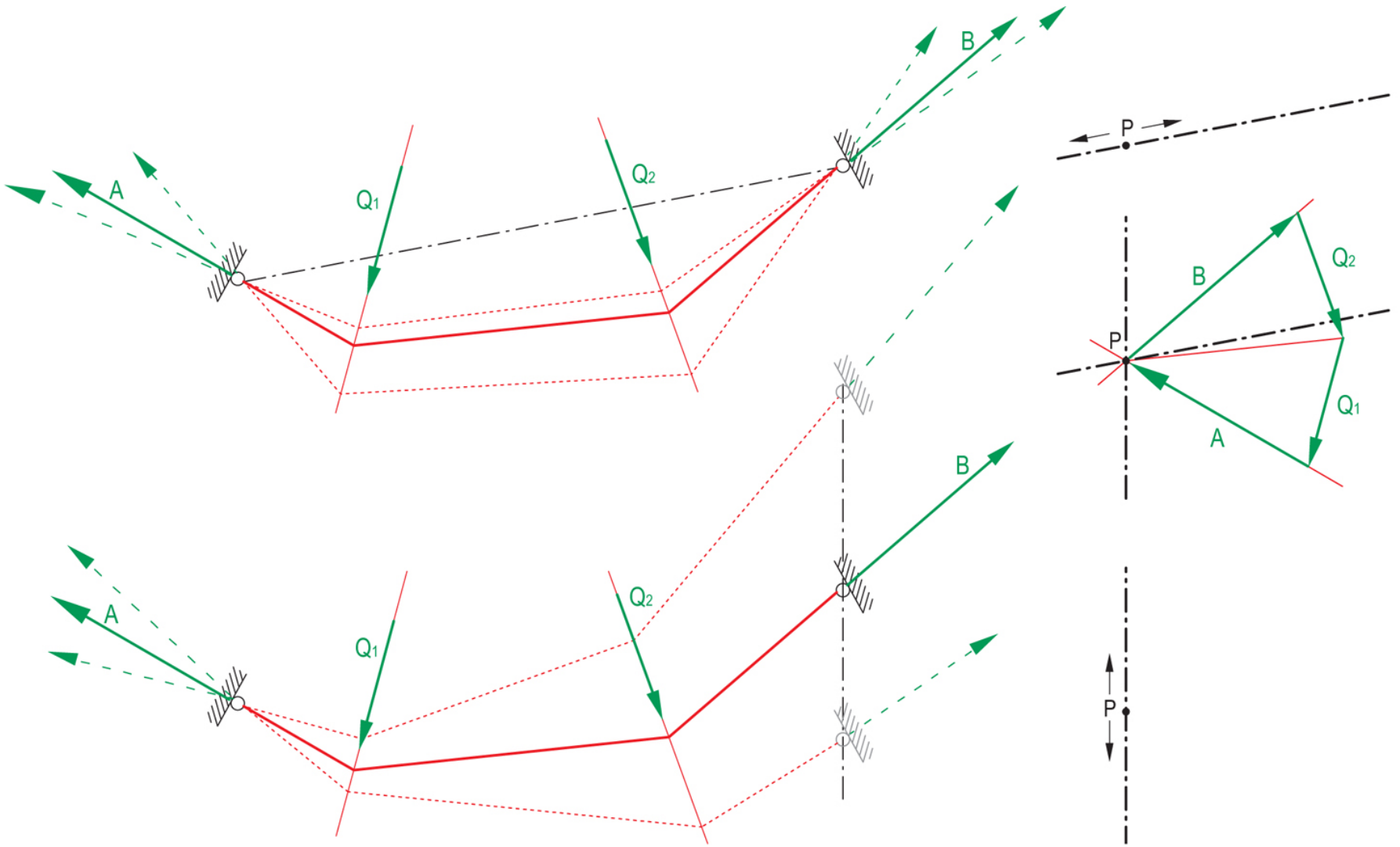

reciprocal relationship between form of cable and forces at support

Equilibrium cable

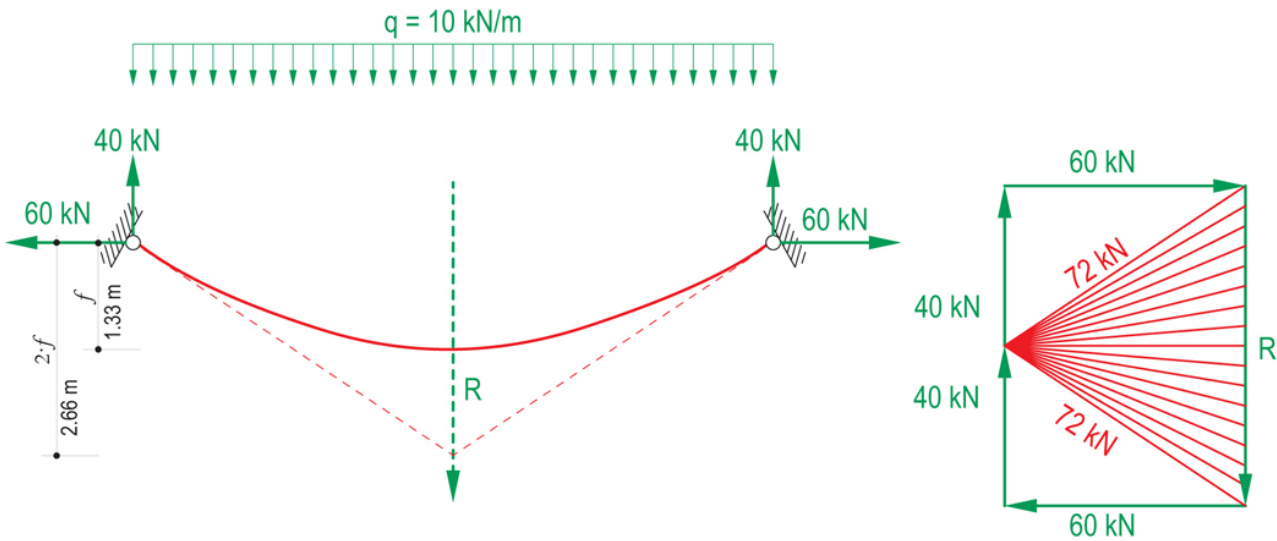
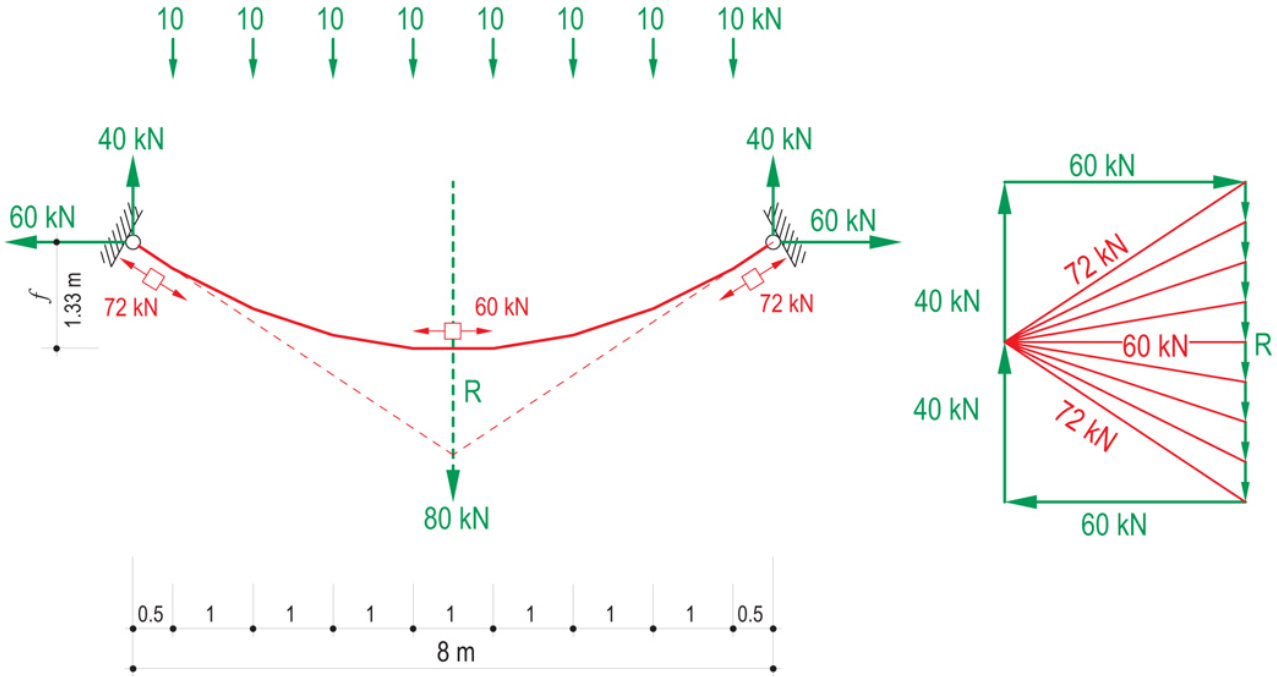



Alvaro Siza: Expo-Pavilion
Lisbon, Portugal, 1998

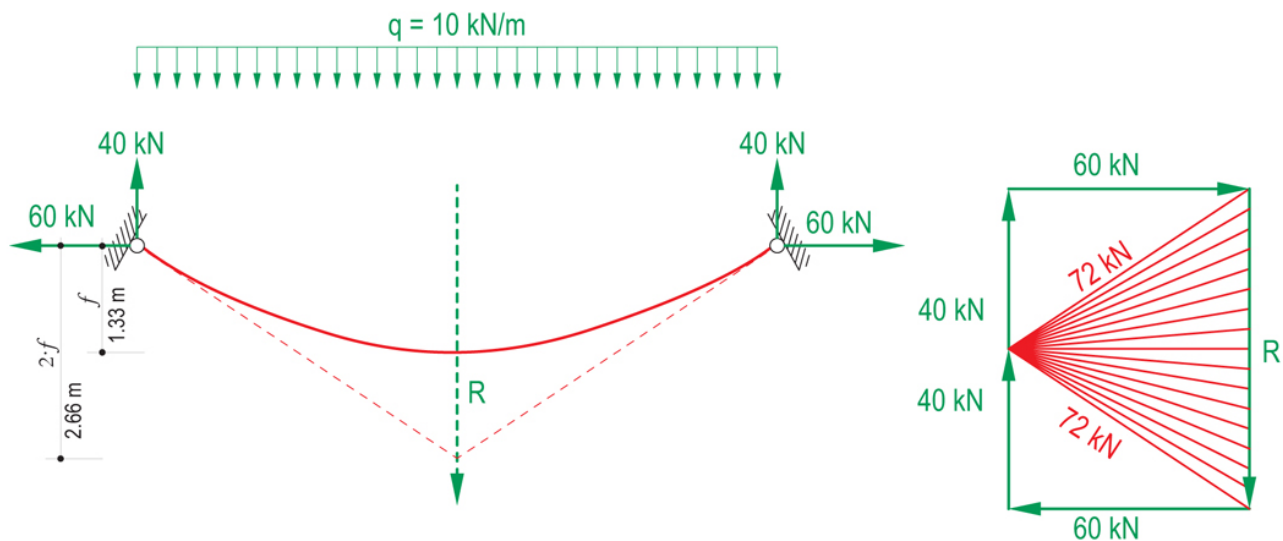



Alvaro Siza: Expo-Pavilion
Lisbon, Portugal, 1998



Alvaro Siza: Expo-Pavilion
Lisbon, Portugal, 1998



Eero Saarinen: Dulles Airport
Washington, USA, 1962

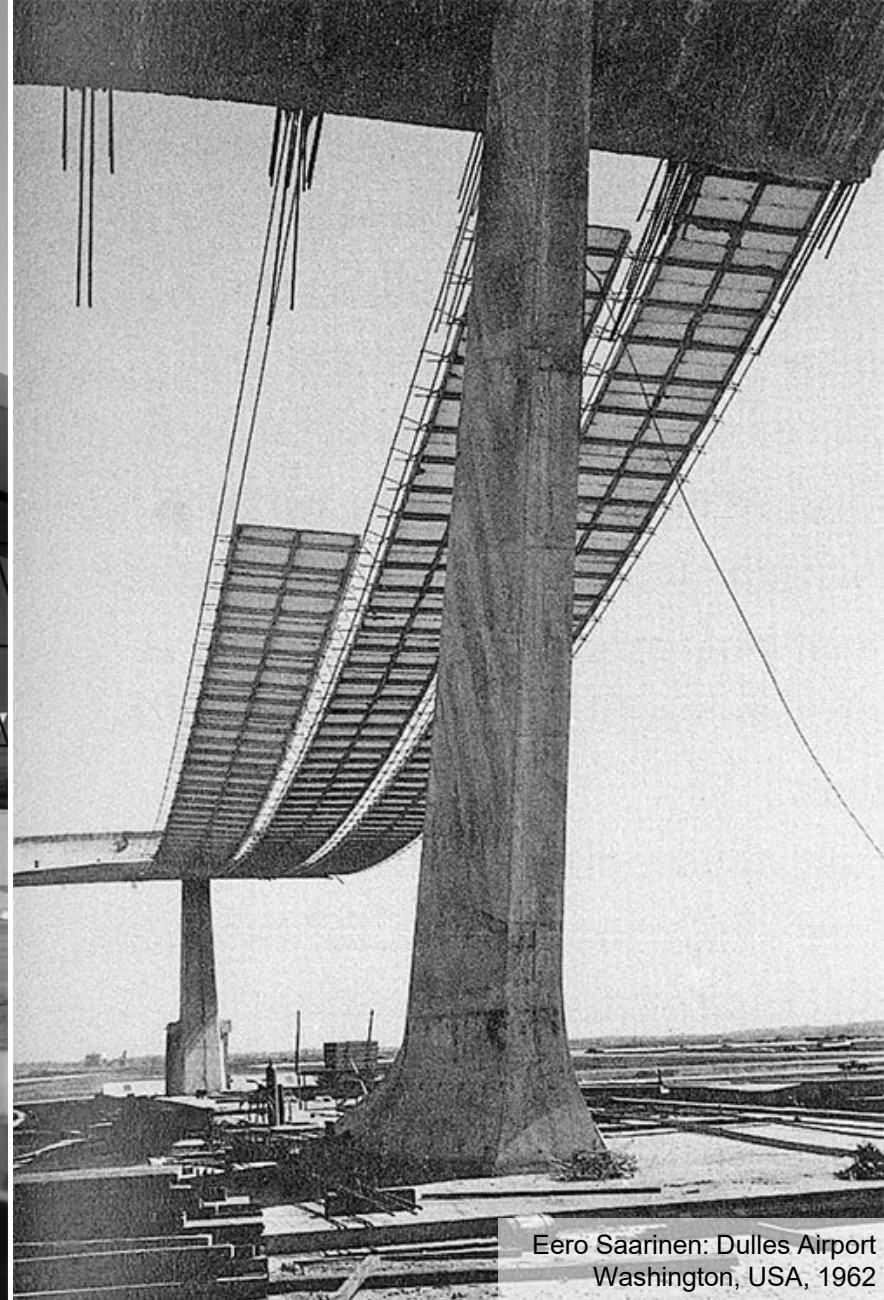

Eero Saarinen: Dulles Airport
Washington, USA, 1962

Principle of Duality

cable

only tension as inner forces

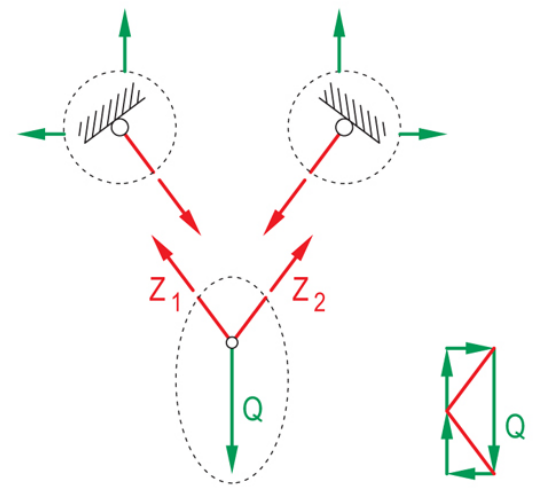
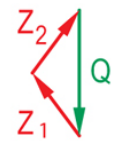
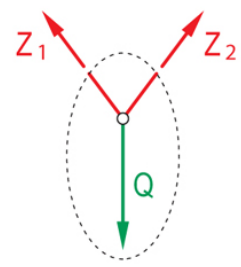
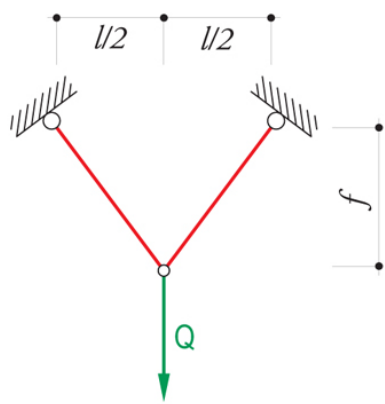

arch

only compression as inner forces

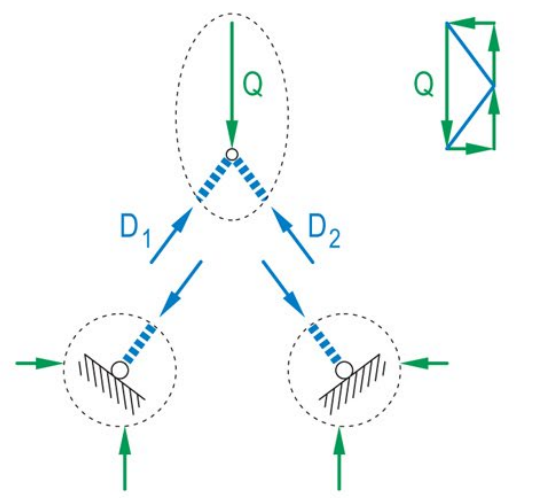
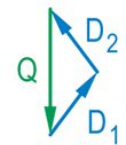
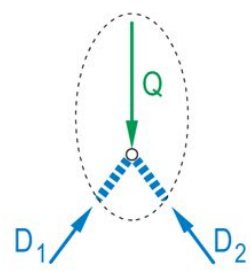
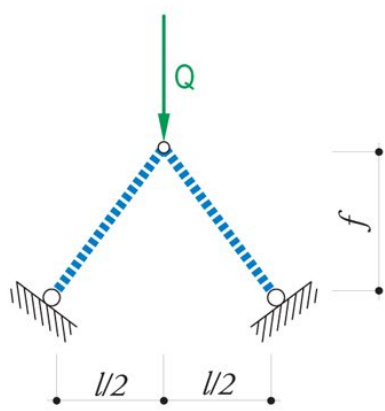

Principle of Duality

cable

only tension
as inner forces

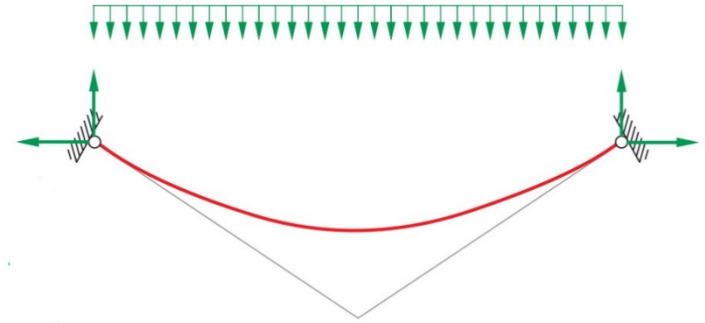
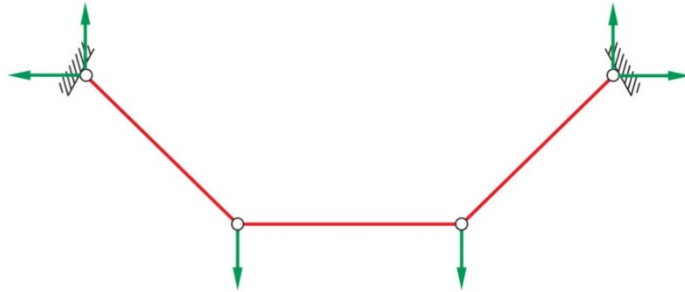

arch

only compression
as inner forces

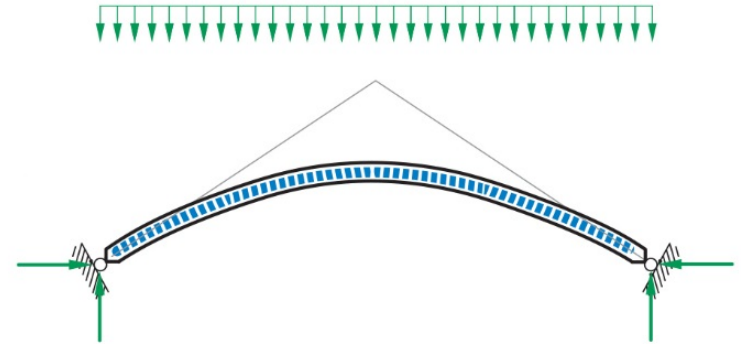
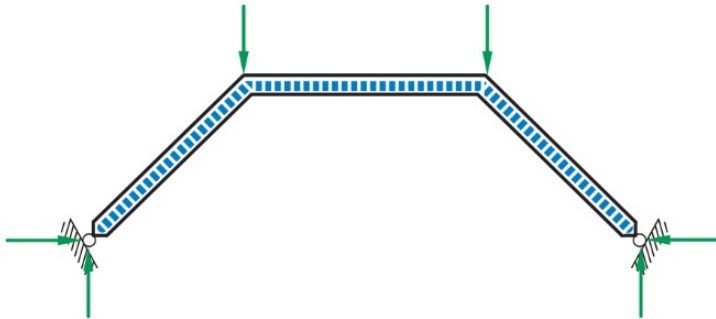

Principle of Duality



Antoni Gaudi: hanging model
Sagrada Família, Barcelona, Spain
around 1889



Antoni Gaudi: hanging model
Sagrada Familia, Barcelona, Spain
around 1889

Principle of Duality

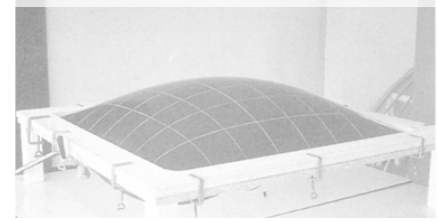

Pneumatic Membrane



Hanging Form

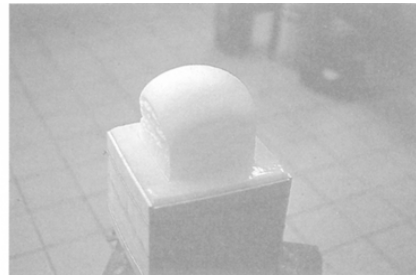

Flow Form

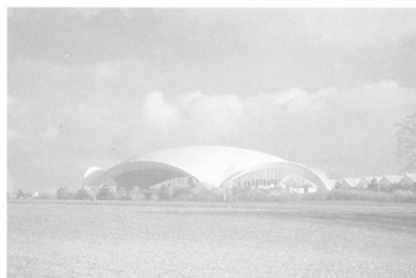
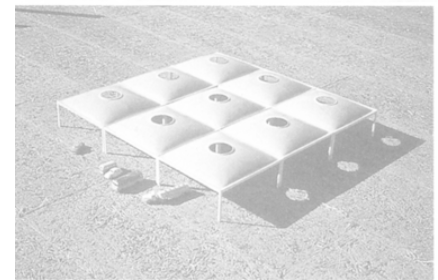
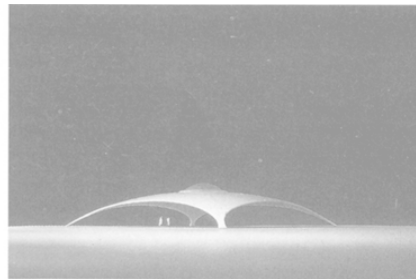
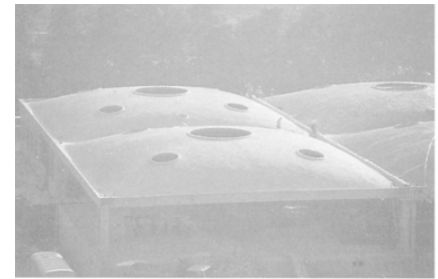

Heinz Isler: New Shapes of Shells
IASS Conference, Madrid, 1955



Heinz Isler: experimental setup for form-finding of hanging forms

Principle of Duality

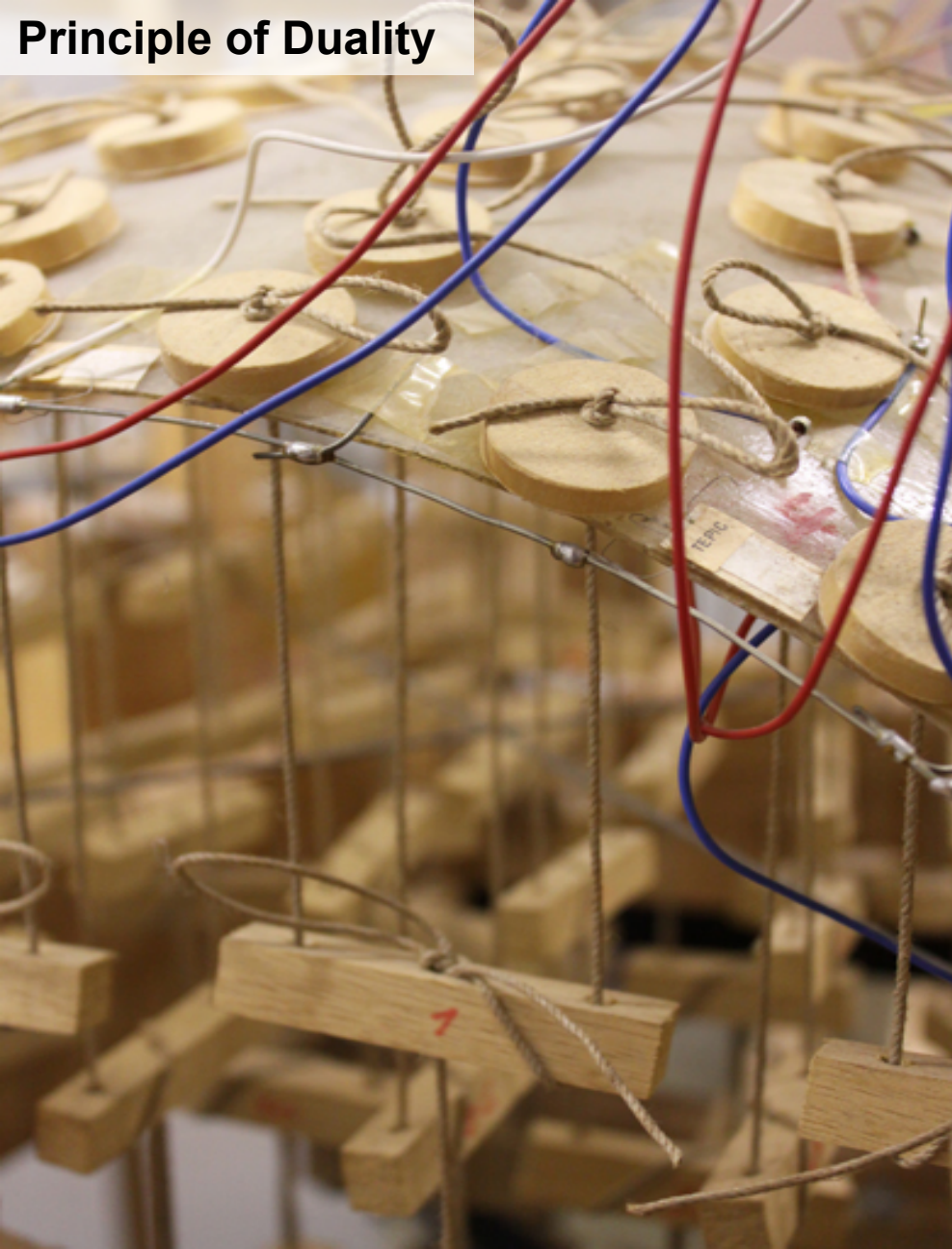

Heinz Isler: experimental setup for form-finding of hanging forms



Heinz Isler: study of variations

Principle of Duality



Heinz Isler: Wyss Garden Center
Solothurn, Switzerland, 1962

Principle of Duality



Heinz Isler: Gasstation
Deitingen, Switzerland, 1968

Principle of Duality

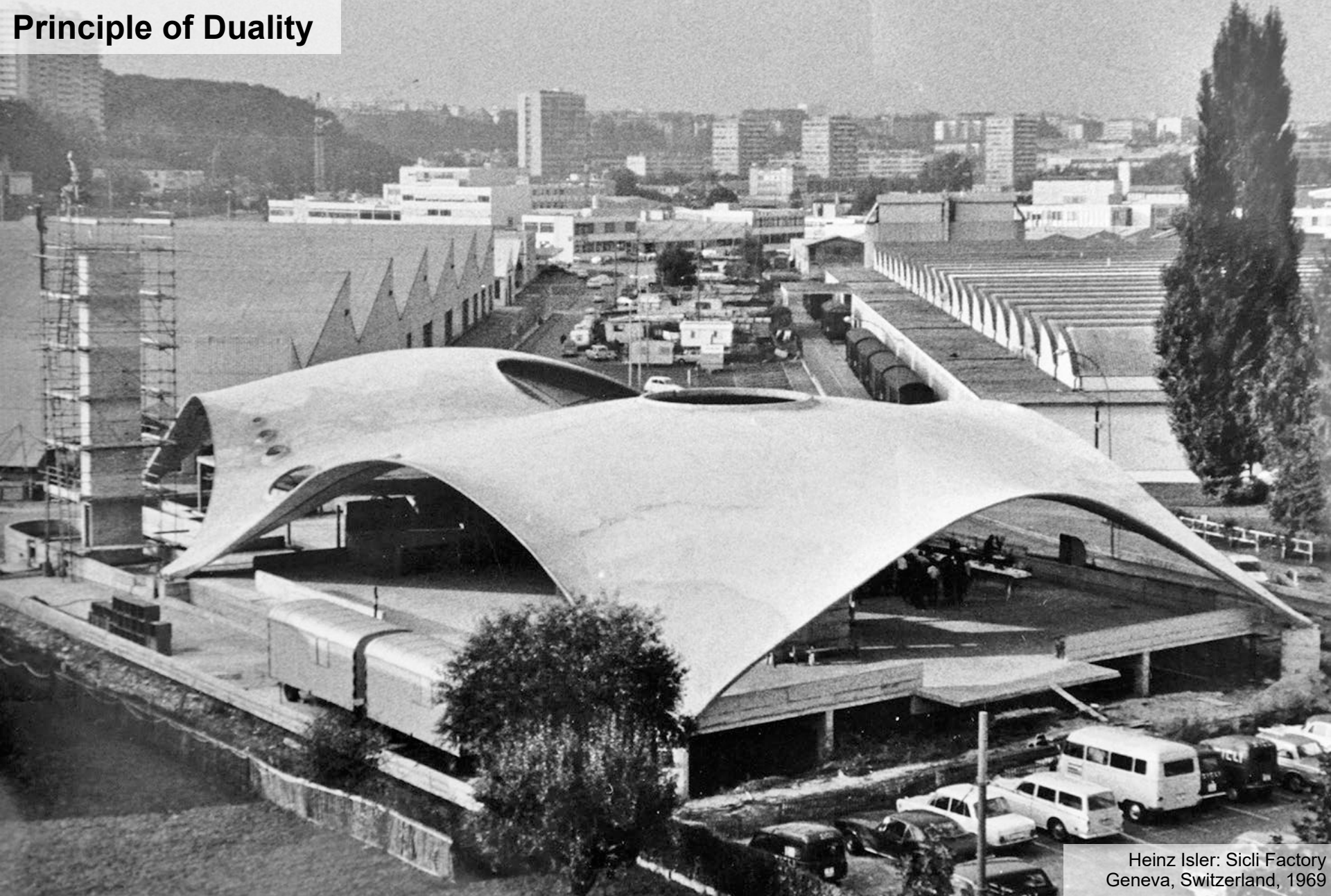

Heinz Isler: Sici Factory
Geneva, Switzerland, 1969

Inner Forces

tension

compression

inner forces act upon material

form & inner forces are coupled

cable as tension-only structure

arch as compression-only structure

principle of duality

ARK-A3001 Design of Structures_Basics Form & Force

Toni Kotnik

Professor of Design of Structures

Aalto University
Department of Architecture
Department of Civil Engineering



Exercise 2.1

Construct a cable (a) and an arch (b) as equilibrium solution for the given three forces F_1 , F_2 and F_3 . How is the form changing if F_1 is doubled?

location plan



F_1



F_2



F_3

