

Introduction to scanning electrochemical microscopy (SECM)

Peter Liljeroth
Bernadette Quinn

Scanning electrochemical microscopy:

- Current flow at a probe electrode, “SECM tip”, is measured
- Can be used to probe the reactivity of insulating, conducting and semi-conducting substrates
- Member of the scanning probe microscopy (SPM) - family
- First introduced in the late 1980s by Engstrom et al. and by Bard et al.
- Subsequently developed into an established electrochemical technique

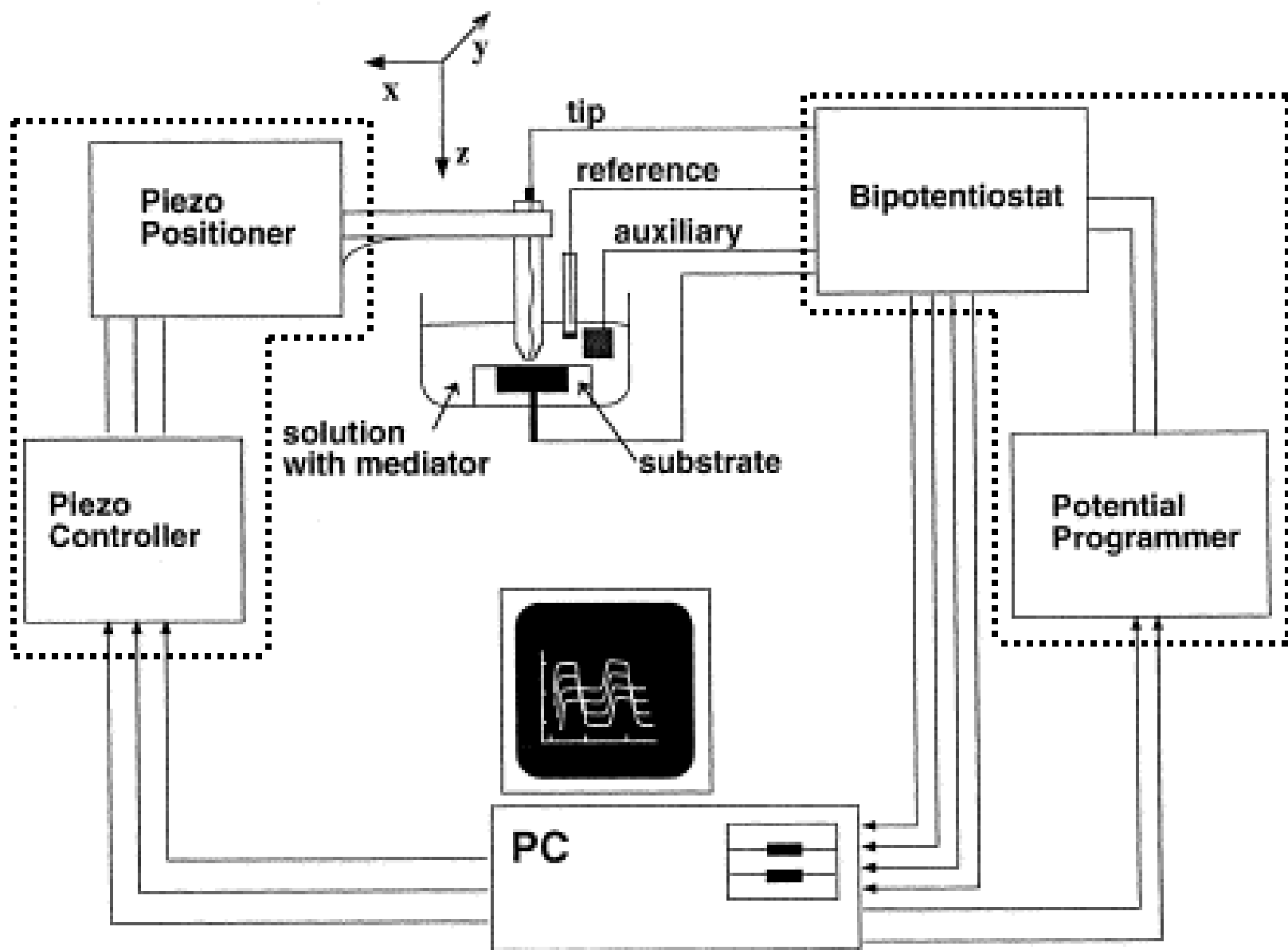

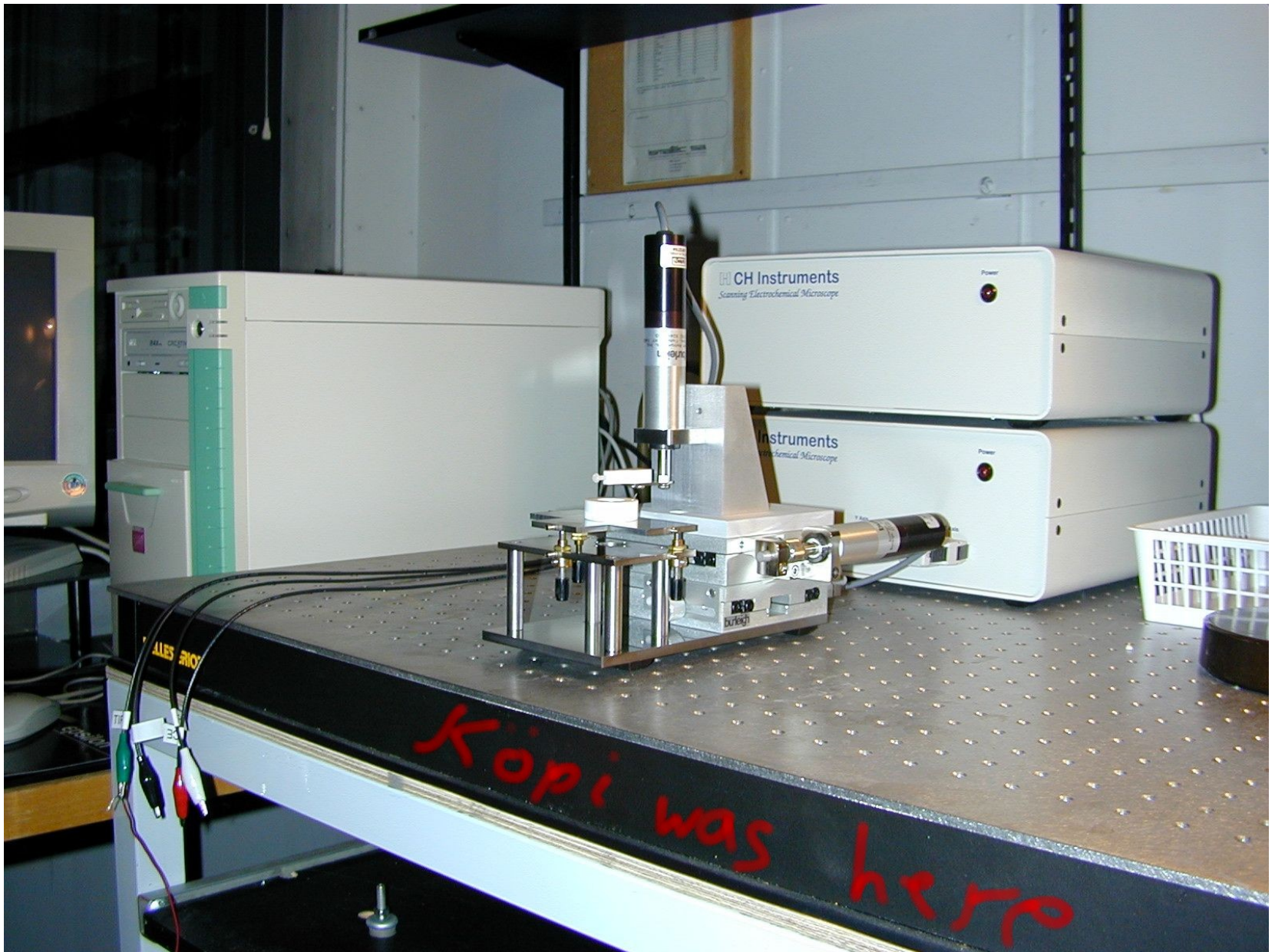

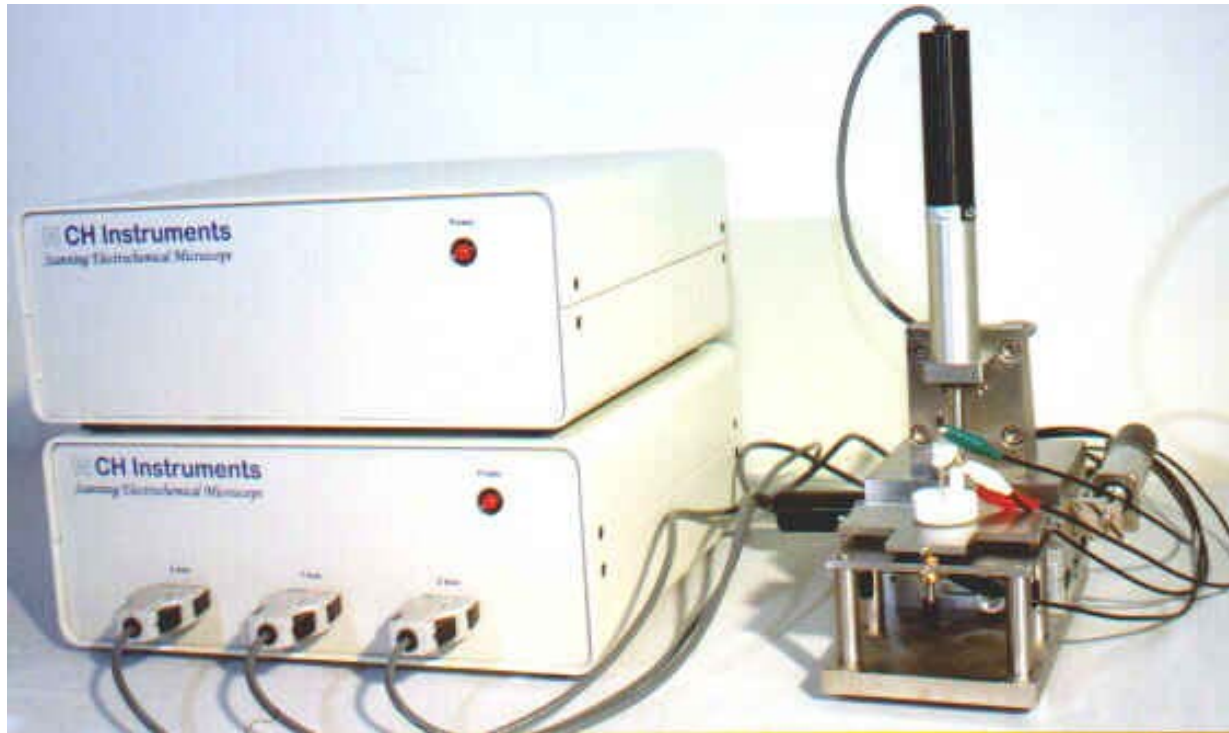

Different SECM operating modes:

- Amperometric feedback mode
- Generation / collection mode
- Potentiometric detection
- Transient methods

Equilibrium perturbation

Double potential step chronoamperometry

- Scanning mode

Amperometric
feedback
mode

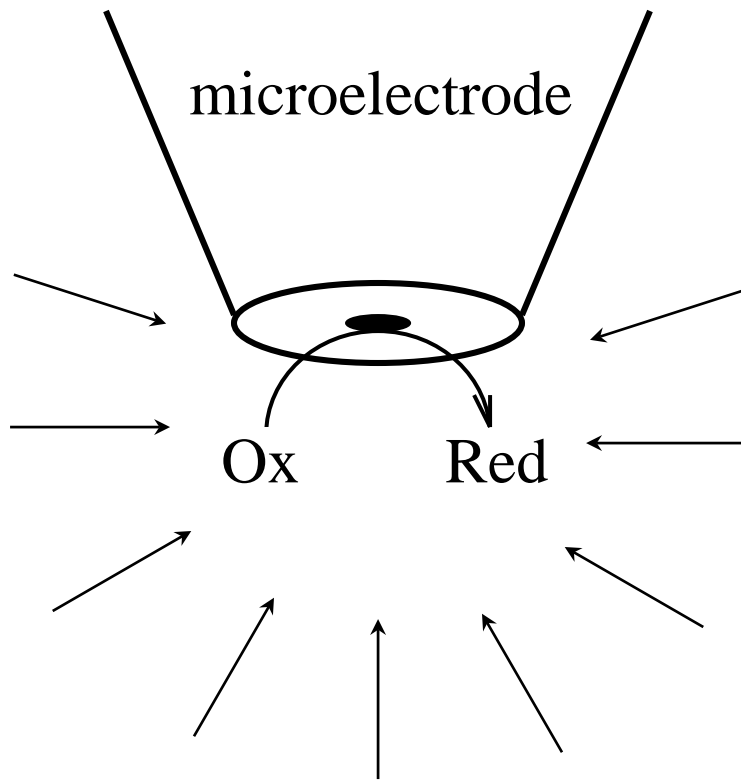

- Diffusion to a microelectrode
- Measure the change due to the proximity of a surface
- Relate this change to the reactivity and topography of the surface

Negative feedback:

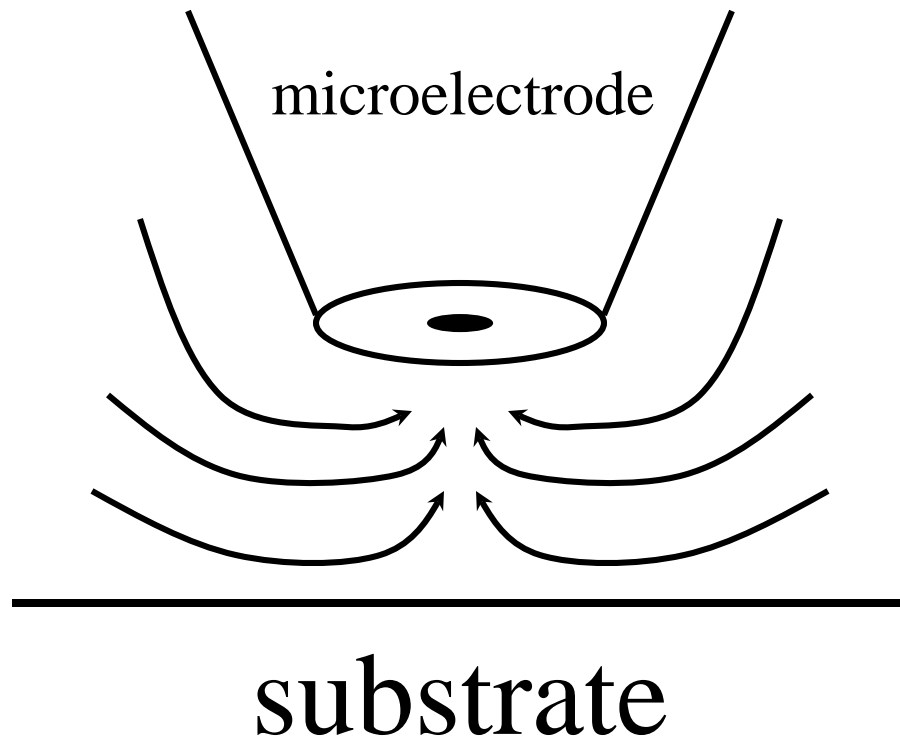

- Hindered diffusion due to the presence of the substrate
- The measured current lower than in the bulk

Positive feedback:

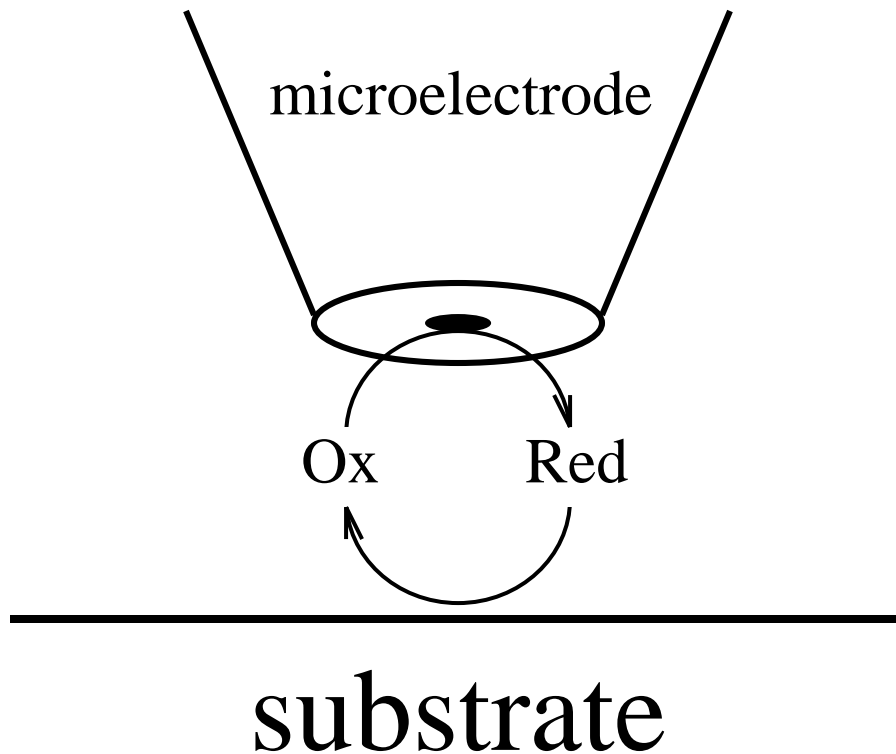

- Redox mediator regeneration occurs at the substrate
- The measured current higher than in the bulk

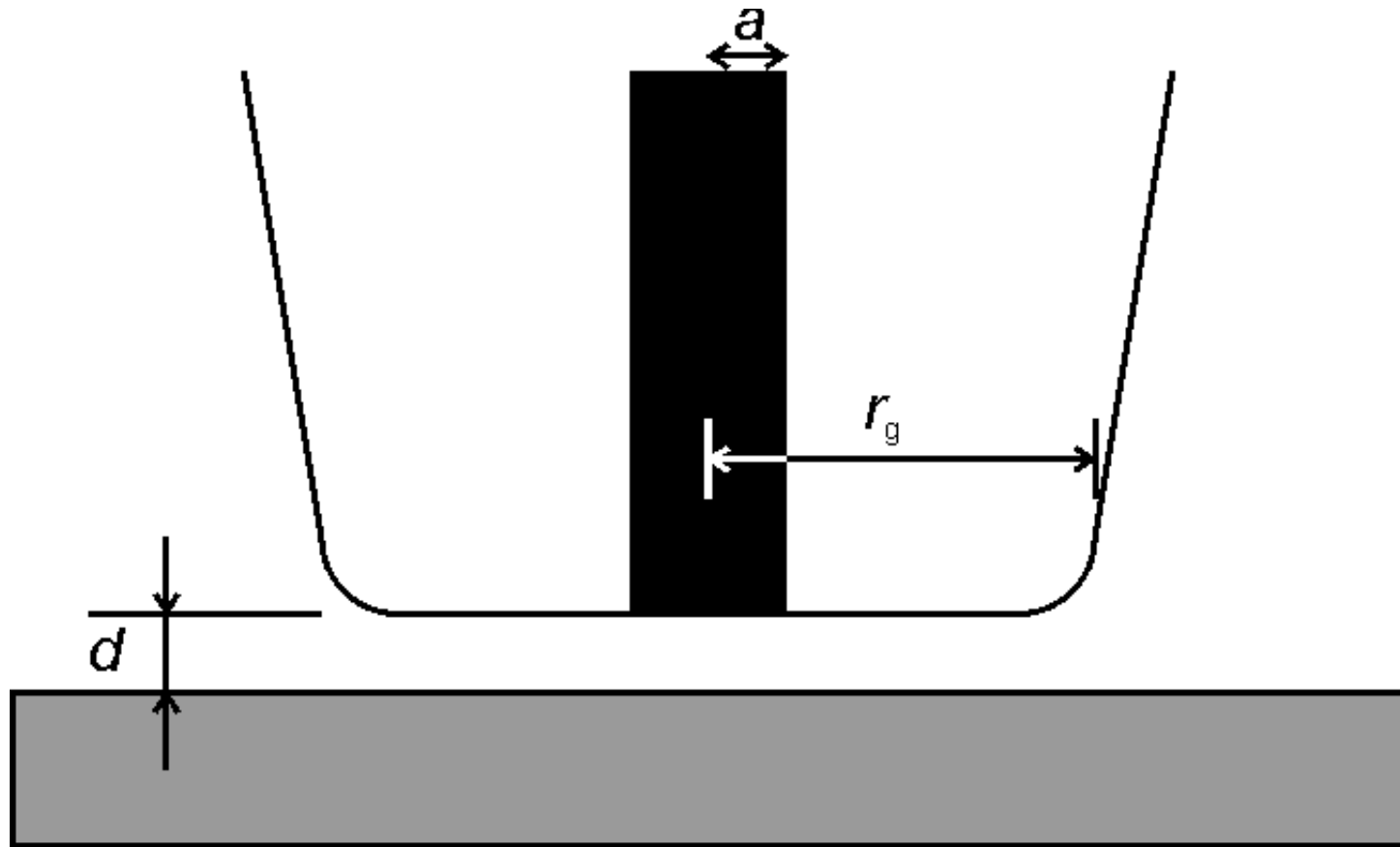

dimensionless coordinates:

$$L = d / a$$

$$R_g = r_g / a$$

Fick's second law:

$$\frac{\partial c}{\partial t} = D \left(\frac{\partial^2 c}{\partial r^2} + \frac{1}{r} \frac{\partial c}{\partial r} + \frac{\partial^2 c}{\partial z^2} \right)$$

dimensionless quantities

$$C = c / c^b; \quad R = r / a;$$

$$Z = z / a; \quad T = t D / a^2$$

$$\rightarrow \frac{\partial C}{\partial T} = \frac{\partial^2 C}{\partial R^2} + \frac{1}{R} \frac{\partial C}{\partial R} + \frac{\partial^2 C}{\partial Z^2}$$

At steady-state:

$$\frac{\partial^2 C}{\partial R^2} + \frac{1}{R} \frac{\partial C}{\partial R} + \frac{\partial^2 C}{\partial Z^2} = 0$$

Initial condition

$$c_{\text{Ox}}(r, z, t=0) = c^b$$

Reaction at the tip,



at a diffusion controlled rate, hence

$$c_{\text{Ox}}(r < a, z=0, t) = 0$$

If $D_{\text{Ox}} = D_{\text{Red}}$, the principle of mass-conservation gives

$$c_{\text{Red}}(r, z, t) = c^b - c_{\text{Ox}}(r, z, t)$$

and only a single species needs to be considered.

This always applies at steady-state.

Initial condition

$$C(R, Z, T=0) = 1$$

At an insulating substrate

$$\partial C / \partial Z = 0$$

At a conducting substrate



at a diffusion controlled rate

$$c_{\text{Red}}(r, z=d, t) = 0$$

$$\Rightarrow C(R, Z=L, T) = 1$$

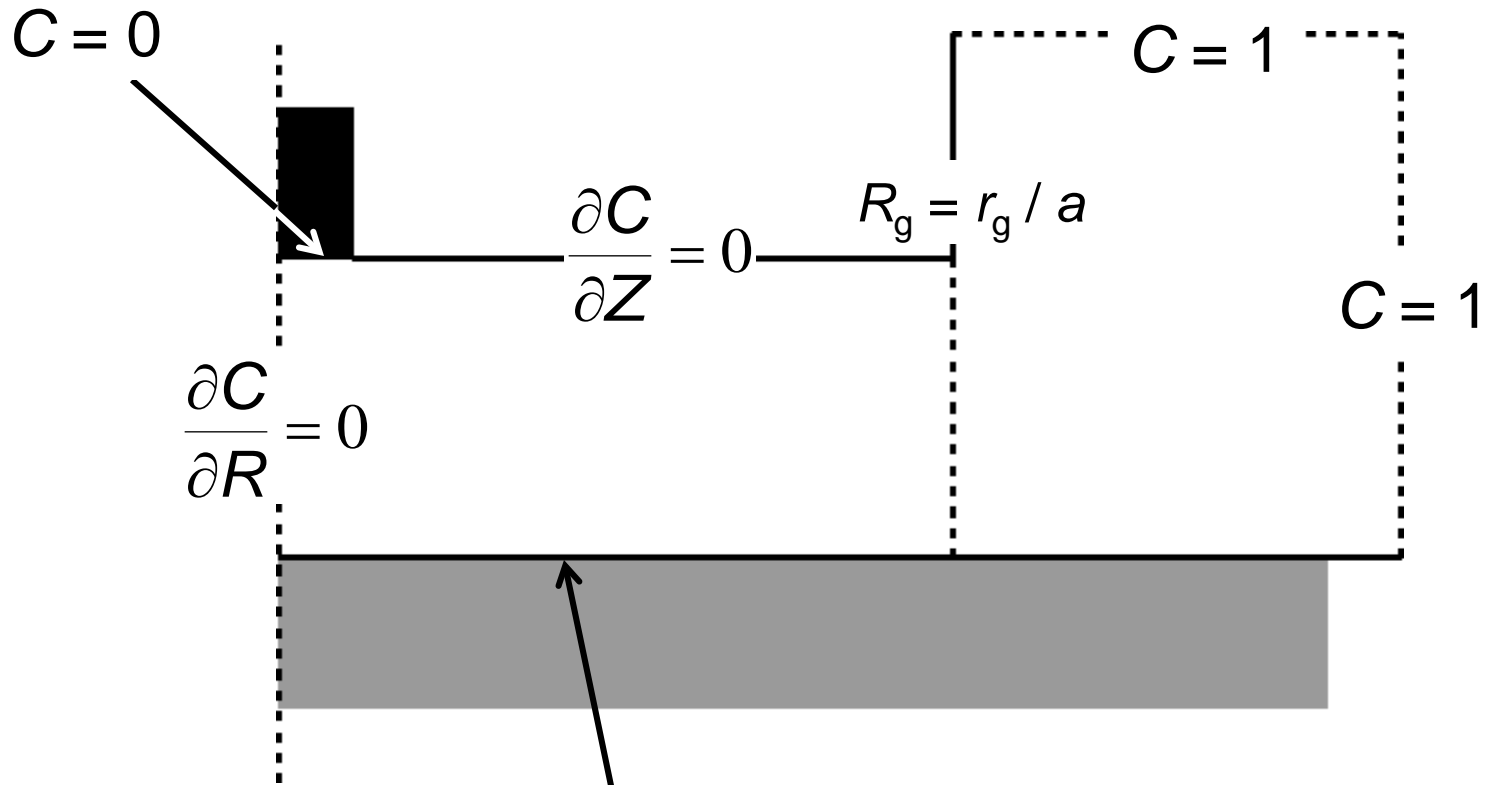

boundary condition at the substrate:

$C = 1$ (conducting)

$\partial C / \partial Z = 0$ (insulating)

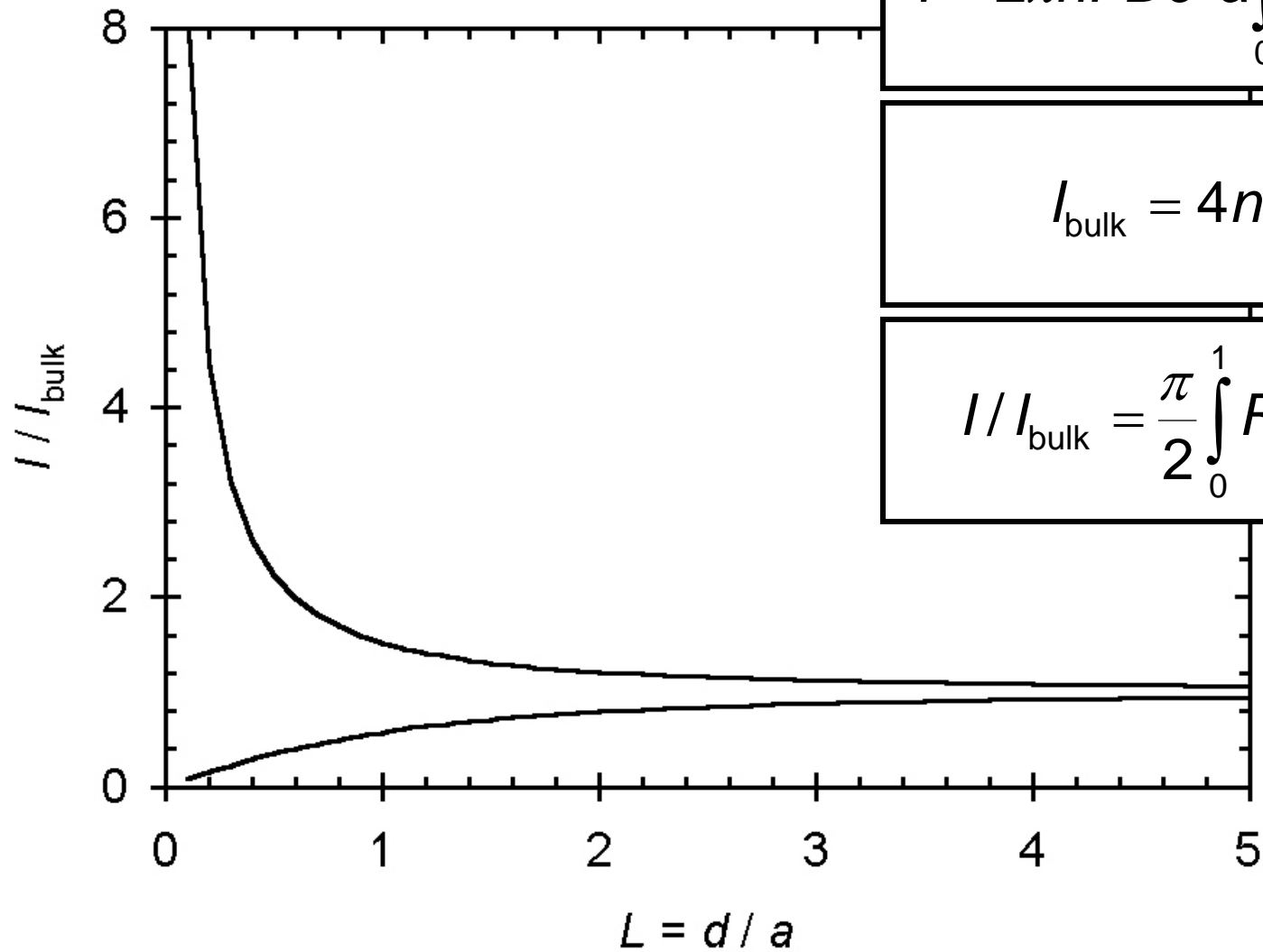

$L = 5.0$

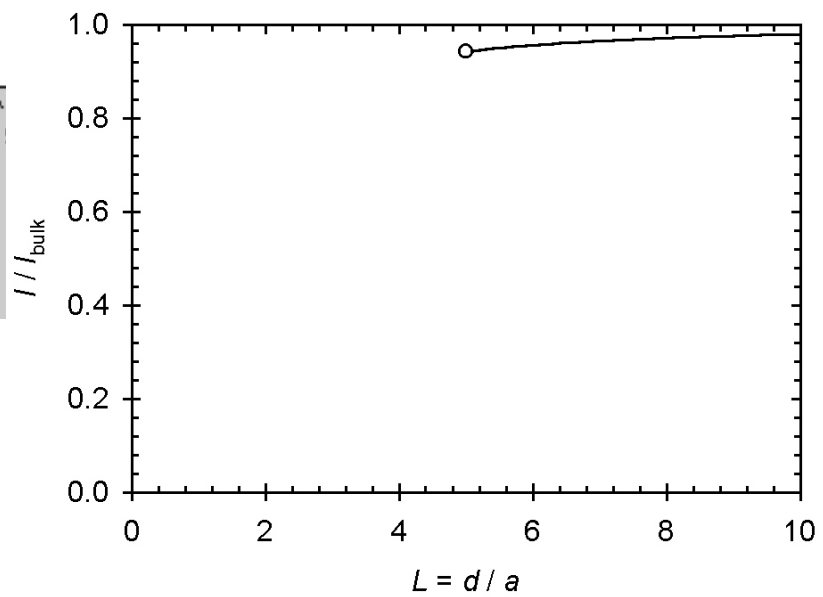
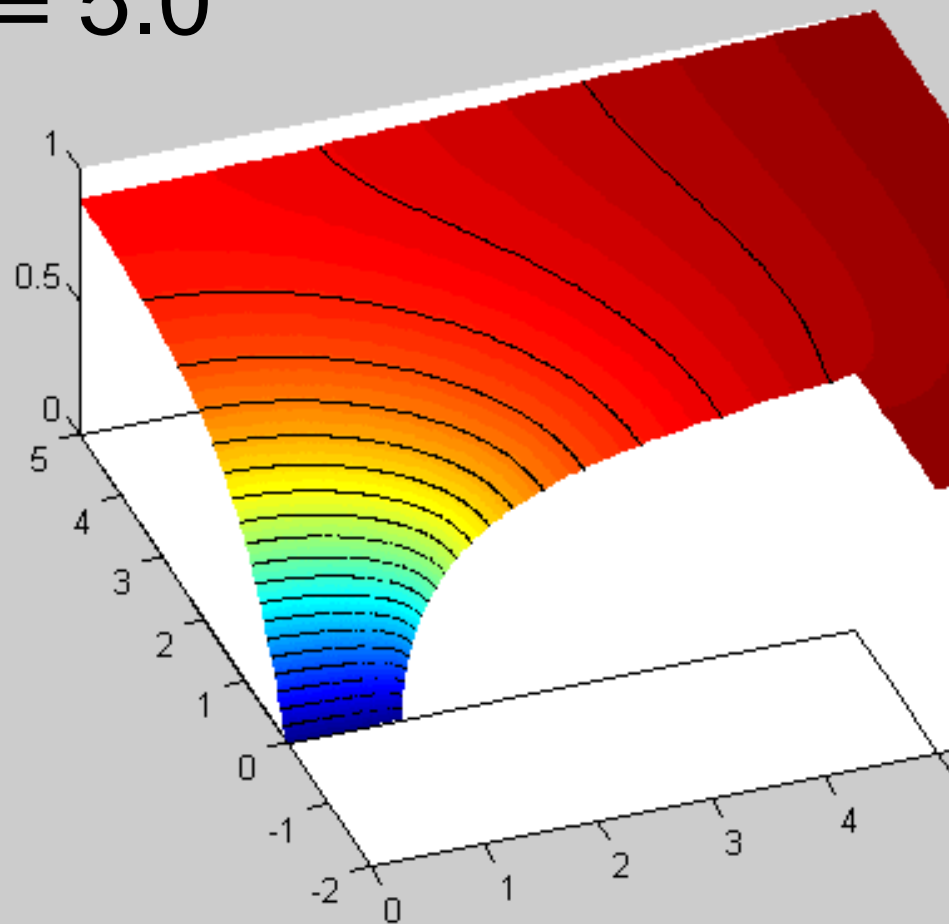

$L = 2.5$

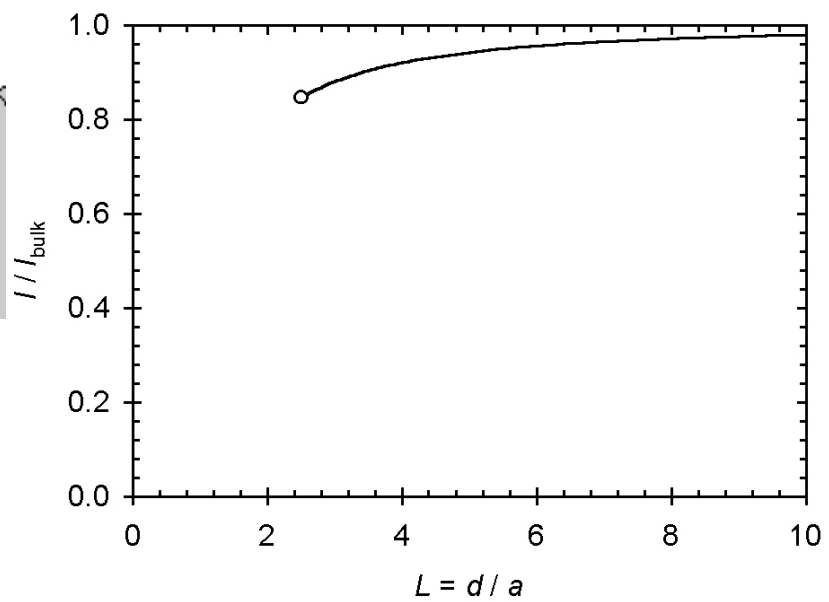
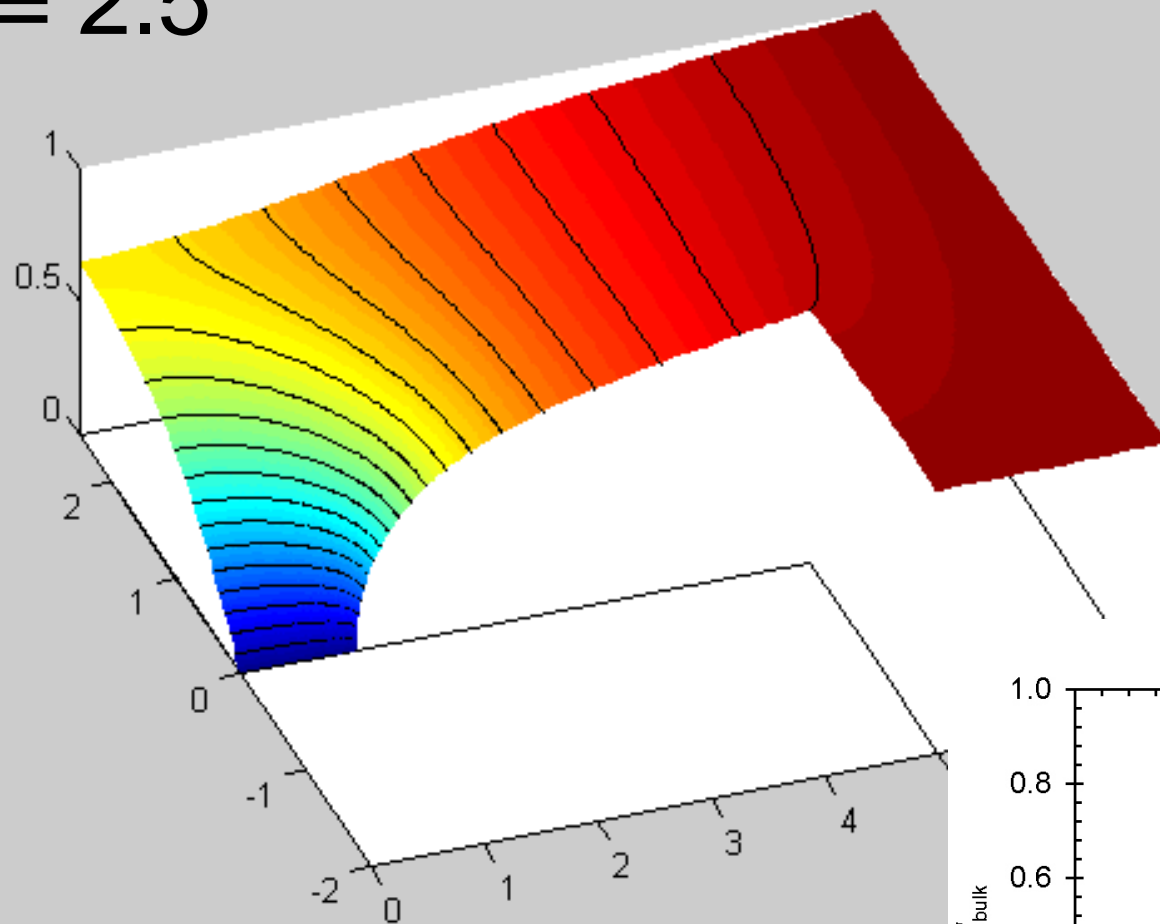

$L = 1.0$

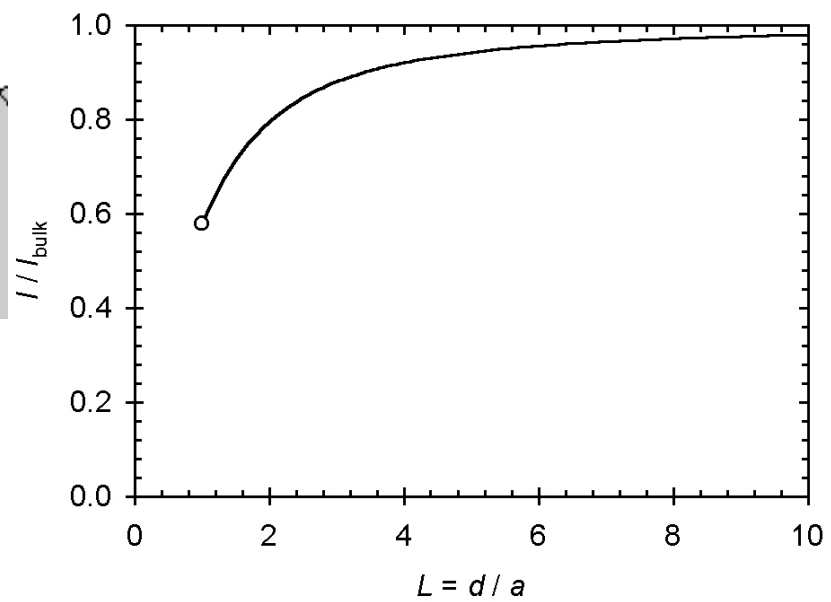
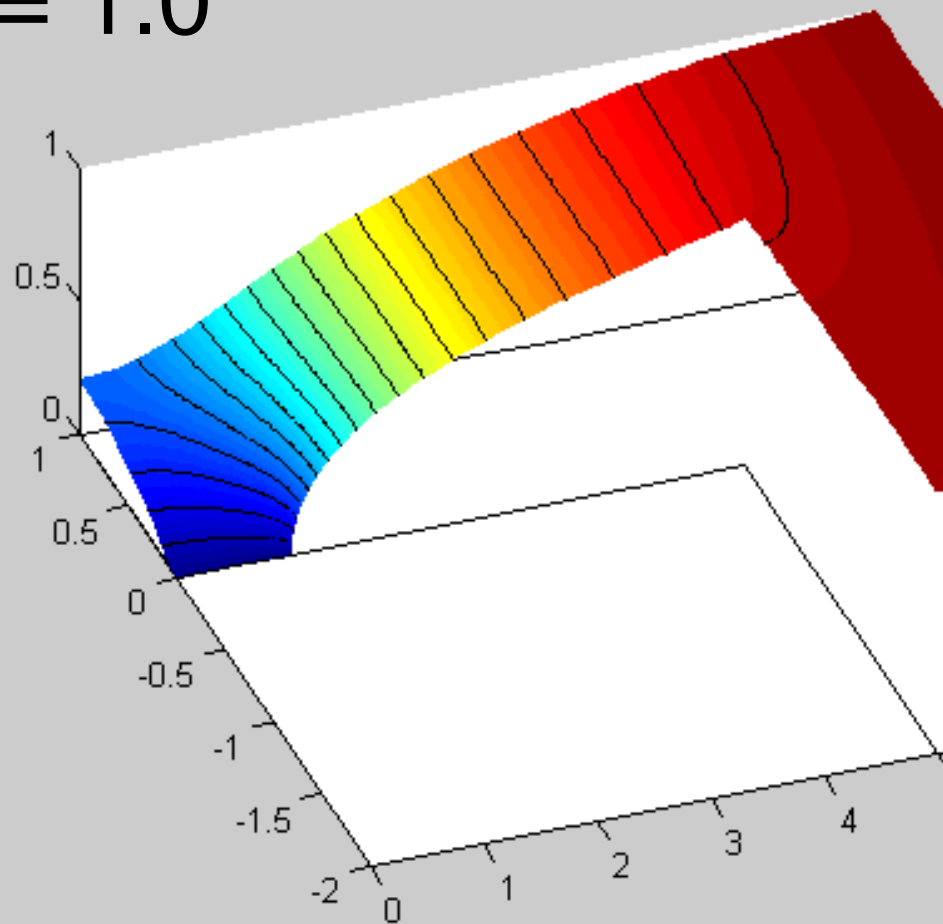

$L = 5.0$

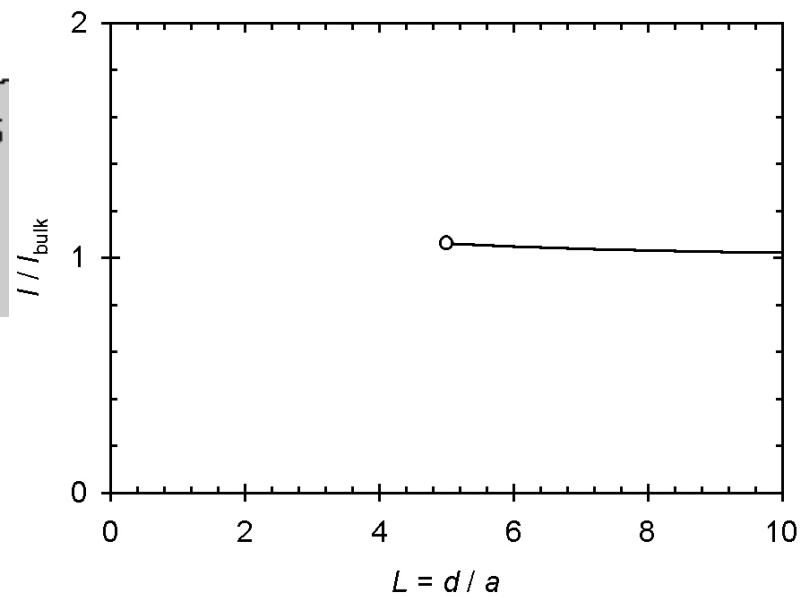
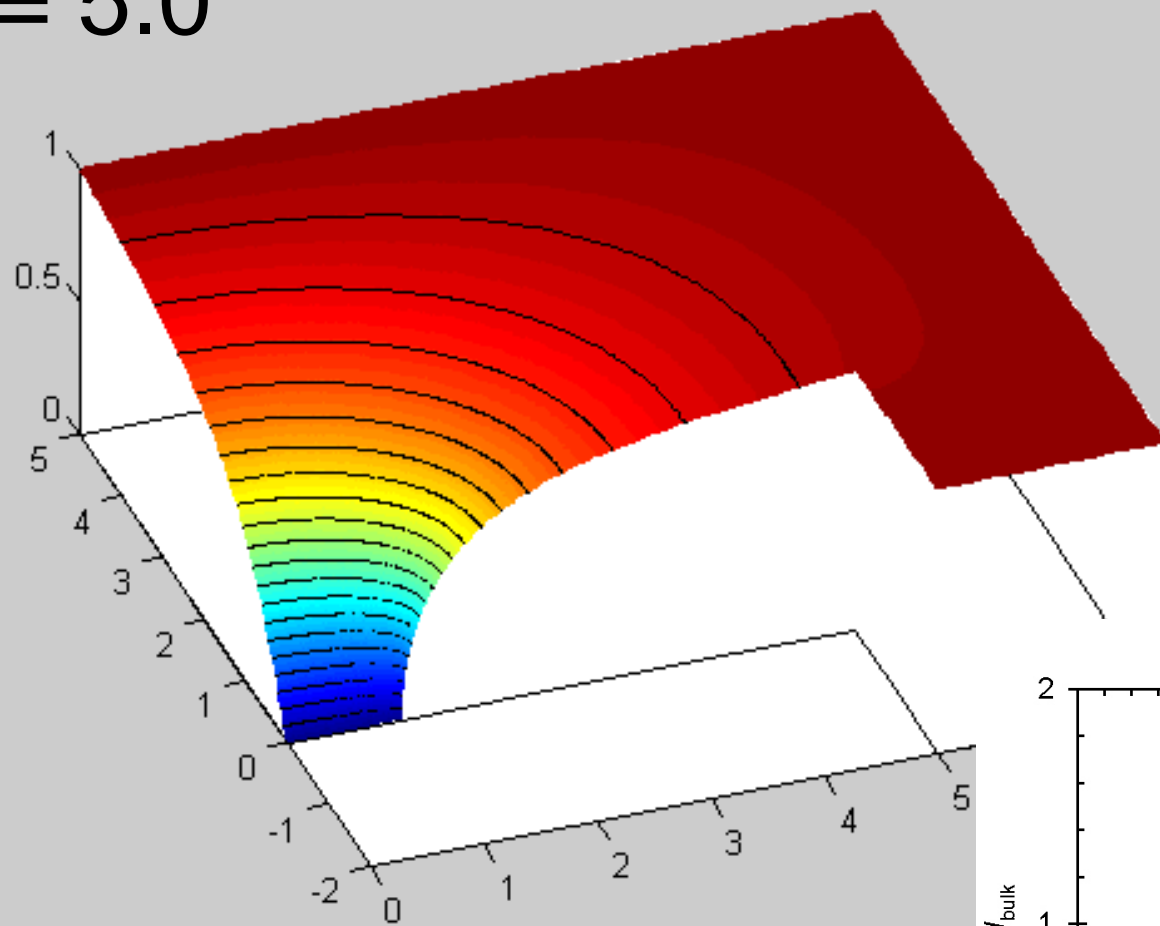

$L = 2.5$

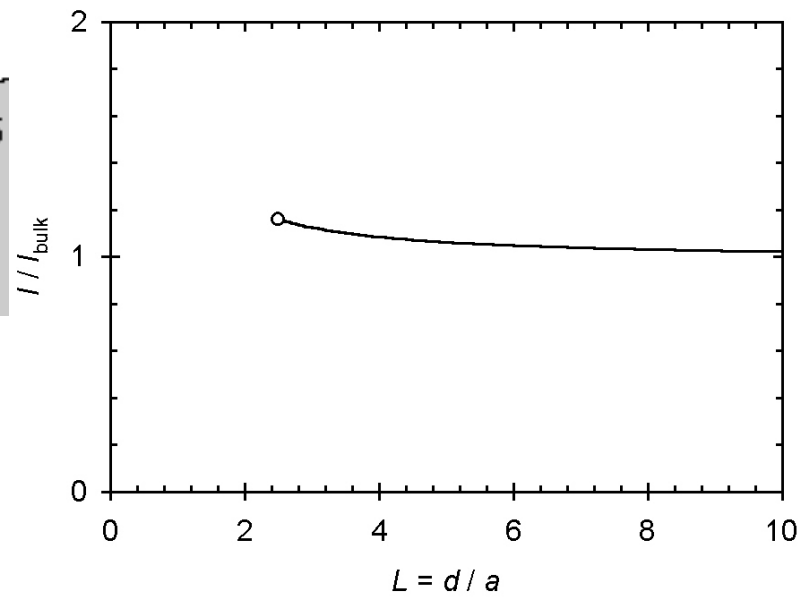
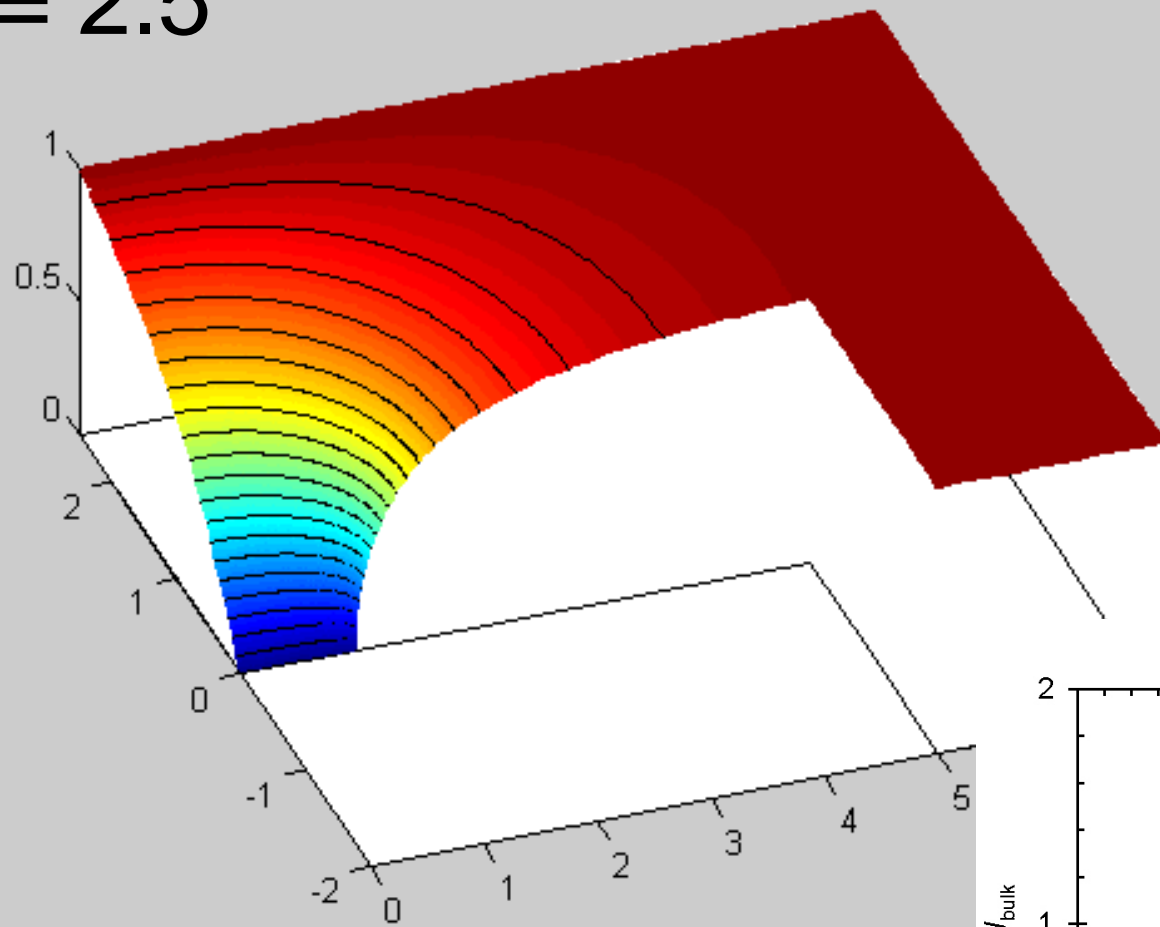

$L = 1.0$

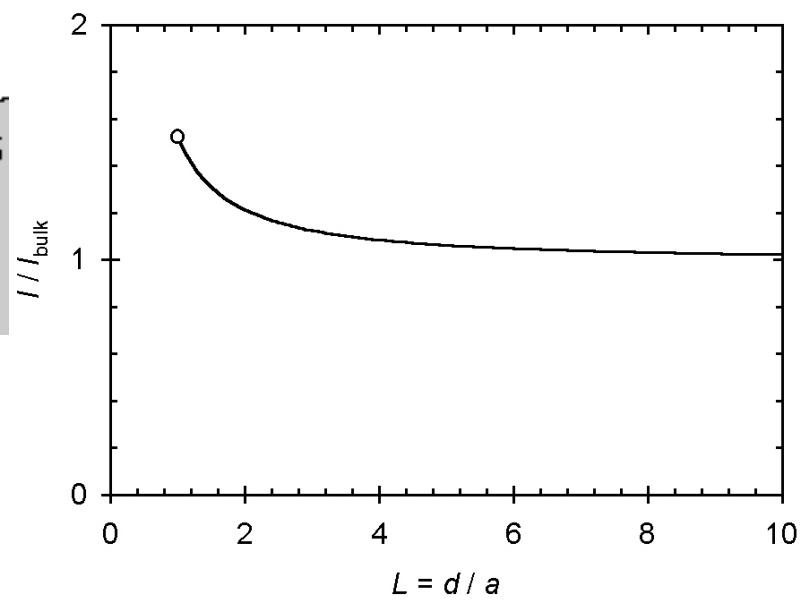
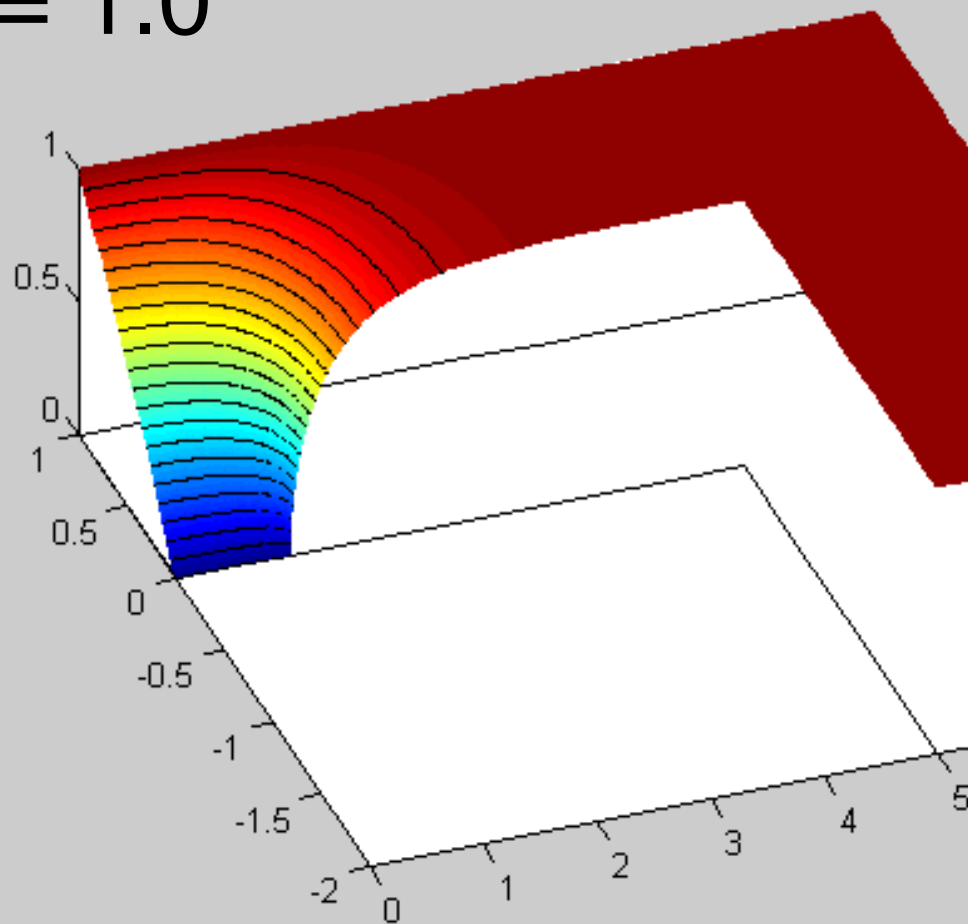

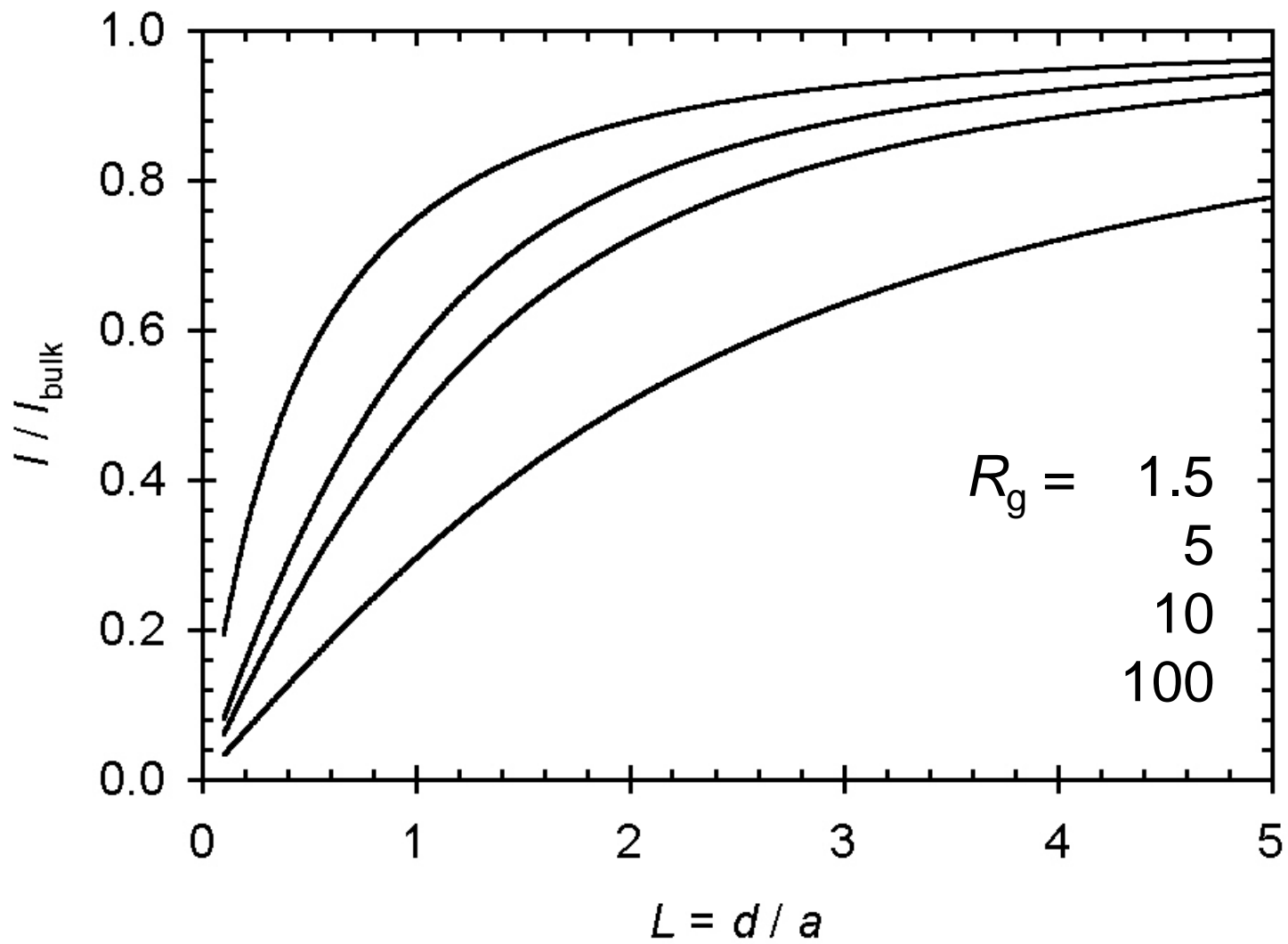

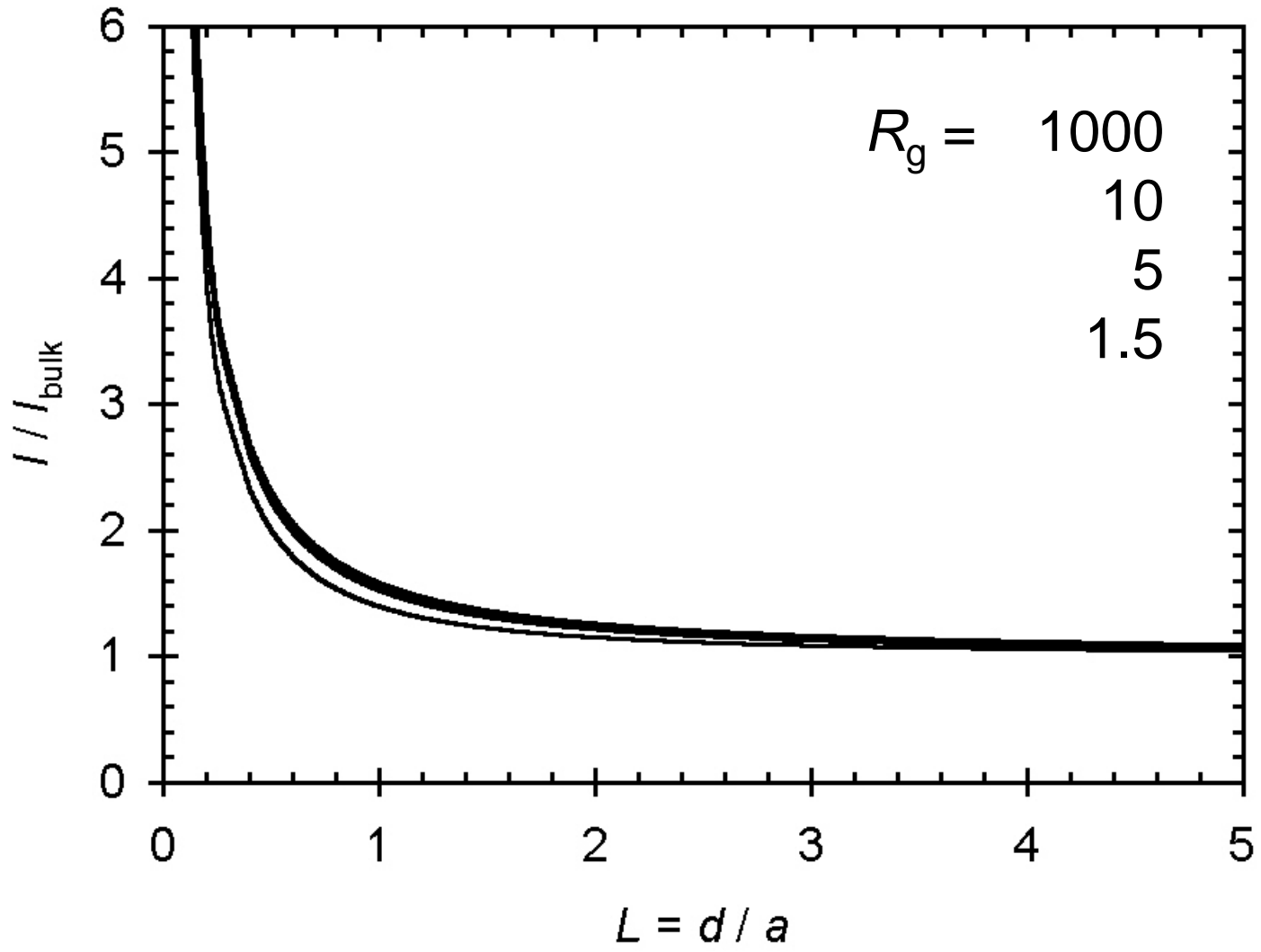

Kinetics at the substrate:

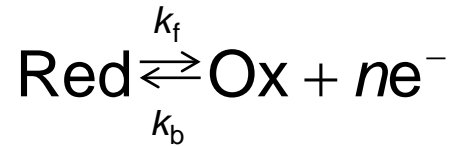

$$D_{\text{Ox}} \left. \frac{\partial C_{\text{Ox}}}{\partial Z} \right|_{z=d} = -D_{\text{Red}} \left. \frac{\partial C_{\text{Red}}}{\partial Z} \right|_{z=d}$$

$$D_{\text{Ox}} \left. \frac{\partial C_{\text{Ox}}}{\partial Z} \right|_{z=d} = k_f C_{\text{Red}}(r, z=d, t) - k_b C_{\text{Ox}}(r, z=d, t)$$

In dimensionless form, with mass-conservation,
for an irreversible reaction, $k_b = 0$

$$\left. \frac{\partial C}{\partial Z} \right|_{Z=L} = K(1-C) \quad \text{where } K = k_f a / D$$

$K =$

100

10

5.0

2.5

1.0

0.5

0.1

0.01

0

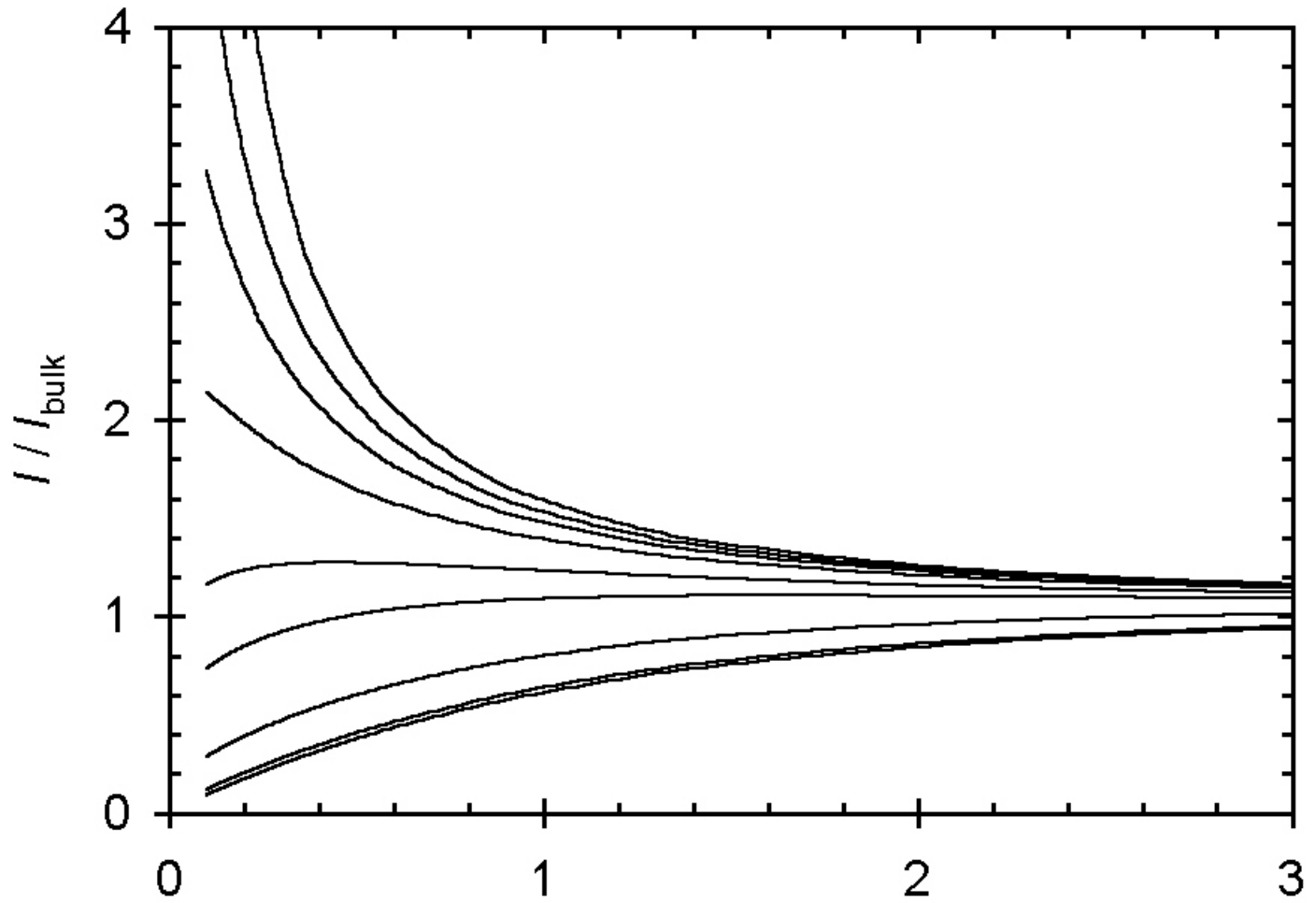

$L = d / a$

Scanning mode

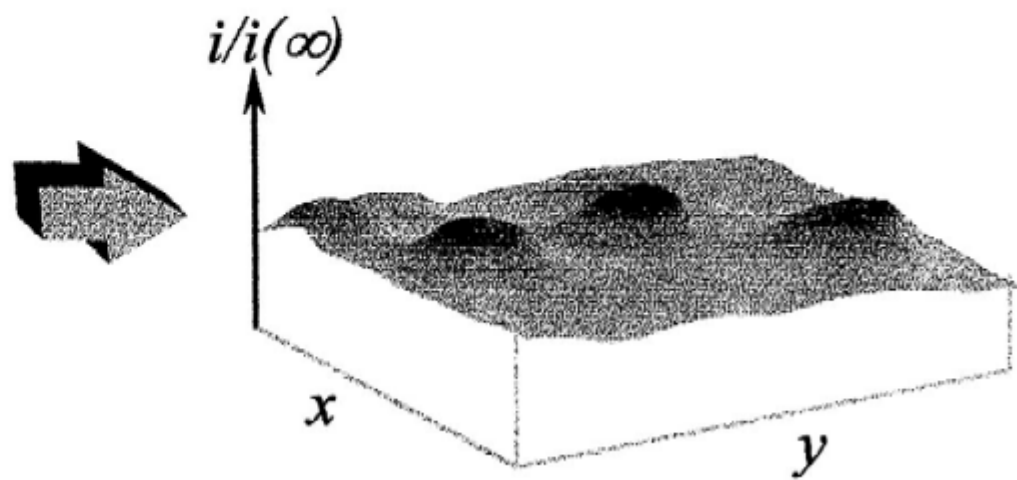
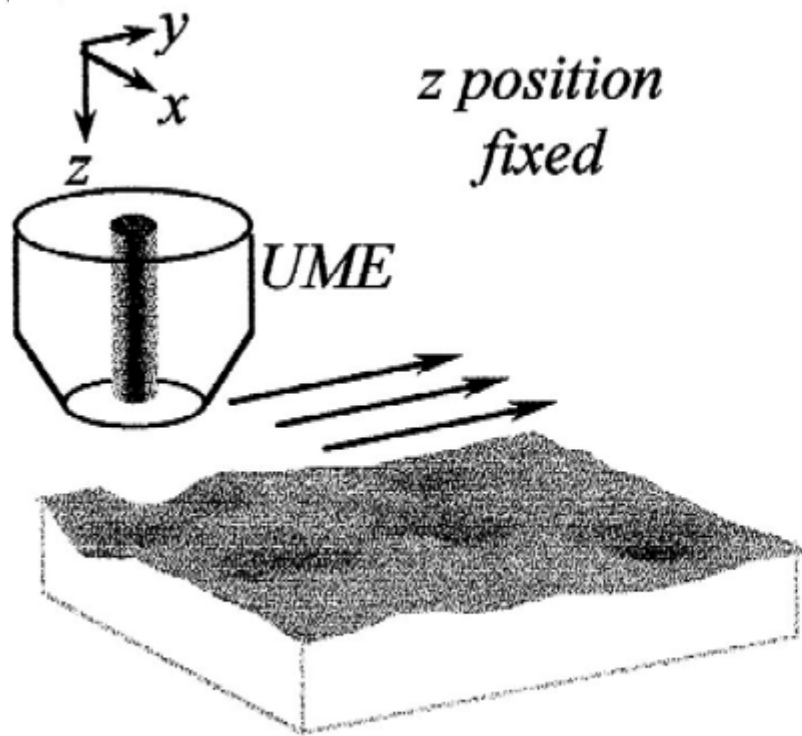

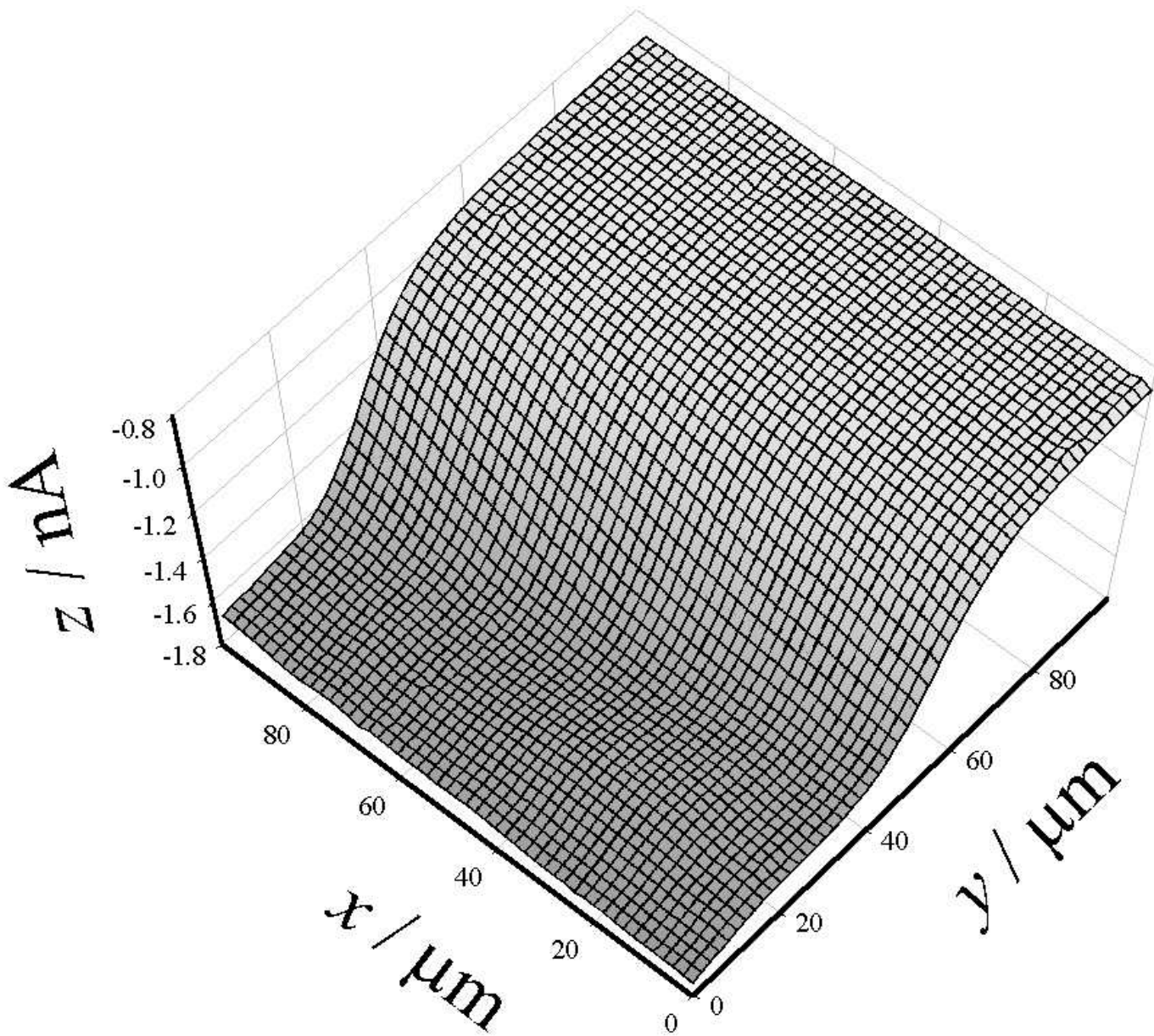

The scanning mode:

- Gives information on both the topography and the local reactivity of the substrate
- The resolution is of the order of the tip radius and dependent on the tip-sample distance
- atomic resolution not possible (SECM vs. STM)
- Two principal types: constant height and constant current
- Two principal modes: feedback and collection
- Variations exist: use of a chemical lens, modulation techniques, shear force detection etc.

Tip preparation

1. pull a glass capillary

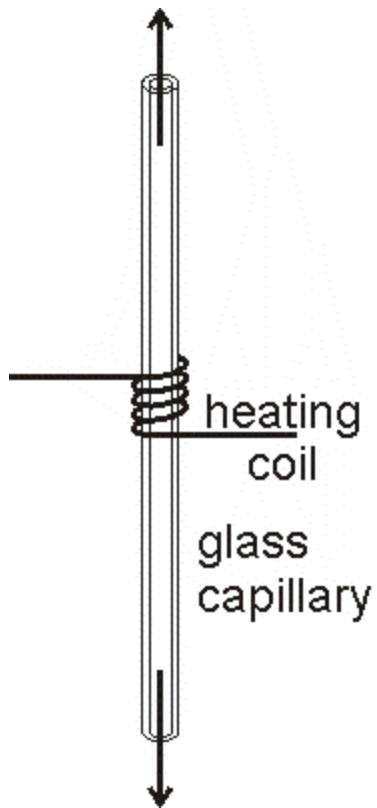

2. seal the end with a Bunsen burner

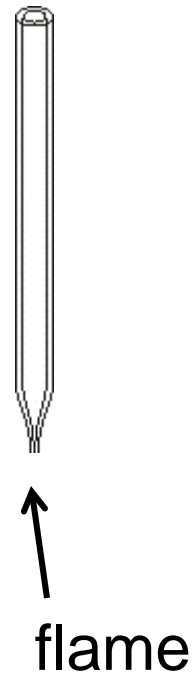

3. insert a metal wire of desired thickness into the end of the capillary

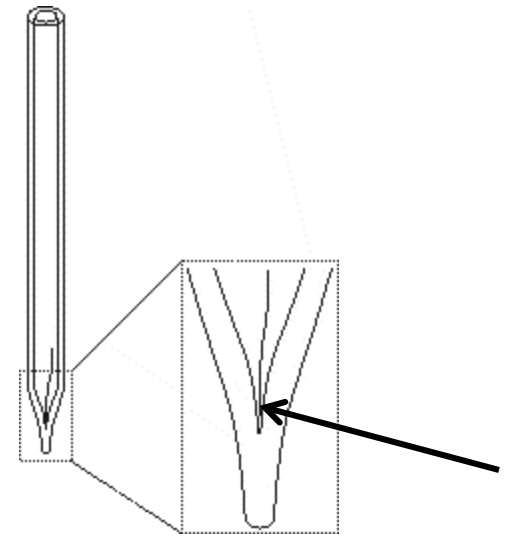

4. draw a vacuum in the capillary

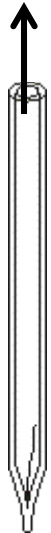

5. melt the glass around the metal wire

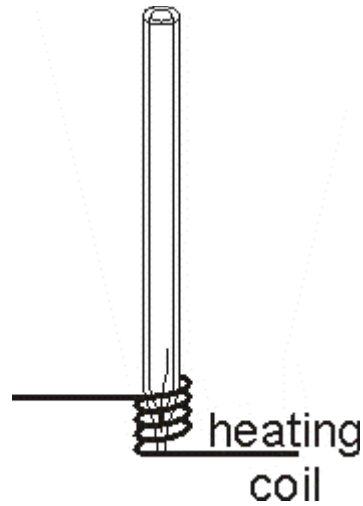

6. metal wire sealed inside the glass

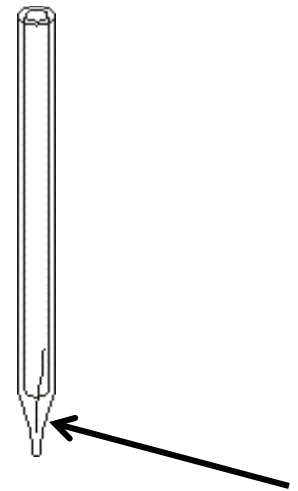

7. grind back to expose the electrode and polish with subsequently finer grinding paper or alumina slurry

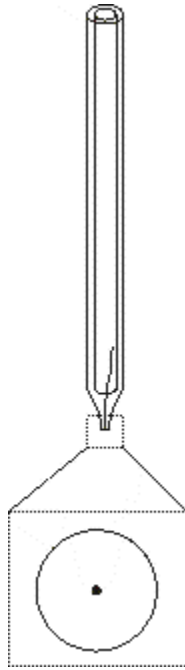

8. make electrical connection to the tip and run a test CV

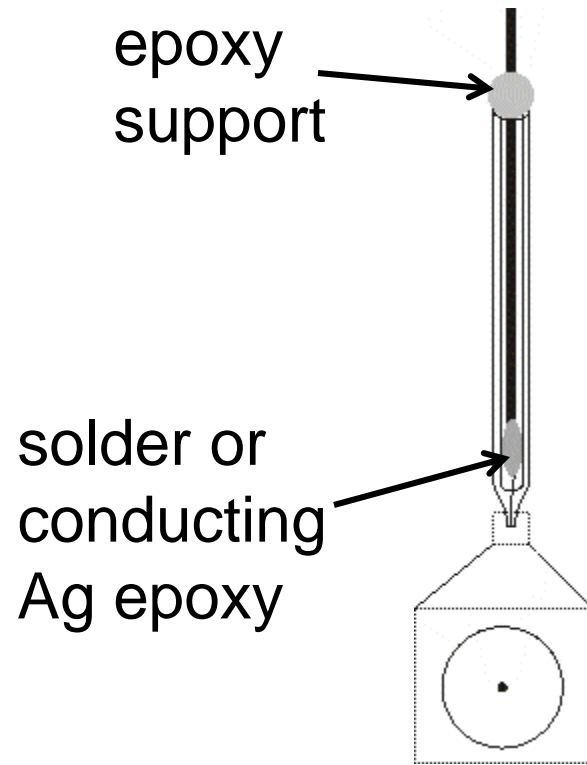

9. sharpen until the radius of the glass sheath is $< 10a$

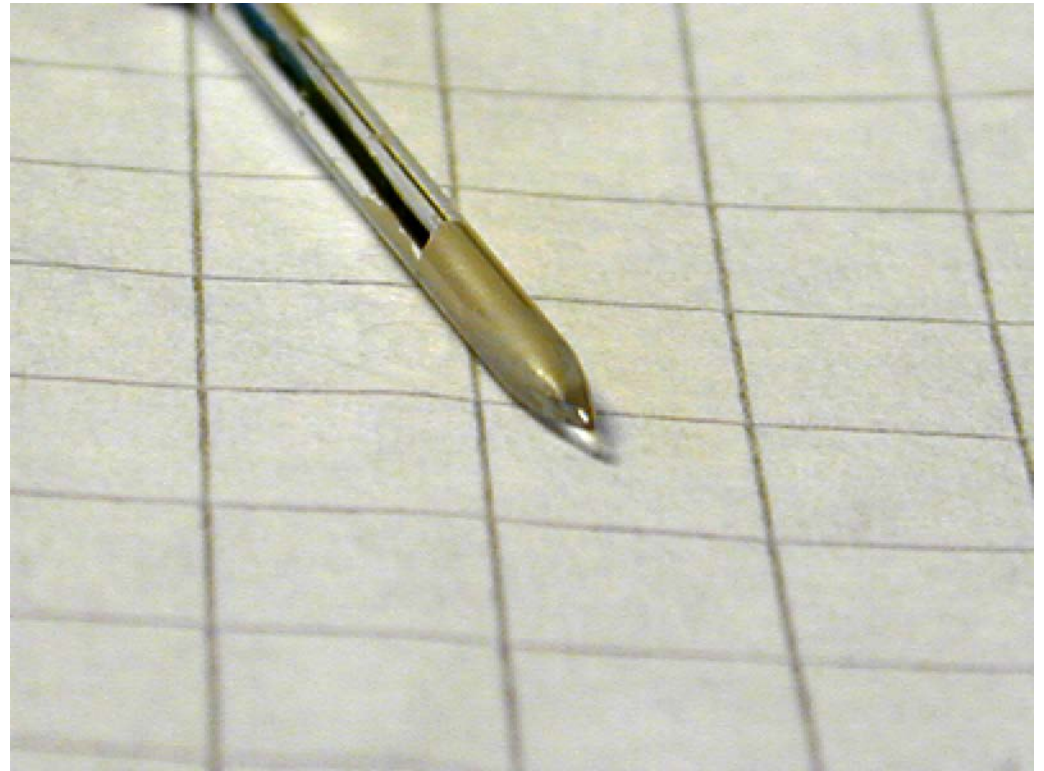

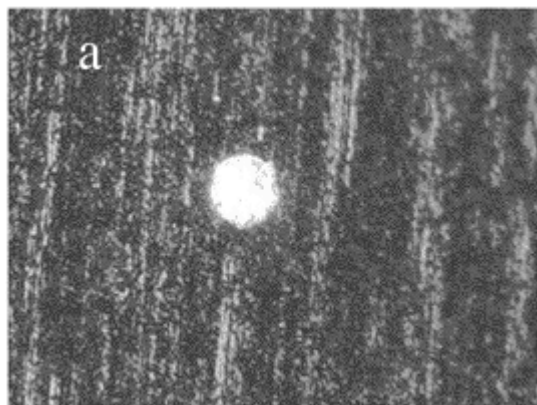

unpolished
microelectrode

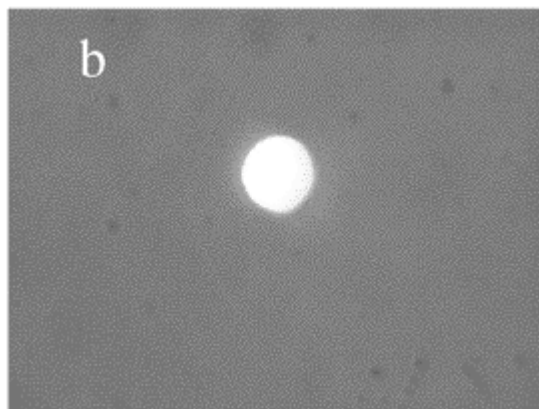

polished
microelectrode

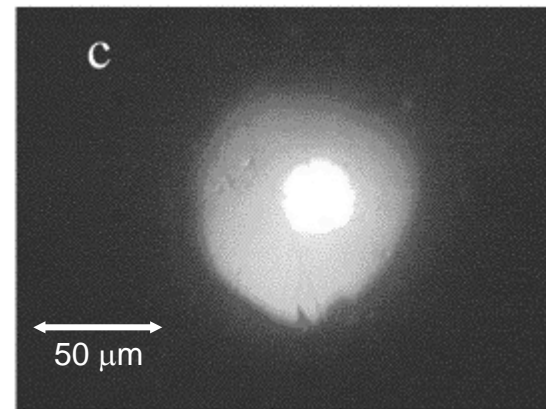

finished
SECM tip

Nanometre electrodes:

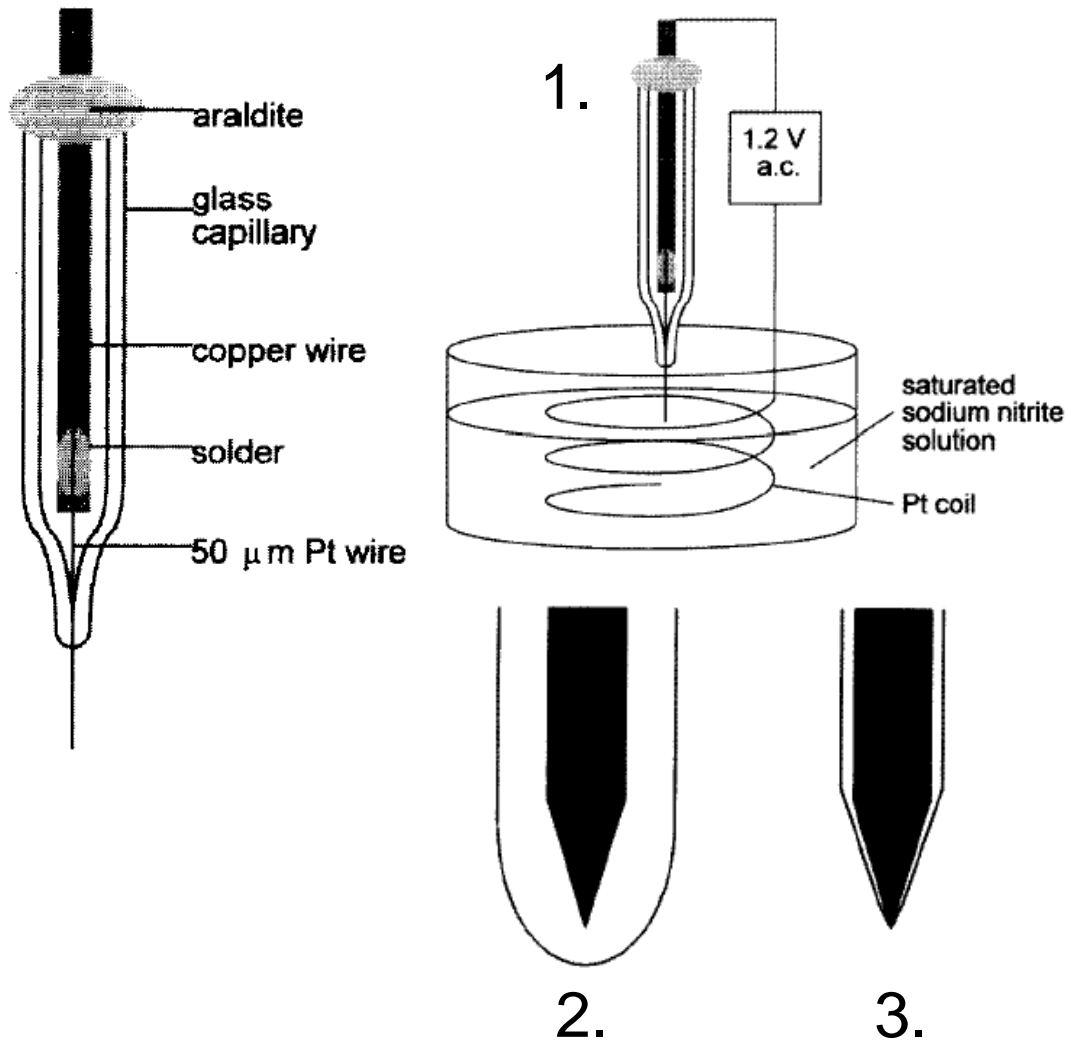

1. Electrochemical etching

2. Electrodeposition of cathodic or anodic electrophoretic paint

3. Thermal curing causes the paint to shrink, exposing a tiny conical electrode

Nanometre electrodes, part deux:

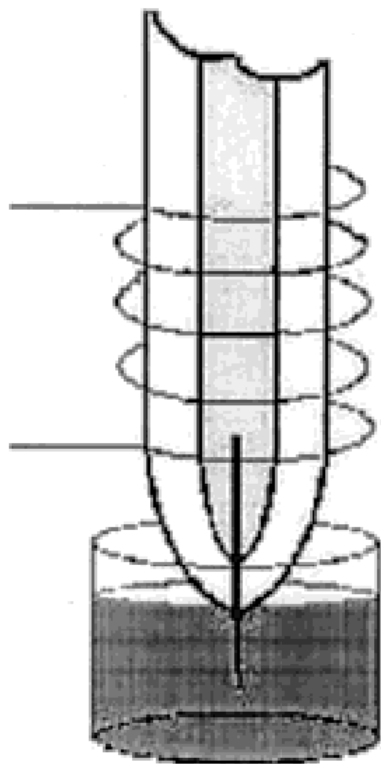

2.

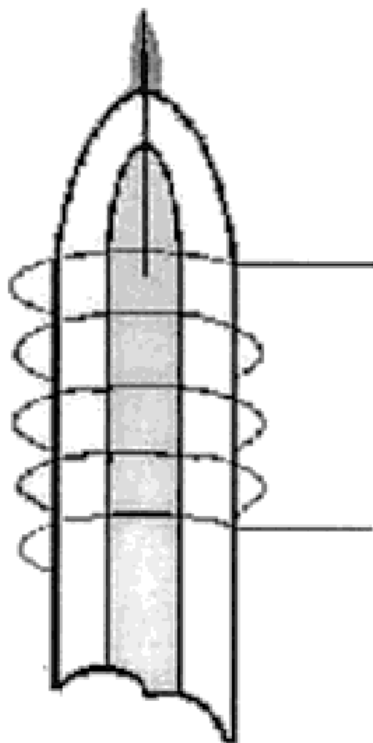

3.

1. Start as previously, electrochemically etch a Pt wire

2. Heat induced polymerisation of an imide

3. Thermal curing at ca. 200°C

Experimental aspects

Tip shape

- concentricity of the disk and the insulating glass sheath
→ effective R_g
- highest point on the tip
- alignment of the tip

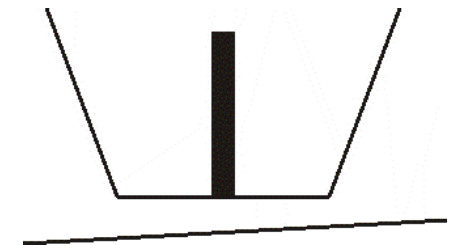
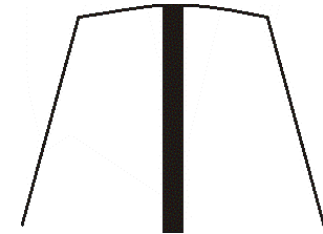
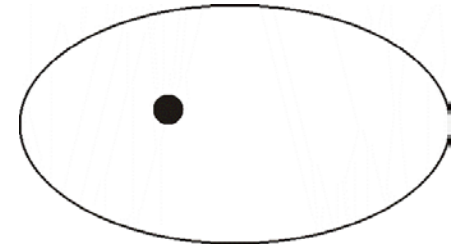

Effect of R_g

- Small R_g makes it easier to get close to the substrate

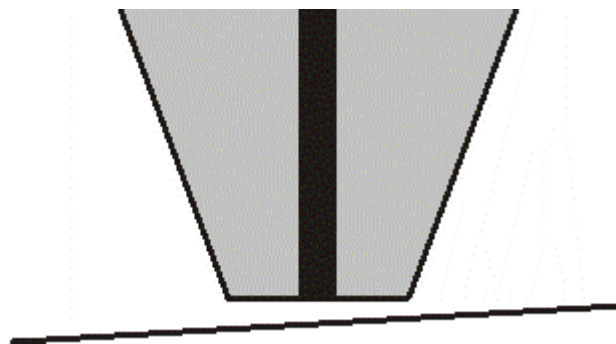
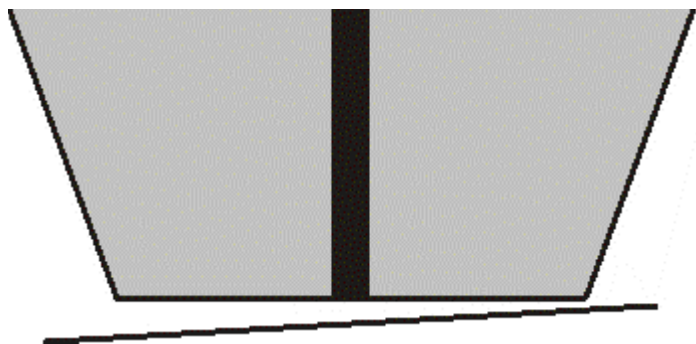

Various imperfections

- Perfect electrode (A), irregularly shaped electrode (B), a recessed electrode (D), a “lagooned” electrode (E) and a leaky UME (F)

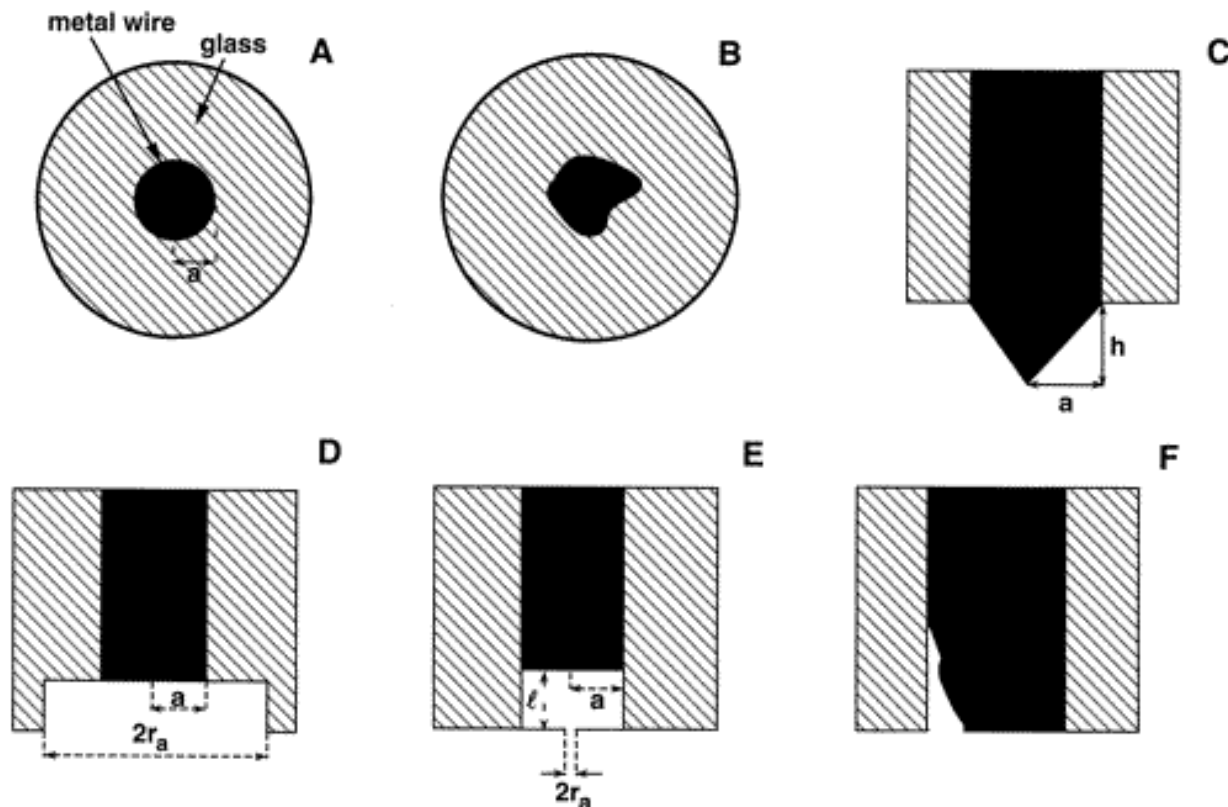

Effect of tip geometry

- Disk preferred, however, especially small electrodes usually have conical or hemi-spherical shape

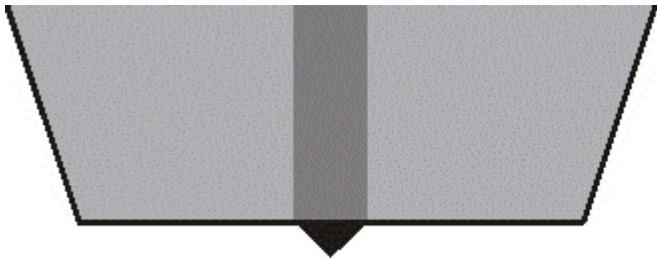

conical

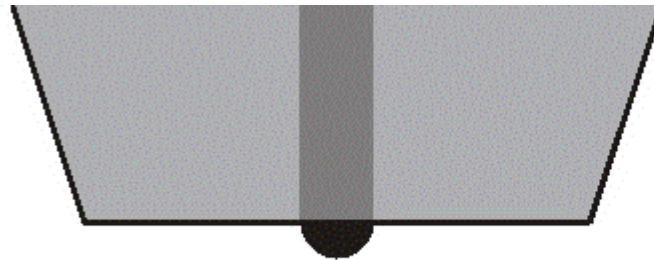

hemi-spherical

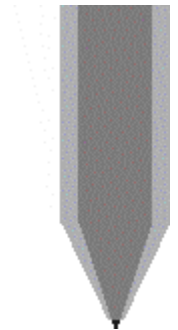

Effect of tip geometry on the approach curves

- Generally makes the response less sharp

