



Aalto University  
School of Chemical  
Engineering

# CHEM-E0115

# Planning and Execution of a Biorefinery Investment Project

*Automation, Electrical and ICT & Security Engineering*

*14.10.2021*

*Jussi-Mikko Paju / Petri Kankkunen*

# Automation engineering

# Electrical and Automation Engineering at AFRY

## AFRY's scope of services

- Pre-feasibility studies
- Pre-engineering studies
- Basic Engineering
- Detail Engineering
- FAT and SAT services
- Electrical and Automation Engineering Supervision
- Check-out, commissioning and start-up services
- EPCM Services
- EPC Services

## For

- New investments
- Production line relocations and rebuilds
- Control and Monitoring systems and DCS upgrades
- MCC and Power distribution system upgrades
- Small scale upgrade projects and services

# Stages of Projects

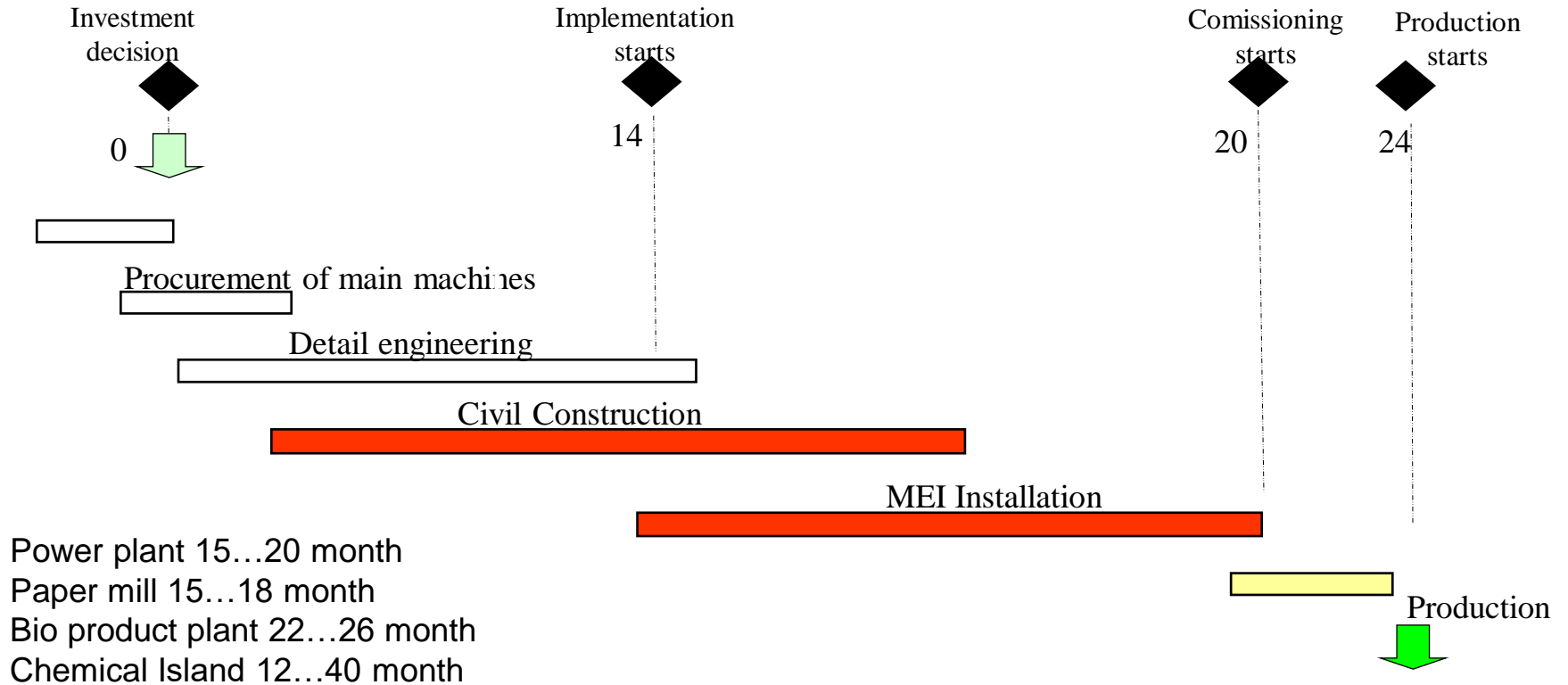

# Smart Site

- Industry needs

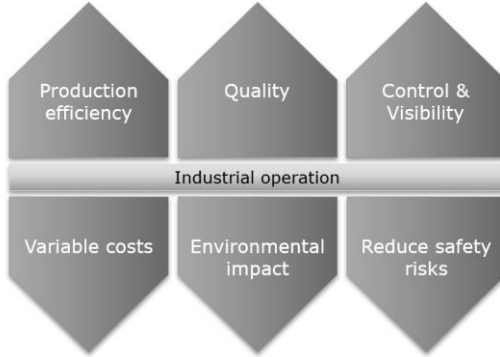

- Establishing 'Smart Data Platform' as the foundation for a digital enterprise

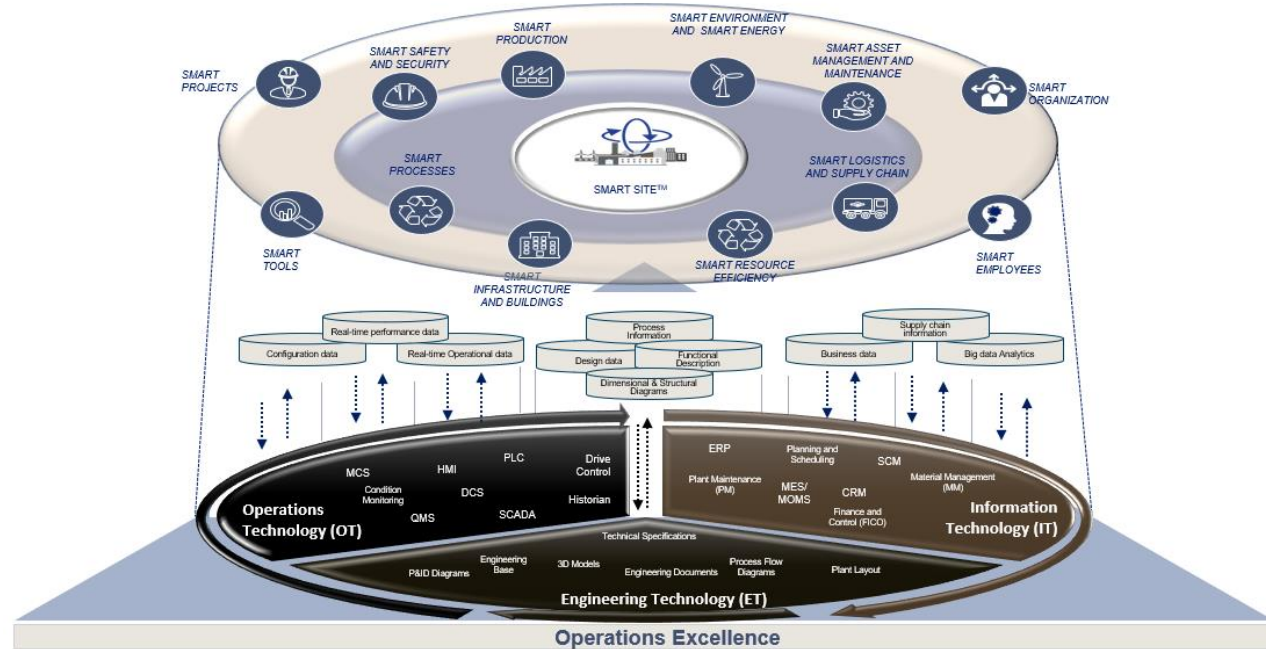

# Smart Site

- Model based approach for integrated engineering data management.
- Extends 'Master Data Management' with single source of truth across all disciplines.
- Consistently manages technical information throughout plant life cycle.
- Provides easy access for all stake holders using web-based user interface.
- Enables transparency and utilization of data guaranteeing better data quality.
- Provides access to real time data integrating with plant IT (MES, ERP) and control systems.

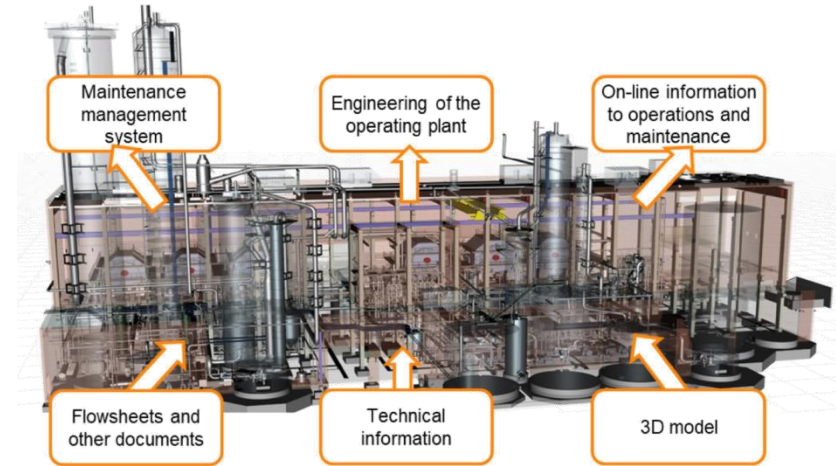

# Detail engineering documents in a paper mill project

Document	Department										Total	
	00	20	30	40	50	60	70	80	90			
I110	TECHNICAL REPORT	4		1	2	1	1					9
I140	ENQUIRY SPECIFICATION	24		1	4	2	6					37
I141	TENDER COMPARISON	23		1	1	1	3					29
I160	COMPONENT STANDARD	12										12
I170	UNIT PRICE LIST	23										23
I226	APPLICATION LIST	2	1	5	5	2	2		1	1		19
I242	SIZING OF INSTRUMENTS	1	2	22	17	9	29					80
I253	LOOP DIAGRAM	5	2	927	538	183	1124					2779
I262	FUNCTION DIAGRAM	0	1	928	527	182	988					2626
I291	DEVICE LIST	8	0	8	6	5	11					38
I294	PURCHASE SPECIFICATION	14	3	71	79	59	122					348
I321	CONTROL AND RACK ROOM LAYOUT			2			8					10
I322	PANEL, CABINET AND RACK LAYOUT			1	2	1	1					5
I324	HOOK-UP LIST	1										1
I325	CONTROL EQUIPMENT AND BOX LIST			2	2	1	2					7
I327	MASTER WIRING DIAGRAM	1										1
I424	TYPICAL INSTALLATION DRAWING	2	1	2	1		1					7
I440	LOCATION DRAWING			28	16	23	50				1	118
I442	WIRING DIAGRAM	7	1	242	133	85	319					787
I444	CABLE LIST	0	1	5	5	5	5					21
I451	NAME PLATE LIST		1	16	21	9	22					69
<b>Total:</b>		<b>127</b>	<b>13</b>	<b>2262</b>	<b>1359</b>	<b>568</b>	<b>2694</b>	<b>1</b>	<b>1</b>	<b>1</b>		<b>7026</b>

# Pre-engineering



# Pre-engineering

**Conceptual study**

**Pre-study**

**Pre-engineering**

**Basic engineering**

**Pre-feasibility study**

**Feasibility study**

**Extended feasibility study**

**Main study**

**Front end engineering**

# Pre-engineering

## **The basic solutions for mill automation**

- automation and ICT design criteria
- systems : DCS, QCS, WIS, other systems
- level of the automation : field devices
- the basic solutions for implementation : cabling techniques

## **Size and locations of automation and control rooms (space reservations)**

## **Calculation of investment for automation**

## **In some cases also part of the basic engineering is done during the pre-engineering**

- Instructions and standards for procurement and engineering

# ISA 95 Functional Hierarchy of Activities

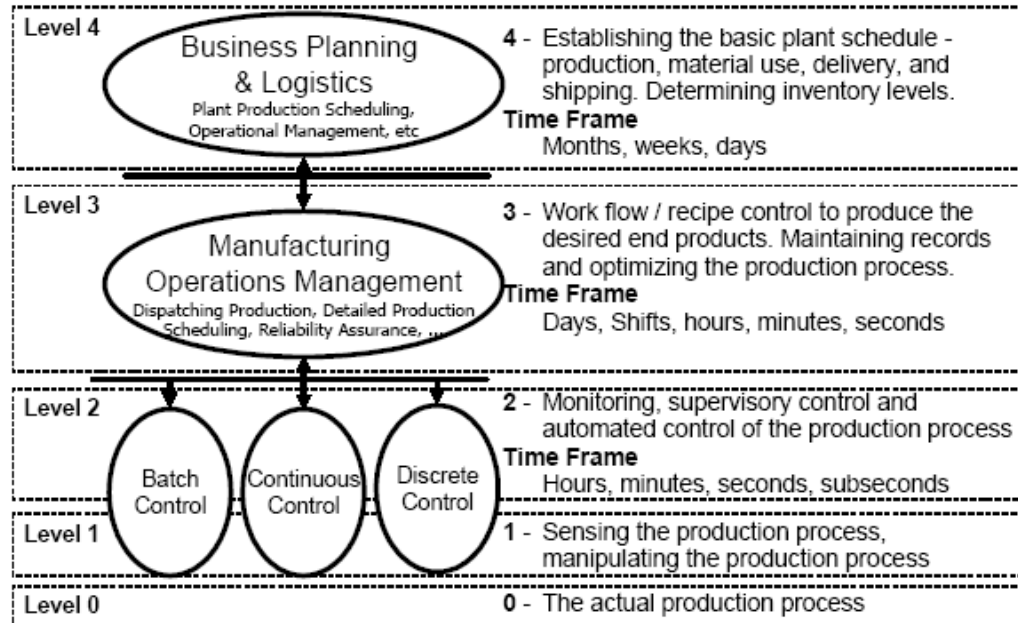

Figure 2 - Multi-level functional hierarchy of activities

# The Basic Solutions for Mill Automation

## Level 4: Business Planning and Logistics

- Applications for Sales and Distribution
- Applications for Materials Management and Purchasing
- Applications for Maintenance
- Applications for Financial Management
- Applications for Human Resources Management and Payroll
- Applications for Information Management, Data Warehousing
- Applications for Collaboration

## Level 3: Manufacturing Operations Management

- Production Management (PPMS)
- Process Information Management (PIMS)
- Dynamic Asset Management (AMS)
- Document Management

# The Basic Solutions for Mill Automation

## Level 2: Monitoring, Supervisory and Automated Control

- Distributed Control System (DCS)
- Machine Control Systems (MCS)
- Supervisory Quality Controls
  - *Quality Control System (QCS), Web Inspection System (WIS), Web Monitoring System (WMS), Machine Monitoring System (MMS),...*
- Product Management, Warehouse and Logistics Systems
- Physical Access Control System (PACS)

## Level 1: Sensing and Manipulating the Production Processes

- Sensors and Transmitters
- Final Control Elements, Remote-operated Control and On-off Valves
- Discrete Switches
- Analyzers

# Automation and Control Rooms

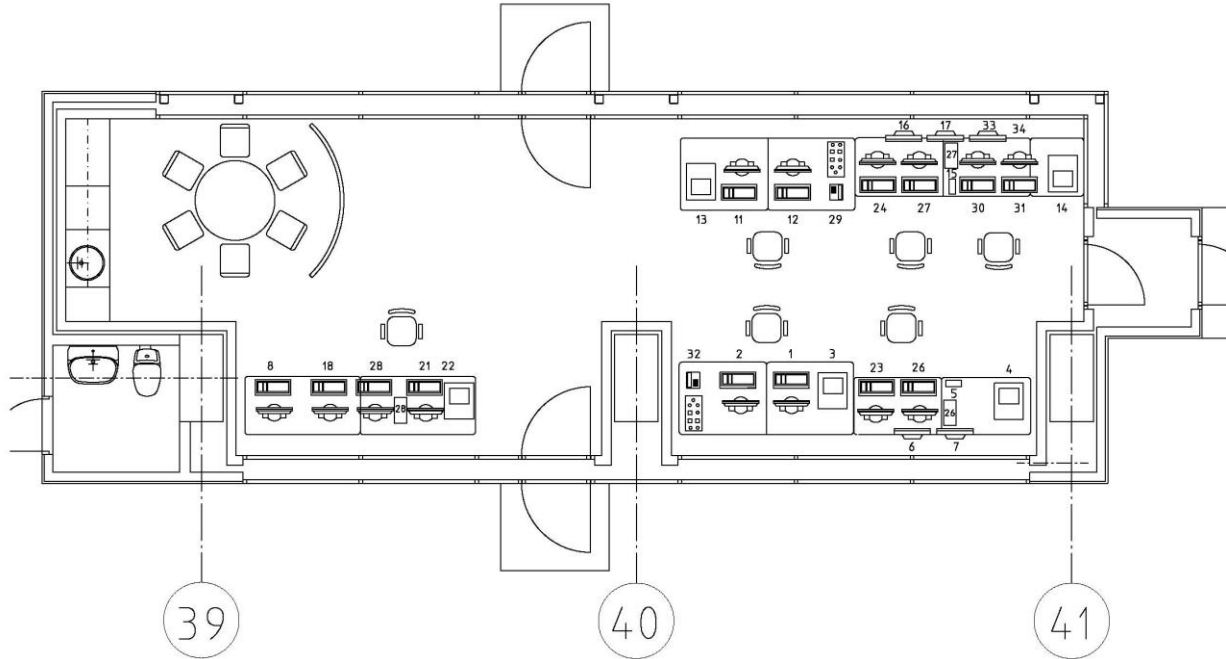

# Calculation of Investment for Automation

**If the cost estimate accuracy is requested to be less than  $\pm 5\%$ , some enquiries shall be prepared;**

- DCS (Distributed Control System)
- QCS (Quality Control System)
- PIMS (Process Information Management System)
- PPMS (Paper Production Management System)
- ICT (Information and Communication Technology)

**Calculation is based on loop and circuit amounts and AFRY cost files**

- Standard instruments
- DCS
- Installation

**Special instruments are listed and priced separately**

# Calculation of Investment for Automation

4ePCM  
Sample Project

230 000 tpa

31 Paper mill - 1000 Eur -

Account No	Pos. Nr.	Quantity	Specification	Unit price	Total	Freight	Erection	TOTAL
AREA SUMMARY								
31			Automation, MIS		7 148	0	1 125	8 273
31			Automation					
	1		Field instruments and installation		1 688	0	1 125	2 813
		750	No of instrument loop	pcs				
			- Field instruments					
			- Control and on/off valves					
			- installation					
	2		Distributed control system (included software)		1 360	0	0	1 360
		1 300	No of instrument loop	pcs				
		400	No of motor controls	pcs				
	3		Special instruments		300	0	0	300
			- retention and consistency measurements					
	4		OMS		1 100	0	0	1 100
			- two measuring frames					
			- basis weight, moisture, caliper, porosity					
			- Drive controls					
			- PIMS					
	5		OCS		incl. In PM	0	0	incl. In PM
			- CD controls and actuators					
	6		Web break monitoring system		300	0	0	300
	7		Edge Cracking Monitoring		100	0	0	100
	8		Machine Control System		incl. In PM		0	incl. In PM
	9.1		Machine monitoring		incl. In PM			incl. In PM
	9.2		Lubrication monitoring		incl. In PM			incl. In PM
	10		Networks		800			800
								0
	11		Production Management System		1 500			1 500
31	-6		Automation	Total	7 148	0	1 125	8 273



# Calculation of Investment for Automation

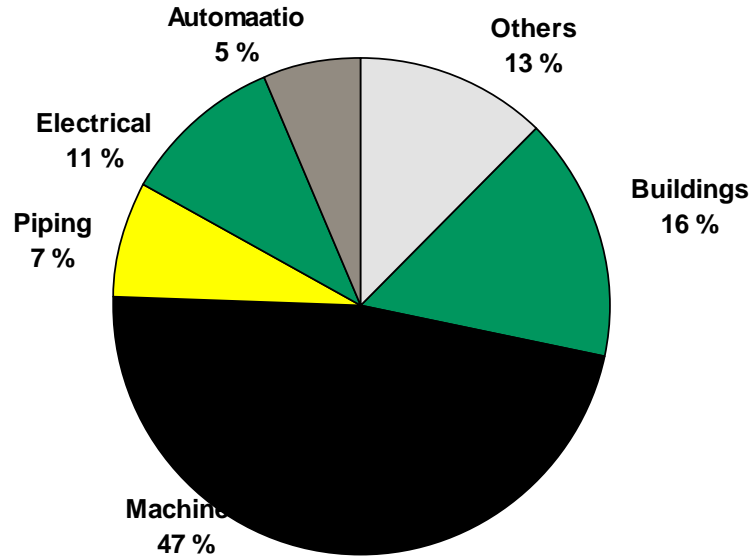

5% 850 MEUR = 42 MEUR

# Basic engineering

# Basic Engineering

## General Automation Engineering

- Co-ordination
- Engineering Instructions and Standards
- Procurement Services

## Safety of Automation

- Hazard and Risk Analysis
- Safety Requirements Allocation
- Overall Safety Requirements

## Process Control System Design (DCS)

- General Process Control System Engineering
- Control and System Room Design

## Field Equipment Design

- Measurement and control methods
- Process data acquisition
- Equipment selection
- Process connection design

# Co-ordination

**Checking and approving of the design, drawings and documents to ensure compliance with the set project standards and criteria**

## **Communication with other disciplines**

- Project management
- Process engineering
- Mechanical and piping engineering
- Civil engineering
- HVAC engineering
- Electrical engineering
- ICT engineering (under automation engineering management)

# Engineering Instructions and Standards

- Automation and instrumentation in machine deliveries**
- Auxiliary equipment for automation and instrumentation**
- Automation and instrumentation design criteria**
- Numbering procedure for automation and instrumentation**
- Cable standard**
- General instruction for automation and instrumentation symbols and identification**
- Marking and name plates for automation and instrumentation**
- Function blocks for functional diagrams**
- Automation and instrumentation commissioning instructions**

# Automation and instrumentation in machine deliveries

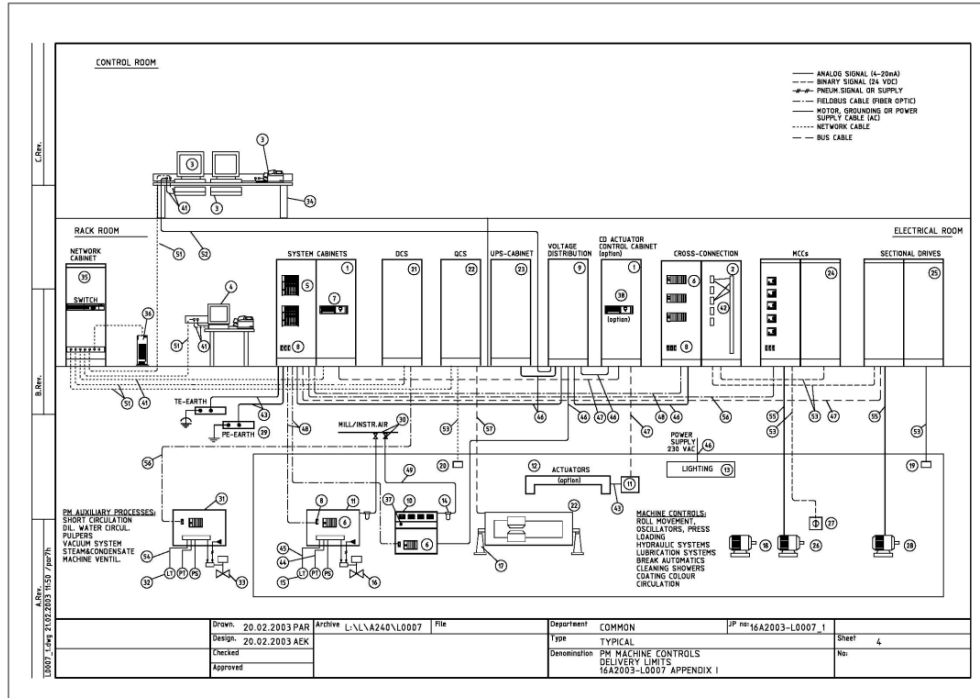

# Automation and instrumentation design criteria

## BF: FLOW MEASUREMENTS AND SWITCHES

### 1 PURPOSE OR TASK OF OBJECT

IEC 61346-2 designation B: Converting an input variable (physical property, condition or event) into a signal for further processing.

IEC 61346-2 designation P: Presenting information.

Subclass F: Flow

### 2 GENERAL

Transmitters shall be used instead of flow switches where possible to enhance the monitoring of functionality of measurement.

### 3 FLOW MEASUREMENTS AND SWITCHES

#### 3.1 Condensate and Steam

Normally by corner taps (BF.E or BF.F) or ring chamber (BF.G) type orifice plates and differential pressure transmitter (BP.F).

The flow nozzle (BF.M) and differential pressure transmitter (BP.F) will be used for high pressure steam.

If sufficient straight lengths of pipe cannot be achieved, V-Cone flow meter (BF.U) and differential pressure transmitter (BP.F) shall be used.

If the remaining pressure loss must be kept small or enough straight lengths of pipe are not available, measurement shall be carried out by venturi tube (BF.V) and differential pressure transmitter (BP.F).

Annubar type flow meter (BF.P) and differential pressure transmitter (BP.F) could be used in some special cases.

Vortex effect flow meters (BF.K) can be used with small diameter pipes.

## 4 INSTRUMENTS

### 4.1 General

All field devices (transmitters, remote controlled valves, analyzers, etc.) shall support EDD (Electronic Device Description) asset management standard.

Field devices, such as limits switches, photocells and similar equipment, shall be installed so that their maintenance and adjustment can be carried out while the equipment is in operation. The devices shall be dust and waterproof, and so constructed and installed that vibration, temperature and dust in the equipment does not damage the devices, or cause disturbances in their function.

Limit switches and corresponding instruments, which are under heavy usage, shall be easily replaceable, being for example plug connected.

Contacts of the 24 VDC field devices shall be gold plated.

Transmitters and positioners shall preferably be using Profibus PA digital communication.

If equipment with Profibus communication is not available, devices with analog 4-20 mA DC signals can be used. 2-wire system is preferred.

The use of 0-20 mA signal will only be allowed in special circumstances.

Transmitters shall not include any signal processing if the calculations can be carried out in the automation system.

Transmitters shall allow measurement of the mA signal while in continuous operation.

The 4-20 mA analog signals connected to the automation system shall be galvanically isolated by the Supplier. This applies both to the input and output signals.

Non-fieldbus based transmitters and positioners shall be HART compatible.

### 4.2 Magnetic flow meters (BF.B)

Used for: water, effluent, stock, white water and various chemicals.

The magnetic flow meter flow tubes are normally lined with Teflon or Ceramic and the electrodes are normally of Hastelloy C material. Other materials can be used for special cases.

If there is a control valve in the same line with the flow meter, the magnetic flow meter size is preferably selected according to the control valve. For water applications the magnetic flow meter flow tube shall be normally sized for full scale range speed 0.5 - 5 m/s. For other liquids the magnetic flow meter flow tube shall be normally sized for full scale range speed 0.5 - 3 m/s.

Magnetic flow meters shall be used always when it is possible (conductivity > 5  $\mu\text{S/cm}$  and temperature < 180 °C).

# Automation and instrumentation design criteria

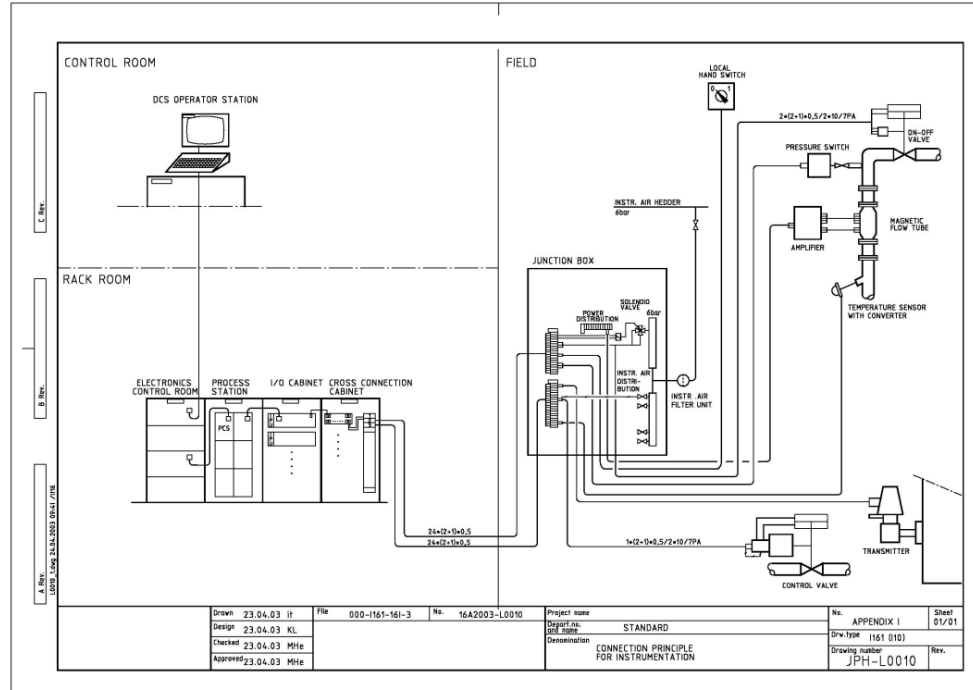



# Automation and instrumentation design criteria

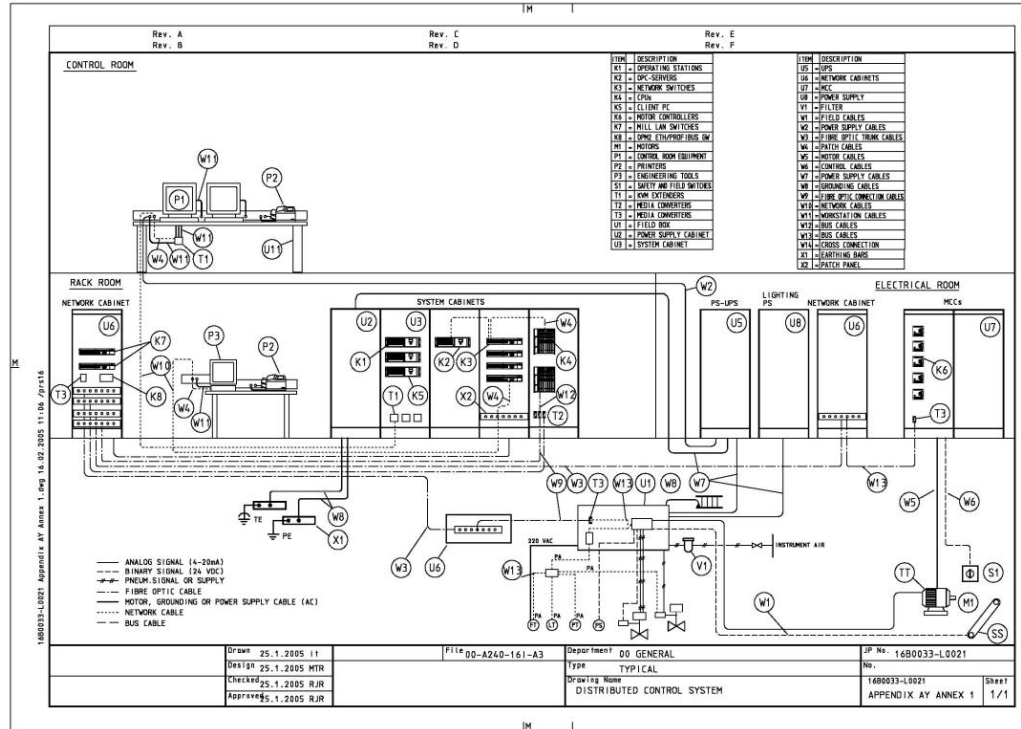

# Procurement Services

**Technical enquiry specifications**

**Participation in technical and commercial tender negotiations**

- Minutes of meetings

**Tender evaluation and comparisons**

**Equipment and material specifications for purchase requisitions and orders**

# Technical enquiry specifications

**DCS (U)**

**ICT infrastructure (U)**

**Control and on-off valves (U)**

**HP control valves**

**Magnetic flowmeters (U)**

**Nozzles and orifice Plates**

**Vortex flowmeters (U)**

**Mass flowmeters**

**Consistency transmitters and pulp sampling valves (U)**

**Pressure, dP and level transmitters (U)**

**Temperature sensors and transmitters (U)**

**Refractometers**

**Radiometric density measurements**

**Radiometric level measurements**

**pH transmitters (U)**

**Conductivity transmitters (U)**

**Pyrometers and lime kiln scanner**

**Special level measurements**

**Smelt bed cameras**

- Flue gas analysers (SO<sub>2</sub>, NO<sub>x</sub>, CO, CO<sub>2</sub>, HCl, HF, CH<sub>4</sub>, C<sub>2</sub>H<sub>4</sub>, C<sub>3</sub>H<sub>3</sub>, O<sub>2</sub>, Dust, Temperature, Flow)
- Flue gas O<sub>2</sub> analysers
- Cooking and washing liquor analysers
- Kappa, brightness and residual chemicals analysers
- Boiler water analysers (SiO<sub>2</sub>, pH, Conductivity, O<sub>2</sub>)
- Pulp sheet dirt count analysers
- Pulp quality analysers
- Ultrasonic flowmeters
- Viscosimeter
- Weighbridges
- Gas detectors
- CCTV system (U)
- Junction boxes (U)
- Network cabling and installation (U)
- Instrument installation (U)
  - U=Unit price based frame contract

# Safety of Automation

## Hazard and Risk Analysis

- Hazard and risk reports

## Safety Requirements Allocation

- Hazard and risk reports with the safety integrity levels (SIL)

## Overall Safety Requirements

- Specification for the overall Safety requirements (Specification of SIL functions)

# Process Control System Design (DCS)

## General Process Control System Engineering

- Allocation of I/O's for loops
  - *I/O list (amounts)*

## Control and System Room Design

- Specification for control and system room requirements for layout design
- Control and system room layouts
- Requirements and specification of floor and ceiling openings
- Requirements and specification of control and system room HVAC
- Cable tray arrangement drawings in control and system rooms

# Control and System Room Design

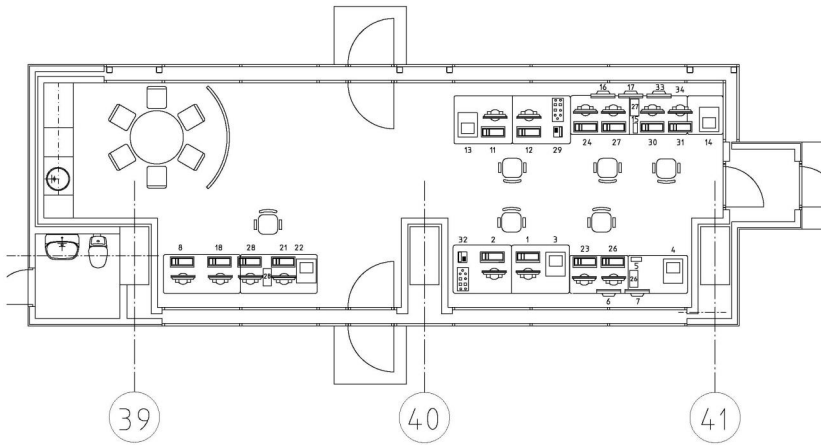

No.	EQUIPMENT	SUPPLIER	PDS.NO	NOTE
1	WINDER 1 OPERATOR STATION	WIN	541EB11-2002	
2	WINDER 1 OPERATOR STATION	WIN	541EB21-2002	
3	WINDER 1 PRINTER	WIN	541ES15-2002	
4	TAG PRINTER			
5	WINDER 1 CCTV CONTROL UNIT			
6	WINDER 1 CCTV MONITOR			
7	WINDER 1 CCTV MONITOR			
8	WINDER 1 DRIVE SERVICE WORKSTATION	ABB3	541ES11	
9				
10				
11	WINDER 2 OPERATOR STATION	WIN	541EB11-3002	
12	WINDER 2 OPERATOR STATION	WIN	541EB21-3002	
13	WINDER 2 PRINTER	WIN	541ES15-3002	
14	TAG PRINTER			
15	WINDER 2 CCTV CONTROL UNIT			
16	WINDER 2 CCTV MONITOR			
17	WINDER 2 CCTV MONITOR			
18	WINDER 2 DRIVE SERVICE WORKSTATION	ABB3	541ES12	
19				
20				
21	DCS OPERATOR STATION	ABB	531OS03	
22	DCS PRINTER	ABB	531PRT03	
23	WIS OPERATOR STATION	PAR	PAR-OS2	
24	WIS OPERATOR STATION	PAR	PAR-OS3	
25				
26	MES PC			
27	MES PC			
28	OFFICE PC			
29	TELEPHONE			
30	ROLL CONTROL PC	RDH		
31	INTERMEDIATE STORAGE OPERATOR STATION	KCI		
32	TELEPHONE			
33	INTERMEDIATE STORAGE CCTV MONITOR			
34	CCTV CONTROL UNIT			

# Control and System Room Design

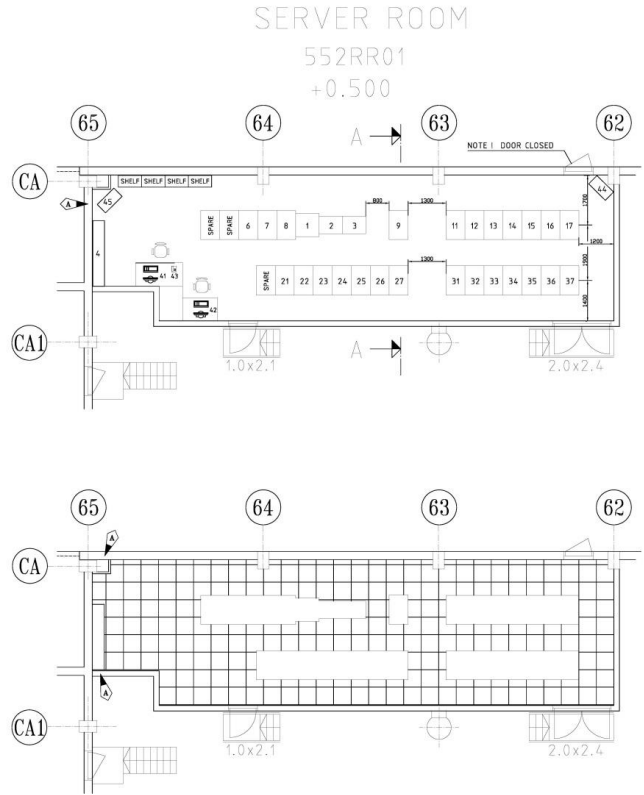

FURNITURE

- TABLE 1200x800 2 PCS
- TABLE 1600x800 1 PCS
- CHAIR 2 PCS
- SHelf 800x400x2000 4 PCS

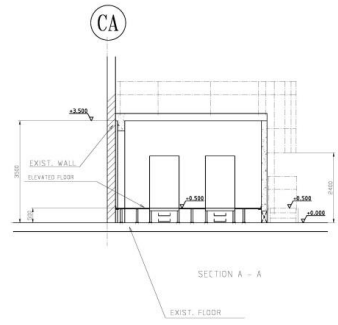

FALSE FLOOR CONSTRUCTION

- PLATES : 600x600mm
- HEIGHT : 500mm
- LOAD : 100N/m<sup>2</sup>
- AREA : 67m<sup>2</sup>

NO.	EQUIPMENT	SUPPLIER	POS. No	NOTE
1	RAI POWER CABINET	SAIT	1100/120	
2	NETWORK CABINET	SAIT	1100/120	
3	RAI POWER CABINET	SAIT	1100/120	
4	UPS VOLTAGE DISTRIBUTION PANEL	SAIT	1100/120	
5	UPS BATTERY	SAIT	1100/120	
6	UPS BATTERY	SAIT	1100/120	
7	UPS BATTERY	SAIT	1100/120	
8	UPS BATTERY	SAIT	1100/120	
9	UPS BATTERY	SAIT	1100/120	
10	UPS BATTERY	SAIT	1100/120	
11	UPS BATTERY	SAIT	1100/120	
12	UPS BATTERY	SAIT	1100/120	
13	UPS BATTERY	SAIT	1100/120	
14	UPS BATTERY	SAIT	1100/120	
15	UPS BATTERY	SAIT	1100/120	
16	UPS BATTERY	SAIT	1100/120	
17	UPS BATTERY	SAIT	1100/120	
18	UPS BATTERY	SAIT	1100/120	
19	UPS BATTERY	SAIT	1100/120	
20	UPS BATTERY	SAIT	1100/120	
21	UPS BATTERY	SAIT	1100/120	
22	UPS BATTERY	SAIT	1100/120	
23	UPS BATTERY	SAIT	1100/120	
24	UPS BATTERY	SAIT	1100/120	
25	UPS BATTERY	SAIT	1100/120	
26	UPS BATTERY	SAIT	1100/120	
27	UPS BATTERY	SAIT	1100/120	
28	UPS BATTERY	SAIT	1100/120	
29	UPS BATTERY	SAIT	1100/120	
30	UPS BATTERY	SAIT	1100/120	
31	UPS BATTERY	SAIT	1100/120	
32	UPS BATTERY	SAIT	1100/120	
33	UPS BATTERY	SAIT	1100/120	
34	UPS BATTERY	SAIT	1100/120	
35	UPS BATTERY	SAIT	1100/120	
36	UPS BATTERY	SAIT	1100/120	
37	UPS BATTERY	SAIT	1100/120	
38	UPS BATTERY	SAIT	1100/120	
39	UPS BATTERY	SAIT	1100/120	
40	UPS BATTERY	SAIT	1100/120	
41	SERVER MANAGEMENT TERMINAL	SAIT	1100/120	
42	SERVER MANAGEMENT TERMINAL	SAIT	1100/120	
43	SERVER MANAGEMENT TERMINAL	SAIT	1100/120	
44	SERVER MANAGEMENT TERMINAL	SAIT	1100/120	
45	SERVER MANAGEMENT TERMINAL	SAIT	1100/120	
46	SERVER MANAGEMENT TERMINAL	SAIT	1100/120	
47	SERVER MANAGEMENT TERMINAL	SAIT	1100/120	
48	SERVER MANAGEMENT TERMINAL	SAIT	1100/120	
49	SERVER MANAGEMENT TERMINAL	SAIT	1100/120	
50	SERVER MANAGEMENT TERMINAL	SAIT	1100/120	
51	SERVER MANAGEMENT TERMINAL	SAIT	1100/120	
52	SERVER MANAGEMENT TERMINAL	SAIT	1100/120	
53	SERVER MANAGEMENT TERMINAL	SAIT	1100/120	
54	SERVER MANAGEMENT TERMINAL	SAIT	1100/120	
55	SERVER MANAGEMENT TERMINAL	SAIT	1100/120	
56	SERVER MANAGEMENT TERMINAL	SAIT	1100/120	
57	SERVER MANAGEMENT TERMINAL	SAIT	1100/120	
58	SERVER MANAGEMENT TERMINAL	SAIT	1100/120	
59	SERVER MANAGEMENT TERMINAL	SAIT	1100/120	
60	SERVER MANAGEMENT TERMINAL	SAIT	1100/120	
61	SERVER MANAGEMENT TERMINAL	SAIT	1100/120	
62	SERVER MANAGEMENT TERMINAL	SAIT	1100/120	
63	SERVER MANAGEMENT TERMINAL	SAIT	1100/120	
64	SERVER MANAGEMENT TERMINAL	SAIT	1100/120	
65	SERVER MANAGEMENT TERMINAL	SAIT	1100/120	
66	SERVER MANAGEMENT TERMINAL	SAIT	1100/120	
67	SERVER MANAGEMENT TERMINAL	SAIT	1100/120	
68	SERVER MANAGEMENT TERMINAL	SAIT	1100/120	
69	SERVER MANAGEMENT TERMINAL	SAIT	1100/120	
70	SERVER MANAGEMENT TERMINAL	SAIT	1100/120	
71	SERVER MANAGEMENT TERMINAL	SAIT	1100/120	
72	SERVER MANAGEMENT TERMINAL	SAIT	1100/120	
73	SERVER MANAGEMENT TERMINAL	SAIT	1100/120	
74	SERVER MANAGEMENT TERMINAL	SAIT	1100/120	
75	SERVER MANAGEMENT TERMINAL	SAIT	1100/120	
76	SERVER MANAGEMENT TERMINAL	SAIT	1100/120	
77	SERVER MANAGEMENT TERMINAL	SAIT	1100/120	
78	SERVER MANAGEMENT TERMINAL	SAIT	1100/120	
79	SERVER MANAGEMENT TERMINAL	SAIT	1100/120	
80	SERVER MANAGEMENT TERMINAL	SAIT	1100/120	
81	SERVER MANAGEMENT TERMINAL	SAIT	1100/120	
82	SERVER MANAGEMENT TERMINAL	SAIT	1100/120	
83	SERVER MANAGEMENT TERMINAL	SAIT	1100/120	
84	SERVER MANAGEMENT TERMINAL	SAIT	1100/120	
85	SERVER MANAGEMENT TERMINAL	SAIT	1100/120	
86	SERVER MANAGEMENT TERMINAL	SAIT	1100/120	
87	SERVER MANAGEMENT TERMINAL	SAIT	1100/120	
88	SERVER MANAGEMENT TERMINAL	SAIT	1100/120	
89	SERVER MANAGEMENT TERMINAL	SAIT	1100/120	
90	SERVER MANAGEMENT TERMINAL	SAIT	1100/120	
91	SERVER MANAGEMENT TERMINAL	SAIT	1100/120	
92	SERVER MANAGEMENT TERMINAL	SAIT	1100/120	
93	SERVER MANAGEMENT TERMINAL	SAIT	1100/120	
94	SERVER MANAGEMENT TERMINAL	SAIT	1100/120	
95	SERVER MANAGEMENT TERMINAL	SAIT	1100/120	
96	SERVER MANAGEMENT TERMINAL	SAIT	1100/120	
97	SERVER MANAGEMENT TERMINAL	SAIT	1100/120	
98	SERVER MANAGEMENT TERMINAL	SAIT	1100/120	
99	SERVER MANAGEMENT TERMINAL	SAIT	1100/120	
100	SERVER MANAGEMENT TERMINAL	SAIT	1100/120	

# Field Equipment Design

## Measurement and control methods

- Instrumentation of process flow diagrams
  - *PI-diagrams*
- Requirements and specification for field equipment
  - *Selection guide of field instruments and control valves by application type*

## Process data acquisition

- Process data acquisition for field equipment selection and sizing
  - *Application list for process data*

## Equipment selection

- Field equipment type definition
  - *Device standard*
- Sizing of flow meters and control valves
  - *Calculation sizing sheets*
- Equipment specification for loops
  - *Specification for equipment in loops*
  - *Calibration list*
  - *Application list*

## Process connection design

- Requirements and specification for mechanical engineering
  - *Installation instructions for field instruments in process piping and machinery*
  - *Dimensional drawings of process connections and field instruments*



# Instrumentation of process flow diagrams => PI-diagrams

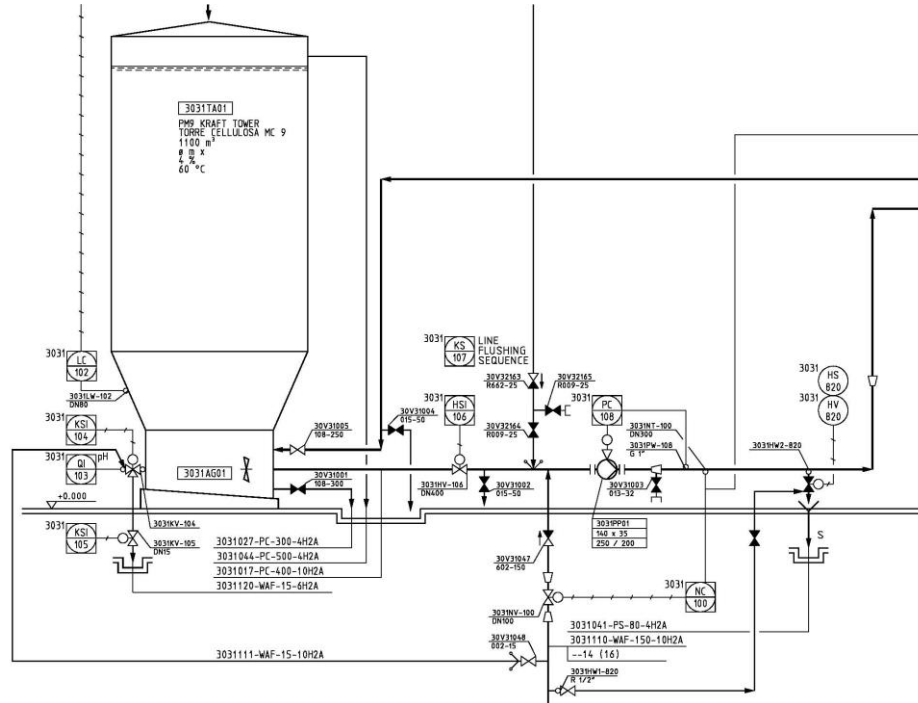

# Process data acquisition

The screenshot displays a software interface for process data acquisition. A central window titled 'PROCESS DATA' is open, showing details for a 'LINE/STREAM PIPE'. The window is divided into several sections:

- Line/Stream Pipe Details:**
  - LineNo: 3125-088
  - Names: (empty)
  - Uon: 236605, DN: 300
  - Pipeclass: 10H120, CC P: (empty), Gasket: AA
  - Flow code: AUSCHUSS
- Physical Properties:**
  - Mass: kg/s
  - Volume: l/s
  - Pressure: 42 MPa
  - Temperature: 55 °C
  - Design: kg/s, 200 l/s, MPa, 59 °C
- Consistency and Density:**
  - Balance: 3.6 %
  - Design: %
  - Density: kg/dm3, 2.83 m/s
  - Velocity: m/s
  - pH: (empty)
  - Viscos: mPa s
  - Content: 4 %
  - Conduct: mS/m
- Vacuum:** (empty)

Below the 'PROCESS DATA' window, there is a table for 'Process Data' with columns for Tag, Tag, Su, <Func. Group, Manuf, Key1>, Set, Supplier, Sign Grp(S), Sign Grp(L), Loc, Pl, Supp, Inst, Pr, Data Group 1, Data Group 2, Litem, S.

Tag	Tag	Su	<Func. Group	Manuf	Key1>	Set	Supplier	Sign Grp(S)	Sign Grp(L)	Loc	Pl	Supp	Inst	Pr	Data Group 1	Data Group 2	Litem	S	
1	FE01		QF	CI3555	METS0AU	0250	METS0 AU	DA0L	P600	V								A	P
1	FT01																		
2	FV01																		

At the bottom of the interface, there is a table for 'Process Data' with columns for \*Sit<Func Group, Manuf, Key1>, Set, Name1, Name2, and Supplier.

*Sit<Func Group	Manuf	Key1>	Set	Name1	Name2	Supplier
1	AY	VXC	JP	02	H-UP	Control valve with electropneumatic positioner, 10/7 mm air supply

# Equipment selection

Calibration calculation

16A2003  
13.9.2008

CONTROL VALVE SIZING SHEET		NELPROF 3.20	
Rev: _____	Revision _____	Tag no: 3128F027-FV01	Slang 1
Customer _____	Metro Contact _____	Cust. Ref _____	Date / by: 5/14/06 / tan16
Metro Ref _____	Metro Contact _____	Cust. Ref _____	Date / by: 5/14/06 / tan16
<b>PROCESS DATA</b>			
Pipe size inlet / outlet	mm 300 / 300	Wall thickness	mm 3
Valve duty	BROKE CIRCULATION	Fluid nature	PULP
Description	Mechanical valve / PP		
Consistency	4 %	Critical pressure	bara 221.2
Molecular weight		Ratio of specific heats	
Flow rate	kg	Case 1	Case 2
Upstream temperature	degC	200	200
Upstream pressure	kPaG	420	420
Differential pressure	kPa	100	30
Downstream pressure	kPaG	300	300
Vapor pressure	bara	0.173	0.173
<b>CALCULATED PERFORMANCE</b>			
Capacity	FoCv	Case 1	Case 2
Percent of full travel	%	781.76	1677.67
Opening in degrees	deg	66.3	96.1
Sound pressure level	dBA (VCMA)	64.1	64.4
Flow velocity (inlet)	m/s	62	67
Terminal pressure drop	bar	4.97	4.97
Pressure recovery factor (F1)		3.66	2.73
		0.86	0.76
<b>VALVE SELECTION</b>			
Nominal size	mm 260	Maximum capacity	Cv 3210
Valve type	SEGMENT	FoCv	2964.32
Valve series	RA		METAL SEATED SEGMENT VALVE
<b>ACTUATOR SIZING DATA</b>			
Supply pressure	kPaG	500	Valve seat
Max shut off db	kPa	420	Gland packing
Load factor		1	Bearings
			std Metal
			PTFE/TFE
			PTFE
<b>ACTUATOR SELECTION</b>			
Selected actuator	B1C13	DOUBLE ACTING CYLINDER ACTUATOR	
Required open	Nm	98	Required close
Opening load factor	%	15	Closing load factor
			Nm
			%
Req control to open	Nm	74	78
Ctrl open load factor	%	11	12
Req control to close	Nm	61	26
Ctrl close load factor	%	8	4
<b>NOTES</b>			

Tag number: 531LT0560		Date: 16.3.04	Rev. 1
<b>Description</b>			
Fluid: Condensate		Temperature T1: 105 °C	
Density dens1: 951 kg/m³	Pressure P1: 1.00 bar		
Density dens2: 1 kg/m³	Temperature T2: 105 °C		
Height h1: 0.60 m	Impulse line density dens3: 998 kg/m³		
Height h2: 0.60 m			
<b>0% calibration</b>			
$dP = (\text{dens2} \cdot g \cdot h1) - (\text{dens3} \cdot g \cdot h1)$			
$dP = -5,9 \text{ kPa}$			
<b>100% calibration</b>			
$dP = ((\text{dens1} \cdot g \cdot h2) + (\text{dens2} \cdot g \cdot (h1-h2))) - (\text{dens3} \cdot g \cdot h1)$			
$dP = -0,3 \text{ kPa}$			

# Process connection design

STANDARD

631-060

August 23, 2007

1 (1)

INSTRUMENTATION DESIGN STANDARDS  
PRESSURE AND SAMPLING CONNECTION  
FOR SERVICE PIPING WITH SHUT OFF VALVE  
DN 10 ...DN 25, LONG WELDING/INSIDE THREAD END R 3/8...R 1

TZT E3X

## 1 GENERAL

The pressure and sampling connection covered by this standard is to be welded on to the tanks, pipes or other equipment. This type of ball valve sampling connection is not to be used for hazardous fluids.

## 2 DIMENSIONS

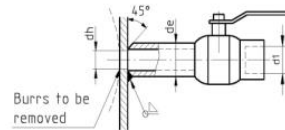

DN	Thread	de	dh
10	R 3/8"	17.2	12
15	R 1/2"	21.3	15
20	R 3/4"	26.9	20
25	R 1"	33.7	25

## 3 MATERIAL

Material same as the base material onto which the connection is to be welded.

## 4 NOTES

Strength of the connection to be checked according to pressure and temperature conditions as indicated in the pressure vessels requirements

## 5 DESIGNATION

Tag, name, DN-thread, material, standard No.  
Example: 33CL-PW001, Pressure and sampling connection, DN 15 - R 1/2",  
1.4432, 631-060

# Detail engineering

# Detail engineering

## **Safety of Automation**

- Engineering Instructions and Standards
- Risk Assessment
- Safety System Design
- Permit Documents and Inspections

## **Process Control System Design (DCS)**

- General Process Control System Engineering

## **Installation design**

- Installation Engineering
- Location Design
- Maintenance design

# Detail engineering

## Process Control Design

### Process Description for Process Control Design

- Alternative 1
  - *Process description*
  - *Interlocking, group start and sequence diagrams*
  - *Functional diagrams for instrument loops*
  - *Distributed Control System DCS graphic display sketches*
- Alternative 2
  - *Process description*
  - *Loop and circuit wise functional descriptions or diagrams*
  - *Distributed Control System DCS graphic display sketches*
- Alternative 3
  - *Process description*
  - *Loop and circuit wise process description*
  - *Distributed Control System DCS graphic display sketches*

# LOOP WISE FUNCTIONAL Description for Process Control Design

## 3031FC-003 PGW PULP TO PM8

### PURPOSE AND FUNCTION

To keep the PGW pulp flow from PGW TOWER 1 and PGW TOWER 2 to PM8 at desired value by controlling the flow with valve FV.

Controller gets remote setpoint from PM8 BROKE TOWER level controller. Remote setpoint = level controller output \* 1.

### INTERLOCKS

Interlock type: 31X

In manual mode interlock signal is true for a time period (pulse) = Valve closes with ramp. In auto mode when interlock signal is true = Valve closes with ramp, control block freezes, mode is kept, mode can be operated during interlock.

In manual mode after the time period (pulse) interlock signal is false = Control block is released for operation, valve stays closed. In auto mode when interlock signal is false = Valve opens with ramp, control block is released for operation when measurement has reached set value (set point - constant) or after a time delay.

Signals:

3031PP02 (PGW TOWER 1 PUMP) is stopped  
AND  
3031PP03 (PGW TOWER 2 PUMP) is stopped

### FAULT INSTRUCTIONS

### DOCUMENT HISTORY

---

## 3031FC-003 PASTA PGW PER MC8

### SCOPO E FUNZIONAMENTO

Mantenere al valore desiderato il flusso della pasta PGW da TORRE PGW 1 e TORRE PGW 2 alla MC8, controllando il flusso con la valvola FV.

Al regolatore è fornito il valore di impostazione remoto dal regolatore di livello della TORRE FOGLIACCI MC8. Valore di impostazione remoto = output del regolatore di livello \* 1.

### INTERBLOCCHI

Tipo di interblocco: 31X

Nel modo manuale, se il segnale dell'interblocco corrisponde allo stato reale per un periodo (temporizzazione) = La valvola si chiude gradualmente (rampa).

Nel modo automatico, se il segnale dell'interblocco corrisponde allo stato reale = La valvola si chiude gradualmente (rampa), il gruppo di controllo viene disabilitato, il modo rimane invariato, ma è possibile modificare il modo durante l'interblocco.

Nel modo manuale, se il segnale dell'interblocco non corrisponde allo stato reale dopo il periodo di tempo (temporizzazione) stabilito = Il gruppo di controllo viene abilitato al funzionamento, la valvola rimane chiusa.

Nel modo automatico, quando il segnale dell'interblocco non corrisponde allo stato reale = La valvola si apre gradualmente (rampa), il gruppo di controllo viene abilitato al funzionamento quando la misurazione ha raggiunto il valore impostato (setpoint - costante) oppure dopo un ritardo.

Segnali:

3031PP02 (POMPA TORRE PGW 1) spenta  
AND  
3031PP03 (POMPA TORRE PGW 2) spenta

### ISTRUZIONI IN CASO DI ANOMALIA

### TRACCIA DELLA DOCUMENTAZIONE

---



# FUNCTIONAL DIAGRAM for Process Control Design

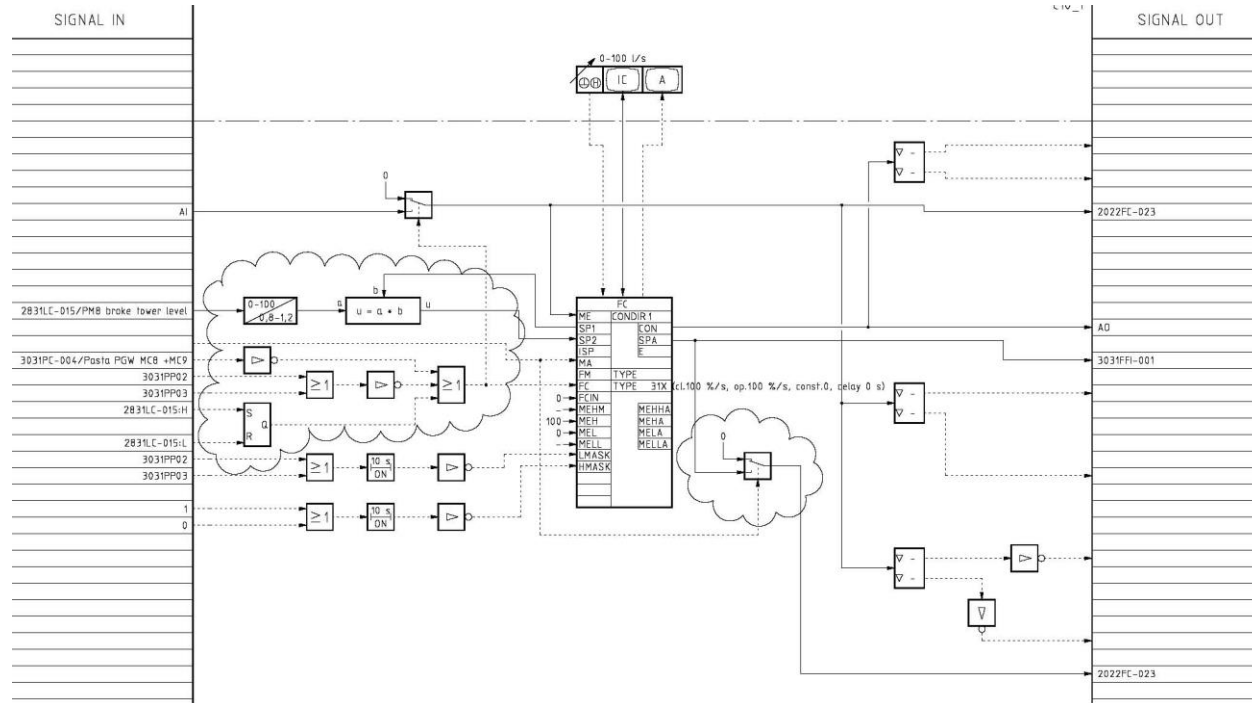

# Safety of Automation

## Engineering Instructions and Standards

- Implementation procedure for Safety Related Systems (SRS)

## Risk Assessment

- Specification of automation in hazardous and classified areas
- Participation to hazard and risk analysis
- Hazard and risk analyse reports with safety integrity levels (SIL)
- Functional safety requirements

## Safety System Design

- Safety Instrumented Systems (SIS)
- Documentation and participation in FAT, SAT and lifetime tests as related to safety system design
- Installation and commissioning planning
- Composing the operation and the maintenance instructions as related to safety system design

## Permit Documents and Inspections

- Permit documents of safety related systems
  - Permit documents of automation in hazardous and classified areas
  - Permit documents of radioactive material in automation
  - Compiling the required documents for verification
  - Verification reports handling
  - Participation in verification meetings with authorities
-

# Process Control System Design (DCS)

## General Process Control System Engineering

- Specification of DCS concept
- Panel, cabinet and rack layouts
- Wiring diagrams for panels, cabinets and racks
- Cross connection layouts
- Wiring diagrams for cross connection
- Allocation of applications in process stations (controllers)
- Allocation of I/O's and signals to the DCS
- Allocation of field bus segments

# Cross connection layouts

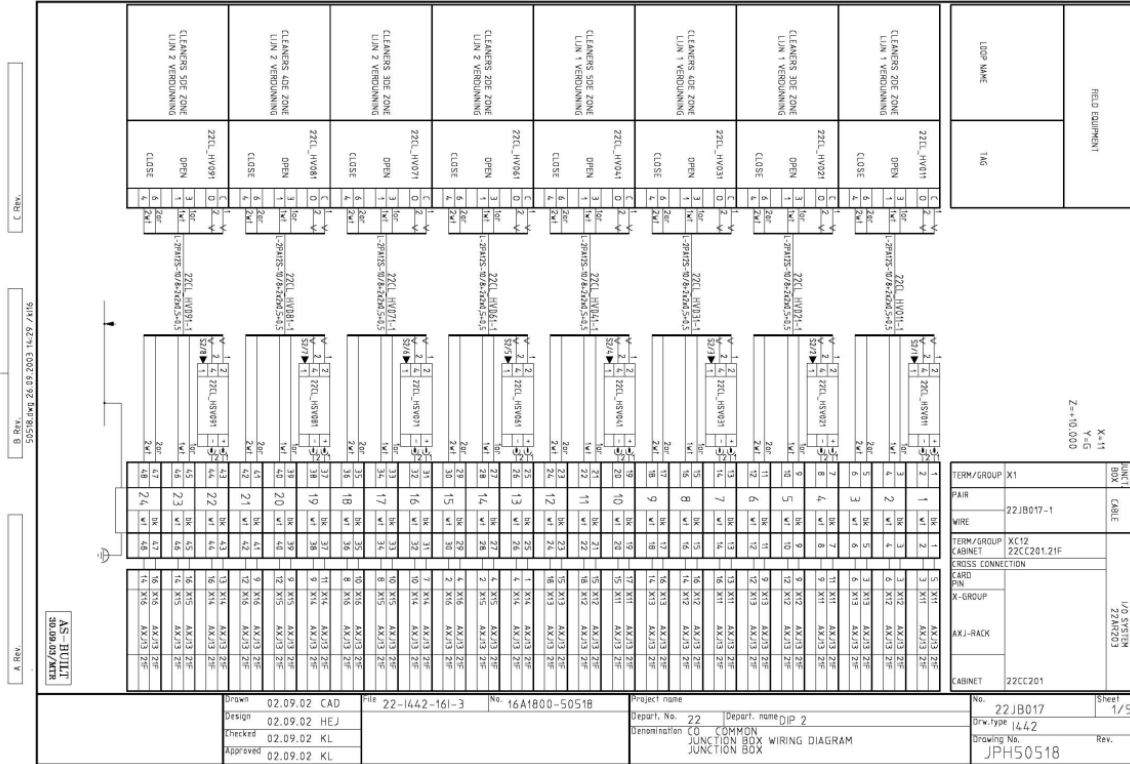

# Installation design

## Installation Engineering

- Typical installation drawings and general instructions
- Field box and panel layouts
- Wiring diagrams of field equipment to field boxes and panels
- Wiring diagrams of field bus segments
- Control equipment and box lists
- Cable lists
- Name plate and marking lists
- Application list for installation

## Location Design

- Location drawings for field instruments and boxes

## Maintenance design

- Loop diagrams
- Collection of the operation and the maintenance instructions of instruments

# Typical installation drawings and general instructions

C Rev. \_\_\_\_\_

B Rev. 16A2003-5003 JPH 27.10.04. 09.10 / JPH/MS  
MECHANICAL INSTALLATION

A Rev. 27.10.04. TDU \_\_\_\_\_

SPECIFICATION				IC = INSTRUMENT CONTRACTOR IS = INSTRUMENT SUPPLIER MC = MECHANICAL CONTRACTOR EC = ELECTRICAL CONTRACTOR P = PURCHASED BY I = INSTALLED BY		NC = NETWORK CONTRACTOR B = BUYER	
Item	Description	Quantity	Size Material	Manufacturer Type/Remarks	P	I	Code
B1	Magnetic flowmeter	1		According to specification	IS	MC	11F_Y BE91
B2	Transmitter for magnetic flowmeter	1		According to specification	IS	IC	11F_Y DT01
F1	Conduit	6 m	Ø 25 mm PVC	Material by mill standard See IV.A.11	IC	IC	12C_Y X020
F2	Conduit	2 m	Ø 25 mm PVC	Material by mill standard See IV.A.11	IC	IC	12C_Y X020
F3	Field instrument nameplate	2	Mill stand. Plastic	Type by mill standard See IV.A.11	IC	IC	10M_Y X001
F4	Cable nameplate	8	Mill stand. Plastic	Type by mill standard See IV.A.11	IC	IC	10M_Y X002
U1	Bolt, DN 934	2	M8		MC	MC	MXG_BS M8
U2	Nut and washer, DN 934	2	M8 SS2343		IS	IC	MXG_NS M8
U3	Name plate holder	1	Mill stand.	Acc. to IV.A.11 opt. A1 See IV.A.11	IC	IC	10M_Y X001
U4	Name plate holder	1	Mill stand.		IC	IC	10M_Y X002
U5	Mounting support for amplifier	1	Mill stand.	Type by mill standard See IV.A.11	IC	IC	1A_Y RX02
U6	Cable clamp supplied with instrument	6			IS	IS	1A_AN Y
U7	Clamps and marking accessories	1 set		See IV.A.01	IC	IC	10M_X 001
U8	Flaring and supporting material	1 set		See IV.A.01	IC	IC	10M_X 002
W1	Signal cable 7 core	35 m		Type by mill standard See IV.A.11	IS	IC	EW5_Y 0005
W2	Magnetic flowmeter signal cable with shield and individual shielded wires	10 m		Included in instrument delivery (see IV.B.02)	IS	IC	EW5_XX P001 CA
W3	Power supply cable 3x1.5 mm <sup>2</sup>	35 m		Type by mill standard See IV.A.11	IS	IC	EW6_Y 1010
W4	Power supply cable for magp flowmeter	10 m		Type by mill standard See IV.A.11	IS	IC	EW6_Y M010
W5	Bare earthing cable	2 m			IS	IC	EW6_C U_010

NOTES:  
- Conduit (F2) to be fixed after the insulation of process pipe.

Drawn	22.10.03	CAD	File	000-1624-161-3	No.	16A2003-50033
Design	22.10.03	KL				
Checked	22.10.03	Mite				
Approved	22.10.03	Mite				

Project name		No.	IV FTFM.015	Sheet	1/1
Design no.	000_GENERAL	Dwg type	160	Process	3
Denomination	Flow measurement with magnetic flowmeter	Drawing number	JPH-50033	Rev.	A
INSTALLATION DETAIL DRAWING					

# Typical installation drawings and general instructions



# Wiring diagrams of field equipment to field boxes and panels

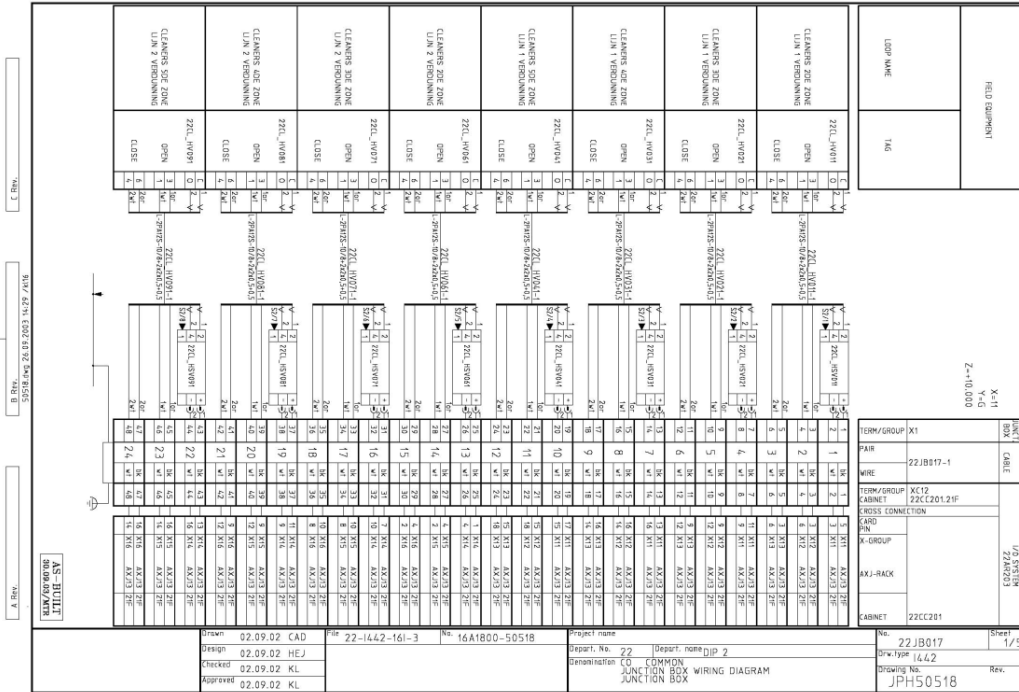



# Wiring diagrams of field equipment to field boxes and panels

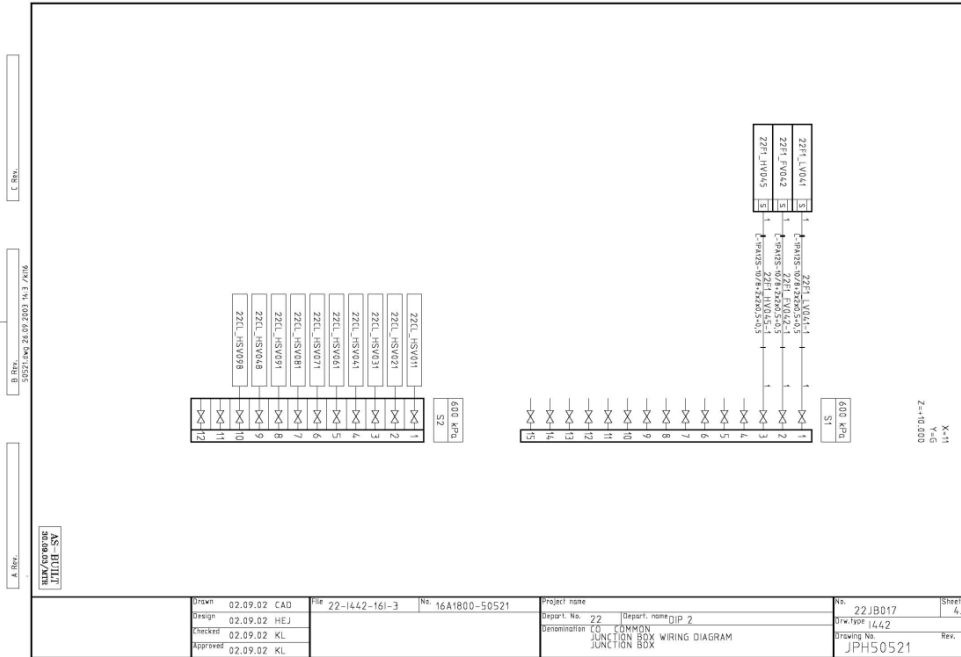

# Wiring diagrams of field equipment to field boxes and panels

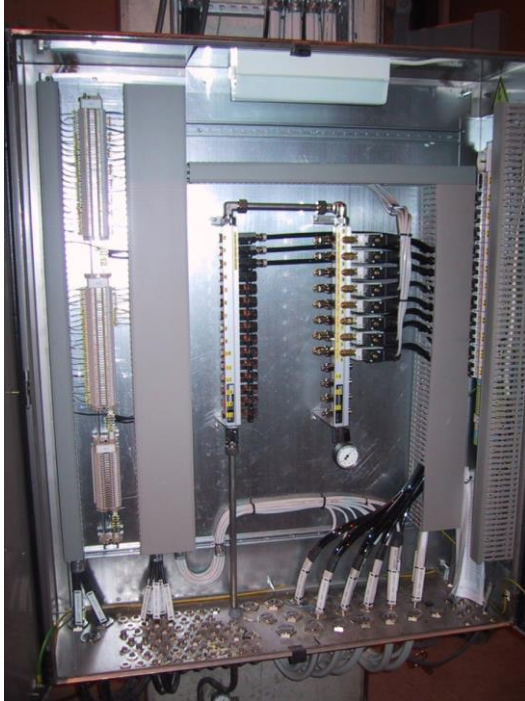

# Allocations of instruments in process piping (3D-model)

Cadmatic Project 16B0248

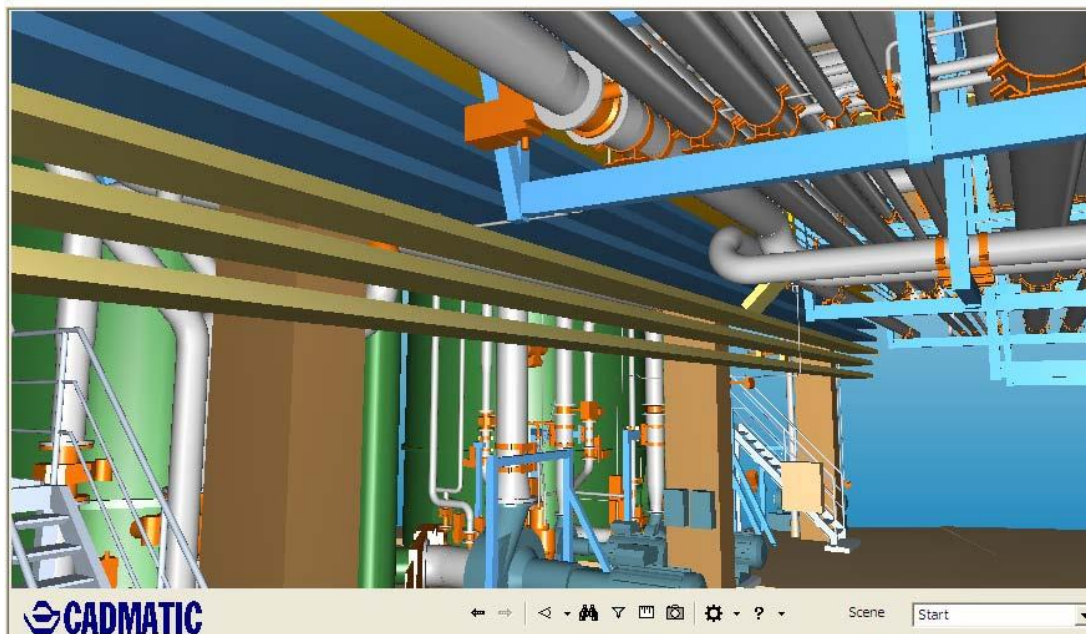

# Location drawings

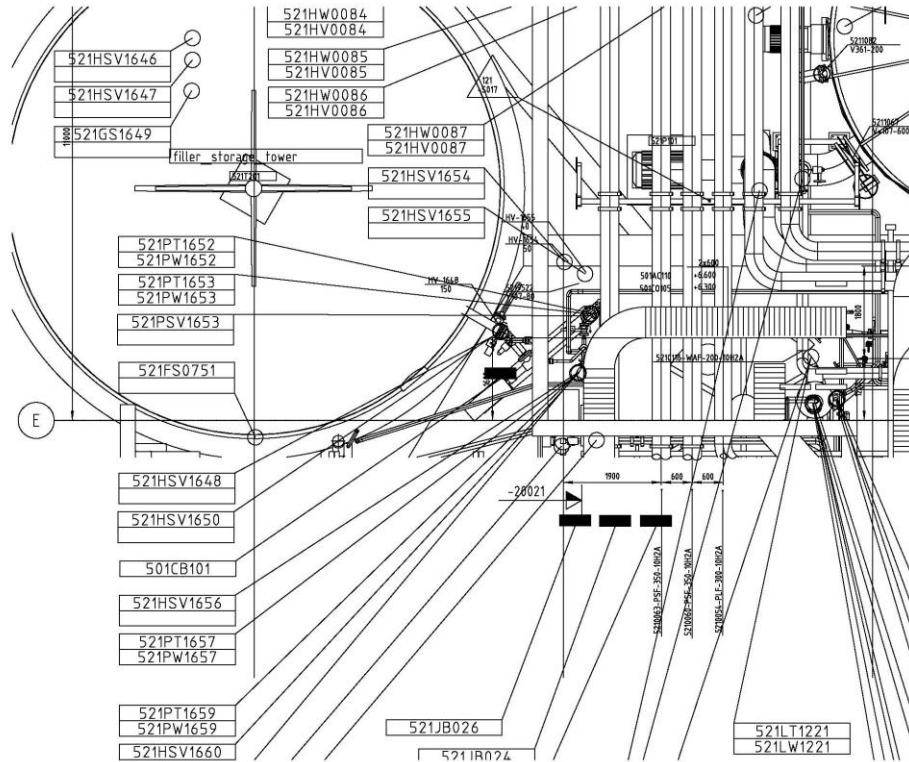

# Loop diagrams

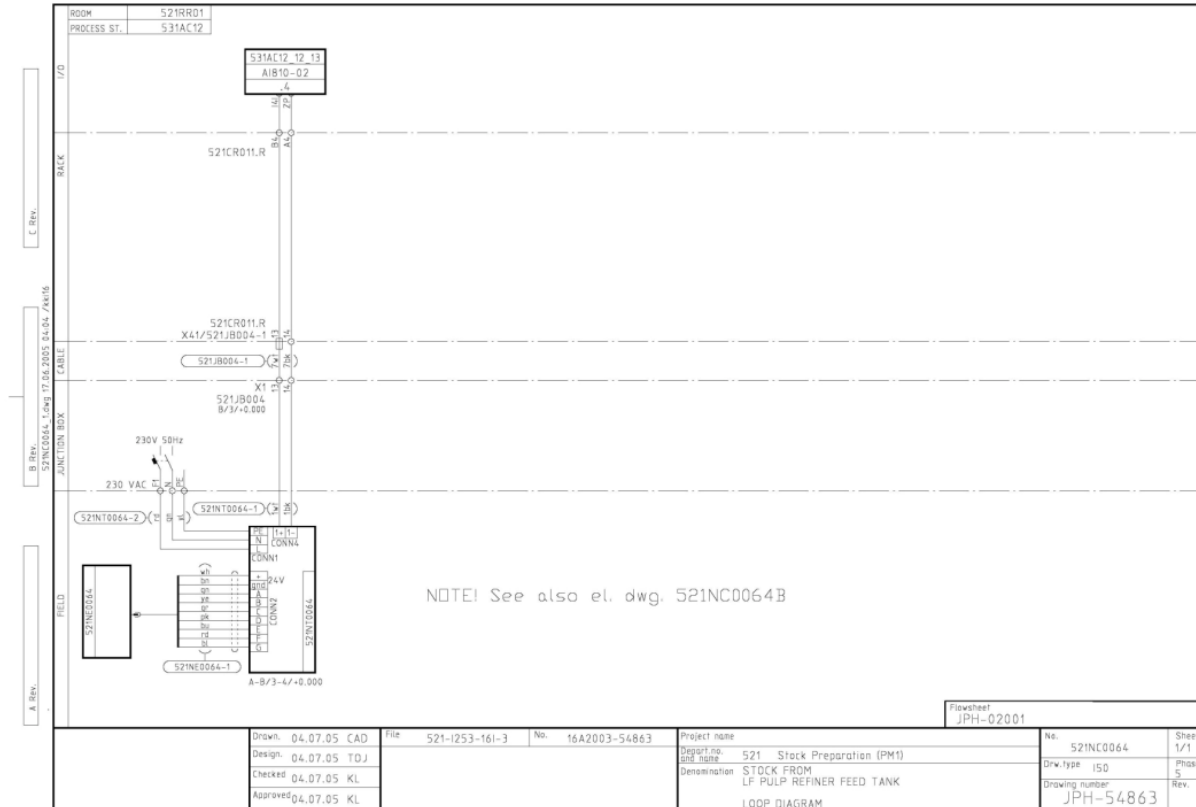

# Site Services

# Site Services

## **FAT (Factory Acceptance Test) for DCS**

- 4 ...12 weeks
- Application configuration checking in simulation situation
- Base parameters for control loops

## **Installation supervision**

- 6 ... 12 month

## **Loop checks (SAT Site Acceptance Test)**

- 6 ... 12 weeks
- Every signal will be tested (measurements, controls, binary signals)

## **Test runs and commissioning**

- 6 ... 12 weeks
- Tuning of the control loops

# ICT Infrastructure, Data Networks and Physical Security engineering @ AFRY



# Contents:

- 1 ICT & Security
- 2 Scope of pre-engineering project
- 3 Scope of detail engineering project
- 4 Site services

# 1. ICT & Security

Pope election 2005 vs 2013

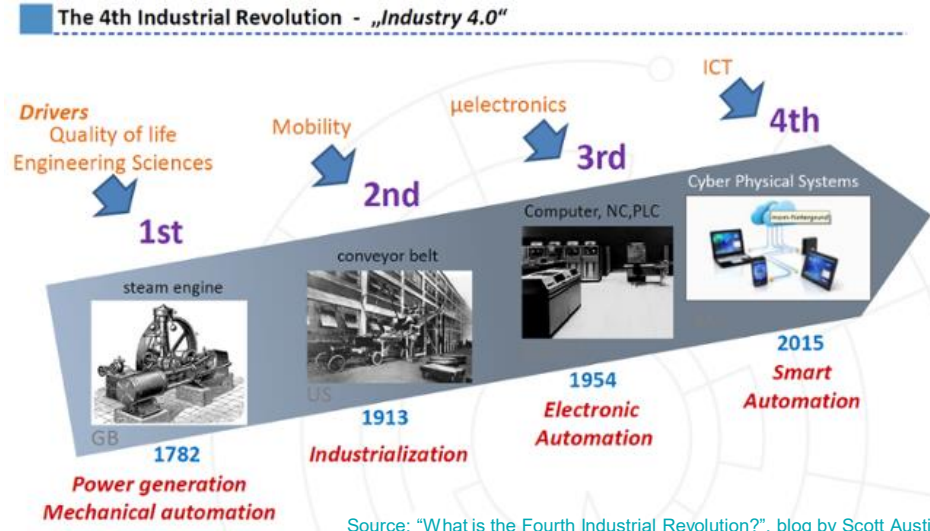

- Amount of network connected devices has increased significantly (IoT, IIoT, others)
- Requirements for real-time data have increased significantly due to desire of digital business operations (digitalization, Industry 4.0...)

# 1. ICT & Security

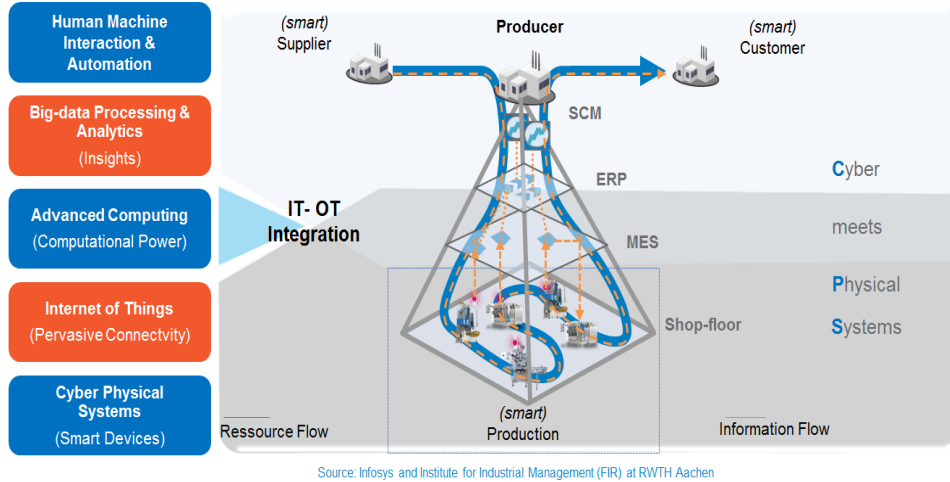

## ISA 95 Functional Hierarchy of Activities

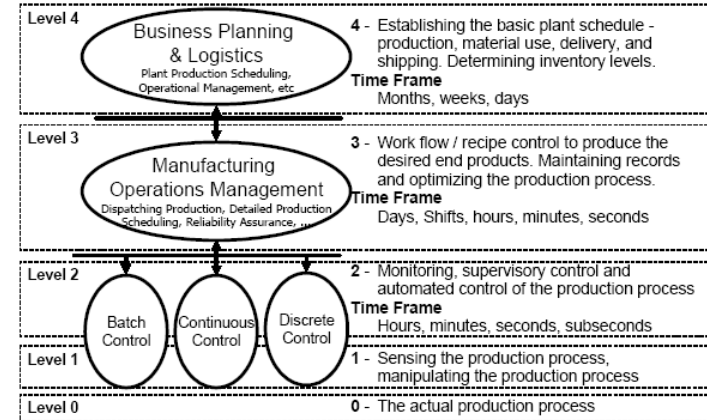

Figure 2 - Multi-level functional hierarchy of activities

- Intelligence of systems in moving towards lower levels of activities
- Cyber Physical Systems
- No cyber security without physical security

# 2. Scope of pre-engineering project



- Principle diagrams:
  - *VLAN and sub-net diagram*
  - *Fiber optic trunk cabling diagram*
  - *Switch topology diagram*
- Standards & Instructions
  - *Operational Technology ICT*
  - *Sub-netting and addressing*
  - *Cyber Security*
  - *Cabinets, enclosures and rooms*
  - *Physical Security*
- ICT and Security concept
- ICT and Security cost estimate

# 2. Scope of pre-engineering project

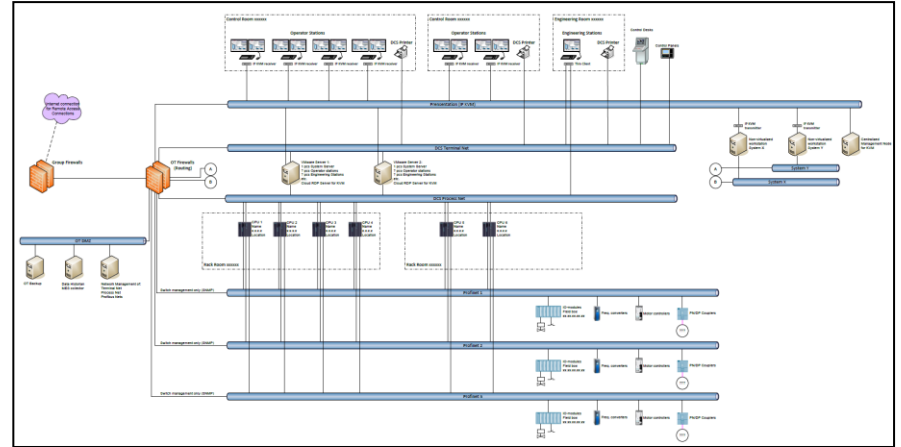
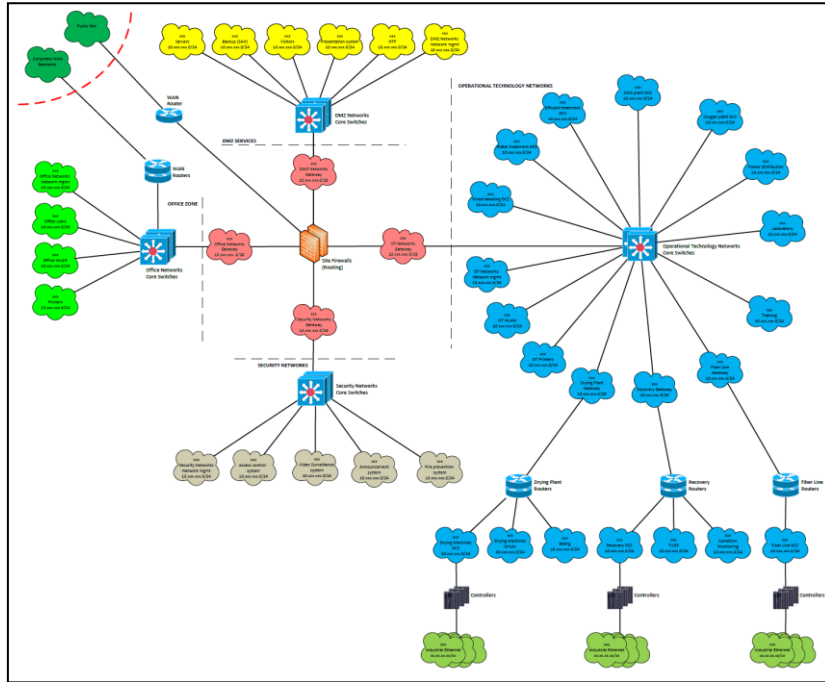

# 3. Scope of detail engineering project

## More instructions and design standards...

- *ICT Infrastructure and Data Networks Installation*
- *Wireless Local Area Network*
- *Cable Standard*
- *Numbering and Identification System for ICT Infrastructure and Data Networks*
- *Marking and Name Plate Standard for ICT Infrastructure and Data Networks*

**Enquiry specifications, bid evaluations, participation in technical negotiations, purchase specifications**

# 3. Scope of detail engineering project

## Data network **architecture and cyber security** design for Operational Technology, Security systems and Office Data Networks

*The networks shall be segmented as necessary to provide adequate services, redundancy and security to ordinary and mission critical communication and systems.*

- *Data network system diagram for Operational technology systems*
- *Sub-network/VLAN diagrams*
- *Switch topology (connectivity) diagram*
- *Switch port VLAN allocation lists*
- *IP address allocation lists*
- *List of systems and equipment applications (software and firmware)*
- *List of systems and equipment communication dependencies and routing*
- *WLAN coverage simulation report*

# 3. Scope of detail engineering project

## 2.1. Coverage, Overlap and Performance

### Data Rate for Floor 1

Data Rate is the highest possible speed (measured in megabits per second) at which the wireless devices will be transmitting data. Typically the true data throughput is about half of the data rate or less.





# 3. Scope of detail engineering project

## Data network **physical infrastructure** design for Operational Technology, Security systems and Office Data Networks

*The necessary cabling and wireless communication channels shall be designed and coordinated. Locations for the Network cabinets and field boxes shall be verified together with the engineering party responsible for 3D modelling. Requirements to electrification design and cable tray route design are specified to the engineering parties responsible for those systems.*

- *Fibre optic backbone cabling diagram*
- *Cable lists*
- *Fibre allocation lists*
- *Connection diagrams (communication channels)*
- *Location drawings for network infrastructure objects (telecom outlets, network cabinets, WLAN access points, etc.)*
- *Layout drawings of network cabinets*
- *Typical installation drawings for network infrastructure objects*

# 3. Scope of detail engineering project

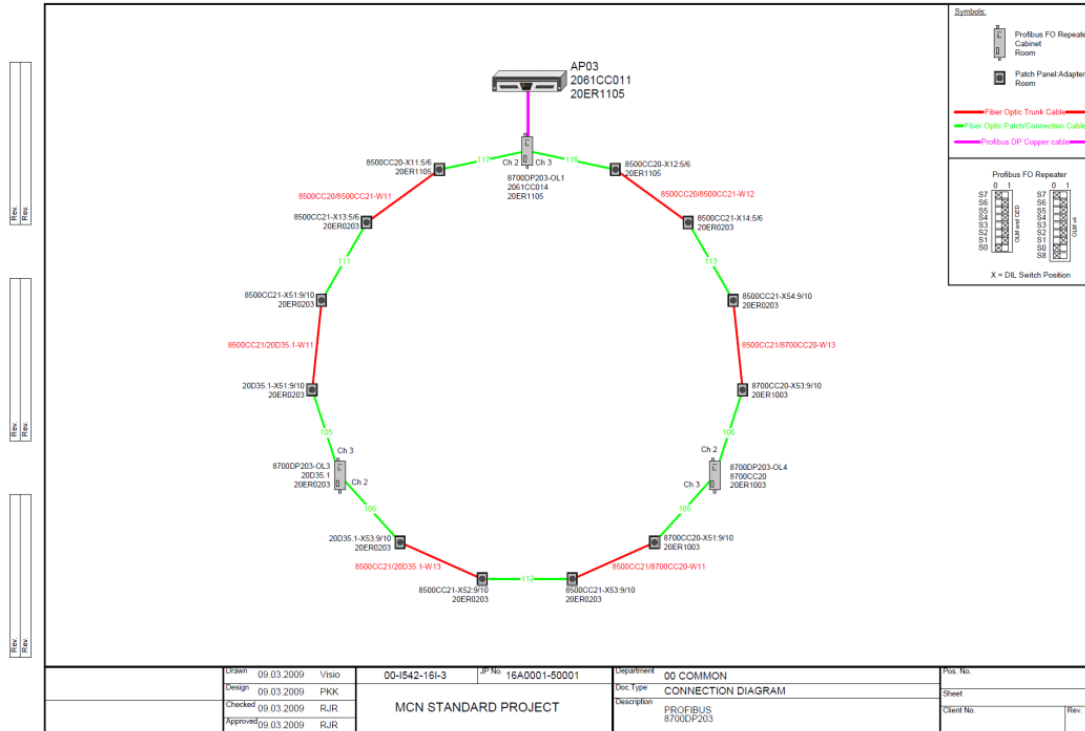

# 3. Scope of detail engineering project

## Physical security design

*Physical security design process takes into account structural security, multiple security sensor detection, communication and monitoring technologies based on Security risk assessment and intrusion analysis. Protective measures are coordinated with other engineering disciplines. Physical security solutions are designed to be compliant with national and international regulations, industry best practice and commensurated with the risk level and the specific activities and needs of the organization and site.*

- *Video surveillance system*
- *Access Control system*
- *Electronic locking system*
- *Intrusion alarm system*

# 4. Site Services

## Installation supervision

- 6 ... 9 months

## Commissioning & start-up services

- 6 ... 12 weeks

# Electrical engineering at AFRY

# Contents:

- 1 Electrical engineering
- 2 Scope of pre-engineering project
- 3 Scope of detail engineering project
- 4 Field services
- 5 Engineering tools
- 6 Co-operation with other disciplines
- 7 Summary

# 1. Electrical engineering

## Network Calculation Service

- Short circuit calculations
- Load flow and voltage profile study
- Protective device co-ordination study

## Power Distribution Analysis

- Capacity and loading conditions
- Harmonic analysis
- Clear picture of current situation
- Road map for continuous development

# 2. Scope of Pre-engineering project



- Power distribution one line diagram
- Preliminary short circuit calculations
- Active and reactive power balance
- Brief description of electrical systems
- Specification of required electrical rooms and main cable routes for layout engineering
- Electrical cost estimate



•20 kV SWITCHGEAR

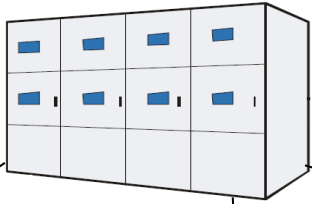

•MAIN TRANSFORMER

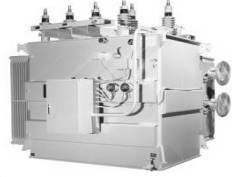

•110 kV UTILITY SUBSTATION

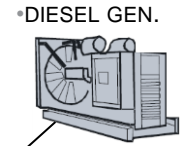
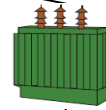
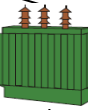
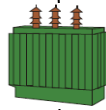
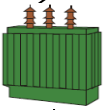
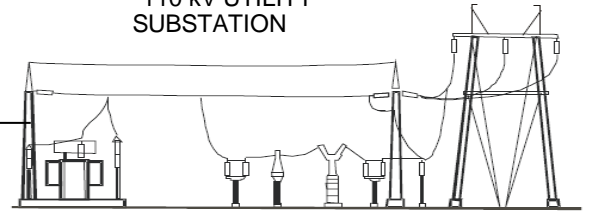

•ELECTRICAL ROOM

•MCC  
•6kV



•MCC  
•690V

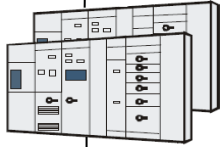

•SECTIONAL  
•DRIVES  
•690V



BUILDING  
ELECTRIFICATION  
400V

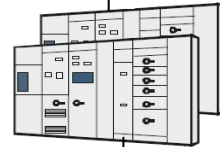

•UPS

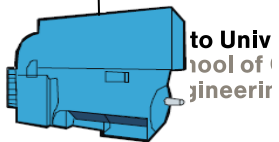

to Univ  
ool of  
ineerir

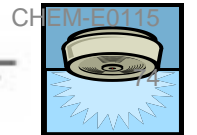
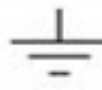
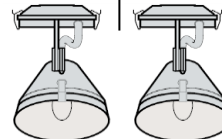
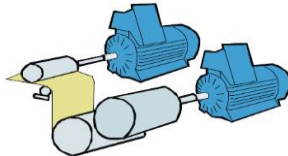
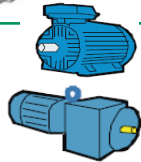

# 3. Scope of detail engineering project

## Engineering instructions and design standards

- *Electrical design criteria*
- *Electrification instructions for machinery suppliers*
- *List of recommended electrical equipment and components*
- *Cable standard*
- *Marking and numbering instructions*
- *Starter and cable sizing table*

**Enquiry specifications, bid evaluations, participation in technical negotiations, purchase specifications**

# 3. Scope of detail engineering project

Rev.	Pn kW	MOTOR		FUSE (IEC 269)		Fused load break switch	Contactor	Motor controller	Current trafo		CABLE MCC- safety switch	max allowed length m	Module size	
		In A	Is A	A	Starting time s				Size	ratio				turns
	0.025	0.44	1.3	2aM	>50	00				3	2/	NY-Y-J 4x2,5	934	
	0.37	0.59	1.9	2aM	>50	00				3			934	
	0.55	0.84	3.3	2aM	>50	00				2			934	
	0.75	1.1	4.5	2aM	>50	00				1			934	
	1.1	1.5	6	2aM	>50	00							934	
	1.5	2.0	10	2aM	11	00							465	
	2.2	2.7	14	4aM	>50	00							465	
	3	3.7	20	4aM	8	00							308	
	4	4.8	31	6aM	7	00							181	
	5.5	6.6	42	10aM	50	00							181	
	7.5	9	59	16aM	>50	00							107	
	11	13	79	16aM	11	00						NY-Y-J 4x4	110	
	15	17	107	25aM	35	00						NY-Y-J 4x6	131	
	18.5	20	152	32aM	13	00						NY-Y-J 4x10	181	
	22	24	180	40aM	23	00							141	
	30	32	224	50aM	23	00						NY-Y-J 4x16	233	
	37	38	266	50aM	6	1							139	
	45	46	354	80aM	28	1						NY-Y-J 3x25+16	174	
	55	56	375	80aM	16	1						NY-Y-J 3x50+25	237	
	75	78	523	100aM	7	1							185	
	90	93	632	125aM	8	1						NY-Y-J 3x70+35	202	
	110	112	750	160aM	16	1						NY-Y-J 3x95+50	216	
	132	134	925	200aM	19	1						NY-Y-J 3x120+70	240	
	160	159	1113	250aM	23	2						NY-Y-J 3x150+70	188	
	200	200	1400	315aM	28	3						NY-Y-J 3x240+120	290	
	250	246	1599	315aM	8	3						NY-Y-J 3x240+120	290	
	315	313	2128	400aM	6	3						2/	NY-Y-J 3x150+70	296
	355	354	2301	500aM	19	3								228
	400	400	2600	500aM	7	3								228
	500	493	3205				Instantaneous settings 1)	4000 A				2/	NY-Y-J 3x240+120	340
	630	614	4175				Instantaneous settings 1)	5000 A				3/	NY-Y-J 3x185+95	330

<p>If motor current (In or Is), starting time or max allowed length of cable differ from table, dimensioning has to be checked. Dimensioning allows to replace the motor by next larger rating up to 200 kW. Max allowed cable length is for 5 s tripping time. Voltage drop has to be checked separately. 1) Instantaneous overcurrent setting which is used for max. allowed cable length calculation (tolerance 20% included). Dimensioning has to be checked case by case.</p>											
<b>PE.20-Part 4 Annex 101 SAMPLE DOCUMENT</b>											

Tom.	Tom	Pvm	26.6.2002	Model Project		Piir. nimi	Läp.päikkä	Lehti	Rev
		Part.	JV/H	Model Project Company				1/1	
		Suunn.	JV/H					Sovellus	Vaihe
		Tark.	OSS	Osasto n:o	Tekn. kohde n:o	DIMENSIONING TABLE MOTOR STARTERS 690 V		Excel	Läp
							Piirinumero	Motmist00VL20.3	

# 3. Scope of detail engineering project

## *Power distribution*

- Power demand calculations
- Active and reactive power balance
- One line diagram
- Short circuit calculations
- Switchgear and transformer specifications
- Protective device co-ordination study
- Distribution of control and auxiliary power
- Emergency power distribution system

## *Electrical rooms and main cable routes*

- Electrical room and cable route requirements
- Electrical room layouts
- Specification of required electrical wall, floor and ceiling openings
- Electrical room cable tray arrangement drawings
- Electrical room HVAC requirements

# 3. Scope of detail engineering project

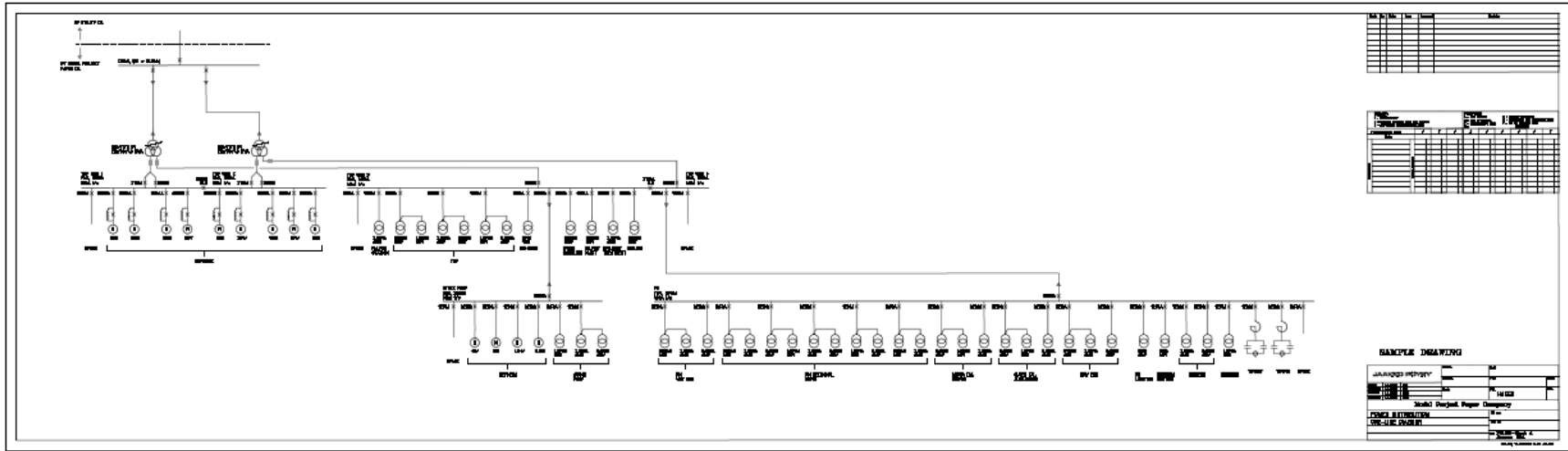

# 3. Scope of detail engineering project

## ***Engineering of process electrification***

- Motors, motor control centers and variable speed drives
  - *Electrical application and circuit list*
  - *MCC and variable speed drive specifications*
  - *Motor delivery requisition list*
  - *Variable speed single drives specifications*
  - *MCC layouts*
  - *Starter wiring diagrams*
- Motor control design
  - *Allocation of motors and electrical I/O to control system*
  - *Circuit and wiring diagrams*

# 3. Scope of detail engineering project

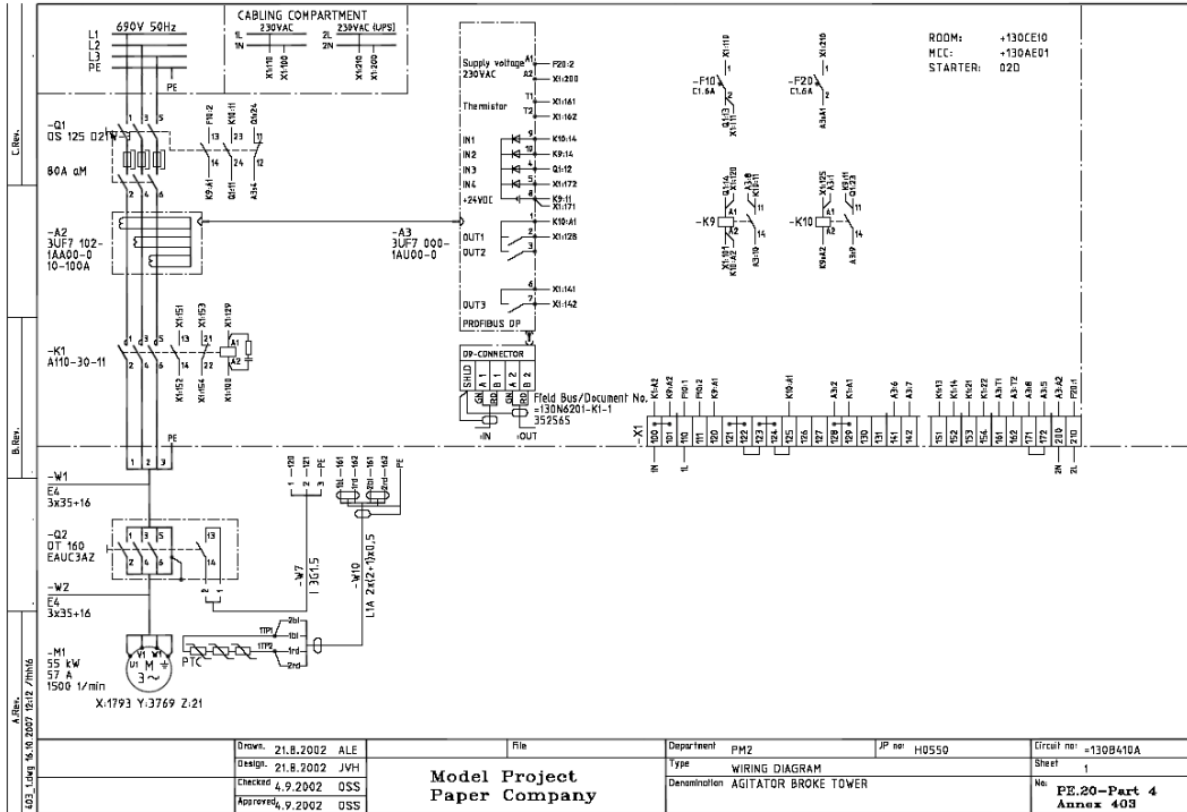

# 3. Scope of detail engineering project

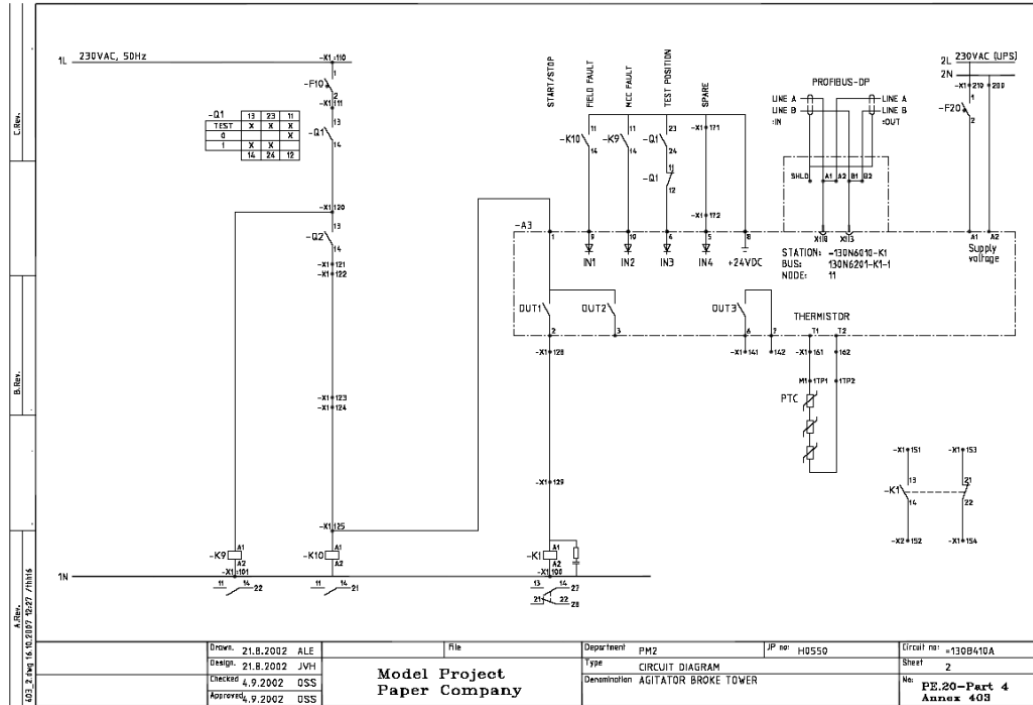



# 3. Scope of detail engineering project

## **Engineering of process electrification**

- Installation design
  - *Electrical installation specification*
  - *Typical installation detail drawings*
  - *Electrical equipment location drawings*
  - *Cable tray installation drawings*
  - *MCC and panel lists*
  - *Field equipment lists*
  - *Cable lists*
  - *Control voltage panel specifications*
  - *Grounding layouts*
  - *Grounding connection drawings*



# 3. Scope of detail engineering project



# 3. Scope of detail engineering project

## ***Engineering of building electrification***

- Lighting design
  - *Lighting design criteria*
  - *Lighting calculations*
  - *Lighting layouts*
  - *Panel specifications*
  - *Lighting fixture specifications*
  - *Installation detail drawings*
  - *Safety and escape lighting*
  - *Lightning protection systems*
  - *Maintenance outlet location drawings*
  - *Installation specification*

# 3. Scope of detail engineering project



# 3. Scope of detail engineering project

## *Engineering of building electrification*

- Fire alarm system
- Grounding electrode

## *Engineering of site*

- Heat tracing system
- Temporary construction power
- Mill site lighting layout

# 3. Scope of detail engineering project

## *As-built drawings for:*

- Application and circuit lists
- MCC specifications and layouts
- Electrical room layouts
- Circuit and wiring diagrams
- Grounding drawings

# 4. Field Services

- Fat tests (MCC, DCS, Power Distribution Control System)
- Installation supervision
- Commissioning and start-up
- Water run
- Baby sitting

# 5. Engineering tools

Drawings: AutoCad/Proelina

Lists: Proelina, Access

3D- Modelling: Cadmatic

Power distribution calculations: Neplan, Excel

Low voltage distribution calculations: Excel

Other documents: Microsoft Office  
(Word, Excel, Access, Power Point)



# 6 Co-operation with other engineering parties

## ELECTRICAL ENGINEERING IN OTHER AFRY OFFICES

- Most of the big projects are "shared projects" ; One of the offices is responsible for the project and detail electrical engineering of process areas will be divided between offices in Finland or world wide

## POWER DISTRIBUTION

- Utility power company
- Mill
- Process engineering

## PROCESS

- Equipment/motor lists
- Motor control engineering

# 6 Co-operation with other engineering parties

## Mechanical and piping engineering

- electrical room dimensions and location
- cable routes for hv power distribution
- fire compartments
- wall and floor openings for cable routes
- motor dimensioning drawings
- foundations for electrical equipment
- layouts for motor location drawings
- cable tray engineering
- location of lighting fixtures
- location of electrical equipment

# 6 Co-operation with other engineering parties

## HVAC engineering

- electrical room heat loads
- ventilation engineering of electrical rooms

## Automation engineering

- motor controls

## Machine vendors

- motor/load list
- automation
- control voltage distribution

# 7 Summary

- Electrical engineering at AFRY includes design from utility substation until motor and other loads including also motor controls and data field bus engineering
- Electrical engineering utilizes effective engineering tools and works in close co-operation with other engineering parties
- AFRY electrical engineering services cover the whole project life cycle starting from pre-feasibility study and including necessary engineering, fat tests , installation supervision and testing at site. After the start-up AFRY can provide services for modification projects with local service concept.