

THE PUNGGOL CHANNEL

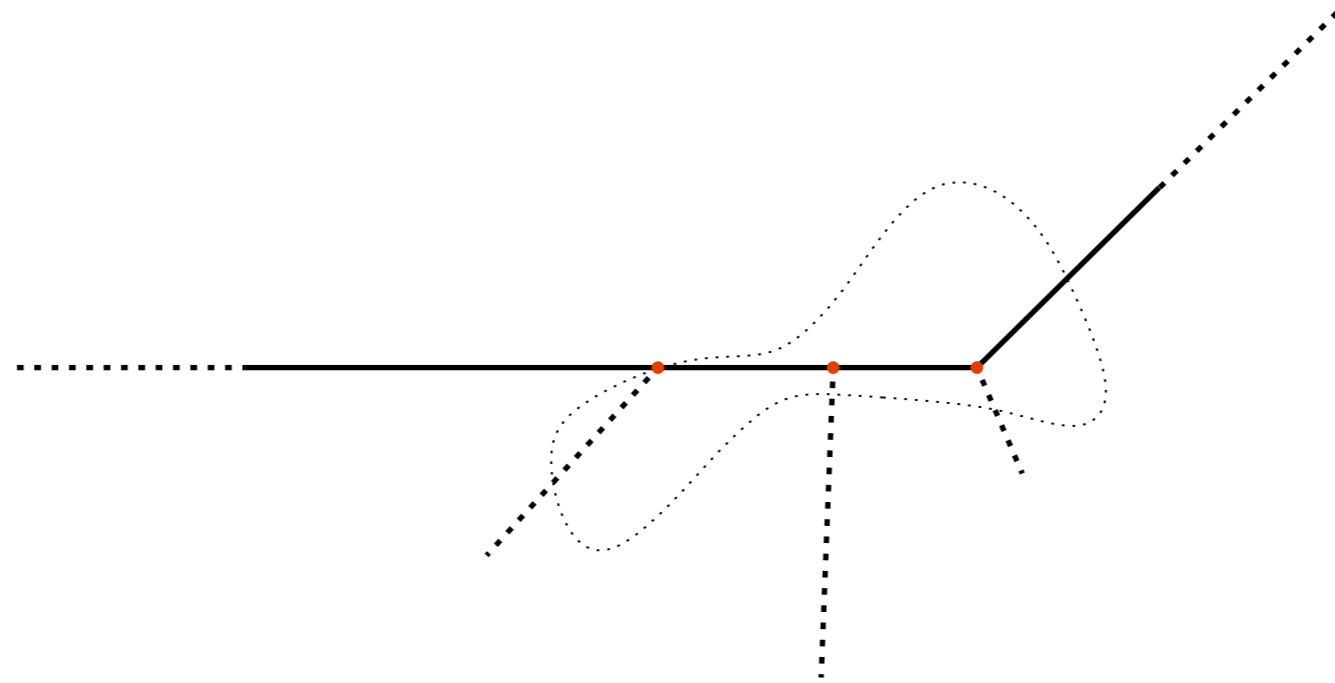

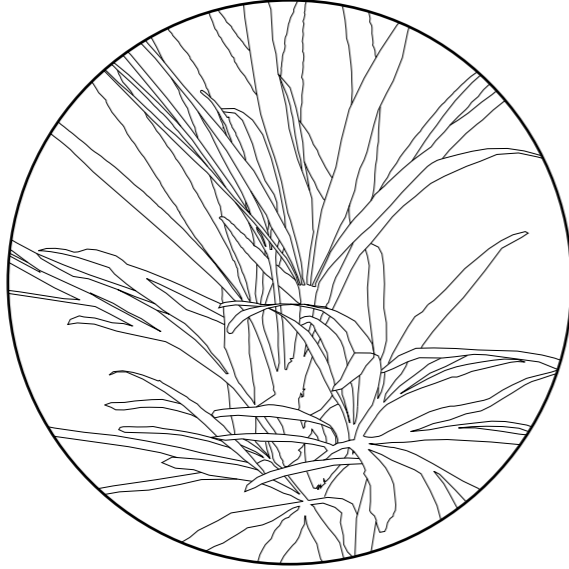

FARMER

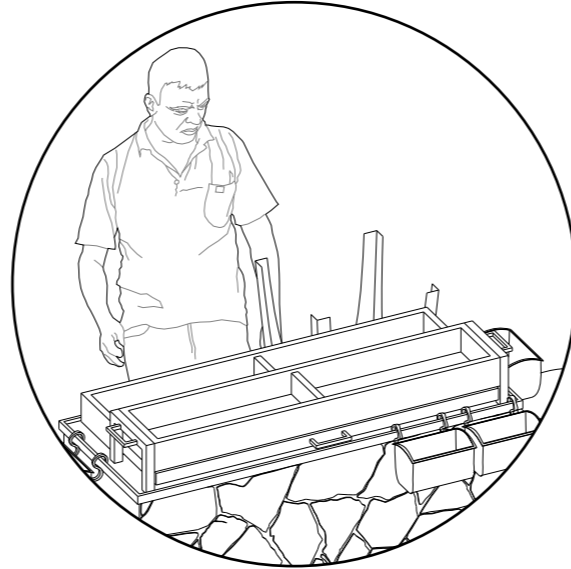

RETAILER



CONSUMER

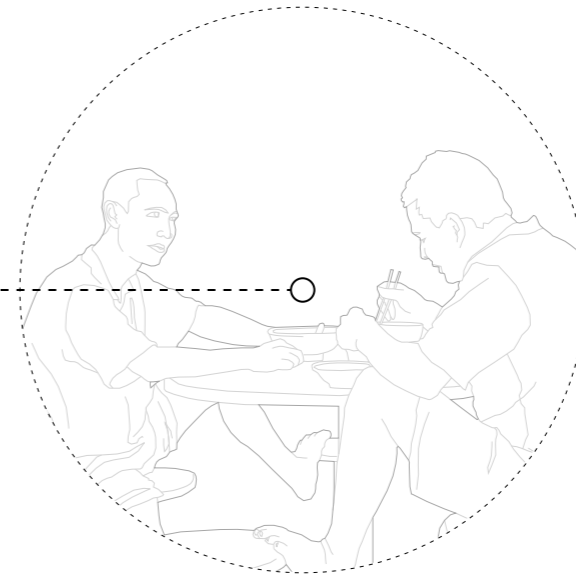
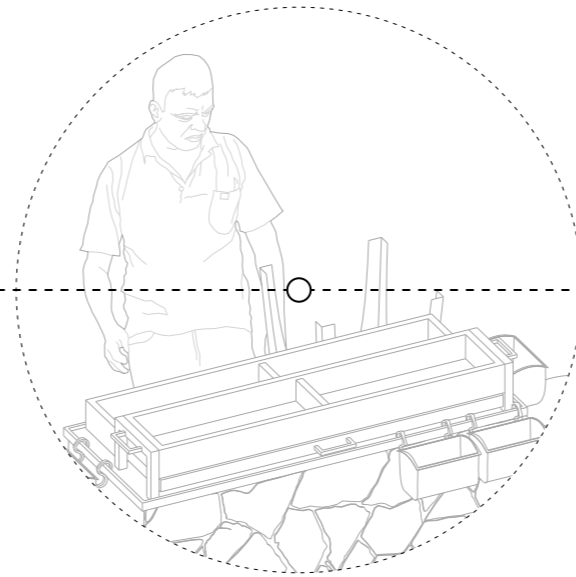
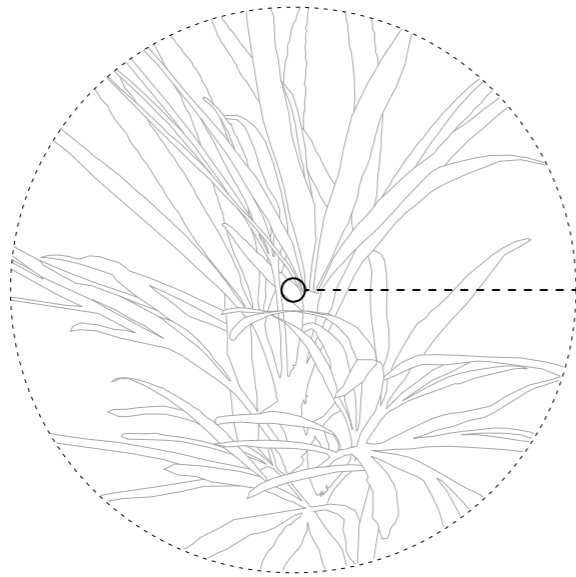

WATER

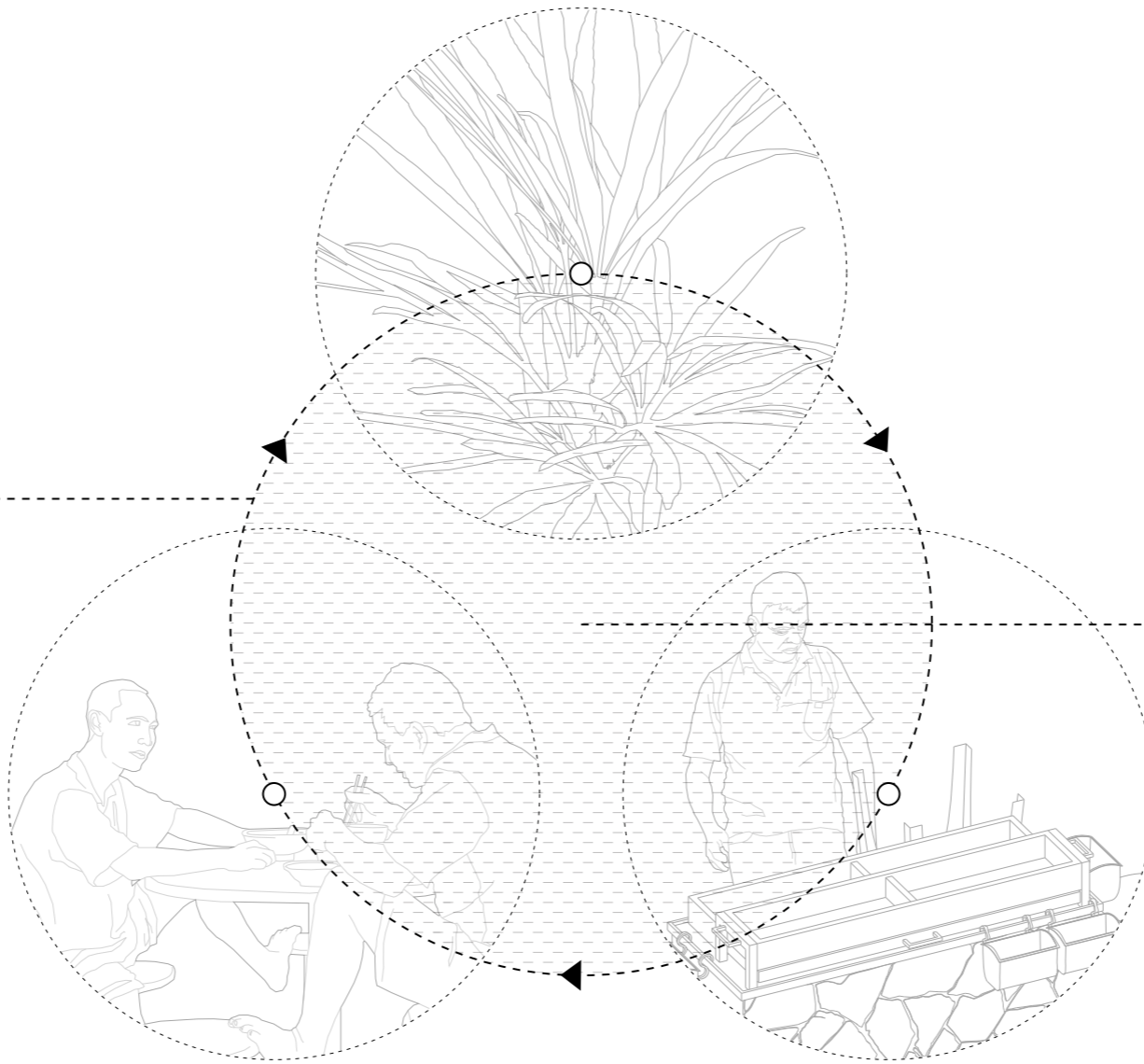

COMMUNITY GARDEN





PCN (NORTH)

PROMENADE

DISCOVERY CUBE

INTERCHANGE

PCN (SOUTH)

WATERWAY POINT/MRT

RESIDENTIAL CROSSING

SCHOOL CROSSING

FUTURE DEVELOPMENT

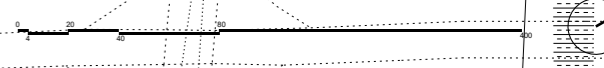
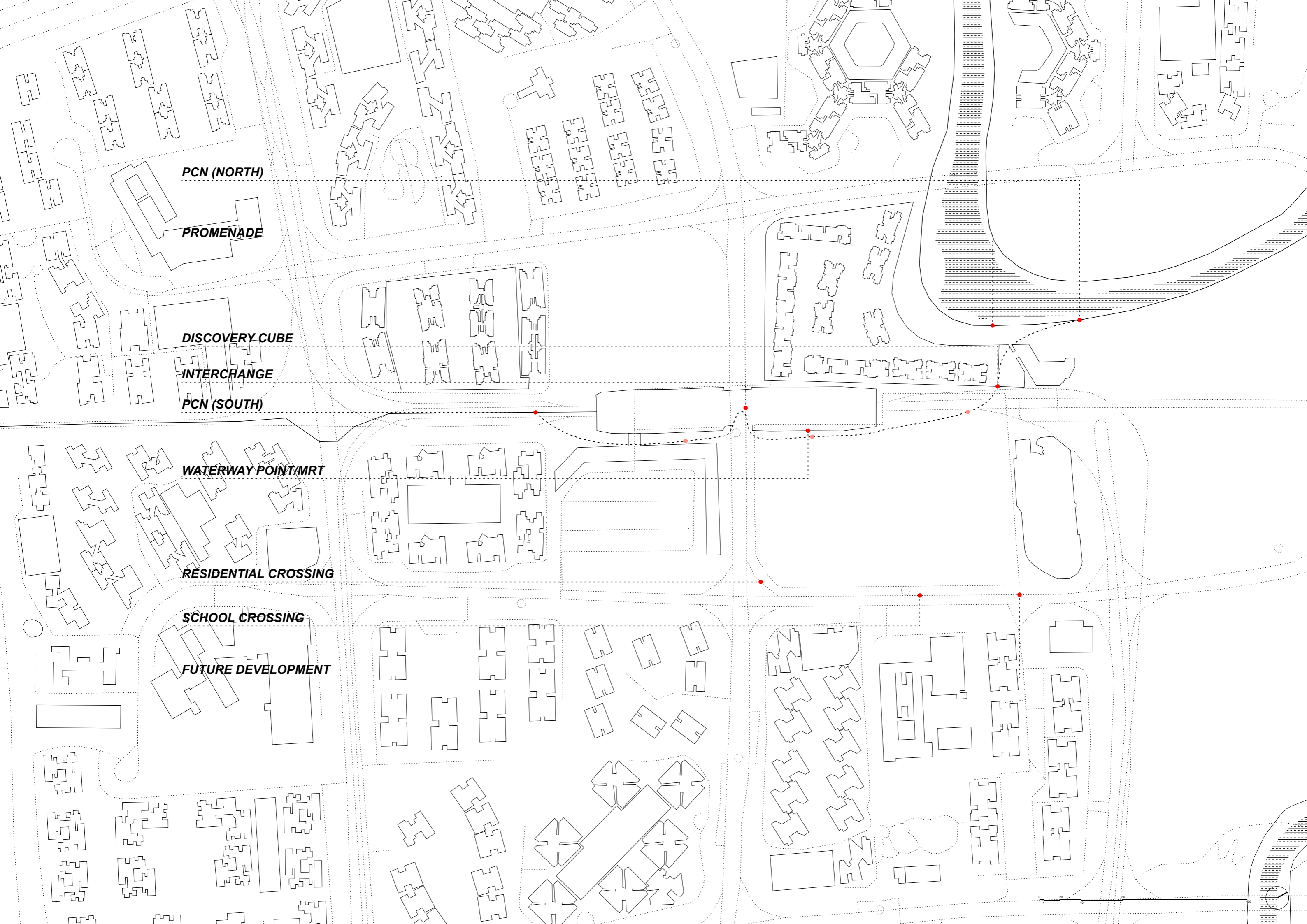

PCN (NORTH)

PROMENADE

DISCOVERY CUBE

INTERCHANGE

PCN (SOUTH)

WATERWAY POINT/MRT

RESIDENTIAL CROSSING

SCHOOL CROSSING

FUTURE DEVELOPMENT

Weekend
Weekday

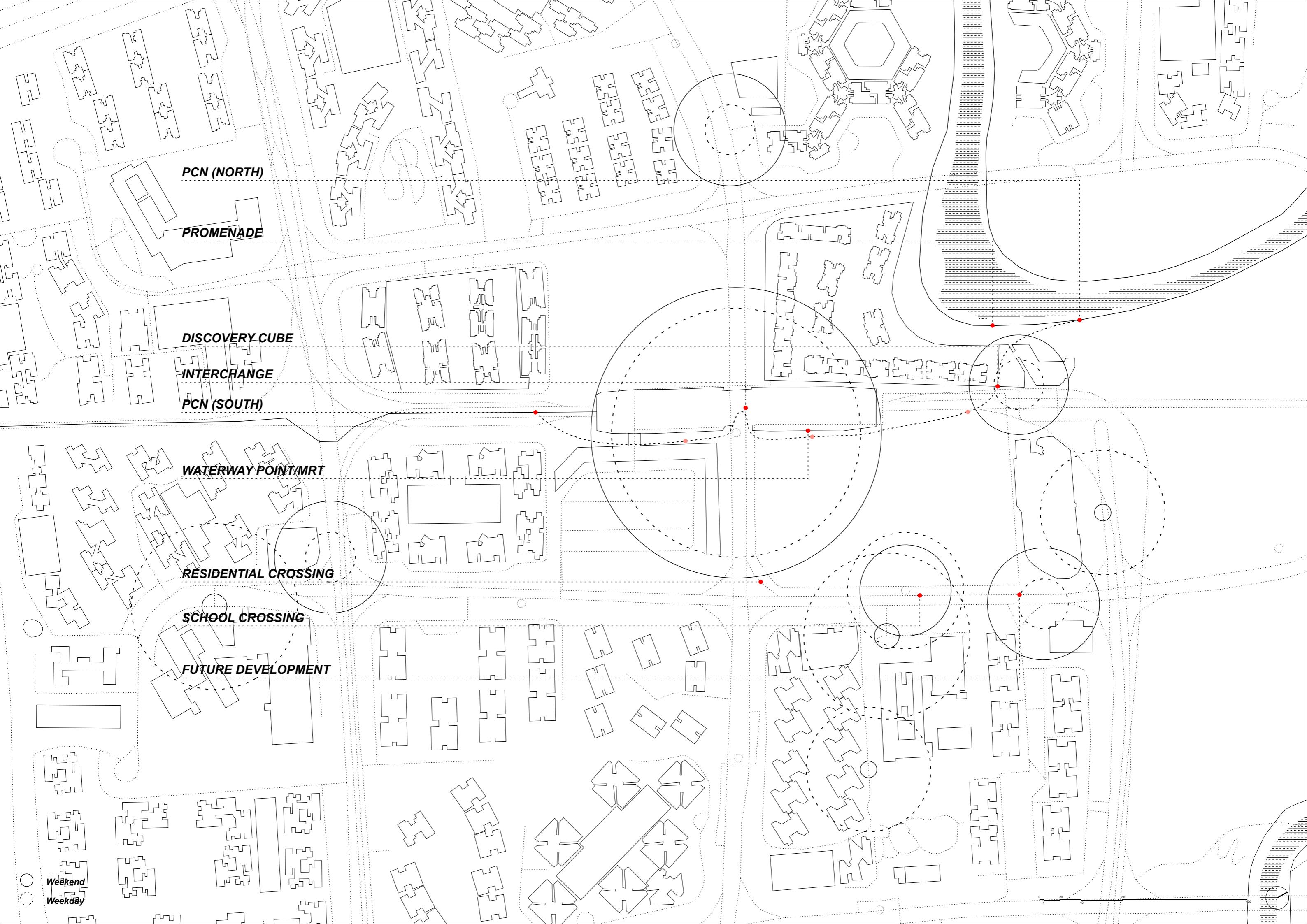

PCN (NORTH) -0.02

PROMENADE -0.02

DISCOVERY CUBE +0.01

INTERCHANGE +0.02

PCN (SOUTH) -0.02

WATERWAY POINT/MRT +0.02

RESIDENTIAL CROSSING +0.02

SCHOOL CROSSING +0.01

FUTURE DEVELOPMENT +0.01

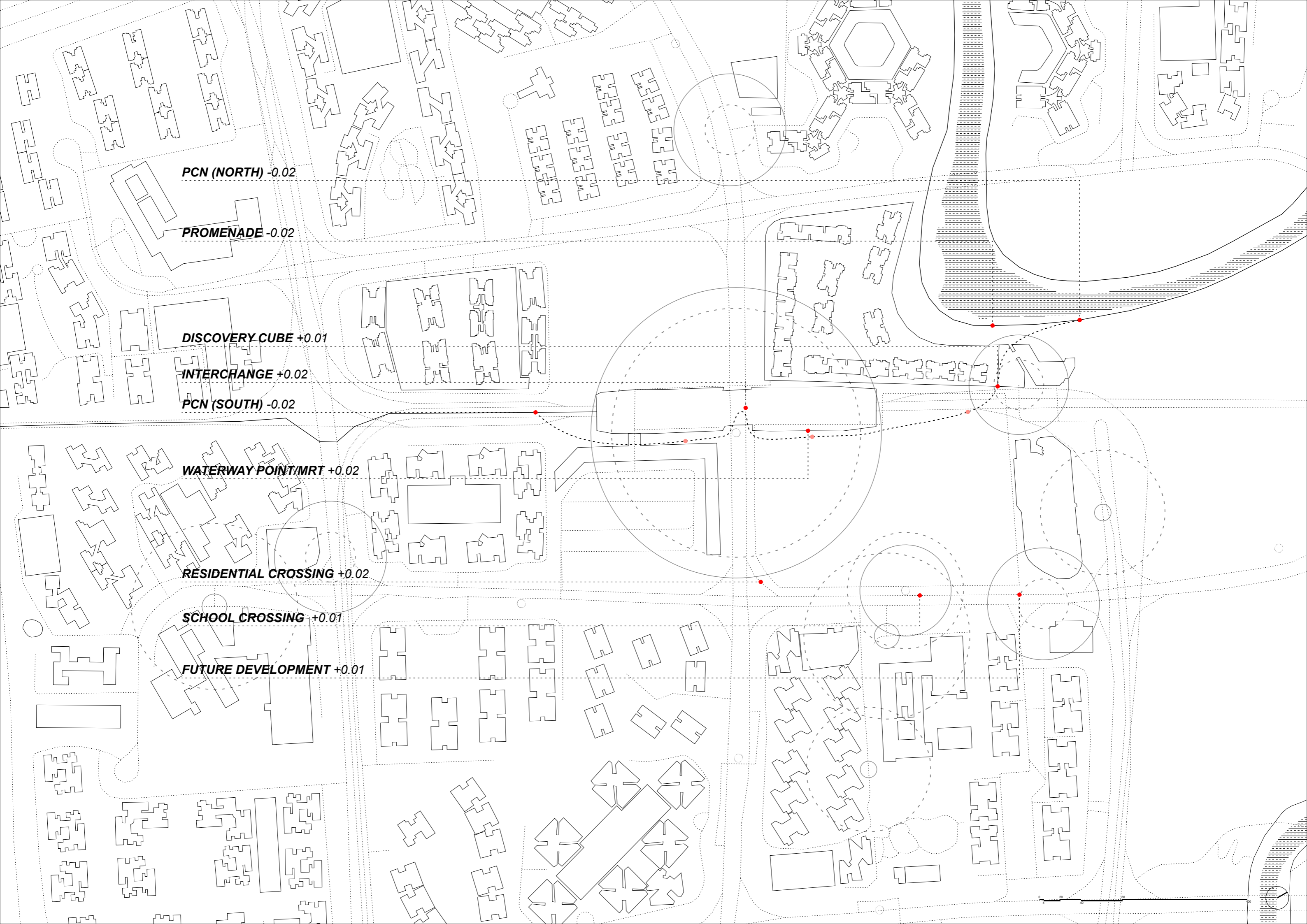

PCN (NORTH) -0.02

PROMENADE -0.02

DISCOVERY CUBE +0.01

INTERCHANGE +0.02

PCN (SOUTH) -0.02

WATERWAY POINT/MRT +0.02

RESIDENTIAL CROSSING +0.02

SCHOOL CROSSING +0.01

FUTURE DEVELOPMENT +0.01

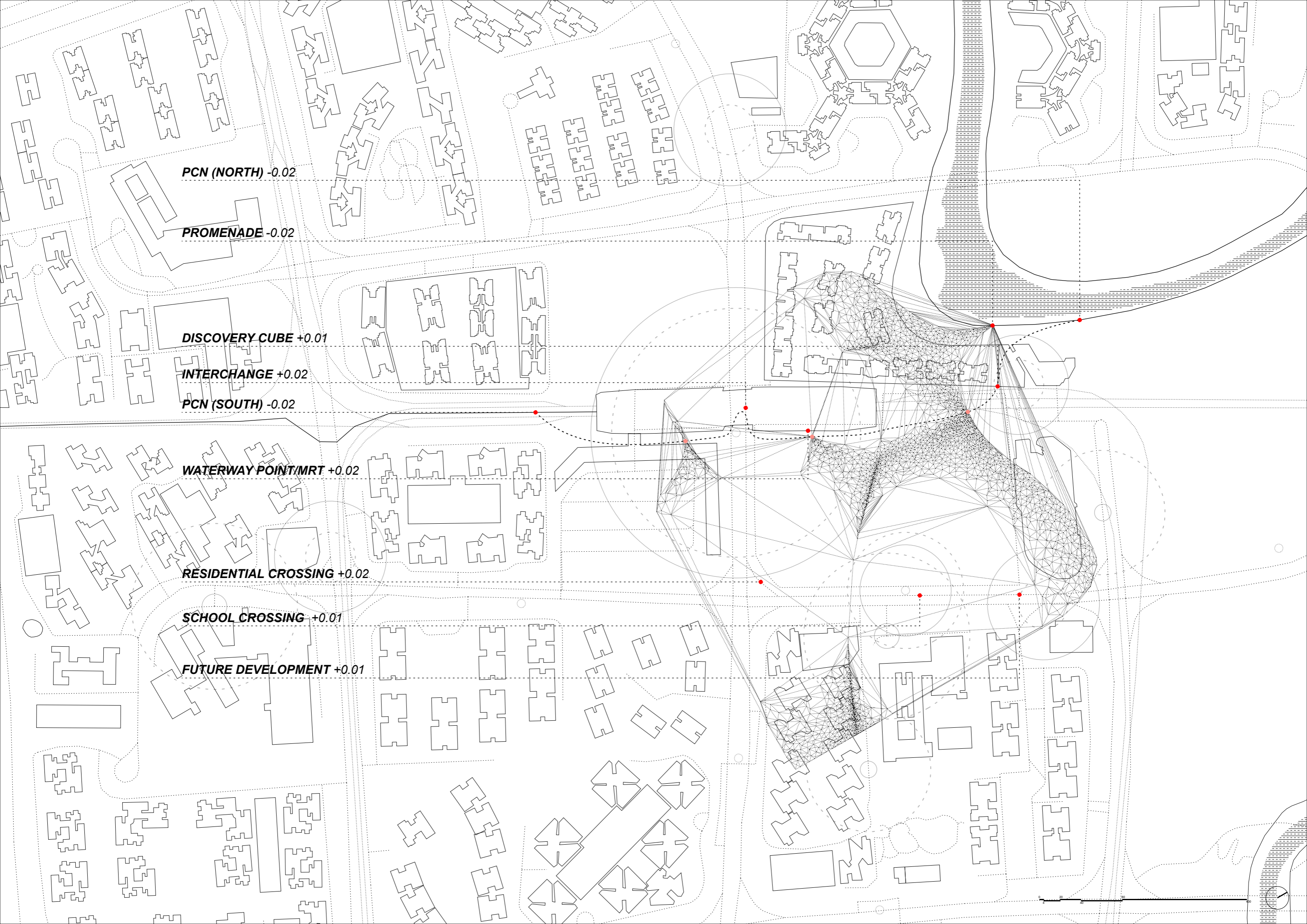

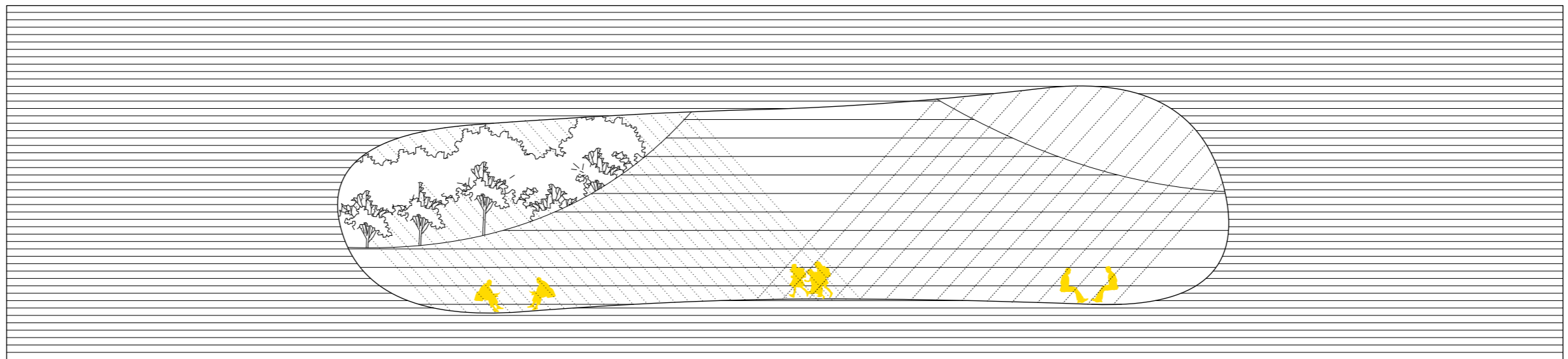
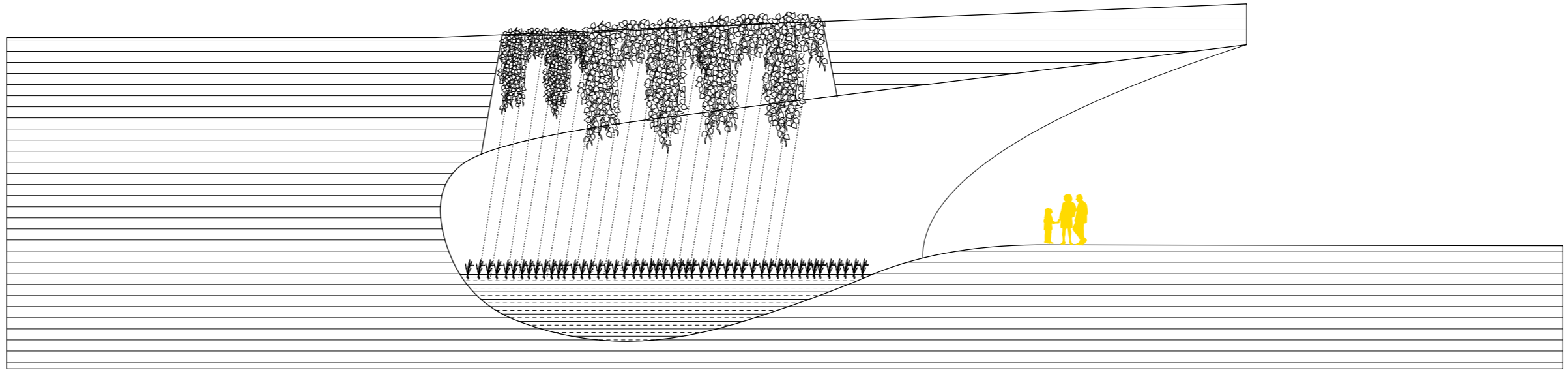

CONNECTIONS BETWEEN STALLS

- Noodles; Drinks; Curry
- Others

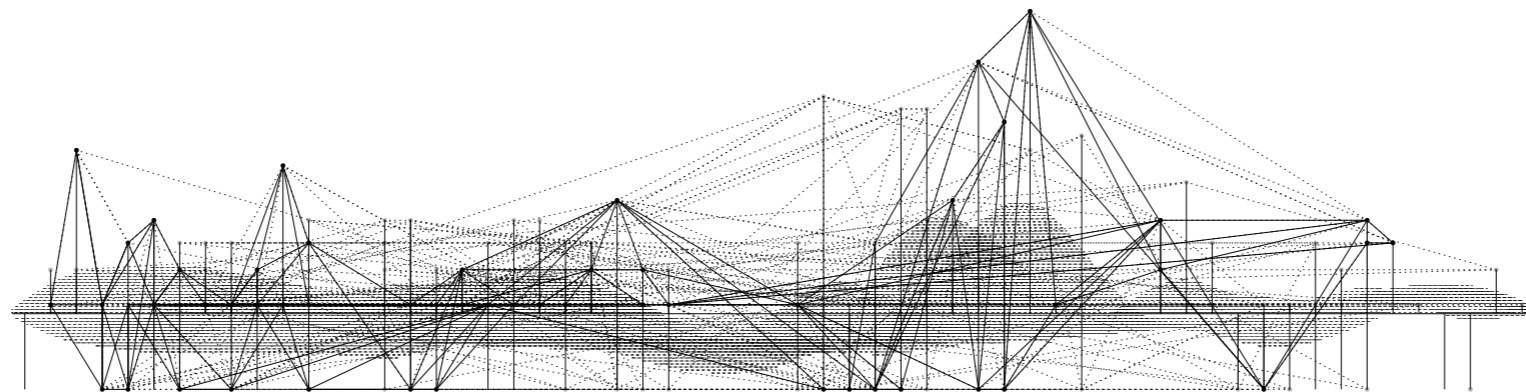
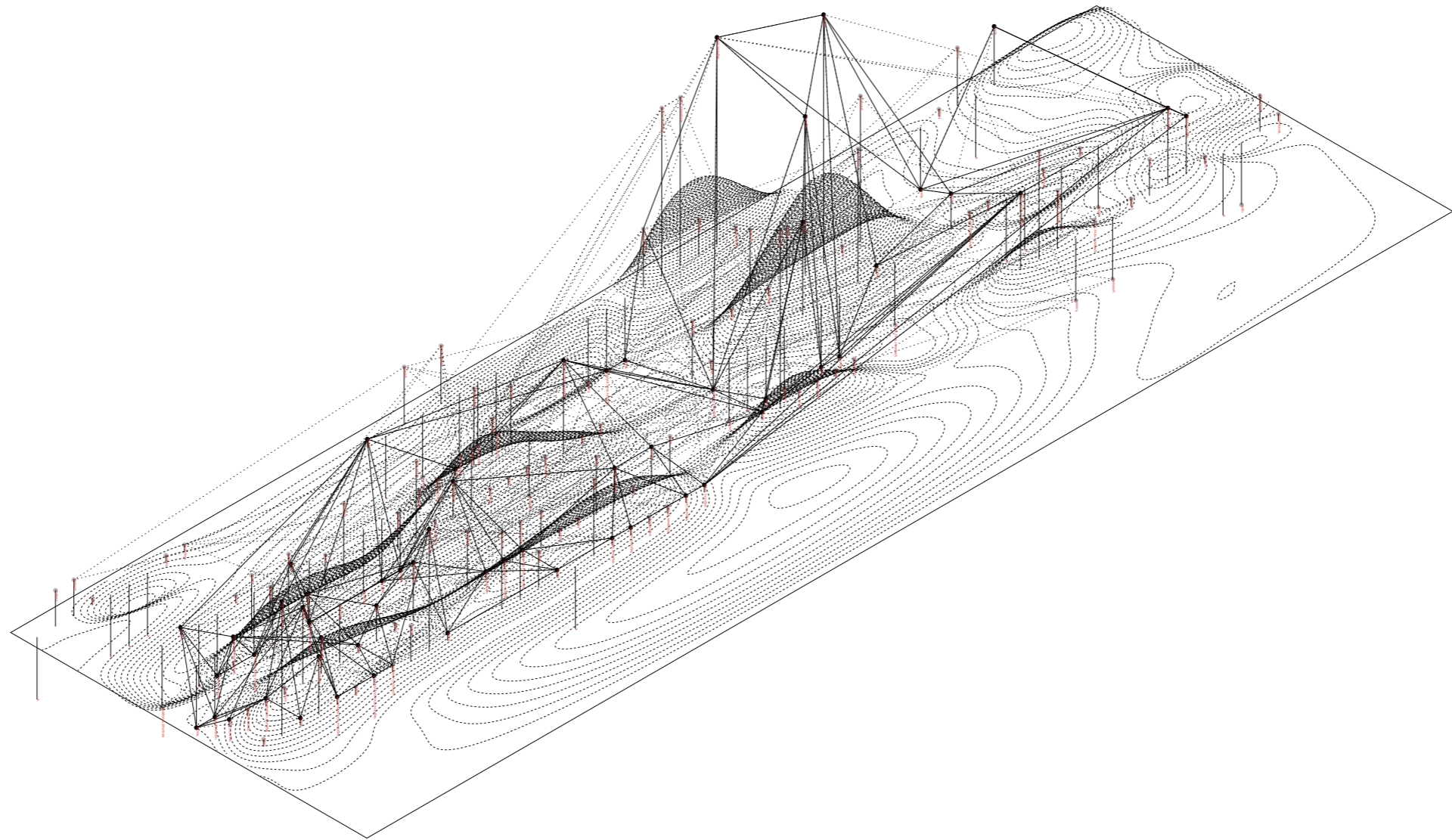

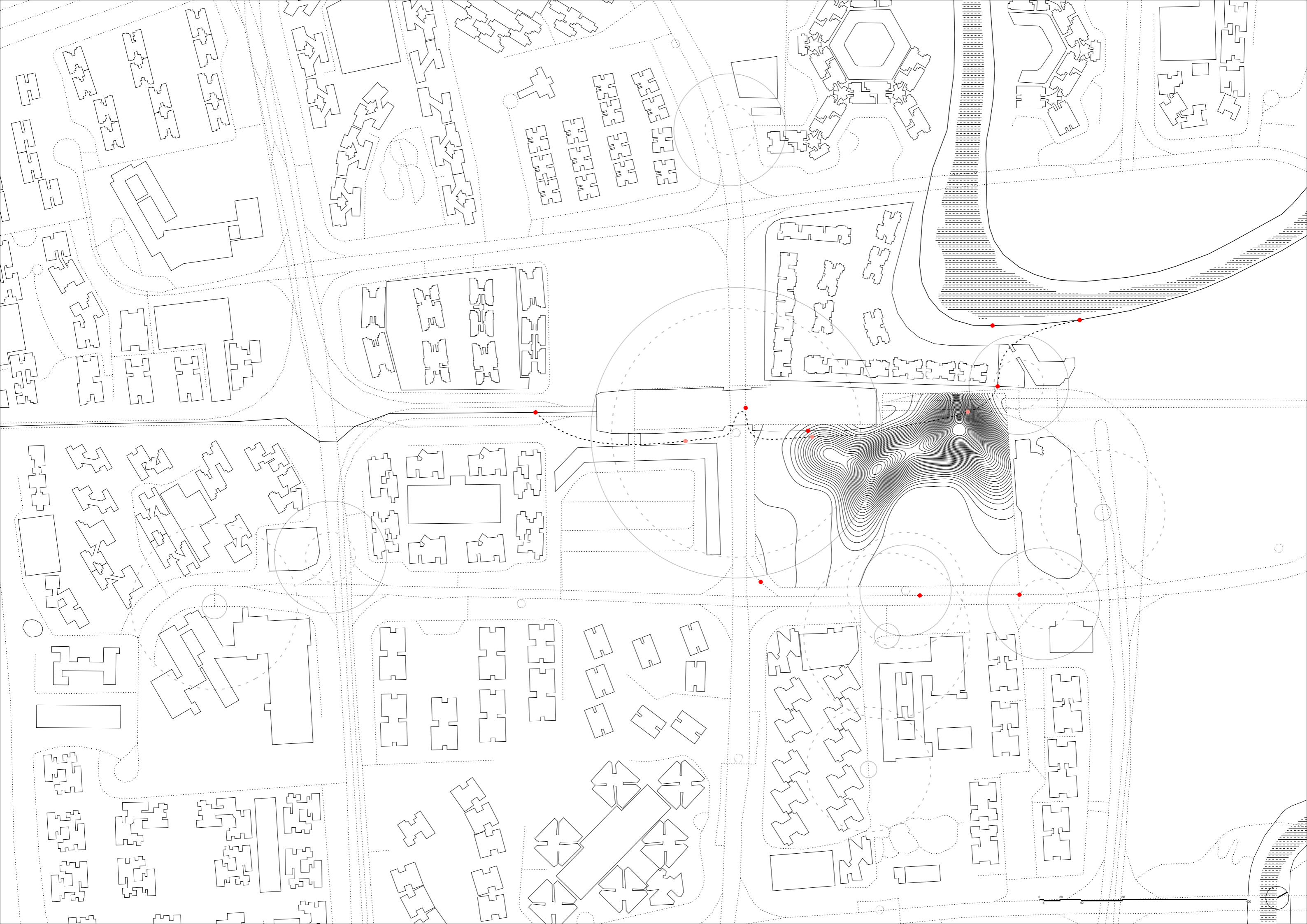

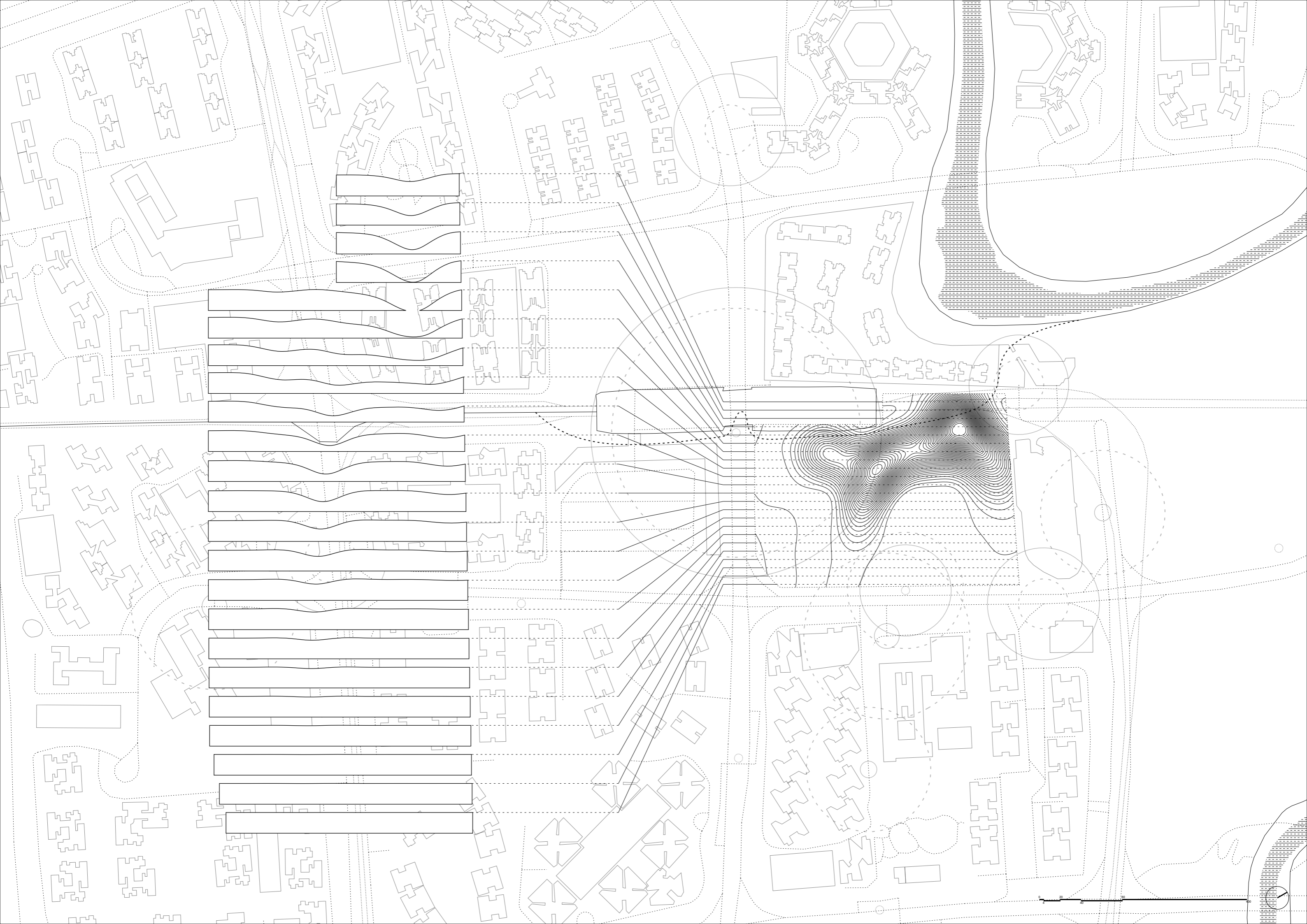

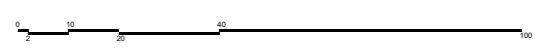
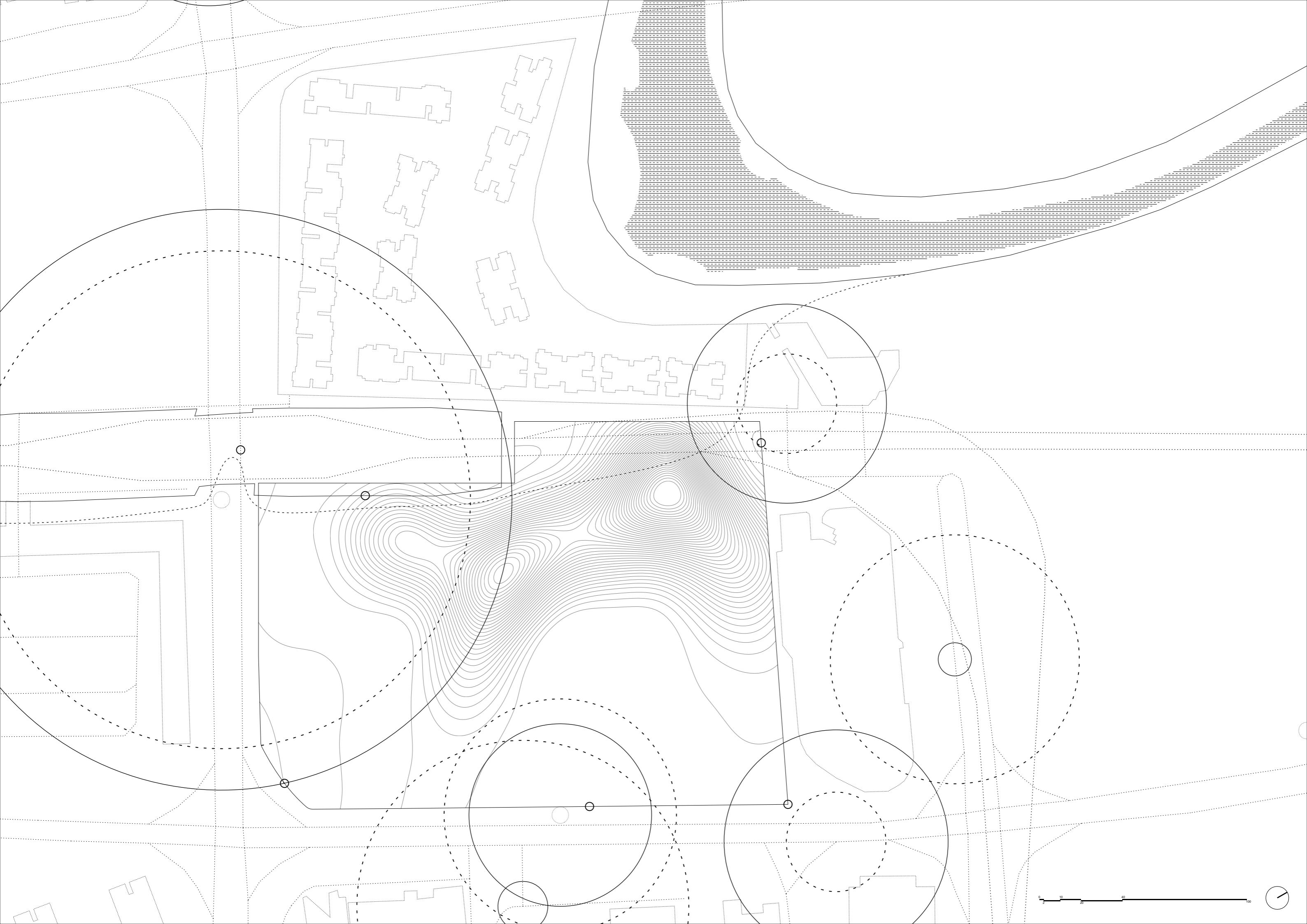

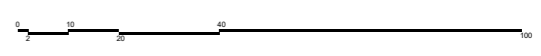
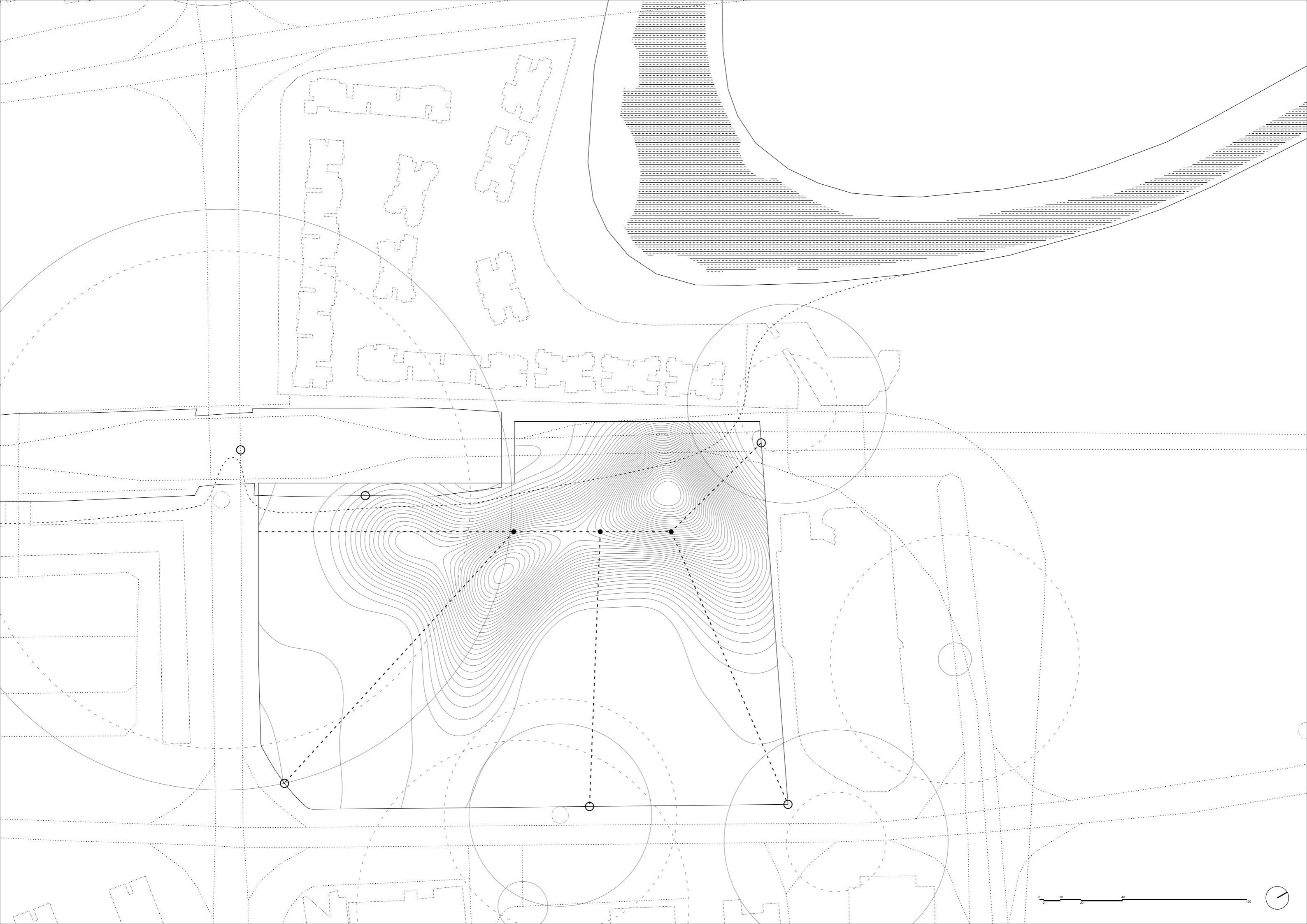

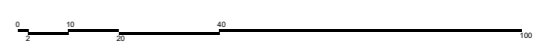
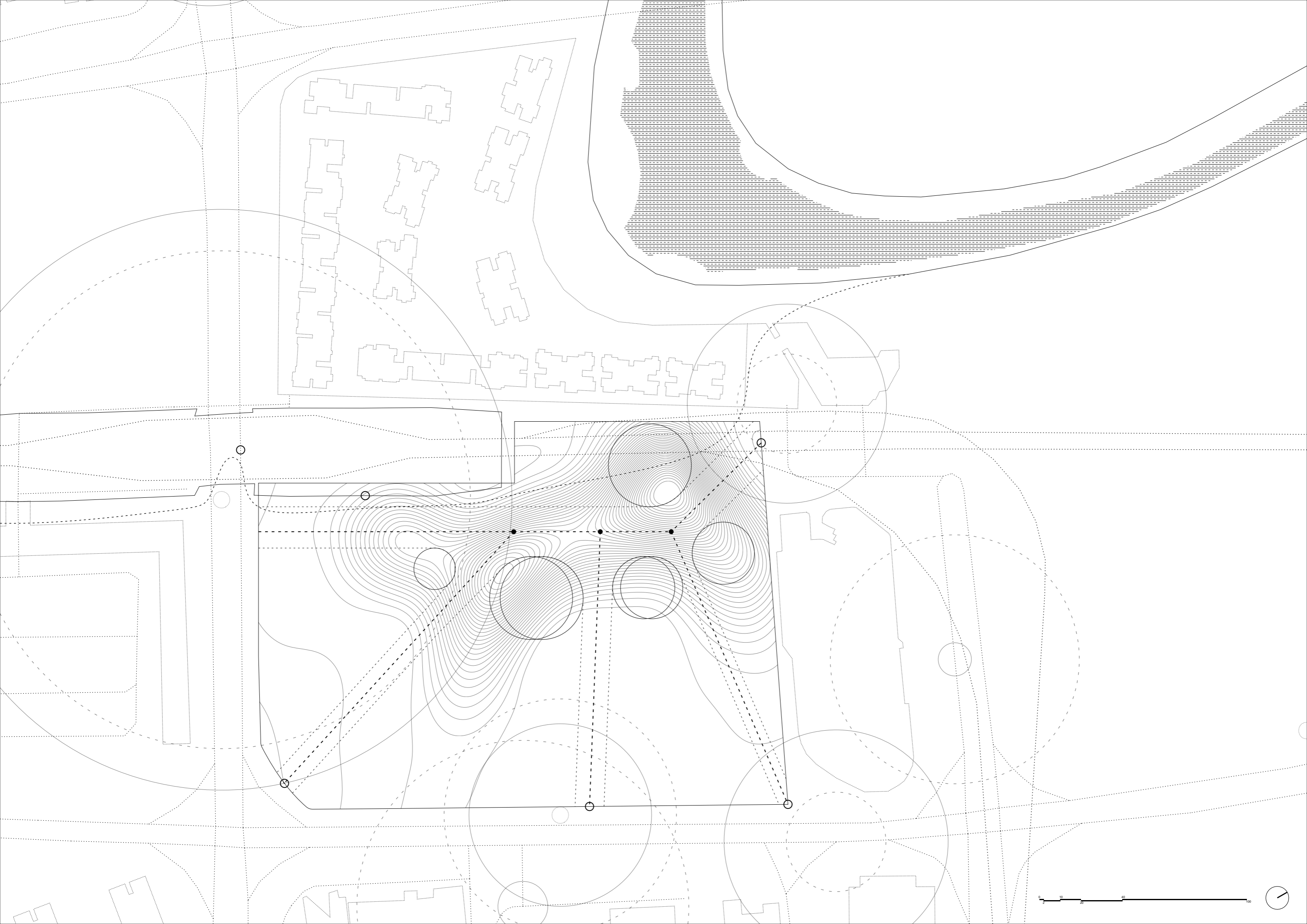

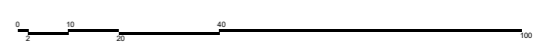
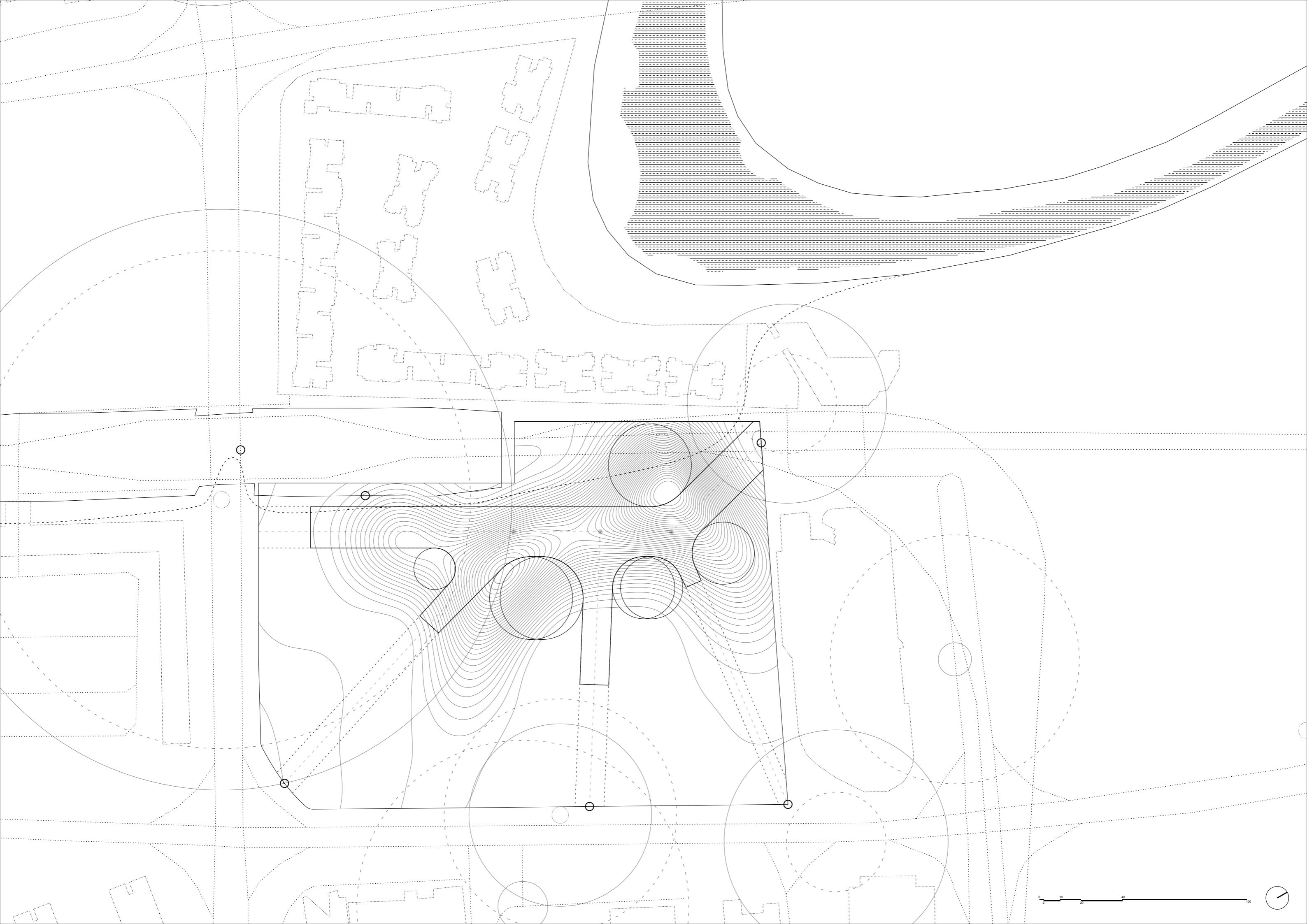

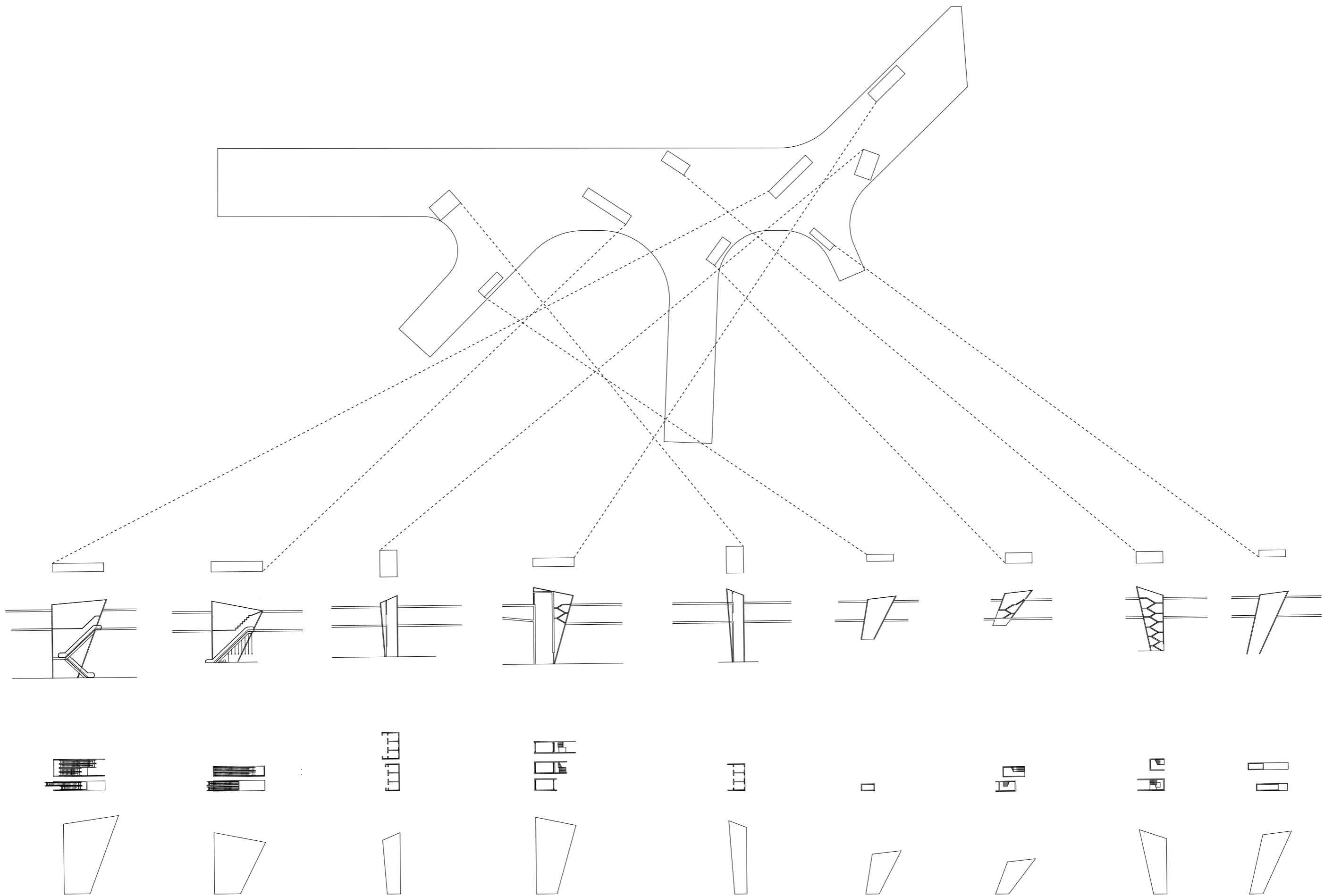

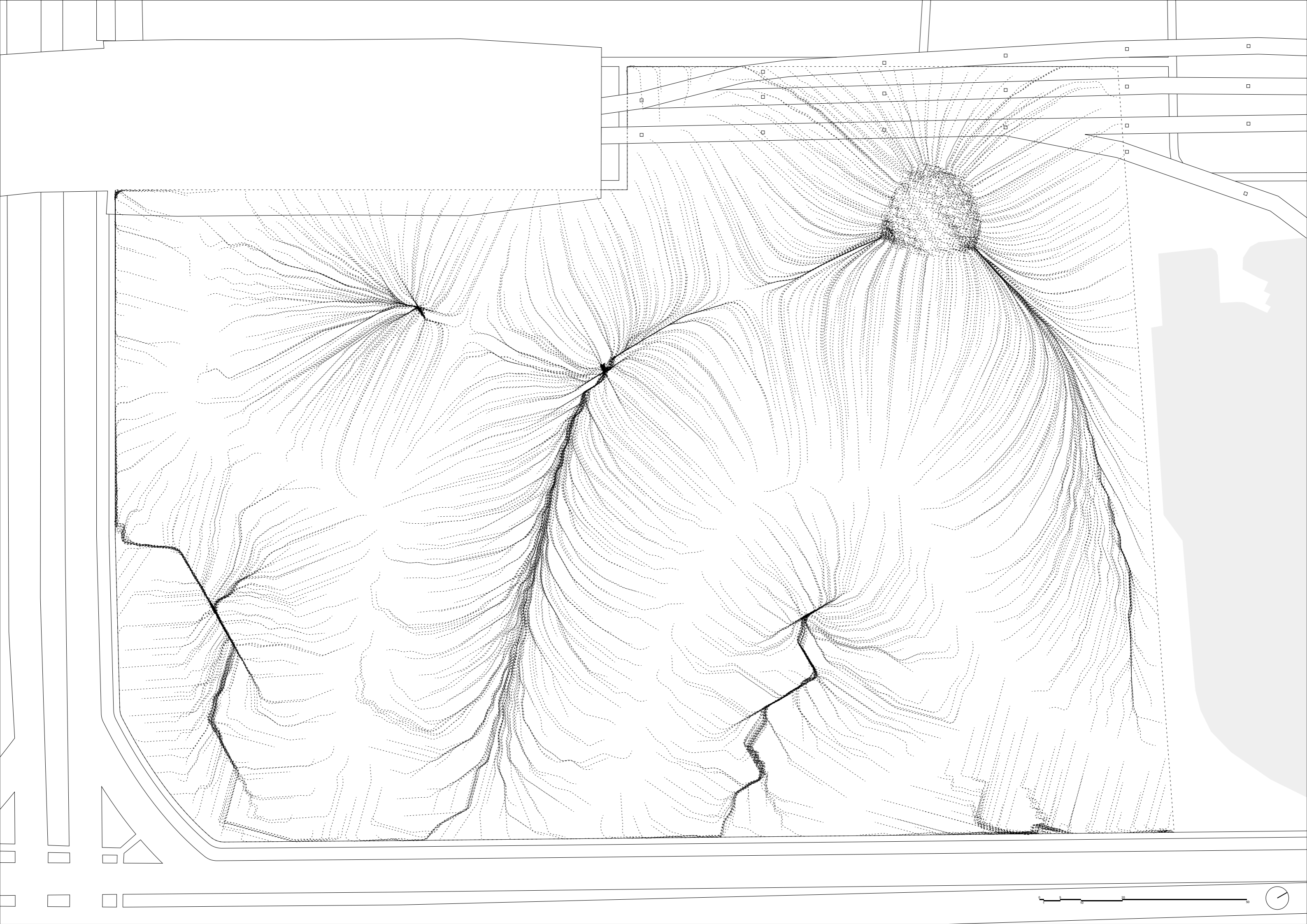

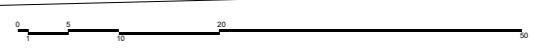
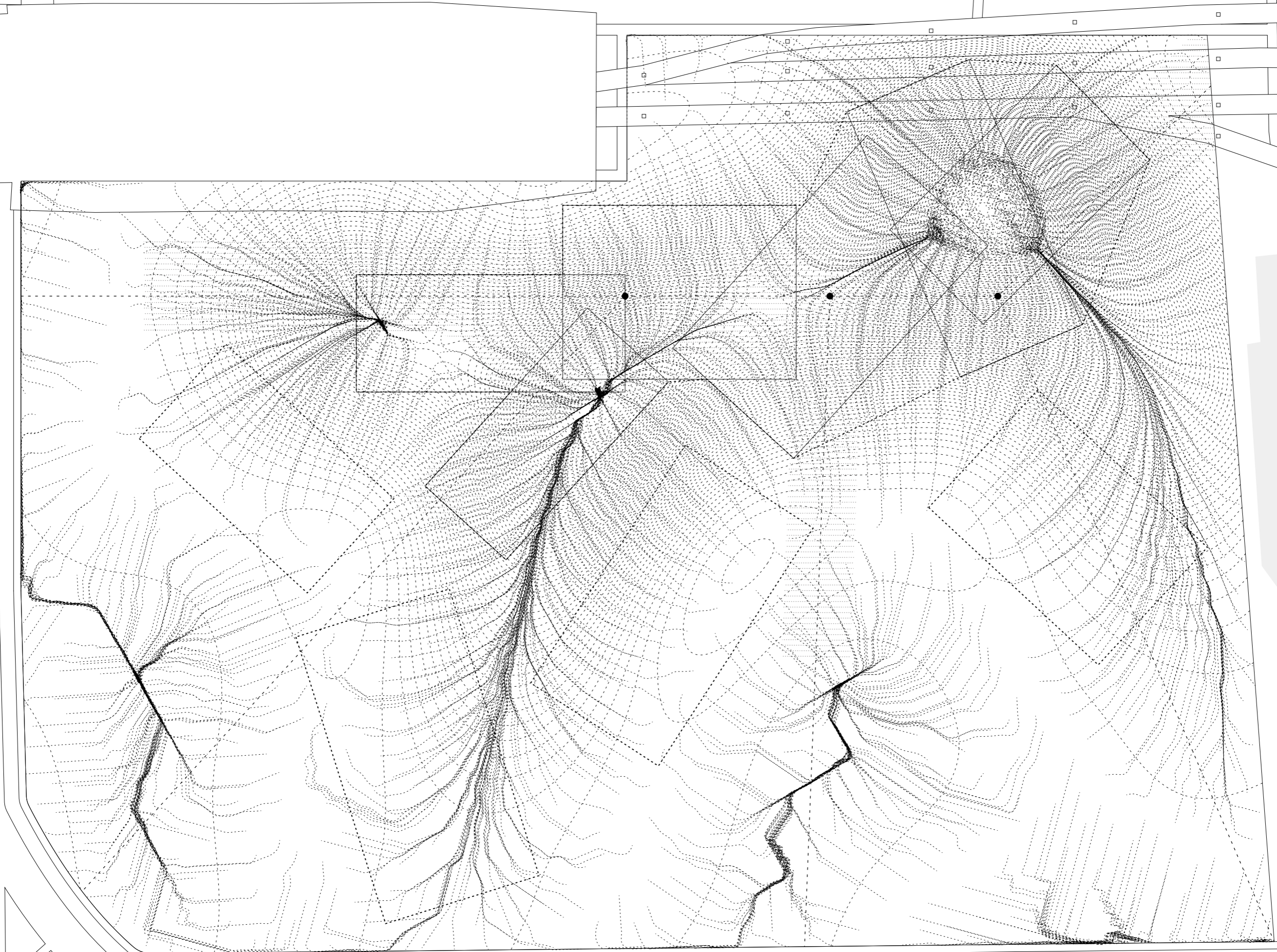

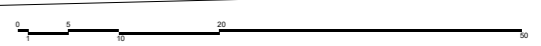
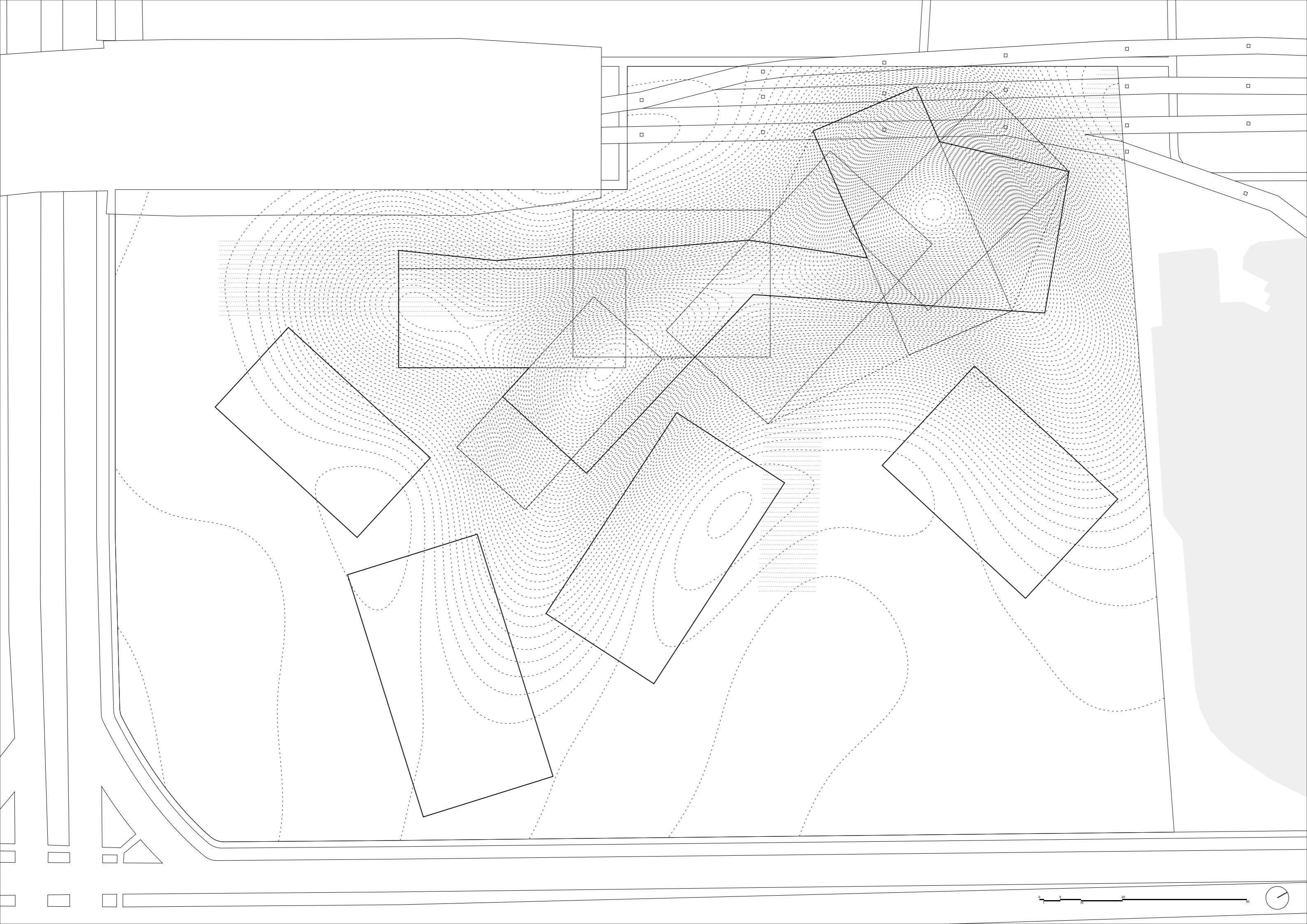

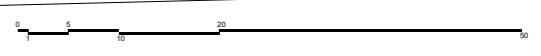
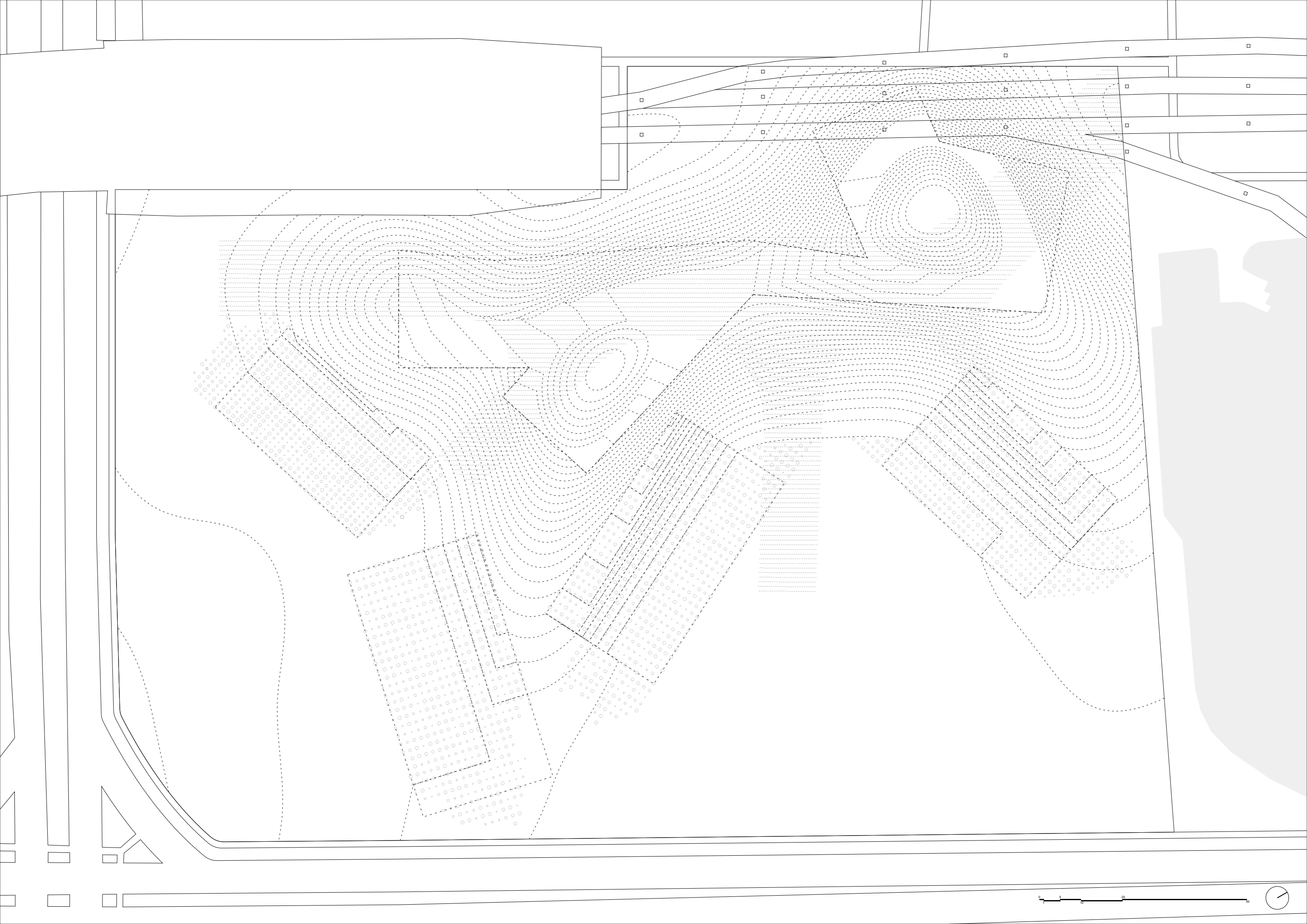

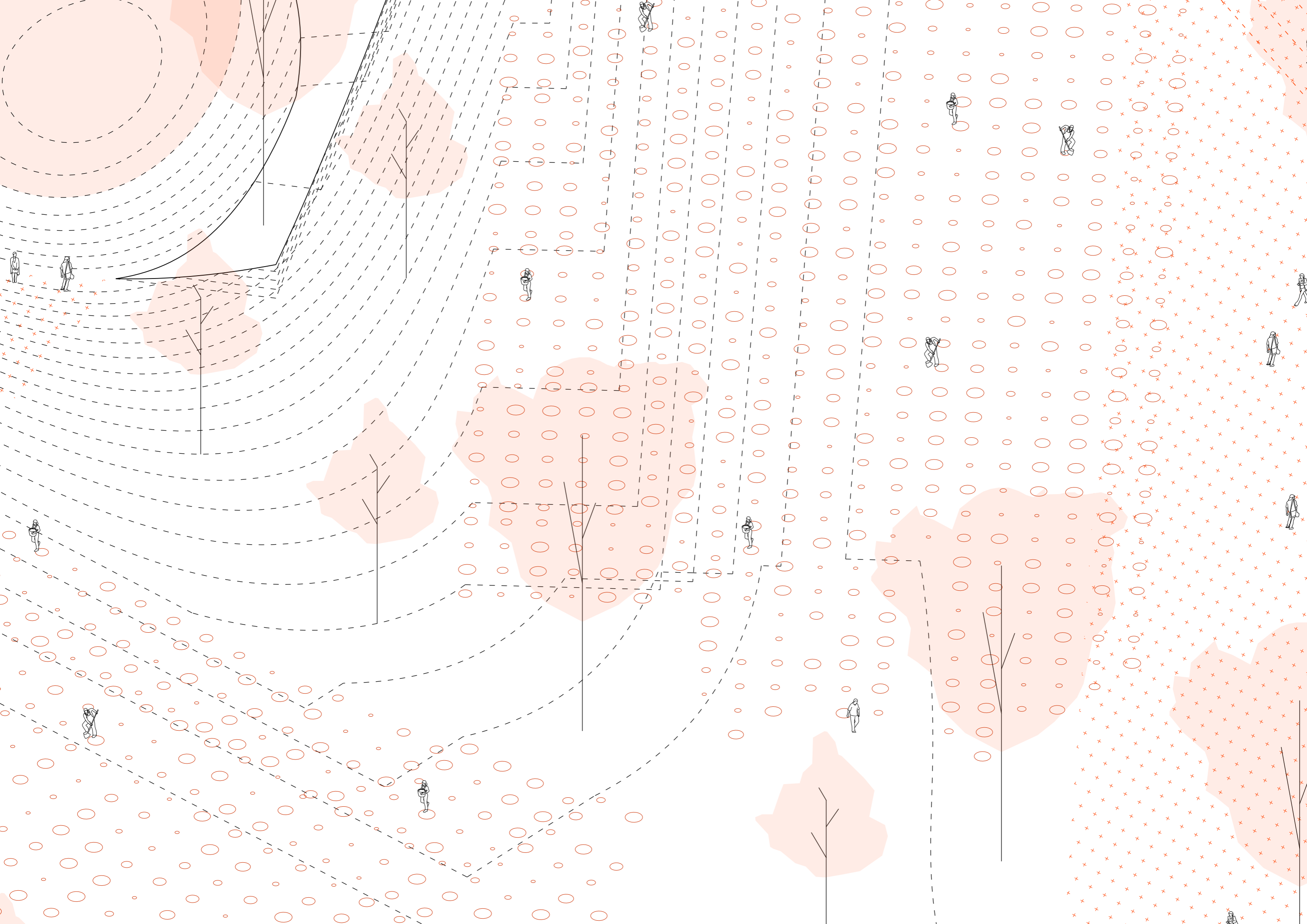

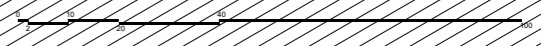
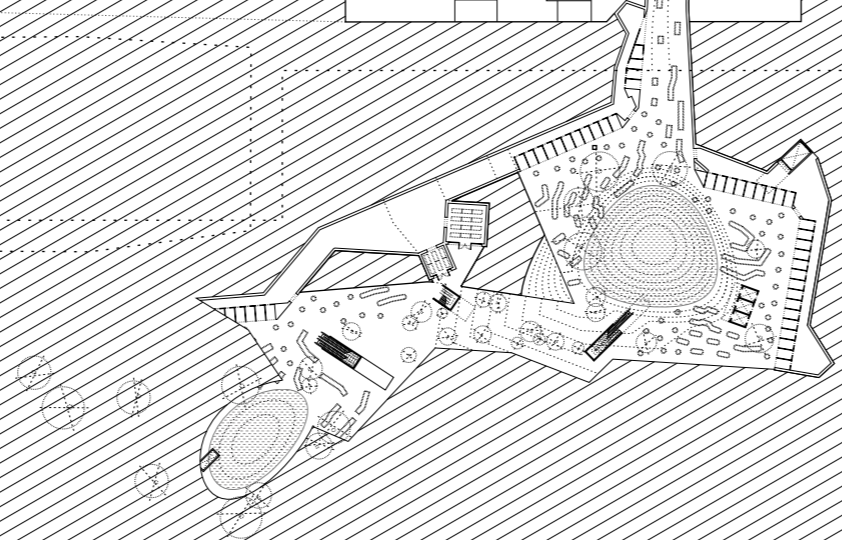

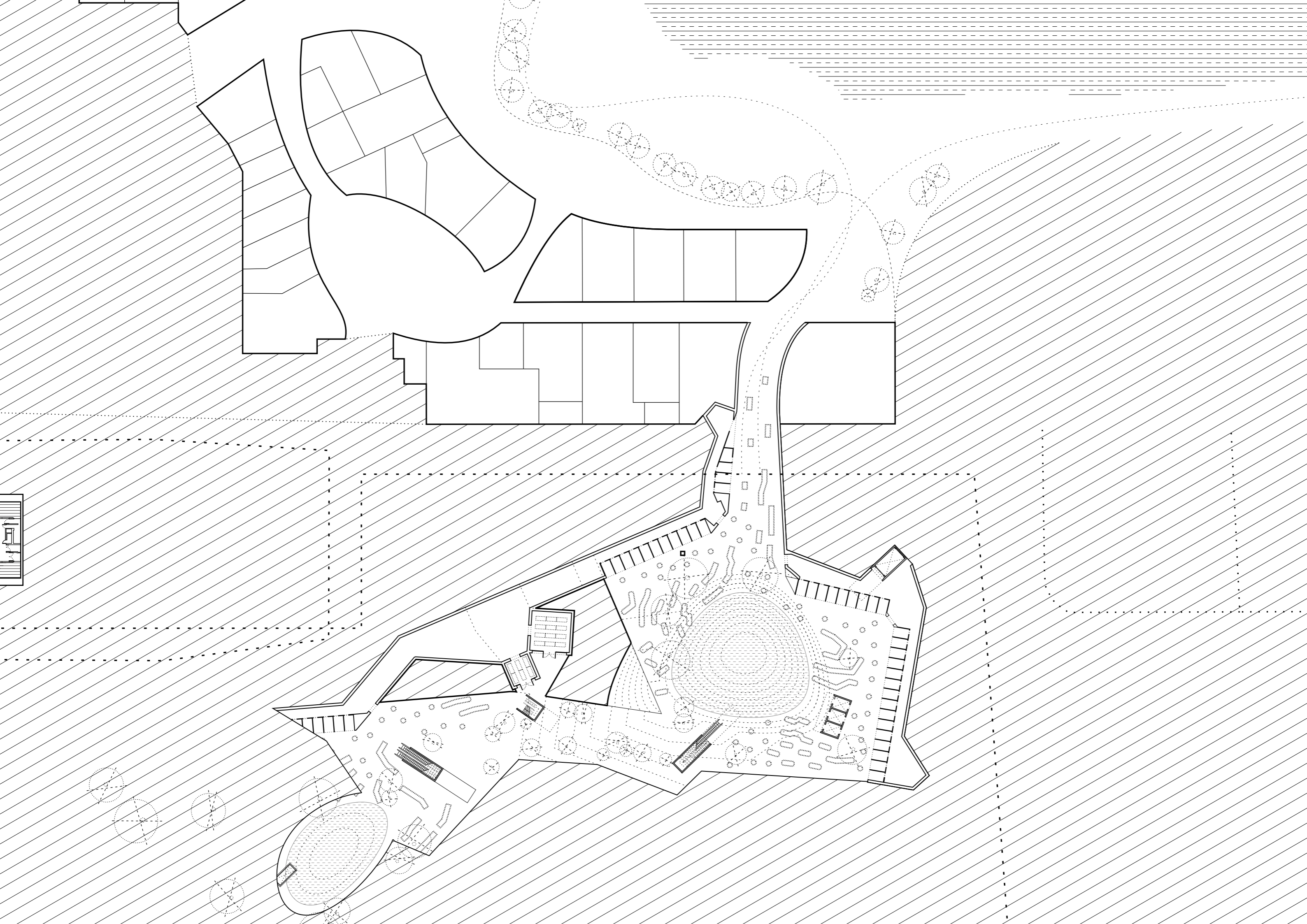

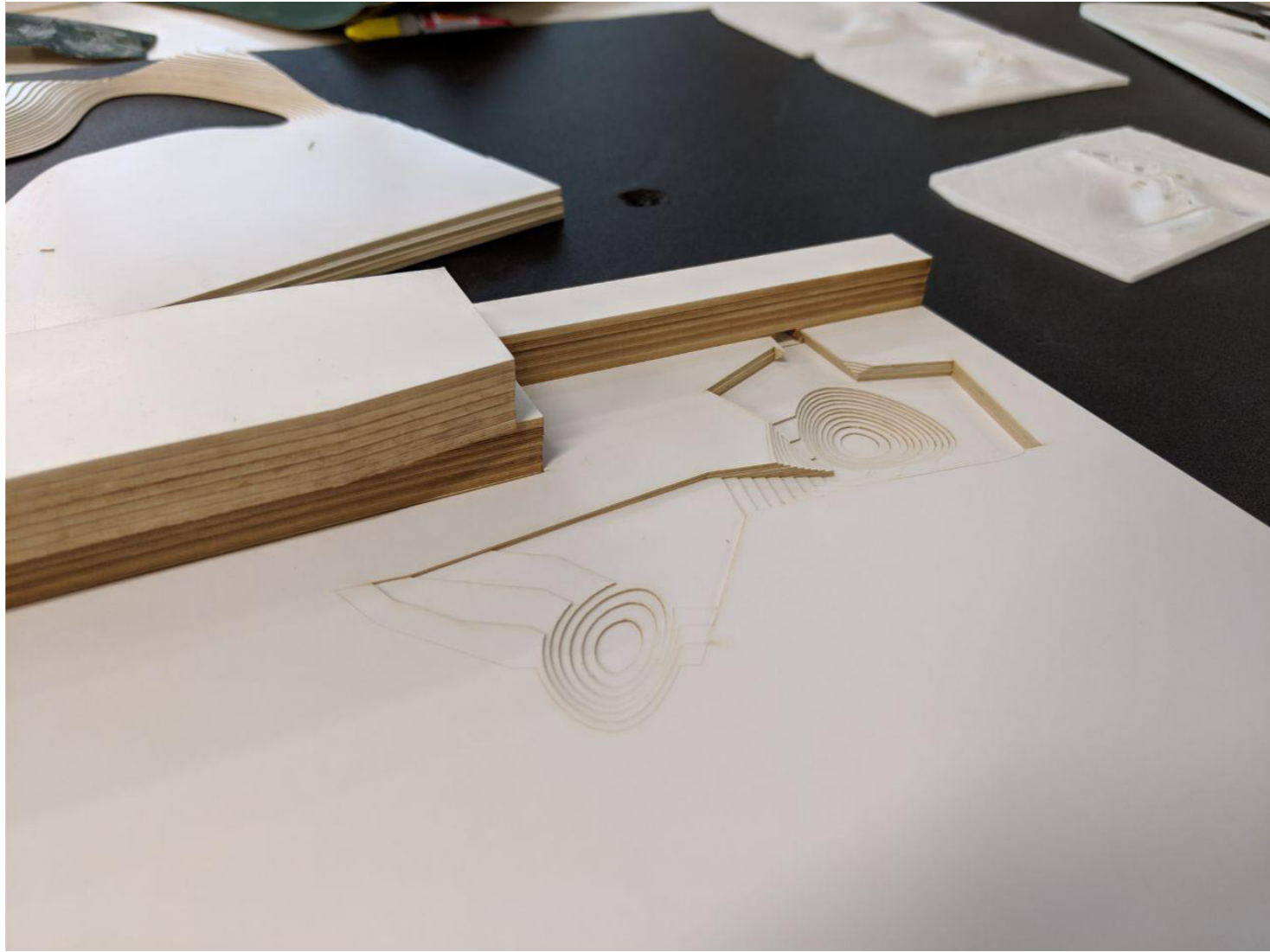

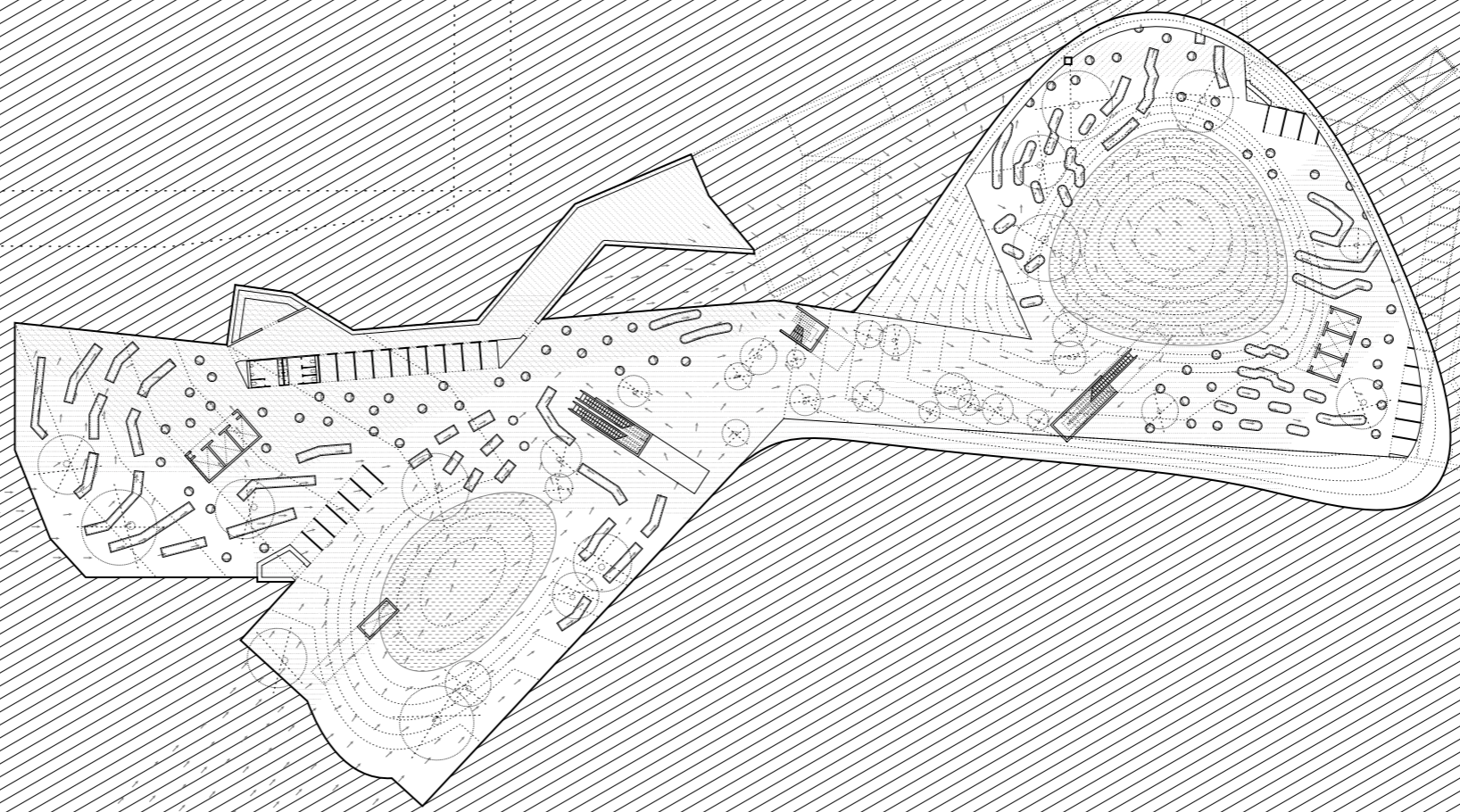
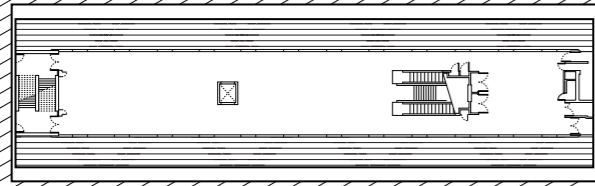

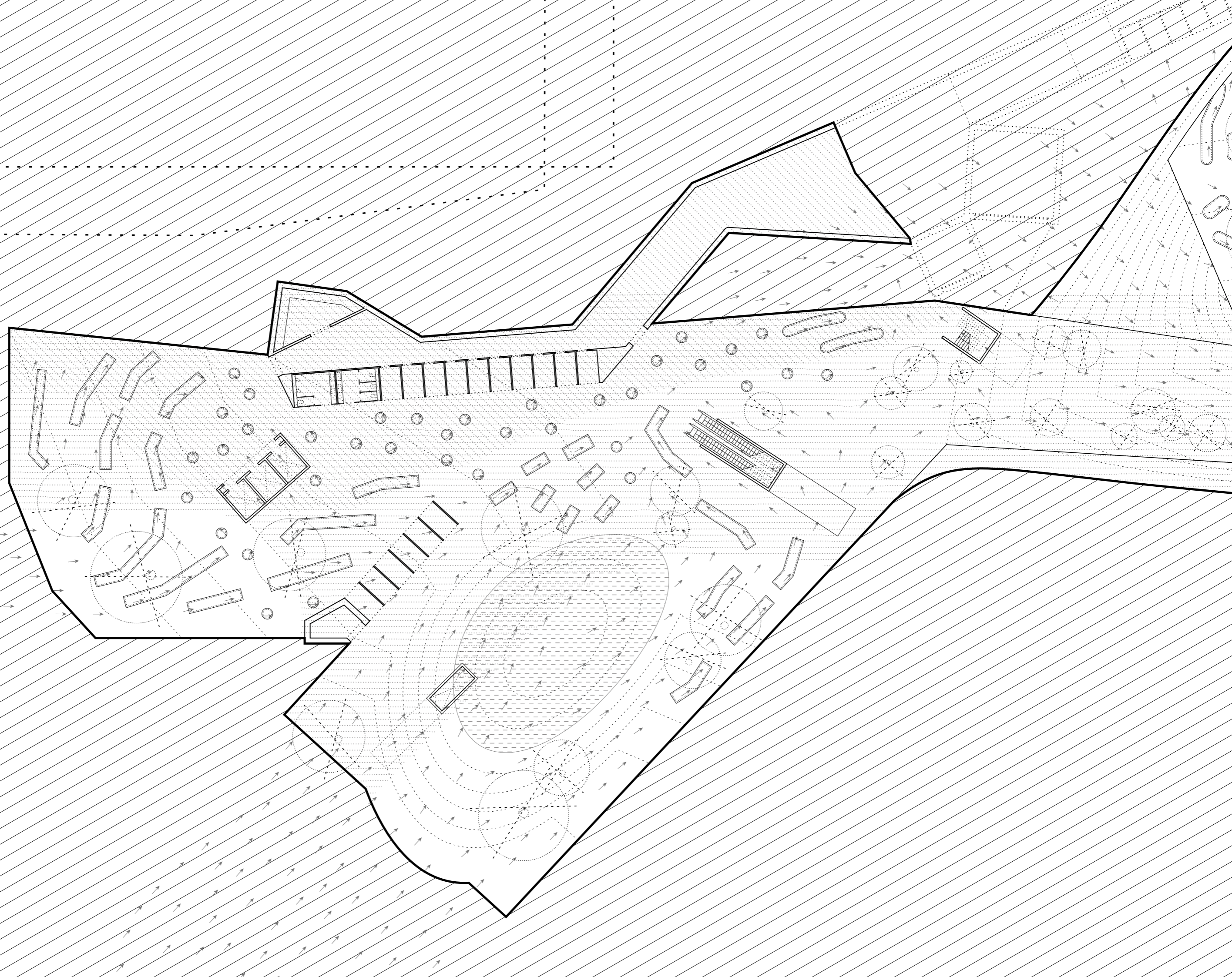
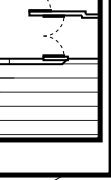

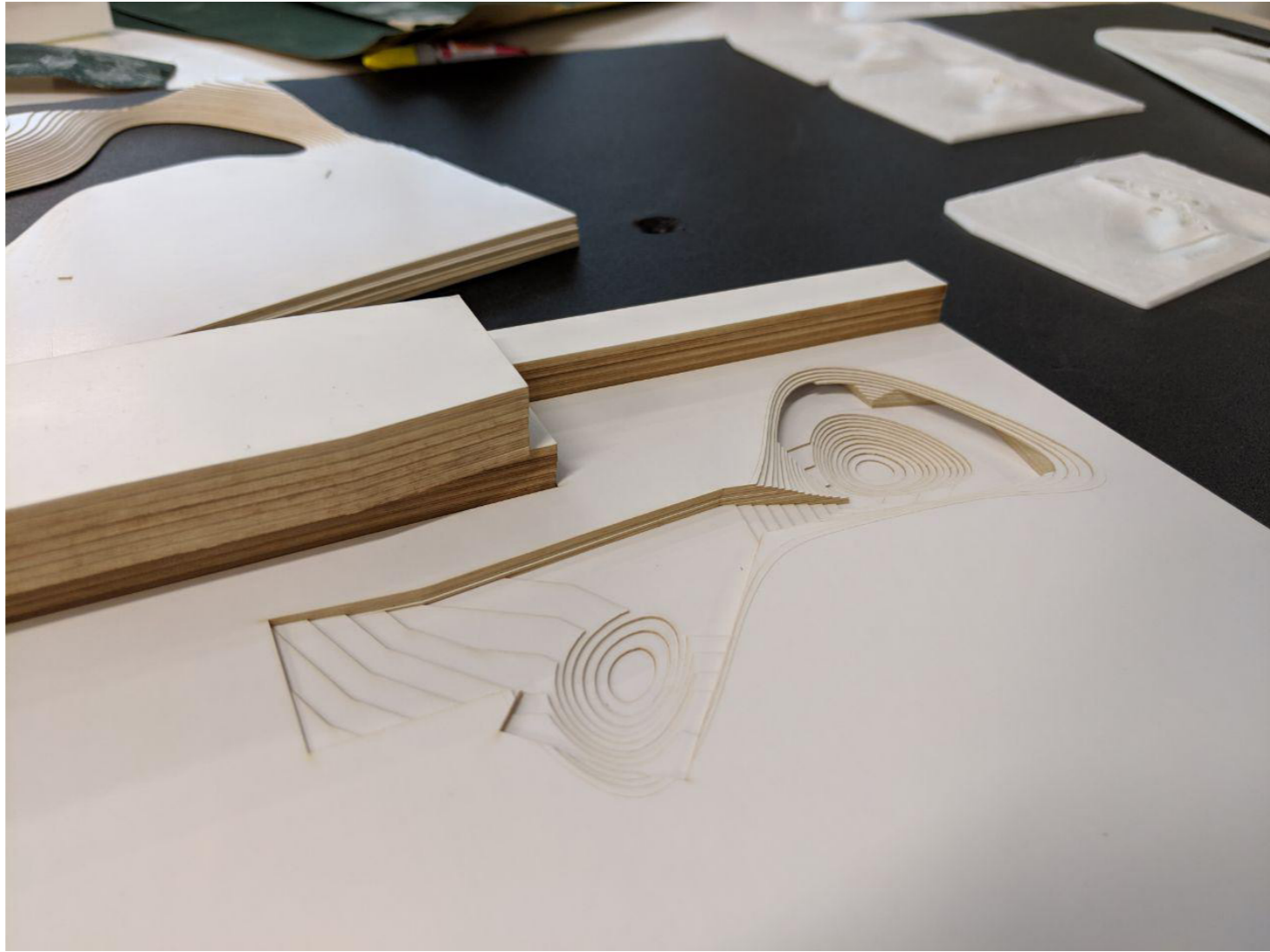

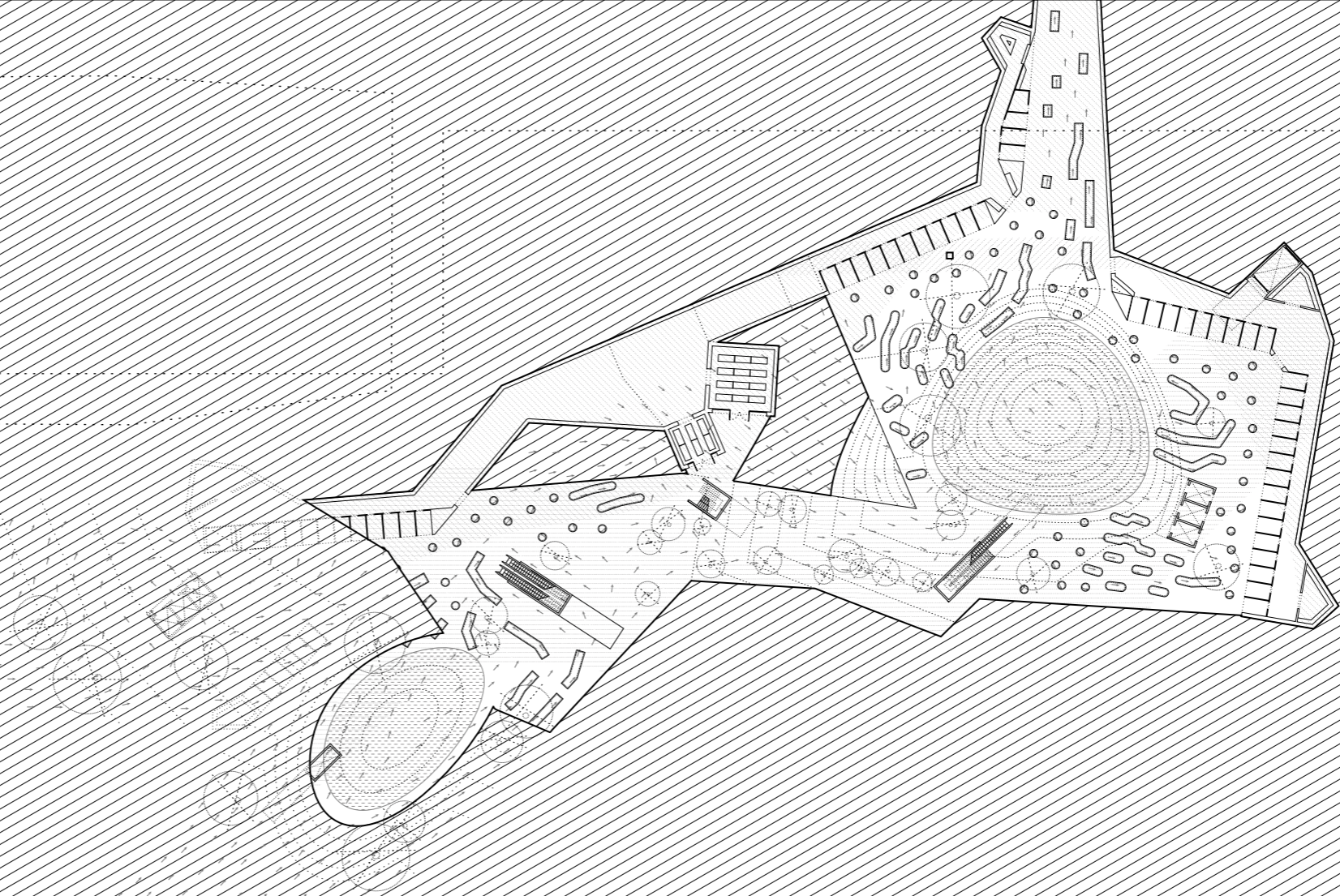
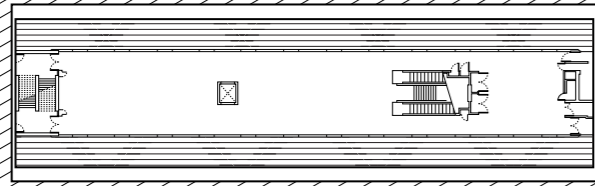

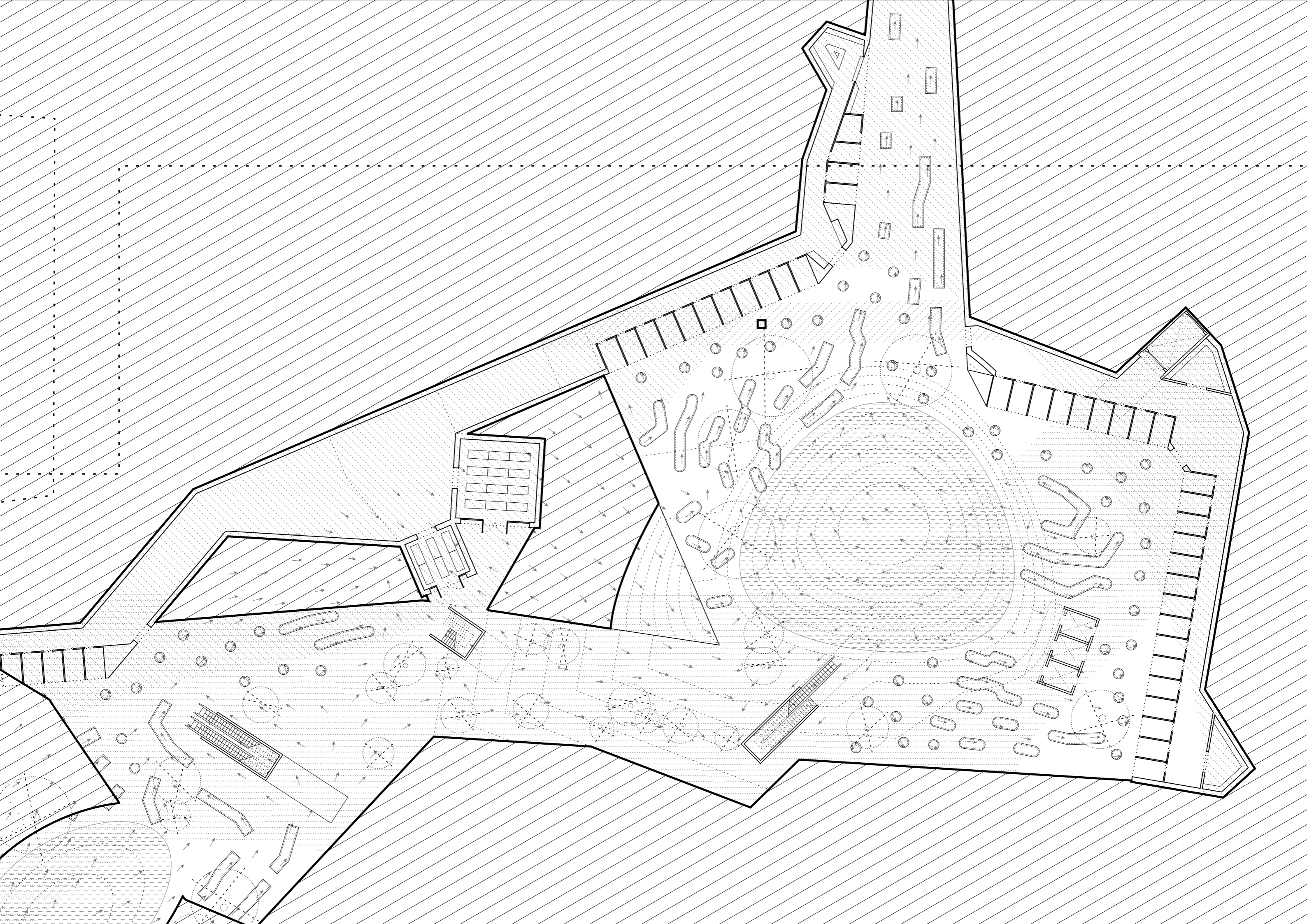

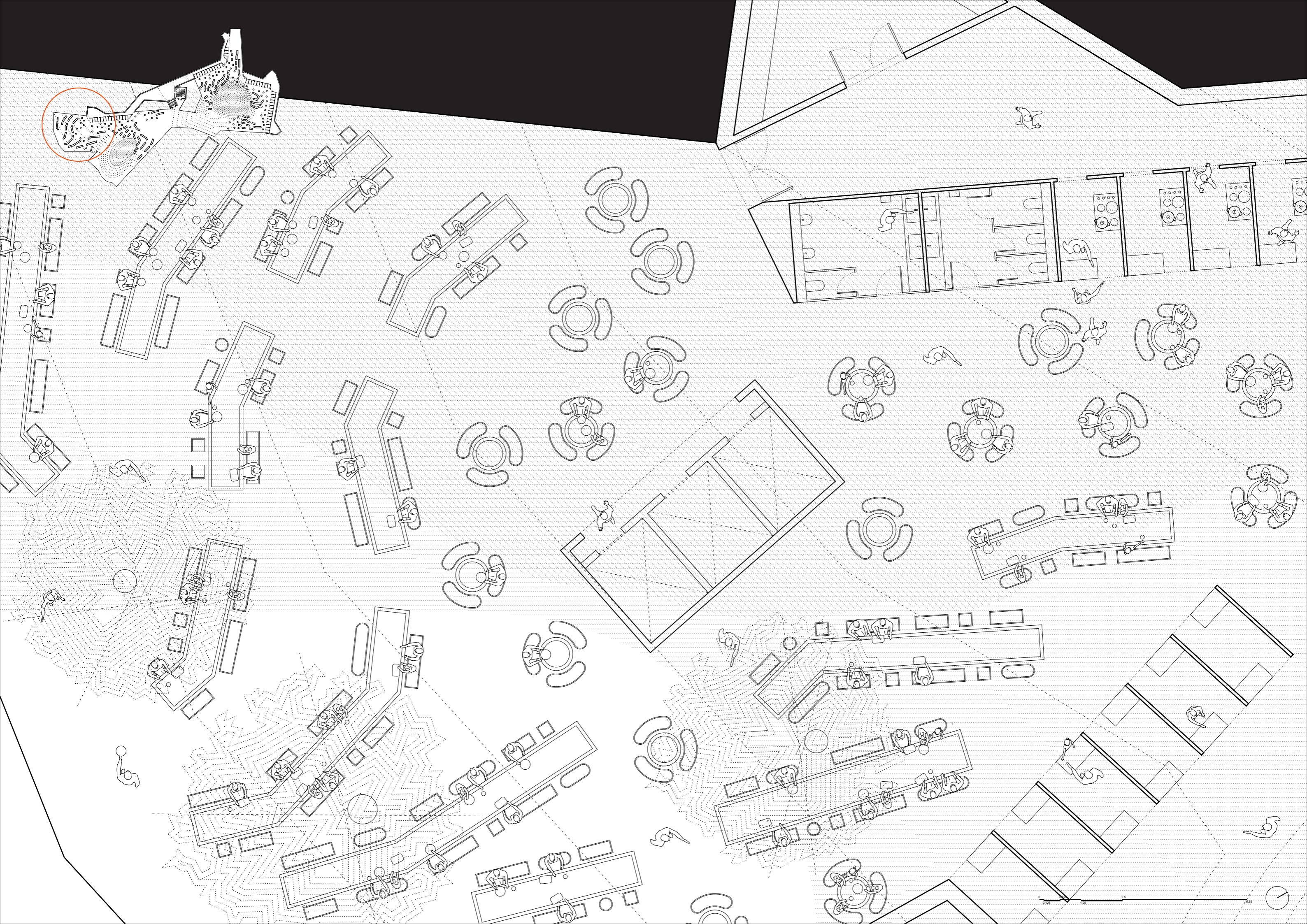

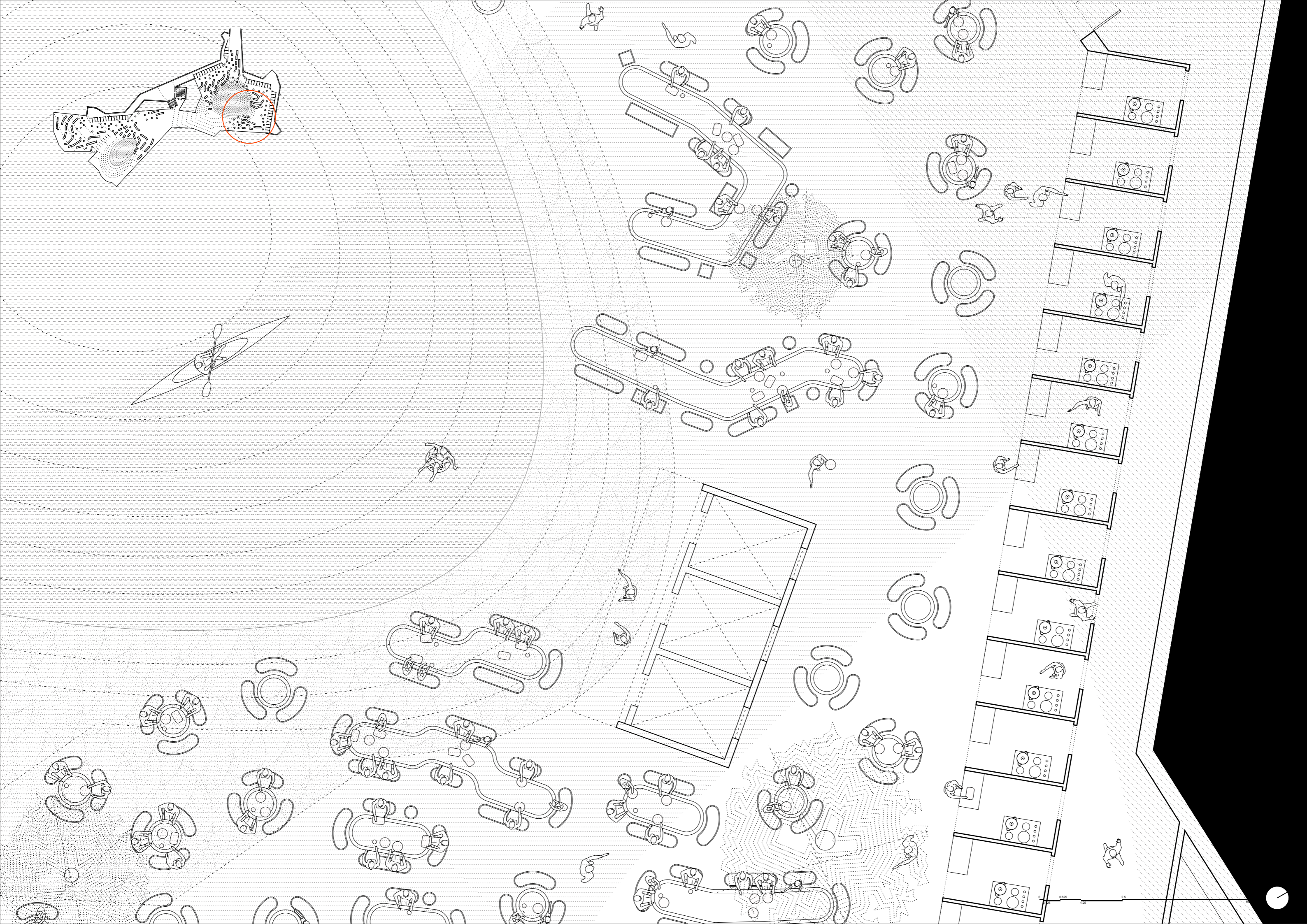
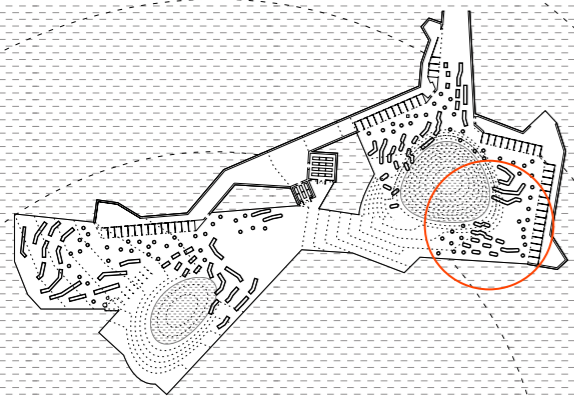

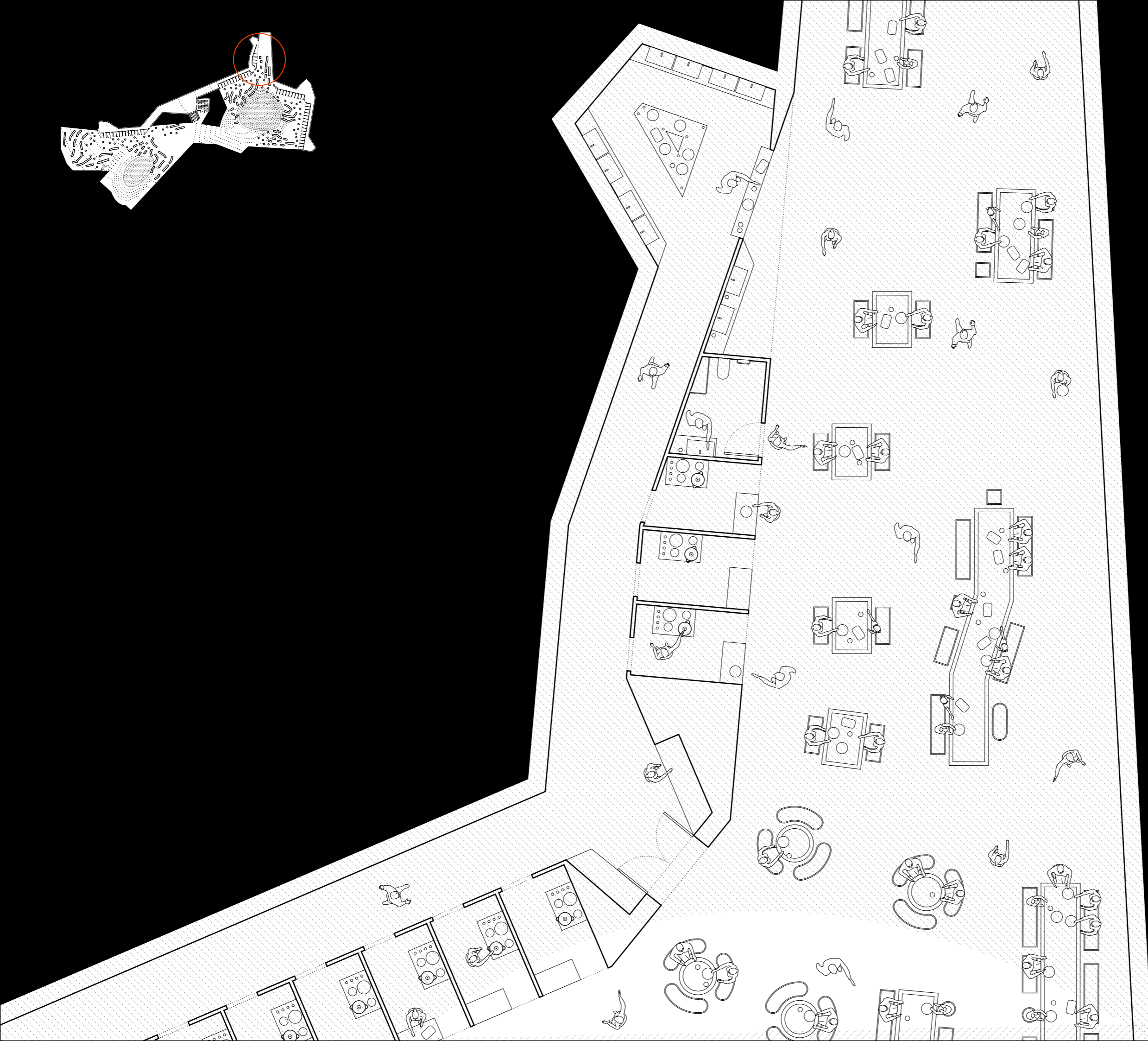
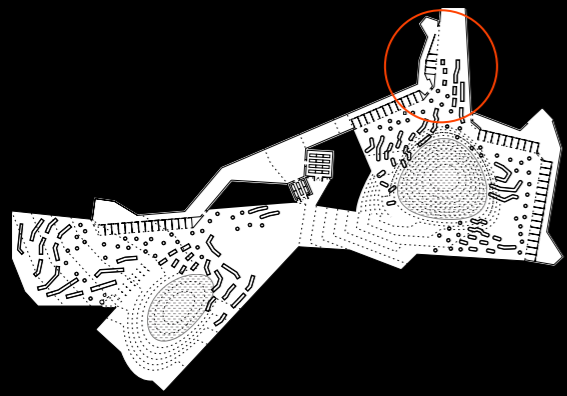

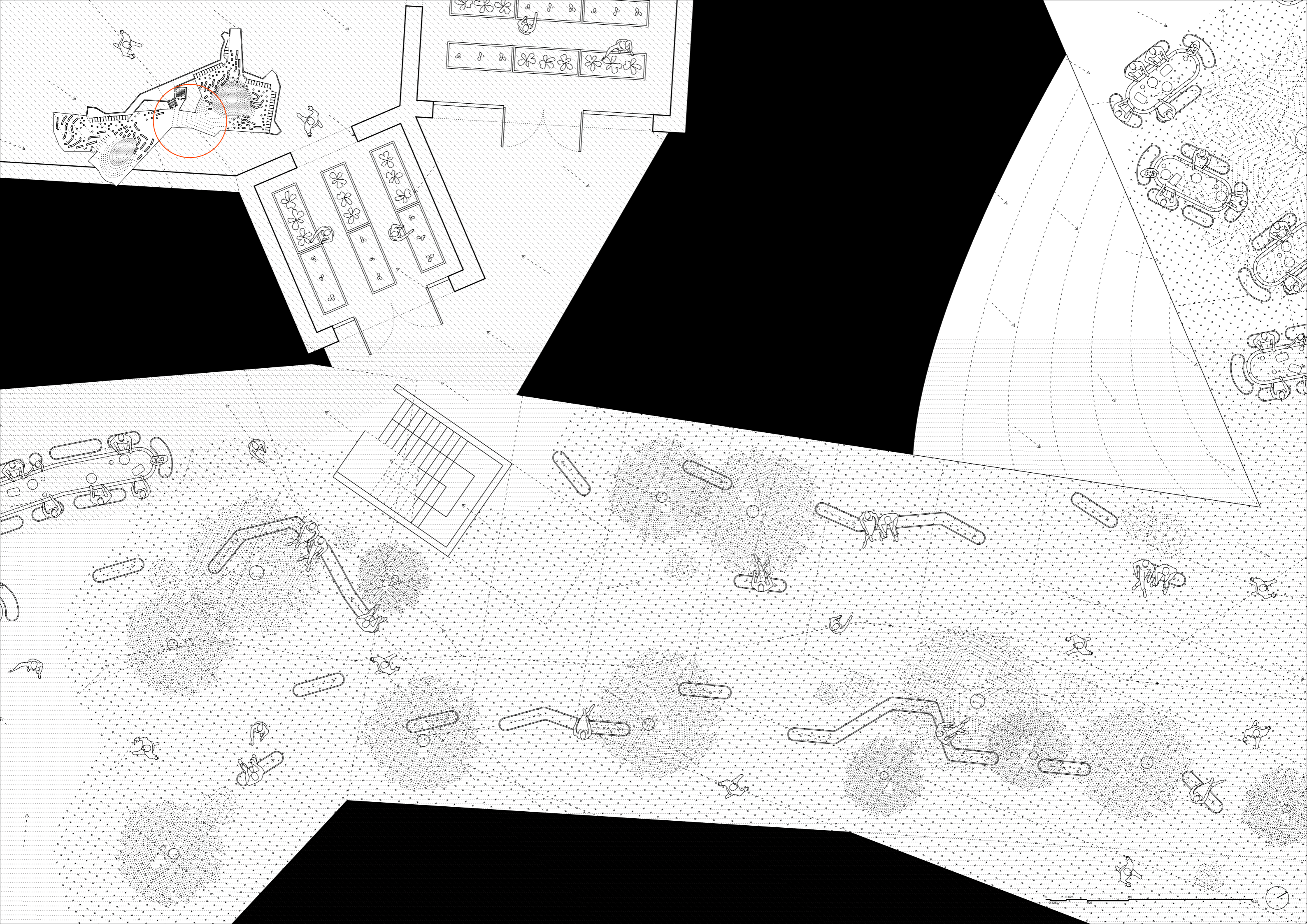



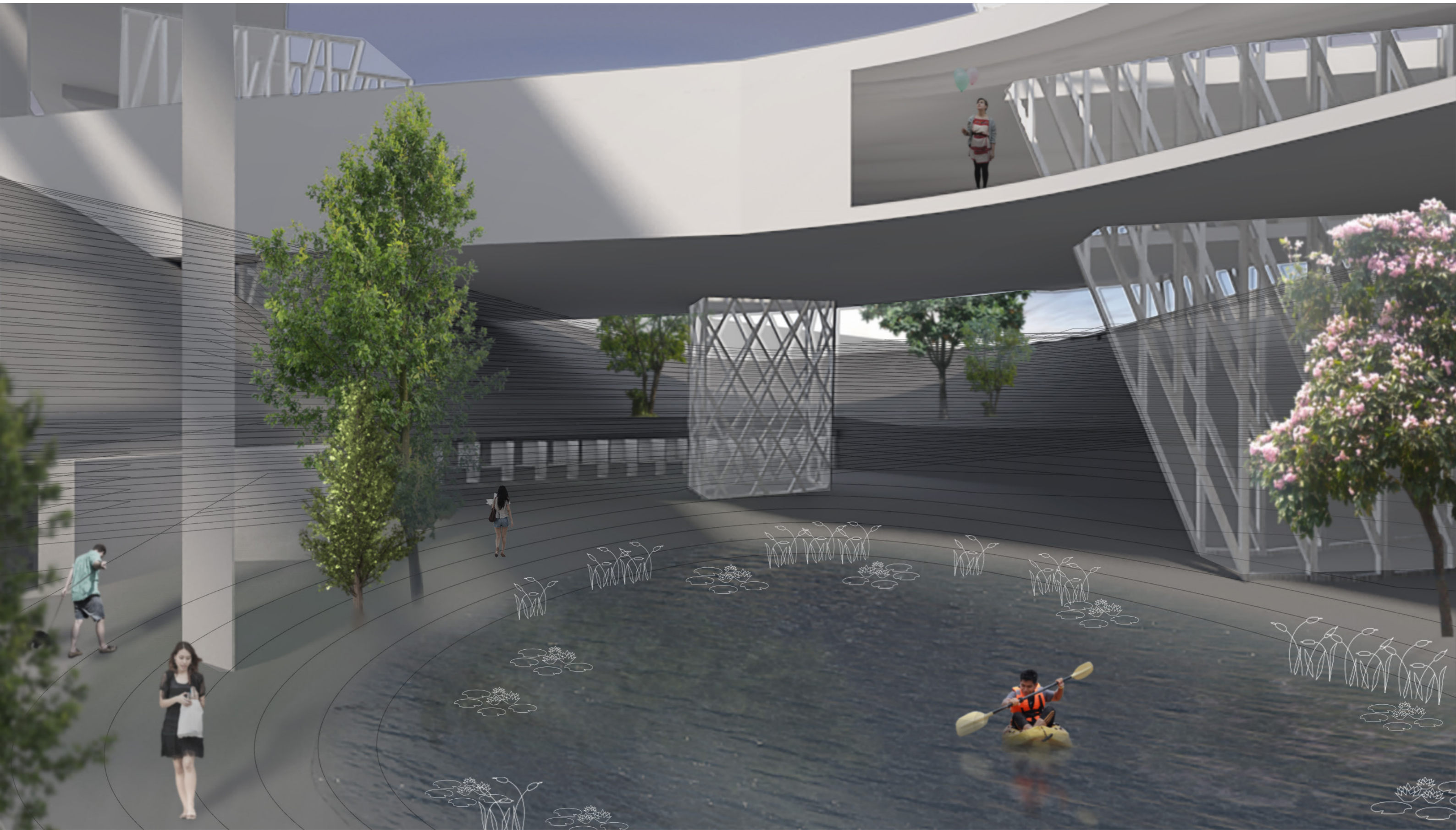

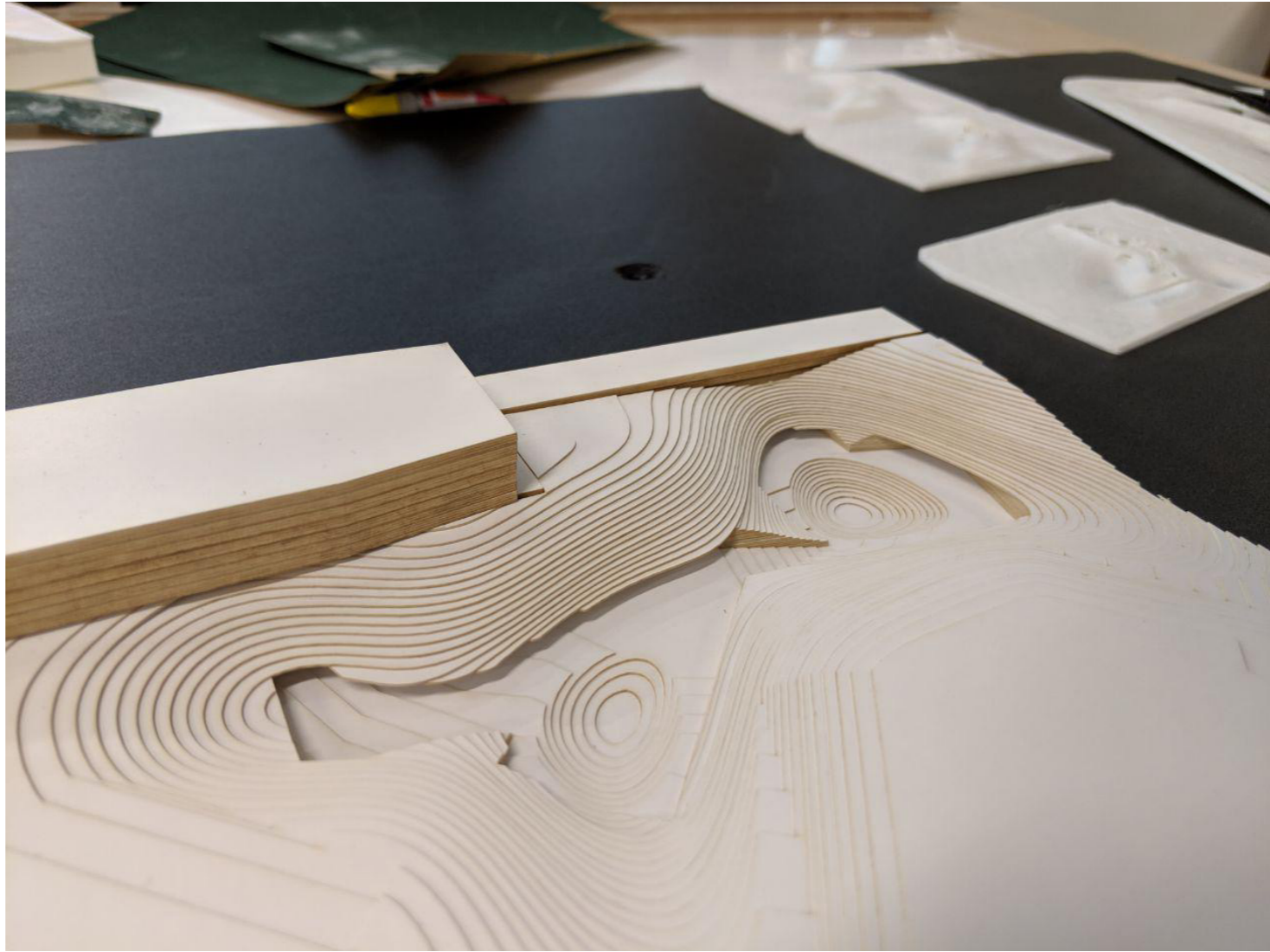

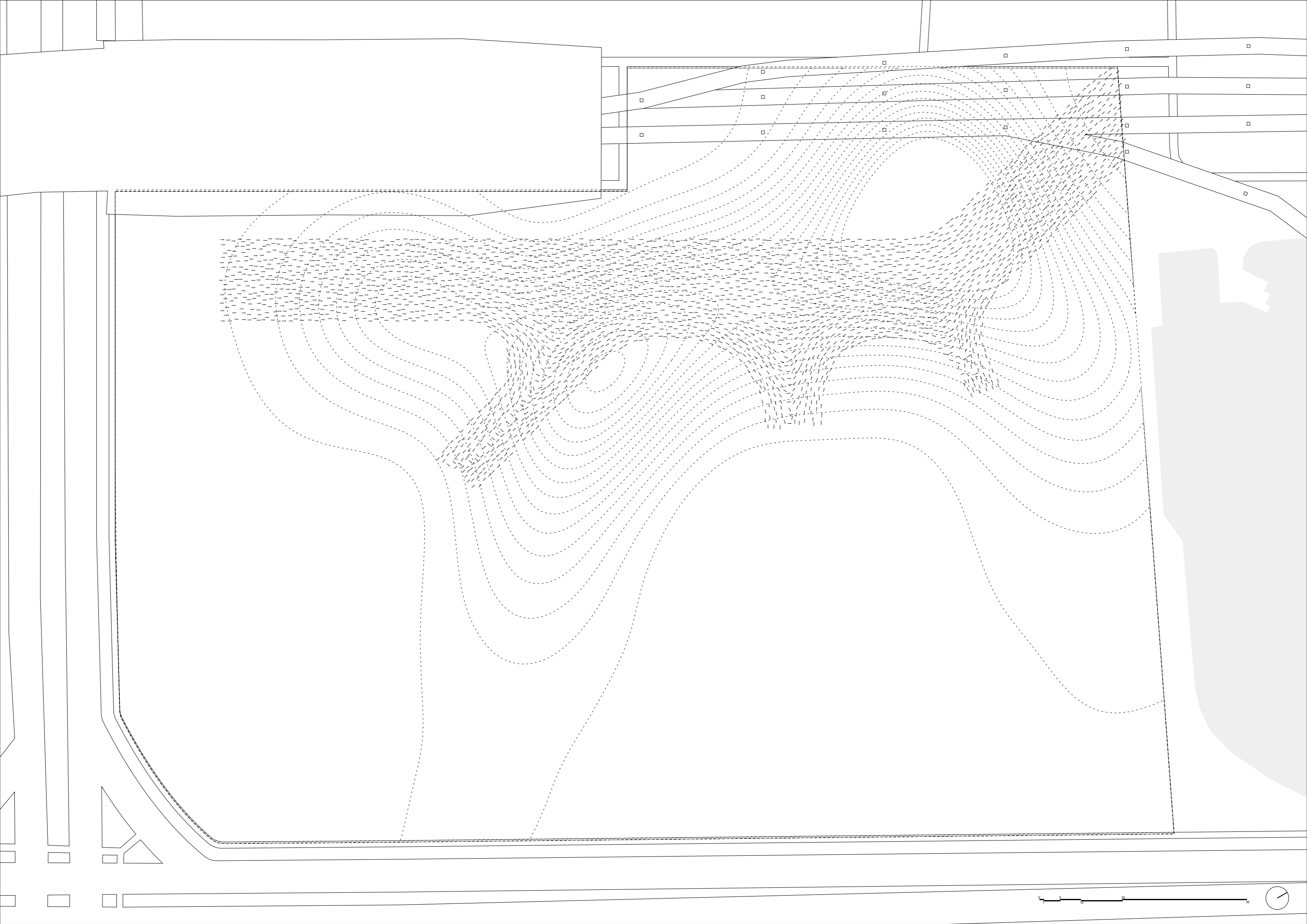

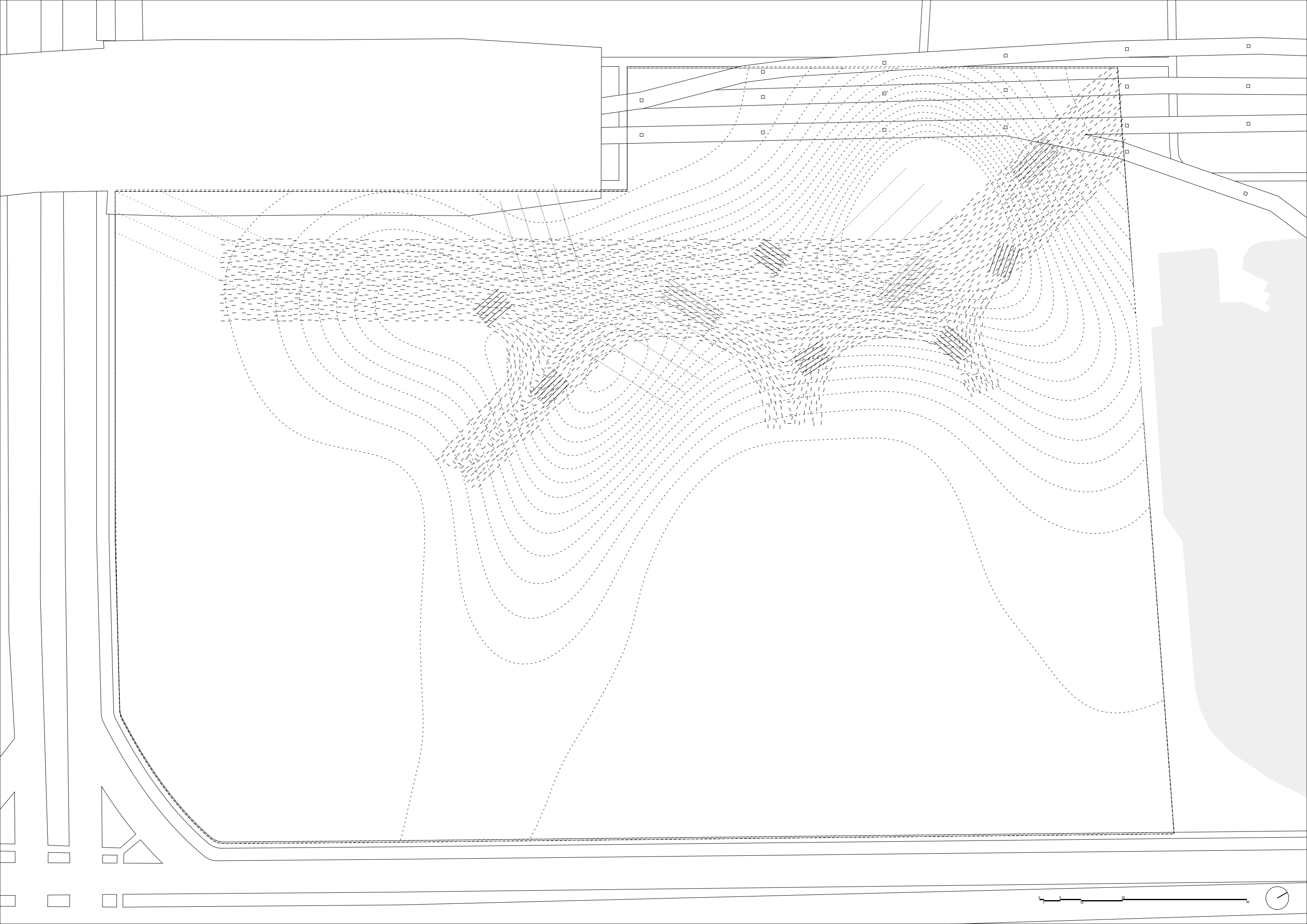

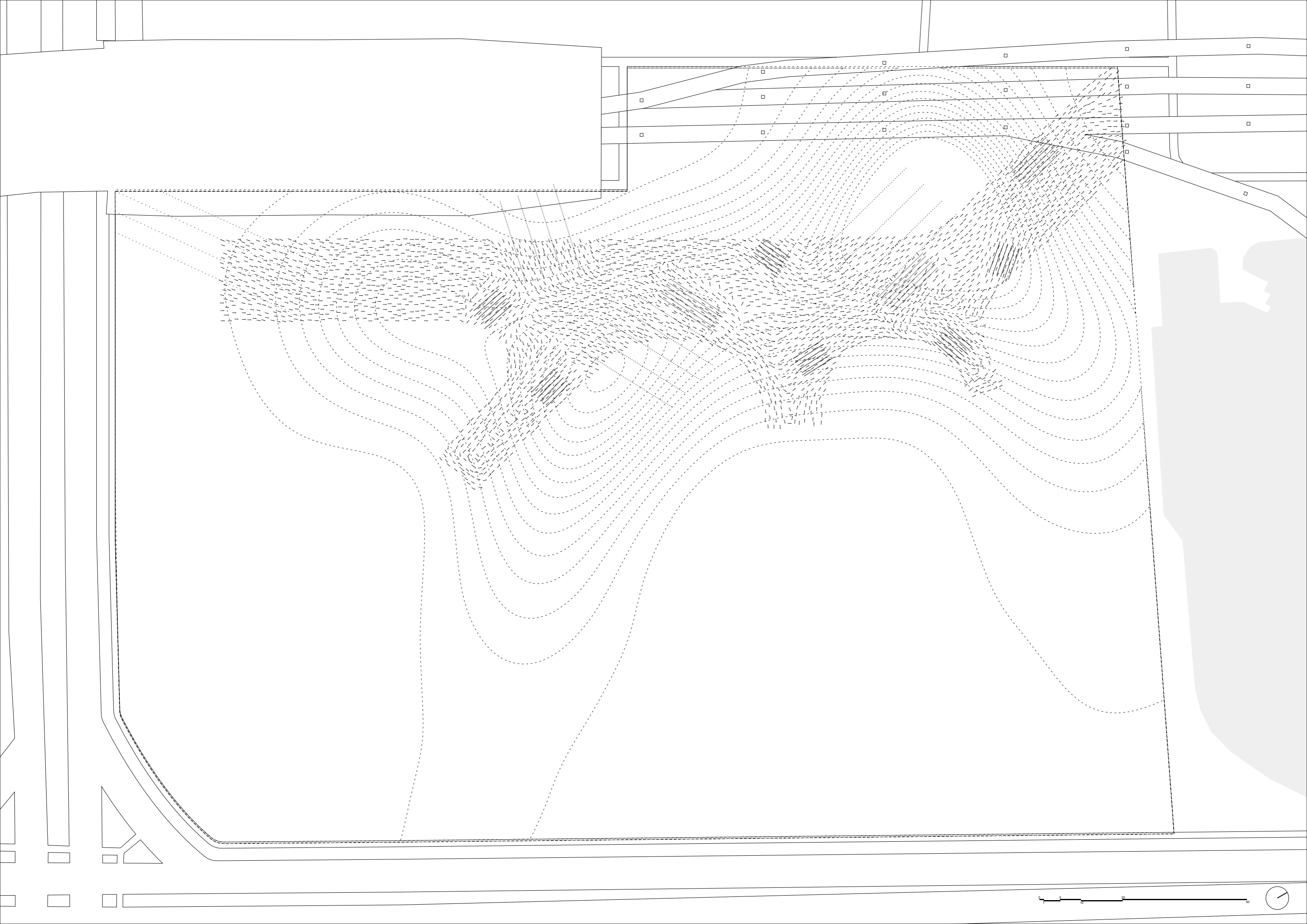

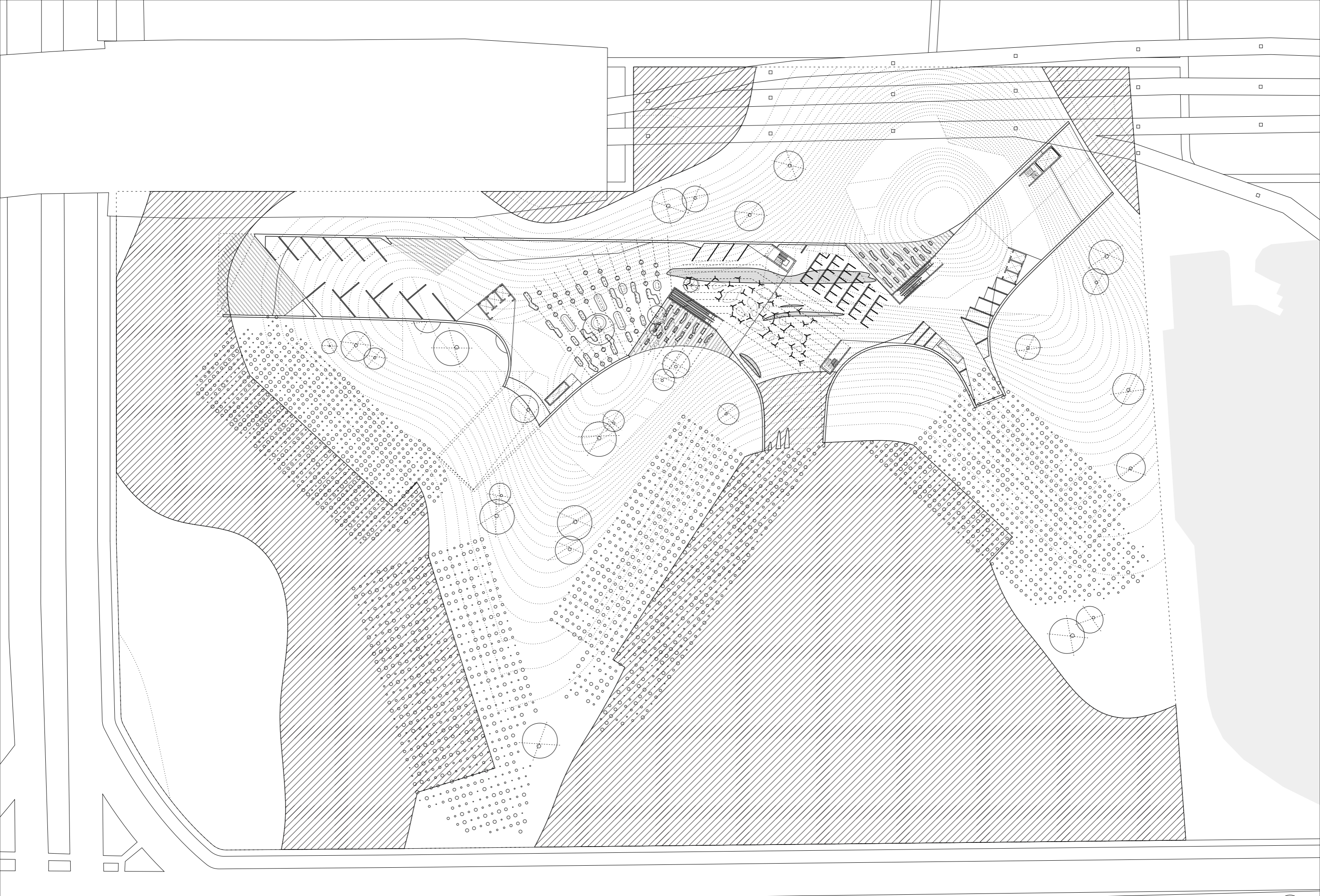

+0

