

Reading guide (first lecture)

- Read the introduction and introductory examples of feedback control from slides.
- **Learn Matlab and Simulink, especially how to write small m-code programs in Matlab and doing simple simulations in Simulink. These tools are needed in homeworks. See Tutorials in the MyCourses page of the course.** The first homework is given next week.
- Familiarize yourself to the basic dynamic and static models of systems (first principles models of physics). (Dorf: Chapters 1 and 2.)
- Note again that the textbook (Dorf and Bishop) contains it all and much more than covered in this course. Reading every chapter takes much time. The purpose is to use the textbook when needed (and personally desired) for clarifications and additional information.

Dynamic models, differential equations, Laplace transformations and block diagram algebra

Example. Dynamical/Static Models

- The system is dynamical when its state is a function of an earlier state (the system has memory and time-dependency).
 - E.g. The effect of external power F on the position of the mass position x -derived from the force balance (M is mass, K spring constant and B attenuation coefficient)

$$m\ddot{x}(t) + B\dot{x}(t) + kx(t) = F(t)$$

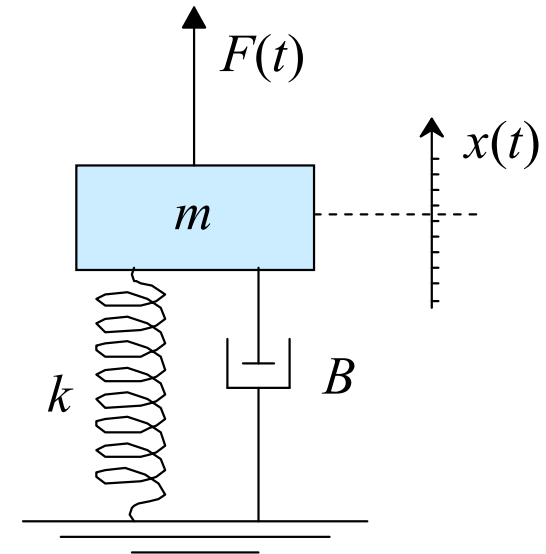

- Static system does not depend on previous state (memoryless and inertial system).
 - E.g. Temperature T effect pressure p in closed, insulated container-derived from ideal gas (n is the number of substances, V volume and R gas constant at standard conditions)

$$p(t)V = nRT(t)$$

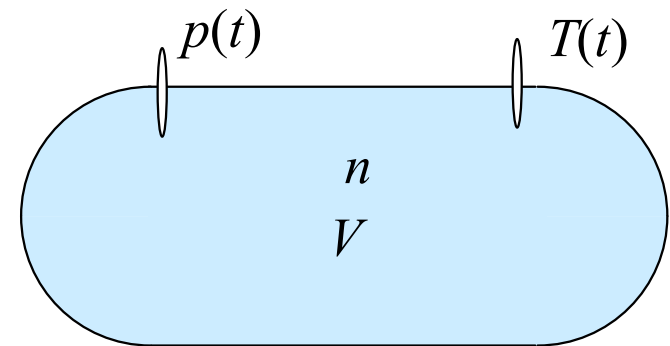

Example. Dynamic/Static Models

- Simulations are carried out to change the temperature in the external power and gas container in the mechanical system.
 - In a dynamic system, the response is changing long after the impulse has entered in input.
 - In the static system, the input and response are changing at the same time, and the response can be determined directly by the value of the input at the same instant.

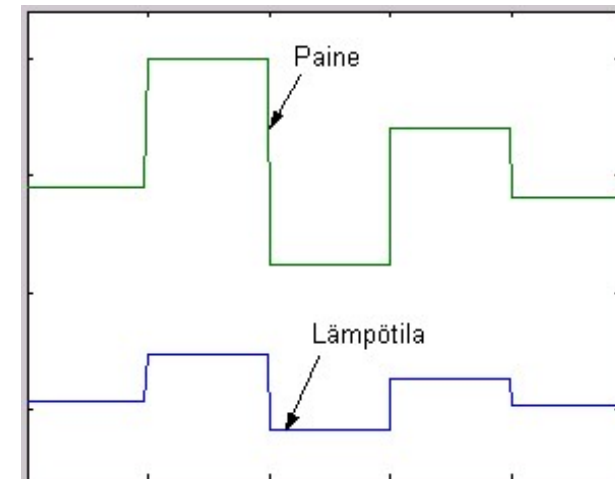
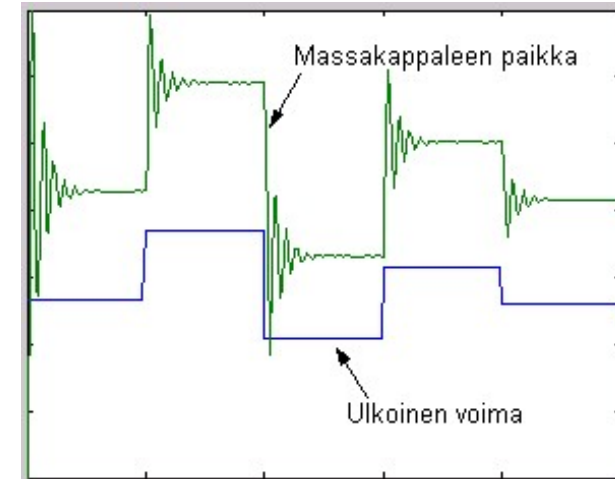

Example of First-principles modelling (modelling by laws of physics): Basic components of electrical circuits

- Resistor (resistance)

$$v(t) = Ri(t)$$

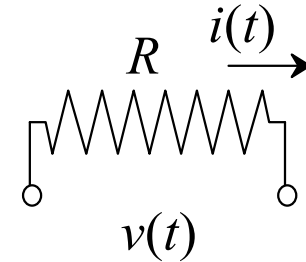

- Coil (inductance)

$$v(t) = L \frac{di(t)}{dt}$$

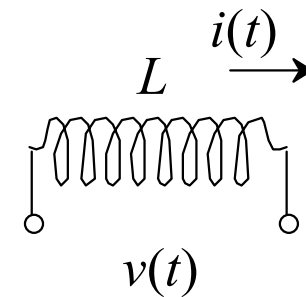

- Capacitor (capacitance)

$$i(t) = C \frac{dv(t)}{dt}$$

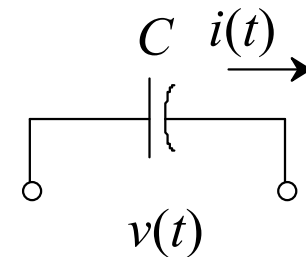

Example. Electrical circuit

- Making a model for the electrical circuit
 - The input is $v_0(t)$ and the output quantities are the voltages $v_1(t)$ and $v_2(t)$.
 - Electric currents and resistors can be modelled as

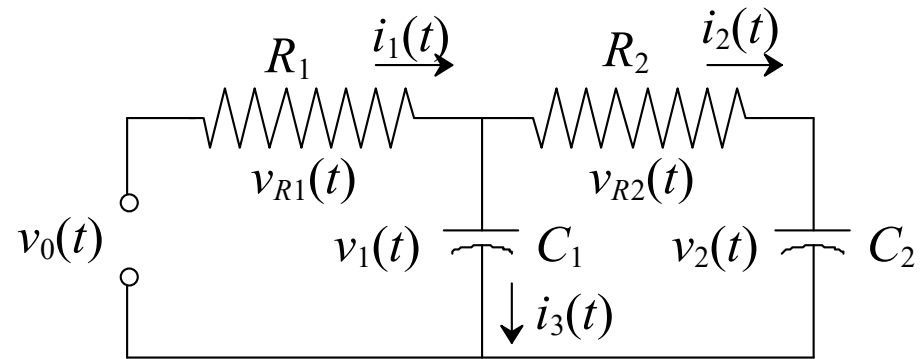

$$C_1 \frac{dv_1(t)}{dt} = i_3(t), \quad C_2 \frac{dv_2(t)}{dt} = i_2(t)$$

$$v_{R1}(t) = R_1 i_1(t), \quad v_{R2}(t) = R_2 i_2(t)$$

- Kirchoff's First Law
- Second Kirchoff law $i_1(t) = i_2(t) + i_3(t)$

$$\begin{cases} v_0(t) = v_{R1}(t) + v_1(t) \\ v_1(t) = v_{R2}(t) + v_2(t) \end{cases} \Rightarrow \begin{cases} v_0(t) = R_1 i_1(t) + v_1(t) \\ v_1(t) = R_2 i_2(t) + v_2(t) \end{cases} \Rightarrow \begin{cases} i_1(t) = \frac{v_0(t) - v_1(t)}{R_1} \\ i_2(t) = \frac{v_1(t) - v_2(t)}{R_2} \end{cases}$$

Example. Electrical circuit

- This model has voltages as states (memory elements), so it is advisable to eliminate the electrical currents as unnecessary variables from the developed equations

$$\begin{cases} \frac{dv_1(t)}{dt} = \frac{1}{C_1} i_3(t) = \frac{1}{C_1} (i_1(t) - i_2(t)) = \frac{v_0(t) - v_1(t)}{R_1 C_1} - \frac{v_1(t) - v_2(t)}{R_2 C_1} \\ \frac{dv_2(t)}{dt} = \frac{1}{C_2} i_2(t) = \frac{v_1(t) - v_2(t)}{R_2 C_2} \end{cases}$$
$$\Rightarrow \begin{cases} \frac{dv_1(t)}{dt} = -\left(\frac{1}{R_1 C_1} + \frac{1}{R_2 C_1}\right) v_1(t) + \left(\frac{1}{R_2 C_1}\right) v_2(t) + \left(\frac{1}{R_1 C_1}\right) v_0(t) \\ \frac{dv_2(t)}{dt} = \left(\frac{1}{R_2 C_2}\right) v_1(t) - \left(\frac{1}{R_2 C_2}\right) v_2(t) \end{cases}$$

Solutions of Differential Equations

- To understand and map the system under consideration, it is essential to know how the output $y(t)$ behaves as a function of time in different conditions and with different control input $u(t)$.
- Since the models are differential equations, the output function can be determined through the input response and initial values given to solve the differential equation.
- Analytical solution cannot be guaranteed for a nonlinear or distributed parameter differential equation group.
- An analytical solution can always be determined for a linear, centralized, precisely defined, differential equation group.

Linear Differential Equation solution

Linear Differential Equation/Equation Group can be solved algebraically using Laplace transform

- Take Laplace transform of the system describing differential equations and system input quantities
- Solve the algebraic equation obtained for output to input relation
- Take Laplace inverse transform and get the output function in time domain.

In control engineering applications, all time functions are assumed zero before the start of the time period:

$$f(t) \equiv 0, \quad \text{for } t < 0$$

Example

Time domain equation

$$\begin{cases} \dot{y}(t) + 2y(t) = e^{-t} \\ y(0) = 1 \end{cases}$$

Time domain solution

$$y(t) = e^{-t}$$

Laplace domain equation

$$\begin{cases} \{sY(s) - y(0)\} + \{2Y(s)\} = \left\{\frac{1}{s+1}\right\} \\ y(0) = 1 \end{cases}$$

Laplace domain solution

$$Y(s) = \frac{1}{s+1}$$

Laplace transformation

- Definition: $f(t)$ is the time domain function and $F(s)$ is the corresponding Laplace domain function

$$F(s) = L\{f(t)\} = \int_{0_-}^{\infty} f(t)e^{-st} dt \quad f(t) = L^{-1}\{F(s)\} = \frac{1}{2\pi j} \int_{b-j\infty}^{b+j\infty} F(s)e^{st} ds$$

- If the limit values exist, then
 - The final value theorem $\lim_{t \rightarrow \infty} f(t) = \lim_{s \rightarrow 0} sF(s)$
 - The initial value theorem $\lim_{t \rightarrow 0} f(t) = \lim_{s \rightarrow \infty} sF(s)$
- Laplace tables are shown in different sources with slightly different expressions (usually either so that the time functions are easy to convert to Laplace domain or so that the Laplace domain form can be reversed easily).

Laplace Transforms (common examples)

Laplace functions	Time functions	
$F(s)$	$f(t)$	T1
$C_1F_1(s) + C_2F_2(s)$	$C_1f_1(t) + C_2f_2(t)$	T2
$F(s + a)$	$e^{-at} f(t)$	T3
$e^{-as} F(s)$	$\begin{cases} 0, & t \leq a \\ f(t - a), & t > a \end{cases}$	T4
$\frac{1}{a} F\left(\frac{s}{a}\right)$	$f(at)$	T5
$-\frac{d}{ds} F(s)$	$f(t)t$	T6

Laplace Transforms (common examples)

Laplace functions	Time functions	
$\int_s^{\infty} F(\sigma) d\sigma$	$f(t) \frac{1}{t}$	T7
$F_1(s)F_2(s)$	$\int_0^t f_1(\tau) f_2(t-\tau) d\tau$	T8
$sF(s) - f(0)$	$\dot{f}(t)$	T9
$s^2 F(s) - (sf(0) + \dot{f}(0))$	$\ddot{f}(t)$	T10
$s^n F(s) - (s^{n-1} f(0) + s^{n-2} \dot{f}(0) \cdots + f^{(n-1)}(0))$	$f^{(n)}(t)$	T11
$\frac{1}{s} F(s) + \frac{1}{s} \left(\int_0^t f(\tau) d\tau \right) \Big _{t=+0}$	$\int_0^t f(\tau) d\tau$	T12

Laplace Transforms (common examples)

L	Laplace functions	Time functions		Laplace functions	Time functions	
	1	$\delta(t)$	M1	$\frac{1}{(s+a)(s+b)}$	$\frac{1}{a-b}(e^{-bt} - e^{-at})$	M9
	$\frac{1}{s}$	1	M2	$\frac{1}{s(s+a)(s+b)}$	$\frac{1}{ab} + \frac{1}{ab(b-a)}(ae^{-bt} - be^{-at})$	M10
	$\frac{1}{s^2}$	t	M3	$\frac{a}{s^2 + a^2}$	$\sin(at)$	M11
	$\frac{1}{s^{n+1}}$	$\frac{t^n}{n!}$	M4	$\frac{s}{s^2 + a^2}$	$\cos(at)$	M12
	$\frac{1}{s+a}$	e^{-at}	M5	$\frac{a}{(s+b)^2 + a^2}$	$e^{-bt} \sin(at)$	M13
	$\frac{1}{(s+a)^2}$	te^{-at}	M6	$\frac{s+b}{(s+b)^2 + a^2}$	$e^{-bt} \cos(at)$	M14
	$\frac{1}{(s+a)^{n+1}}$	$\frac{t^n e^{-at}}{n!}$	M7	$\frac{s+a}{s+b}$	$\delta(t) + (a-b)e^{-bt}$	M15
	$\frac{1}{s(s+a)}$	$\frac{1}{a}(1 - e^{-at})$	M8			

TABLE 3.1 AN INITIAL LIST OF TRANSFORM PAIRS

		$f(t)$		$F(s)$
1	Impulse	$\delta(t)$	Dirac delta	1
2	Step	$u_s(t)$		$\frac{1}{s}$
3		$e^{-at}u_s(t)$		$\frac{1}{s+a}$
4	Staircase	$tu_s(t)$		$\frac{1}{s^2}$
5		$t^n u_s(t)$		$\frac{n!}{s^{n+1}}$
6		$(\sin \omega t)u_s(t)$		$\frac{\omega}{s^2 + \omega^2}$
7		$(\cos \omega t)u_s(t)$		$\frac{s}{s^2 + \omega^2}$

TABLE 3.2 ADDITIONAL TRANSFORM PAIRS

	$f(t)$	$F(s)$
8	$te^{-at}u_s(t)$	$\frac{1}{(s+a)^2}$
9	$(e^{-at} \sin \omega t)u_s(t)$	$\frac{\omega}{(s+a)^2 + \omega^2}$
10	$(e^{-at} \cos \omega t)u_s(t)$	$\frac{(s+a)}{(s+a)^2 + \omega^2}$
11	$[(B - Aa)te^{-at} + Ae^{-at}]u_s(t)$	$\frac{As + B}{(s+a)^2}$
12	$e^{-at} \left[A \cos \omega t + \frac{(B - Aa)}{\omega} \sin \omega t \right] u_s(t)$	$\frac{(As + B)}{(s+a)^2 + \omega^2}$

Deterministic inputs

- The system input $u(t)$ is commonly modeled as the following functions:

- Unit Impulse function (Dirac delta function)

$$u_{\delta}(t) = \delta(t) = \begin{cases} \infty; & t = 0_+ \\ 0; & \text{otherwise} \end{cases} \quad \int_{-\infty}^{\infty} \delta(t) dt = 1$$
$$U_{\delta}(s) = \Delta(s) = 1$$

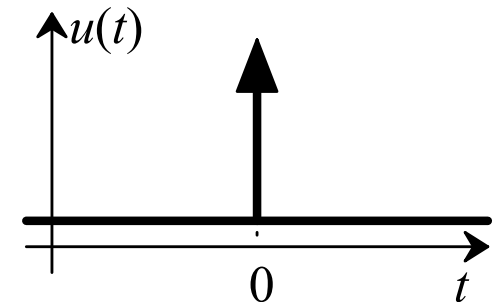

- Unit step function

$$u_s(t) = \begin{cases} 0; & t \leq 0 \\ 1; & t > 0 \end{cases} \quad U_s(s) = \frac{1}{s}$$

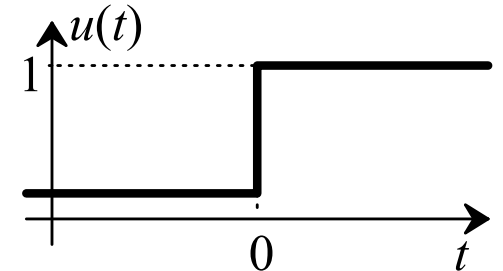

- Staircase function

$$u_r(t) = \begin{cases} 0; & t \leq 0 \\ t; & t > 0 \end{cases} \quad U_r(s) = \frac{1}{s^2}$$

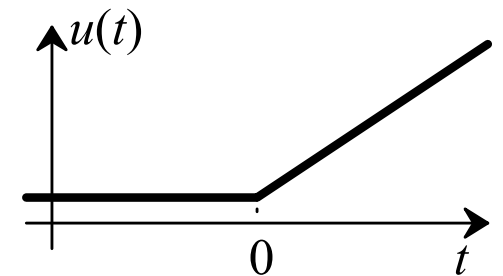

Example: Mass block

An earlier example showed the mass equation:

$$m\ddot{x}(t) + B\dot{x}(t) + kx(t) = F(t)$$

Solve for the response, when

$$\begin{cases} k = 5 & x(0) = 1 \\ B = 2 & \dot{x}(0) = -1 \\ m = 1 & F(t) = 2\delta(t) \text{ (impulse)} \end{cases}$$

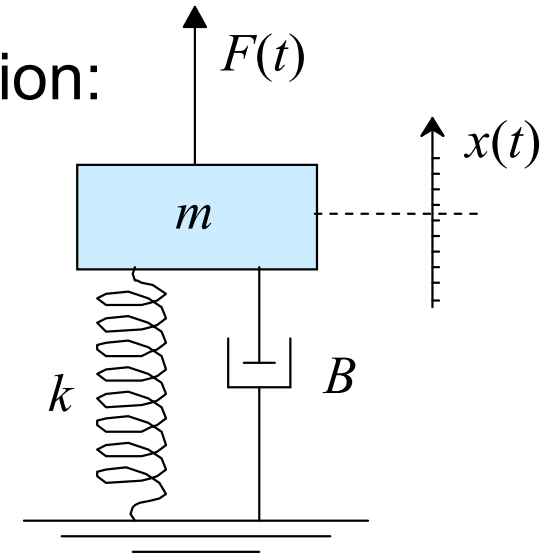

Mass force balance in time domain: $\ddot{x}(t) + 2\dot{x}(t) + 5x(t) = 2\delta(t)$
and in Laplace domain:

$$(s^2 X(s) - sx(0) - \dot{x}(0)) + 2 \cdot (sX(s) - x(0)) + 5 \cdot X(s) = 2 \cdot 1$$

$$(s^2 X(s) - s + 1) + 2(sX(s) - 1) + 5X(s) = 2 \quad \Rightarrow \quad (s^2 + 2s + 5)X(s) = s + 3$$

Example: Mass block

Solving the expression for position of the mass block in Laplace domain

$$X(s): \quad X(s) = \frac{s+3}{s^2+2s+5} = \frac{s+1+2}{(s+1)^2+2^2} = \frac{s+1}{(s+1)^2+2^2} + \frac{2}{(s+1)^2+2^2}$$

Taking reverse Laplace transform to get position equation in time domain:

$$x(t) = L\{X(s)\} = e^{-t} \cos(2t) + e^{-t} \sin(2t) = e^{-t} (\sin(2t) + \cos(2t))$$

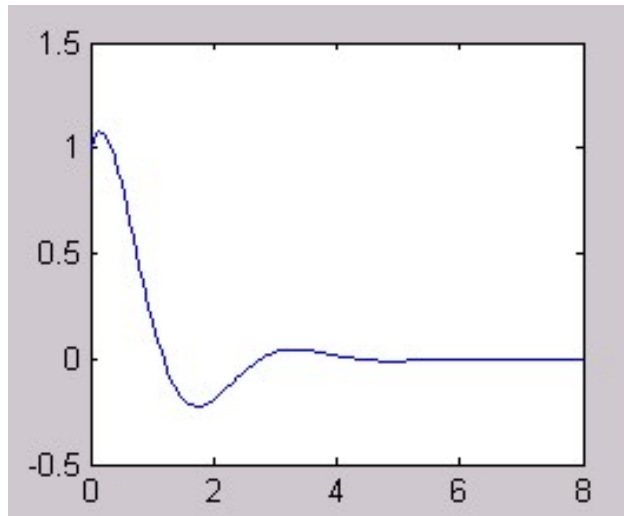

Free and Forced responses

- The response can be divided into initial $y_0(t)$ (Free response) and external control response $y_u(t)$ (Forced response). The overall response of the linear system is the sum of the two responses.

$$y(t) = y_u(t) + y_0(t)$$

- Free response $y_0(t)$ is the response when external controls do not affect the system $u_i(t) = 0$.
- Forced response $y_u(t)$ is the response when all initial values of the system $y^{(n)}(0)$ and $u_i^{(n)}(0)$ are zero.
- Often, the term "response" refers to a forced response or response to a given input, ignoring initial values.

Example 2: Mass block

- Separating the last example into free and forced responses:

$$(s^2 X(s) - sx(0) - \dot{x}(0)) + 2 \cdot (sX(s) - x(0)) + 5 \cdot X(s) = 2 \cdot \Delta(s)$$

$$(s^2 + 2s + 5)X(s) = (sx(0) + \dot{x}(0) + 2x(0)) + 2\Delta(s)$$

$$X(s) = \frac{(sx(0) + \dot{x}(0) + 2x(0))}{s^2 + 2s + 5} + \frac{2\Delta(s)}{s^2 + 2s + 5} = X_0(s) + X_u(s)$$

$$X(s) = X_0(s) + X_u(s) = \frac{s+1}{(s+1)^2 + 2^2} + \frac{2}{(s+1)^2 + 2^2}$$

$$x(t) = L\{X(s)\} = L\{X_0(s) + X_u(s)\} = e^{-t} \cos(2t) + e^{-t} \sin(2t) = x_0(t) + x_u(t)$$

Example 2: Mass block

- The free response starts from the initial state due to the system's initial values (the position of the mass track at the start is 1 and its initial speed -1)
- The forced response moves away from rest as a result of external control or force (impulse-like nudge at the start)

$$\begin{cases} x_0(t) = e^{-t} \cos(2t) \\ x_u(t) = e^{-t} \sin(2t) \\ x(t) = e^{-t} (\cos(2t) + \sin(2t)) \end{cases}$$

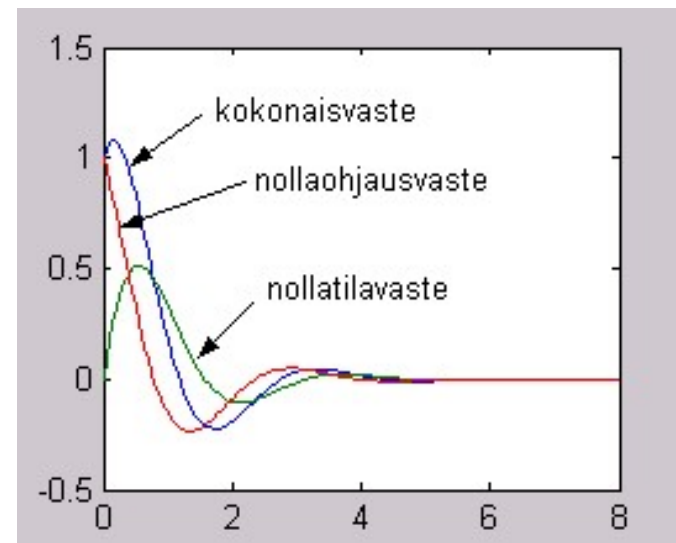

Transfer function

- Control techniques normally examine how external inputs and disturbances affect the response; The effect of the initial values is ignored and the focus is on the forced response.
- When initial values are zero, the expression of the response is given in the form of Laplace output $Y(s)$ which is a product of the impulse response in Laplace domain $G(s)$ and the Laplace input function $U(s)$.
- The Laplace representation of the model $G(s)$ is called the transfer function.

-

$$Y(s) = G(s) \cdot U(s)$$

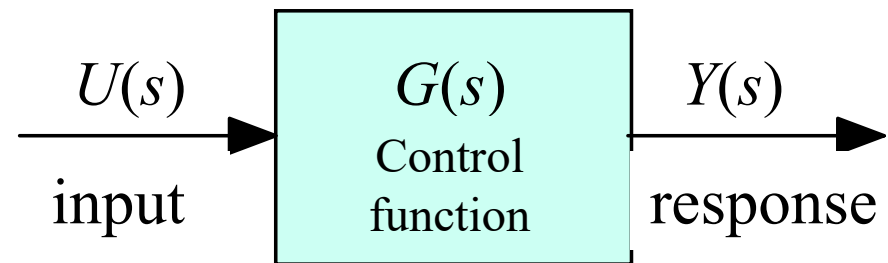

Block Diagram conversions: Signals

- In block diagrams, a single signal can be exported to more than one block (signal branching).
 - A block diagram is an information chart and it can branch information, but it does not reduce that information. Each branch has the same information.

$$Y_1(s) = Y_2(s) = Y_3(s) = U(s)$$

- The different signals can be combined using a summation block. The combination can be either an addition or subtraction of individual signals
 - Signs on the summation block indicate the signs of the individual signals in the total.

$$Y(s) = U_1(s) + U_2(s) - U_3(s)$$

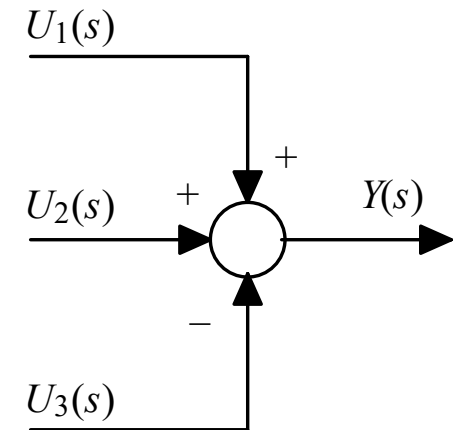
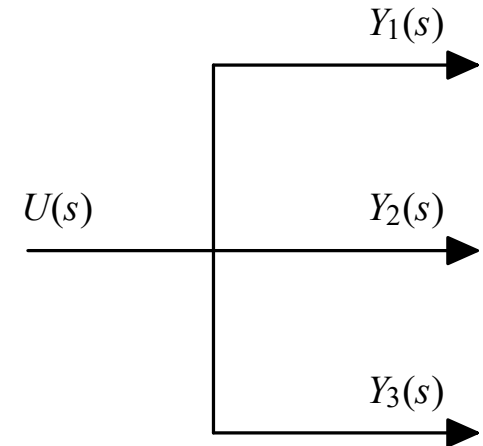

Passing a signal through a block

- As stated in previous lectures, in Laplace domain the output signal is obtained by multiplying the input signal with a transfer function

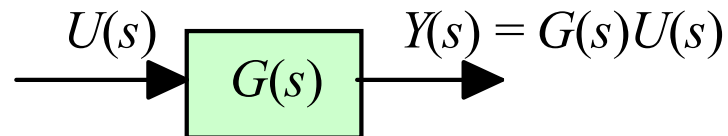

- This basic formula can be used to derive a transformation from the serial association of the equation blocks. Introduce the auxiliary variable $\varepsilon(s)$, which is subsequently eliminated

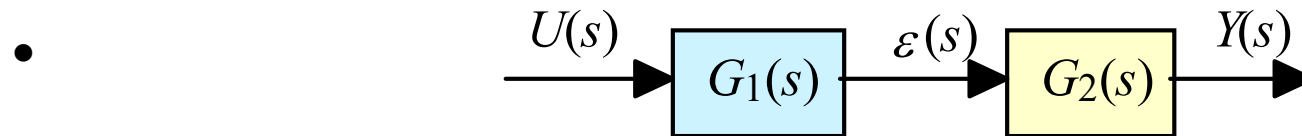

$$Y(s) = G_2(s)\varepsilon(s)$$

$$\varepsilon(s) = G_1(s)U(s)$$

$$\Rightarrow Y(s) = G_2(s)G_1(s)U(s)$$

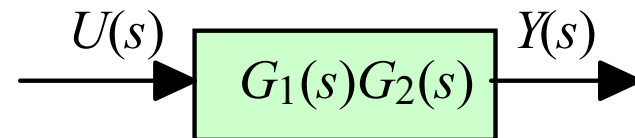

Passing a signal through a block

- The derivation for parallel blocks:

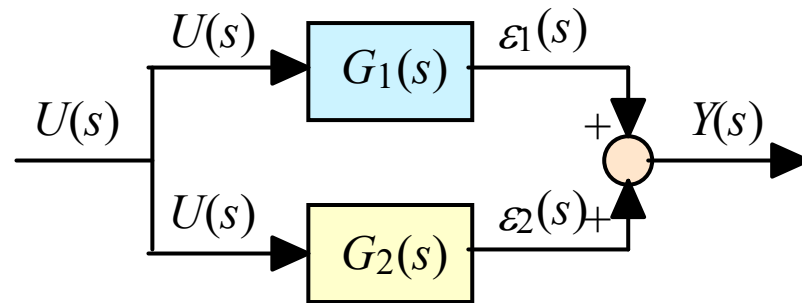

$$\begin{cases} Y(s) = \varepsilon_1(s) + \varepsilon_2(s) \\ \varepsilon_1(s) = G_1(s)U(s) \\ \varepsilon_2(s) = G_2(s)U(s) \end{cases} \Rightarrow Y(s) = G_1(s)U(s) + G_2(s)U(s)$$

$$Y(s) = (G_1(s) + G_2(s))U(s) = G_{TOT}(s)U(s) \Rightarrow G_{TOT}(s) = G_1(s) + G_2(s)$$

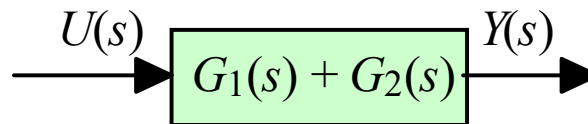

Passing a signal through a block

- Loop relation (feedback) to the conversion formula is calculated as:

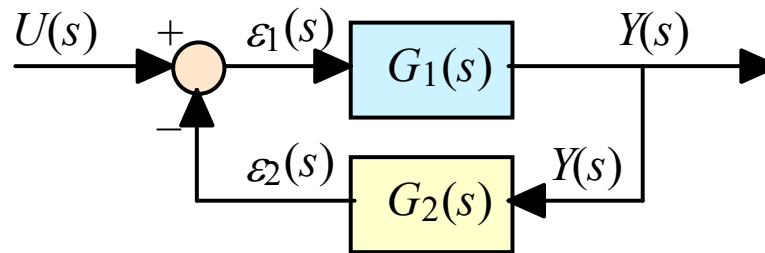

$$\begin{cases} Y(s) = G_1(s)\varepsilon_1(s) \\ \varepsilon_1(s) = U(s) - \varepsilon_2(s) \\ \varepsilon_2(s) = G_2(s)Y(s) \end{cases} \Rightarrow Y(s) = G_1(s)(U(s) - G_2(s)Y(s))$$

$$\Rightarrow Y(s) = G_1(s)U(s) - G_1(s)G_2(s)Y(s) \Rightarrow (1 + G_1(s)G_2(s))Y(s) = G_1(s)U(s)$$

$$\Rightarrow Y(s) = \frac{G_1(s)}{1 + G_1(s)G_2(s)}U(s) = G_{TOT}(s)U(s) \Rightarrow G_{TOT}(s) = \frac{G_1(s)}{1 + G_1(s)G_2(s)}$$

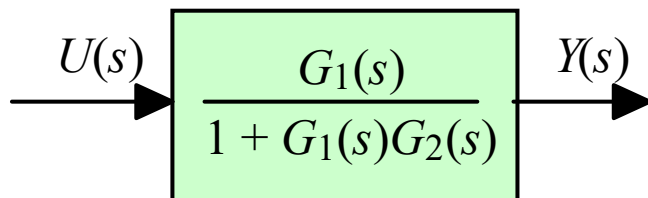

Thus, the overall transfer function is the tf of the forward path divided by the term $(1 + \text{open loop transfer function})$. This will be essential in future.