

5 LARGE DISPLACEMENT ANALYSIS

5.1 LARGE DISPLACEMENT ELASTICITY	12
5.2 LARGE DISPLACEMENT FEA	22
5.3 ELEMENT CONTRIBUTIONS.....	30

LEARNING OUTCOMES

Students are able to solve the weekly lecture problems, home problems, and exercise problems about large displacement FEA:

- Large displacement elasticity theory, principle of virtual work
- Large displacement FEA for solid, thin slab, and bar models
- Non-linear element contributions of solid, thin slab, and bar models

BENDING OF BEAM

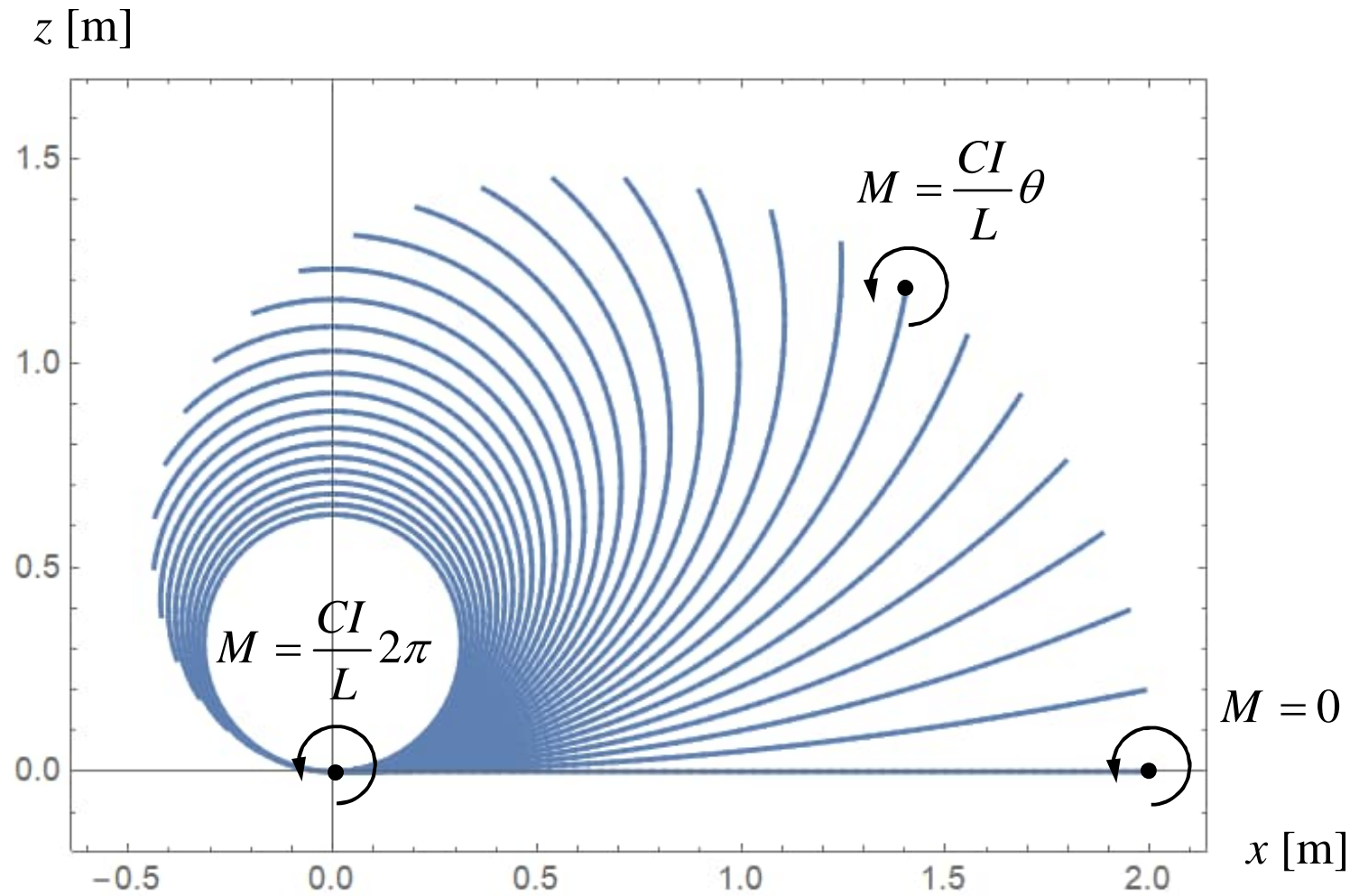

BALANCE LAWS OF MECHANICS

Balance of mass (def. of a body or a material volume) Mass of a body is constant ←

Balance of linear momentum (Newton 2) The rate of change of linear momentum within a material volume equals the external force resultant acting on the material volume. ←

Balance of angular momentum (Cor. of Newton 2) The rate of change of angular momentum within a material volume equals the external moment resultant acting on the material volume. ←

Balance of energy (Thermodynamics 1)

Entropy growth (Thermodynamics 2)

SOURCES OF NON-LINEARITY

- **Geometry:** Equilibrium equations should be satisfied in deformed geometry depending on displacement. Strain measures of large displacements are always non-linear.
- **Material:** Constitutive equation $g(\sigma, u) = 0$ may be non-linear. Near reference geometry, truncated Taylor series $g^\circ + (\partial g / \partial \sigma)^\circ \Delta \sigma + (\partial g / \partial u)^\circ \Delta u = 0$ gives a useful approximation.
- **External forces:** External forces may be non-linear. Even the simplest contact conditions containing inequalities are always non-linear.

In non-linear mechanics $g(\sigma, \varepsilon) = 0$ and $f(\varepsilon, u) = 0$ the effect of material and geometry cannot clearly be separated!

EFFECT OF GEOMETRY

Displacement at the free end (u_L, w_L) caused by force F in bending of a cantilever. Axial stiffness EA is assumed to be much larger than the bending stiffness EI ($I \ll AL^2$). Then, length of the axis is (almost) constant L no matter the deformation.

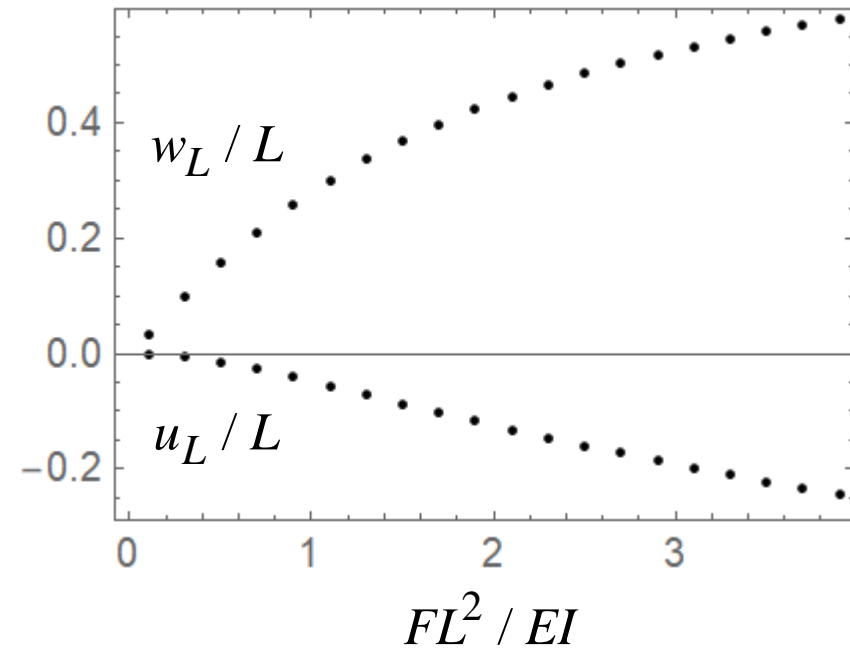
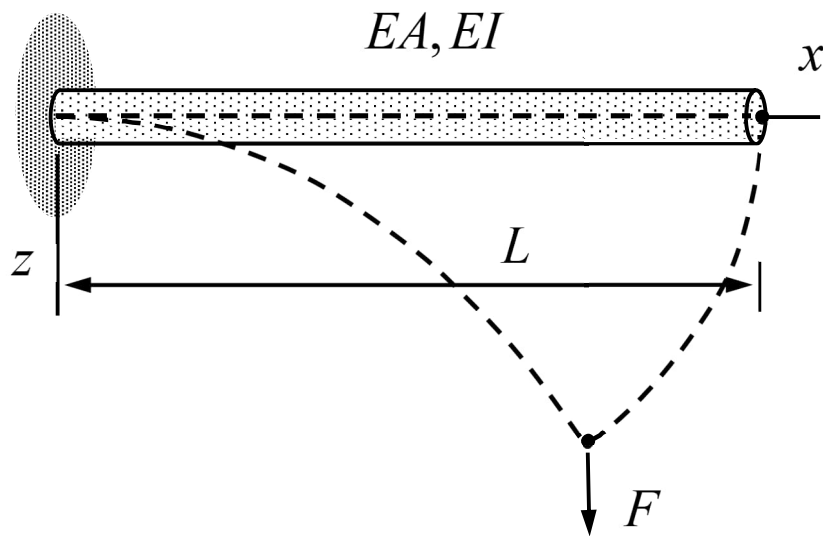

BOUNDARY CONDITIONS

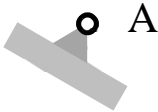
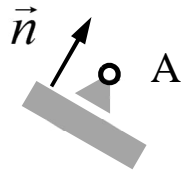
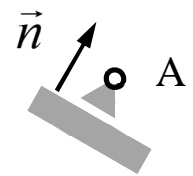
name	symbol	equation
joint		$\vec{u}_A = 0$
slider		$u_n = \vec{n} \cdot \vec{u}_A = 0$
contact		<p style="color: red; font-weight: bold;">One-sided (non-linear) boundary condition!</p> $u_A = \vec{n} \cdot \vec{u}_A \geq 0, F_A = \vec{n} \cdot \vec{F}_A \geq 0, u_A F_A = 0$

EXAMPLE. Determine the relationship between the vertical displacement of node 2 (positive upwards) and force F acting on node 2 for the structure shown. Assume that the force-length relationship is given by $N = EAe$ and $e = h / h^\circ - 1$ in which EA is constant, h° is the length when $N = 0$, and h is the length at the deformed geometry (takes into account the displacement).

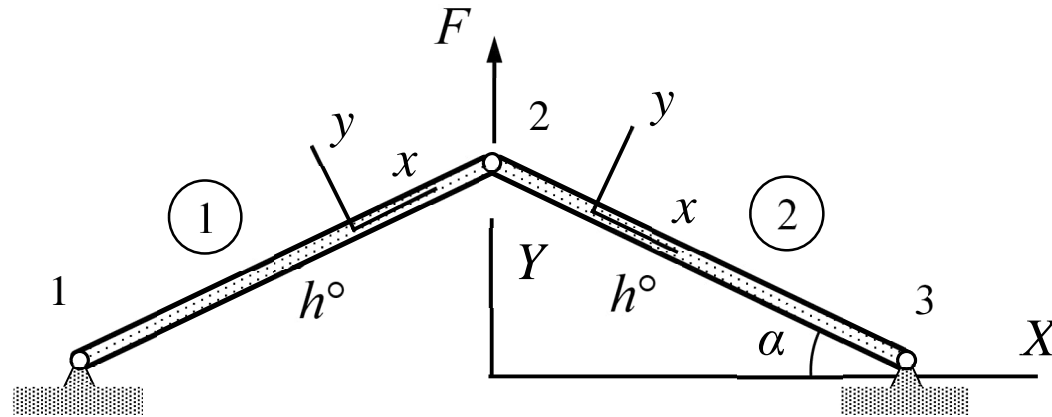

Answer $\frac{F}{EA} - 2(\sin \alpha + a) \frac{\sqrt{1 + 2a \sin \alpha + a^2} - 1}{\sqrt{1 + 2a \sin \alpha + a^2}} = 0$, where $a = \frac{u_{Y2}}{h^\circ}$

- Strain definition should not induce stress under rigid body motion of motion of a bar. Strain measure $e = h / h^\circ - 1$, based on the relative length change, satisfies the criterion. At the deformed geometry, when displacement is u_{Y2} ,

$$h = \left| h^\circ \cos \alpha \vec{I} + (h^\circ \sin \alpha + u_{Y2}) \vec{J} \right| = h^\circ \sqrt{1 + 2a \sin \alpha + a^2} \quad \Rightarrow$$

$$\delta h = \frac{\partial h}{\partial u_{Y2}} \delta u_{Y2} = \frac{\sin \alpha + a}{\sqrt{1 + 2a \sin \alpha + a^2}} \delta u_{Y2} \quad \Rightarrow$$

$$N = EA \left(\frac{h}{h^\circ} - 1 \right) = EA \left(\sqrt{1 + 2a \sin \alpha + a^2} - 1 \right), \text{ where } a = \frac{u_{Y2}}{h^\circ}.$$

- Virtual work expressions of external and internal forces for one bar element, written at the deformed geometry with length h , are $\delta W^{\text{ext}} = F \delta u_{Y2}$ and $\delta W^{\text{int}} = -N \delta h$. As the

structure consists of two bars (internal parts of the bars are the same by symmetry),
virtual work expression of the structure

$$\delta W = [F - 2EA(\sin \alpha + a) \frac{\sqrt{1 + 2a \sin \alpha + a^2} - 1}{\sqrt{1 + 2a \sin \alpha + a^2}}] \delta u_{Y2}.$$

- Principle of virtual work and the fundamental lemma of variation calculus are valid also in large displacement analysis

$$F - 2EA(\sin \alpha + a) \frac{\sqrt{1 + 2a \sin \alpha + a^2} - 1}{\sqrt{1 + 2a \sin \alpha + a^2}} = 0. \quad \leftarrow$$

The remaining –mathematical problem– is to find a solution or solutions to the non-linear algebraic equilibrium equation.

FORCE-DISPLACEMENT RELATIONSHIP $\alpha = \pi / 3$

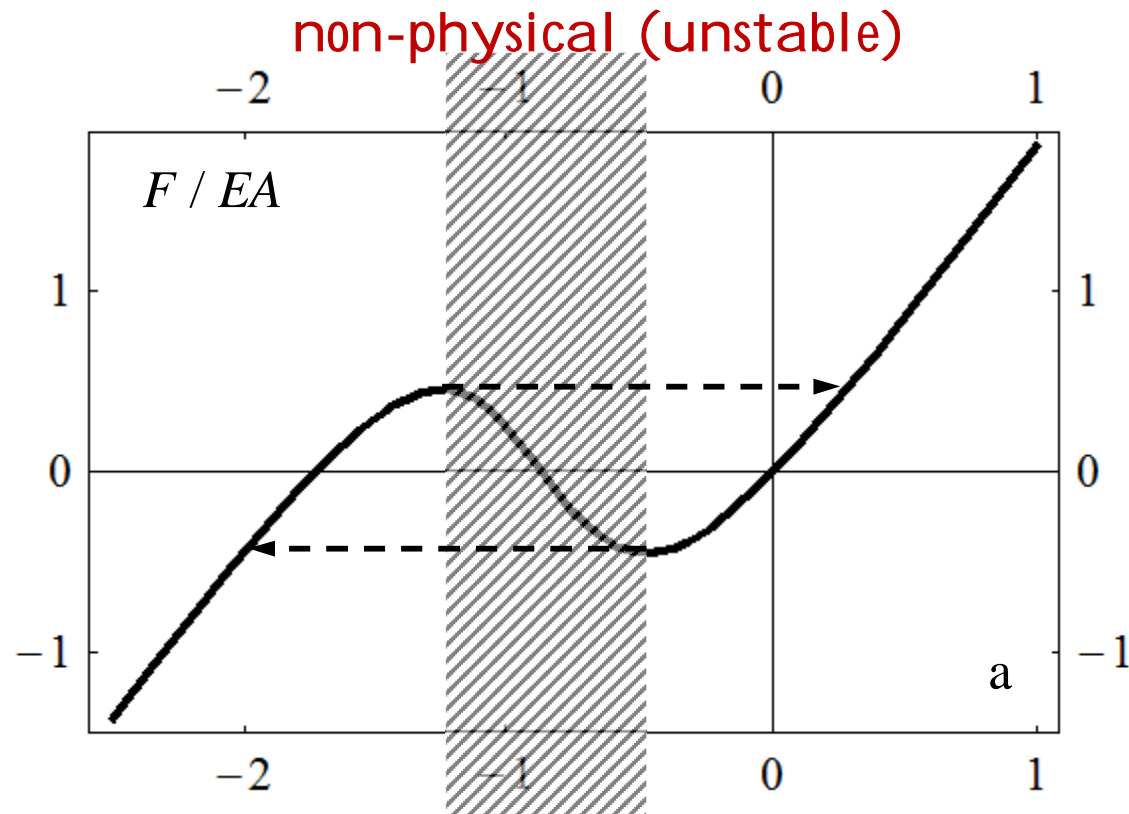

Finding the solution by a numerical method can be tricky as a mathematically correct solution may not be physically feasible, displacement (solution) may not depend continuously on the force (data), solution depends on the loading path, etc.

5.1 LARGE DISPLACEMENT ELASTICITY

Assuming equilibrium on the initial domain Ω° , the aim is to find a new equilibrium on the deformed domain Ω , when, e.g., external forces acting on the structure are changed.

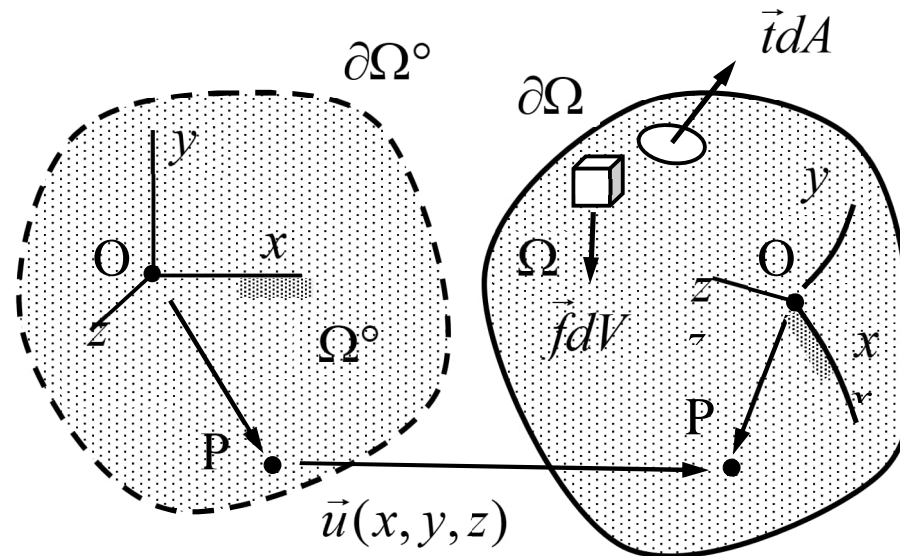

The local forms of the balance laws are concerned with the deformed domain which depends on the displacement! Precise treatment of large displacements requires modifications in stress and strain concepts of linear theory.

KINEMATICS OF LARGE DISPLACEMENTS

Displacement $\vec{r} = \vec{r}^\circ + \vec{u}(x^\circ, y^\circ, z^\circ)$

Deformation gradient $\vec{F}_c = \vec{I} + \nabla^\circ \vec{u}$

Green-Lagrange $2\vec{E} = \vec{F}_c \cdot \vec{F} - \vec{I} = \nabla^\circ \vec{u} + (\nabla^\circ \vec{u})_c + (\nabla^\circ \vec{u}) \cdot (\nabla^\circ \vec{u})_c$

Variation $\delta \vec{E} = \vec{F}_c \cdot \delta \vec{\varepsilon} \cdot \vec{F}$ where $2\vec{\varepsilon} = \nabla \vec{u} + (\nabla \vec{u})_c$

Domain element $dV = JdV^\circ$

Jacobian $J = |\det[F]|$

Nanson $\vec{n}dA = J\vec{F}_c^{-1} \cdot \vec{n}^\circ dA^\circ$ or $d\vec{A} = J\vec{F}_c^{-1} \cdot d\vec{A}^\circ$

KINETICS OF LARGE DISPLACEMENTS

Piola-Kirchhoff 1..... $J\vec{\sigma} = \vec{P} \cdot \vec{F}_c$

Piola-Kirchhoff 2..... $J\vec{\sigma} = \vec{F} \cdot \vec{S} \cdot \vec{F}_c \quad (\vec{F} \cdot \vec{S} = \vec{P})$

Force element $d\vec{F} = \vec{t}dA = \vec{n} \cdot \vec{\sigma}dA = \vec{\sigma}_c \cdot \vec{n}dA = \vec{P} \cdot \vec{n}^\circ dA^\circ$

Virtual work density $\delta w_{V^\circ}^{\text{int}} = -\vec{S} : \delta \vec{E}_c = -\vec{\sigma} : \delta \vec{\epsilon}_c J$

Elastic material..... $\vec{S} = \lambda \text{tr}(\vec{E})\vec{I} + 2\mu\vec{E}$

Analysis uses the PK2 stress concept. Cauchy (true) stress follows from the relationship between the quantities. In practice, the simple constitutive equation applies to isotropic material subjected to small strains (displacements may be large).

GREEN-LAGRANGE STRAIN

A rigid body motion should not induce strains! The proper strain measures with this respect are non-linear in displacement components

$$\begin{Bmatrix} E_{xx} \\ E_{yy} \\ E_{zz} \end{Bmatrix} = \begin{Bmatrix} \varepsilon_{xx} \\ \varepsilon_{yy} \\ \varepsilon_{zz} \end{Bmatrix} + \frac{1}{2} \begin{Bmatrix} (\partial u_x / \partial x)^2 + (\partial u_y / \partial x)^2 + (\partial u_z / \partial x)^2 \\ (\partial u_x / \partial y)^2 + (\partial u_y / \partial y)^2 + (\partial u_z / \partial y)^2 \\ (\partial u_x / \partial z)^2 + (\partial u_y / \partial z)^2 + (\partial u_z / \partial z)^2 \end{Bmatrix},$$

$$\begin{Bmatrix} E_{xy} \\ E_{yz} \\ E_{zx} \end{Bmatrix} = \begin{Bmatrix} \varepsilon_{xy} \\ \varepsilon_{yz} \\ \varepsilon_{zx} \end{Bmatrix} + \frac{1}{2} \begin{Bmatrix} (\partial u_x / \partial x)(\partial u_x / \partial y) + (\partial u_y / \partial x)(\partial u_y / \partial y) + (\partial u_z / \partial x)(\partial u_z / \partial y) \\ (\partial u_x / \partial y)(\partial u_x / \partial z) + (\partial u_y / \partial y)(\partial u_y / \partial z) + (\partial u_z / \partial y)(\partial u_z / \partial z) \\ (\partial u_x / \partial z)(\partial u_x / \partial x) + (\partial u_y / \partial z)(\partial u_y / \partial x) + (\partial u_z / \partial z)(\partial u_z / \partial x) \end{Bmatrix}.$$

All measures boil down to the definitions of linear displacement analysis when strains and rotations of material elements are small!

ELASTIC MATERIAL

Under the assumption of large displacement and small strains, the Green-Lagrange strain measure does not differ much from the linear setting with small displacements and small strains. Constitutive equations

$$\begin{Bmatrix} E_{xx} \\ E_{yy} \\ E_{zz} \end{Bmatrix} = \frac{1}{C} \begin{bmatrix} 1 & -\nu & -\nu \\ -\nu & 1 & -\nu \\ -\nu & -\nu & 1 \end{bmatrix} \begin{Bmatrix} S_{xx} \\ S_{yy} \\ S_{zz} \end{Bmatrix} \quad \text{and} \quad \begin{Bmatrix} 2E_{xy} \\ 2E_{yz} \\ 2E_{zx} \end{Bmatrix} = \frac{1}{G} \begin{Bmatrix} S_{xy} \\ S_{yz} \\ S_{zx} \end{Bmatrix},$$

with material parameters C (which replaces E), ν , and $G = C / (2 + 2\nu)$ are same as those of the linear case, are assumed to simplify the setting. Also, the uni-axial and two-axial (plane) stress and strain relationships follow just by using Green-Lagrange strains instead of linear strains and C instead of E .

PRINCIPLE OF VIRTUAL WORK

Principle of virtual work $\delta W^{\text{int}} + \delta W^{\text{ext}} = 0 \quad \forall \delta \vec{u}$ is concerned with the deformed domain Ω . In large displacement theory, all quantities are expressed in the Cartesian xyz -system of the initial geometry

$$\delta W^{\text{int}} = \int_{\Omega} \delta w_V^{\text{int}} dV = \int_{\Omega^{\circ}} \delta w_{V^{\circ}}^{\text{int}} dV^{\circ},$$

$$\begin{aligned} \delta W^{\text{ext}} &= \int_{\Omega} \delta w_V^{\text{ext}} dV + \int_{\partial\Omega} \delta w_A^{\text{ext}} dA \\ &= \int_{\Omega^{\circ}} \delta w_{V^{\circ}}^{\text{ext}} dV^{\circ} + \int_{\partial\Omega^{\circ}} \delta w_{A^{\circ}}^{\text{ext}} dA^{\circ}. \end{aligned}$$

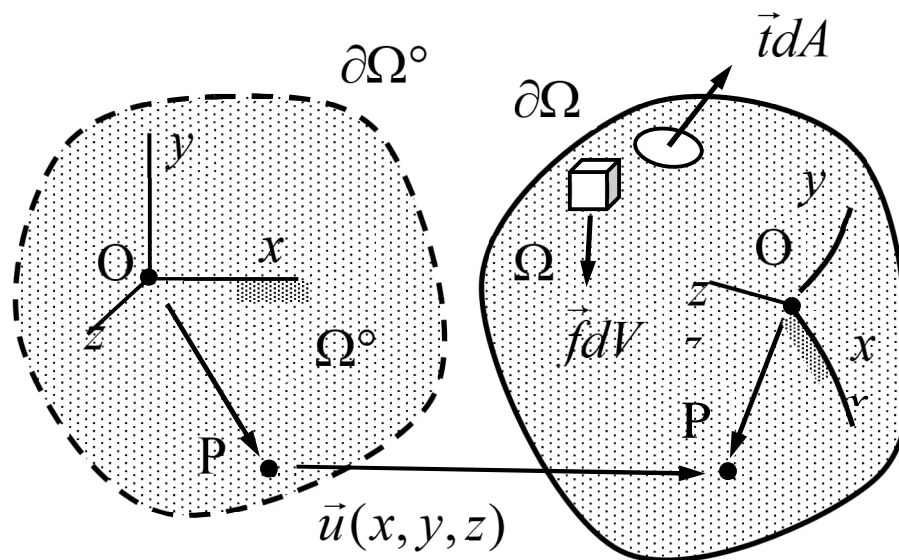

Physics is related with domain Ω occupied by the deformed body but mathematics with the initial domain Ω° of fixed geometry.

- Principle of virtual work $\delta W^{\text{int}} + \delta W^{\text{ext}} = 0 \quad \forall \delta \vec{u}$ holds at the equilibrium and therefore at the deformed geometry. In non-linear analysis, virtual work density of internal forces is expressed in terms of Green-Lagrange strain measure and PK2 stress with $\delta \vec{E} = \vec{F}_c \cdot \delta \vec{\varepsilon} \cdot \vec{F}$ and $dV = JdV^\circ$ (tensor identity $\vec{a} : (\vec{b}_c \cdot \vec{c} \cdot \vec{b}) = (\vec{b} \cdot \vec{a} \cdot \vec{b}_c) : \vec{c}$)

$$\delta W^{\text{int}} = -\int_{\Omega} (\vec{\sigma} : \delta \vec{\varepsilon}_c) dV = -\int_{\Omega^\circ} \vec{\sigma} : (\vec{F}_c^{-1} \cdot \delta \vec{E}_c \cdot \vec{F}^{-1}) J dV^\circ \quad \Rightarrow$$

$$\delta W^{\text{int}} = -\int_{\Omega^\circ} (\vec{F}^{-1} \cdot \vec{\sigma} \cdot \vec{F}_c^{-1} J) : \delta \vec{E}_c dV^\circ = -\int_{\Omega^\circ} (\vec{S} : \delta \vec{E}_c) dV^\circ. \quad \leftarrow$$

$$\delta W^{\text{ext}} = \int_{\Omega} (\rho \vec{g} \cdot \delta \vec{u}) dV + \dots = \int_{\Omega^\circ} (\rho^\circ \vec{g} \cdot \delta \vec{u}) dV^\circ + \dots \quad \leftarrow$$

The virtual work density due to gravity uses the balance law of mass in its local form $\rho dV = \rho^\circ dV^\circ$ or $\rho J = \rho^\circ$ (also $\vec{t} dA = \vec{t}^\circ dA^\circ$).

VIRTUAL WORK DENSITIES

Virtual work densities of the internal forces, inertia forces, external volume forces due to gravity are

$$\delta w_{V^{\circ}}^{\text{int}} = - \begin{Bmatrix} \delta E_{xx} \\ \delta E_{yy} \\ \delta E_{zz} \end{Bmatrix}^T \begin{Bmatrix} S_{xx} \\ S_{yy} \\ S_{zz} \end{Bmatrix} - \begin{Bmatrix} 2\delta E_{xy} \\ 2\delta E_{yz} \\ 2\delta E_{zx} \end{Bmatrix}^T \begin{Bmatrix} S_{xy} \\ S_{yz} \\ S_{zx} \end{Bmatrix},$$

$$\delta w_{V^{\circ}}^{\text{ext}} = \begin{Bmatrix} \delta u_x \\ \delta u_y \\ \delta u_z \end{Bmatrix}^T \rho^{\circ} \begin{Bmatrix} g_x \\ g_y \\ g_z \end{Bmatrix}.$$

External distributed force due to gravity

Virtual work densities consist of terms containing kinematic quantities and their “work conjugates” !

DENSITY EXPRESSIONS FOR BEAMS AND PLATES

In large displacement theory, the displacement assumptions need to be modified to keep the idea of rigid body motion of cross-sections (beams) or line segments (plates). In terms of strain measures, the virtual work densities of internal forces

$$\mathbf{Beam:} \quad \delta w_{\Omega^\circ}^{\text{int}} = -\delta \frac{1}{2} (CAE^2 + CI \kappa^2 + GJ \tau^2),$$

$$\mathbf{Plate:} \quad \delta w_{\Omega^\circ}^{\text{int}} = -\delta \frac{1}{2} \left(\begin{Bmatrix} E_{xx} \\ E_{yy} \\ 2E_{xy} \end{Bmatrix}^T t [C]_{\sigma} \begin{Bmatrix} E_{xx} \\ E_{yy} \\ 2E_{xy} \end{Bmatrix} + \begin{Bmatrix} \kappa_{xx} \\ \kappa_{yy} \\ 2\kappa_{xy} \end{Bmatrix}^T \frac{t^3}{12} [C]_{\sigma} \begin{Bmatrix} \kappa_{xx} \\ \kappa_{yy} \\ 2\kappa_{xy} \end{Bmatrix} \right).$$

The strain measures of the bar, bending and torsion modes of the beam expression depend on Green-Lagrange axial strain E , curvature κ , and torsion τ of the mid-curve.

- Finally, the strain measures need to be expressed in terms of displacement components.

For example, in a xz –plane beam problem

$$E = \frac{du}{dx} + \frac{1}{2} \left(\frac{du}{dx} \right)^2 + \frac{1}{2} \left(\frac{dw}{dx} \right)^2,$$

$$\kappa = \left[\frac{dw}{dx} \frac{d^2u}{dx^2} - \left(1 + \frac{du}{dx} \right) \frac{d^2w}{dx^2} \right] / \left[\left(1 + \frac{du}{dx} \right)^2 + \left(\frac{dw}{dx} \right)^2 \right]^{3/2}.$$

These virtual work densities and the strain measure expressions assume. e.g., a stress-free flat initial geometry, retain only the most significant terms etc. The generic expressions in terms of the three displacement components are lengthy.

5.2 LARGE DISPLACEMENT FEA

- Model a structure as a collection of beam, plate, etc. elements by considering the initial geometry. Derive the element contributions $\delta W^e = \delta W^{\text{int}} + \delta W^{\text{ext}}$ in terms of the nodal displacement and rotation components of the structural coordinate system.
- Sum the element contributions to end up with the virtual work expression of the structure $\delta W = \sum_{e \in E} \delta W^e$. Re-arrange to get $\delta W = -\delta \mathbf{a}^T \mathbf{R}(\mathbf{a})$
- Use the principle of virtual work $\delta W = 0 \quad \forall \delta \mathbf{a}$ and the fundamental lemma of variation calculus for $\delta \mathbf{a} \in \mathbb{R}^n$ to deduce the system equations $\mathbf{R}(\mathbf{a}) = 0$. Find a physically meaningful solution by any of the standard numerical methods for non-linear algebraic equation systems.

BAR MODE

Virtual work expression can be expressed in a concise form in terms of initial and deformed lengths of a bar element

$$\delta W^{\text{int}} = -\delta E_{xx} CA^\circ E_{xx},$$

$$\delta W^{\text{ext}} = \begin{Bmatrix} \delta \vec{u}_1 \cdot \vec{g} \\ \delta \vec{u}_2 \cdot \vec{g} \end{Bmatrix}^T \frac{\rho^\circ A^\circ h^\circ}{2} \begin{Bmatrix} 1 \\ 1 \end{Bmatrix},$$

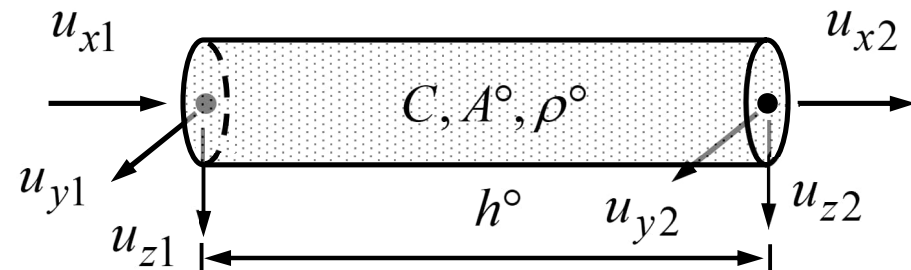

where $E_{xx} = [(h/h^\circ)^2 - 1]/2$ and $h^2 = (h^\circ + u_{x2} - u_{x1})^2 + (u_{y2} - u_{y1})^2 + (u_{z2} - u_{z1})^2$ of the deformed element depends also on the nodal displacements in the y - and z -directions. Transformation into the components of the structural system follows the lines of the linear displacement analysis.

EXAMPLE 5.1 Consider the bar structure shown subjected to large displacements. Determine the relationship between the vertical displacement of node 2 (positive upwards) and force F acting on node 2. Use the principle of virtual work and assume the constitutive equation $S_{xx} = CE_{xx}$, in which Green-Lagrange strain $E_{xx} = [(h/h^\circ)^2 - 1]/2$ and C is constant. Cross-sectional area of the initial geometry is A° .

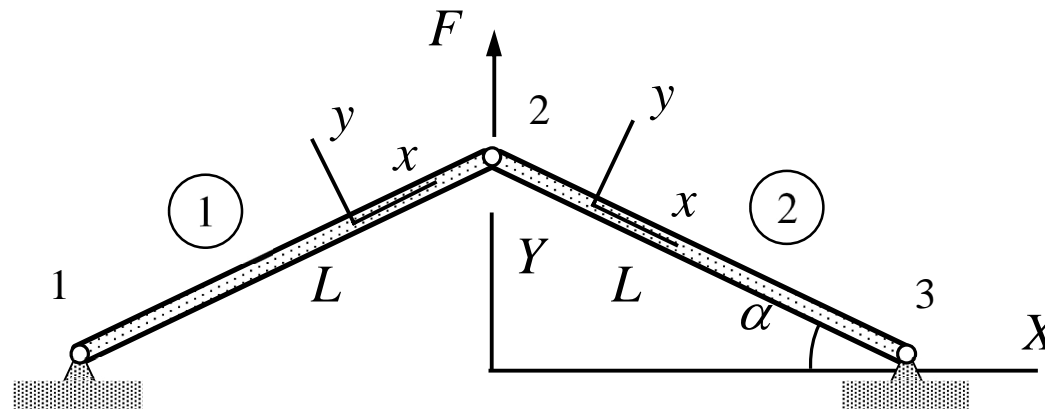

Answer $\frac{F}{CA^\circ} - 2(\sin \alpha + a)(a \sin \alpha + \frac{1}{2}a^2) = 0$ where $a = \frac{u_{Y2}}{L}$

- In (geometrically) non-linear analysis, equilibrium equations are satisfied at the deformed geometry, although the mathematics is related with the initial geometry. Virtual work expressions of internal forces of the bar element and the point force are

$$\delta W^{\text{int}} = -\delta E_{xx} CA^\circ E_{xx} = -\delta h \frac{h}{h^\circ} CA^\circ \frac{1}{2} \left[\left(\frac{h}{h^\circ} \right)^2 - 1 \right] \quad \text{and} \quad \delta W^{\text{ext}} = F \delta u_{Y2}.$$

- For element 1, the relationship between the displacement components in the material coordinate system are $u_{x2} = u_{Y2} \sin \alpha$ and $u_{y2} = u_{Y2} \cos \alpha$ giving ($a = u_{Y2} / L$)

$$h^2 = (L + u_{Y2} \sin \alpha)^2 + (u_{Y2} \cos \alpha)^2 = L^2 (1 + 2a \sin \alpha + a^2) \Rightarrow$$

$$h \delta h = \delta u_{Y2} 2(L \sin \alpha + u_{Y2}) = \delta a L^2 (\sin \alpha + a).$$

- For element 1, the virtual work expression of internal forces takes the form

$$\delta W^{\text{int}} = -\delta h \frac{h}{h^\circ} CA^\circ \frac{1}{2} \left[\left(\frac{h}{h^\circ} \right)^2 - 1 \right] = -\delta a L (\sin \alpha + a) CA^\circ \frac{1}{2} (2a \sin \alpha + a^2).$$

- Virtual work expression of the structure becomes (the internal contribution for bar 2 is the same due to the symmetry). Hence

$$\delta W = 2\delta W^{\text{int}} + \delta W^{\text{ext}} = -\delta a L (\sin \alpha + a) CA^\circ (2a \sin \alpha + a^2) + FL\delta a.$$

- Principle of virtual work and the fundamental lemma of variation calculus give

$$-\delta a [L (\sin \alpha + a) CA^\circ (2a \sin \alpha + a^2) - FL] = 0 \quad \forall \delta a \quad \Leftrightarrow$$

$$(\sin \alpha + a)a(2 \sin \alpha + a) - \frac{F}{CA^\circ} = 0. \quad \leftarrow$$

FORCE-DISPLACEMENT RELATIONSHIP

F / CA°

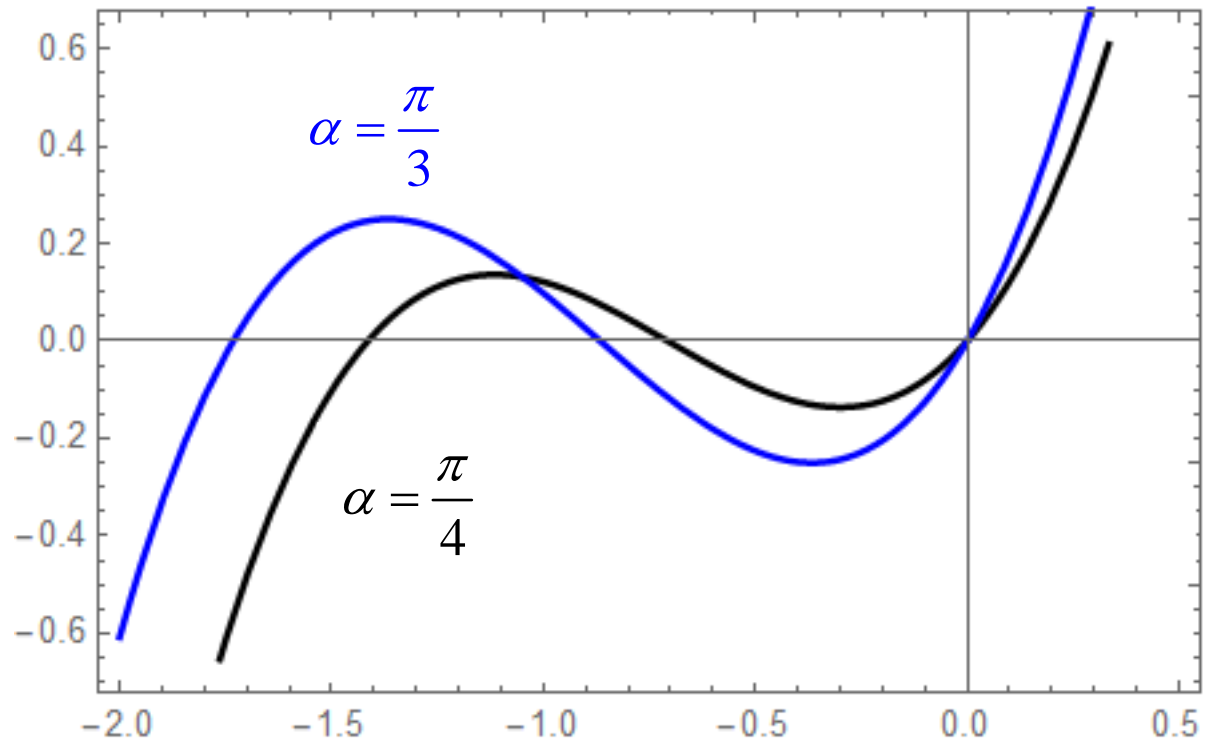

a

EXAMPLE 5.2 Determine the nodal displacement u_{Z2} and u_{Z3} of the bar structure shown. Use non-linear bar elements and linear approximations. Cross-sectional areas and length of the initial geometry are $A = 0.01\text{m}^2$ and $L = 1\text{m}$. Elasticity parameter $C = 100\text{Nm}^{-2}$ and external force $F = 0.05\text{N}$.

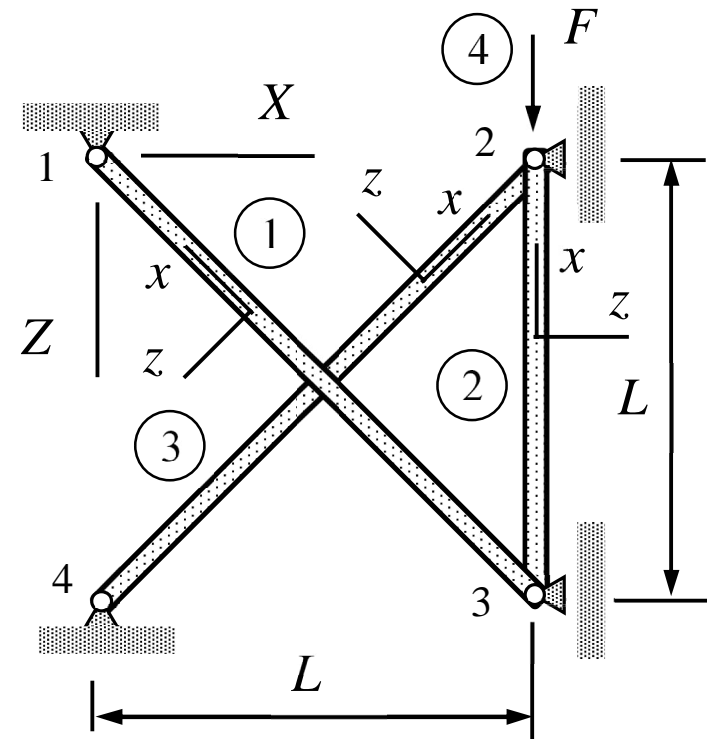

Answer $u_{Z2} \approx 0.085\text{m}$ and $u_{Z3} \approx 0.061\text{m}$

- The physically correct solution is just one of the mathematically correct solutions to the nodal displacements (in this case the number of solutions is 6). The solver for non-linear analysis returns a real valued solution with the minimal norm. In the example, when $L = 1\text{m}$, $A = 0.01\text{m}^2$, $C = E = 100\text{Nm}^{-2}$, and $F = 1/20\text{N}$:

	model	properties	geometry
1	BAR	$\{\{E\}, \{A\}\}$	Line[$\{3, 1\}$]
2	BAR	$\{\{E\}, \{A\}\}$	Line[$\{3, 2\}$]
3	BAR	$\{\{E\}, \{A\}\}$	Line[$\{4, 2\}$]
4	FORCE	$\{0, 0, F\}$	Point[$\{2\}$]

	$\{X, Y, Z\}$	$\{u_X, u_Y, u_Z\}$	$\{\theta_X, \theta_Y, \theta_Z\}$
1	$\{0, 0, 0\}$	$\{0, 0, 0\}$	$\{0, 0, 0\}$
2	$\{L, 0, 0\}$	$\{0, 0, u_Z[2]\}$	$\{0, 0, 0\}$
3	$\{L, 0, L\}$	$\{0, 0, u_Z[3]\}$	$\{0, 0, 0\}$
4	$\{0, 0, L\}$	$\{0, 0, 0\}$	$\{0, 0, 0\}$

$\{u_Z[2] \rightarrow 0.0854082, u_Z[3] \rightarrow 0.0609567\}$

5.3 ELEMENT CONTRIBUTIONS

Virtual work expressions for the elements combine virtual work densities of the model and an approximation depending on the element shape and type. To derive the expression for an element:

- Start with the large displacement versions of the virtual work densities $\delta w_{\Omega^0}^{\text{int}}$ and $\delta w_{\Omega^0}^{\text{ext}}$ of the formulae collection.
- Represent the unknown functions by interpolation of the nodal displacement and rotations (see formulae collection). Substitute the approximations into the density expressions.
- Integrate the virtual work density over the domain occupied by the element at the initial geometry to get δW .

ELEMENT APPROXIMATION

In MEC-E8001 element approximation is a polynomial interpolant of the nodal displacements and rotations in terms of shape functions. In non-linear analysis, approximations, shape functions etc. are written for the initial geometry.

Approximation $\mathbf{u} = \mathbf{N}^T \mathbf{a}$ **always of the same form!**

Shape functions $\mathbf{N} = \{N_1(x, y, z) \quad N_2(x, y, z) \quad \dots \quad N_n(x, y, z)\}^T$

Parameters $\mathbf{a} = \{a_1 \quad a_2 \quad \dots \quad a_n\}^T$

Nodal parameters $\mathbf{a} \in \{u_x, u_y, u_z, \theta_x, \theta_y, \theta_z\}$ may be just displacement or rotation components or a mixture of them (as with the beam model).

SOLID MODEL

The model does not contain kinetic or kinematic assumptions in addition to those of non-linear elasticity theory. Virtual work density expression of the internal and external forces for the initial geometry are given by

$$\delta w_{V^\circ}^{\text{int}} = - \begin{Bmatrix} \delta E_{xx} \\ \delta E_{yy} \\ \delta E_{zz} \end{Bmatrix}^T [C] \begin{Bmatrix} E_{xx} \\ E_{yy} \\ E_{zz} \end{Bmatrix} - \begin{Bmatrix} 2\delta E_{xy} \\ 2\delta E_{yz} \\ 2\delta E_{zx} \end{Bmatrix}^T G \begin{Bmatrix} 2E_{xy} \\ 2E_{yz} \\ 2E_{zx} \end{Bmatrix},$$

$$\delta w_{V^\circ}^{\text{ext}} = \delta \vec{u} \cdot \vec{g} \rho^\circ \quad \text{and} \quad \delta w_{A^\circ}^{\text{ext}} = \delta \vec{u} \cdot \vec{t}^\circ.$$

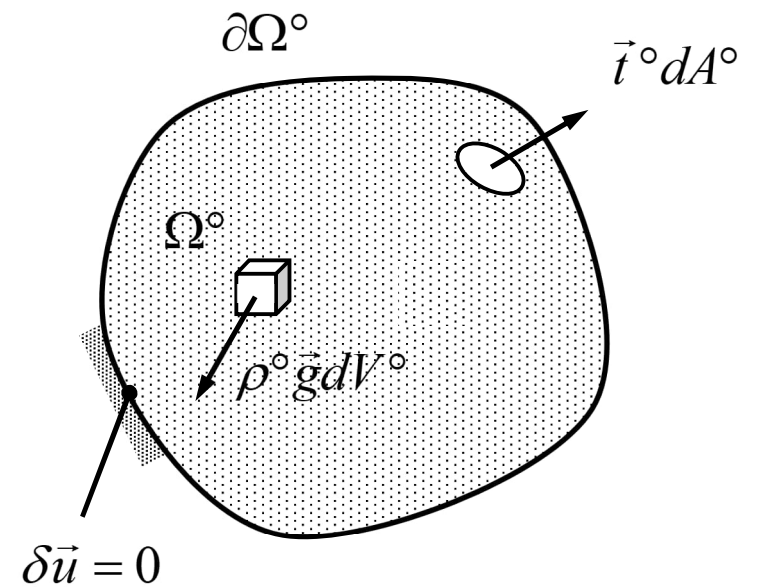

The solution domain can be represented, e.g., by tetrahedron elements with linear interpolation of the displacement components $u(x, y, z)$, $v(x, y, z)$, and $w(x, y, z)$

EXAMPLE 5.3 A tetrahedron of edge length L , density ρ , and elastic properties C and ν is subjected to its own weight on a horizontal floor. Determine the equilibrium equation for the displacement u_{Z3} of node 3 with one tetrahedron element and linear approximation. Assume that $u_{X3} = u_{Y3} = 0$ and that the bottom surface is fixed and that the geometry and density described is concerned with the initial geometry (gravity omitted).

Answer: $(1+a)a(1+\frac{1}{2}a) + F = 0$ where

$$F = \frac{1}{4} \frac{1-\nu-2\nu^2}{1-\nu} \frac{\rho g L^3}{C} \quad \text{and} \quad a = \frac{u_{Z3}}{L} .$$

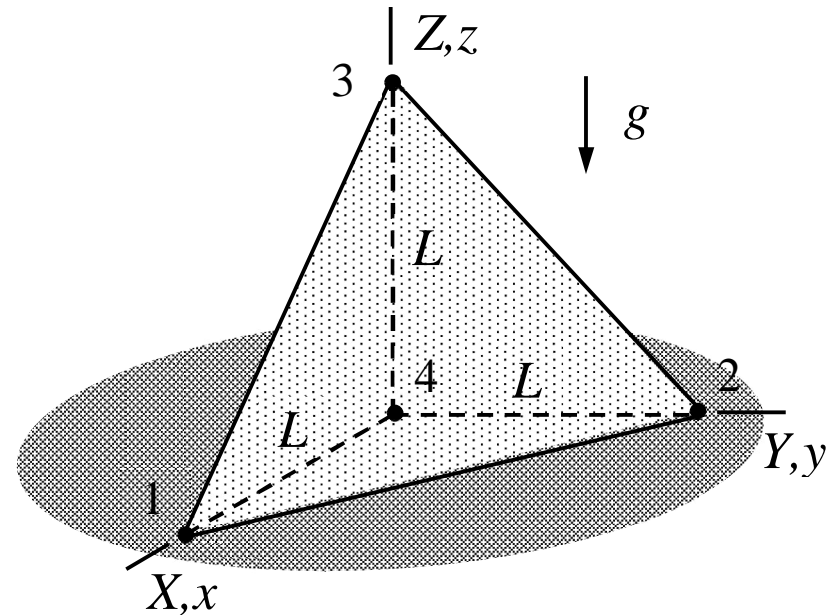

- Linear shape functions can be deduced directly from the figure $N_1 = x/L$, $N_2 = y/L$, $N_3 = z/L$, and $N_4 = 1 - x/L - y/L - z/L$. Only the shape function of node 3 is actually needed as the other nodes are fixed. Approximations to the displacement components are

$$u_x = u_y = 0 \quad \text{and} \quad u_z = \frac{z}{L}u_{Z3}, \quad \text{giving} \quad \frac{\partial u_z}{\partial x} = \frac{\partial u_z}{\partial y} = 0 \quad \text{and} \quad \frac{\partial u_z}{\partial z} = \frac{1}{L}u_{Z3}.$$

- When the approximation is substituted there, the non-zero Green-Lagrange strain component takes the form

$$E_{zz} = \frac{1}{L}u_{Z3} + \frac{1}{2L^2}u_{Z3}^2 \quad \Rightarrow \quad \delta E_{zz} = \frac{1}{L}\delta u_{Z3} + \frac{1}{L^2}u_{Z3}\delta u_{Z3}.$$

- Virtual work densities of the internal and external forces simplify to (we assume that the material is described by the constitutive equation of linear elasticity theory in which the Young's modulus E is replaced by elasticity parameter C)

$$\delta w_{V^{\circ}}^{\text{int}} = -\delta E_{zz} S_{zz} = \frac{-C(1-\nu)}{(1+\nu)(1-2\nu)} \delta u_{Z3} \left(\frac{1}{L} + \frac{1}{L^2} u_{Z3} \right) \left(\frac{1}{L} u_{Z3} + \frac{1}{2L^2} u_{Z3}^2 \right),$$

$$\delta w_{V^{\circ}}^{\text{ext}} = -\delta u_z \rho g = -\frac{z}{L} \rho g \delta u_{Z3}.$$

- Virtual work expressions are obtained as integrals of densities over the volume occupied by the body at the initial geometry. With $a = u_{Z3} / L$

$$\delta W^{\text{int}} = \int_{\Omega^{\circ}} \delta w_{V^{\circ}}^{\text{int}} dV = \delta w_{V^{\circ}}^{\text{int}} \frac{L^3}{6} = -\frac{L^2}{6} \frac{1-\nu}{(1+\nu)(1-2\nu)} C \delta u_{Z3} (1+a) \left(a + \frac{1}{2} a^2 \right),$$

$$\delta W^{\text{ext}} = \int_{\Omega^{\circ}} \delta w_{V^{\circ}}^{\text{ext}} dV = -\frac{L^3}{24} \rho g \delta u_{Z3}.$$

- Finally, principle of virtual work $\delta W = 0$ with $\delta W = \delta W^{\text{int}} + \delta W^{\text{ext}}$ implies the equilibrium equation

$$\frac{L^2}{6} \frac{C(1-\nu)}{(1+\nu)(1-2\nu)} (1+a)(a + \frac{1}{2}a^2) + \frac{L^3}{24} \rho g = 0. \quad \leftarrow$$

- In terms of $F = \frac{1}{4} \frac{1-\nu-2\nu^2}{1-\nu} \frac{\rho g L}{C}$ the physically meaningful solution is given by

$$a = \frac{1}{3^{1/3} \alpha} + \frac{\alpha}{3^{2/3}} - 1 \quad \text{where} \quad \alpha = (-9F + \sqrt{3} \sqrt{-1 + 27F^2})^{1/3}.$$

THIN SLAB MODE

Virtual work densities of plate combine the thin-slab and plate bending modes. Assuming that the two modes de-couple and the bending mode can be omitted

$$\delta w_{\Omega^\circ}^{\text{int}} = - \begin{Bmatrix} \delta E_{xx} \\ \delta E_{yy} \\ 2\delta E_{xy} \end{Bmatrix}^T t^\circ [C]_\sigma \begin{Bmatrix} E_{xx} \\ E_{yy} \\ 2E_{xy} \end{Bmatrix}, \quad \delta w_{\Omega^\circ}^{\text{ext}} = \begin{Bmatrix} \delta u \\ \delta v \end{Bmatrix}^T \rho^\circ t^\circ \begin{Bmatrix} g_x \\ g_y \end{Bmatrix} \quad \text{where}$$

$$\begin{Bmatrix} E_{xx} \\ E_{yy} \\ 2E_{xy} \end{Bmatrix} = \begin{Bmatrix} \partial u / \partial x \\ \partial v / \partial y \\ \partial u / \partial y + \partial v / \partial x \end{Bmatrix} + \begin{Bmatrix} (\partial u / \partial x)^2 / 2 + (\partial v / \partial x)^2 / 2 \\ (\partial u / \partial y)^2 / 2 + (\partial v / \partial y)^2 / 2 \\ (\partial u / \partial x)(\partial u / \partial y) + (\partial v / \partial x)(\partial v / \partial y) \end{Bmatrix}.$$

The planar solution domain Ω° (reference-plane of the initial geometry) can be represented by triangular or rectangular elements.

EXAMPLE 5.4 Consider the thin triangular structure shown. Assuming plane-stress conditions and xy -plane deformation, determine the equation for the displacement $u_{X1} = aL$ and $u_{Y1} = aL$ of node 1 according to the large displacement theory. Young's modulus E , Poisson's ratio ν , and thickness t are constants and distributed external force vanishes.

Answer:
$$(-1 + 2a)L \frac{tE}{1 - \nu^2} a(-1 + a) - F = 0$$

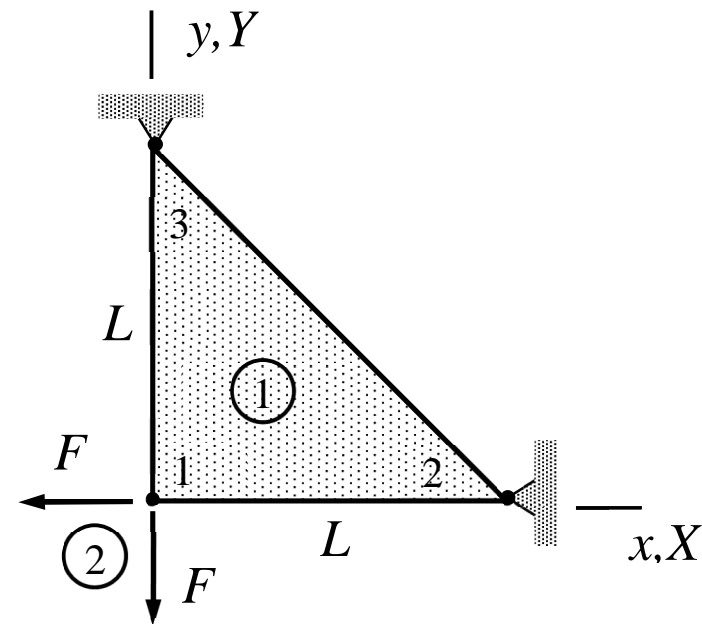

- Nodes 2 and 3 are fixed and the non-zero displacement/rotation components are $u_{X1} = aL$ and $u_{Y1} = aL$. Linear shape functions $N_1 = (L - x - y)/L$, $N_2 = x/L$ and $N_3 = y/L$ are easy to deduce from the figure. Therefore $u = v = (L - x - y)a$ and

$$\begin{Bmatrix} E_{xx} \\ E_{yy} \\ 2E_{xy} \end{Bmatrix} = \begin{Bmatrix} 1 \\ 1 \\ 2 \end{Bmatrix} (-a + a^2) \Rightarrow \begin{Bmatrix} \delta E_{xx} \\ \delta E_{yy} \\ 2\delta E_{xy} \end{Bmatrix} = \delta a(-1 + 2a) \begin{Bmatrix} 1 \\ 1 \\ 2 \end{Bmatrix}.$$

- Virtual work density of internal forces simplifies to

$$\delta W_{\Omega^o}^{\text{int}} = - \begin{Bmatrix} \delta E_{xx} \\ \delta E_{yy} \\ 2\delta E_{xy} \end{Bmatrix}^T t[C]_{\sigma} \begin{Bmatrix} E_{xx} \\ E_{yy} \\ 2E_{xy} \end{Bmatrix} = -\delta a(-1 + 2a) \frac{4tE}{1-\nu^2} (-a + a^2).$$

- Integration over the triangular domain gives (integrand is constant)

$$\delta W^1 = -\delta a(-1+2a)L^2 \frac{2tE}{1-\nu^2}(-a+a^2).$$

- Virtual work expression for the point forces follows from the definition of work

$$\delta W^2 = -2\delta aLF .$$

- Principle of virtual work in the form $\delta W = \delta W^1 + \delta W^2 = 0 \quad \forall \delta a$ and the fundamental lemma of variation calculus give

$$\delta W = -\delta aL[(-1+2a)L\frac{2tE}{1-\nu^2}(-a+a^2) - 2F] = 0 \quad \forall \delta a \Leftrightarrow$$

$$(-1+2a)L\frac{2tE}{1-\nu^2}(-a+a^2) - 2F = 0. \quad \leftarrow$$

The point forces acting on a thin slab should be considered as “equivalent nodal forces” i.e. just representations of tractions acting on some part of the boundary. Under the action of an actual point force, displacement becomes non-bounded. In practice, numerical solution to the displacement at the point of action increases when the mesh is refined.

- In the Mathematica code of the course, the problem description is given by

	model	properties	geometry
1	PLANE	$\{\{E, \nu\}, \{t\}\}$	<code>Polygon[{1, 2, 3}]</code>
2	FORCE	$\{-F, -F, 0\}$	<code>Point[{1}]</code>

	$\{X, Y, Z\}$	$\{u_X, u_Y, u_Z\}$	$\{\theta_X, \theta_Y, \theta_Z\}$
1	$\{0, 0, 0\}$	$\{L a[1], L a[1], 0\}$	$\{0, 0, 0\}$
2	$\{L, 0, 0\}$	$\{0, 0, 0\}$	$\{0, 0, 0\}$
3	$\{0, L, 0\}$	$\{0, 0, 0\}$	$\{0, 0, 0\}$

$$\delta W = -(\delta \mathbf{a}[1])^T \left(-\frac{2L(F - F\nu^2 + LtEa[1](1 - 3a[1] + 2a[1]^2))}{-1 + \nu^2} \right)$$

BAR MODE

With the assumptions of the bar model $\vec{u} = u(x)\vec{i} + v(x)\vec{j} + w(x)\vec{k}$, $\vec{S} = S_{xx}\vec{ii}$ etc. in the generic expressions for large displacement analysis for the solid model simplify to

$$\delta w_{\Omega^\circ}^{\text{int}} = -\delta E_{xx} A^\circ C E_{xx},$$

$$\delta w_{\Omega^\circ}^{\text{ext}} = A^\circ \rho^\circ \delta \vec{u} \cdot \vec{g},$$

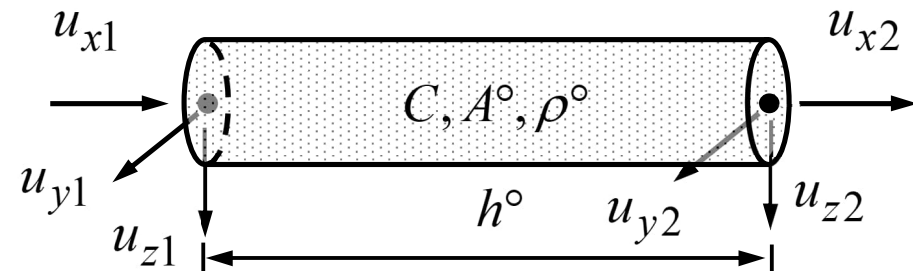

where $E_{xx} = \frac{du}{dx} + \frac{1}{2}\left(\frac{du}{dx}\right)^2 + \frac{1}{2}\left(\frac{dv}{dx}\right)^2 + \frac{1}{2}\left(\frac{dw}{dx}\right)^2$.

In FEA, the solution domain (a line segment) is represented by line elements and the displacement components $u(x)$, $v(x)$, $w(x)$ by their interpolants.

- Let us start with the kinematical assumption $\vec{u} = u(x)\vec{i} + v(x)\vec{j} + w(x)\vec{k}$. The kinetic assumption is $\vec{S} = S_{xx}\vec{ii}$. Green-Lagrange strain and its variation are

$$E_{xx} = \frac{du}{dx} + \frac{1}{2}\left(\frac{du}{dx}\right)^2 + \frac{1}{2}\left(\frac{dv}{dx}\right)^2 + \frac{1}{2}\left(\frac{dw}{dx}\right)^2, \quad \delta E_{xx} = \frac{d\delta u}{dx} + \frac{d\delta u}{dx} \frac{du}{dx} + \frac{d\delta v}{dx} \frac{dv}{dx} + \frac{d\delta w}{dx} \frac{dw}{dx}.$$

- Assuming the constitutive equation $S_{xx} = CE_{xx}$, virtual work densities of the internal and external forces per unit length of the initial domain become (expression is integrated over the cross section of the initial geometry)

$$\delta w_{\Omega^0}^{\text{int}} = -\delta E_{xx} A^0 C E_{xx} \quad \text{and} \quad \delta w_{\Omega^0}^{\text{ext}} = A^0 \rho^0 (\delta u g_x + \delta v g_y + \delta w g_z). \quad \leftarrow$$

BAR MODE

Virtual work expression can be expressed in a concise form in terms of initial and deformed lengths of a bar element

$$\delta W^{\text{int}} = -\delta E_{xx} CA^\circ E_{xx},$$

$$\delta W^{\text{ext}} = \begin{Bmatrix} \delta \vec{u}_1 \cdot \vec{g} \\ \delta \vec{u}_2 \cdot \vec{g} \end{Bmatrix}^T \frac{\rho^\circ A^\circ h^\circ}{2} \begin{Bmatrix} 1 \\ 1 \end{Bmatrix},$$

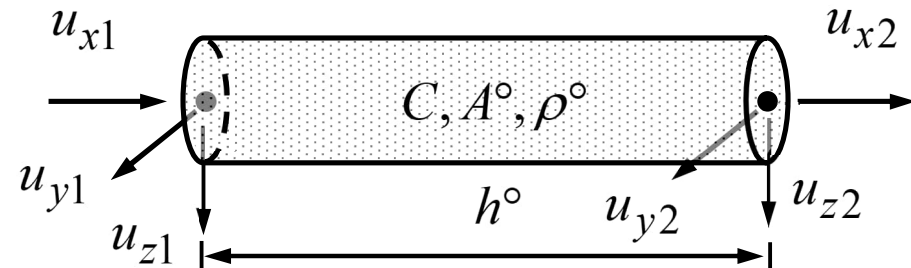

where $E_{xx} = [(h/h^\circ)^2 - 1]/2$ and $h^2 = (h^\circ + u_{x2} - u_{x1})^2 + (u_{y2} - u_{y1})^2 + (u_{z2} - u_{z1})^2$ of the deformed element depends also on the nodal displacements in the y - and z -directions. Transformation into the components of the structural system follows the lines of the linear displacement analysis.

- Linear approximations to the displacement components give constant values to the derivatives du/dx , dv/dx , and dw/dx and the Green-Lagrange strain component E_{xx} is simply the relative difference in the squares of lengths:

$$E_{xx} = \frac{1}{2} \frac{h^2 - (h^\circ)^2}{(h^\circ)^2} = \frac{1}{2} \left[\left(\frac{h}{h^\circ} \right)^2 - 1 \right] \quad \text{and} \quad \delta E_{xx} = \frac{\delta h}{h^\circ} \frac{h}{h^\circ}.$$

- As virtual work density of internal forces is constant and the approximation linear Virtual works of internal and external forces become

$$\delta W^{\text{int}} = \delta w_{\Omega^\circ}^{\text{int}} h^\circ = -\delta h \frac{h}{h^\circ} CA^\circ \frac{1}{2} \left[\left(\frac{h}{h^\circ} \right)^2 - 1 \right], \quad \leftarrow$$

$$\delta W^{\text{ext}} = \begin{Bmatrix} g_x \delta u_{x1} + g_y \delta u_{y1} + g_z \delta u_{z1} \\ g_x \delta u_{x2} + g_y \delta u_{y2} + g_z \delta u_{z2} \end{Bmatrix}^T \frac{1}{2} \rho^\circ h^\circ A^\circ \begin{Bmatrix} 1 \\ 1 \end{Bmatrix}. \quad \leftarrow$$

- It is noteworthy that PK2 does not represent the true stress in bar. The constitutive equation for the (true) axial force in terms of Green-Lagrange strain follows from the relationship between the Cauchy stress and PK2 stress. Here the relationship $J\vec{\sigma} = \vec{F} \cdot \vec{S} \cdot \vec{F}_c$ simplifies to $J\sigma = F S F$ in which $J = V / V^\circ = hA / h^\circ A^\circ$ and $F = h / h^\circ$ giving

$$S = \frac{h^\circ}{h} \sigma \frac{h^\circ}{h} \frac{hA}{h^\circ A^\circ} = \frac{h^\circ}{hA^\circ} (\sigma A) = \frac{h^\circ}{hA^\circ} N \quad \Rightarrow \quad N = \frac{h}{h^\circ} A^\circ S = \frac{h}{h^\circ} A^\circ CE.$$

- Using the axial force N and the variation δh (at deformed geometry)

$$\delta W^{\text{int}} = -N\delta h = -\delta h \frac{h}{h^\circ} CA^\circ \frac{1}{2} \left[\left(\frac{h}{h^\circ} \right)^2 - 1 \right] \quad (\text{same as earlier}).$$

EXAMPLE 5.5 Write the virtual work expression of the structure shown in terms of the nodal displacement u_{Z2} and u_{Z3} . Use non-linear bar elements and linear approximations. Solve for the nodal displacement when the cross-sectional areas and material properties are $L = 1\text{m}$, $A^\circ = 1/100\text{m}^2$, $C = 100\text{Nm}^{-2}$ and $F = 1/20\text{N}$.

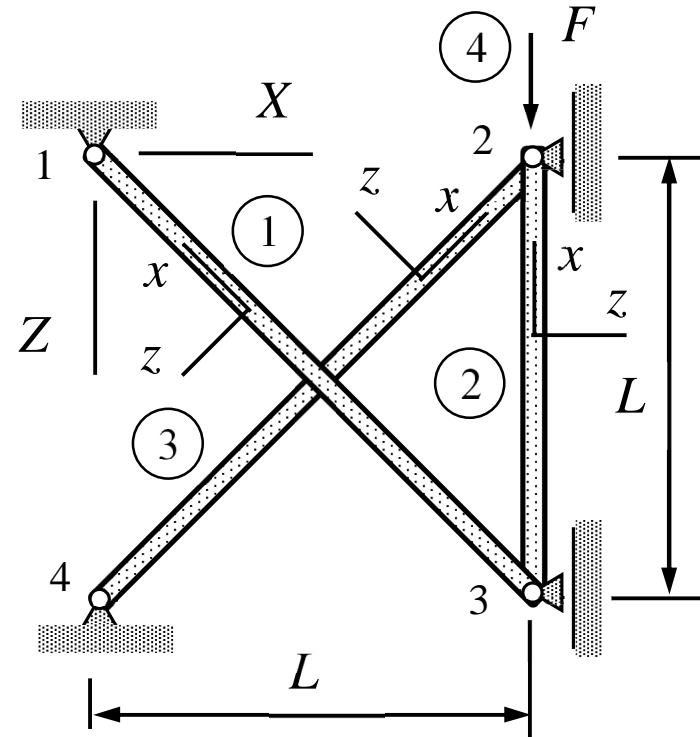

Answer $u_{Z2} = 0.085\text{m}$ and $u_{Z3} = 0.061\text{m}$

- For bar 1, the nodal displacement components of material coordinate system are $u_{x1} = u_{z1} = 0$, $u_{x3} = -u_{z3} / \sqrt{2}$, and $u_{y3} = u_{z3} / \sqrt{2}$. As approximations are linear, derivatives are

$$\frac{du}{dx} = \left(0 + \frac{u_{z3}}{\sqrt{2}}\right) \frac{1}{\sqrt{2}L} = \frac{u_{z3}}{2L}, \quad \frac{dv}{dx} = 0, \quad \frac{dw}{dx} = \left(0 - \frac{u_{z3}}{\sqrt{2}}\right) \frac{1}{\sqrt{2}L} = -\frac{u_{z3}}{2L}.$$

$$E_{xx} = \frac{1}{2} \frac{u_{z3}}{L} \left(1 + \frac{1}{2} \frac{u_{z3}}{L}\right) \quad \Rightarrow \quad \delta E_{xx} = \frac{1}{2} \frac{\delta u_{z3}}{L} \left(1 + \frac{u_{z3}}{L}\right).$$

When the approximations are substituted there, virtual work expression of internal forces simplifies to (density is constant)

$$\delta W^1 = -\delta u_{z3} \left(1 + \frac{u_{z3}}{L}\right) \frac{CA^\circ}{4\sqrt{2}} \frac{u_{z3}}{L} \left(2 + \frac{u_{z3}}{L}\right).$$

- For bar 2, the nodal displacement components are $u_{x3} = -u_{Z3}$, $u_{x2} = -u_{Z2}$ and $u_{z2} = u_{z3} = 0$. As approximations are linear, derivatives and the Green-Lagrange strains take the forms

$$\frac{du}{dx} = \frac{u_{x2} - u_{x3}}{L} = \frac{u_{Z3} - u_{Z2}}{L}, \quad \frac{dv}{dx} = 0, \quad \text{and} \quad \frac{dw}{dx} = 0.$$

$$E_{xx} = \frac{u_{Z3} - u_{Z2}}{L} \left(1 + \frac{1}{2} \frac{u_{Z3} - u_{Z2}}{L}\right) \quad \Rightarrow \quad \delta E_{xx} = \frac{\delta u_{Z3} - \delta u_{Z2}}{L} \left(1 + \frac{u_{Z3} - u_{Z2}}{L}\right).$$

When the approximations are substituted there, virtual work expression of internal forces simplifies to

$$\delta W^2 = -(\delta u_{Z3} - \delta u_{Z2}) \left(1 + \frac{u_{Z3} - u_{Z2}}{L}\right) CA \frac{u_{Z3} - u_{Z2}}{L} \left(1 + \frac{1}{2} \frac{u_{Z3} - u_{Z2}}{L}\right).$$

- For bar 3, the nodal displacement components are $u_{x4} = u_{z4} = 0$, $u_{x2} = -u_{Z2} / \sqrt{2}$, and $u_{z2} = -u_{Z2} / \sqrt{2}$. As approximations are linear, derivatives and the Green-Lagrange strain take the forms

$$\frac{du}{dx} = \left(-\frac{u_{Z2}}{\sqrt{2}}\right) \frac{1}{\sqrt{2}L} = -\frac{u_{Z2}}{2L}, \quad \frac{dv}{dx} = 0, \quad \text{and} \quad \frac{dw}{dx} = \left(-\frac{u_{Z2}}{\sqrt{2}}\right) \frac{1}{\sqrt{2}L} = -\frac{u_{Z2}}{2L}.$$

$$E_{xx} = \frac{1}{2} \frac{u_{Z2}}{L} \left(-1 + \frac{1}{2} \frac{u_{Z2}}{L}\right) \quad \Rightarrow \quad \delta E_{xx} = \frac{1}{2} \frac{\delta u_{Z2}}{L} \left(-1 + \frac{u_{Z2}}{L}\right).$$

When the approximations are substituted there, virtual work expression of internal forces simplifies to (density is constant)

$$\delta W^3 = -\frac{CA^\circ}{4\sqrt{2}} \delta u_{Z2} \left(-1 + \frac{u_{Z2}}{L}\right) \frac{u_{Z2}}{L} \left(-2 + \frac{u_{Z2}}{L}\right).$$

- Virtual work expression is sum of the element contributions. By taking into account also the point force contribution $\delta W^4 = \delta u_{Z2} F$

$$\delta W = -\delta u_{Z3} \left(1 + \frac{u_{Z3}}{L}\right) \frac{CA^\circ}{4\sqrt{2}} \frac{u_{Z3}}{L} \left(2 + \frac{u_{Z3}}{L}\right) - (\delta u_{Z3} - \delta u_{Z2}) \left(1 + \frac{u_{Z3} - u_{Z2}}{L}\right) \times$$

$$CA^\circ \frac{u_{Z3} - u_{Z2}}{L} \left(1 + \frac{1}{2} \frac{u_{Z3} - u_{Z2}}{L}\right) - \delta u_{Z2} \left(-1 + \frac{u_{Z2}}{L}\right) \frac{CA^\circ}{4\sqrt{2}} \frac{u_{Z2}}{L} \left(-2 + \frac{u_{Z2}}{L}\right) + \delta u_{Z2} F .$$

- Principle of virtual work and the fundamental lemma of variation calculus give a non-linear algebraic equation system for the non-zero displacement components u_{Z2} and u_{Z3} . In most cases, finding an analytical solution in terms of the parameters of the problem is not possible.

EXAMPLE 5.6 A bar truss is loaded by a point force having magnitude F as shown in the figure. Determine the equilibrium equations according to the large displacement theory. At the initial (non-loaded) geometry, cross-sectional area of bar 1 is A° and that for bar 2 $A^\circ / \sqrt{2}$. Also, find the solution for $L = 1\text{m}$, $A^\circ = 1/100\text{m}^2$, $C = 100\text{Nm}^{-2}$ and $F = 1/20\text{N}$.

Answer $u_{X2} = -0.085\text{m}$ and $u_{Z2} = 0.25\text{m}$

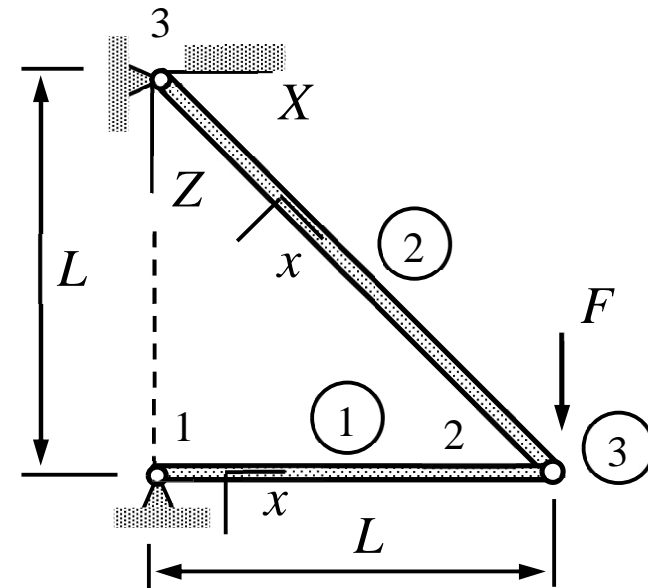

- For bar 1, the nodal displacement components of material coordinate system are $u_{x1} = u_{z1} = 0$, $u_{x2} = u_{X2}$, and $u_{z2} = u_{Z2}$. As the approximations are linear

$$\frac{du}{dx} = \frac{u_{X2}}{L}, \quad \frac{dv}{dx} = 0, \quad \text{and} \quad \frac{dw}{dx} = \frac{u_{Z2}}{L}$$

and the virtual work expression (density is constant) of internal forces simplifies to

$$\delta W^1 = -(\delta u_{X2} + \delta u_{X2} \frac{u_{X2}}{L} + \delta u_{Z2} \frac{u_{Z2}}{L}) CA \left[\frac{u_{X2}}{L} + \frac{1}{2} \left(\frac{u_{X2}}{L} \right)^2 + \frac{1}{2} \left(\frac{u_{Z2}}{L} \right)^2 \right].$$

- For bar 2, the nodal displacement components of material coordinate system are $u_{x3} = u_{z3} = 0$, $u_{x2} = (u_{X2} + u_{Z2}) / \sqrt{2}$ and $u_{z2} = (-u_{X2} + u_{Z2}) / \sqrt{2}$ (notice the use of initial geometry). As the approximations are linear

$$\frac{du}{dx} = \frac{u_{X2} + u_{Z2}}{L}, \quad \frac{dw}{dx} = \frac{u_{Z2} - u_{X2}}{L}$$

and the virtual work expression (density is constant) of internal forces simplifies to

$$\delta W^2 = -[\delta u_{X2} + \delta u_{Z2} + (\delta u_{X2} + \delta u_{Z2})\left(\frac{u_{X2} + u_{Z2}}{L}\right) + (\delta u_{Z2} - \delta u_{X2})\left(\frac{u_{Z2} - u_{X2}}{L}\right)] \times$$

$$CA^\circ \left[\left(\frac{u_{X2} + u_{Z2}}{L}\right) + \frac{1}{2} \left(\frac{u_{X2} + u_{Z2}}{L}\right)^2 + \frac{1}{2} \left(\frac{u_{Z2} - u_{X2}}{L}\right)^2 \right].$$

- Virtual work expression of the point follows from definition of work

$$\delta W^3 = F \delta u_{Z2}.$$

- Virtual work expression is sum of the element contributions. After a considerable amount of manipulations, the standard form with notations $a_1 = u_{X2} / L$ and $a_2 = u_{Z2} / L$

$$\delta W = -\frac{EA}{8} \begin{Bmatrix} \delta u_{X2} \\ \delta u_{Z2} \end{Bmatrix}^T \begin{Bmatrix} -(1+a_1)(10a_1 + 5a_1^2 + 2a_2 + 5a_2^2) \\ 8\frac{F}{EA} - [2a_1(1+5a_2) + a_1^2(1+5a_2) + a_2(2+3a_2+5a_2^2)] \end{Bmatrix} = 0.$$

- Principle of virtual work and the fundamental lemma of variation calculus give a non-linear algebraic equation system ($a_1 = u_{Z3} / L$ and $a_2 = u_{Z2} / L$)

$$\begin{Bmatrix} -(1+a_1)(10a_1 + 5a_1^2 + 2a_2 + 5a_2^2) \\ 8\frac{F}{EA} - [2a_1(1+5a_2) + a_1^2(1+5a_2) + a_2(2+3a_2+5a_2^2)] \end{Bmatrix} = 0. \quad \leftarrow$$

- It is obvious that finding an analytical solution in terms of the parameters of the problem becomes impossible even when the truss is very simple if the number of non-zero displacement components exceeds one. Mathematica code of the course gives the real

valued solution with the minimal norm (that is likely to be the physically meaningful solution when the initial displacement is zero) ($L=1\text{m}$, $A^\circ=1/100\text{m}^2$, $E=C=100\text{Nm}^{-2}$ and $F=1/20\text{N}$).

	model	properties	geometry
1	BAR	$\{\{E\}, \{A\}\}$	Line [$\{1, 2\}$]
2	BAR	$\{\{E\}, \{\frac{A}{\sqrt{2}}\}\}$	Line [$\{3, 2\}$]
3	FORCE	$\{0, 0, F\}$	Point [$\{2\}$]

	$\{X, Y, Z\}$	$\{u_X, u_Y, u_Z\}$	$\{\theta_X, \theta_Y, \theta_Z\}$
1	$\{0, 0, L\}$	$\{0, 0, 0\}$	$\{0, 0, 0\}$
2	$\{L, 0, L\}$	$\{u_X[2], 0, u_Z[2]\}$	$\{0, 0, 0\}$
3	$\{0, 0, 0\}$	$\{0, 0, 0\}$	$\{0, 0, 0\}$

$$\{u_X[2] \rightarrow -0.0848497, u_Z[2] \rightarrow 0.25\}$$