



Aalto University
School of Chemical
Engineering

CHEM-E0115 Planning and Execution of a Biorefinery Project (5 cr)

*Lecture 7: Working at site (commissioning and start-up phase), experiences
from site
October 27, 2022
Tuomas Turkama*

Tuomas Turkama

AFRY Finland Oy
Technology Specialist, Paper
Process Industries Finland

M.Sc. Paper Technology
Helsinki University of Technology



COMMISSIONING & START-UP

The nature of an investment project execution can be like a conquest of mountain

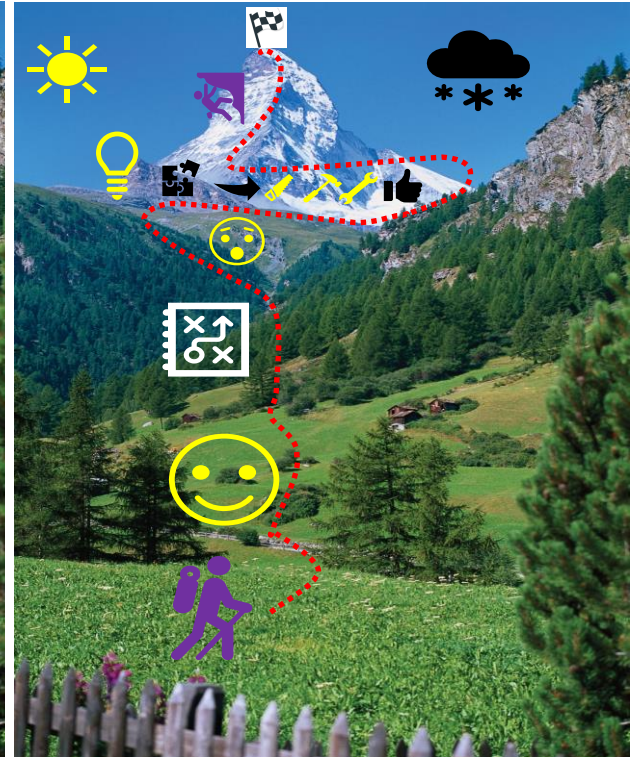
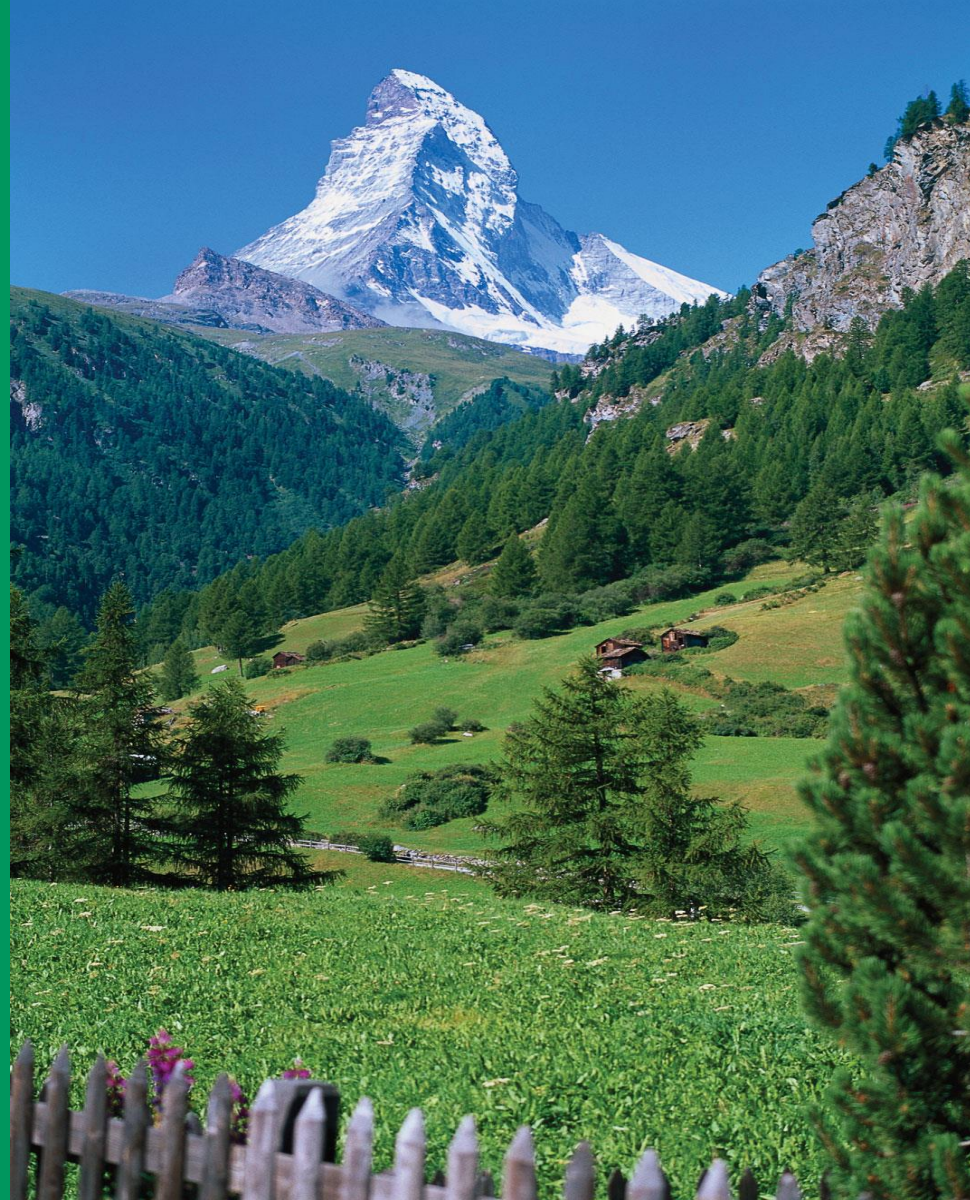

Table of contents

1. Commissioning as a part of an investment project
2. Preparation tasks for commissioning
3. Execution of commissioning
4. Examples occurrences during commissioning



Aalto University
School of Chemical
Engineering



1. Commissioning as a part of an investment project

Commissioning

- Commissioning: Activities after the installation, but before the start-up
- Target: Secure a safe and successful start-up in adherence to the planned schedule



- Activities: Check-outs, functional testing, lubrication, water run, internal cleaning and flushing

Project life cycle and Start-up phase

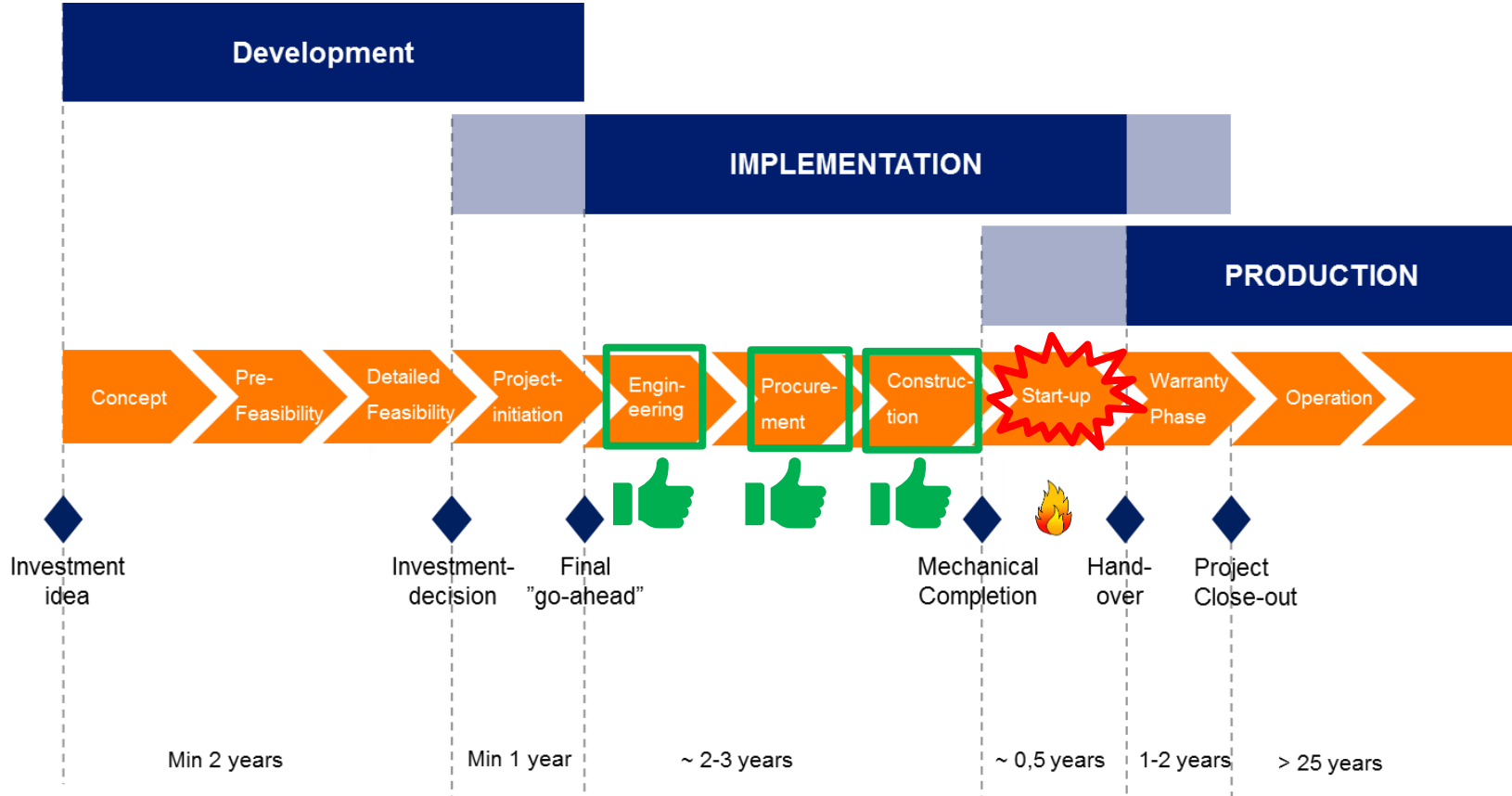

Start-up activities

Model of start-up logic

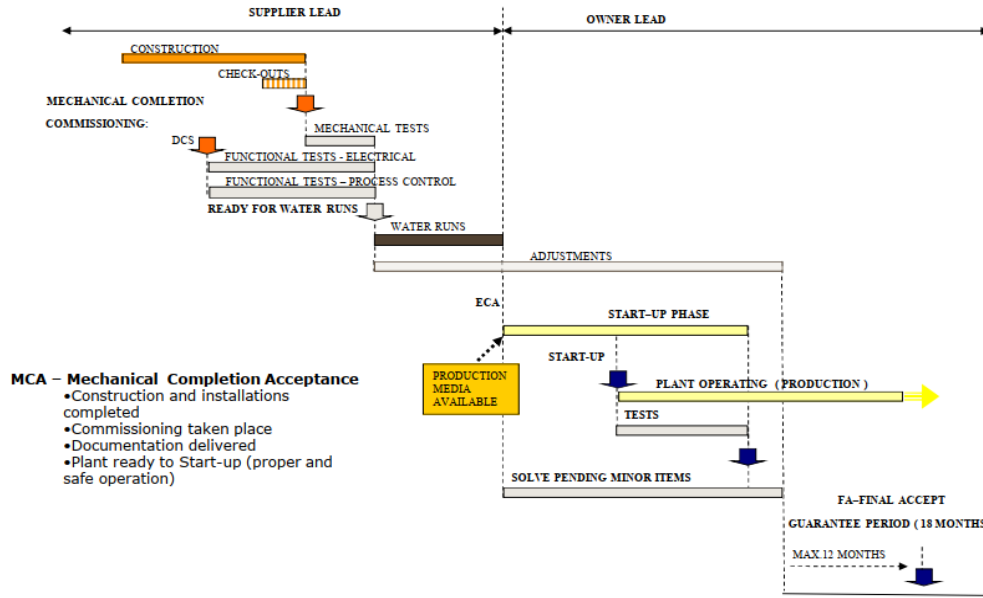

Project life cycle and Start-up phase

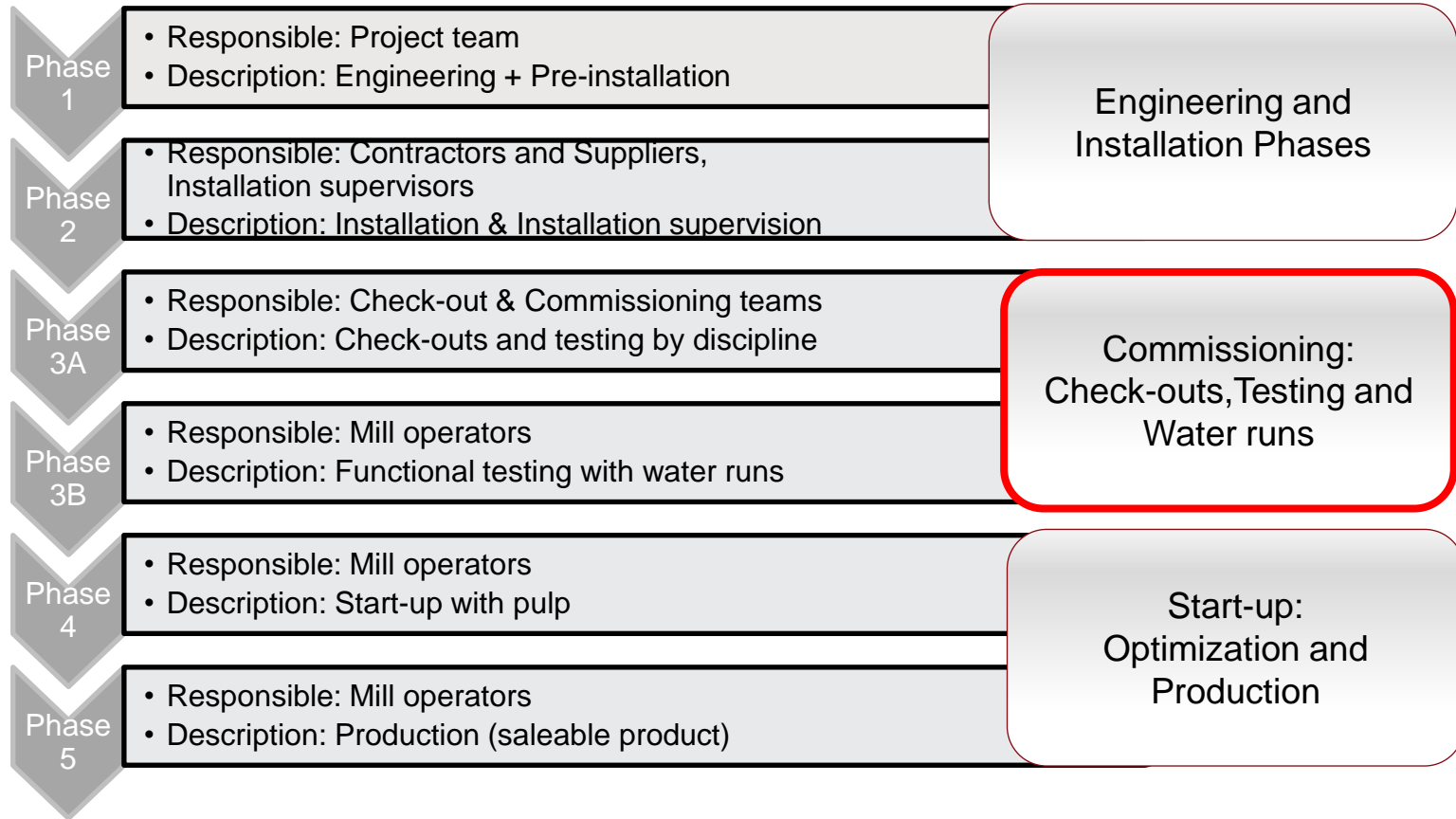

Project Functions

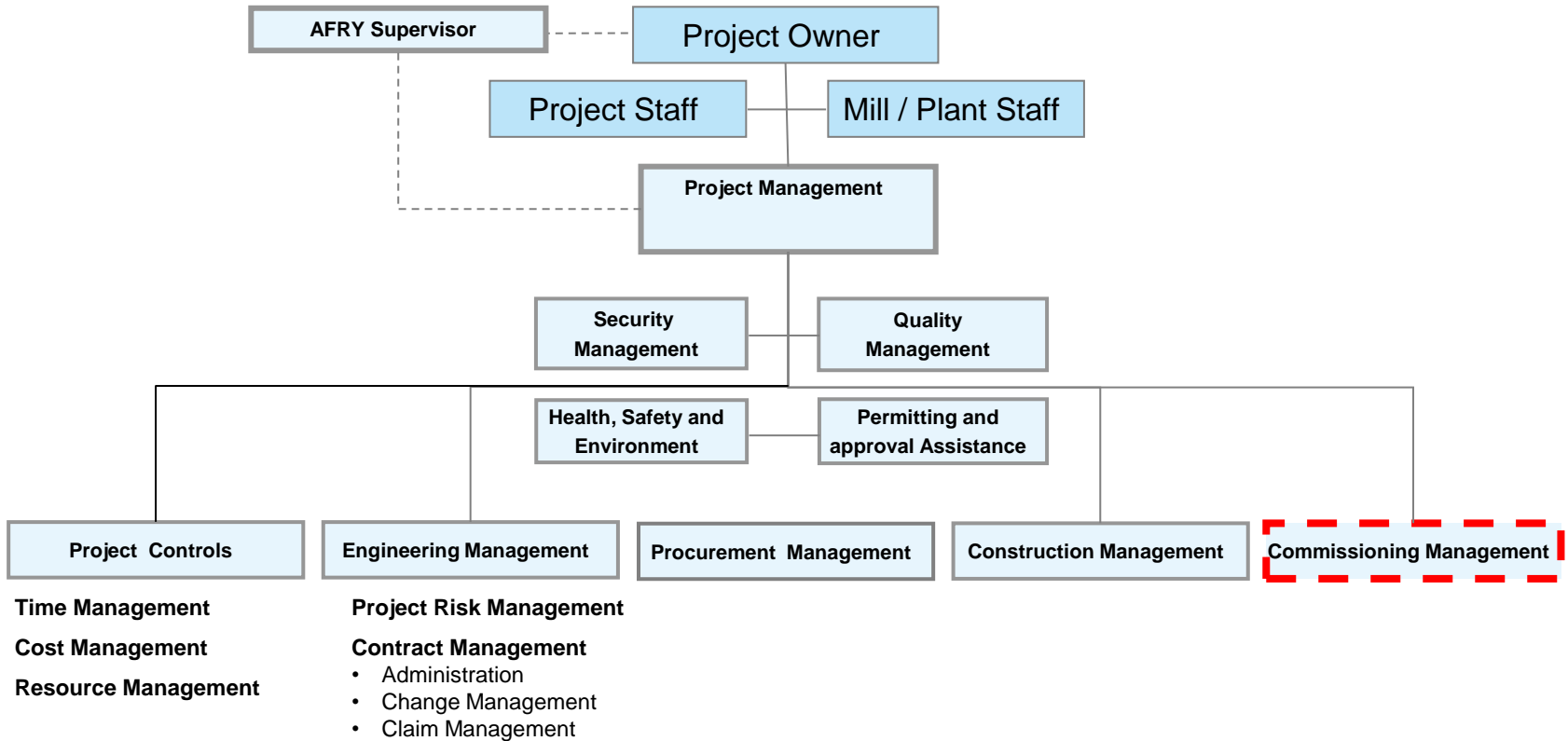

2. Preparation tasks for commissioning

Commissioning preparations

Good preparation of commissioning creates a good chance for a safe and successful start up!

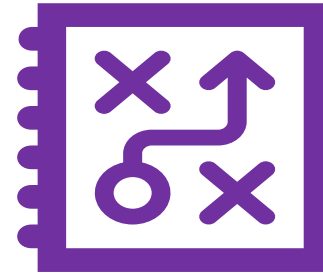

Commissioning preparations



- Outline the contractual responsibilities of the parties involved
- Preparation of commissioning manual
 - ✓ Commissioning organization
 - ✓ Commissioning reports, check sheets, isolation procedures, permit to work procedures
 - ✓ Commissioning schedules
 - ✓ Commissioning planning meeting schedules
 - ✓ Commissioning spare parts
 - ✓ Open issue list
 - ✓ Minutes of meetings
- Definition of raw material and/or fuel requirements
- Preparation of a list with contact details of suppliers and contractors
- Establishment of the erecting support team to commissioning
- Definition of the hand-over procedure from erection to commissioning
- To clarify and comply with the project insurance requirements
- Safety in commissioning

Safety in commissioning

Environment:

- ✓ Site environment includes several issues, which must be considered in order to achieve a safe place to work
 - such as lock-out tag out (local practices for electrical safety procedures), working at high, working with cranes and other lifting apparatus etc.
- ✓ Each site is individual. The safety issues and dangers must be analyzed and the procedure for a safe way to complete the work must be defined, instructed and supervised in each case individually
 - such as traffic ways, areas with special dangers, areas with no admittance, chemicals etc.

Behavior and training:

- ✓ General training
- ✓ Site & client specific training
- ✓ Own safe behavior all the time at the site → Impact on the own personal colleagues' health

Personal protective equipment:

- ✓ Equipment required by the employer
- ✓ Equipment required by the customer / site
- ✓ Equipment required by the individual work

Commissioning preparations (process discipline)

- Definition of water run test loops
- Preparation of commissioning PI-diagrams (coloured) presenting each group
- Compilation of check-out lists
- Technical definitions for the execution of commissioning, test runs and start-up

Check-out:

First stage of the commissioning. The check-outs are the activities that ensure that the system is ready for water run. The installation inspection and Field Check-out certifies that a delivery and installation fulfils contractual and process technical demands.

Commissioning test groups

- The mill is divided in individual test groups
- A test group must be a suitable process / mill part. There must be a possibility to separate the individual test groups of each other mechanically (hand valve)
- The test systems are systematic commissioned and tested
- Commissioning PI-diagrams (coloured) presenting each group are prepared
- Check-out lists are created
- The test groups are placed in the commissioning time schedule

Commissioning test groups

- The mill is divided into individual smaller parts called test systems.
- A test system is a suitable part of the process or mill system, which may be commissioned and tested independently. The individual test systems can be mechanically (e.g. hand valve) separated from each other.

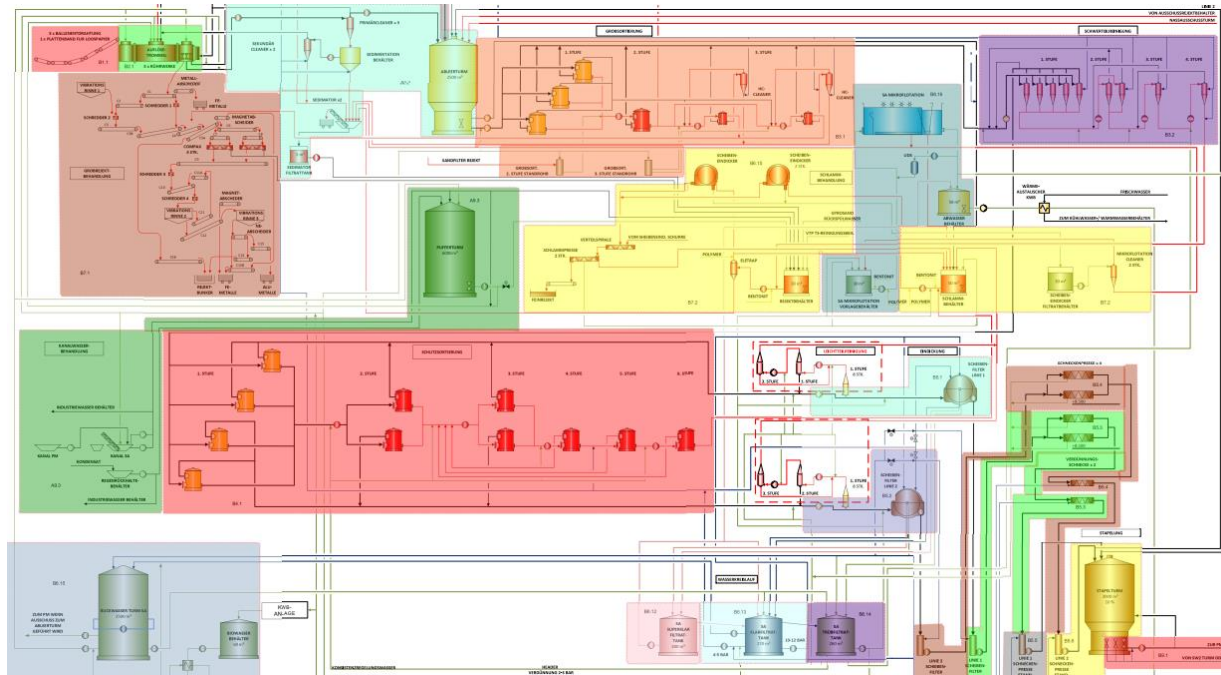

Commissioning test groups - examples

A	Common systems & Utilities	B	Stock preparation	I	Steam and condensate system	L	Coating color kitchen
A1	Mill air	B1	BHKP storage and dewatering	I1	Steam and condensate HP&LP	L1	CCK chilled water
A2	Instrument air	B2	BHKP refining (back&print)	J	KM7	L2	Starch system
A3	Fresh water	B3	BSKP storage and dewatering	J01	Dyer section	L3	Coating color mixers and storage
A4	Cooling water	B4	BSKP refining (print&middle)	J02	Wet end	L4	Coating color supply system
A5	Sealing water	B5	LUBSKP storage and dewatering	J03	HVC, Coater	L5	CCK dye system
A6	Chilled water	B6	LUBSKP(BSKP) refining (back)	J04	Speedsizer 3, Coater 4, Web run C3, C4	L6	Latex
A6.1	Chilled water primary net	B7	CTMP pulping and storage	J05	SNC, Web run, Sirius	L7	PVA
A6.2	Chilled water secondary systems 1..3	B8	CTMP refining (middle)	J06	Slitter winder VarFlex L	L8	Pigments storage and filtration
A7	Heating water	B9	Analysators Stock Preparation	J07	Lubrication	L9	Major & minor additives
A7.1	Heating water system 1	C	Approach flow system	J08	Machine air system	L10	Waste water treatment
A7.2	Heating water system 2	C1	Print ply	J09	Machine sectional drives		
A8	Potable water and emergency showers	C2	Back ply	J10	Working stations		
A9	Control system	C3	Middle ply	J11	Monitoring system		
A10	Ventilation	C4	Analysators Approach flow system	K	Wet end chemical systems		
A10.1	Hall ventilation KM7 hall	D	Broke system	K1	Alkaline detergent		
A10.2	Stock preparation hall ventilation	D1	Machine pulpers	K2	Alum		
A10.3	Coating kitchen Hall ventilation	D2	Other broke pulpers	K3	Bicarbonate and carbon dioxide		
A10.4	Roll Wrapping Hall ventilation	D3	Broke HC towers and deflaking	K4	Bicocide (also CCK)		
A11	KM Special room HVAC systems	D4	Broke screening	K5	Cationic starch		
A11.1	Electrical rooms dyer section HVAC systems	D5	Broke refining	K6	Chelating agent		
A11.2	Electrical rooms ED820, 807, 817, 818 HVAC systems	D6	Roll splitter	K7	Defoamer		
A11.3	Electrical rooms Stock preparation HVAC systems	D7	Re-winder	K8	Dye blue & violet		
A11.4	Electrical room ED809 HVAC systems	D8	Wrapping line	K9	Filler clay		
A11.5	Electrical room ED808 rack room ED831, winder control room H	D9	Core cutter	K10	Filler CaCO3		
A11.6	Electrical room ED821 HVAC systems	E	White water system	K11	Neutral size		
A11.7	Server room ED833 HVAC systems	E1	White water storage	K12	Retention polymer		
A11.8	Main control room HVAC systems	E2	Disc filter and broke thickening	K13	Retention silica		
A12	Office building HVAC systems	E3	Tank cleaning systems	K14	Rosin size		
A12.1	Laboratories HVAC systems	F	Warm and shower water systems	K15	Sodium bisulfite		
A12.2	Maintenance HVAC systems	F1	Warm and shower water	K16	Sodium hydroxide NaOH		
A12.3	Offices HVAC systems	G	Vacuum system	K17	Spray starch		
A12.4	Social rooms HVAC systems	G1	Vacuum	K18	Sulphuric acid H2SO4		
A13	HVAC systems for small rooms in KM7 area	H	Effluent system				
A14	Fire water	H1	Effluent system				
A15	Sprinkler system						
A16	Field Boxes Instrumentation						
A17	ICT						
A18	WISA/WMS systems						
A20	Power Distribution						
A20.1	11kV switchgears						
A20.2	Control and lighting voltage						
A20.3	Main process MCC's						
A21	Field boxes electrification						
A22	E-stop syst. KM7 process						
A23	E-stop syst. KM7 sect. drives						

Commissioning test groups

- Commissioning PI-diagrams (coloured) presenting each group are prepared

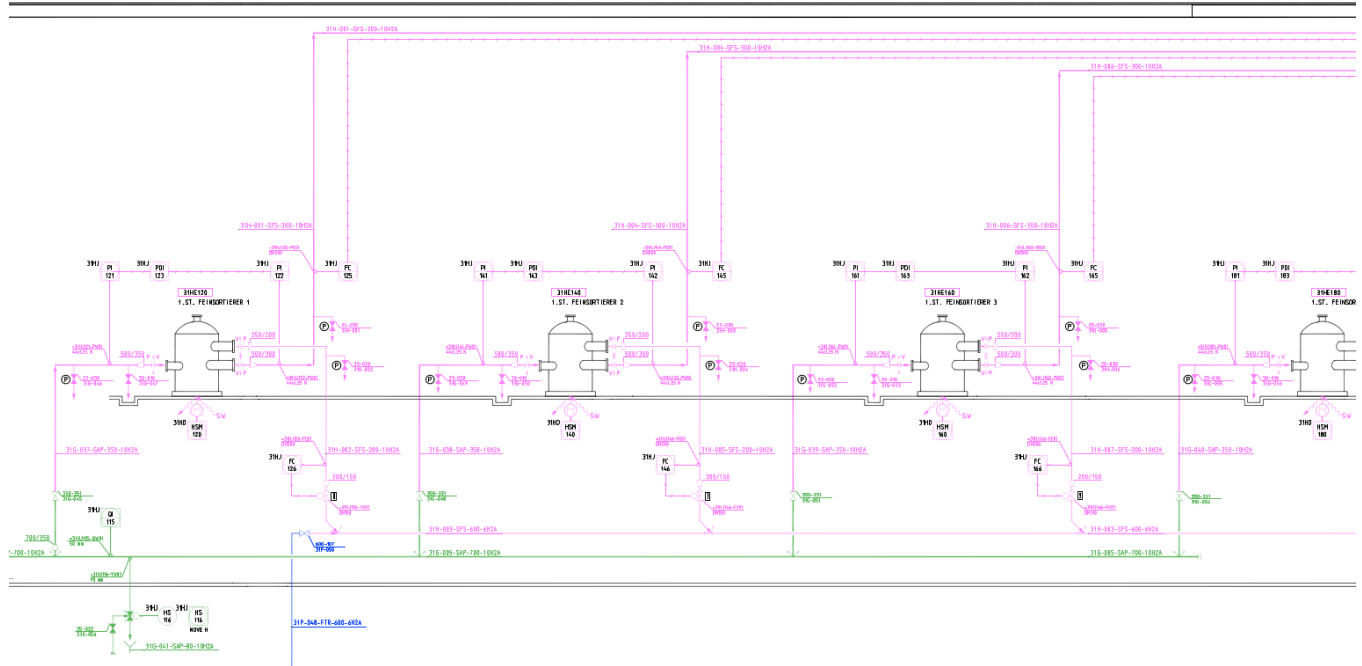

Commissioning test groups

- The test systems are systematically commissioned and tested: Detailed list of all equipment, loops, pipelines and electrical circuits for installations, check-out procedures and testing progress. One list per test system and per discipline.

PROJ	1000-334-P230-300065	1000-331-P230-300051	1000-331-P230-300053											
Set Descr	Name 1													
Dis 1	Schaltzentrale													
Mechanischer Zieltag	Rohr Zieltag													
Loop Zieltag	Elektrischer Zieltag													
			Prozessgerät				Rohrleitungen		Instrumentierung		Elektrifizierungen			
			Installation abgeschlossen	Auschecken abgeschlossen	Installation abgeschlossen	Markierung abgeschlossen	Auschecken abgeschlossen	Installation abgeschlossen	Auschecken abgeschlossen	Installation abgeschlossen	Auschecken abgeschlossen	Bemerkungen		
6	PROZESSGERÄT	Pos. Nummer	Name											
7		31HE120	1.ST. FEINSORTIERER 1											
8		31HE140	1.ST. FEINSORTIERER 2											
9		31HE160	1.ST. FEINSORTIERER 3											
0		31HE180	1.ST. FEINSORTIERER 4											
1		31HE200	2.ST. FEINSORTIERER 1											
2		31HE240	2.ST. FEINSORTIERER 2											
3		31HE320	3.ST. FEINSORTIERER 1											
4		31HE340	3.ST. FEINSORTIERER 2											
5		31HE360	4.ST. FEINSORTIERER 1											
6		31HE510	5.ST. FEINSORTIERER ECHT											
7		31HE520	5.ST. FEINSORTIERER											
8		31HE620	6.ST. FEINSORTIERER											
9	PUMPEN	Pos. Nummer	Name											
0		31HP210	2.ST. FEINSORTIERUNG PUMPE											
1		31HP310	3.ST. FEINSORTIERUNG PUMPE											
2		31HP410	4.ST. FEINSORTIERUNG PUMPE											
3		31HP610	6.ST. FEINSORTIERUNG PUMPE											
4	ROHRLEITUNGEN	Pos. Nummer	Name											
5		31G-037												
6		31G-038												
7		31G-039												
8		31G-040												
9		31H-001												
0		31H-002												
1		31H-003												
2		31H-004												
3		31H-005												
4		31H-006												
5		31H-007												
6		31H-008												

Summary check-out list

- Creation of summary check-out lists: An overall view of the status of mechanical, electrical and automation commissioning activities for a given test system.

Area: XXXXX Area Name: _____
 Test System: XXXXX Test system Name: _____

Equipment	Pos. number	Name 1	Name 2	Mechanical Equipment		Piping		Control Equipment		Electrical Equipment		Remarks
				Installation Completed	Check-Out Completed	Installation Completed	Marking Completed	Check-Out Completed	Installation Completed	Check-Out Completed	Installation Completed	
Pumps	Pos. number	Name 1	Name 2									
Tanks	Pos. number	Name 1	Name 2									
Pipelines	Pos. number	Media	Name 1	Name 2								
Instrument Loops	Pos. number	Name										
Electrical circuits	Pos. number	Name										

- System ready for water run: When all relevant Inspections and Check-out activities related to the Test system have been completed and the test system is ready for Water run.
- System taken over for water run: When the Water run team (operators) have made an overall inspection of the Test system and found the system ready for Water run.
- Water run completed: When the Water run has been completed and the test system is considered ready for start-up operation

Commissioning test groups

- The test groups are placed in the commissioning time schedule, which also works as a guidance tool for the completion of the installation during erection period. It is planned so that the work is done systematically and that the start-up can be done in the correct and logical sequence.

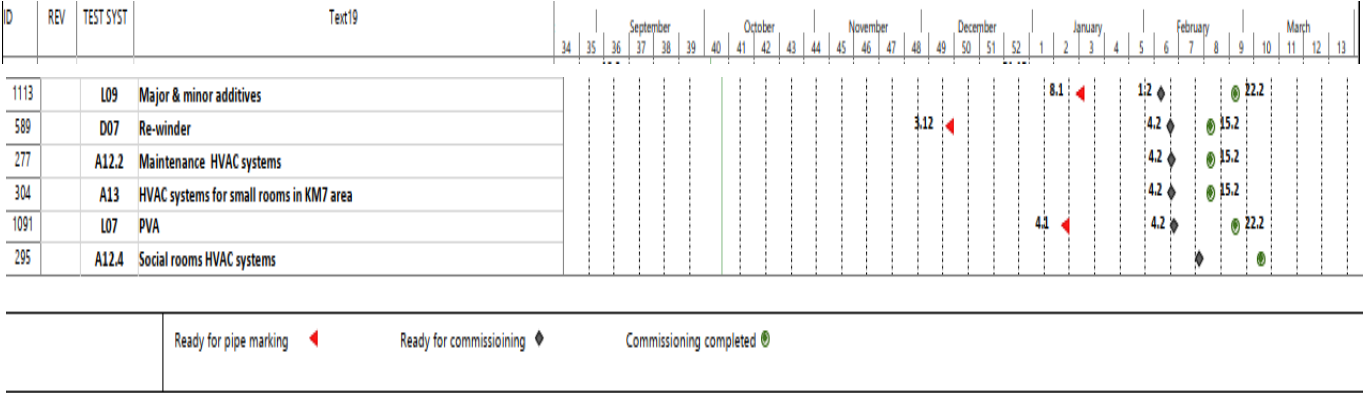

Terminology related to commissioning

Installation inspection:

The installation inspection certifies a delivery and an installation that fulfils contractual and process technical demands.

FAT (factory acceptance test):

Software testing of process control concepts after the programming in a way that the control system description corresponds to the application programming. Normally carried out during the final part of the design and engineering phase before the final installation in the mill. Application configuration checking in simulation situation. Base parameters for control loops.

SAT (site acceptance test):

Test after the complete installation and final configuration. Every signal will be tested (measurements, controls, binary signals)

Terminology related to commissioning

DCS (distributed control system):

A digital automated industrial control system that uses geographically distributed control loops throughout a factory, machine or control area. DCS allows each section of a machine to have its own dedicated controller that runs the operation. A DCS has several local controllers located throughout the area that are connected by a high-speed communication network. While each controller works autonomously, there is central supervisory control run by an operator.

PLC (Programmable logic controllers):

A programmable logic controller (PLC) is a modular solid state computer with customized instructions for performing a particular task. Examples of applications are non-continuous control and event-based manipulations.

MCS (machine control system):

Controls the loops of a certain machine, e.g. paper machine.

QCS (quality control system):

The quality control system of a paper machine controls the quality parameters of paper (Basis Weight, Moisture, Caliper, Ash and Color).

Terminology related to commissioning

Field Check-out:

For electrical and process control objects, the field check-out certifies a delivery and installation that fulfils contractual and process technical demands. Electrification Field check-out is a part of installation and is made by installation contractor. Field check-out includes also rotation direction check for motors.

Functional test:

Verification that interconnected process control programs communicate with each other and perform the intended operations.

I/O test:

Part of functional testing

Loop Check-out:

Verification that interconnected process control programs communicate with each other and perform the intended operations.

Field test for instrument loops: Part of process control. Mechanical, electrical and pneumatic testing of instrument loops.

3. Execution of commissioning

Execution of commissioning

Cooperation is important!



Cooperation & communication:
CUSTOMER / DESIGNER / SUPPLIER

Mechanical commissioning and check-out activities

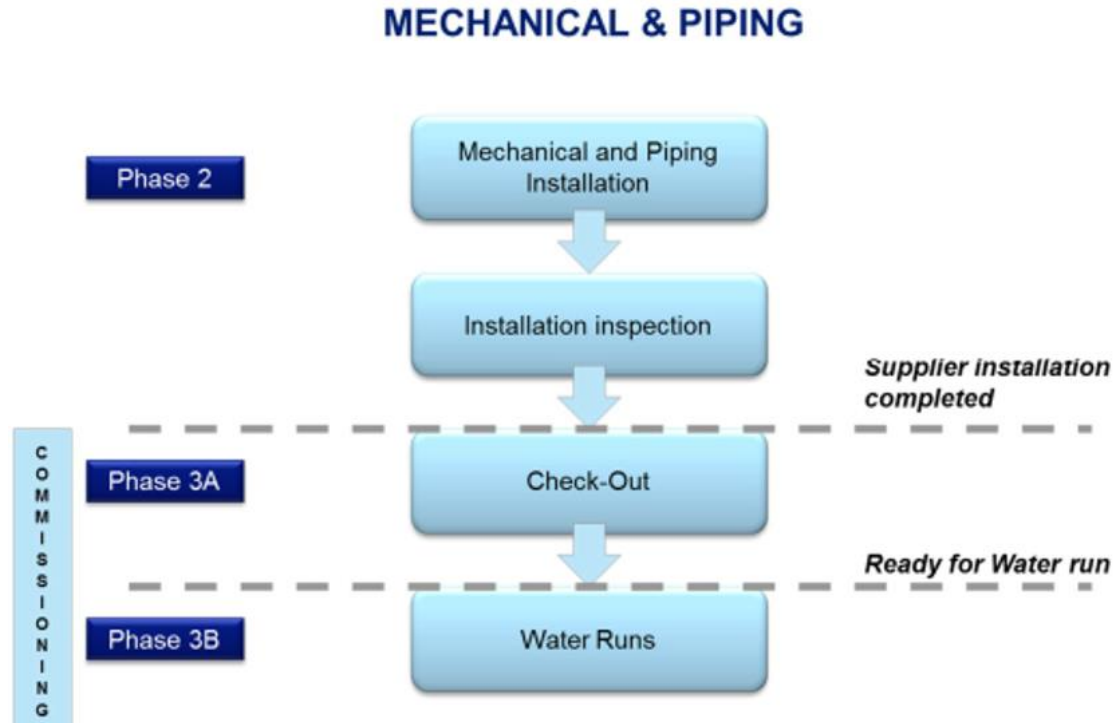

Commissioning mechanical equipment

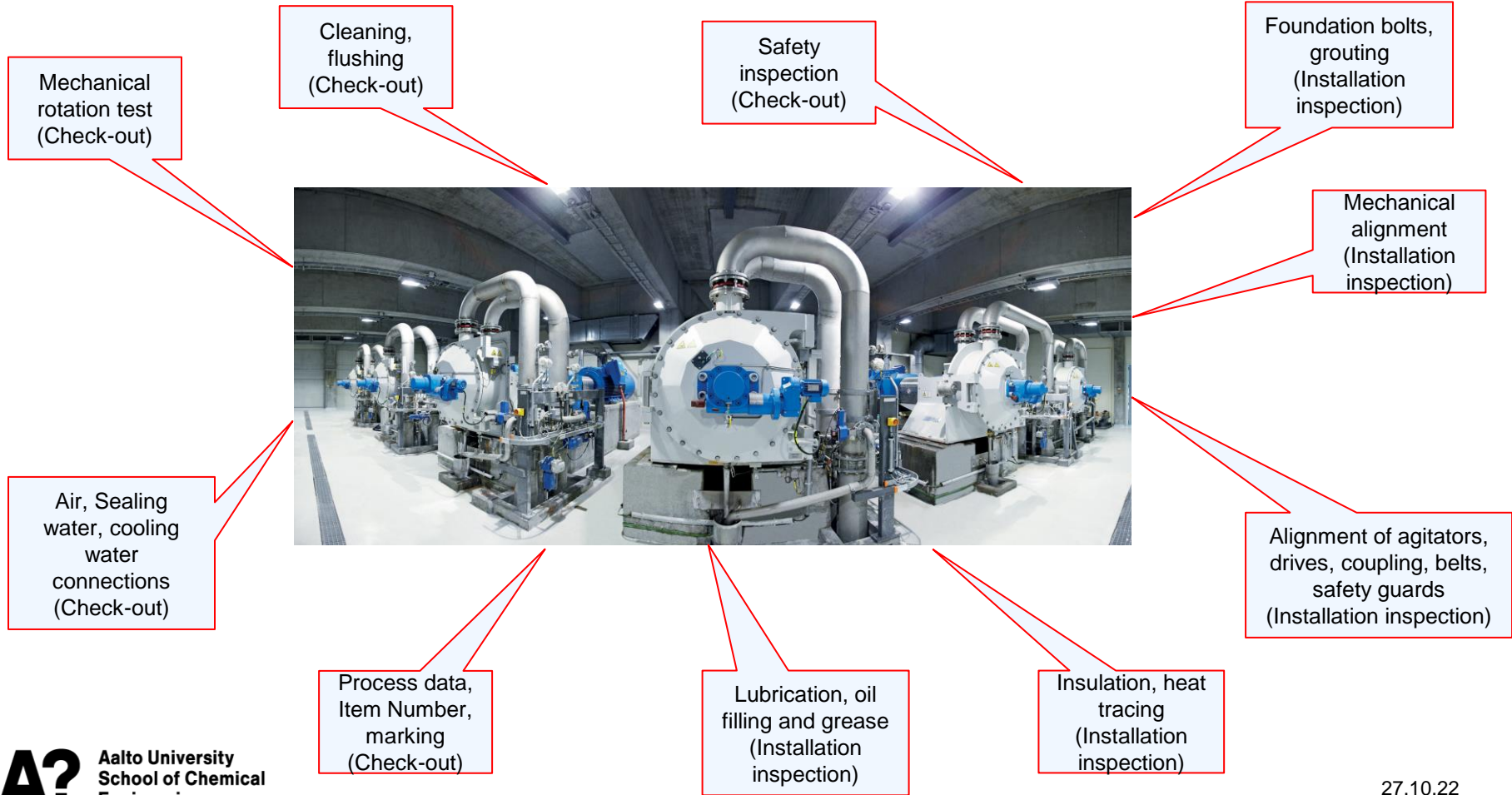

Discipline check-out list mechanical equipment

- Mechanical equipment installation completed:
The equipment is completely installed, pressure tested, aligned and foundations are grouted.
- Check-Out Completed:
The check-out activities as are performed

POS NO.	TANK NAME	P&ID	Installation									Commissioning				REMARKS	
			T1	T2	T3	T4	T5	T6	T7	T8	T9	INSTALLATION COMPLETED	T10	T11	T12		
			Foundation bolts, grouting	Mechanical alignment	Internal piping partition walls	Alignment of agitator, drives coupling, belts,	Heat tracing installed and insulated	Pipe connections, vents,	Instrument connections	Manhole covers, steps, ladders etc	Authority test and inspections		Process data, Item No., marking	Cleaning	Safety inspection	READY FOR WATER RUN	

Commissioning piping

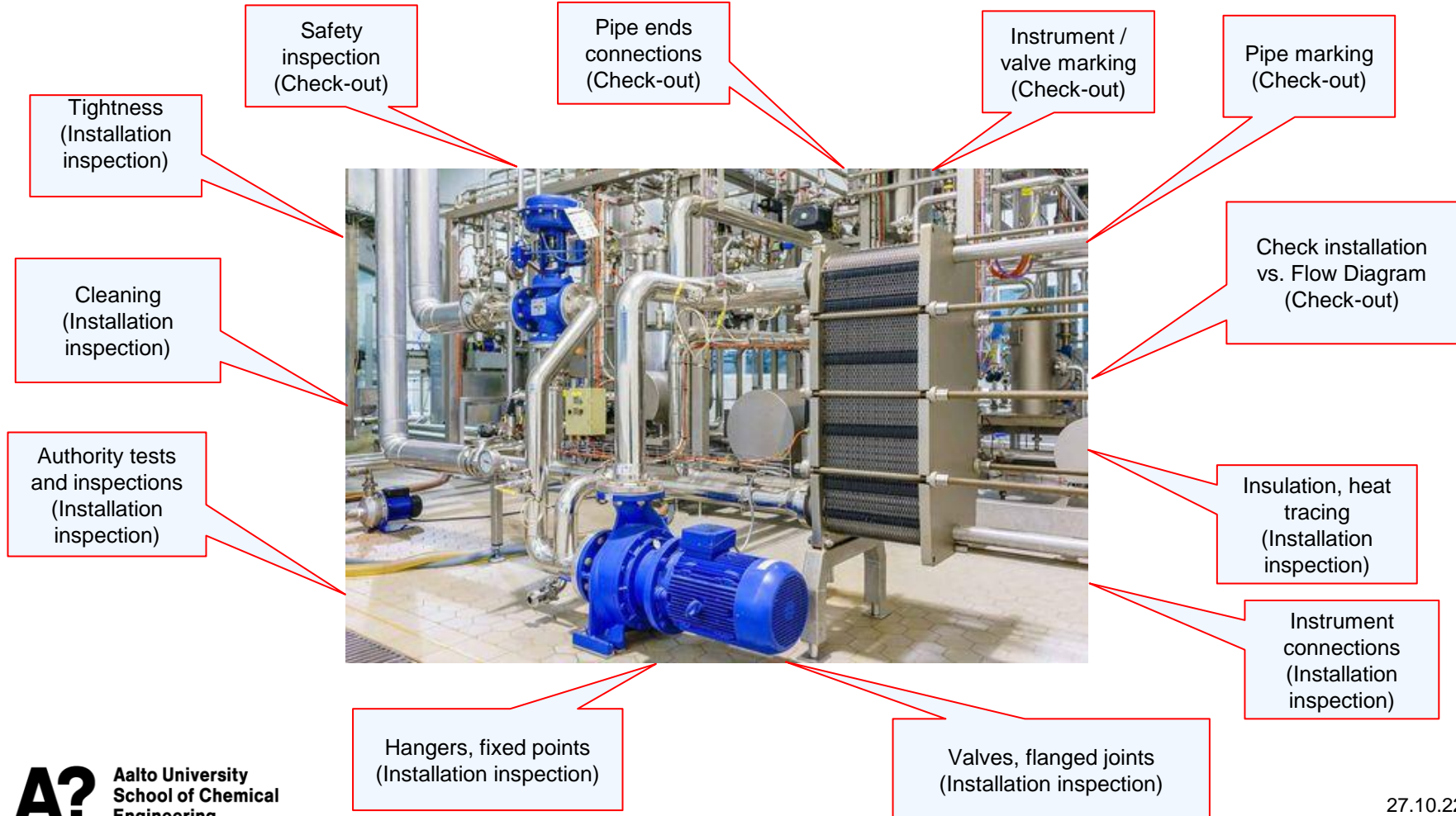

Discipline check-out list piping

- Piping Installation completed:
The complete pipeline is installed, pressure & leak tested. Pipe marked according to drawings and instructions.
- Check-Out Completed:
The check-out activities as are performed

POS NO.	PIPELINE NAME	P&ID	Flow Media	Insulation class	Pipe Class	Installation							Commissioning					REMARKS					
						Tightness P1	Cleaning P2	Authority test and inspections P3	Hangers, Fixed points P4	Valves, flanged joints P5	Instrument connections P6	Insulation P7	INSTALLATION COMPLETED	Check vs flow diagram P8.1	Pipe marking P8.2	Valve / Instrument marking P8.3	Connected to item number P8.4		Safety / Inspection P9	READY FOR WATER RUN			

Commissioning tanks and towers

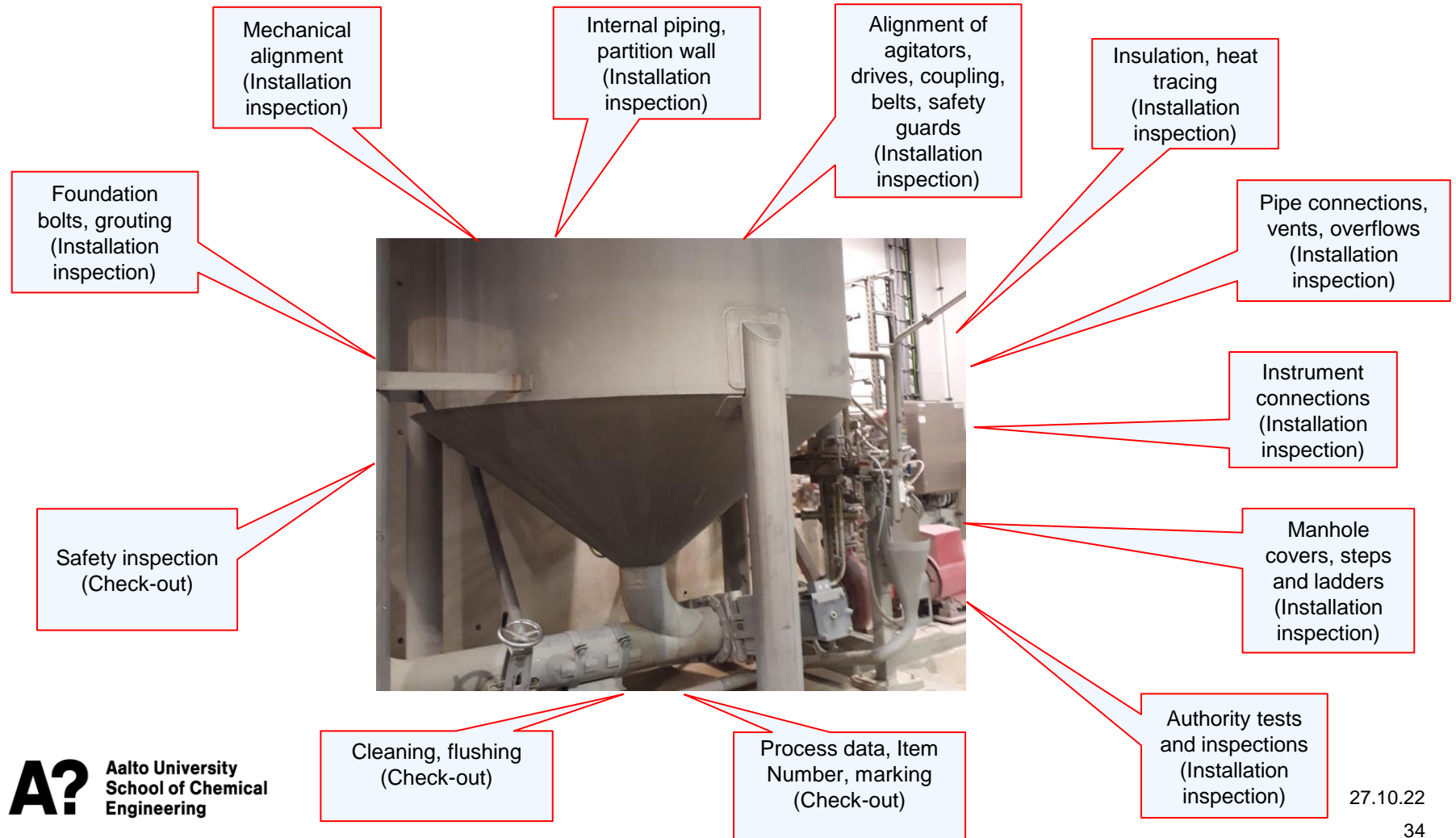

Discipline check-out tanks and towers

- Tanks and towers installation completed:
The tank is installed and pressure & leak tested. Tank marked according to drawings and instructions.
- Check-Out Completed:
The check-out activities as are performed

POS NO.	TANK NAME	P&ID	Installation										Commissioning			REMARKS
			Foundation bolts, grouting	Mechanical alignment	Internal piping partition walls	Alignment of agitator, drives coupling, belts,	Heat tracing installed and insulated	Pipe connections, vents,	Instrument connections	Manhole covers, steps, ladders etc	Authority test and inspections	INSTALLATION COMPLETED	Process data, Item No., marking	Cleaning	Safety inspection	
			T1	T2	T3	T4	T5	T6	T7	T8	T9		T10	T11	T12	

Electrical commissioning and check-out activities

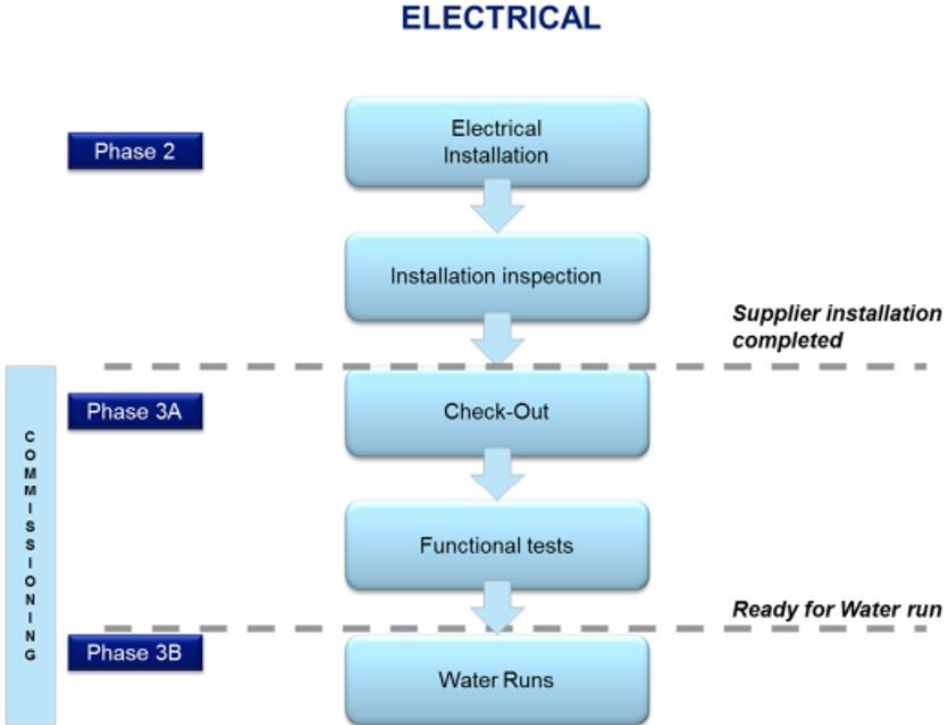

Electrical commissioning

Motor Control Circuit Checks:

- Motor data from the motor rating plate
- Motor starter sizing
- Fuses
- Contactor
- Overload setting
- Variable speed drive rating and settings
- Starter is in test position
- Switch on the control voltage
- Contactor on-off from control system
- Contactor feedback
- Fault in starter
- Thermal overload and ground fault
- Local stop
- Local start/stop (if applicable)
- Safety interlocking (limit switches etc. if applicable)
- Emergency stop (if applicable)
- Other issues

Motor Rotation
Test

Feeder circuit test

Functional and Interlocking Tests:

- Circuit functionality in the process
- Interlockings between different circuits (motor circuits and instrument loops etc.) are working in accordance with the control system description and operation manuals
- Final adjustments of field devices
- Group starts, automatic operations and sequence controls
- Special functions
- Current and/or power reading in DCS



Electrical discipline check-out list

- Electrical equipment Installation completed:
The MCC, I/O racks and the Process equipment (motor etc.) are installed and the control and power cables are connected in both ends and when the cold test have been made
- Check-Out Completed:
The check-out activities as are performed

Test system	Application ID	Application Name1	Application Name2	Ready for check out	E1.Motor /MCC/VSD rated data checked	E2.Controls, interlockings and settings, I/Os to DCS checked	E3.Rotation test done	E4.Ready for water run	E5.Punch list check out	Remarks
-------------	----------------	-------------------	-------------------	---------------------	--------------------------------------	--	-----------------------	------------------------	-------------------------	---------

Automation commissioning and check-out activities

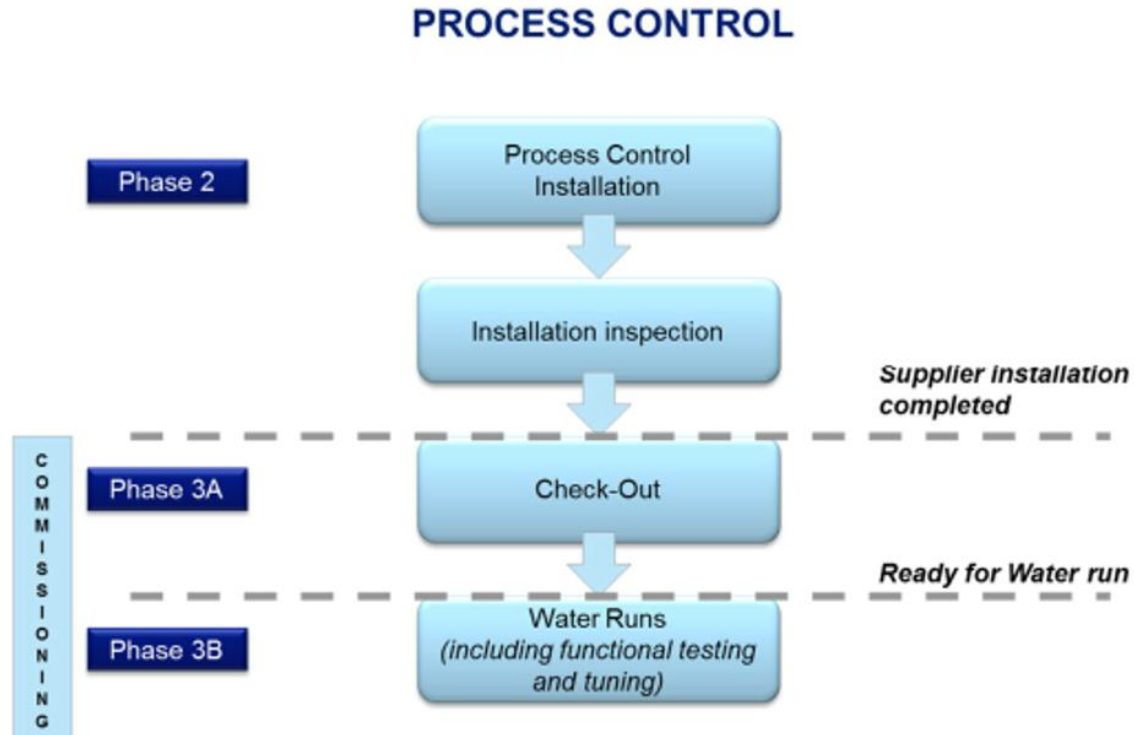

Automation commissioning

- Check communication between loop devices and DCS, MCS or other systems as specified in the documentation
- Device software check
- Device check-out (valve opening with different signal outputs, checking and adjusting the 0-point etc.)



Functional Check-out:

- The loop performance according to documentation with water as main process media.
- Interfaces to other loops, motors, aux systems, safety etc.
- Check and adjustment of loop functionalities, interlockings, alarms, group starts/stops
- Test of safety systems

Preparation of the field box for check-out by clean blow of pneumatics etc.

Preparation of the device/loop ready for water run with power on, impulse lines filled etc. as required.

Power up of field boxes, devices etc.

Automation discipline check-out list

- Control equipment Installation completed:
The instrument or valve is mechanically installed according to certified documentation, when the cables are connected in both ends and when the cold test have been made
- Check-Out Completed:
The check-out activities as are performed

Loop type
Test system
Area
Subarea
Loop
Application ID
Tag ID
Assembly
Loop name 1
Loop name 2
Ready for check-out
1. Shut-off valves opened and impulse lines filled when applicable
2. Device powered
3. Device software checked. Hart
4. Signals checked. Movements checked.
Checked. Ready for water run
Punchlist check-out
Remarks

Test system
Main Area (Assembly)
Area (Assembly)
Area name
AsmSubArea
Assembly ID
Supplier
Name 1
Name 2
Type
Location
Ready for check-out
1. Air supply and solenoid valve manifolds clean/blown.
2. Boilpanel powered (main 230 VAC supplies)
3. Power up signs fixed to box
Punchlist check-out
Remarks

Deviation handling

Punch list:

List of notified deviations. Punch lists are made per discipline.

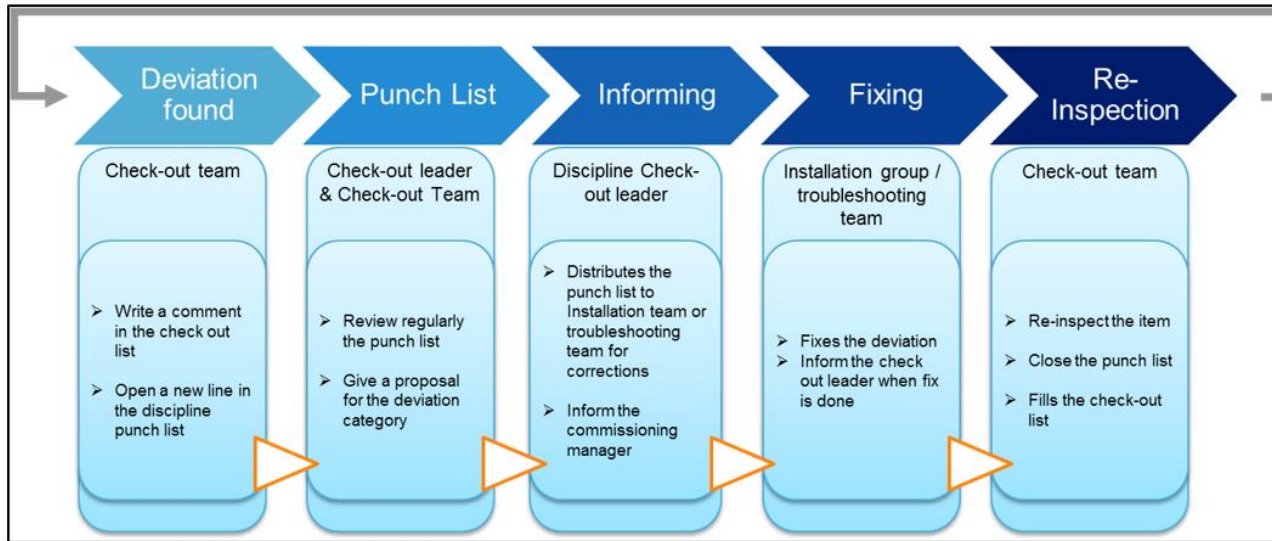

Execution of commissioning

Water runs

- Final stage of commissioning when the process is operated with water instead of media. Carried out when the whole test system is ready. The process is simulated.
- Flanges are checked for tightness, leakages are checked, the function of the plant is checked, possible vibrations and noises are investigated, the function and capacity of valves, pumps, agitators and fans are measured and the instruments are adjusted and fine-tuned. Motor currents are checked Checking: Leakages and in pipelines and tanks.
- Started by running single machines within the test system first, then whole system and later several tests' systems together.

Execution of commissioning

Rotation test:

Part of electrical commissioning; it is done to ensure that electrical motors work properly.

Start-up:

Start-up with pulp after commissioning is completed. The moment when all suppliers' and contractors' responsibilities are fulfilled and the equipment is ready for test run with media.

Take over:

Start of production when all tests are finalized and the equipment reaches the requested quality targets.

Production:

Final phase of the start-up; production of final, saleable product. Preceded by take-over certificate.

Execution of commissioning

Red Pen Markings:

During commissioning phase differences between what has been installed on site and what is shown in the engineering documents may be observed. Reasons for this can be needed changes, changed needs or practical improvements or.

The final installation or programming is documented in the red pen versions of the engineering documents. The as-built documents are produced based on the red pen versions.

As-built documentation:

Documentation based on the situation when saleable production is started. No revisions will be done afterwards.

4. Examples occurrences during commissioning

Case: Wrong pump type



Case: Wrong pump type



Case: Wrong tank bottom form

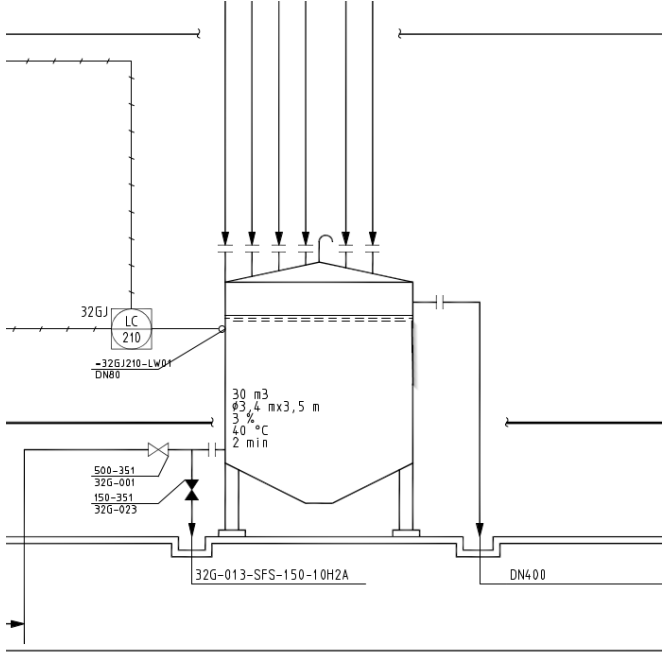

Case: Wrong tank bottom form

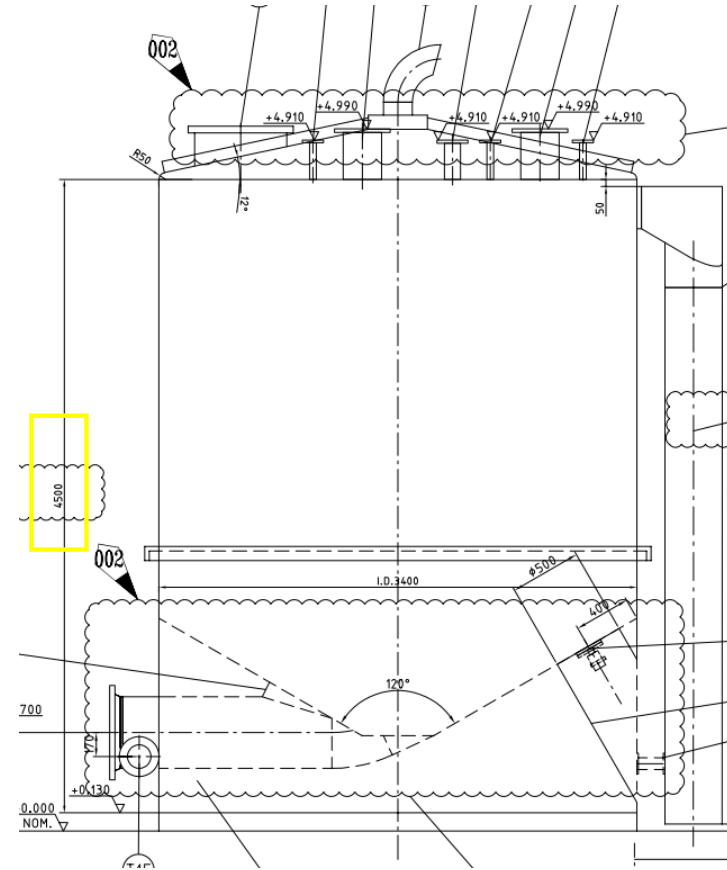
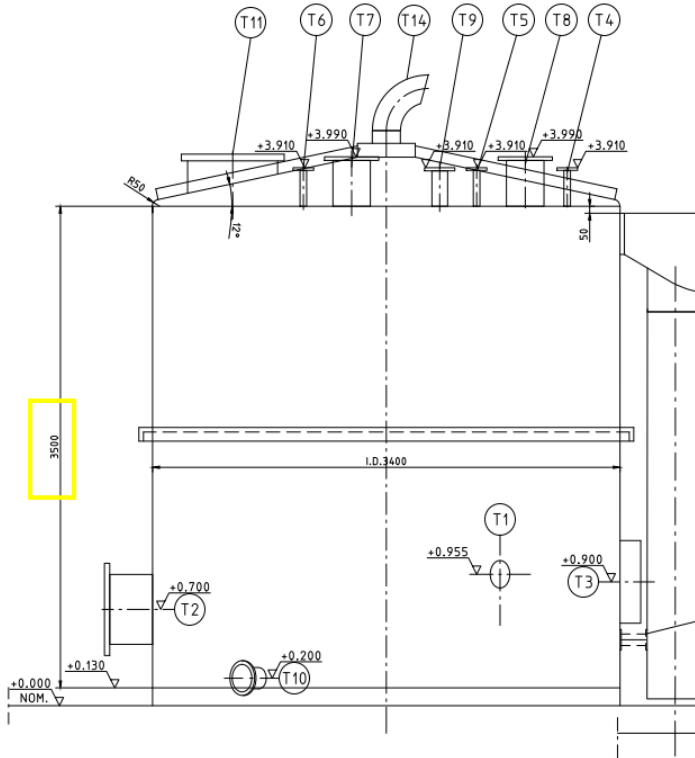

Case: Wrong tank bottom form

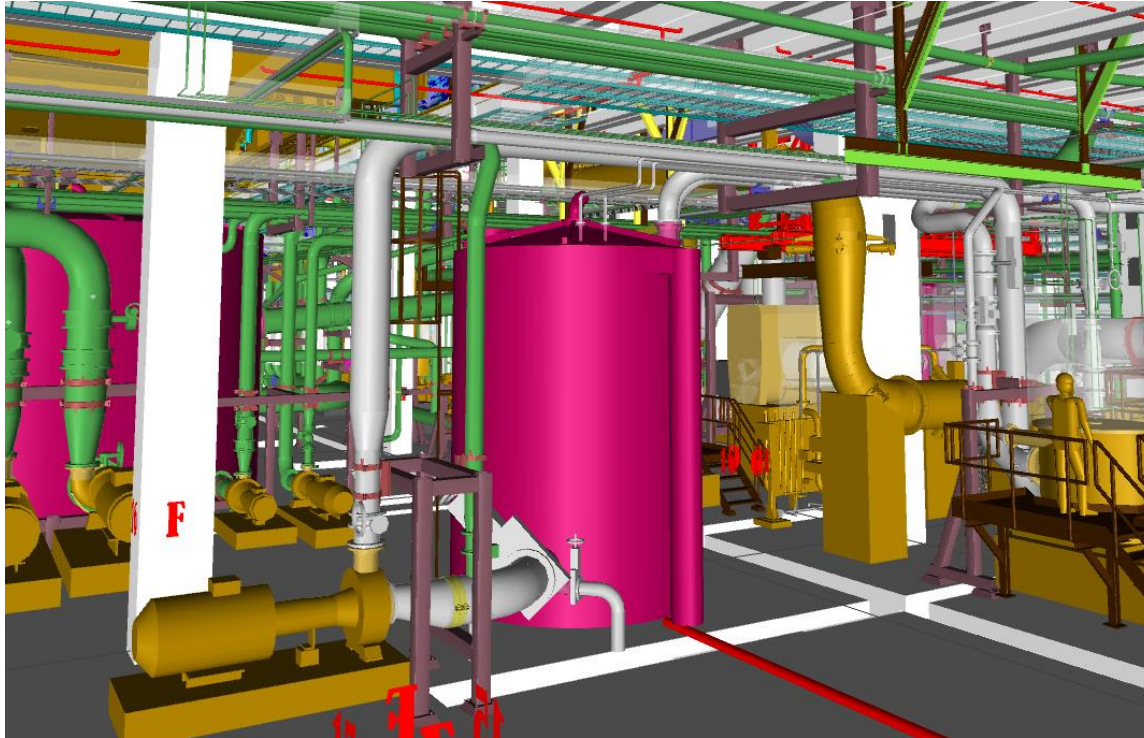

Case: Wrong tank bottom form



Case: Wrong level measurement placing

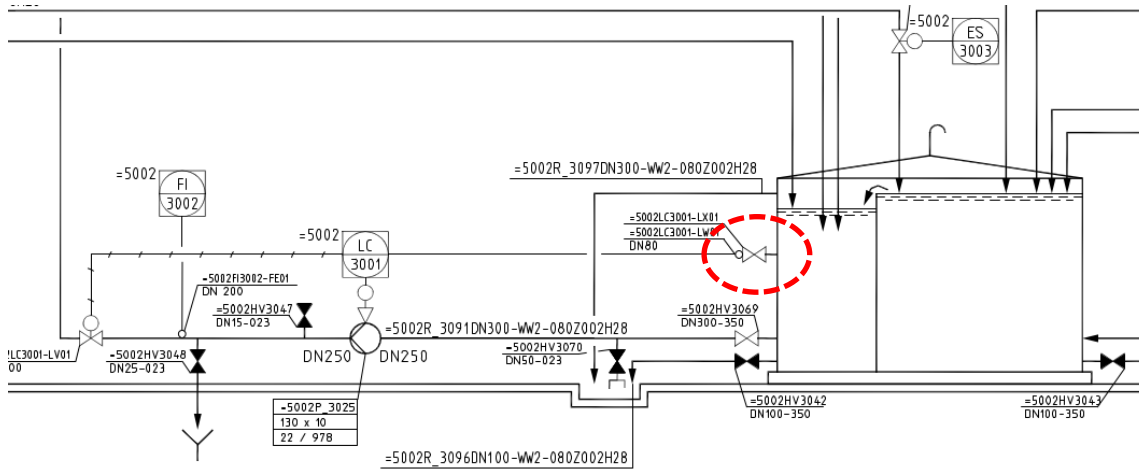

Case: Wrong level measurement placing

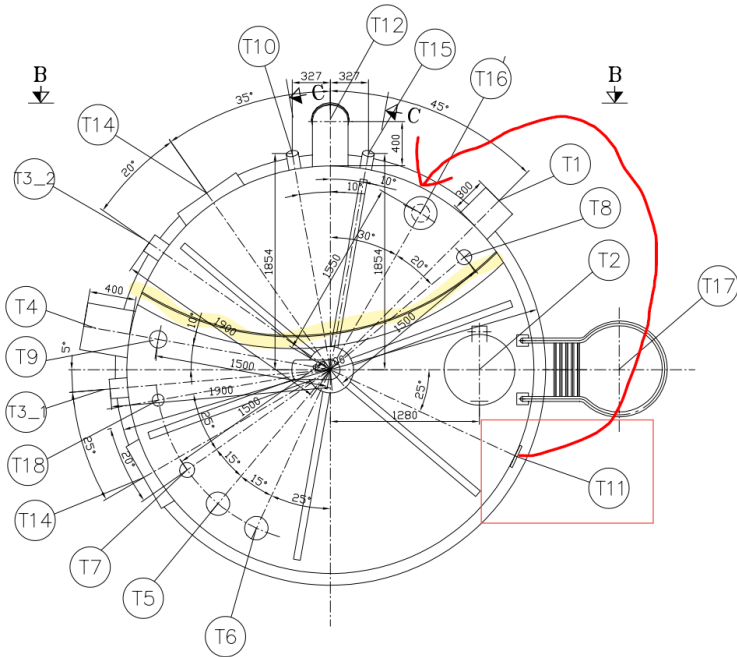

Thank you!