



Aalto University
School of Engineering

MEC-E1003

Machine Design Project

Sept. 16, 2022

Prof. Sven Bossuyt



Aalto University
School of Engineering

MEC-E1003

Stirling Engine Starter Project

What is this starter project about?

- This project will provide an introduction to mechanical fabrication: specified parts for *machining*, *assembly*, *inspection*, and *compliance*. *These are all skills you will need to be successful at designing machines.*
- This is a **hands-on experience** project. It is purposefully given *now*, before you have learned any theory on cutting, machining, measurement, or fabrication.
- It provides a practical background before you study the theory.

Miniature Stirling Engine

First three weeks

- You will inspect parts, assemble, and test a working miniature Stirling engine built of machined parts.
- The more precisely you fabricate parts and assemble the engine, the faster it will go



Miniature Stirling Engine

kit of parts

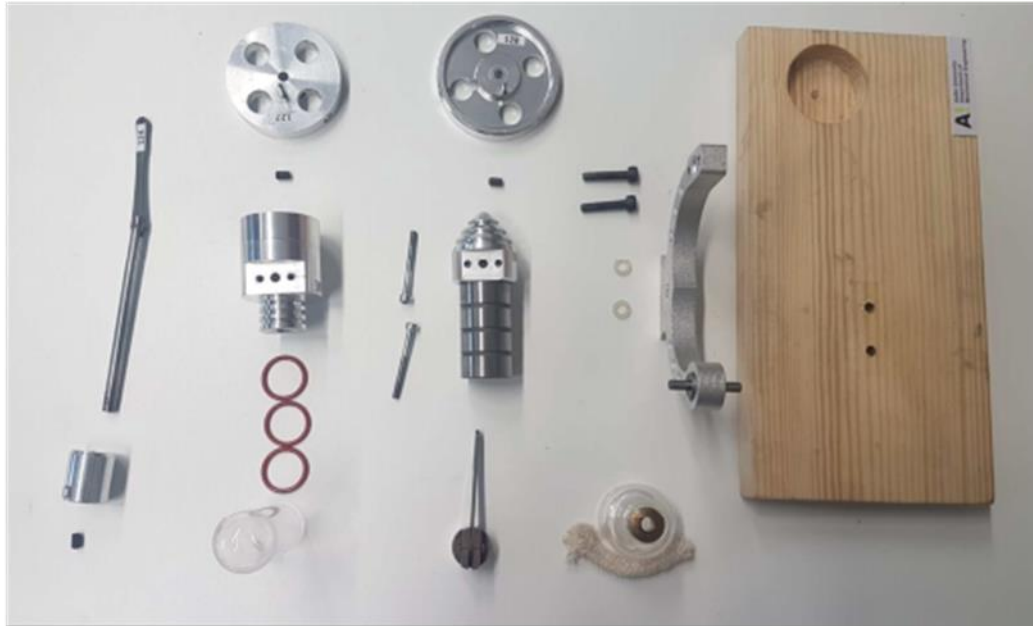

Stirling engines

A Stirling engine operates not through internal combustion, but rather from simple heat transfer.

It can approach Carnot thermodynamic efficiency.

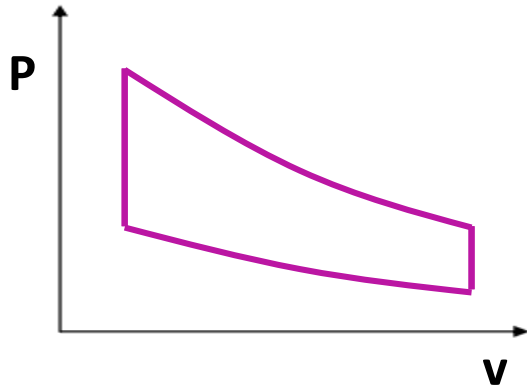

Engine parts

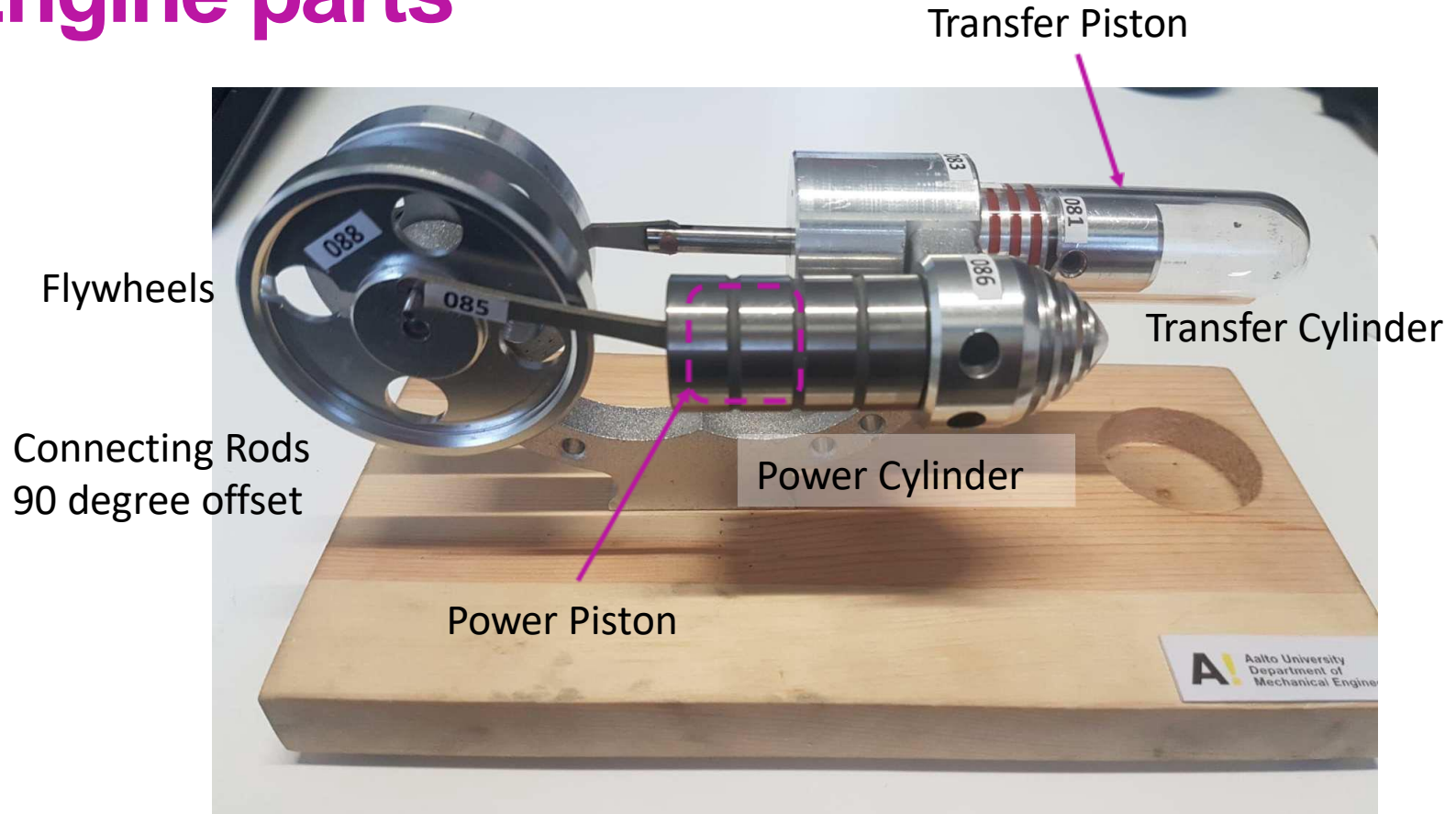

Engine operation

Watch it spin. What makes it go?



Miniature Stirling engine

Observe it operating

Observe it operating:

- How big is it?
- What distance does each piston move?
- How large is the displacer piston?
- How large is the displacer cylinder?
- How fast is it spinning?
- How loud is it?
- How hot is the hot side?
- How cold is the cold side?



Miniature Stirling engine

Observe it operating

Observe it operating:

- How big is it?
- What distance does each piston move?
- How large is the displacer piston?
- How large is the displacer cylinder?
- How fast is it spinning?
- How loud is it?
- How hot is the hot side?
- How cold is the cold side?

How much useful shaft power does it generate?

- answer on MyCourses (in-class assignment 1)

Stirling engines: How does it work?

What makes it turn?

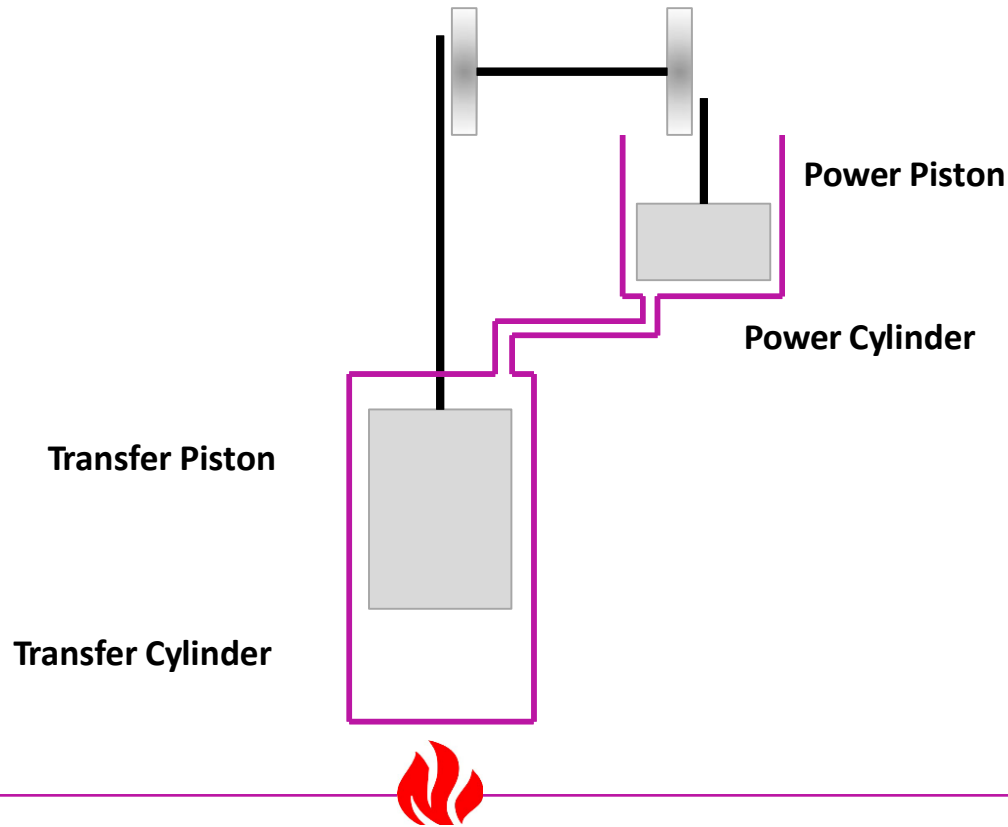

Stirling engines: How does it work?

Phase 1: Heating

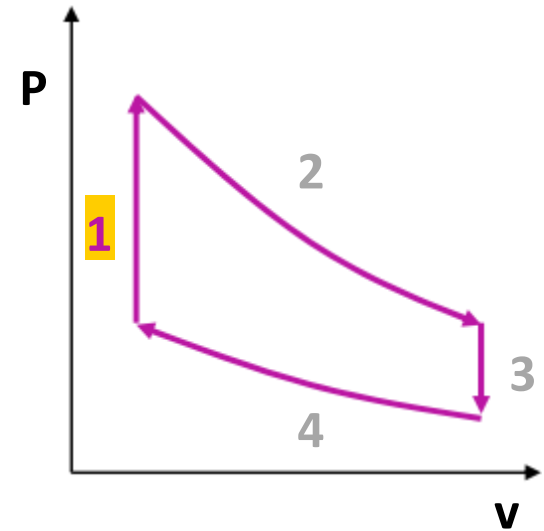
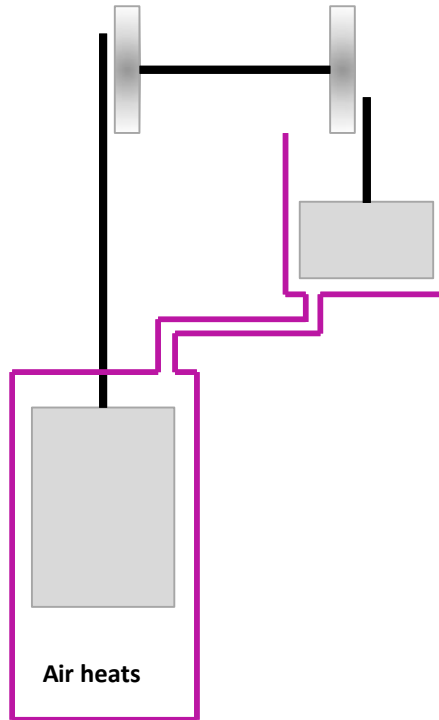

Stirling engines: How does it work?

Phase 2: Expansion

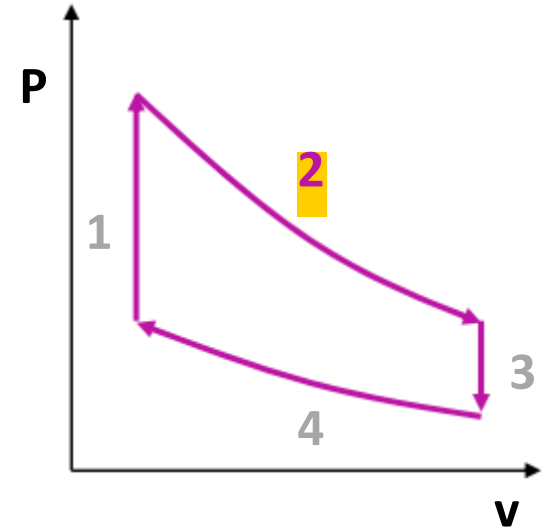
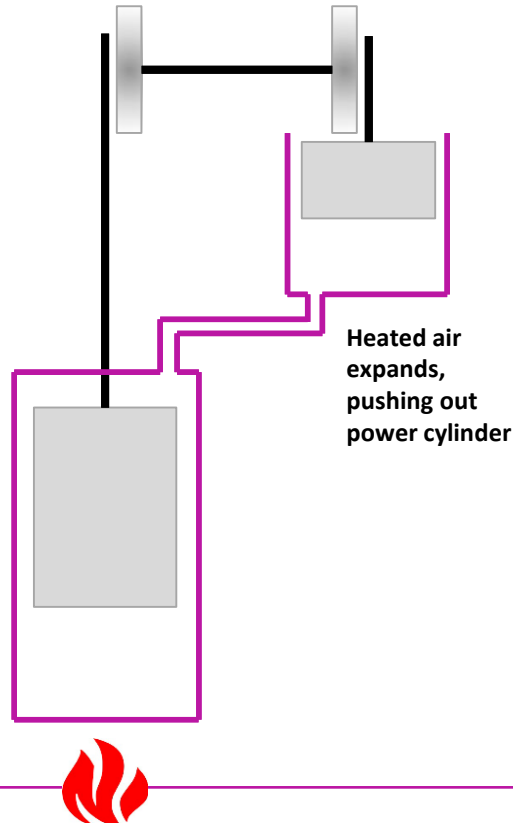

Stirling engines: How does it work?

Phase 3: Cooling

Power cylinder movement also moves transfer cylinder. Now air cools.

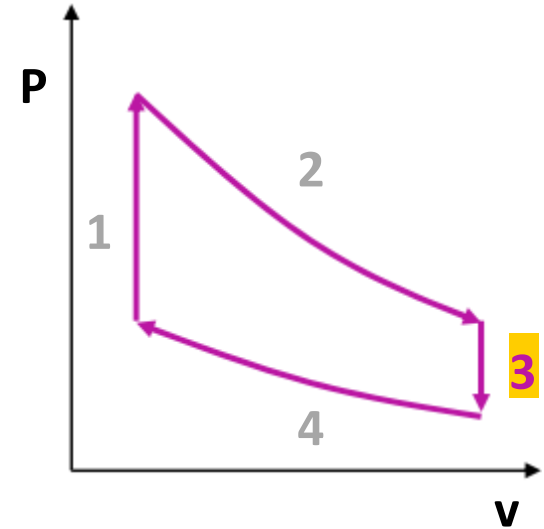
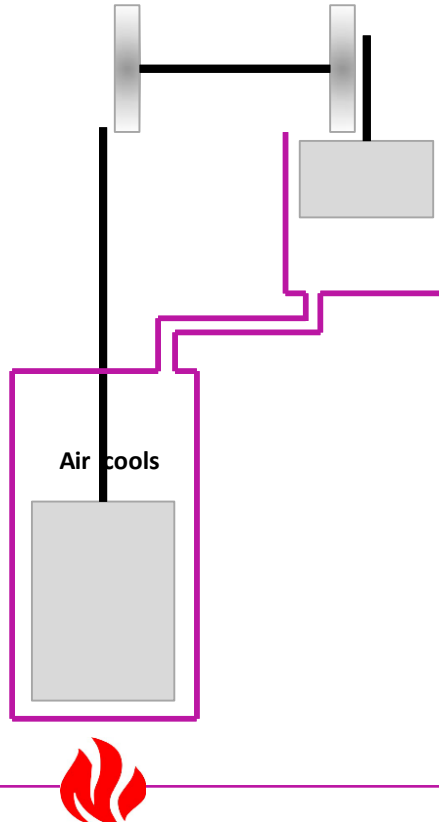

Stirling engines: How does it work?

Phase 4: Contraction

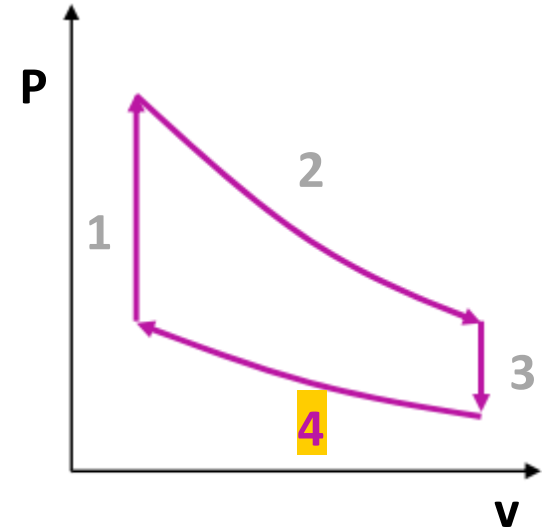
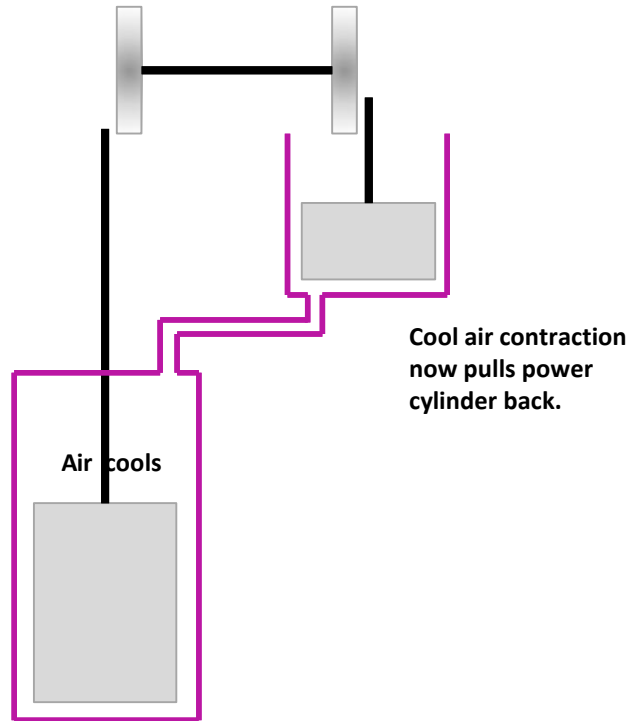

Stirling engines: How does it work?

What makes it turn?

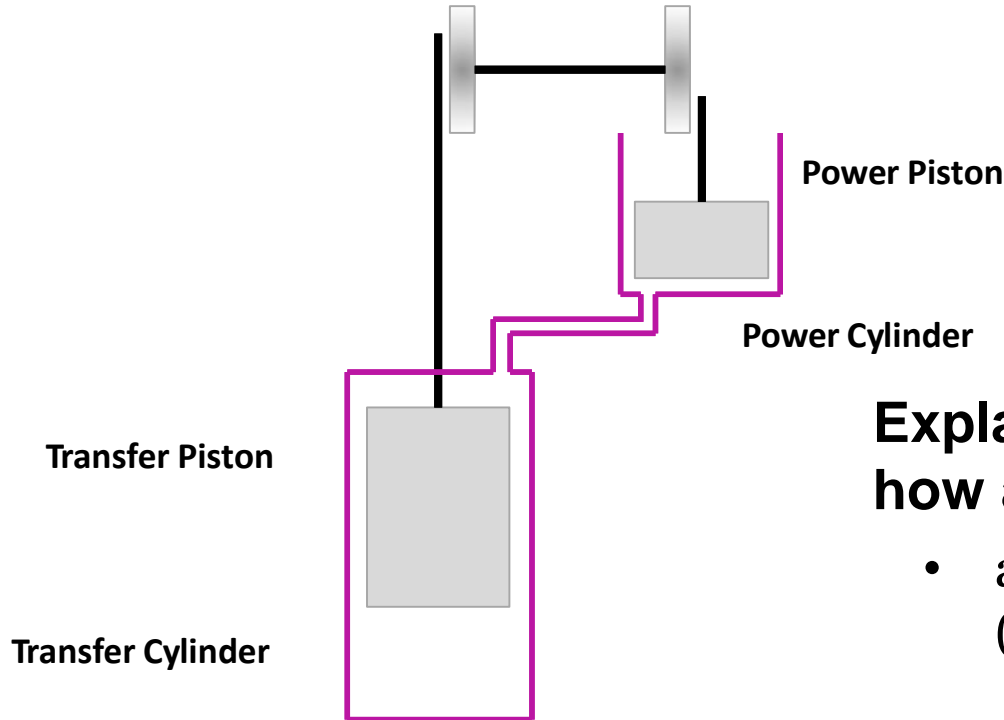

**Explain the Stirling cycle,
how a Stirling engine works**

- answer on MyCourses
(in-class assignment 2)





Aalto University
School of Engineering

MEC-E1003

Estimation

Design Calculations

In this course, and in your future life as a designer and engineer, you will need to do calculations:

- *How big a shaft do I need?*
- *How large a brake disc do I need?*
- *How small a battery can I use?*
- ...



Often you will initially answer these with calculations. Then you build the result of your calculation and “try it out”.

Engineering Estimation

Last year, we also asked to estimate the engine power.

Lecture 01 - In Class Assignment 1

How much useful shaft power can the engine generate?

Grading summary

Participants	65
Submitted	60
Needs grading	60
Due date	Friday, 17 September 2021, 4:15 PM
Time remaining	Assignment is due

[View all submissions](#)

[Grade](#)

Engineering Estimation

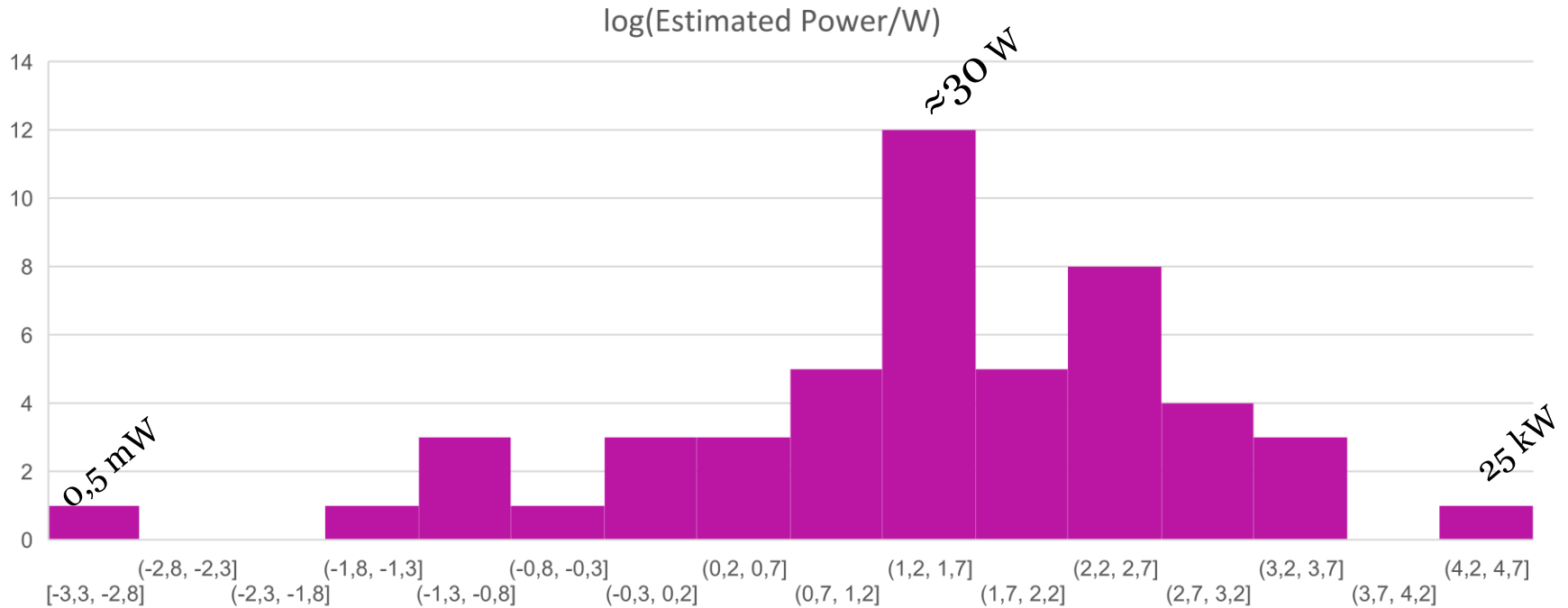

Estimation Skills

As an engineer, you need to be able to check your work
You use equations. You compute a result.
Is it right?



Estimation

The ability to estimate a quantity is an *engineering skill*.
You get better at it the more you do it.
It is *not* guessing.



How much power is generated by an A380 engine?



How much energy goes into the A380 brakes to stop the plane?



How much does an A380 weigh?



How long is an A380?



How wide is a door on an A380?



Perception and Estimation

It is easy to estimate amounts you can perceive



It is difficult to estimate amounts you cannot perceive

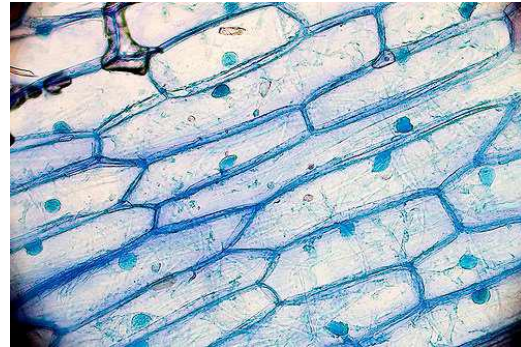

Perception and Estimation

- How long is 1m?
- How much force is 1N?
- How much pressure is 1Pa?
- How much energy is 1J?
- How much entropy is 1 J/K?

Perception and Estimation

Directly perceivable units can be more easily estimated.

- Length. Force. Temperature. Sound.

Units not directly perceivable cannot be as easily estimated.

- Speed. Force. Energy. Power. Entropy.

Estimation

- The ability to estimate is an *engineering skill*.
- You get better at it the more you do it.
- There are better estimating methods than others.

Estimation Process #1

1. Define the SI unit
2. Establish easily memorized reference points
3. Compare your unknown to your references

Example:

How much useful shaft power can the Stirling engine generate?

Estimation Process #1

1. Define the SI unit

Power: Watts

2. Establish easily memorized reference points



1mW



1W



10W



1000W



**200hp
150,000W**

3. Compare your unknown to your references

Reference Points

- On every SI unit, have available *personal, easily remembered* reference points every few orders of magnitude

10^{-6}

10^{-3}

1

10^3

10^6

m

kg

s

A

V

kg/m³

J

Pa

C

Hz

W

Estimation Process #2

1. Define the SI unit
2. Establish easily memorized reference points
3. Recall its most basic equation
4. Form a thought experiment
5. Estimate the equation inputs
6. Compute the equation and compare with references

Power Estimation

How much useful shaft power can the Stirling engine generate?

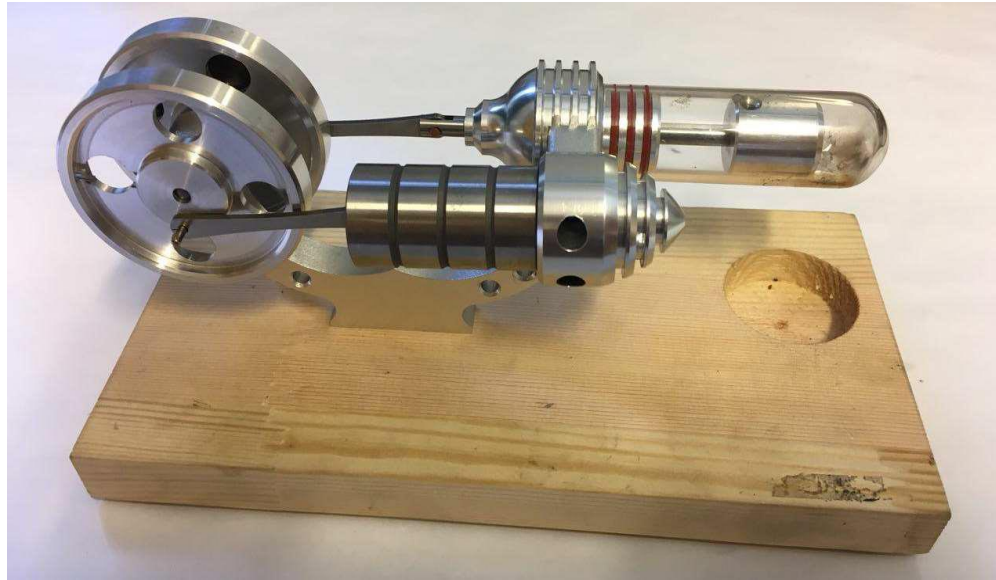

Estimation Process #2

1. Define the SI unit: *Watt*
2. Establish easily memorized reference points
3. Recall its most basic equation
4. Form a thought experiment

$$\text{Power} = \text{Torque} * \text{Rotational Speed}$$

*Estimation thought exercise:
If I push on the flywheel to slow it down,
how much drag torque is that?*



Estimation Process #2

1. Define the SI unit: Watt
2. Establish easily memorized reference points
3. Recall its most basic equation
4. Form a thought experiment
5. Estimate equation inputs
6. Compute the equation and compare with references

$$\begin{aligned} \text{Power} &= \text{Torque} * \text{Rotational Speed} \\ &= (\mu * N * d/2) * (\omega * 2\pi) \end{aligned}$$

$$d = 30\text{mm}, \quad \omega = 500\text{rpm}, \quad N = 1\text{N}, \quad \mu = 0.2$$

$$\text{Power} = (0.2 * 1\text{N} * 30\text{mm}/2) * (500/60 * 2\pi) = 0.2\text{W}$$

How much does an A380 weigh?

1. Define the SI unit: **kg**
2. Reference points
3. Basic equation

$$\text{Mass} = \text{density} * \text{volume}$$



How much does an A380 weigh?

1. Define the SI unit: **kg**
2. Reference points
3. Basic equation
4. Thought experiment

*Suppose it was placed on water.
Would it sink?
How far?*



How much does an A380 weigh?

1. Define the SI unit: **kg**
2. Reference points
3. Basic equation ...
4. Thought experiment

Mass = volume

** fraction that sinks*

** density of water*



How much power is generated by an A380 engine?

1. Define the SI unit: **N**
2. Reference points
3. Basic equation

Lift = weight of the plane



How much power is generated by an A380 engine?

1. Define the SI unit: **N**
2. Reference points
3. Basic equation
4. Thought experiment

Angle of attack α

$$4 * thrust = mass * g * \sin(\alpha)$$



How much energy goes into the A380 brakes to stop the plane?

1. Define the SI unit: **J**
2. Reference points
3. Basic equation

*Work = force * distance*



How much energy goes into the A380 brakes to stop the plane?

1. Define the SI unit: **J**
2. Reference points
3. Basic equation
4. Thought experiment

$$W = m * \Delta v / \Delta t * distance$$



Are these useful design equations?

$P = \text{torque} * \text{speed}$.

- To do any *design improvements*, though, we need a first-principles parametric equation.

What is the effect of changes?

- Increase the temperature?
- Decrease the work piston volume?
- Increase the exchange piston volume?
- Other ideas?

You cannot determine this without a first principles equation.

We need a thermodynamic derivation.

Engine Power

What is the power balance of the engine?

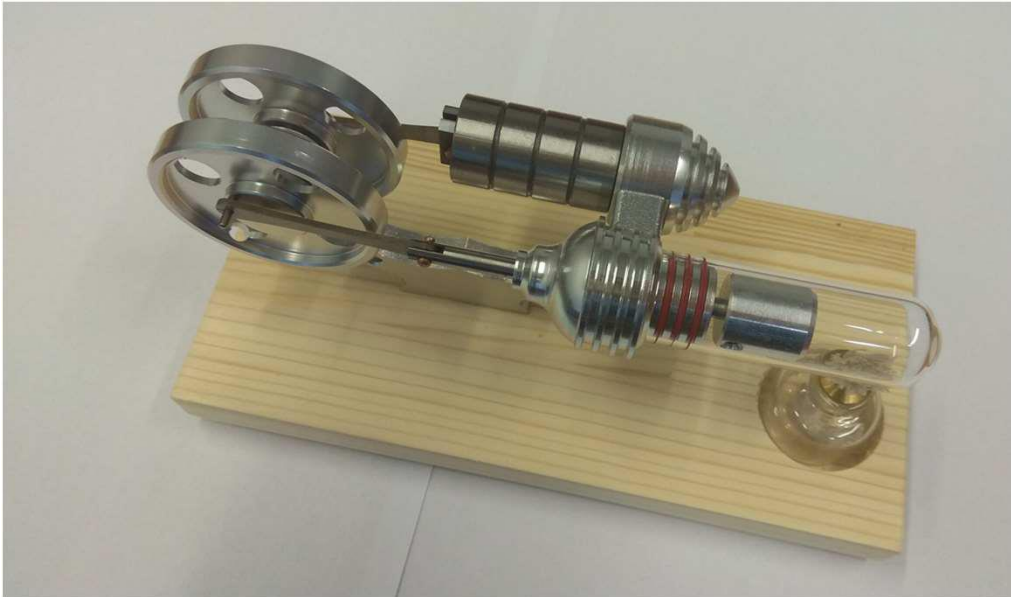

Engine Power

What is the power balance of the engine?

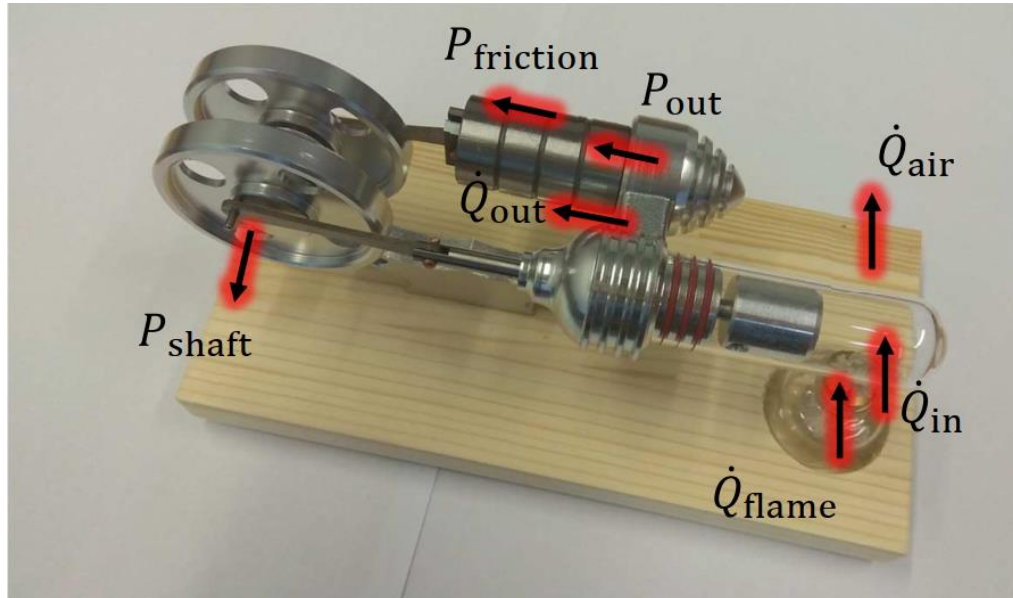

$$\dot{Q}_{\text{flame}} = \dot{Q}_{\text{in}} + \dot{Q}_{\text{lost to air}}$$

$$\dot{Q}_{\text{in}} = P_{\text{out}} + \dot{Q}_{\text{out}}$$

$$P_{\text{shaft}} = P_{\text{out}} - P_{\text{friction}}$$

Engine Power

Consider the engine. It is powered by a flame.

- What is something whose power (in Watts) you know that exhibits the same power as the flame? How much power does it exhibit?

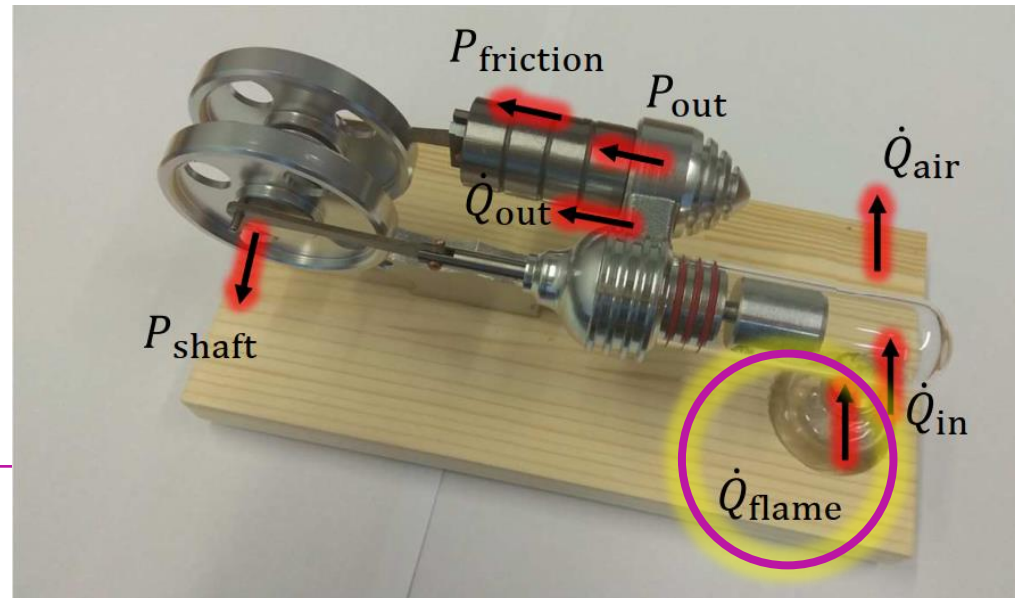

Engine Power

Consider the engine. It is powered by a flame.

- What is something whose power (in Watts) you know that exhibits the same power as the flame? How much power does it exhibit?
- Answer on MyCourses (in-class assignment 3)

Engine Power

Suppose a perfect engine, operating at Carnot efficiency
How much thermodynamic power P_{out} is generated?

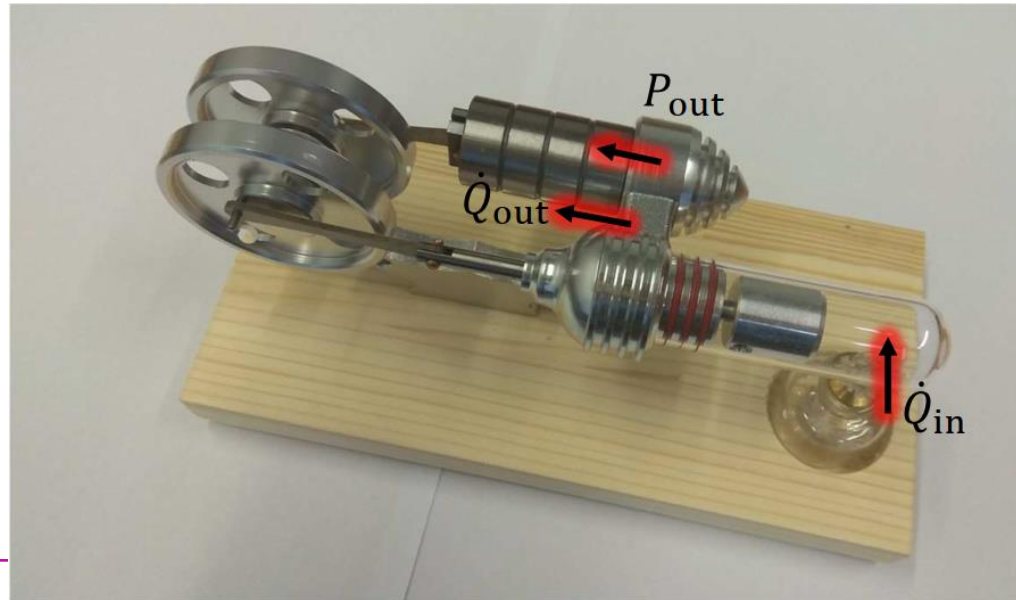

Ideal work cycle derivation

How much change in every cycle?

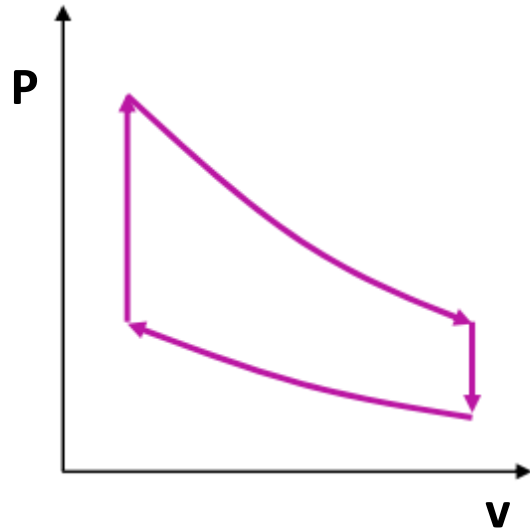

$$W = - \oint p dV$$

$$W = -mR \ln \left(\frac{V_{\text{hot}}}{V_{\text{cold}}} \right) (T_H - T_C) \quad P_{\text{out}} = W\omega$$

$$Q_{\text{in}} = mR \ln \left(\frac{V_{\text{hot}}}{V_{\text{cold}}} \right) (T_H) \quad \dot{Q}_{\text{out}} = Q_{\text{out}}\omega$$

$$Q_{\text{out}} = -mR \ln \left(\frac{V_{\text{hot}}}{V_{\text{cold}}} \right) (T_C) \quad \dot{Q}_{\text{in}} = Q_{\text{in}}\omega$$

Ideal work cycle derivation

How much thermodynamic power is ideally generated?

Input	Value	Unit
Air density ρ		kg/m ³
Ideal gas constant R		J/molC
Air molar mass		kg/mol
Hot Volume V_{hot}		m ³
Cold Volume V_{cold}		m ³
Hot Side Temperature T_H		C
Cold Side Temperature T_C		C

$$m = \rho V$$

$$P_{\text{out}} = \omega m R \ln \left(\frac{V_{\text{hot}}}{V_{\text{cold}}} \right) (T_H - T_C)$$

$$\dot{Q}_{\text{in}} = \omega m R \ln \left(\frac{V_{\text{hot}}}{V_{\text{cold}}} \right) (T_H)$$

$$\dot{Q}_{\text{out}} = \omega m R \ln \left(\frac{V_{\text{hot}}}{V_{\text{cold}}} \right) (T_C)$$

Ideal work cycle derivation

How much thermodynamic power is ideally generated?

Input	Value	Unit
Air density ρ	1.222	Kg/m ³
Ideal gas constant R	8.3145	J/molC
Air molar mass	0.029	kg/mol
Cold Volume V_{dead}	13.1	cm ³
Hot Volume V_{delta}	11.1	cm ³
Hot Side Temperature T_H	250	C
Cold Side Temperature T_C	25	C
Speed	500	rpm

$$m = \rho V$$

$$P_{\text{out}} = \omega m R \ln \left(\frac{V_{\text{hot}}}{V_{\text{cold}}} \right) (T_H - T_C)$$

$$\dot{Q}_{\text{in}} = \omega m R \ln \left(\frac{V_{\text{hot}}}{V_{\text{cold}}} \right) (T_H)$$

$$\dot{Q}_{\text{out}} = \omega m R \ln \left(\frac{V_{\text{hot}}}{V_{\text{cold}}} \right) (T_C)$$

Ideal work cycle derivation

How much thermodynamic power is ideally generated?

Vcold	11.10	cc			
Vhot	13.08	cc			
rho	1.225	kg/m3			
M	1.6E-05	kg			
R	8.3145	J/(K mol)			
mm	29	g/mol			
R'	286.7069	J/(K kg)	Qin	0.51	J
Th	400	C	Qout	-0.22	J
Tc	20	C	Work	0.29	J
Th	673	K			
Tc	293	K	Power in	4.24	W
Speed	500	rpm	Power loss	-1.85	W
w	8.333333	Hz	Power gen	2.40	W

$$m = \rho V$$

$$P_{\text{out}} = \omega m R \ln \left(\frac{V_{\text{hot}}}{V_{\text{cold}}} \right) (T_H - T_C)$$

$$\dot{Q}_{\text{in}} = \omega m R \ln \left(\frac{V_{\text{hot}}}{V_{\text{cold}}} \right) (T_H)$$

$$\dot{Q}_{\text{out}} = \omega m R \ln \left(\frac{V_{\text{hot}}}{V_{\text{cold}}} \right) (T_C)$$

Estimation Process

1. Define the SI unit

Power: Watts

2. Establish easily memorized reference points



1mW



1W



10W



1000W



**200hp
150,000W**

3. Compare your unknown to your references

Engine Power

Estimate of the power balance of the engine

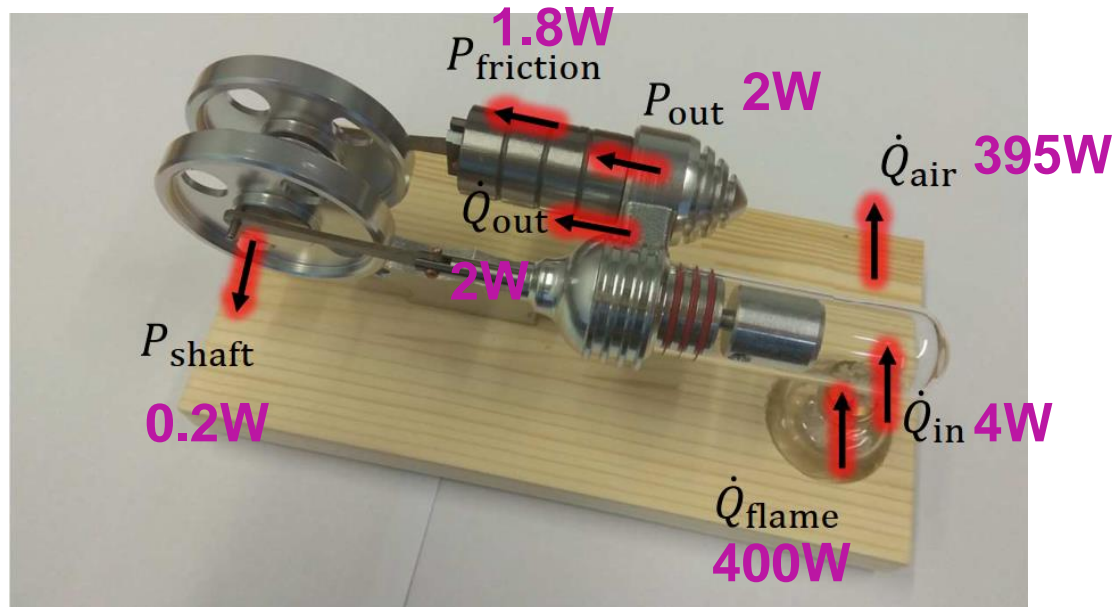

Schmidt Stirling engine analysis

The engine is not ideal.

It does not have Carnot efficiency.

A more accurate analysis incorporates the sine wave motion of the two cylinders.

This was first done by Prof. Gustav Schmidt in 1871.



Theorie der Lehmann'schen calorischen Maschine. In: Zeitschrift des Vereins deutscher Ingenieure. 1871 Band XV, 1871. Heft 1, S. 1–12, dazu Tafel III, und Heft 2, S. 97–112.

Schmidt Analysis

The volumes are calculated as the engine rotates.

Using the ideal gas law, pressures are calculated from the temperatures.

The resulting p-V diagram is used to calculate the work.

$$W = - \oint p dV = \int_{-\pi}^{\pi} p V d\theta$$

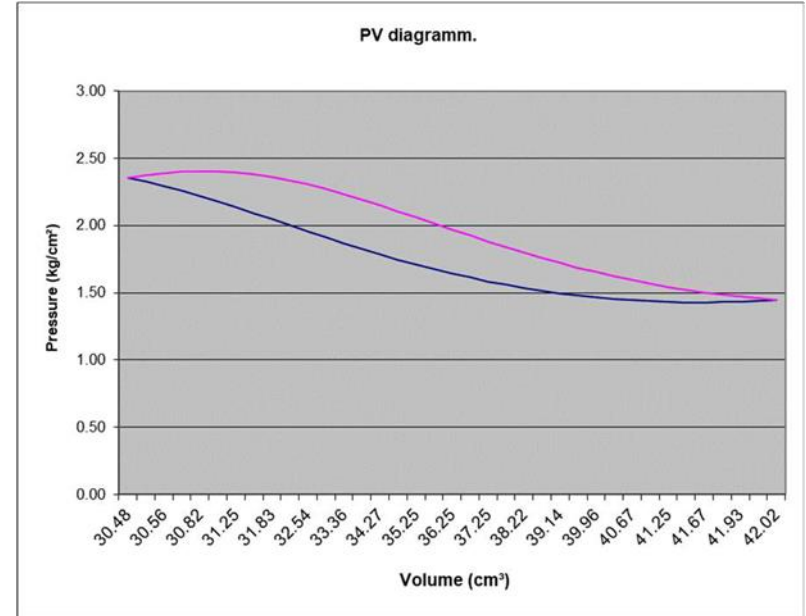

Schmidt Analysis

This is all provided in an Excel spreadsheet, modified for easier use.
Note the parametric engine dimensions.

Dimensions		Length (mm)
	Displacer piston	19,90 mm
	Displacer travel	16,20 mm
	Displacer cylinder	47,60 mm
	Displacer shaft	90,00 mm
	Power Piston	10,00 mm
	Power piston travel	16,00 mm
	Power cylinder	47,00 mm
	Regenerator 1	63,70 mm
	dcp	
	dpp	
	Xrd +Rsl	18,20 mm
	Xe	30,00 mm
	Xpp	15,50 mm
	Xd	2,00 mm
	Xp	0,50 mm
	ldh	9,50 mm
	Psi	90,00 degrés
Operating Measurements		
	Th	400,0 °C
	Tc	20,0 °C
	dT	1,0 °C
	Po	101359,9 Pa
	Speed	500,0 rpm
Calculated Power		
	Power	1,51 W

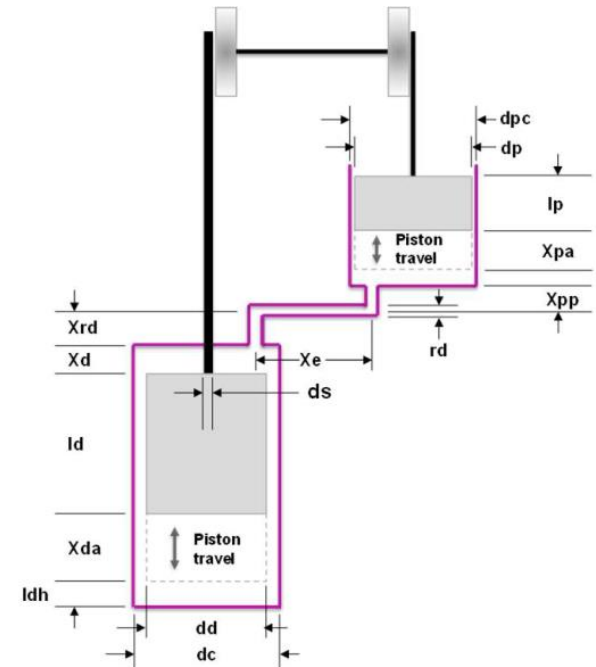

Homework 2: engine improvements

Using the engine thermodynamic power calculator spreadsheet

- ~~1. Enter the engine dimensions into the spreadsheet~~
 - ~~2. Compute the engine power~~
 3. Suggest a **design change** that would increase engine power and compute the new power level
- Turn in the Schmidt calculator xlsx file with your design changes made as highlighted yellow cells.

DUE: September 30th, 2022

Summary

This course is about mechanical engineering design

- Engineering involves application of physics as equations
- When you calculate a result, you need to be able to ascertain if the result is correct before you spend resources fabricating

To judge correctness you need to estimate

Estimating is a learned skill

- Units
- Easily memorized reference points on each unit
- Use simple equations to validate that you have made no dumb mistakes in your detailed correct equations