

A!

Aalto University
School of Chemical
Technology

Fibres and nanofibers: structure-property relationships

Eero Kontturi
6th October 2022

CHEM-E2140

Learning outcome

- Basic idea on what in the structure of fibres influences the properties of macroscopic objects made of fibres
- Awareness of quantitative theories on (nano) fibre networks
- Knowledge on how the presence and absence of water affects the properties of fibres and fibre products

Contents

- (1) Plant fibres vs. others
- (2) Properties of single fibres and nanofibres
- (3) Fibre network: basic theories
 - Cox theory
 - Page equation
 - Gibson-Ashby theory
- (4) Effect of moisture on paper
- (5) Effect of water and removal of water on fibres and fibre networks
- (6) Case study with nanopaper from cellulose nanofibres

Plant fibres vs. other fibres

- All plant fibres are, by definition, composite structures:
 - Cellulose/hemicellulose/lignin

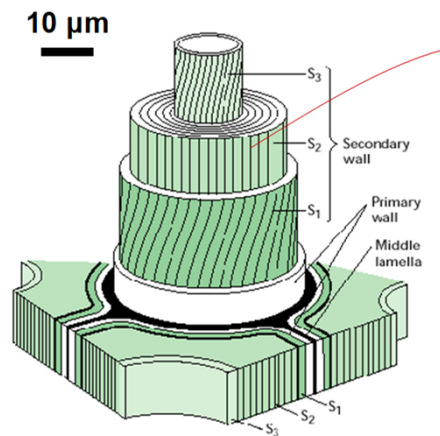

- Cellulose is the main structural (load-bearing) component
- Hemicellulose/lignin matrix gives flexibility and controls the moisture content
- Lignin protects against pathogen

Plant fibres vs. other fibres

- Many synthetic fibres are monocomponent and homogeneous structures
- Most regenerated cellulose fibres are also monocomponent and homogeneous structures
- All fibres can be used as reinforcing phases in composites
- However, few fibres are composites by themselves

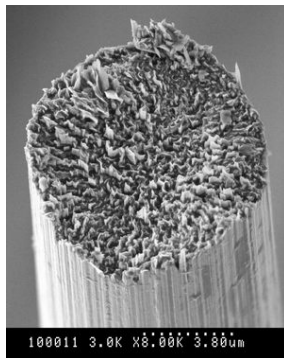

Carbon
fibre

Viscose
fibres



Properties of single cellulose-based fibres

Comparison of tensile properties

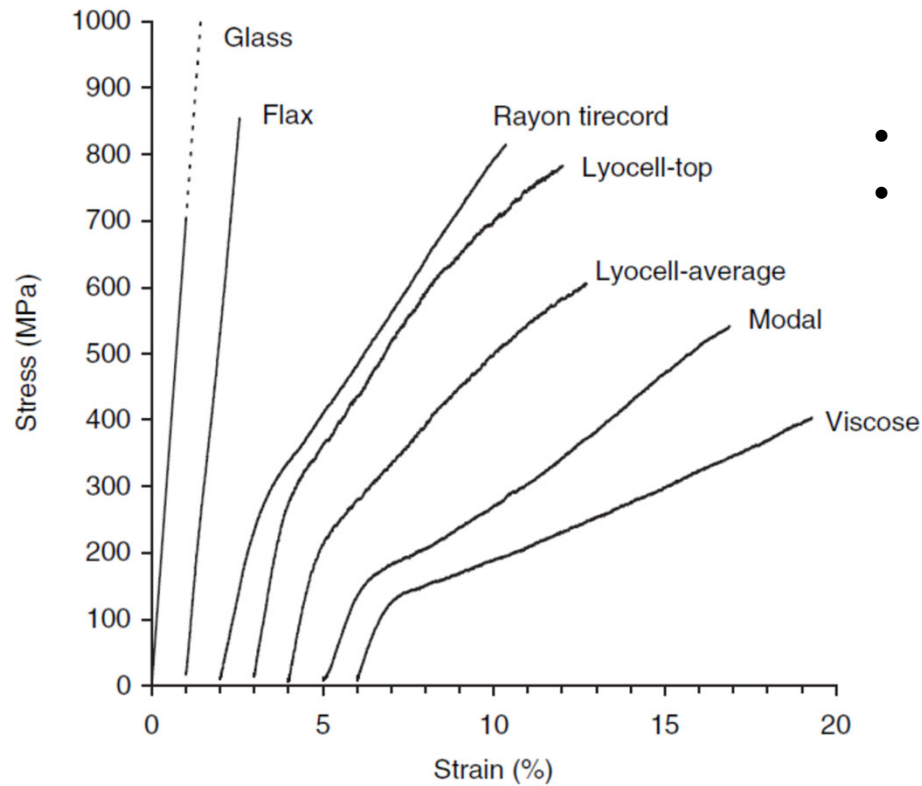

- Glass fibre goes up to 3000 MPa
- However, the density of glass fibres is ~2.5 whereas cellulose fibres possess typically a density of 1.5

Tensile strength vs. modulus

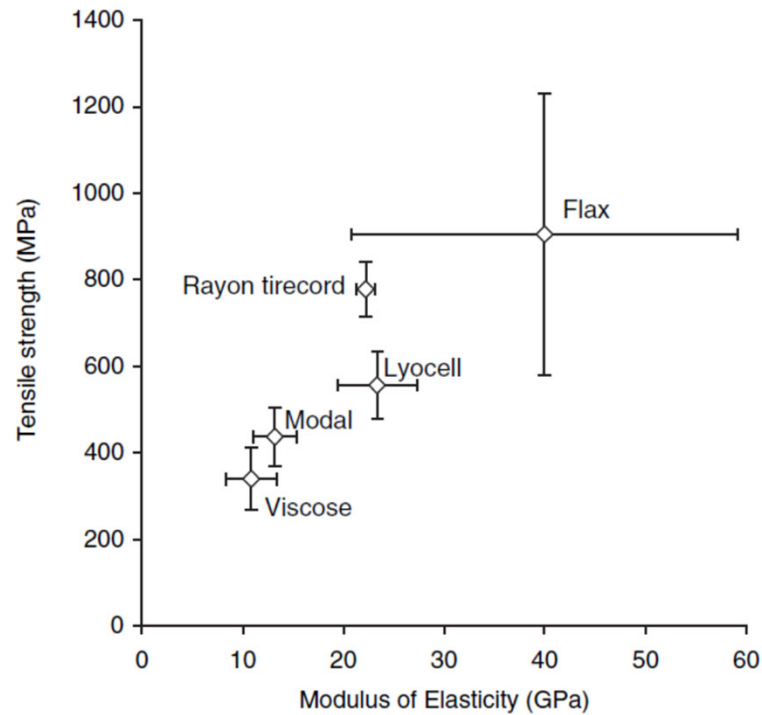

- Natural cellulose fibres (like flax) are typically superior in tensile strength and modulus compared with regenerated cellulose fibres

Single fibre properties – comparison

Table 1.

Average tensile properties of regenerated cellulose and reference fibres (E – modulus of elasticity, σ_f – tensile strength, ε_f – elongation at break, W_{ef} – work to fracture, for lyocell top values are given in brackets).

Fibre	E (GPa)	σ_f (MPa)	ε_f (%)	W_{ef} ($J \cdot 10^{-3} \text{ mm}^{-3}$)
Viscose	10.8 ± 2.5	340 ± 73	15.4 ± 2.2	32.7
Modal	13.2 ± 2.2	437 ± 69	10.4 ± 1.8	37.2
Lyocell	23.4 (30.5) ± 3.9	556 (790) ± 78	8.7 ± 1.6	34.5 (47.1)
Rayon tirecord	22.2 ± 1.0	778 ± 62	10.7 ± 1.4	40.8
Flax	40.0 ± 19.2	904 ± 326	1.4 ± 0.2	6.7
Glass	70.0 ± 9.3	3000 ± 356	$4.3 \pm$	54.3

Lyocell modulus – how fibre diameter affects the modulus

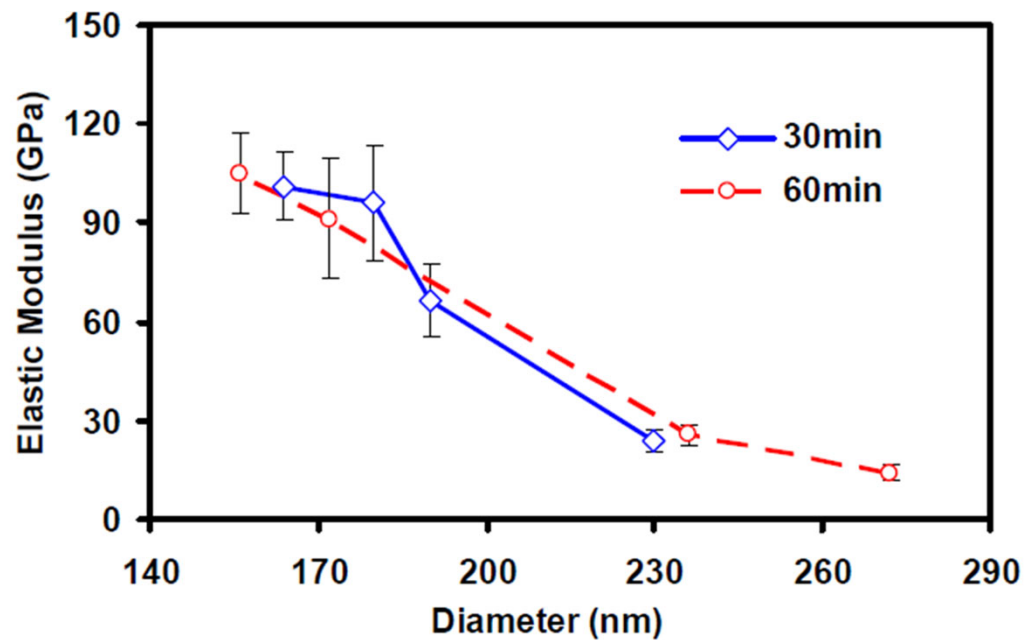

- Fibre diameter (increased surface area) has a drastic effect on the fibre modulus

Cellulose nanofibres

- Strength and modulus depend on the method used for measuring and interpreting but in general they are considered very high for individual fibrils

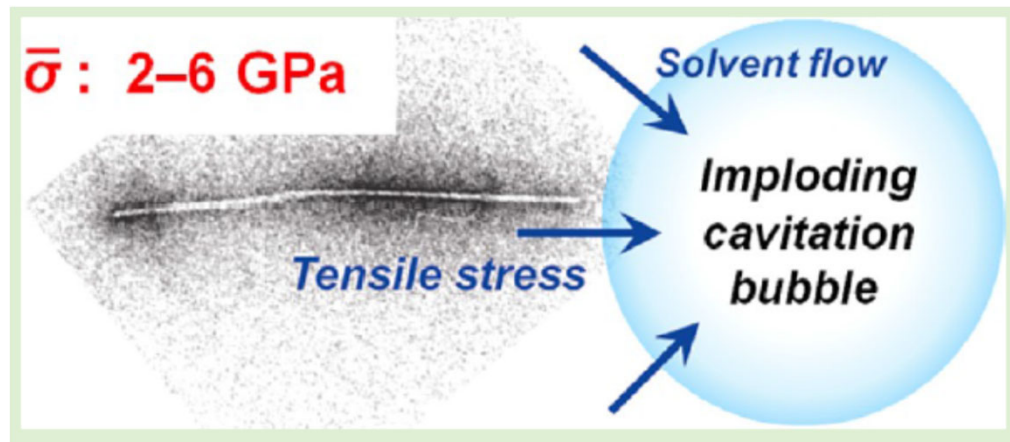

Tensile strength for TEMPO-oxidized nanofibres: 2-6 GPa

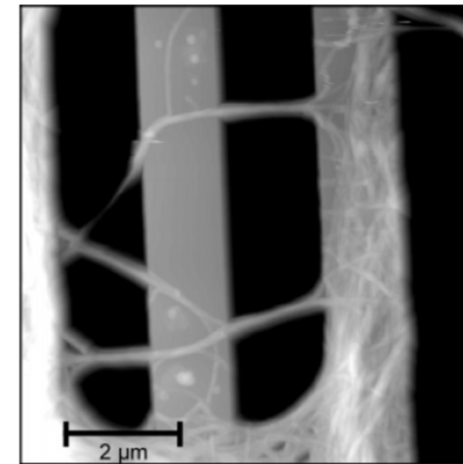

Elastic modulus for bacterial cellulose nanofibres: ~80 GPa

Comparison of strength/modulus of various fibres

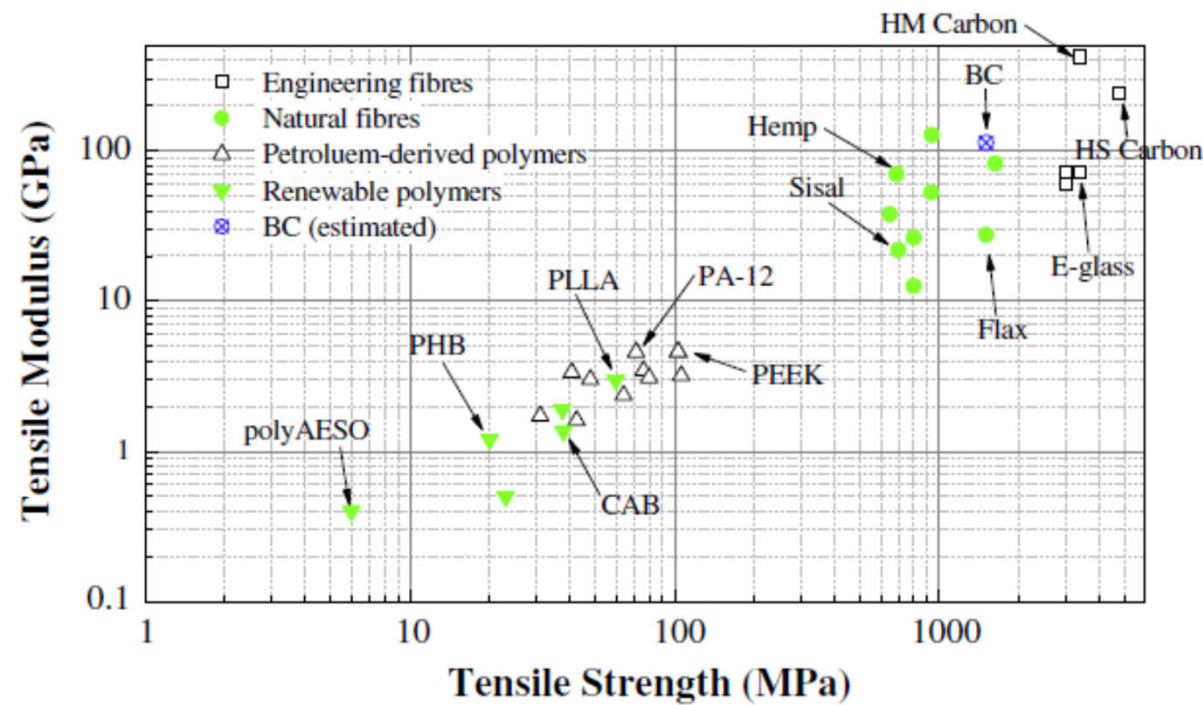

BC Bacterial cellulose
 PLLA Polylactic acid
 PEEK Polyether ether ketone
 PHB Polyhydroxybutyrate
 CAB Cellulose acetate butyrate
 AESO Acrylated epoxidized soybean oil
 HS High strength
 HM High modulus

Theoretical strength of crystalline cellulose

Table 3

Theoretical tensile strength of cellulose crystals.

Calculation assumptions	$\sigma_{\text{theoretical}}$ (MPa)
Stress to cause cohesive fracture based on intra-chain link energy	7340
Stress to cause chain scission based on potential energy function	22600 ¹ and 17150 ²
Stress to cause separation of chains if ends are all in one transverse plane	280
Stress to cause sliding fracture	1260 ¹ and 1190 ²
Stress normal to chain axis to rupture hydrogen bonds	300
Ultimate shear strength	323

Strength of crystalline cellulose is theoretically extremely high.

Nanopaper strength

- Nanopaper means a network (paper) made of cellulose nanofibres

Table 2. Physical and Average Mechanical Properties for MFC Films Prepared of MFC with Different DP^a

material	porosity [%]	modulus, E [GPa]	slope in the plastic region, n [GPa]	yield stress, $\sigma_{0.2}$ [MPa]	tensile strength, σ_c [MPa]	strain-to-failure, ϵ_c [%]	work to fracture, W_A [MJ/m ³]
DP-410	20	13.7 (0.3)	- ^b	81.5 (4.7)	129 (8.7)	3.3 (0.4)	3.0 (0.5)
DP-580	24	10.7 (1.2)	1.27 (0.13)	83.6 (2.1)	159 (16.4)	6.4 (1.7)	7.1 (2.5)
DP-820		10.4 (0.5)	1.50 (0.07)	83.6 (2.8)	181 (12.7)	7.4 (1.5)	9.1 (2.3)
DP-1100	28	13.2 (0.6)	1.28 (0.16)	92.2 (5.2)	214 (6.8)	10.1 (1.4)	15.1 (1.9)

^a The values in parentheses are the sample standard deviations. ^b Due to low ϵ_c , the plastic region is limited and this value can not be calculated.

However, the strength of crystalline cellulose is not realized even in the highly dense nanopapers.

Fibre network

- Cox
- Page
- Gibson-Ashby

Cox theory

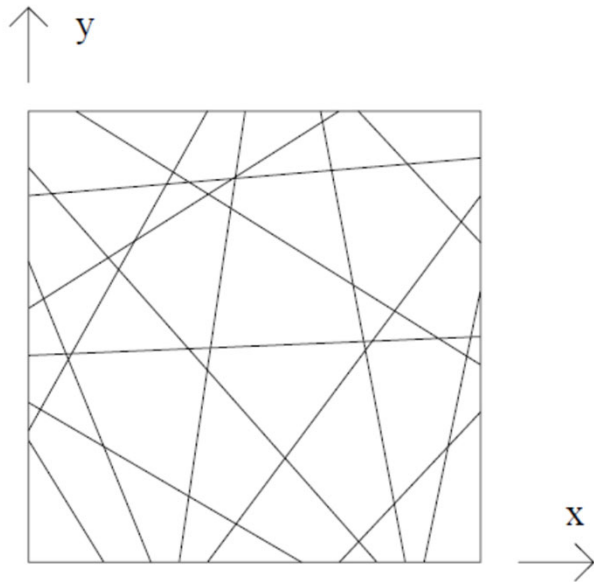

Preconditions:

- Long, thin, straight fibres
- Uniform network
- Homogeneous strain field
- Fibres carry axial load only
- Fibres do not interact with each other

Cox theory

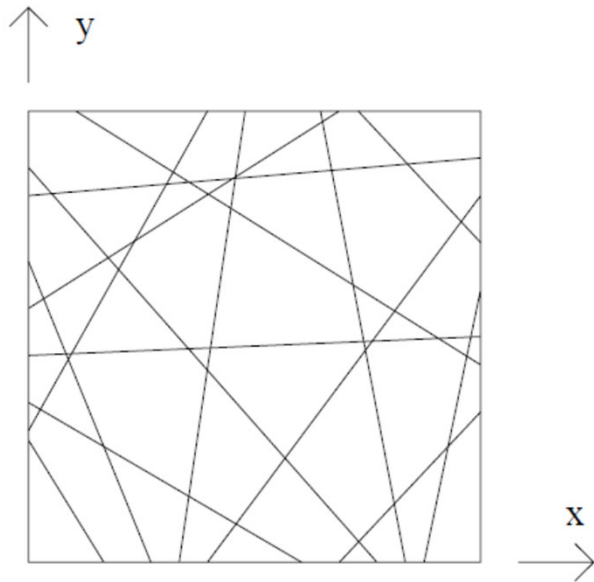

Strain (ϵ) is a vector and is related to strain in directions x and y as well as to angle of fibre around its own axis (γ)

$$\epsilon = (\epsilon_x, \epsilon_y, \gamma_{xy})$$

Cox theory

$$\epsilon = \epsilon_x \cos^2 \alpha + \epsilon_y \sin^2 \alpha + \gamma_{xy} \cos \alpha \sin \alpha$$

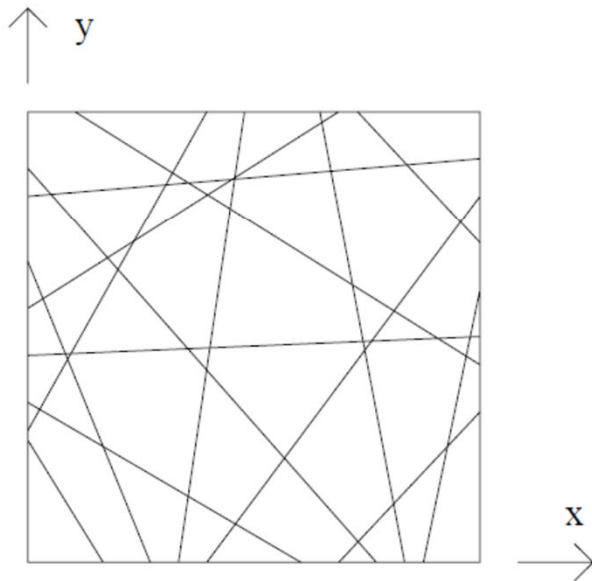

Axial strain (ϵ) in a fibre inclined at an angle α to the x-axis

Cox theory

$$F = E_f A_f (\epsilon_x \cos^2 \alpha + \epsilon_y \sin^2 \alpha + \gamma_{xy} \cos \alpha \sin \alpha)$$

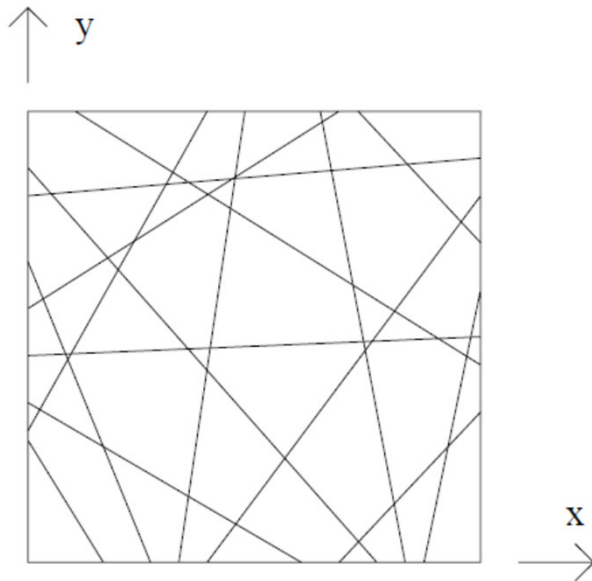

Force (F) on a fibre
 A_f is the cross-sectional area

The equation is derived from
Hooke's law

Cox theory

$$f(\alpha) = \frac{1}{\pi}(1 + a_1 \cos 2\alpha + a_2 \cos 4\alpha + \dots + b_1 \sin 2\alpha + b_2 \sin 4\alpha + \dots)$$

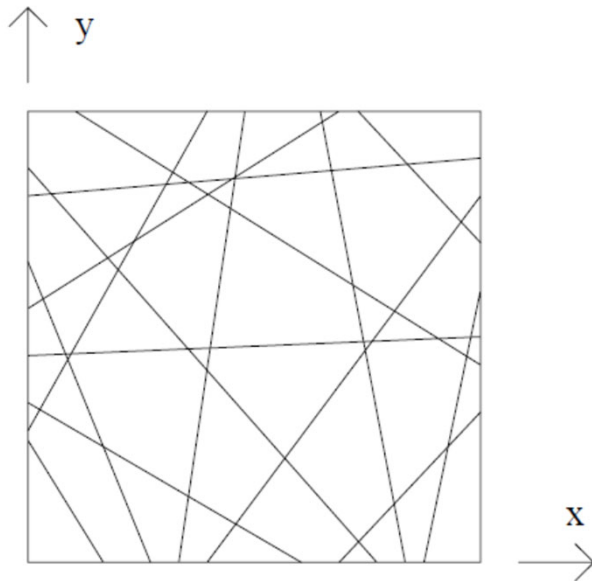

Fibres can be presented as a matrix
 $a_1, a_2 \dots$ are coefficients

$$\int_0^{\pi} f(\alpha) d\alpha = 1$$

For an isotropic network $f(\alpha)=\pi$

Cox theory

After matrix algebra, we derive the value K:

$$K = A_f E_f \rho = \frac{\rho_s}{\rho_f} E_f$$

where

A_f is the cross-sectional area

E_f is the elastic modulus

ρ_s is the density of fibre network

ρ_f is the density of a fibre

Network values:

$$E = \frac{K}{3} \quad \text{Elastic modulus}$$

$$G = \frac{K}{8} \quad \text{Shear modulus}$$

$$\nu = \frac{1}{3}, \quad \text{Poisson's ratio}$$

Notes on Cox theory

- Seminal theory for fibre networks in general
- Works for well-bonded networks of long fibres
- Modulus values from Cox theory can be viewed as theoretical upper limits for cellulosic fibre networks
- In practice the modulus values predicted by the Cox theory are never reached for cellulosic fibres

Page equation

$$\left[\frac{1}{T} \right] = \left[\frac{9}{8Z} \right] + \left[\frac{(12g \cdot C)}{(P \cdot l \cdot b \cdot RBA)} \right]$$

Cannot be measured easily



- l = fiber length (length)
- b = fiber-fiber bond strength (N/m²)
- RBA = relative bonded area (unit less)
- g = gravitational constant -(length/second² = 9.8 m/s²)
- T = tensile breaking length (length)
- Z = zero span tensile (length)
- C = fiber coarseness (weight/length)
- P = fiber perimeter (length)

Notes on Page equation

$$\left[\frac{1}{T} \right] = \left[\frac{9}{8Z} \right] + \left[\frac{(12g \cdot C)}{(P \cdot l \cdot b \cdot RBA)} \right]$$

- Relative bonded area can be approximated from light scattering measurements because more inter-fibre bonds scatter less light
- Works well for papers from chemical pulp fibres, but also nanopapers have recently been well-described by the Page equation
- Although the Page equation was designed for paper (pulp fibres), it works mainly for relatively straight, unbroken fibres; they should be mostly free from kinks and curls

Gibson-Ashby theory for cellular solids

Fibrillar networks can be approached as cellular solids

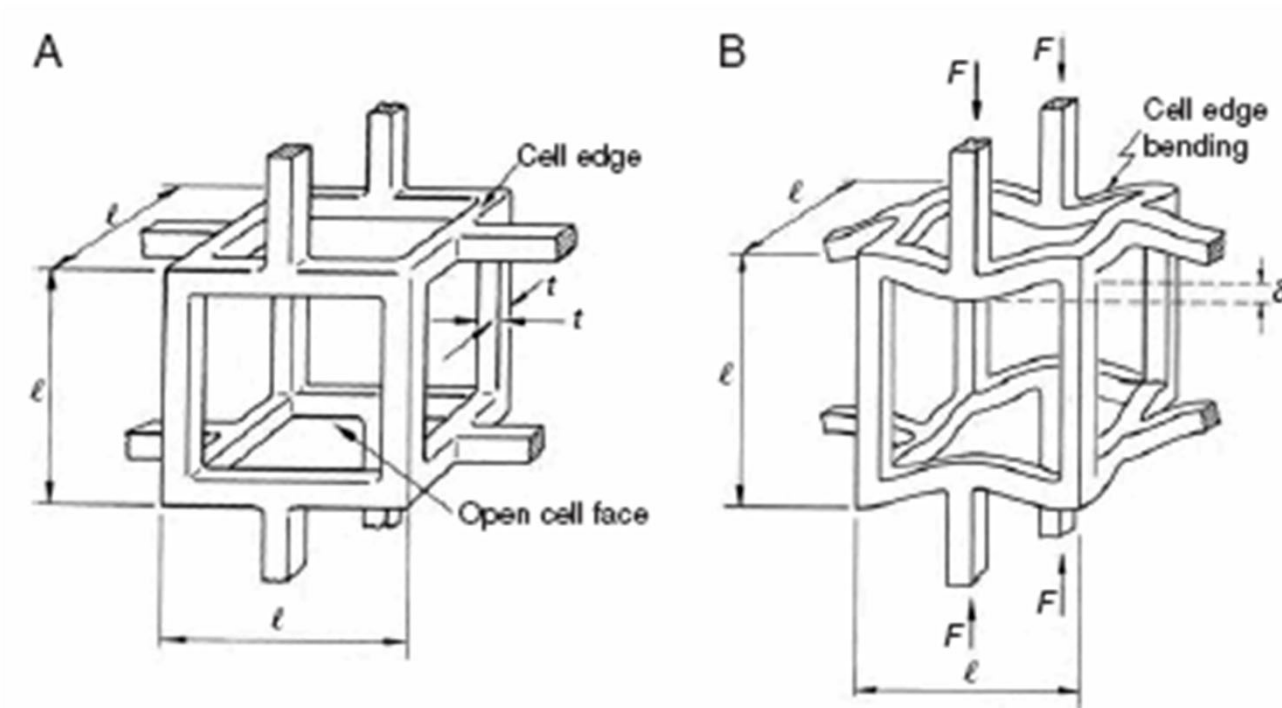

Gibson-Ashby theory for cellular solids

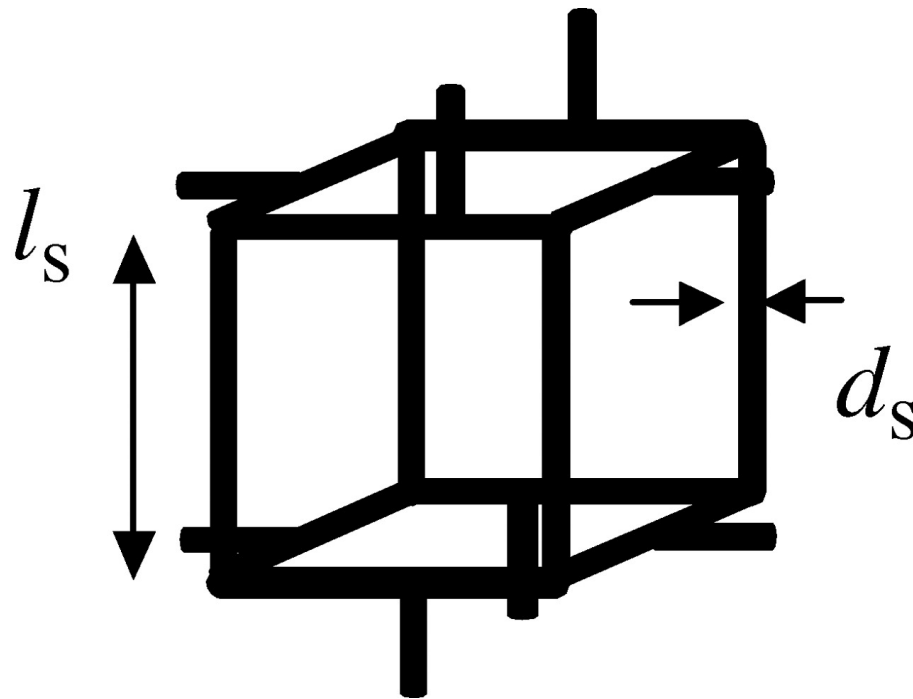

$$\frac{E^*}{E_s} = \left\{ \frac{\rho^*}{\rho_s} \right\}^2$$

E_s – Modulus of a fibril

ρ_s – Density of a fibril

E^* – Modulus of a film

ρ^* – Density of a film

Simple case study: effect of moisture on paper strength

Tensile strength goes down with increasing relative humidity

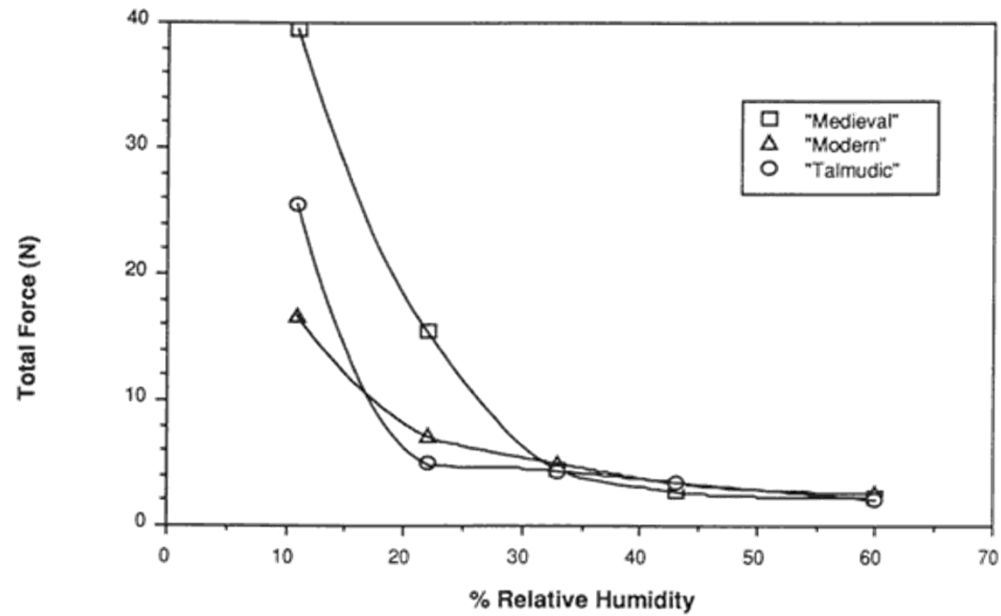

Tensile strength decreases with increasing moisture content

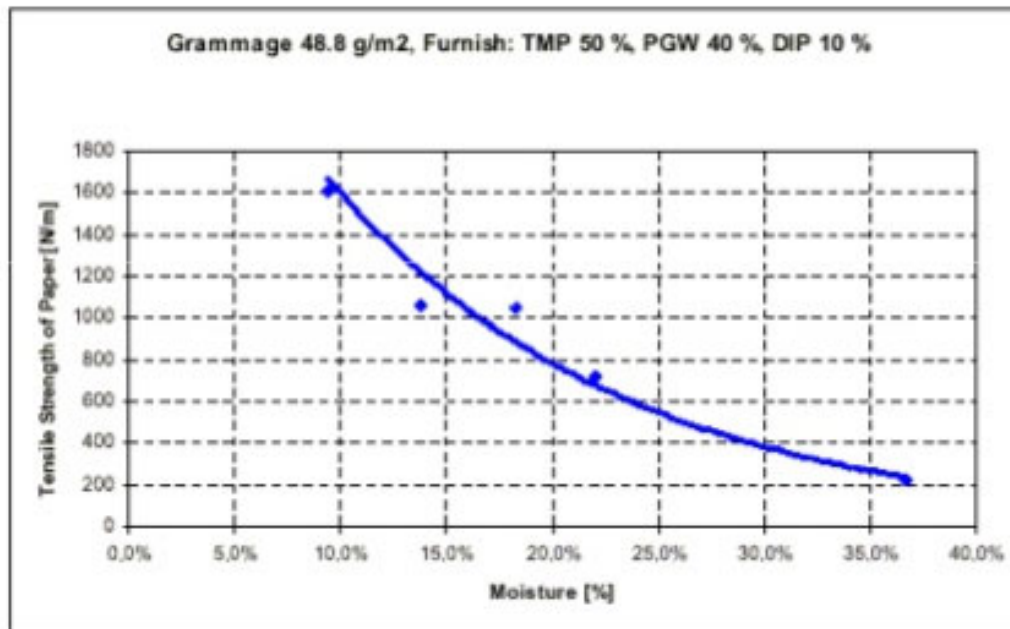

- Notwithstanding the paper grade (historic, newsprint, art paper etc.), the detrimental effect of humidity on paper strength is clear

Notes on humidity effect

- The effect of humidity, i.e., added moisture on a paper sheet is unambiguous: tensile strength goes down
- The reason for decreased tensile strength is the hydrophilic nature of cellulose: water penetrates between the fibre-fibre bonds and reduces their strength; moreover, water penetrates between the microfibrils and makes the fibres softer

Case study on fibre networks: porosity of cellulose fibres

Swelling of chemical pulp fibres

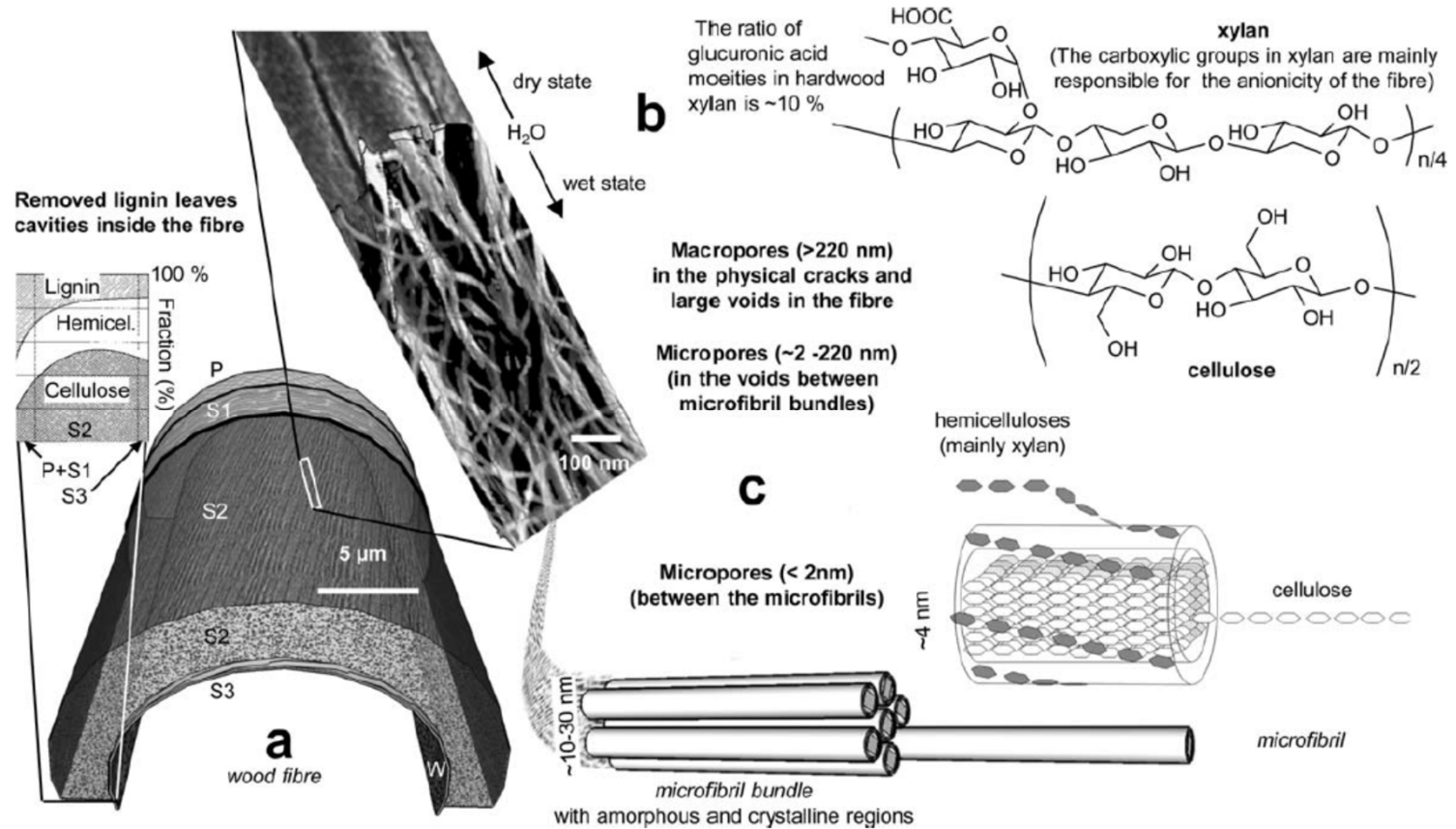

Swelling of chemical pulp fibres

Verbal summary of the previous slide:

- Pulp fibres are full of pores because lignin has been removed from between cellulose microfibrils
- However, the pores exist only in presence of water; when dried, the microfibrils collapse together and the pores do not exist
- In other words, the presence of water-filled pores is equal to swelling of the fibre
- Water is attracted to cellulose because of its OH-groups but the presence of charged groups (like COO⁻ in xylan) strongly increases water sorption

How to measure swelling/porosity?

The most straightforward measure is to determine the water retained in fibres, i.e., water retention value (WRV):

$$WRV = \frac{m_1}{m_2} - 1 \quad [1]$$

where

m_1 is the mass of the centrifuged wet test pad, in grams;

m_2 is the mass of the dry test pad, in grams.

Before the measurement, free water is removed by centrifugation, leaving behind the water bound (retained) in the cell wall of the fibre

What happens when fibres are dried?

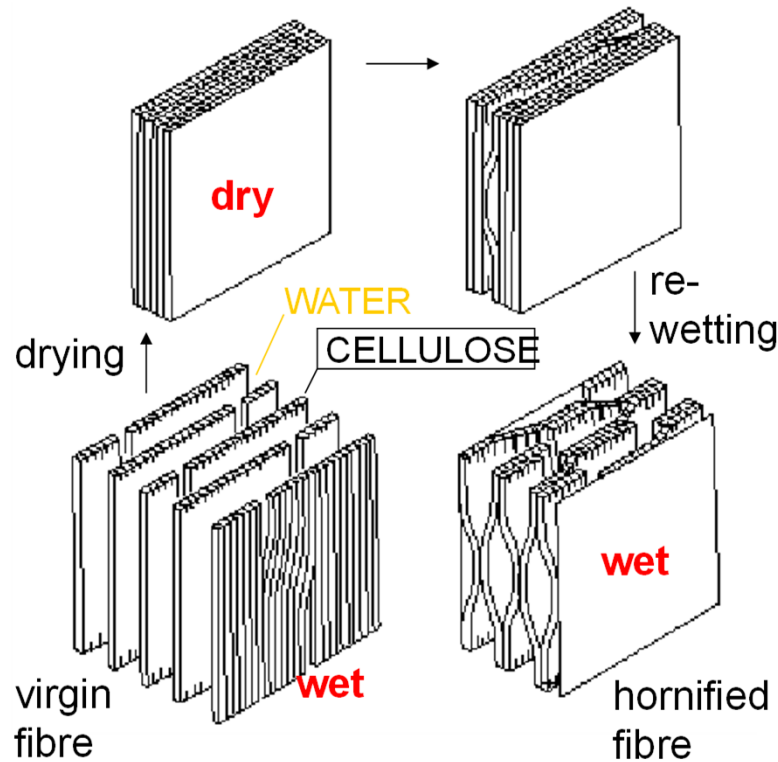

- When paper is recycled it needs to be slushed to pulp **in water**
- Rewetting of the fibre induces irreversible changes
 - Fibres do not swell to the same extent as they used to before drying (hornification)
 - Flexibility of the fibre is partially lost

Results of hornification: aggregation of cellulose microfibrils in fibre

Table 1. The Lateral Dimensions of Fibrils and Fibril Aggregates Before and After Drying *

Sample	Average lateral fibril dimension (nm)		Average lateral fibril aggregate dimension (nm)		Hemicellulose (% on dry wood)
	Never-dried pulp	Dried handsheets	Never-dried pulp	Dried handsheets	
Kraft cook (H factor 2000)	4.8	4.8	18.1	23.1	10
Kraft cook (H factor 1600)	4.5	4.8	17.9	21.4	17
Kraft cook (H factor 1300)	3.9	4.5	15.4	17.6	22

* Adapted from Hult *et al.* 2001; Copyright 2001 with permission from Elsevier

Results of hornification: strength of single fibres

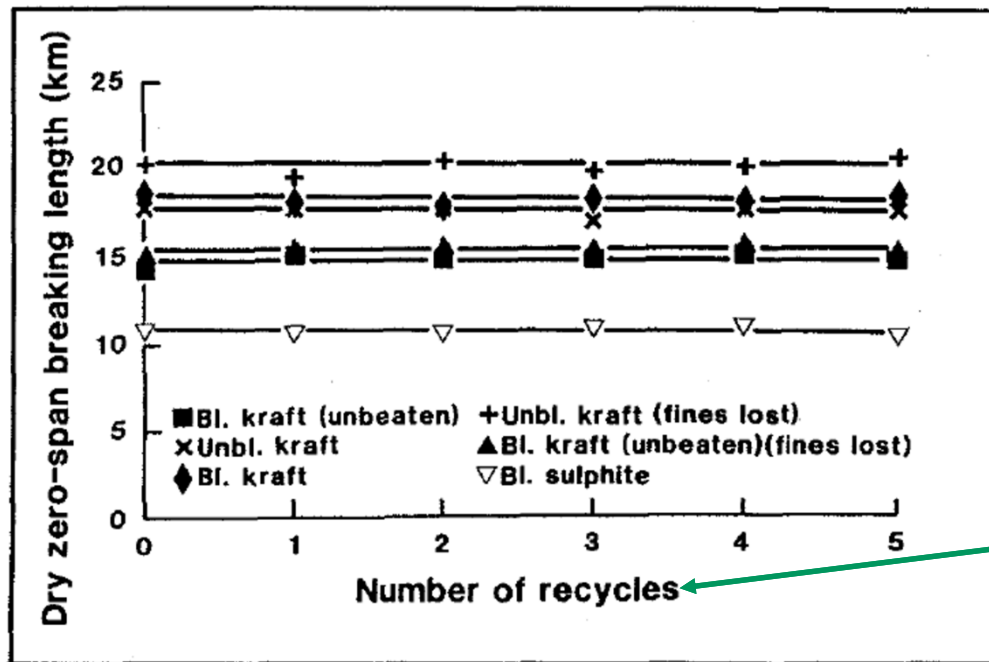

Note: Hornification does not affect the tensile strength of single fibres (as measured by zero-span measurement)

Number of drying steps

Results of hornification: elasticity of single fibres

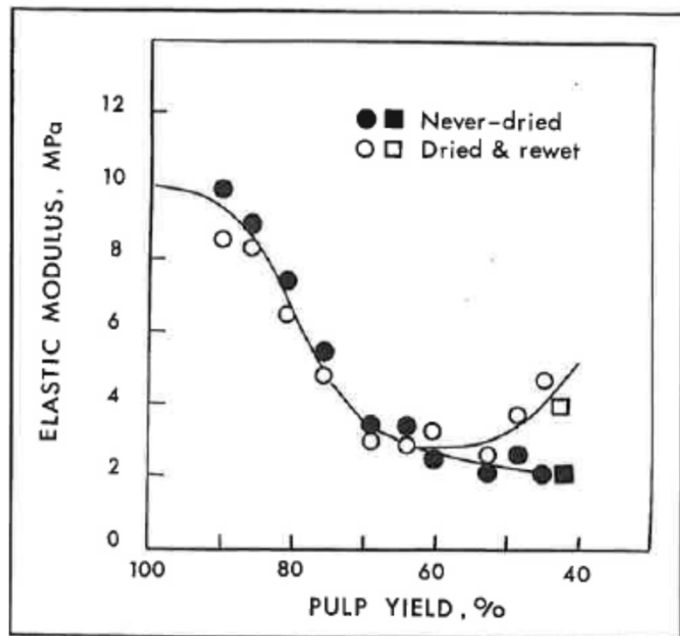

Hornification affects the elasticity (plasticity) of single fibres when the lignin content of the pulps is very low (i.e., pulp yield is low)
→ Drying makes fibres stiffer when they consists of mainly cellulose and hemicellulose

Results of hornification: loss of tensile strength in paper sheets (fibre network)

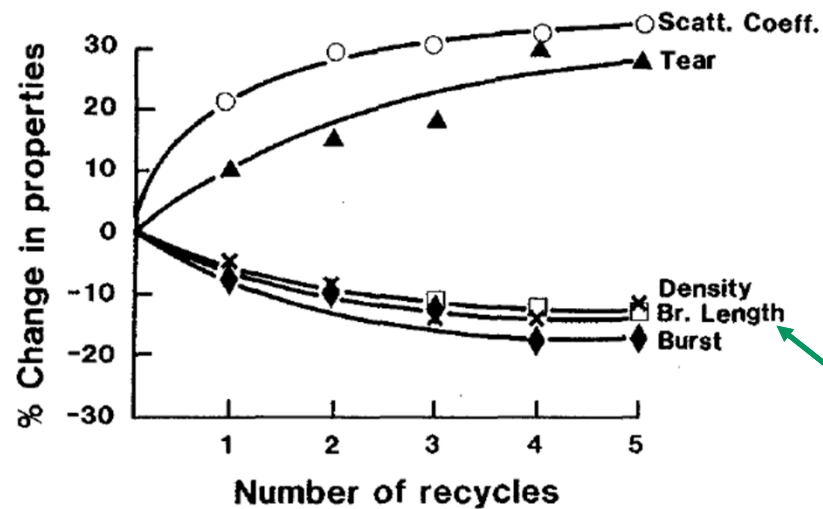

- Fibres become stiffer because of reduced swelling
 - Less conformation for favourable fibre-fibre bonds
 - Reduced tensile properties

Correlates with tensile strength

Notes on hornification

- Many factors affect the changes in fibre morphology upon drying/rewetting; microfibril aggregation is just one of them
- For example, collapse of the hollow lumen plays a big role in the properties of the dried fibre and the subsequent fibre network
- Moreover, the effects of hornification are not straightforward: for example, reduced swelling is favourable for dewatering in the paper machine
- Many effects of hornification can be reversed by, e.g., beating fibres

Lesson learned: structure-property relationship of native fibres is a very complex one – which structure affects which property

Case study on nanopaper strength: effect of hemicellulose

Two types of nanopapers

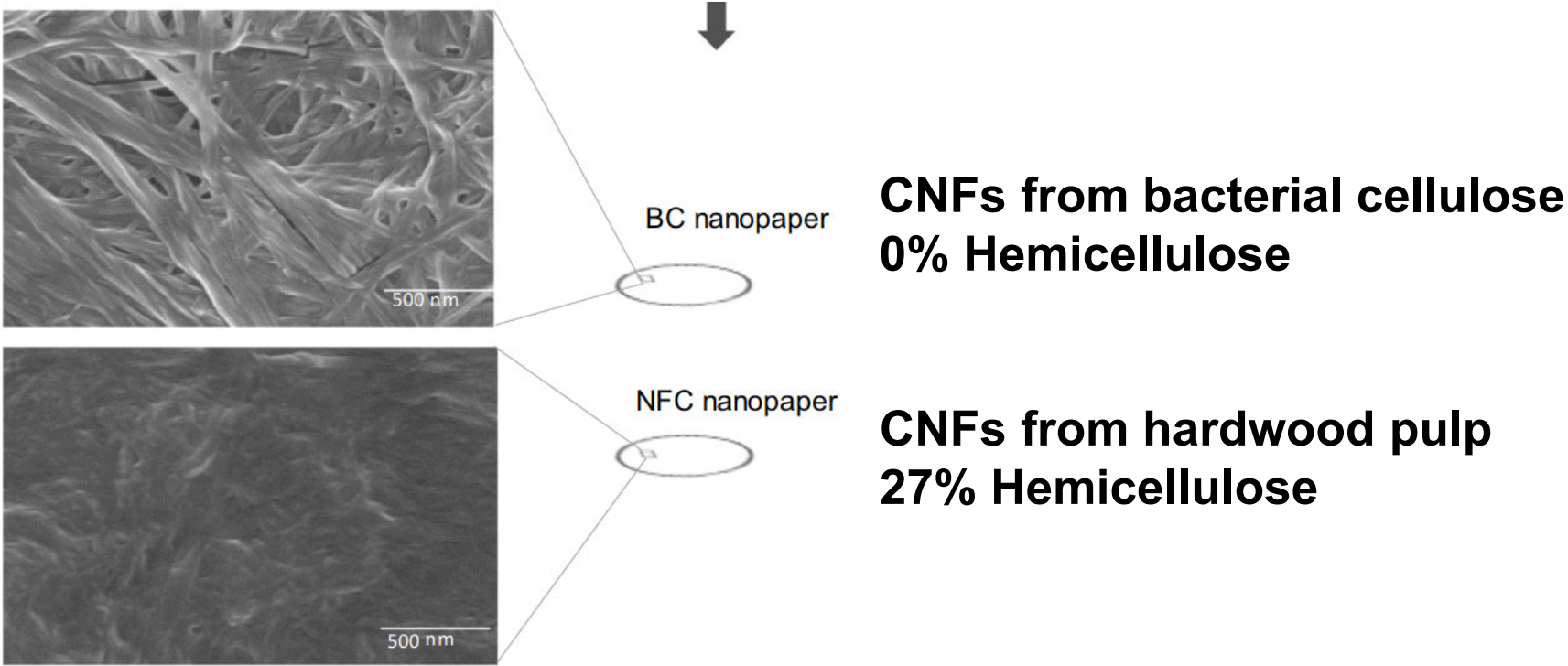

Tensile properties of two nanopapers

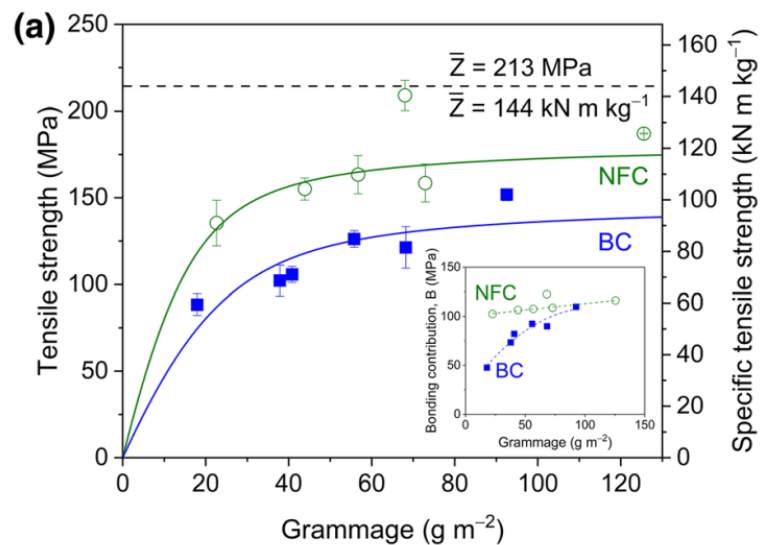

Wood-based CNFs (NFC) have a higher tensile strength

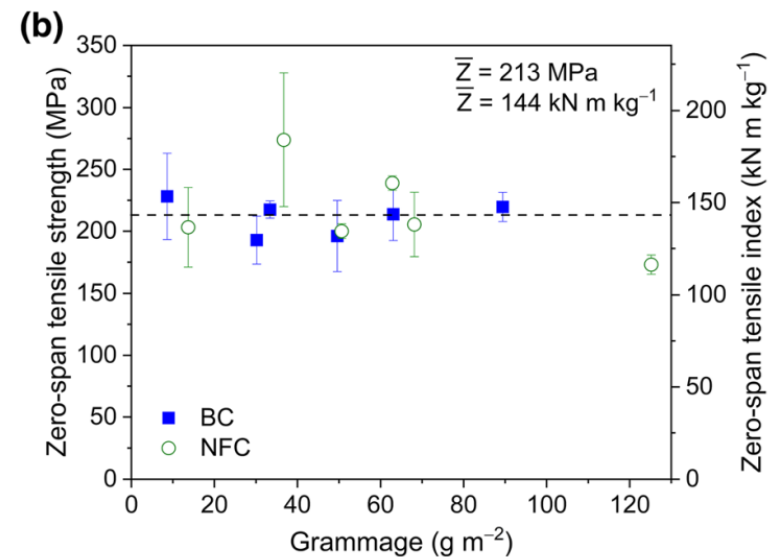

Zero-span strength (corresponds to individual fibre strength) is the same.

Hemicellulose effect on strength

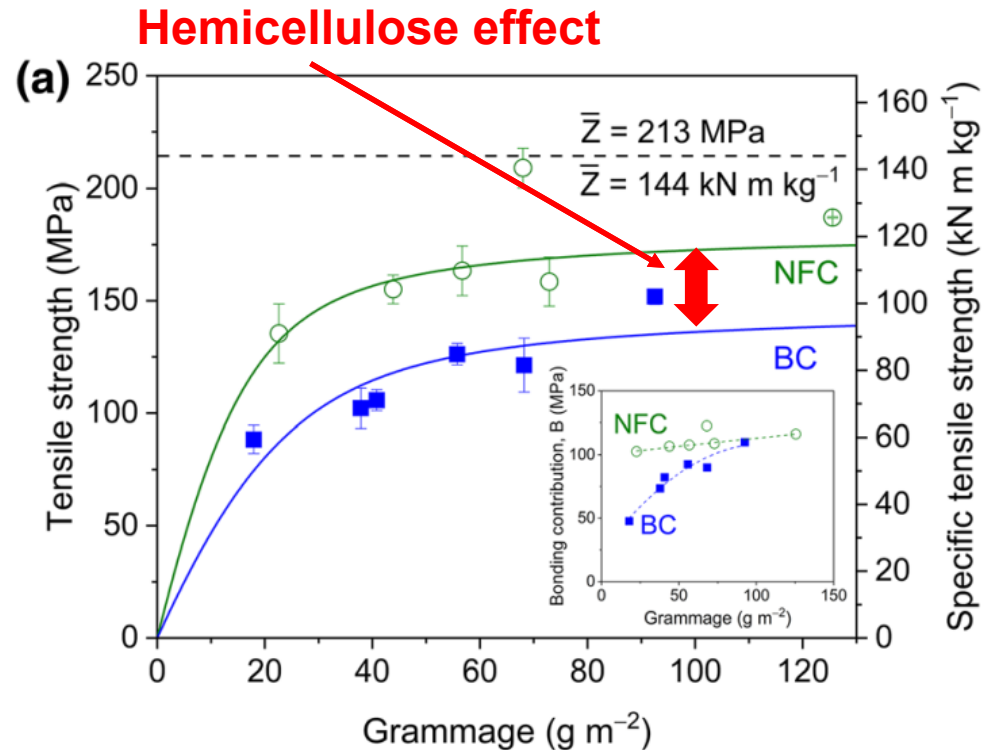

Page equation in *simple* form
(without empirical constants):

$$\frac{1}{T} = \frac{1}{Z} + \frac{1}{B}$$

- Zero-span (Z) is the same for both nanopapers
- Bonding (B) is stronger for wood-based CNFs (NFC)
- The effect of hemicellulose on tensile strength (T) can be as high as 25%

Case study with cellulose nanopapers - CNF size

Scaling laws for strength and toughness

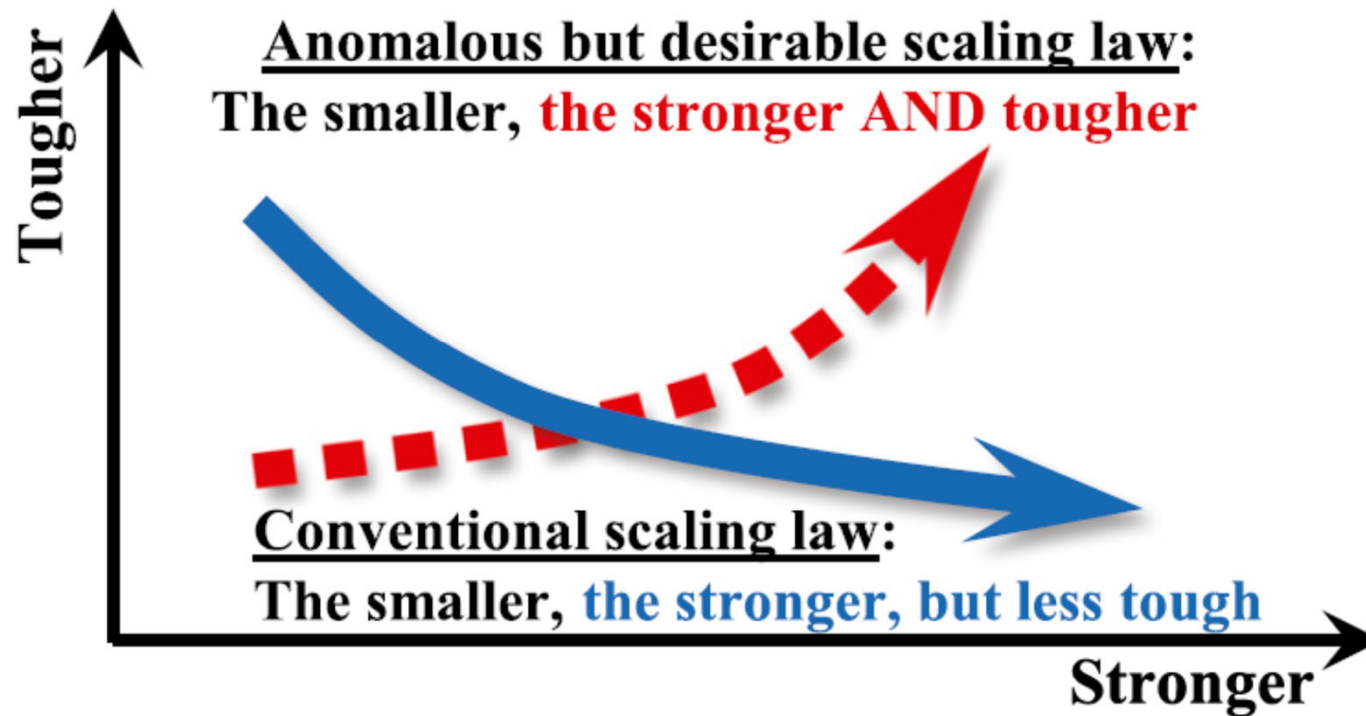

Toughness development according to fibre diameter

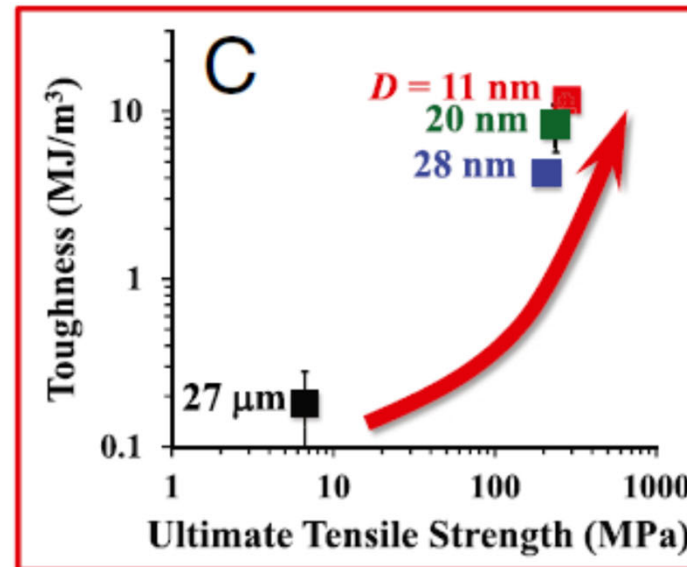
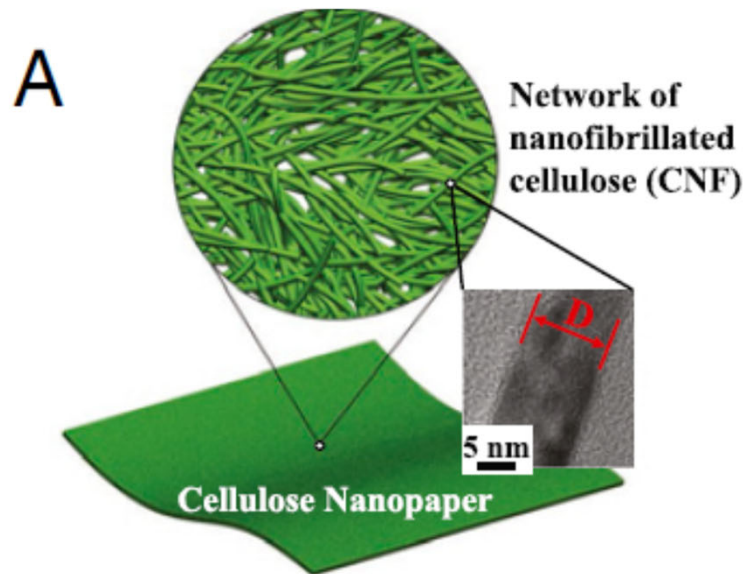

Strength development according to fibre diameter

Nanopaper strength vs. fibre diameter

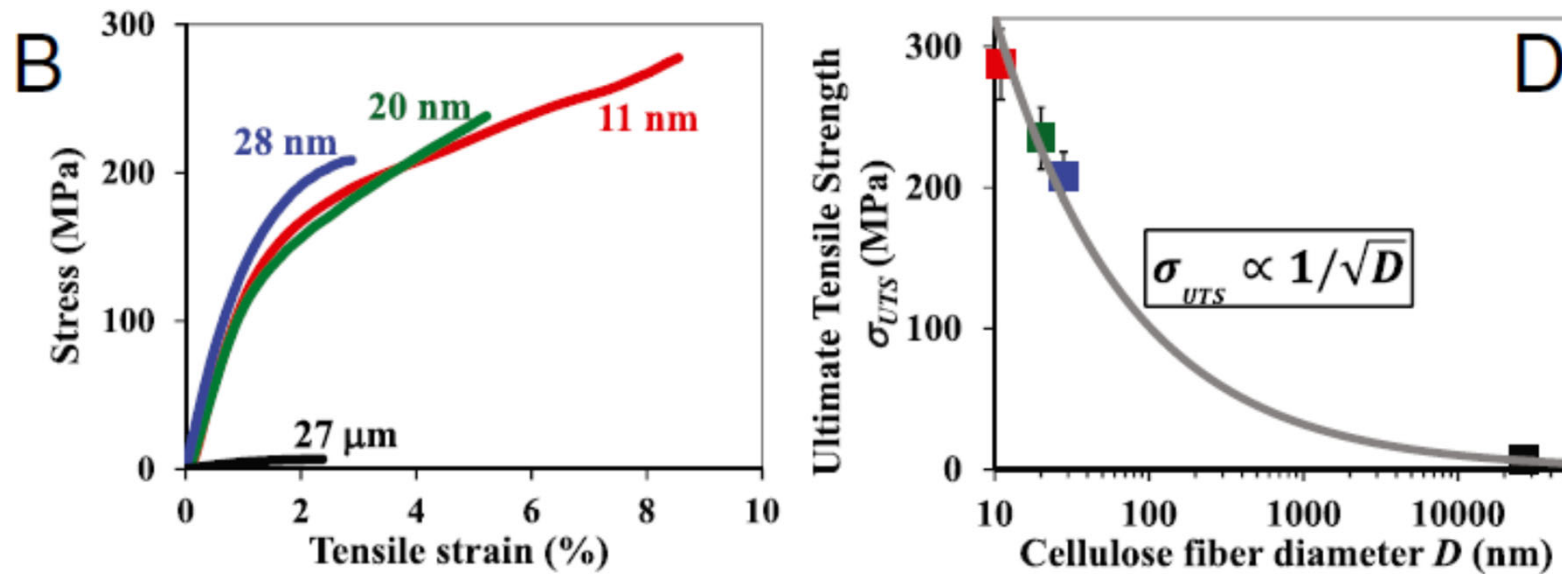

Anomalous scaling law – why?

- (1) Fewer defects in smaller fibres
- (2) Multiple hydrogen bonds between small CNFs can break and reform → dissipation of energy

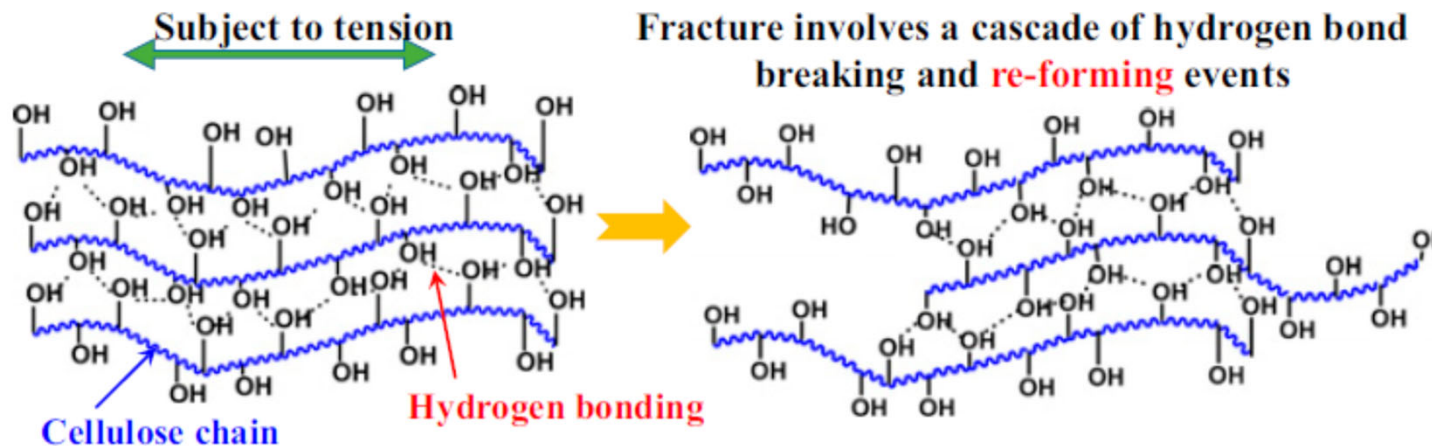

Summary

- Particularly native cellulose fibres are very strong and stiff when compared with their density
- Strength of individual fibres or nanofibres is not manifested in the isotropic fibre networks to their full extent
- Cox theory is fundamental for fibre networks but does not work well for cellulose-based fibres
- Effect of moisture on paper is unambiguous: increased moisture decreases paper strength
- Anomalous scaling law for cellulose nanopaper: strength and toughness increase with decreasing CNF width
- Many structure-property relationships with cellulosic fibres and fibre networks are ambiguous