

Review

Overview of Compressed Air Energy Storage and Technology Development

Jidai Wang ^{1,*}, Kunpeng Lu ¹, Lan Ma ¹, Jihong Wang ^{2,3} , Mark Dooner ², Shihong Miao ³, Jian Li ³ and Dan Wang ^{3,*}

¹ College of Mechanical and Electronic Engineering, Shandong University of Science and Technology, Qingdao 266590, China; kpsdust@163.com (K.L.); 18205426505@163.com (L.M.)

² School of Engineering, University of Warwick, West Midlands, Coventry CV47AL, UK; jihong.wang@warwick.ac.uk or jihongwang@hust.edu.cn (J.W.); m.dooner.1@warwick.ac.uk (M.D.)

³ State Key Laboratory of Advanced Electromagnetic Engineering and Technology, School of Electrical and Electronic Engineering, Huazhong University of Science and Technology, Wuhan 430074, China; shmiao@hust.edu.cn (S.M.); Jianli@hust.edu.cn (J.L.)

* Correspondence: djdwang8911@sina.com (J.W.); wangdan@hust.edu.cn (D.W.); Tel.: +86-158-5420-2209 (J.W.); +86-130-0619-0033 (D.W.)

Received: 18 May 2017; Accepted: 7 July 2017; Published: 13 July 2017

Abstract: With the increase of power generation from renewable energy sources and due to their intermittent nature, the power grid is facing the great challenge in maintaining the power network stability and reliability. To address the challenge, one of the options is to detach the power generation from consumption via energy storage. The intention of this paper is to give an overview of the current technology developments in compressed air energy storage (CAES) and the future direction of the technology development in this area. Compared with other energy storage technologies, CAES is proven to be a clean and sustainable type of energy storage with the unique features of high capacity and long-duration of the storage. Its scale and cost are similar to pumped hydroelectric storage (PHS), thus CAES has attracted much attention in recent years while further development for PHS is restricted by the availability of suitable geological locations. The paper presents the state-of-the-art of current CAES technology development, analyses the major technological barriers/weaknesses and proposes suggestions for future technology development. This paper should provide a useful reference for CAES technology research and development strategy.

Keywords: compressed air energy storage (CAES); renewable energy; energy storage

1. Introduction

How to maintain economic growth and at the same time reduce the usage of fossil fuel for environmental protection is a global challenge. Various efforts are being made, mainly in two aspects: to reduce the energy consumption by improving energy efficiency and to explore clean and sustainable renewable energy sources [1,2]. Wind, solar and other alternative energy sources are being explored and rapidly developed. Wind power is considered as one of the renewable energy sources with a great development potential in the 21st century. However, the high-level penetration of wind power generation in the grid causes serious problems of power grid stability and reliability due to the intermittence and volatility of wind power. Suitable solutions are urgently needed and energy storage has been recognized as one of the most promising technologies for addressing the problems [3,4].

Energy storage, especially PHS, has a long history of being used for grid dispatching and peak shaving. Coal and gas reserves were historically considered as the major storage forms for flexible dispatch of energy. As technology developed, various feasible energy storage technological solutions have emerged on the market. At the ENERGY STORAGE CHINA 2016 conference, the China Energy

Storage Alliance reported that China had 118 energy storage projects in operation (employing Li-ion, lead-acid and flow batteries, and excluding PHS, CAES and thermal energy storage). This represents 105.5 MW of installed capacity with a 110% (2010–2015) annual growth rate, meaning a predicated capacity of up to 24.2 GW (excluding PHS) and 40 GW (including PHS) by 2020 [5].

Energy storage can be organized into several categories based on the nature of its operation and storage medium used: primary fuel (such as coal, oil storage, etc.), intermediate fuel (such as gas, hydrogen, etc.), electrical energy storage and other forms [1]. The recent status of electrical energy storage technologies is presented in the Table 1 [6–10], and the cost of different energy storage technologies is shown in Figure 1 [6–11], including the capital energy cost pitted against capital power cost.

Table 1. Technical characteristics of electrical energy technologies [6–10].

Technology	Energy Density (Wh/L)	Power Rating (MW)	Suitable Storage Duration	Lifetime (years)	Discharge Time	Cycling Times (cycles)	Maturity
PHS	0.5–2	30–5000	H-Mon	40–60	1–24 H+	10,000–30,000	Mature
Flywheel	20–80	0.1–20	Sec-Min	15–20	Sec-15 Min	20,000	Early Com
CAES	2–6	≥300	H-Mon	20–40	1–24 H+	8000–12,000	Early Com
Capacitor	2–6	0–0.05	Sec-H	1–10	Millis-1 H	50,000+	Com
SMES	0.2–6	0.1–10	Millis-H	20–30	≥30 Min	10,000+	Demo/Early Com
TES	80–500	0.1–300	Min-Days	5–30	1–24 H+	-	Demo/Early Com
Solar fuel	500–10,000	0–10	H-Mon	-	1–24 H+	-	Developing
Hydrogen fuel cell	500–3000	0–50	H-mon	5–20	Sec-24 H+	1000+	Developing/Demo
Li-ion	150–500	0–100	Min-Days	5–15	Min-H	1000–10,000	Demo
Lead-acid	50–90	0–40	Min-Days	5–15	Sec-H	500–10,000	Mature

Abbreviations: SMES, Superconducting magnetic energy storage; TES, Thermal energy storage.

In more detail, a meticulous comparative life cycle cost (LCC) analysis of electricity storage systems was provided by Zakeri and Syri, and the LCC of a CAES plant is highly dependent on fuel costs, emissions costs, and charging electricity prices [11]. Comparing the investment cost, capacity, lifetime, energy density and storage duration, PHS and CAES are suitable for use in large-scale commercial applications where they are more economic [6–12].

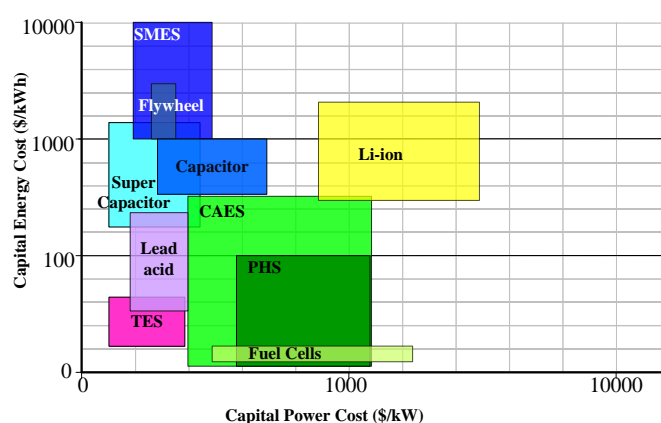

Figure 1. Capital energy cost vs. capital power cost [6–10].

PHS, as shown in Figure 2, is one of the most widely-used energy storage technologies, which has demonstrated its merits in terms of technological maturity, high cycle efficiency, large rated power, long service life and low operating cost, but the location choices are highly restricted, construction cycles are long, maintenance costs are high and it impacts the local environment, so the further utilization of PHS is limited [13–15]. In addition to PHS, CAES is another feasible way to realize large-scale power

storage. Since 1949 when Stal Laval proposed to store compressed air using underground caverns, the research in CAES has been progressing [16]. Compared with PHS, CAES has relatively low impact on the environment and the cost of building a CAES plant is similar to the cost of PHS [4,15–19]. While PHS development has slowed down (or increased in difficulty), CAES has the potential to be an equivalent technology with its distinguishing advantages allowing it to take the place of PHS. Therefore, the article concentrates on the technology development and future trend in CAES.

2. Description of CAES Technologies

CAES refers to the energy stored in the form of high pressure compressed air and consumed in a different form of energy converted from the compressed air. In supporting power network operation, compressed air energy storage works by compressing air to high pressure using compressors during the periods of low electric energy demand and then the stored compressed air is released to drive an expander for electricity generation to meet high load demand during the peak time periods, as illustrated in Figure 3.

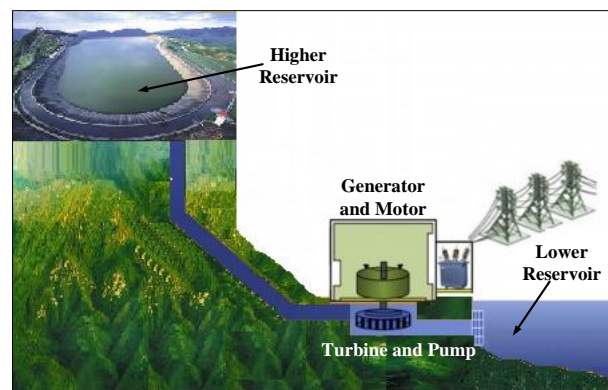

Figure 2. Pumped hydroelectric storage.

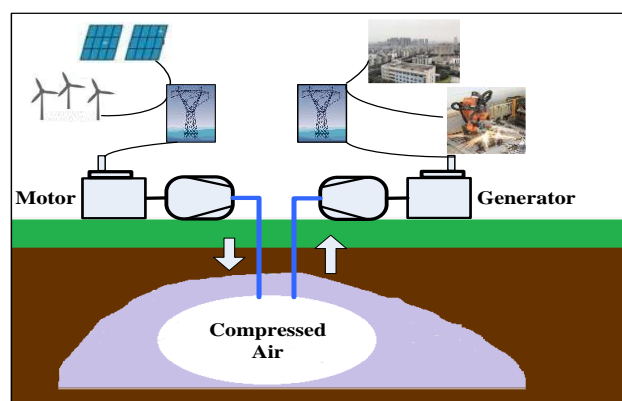

Figure 3. Illustration of a compressed air energy storage process.

CAES technology is based on the principle of traditional gas turbine plants. As shown in Figure 4, a gas turbine plant, using air and gas as the working medium, mainly consists of three sections: gas turbine, compressor and combustor. Gas with high temperature and high pressure, which is formed by mixing compressed air and fuel in the combustion chamber, drives the turbine which in turn drives a generator to generate electricity [20,21]. For a CAES plant, as shown in Figure 5, there are two different stages of operation, namely compression and expansion. Since the two stages do not run simultaneously, there is higher system efficiency (48–54%) than in traditional gas turbine systems. At present, two large scale commercial CAES plants involving gas fires are in operation. The first CAES plant was installed

and commissioned for operation in Huntorf, in 1978 [19]. It has a rated generation capacity of 290 MW for providing load following service and meeting the peak demand while maintaining the constant capacity factor of a nuclear power plant. In 1991, the second large-scale CAES plant commenced operation in McIntosh [19]. This plant has a generation capacity of 110 MW, with a storage capacity of 2700 MWh, and is capable of continuously delivering its full power output for up to 26 h.

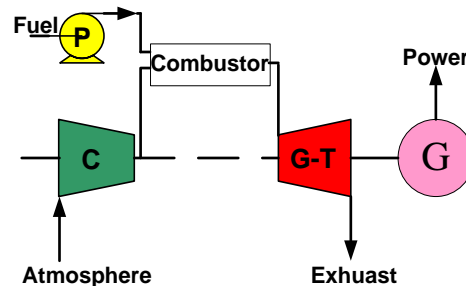

Figure 4. Schematic diagram of gas turbine plant (C—Compressor, G-T—Gas turbine, G—Generator, P—Pump, R—Reservoir).

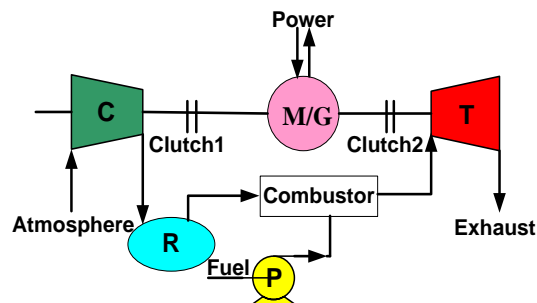

Figure 5. Schematic diagram of CAES system (C—Compressor, G-T—Gas turbine, M/G—Motor/Generator, P—Pump, R—Reservoir).

A whole CAES system has the following primary components: (1) compressors; (2) expanders; (3) air reservoirs; (4) combustor; (5) motor/generator; (6) controlling system; (7) other auxiliary equipment, such as fuel tanks, pipe connection and so on. Compressors, expanders and air reservoirs play decisive roles in the whole CAES system formulation, and the descriptions of each are presented below.

(1) Compressors and Expanders

Compressors and expanders are designed, or selected, according to the applications and the designed storage pressure of the air. The pressure of air in a vehicle cylinder can reach 30 MPa of storage pressure for higher energy storage density in a limited volume, so multi-stage reciprocating compressors are normally adopted. The pressure used for a large scale CAES system is about 8 MPa, for which multi-stage compressors are used, and normally combined axial flow compressors and centrifugal compressors are selected [22,23]. Similarly, the steam turbines in Huntorf are used for the first-level expansion from 4.6 MPa to 1.1 MPa; and gas turbines are utilized for the second-level expansion from 1.1 MPa to atmospheric pressure, in which the working medium is flue gas generated from the combustion of the air and fuel.

(2) Air Reservoirs

Large volume air reservoirs are required for large scale CAES systems, so fabricating large storage containers is a key factor. This is why the current operational CAES plants use underground caverns for storage, in particular, salt caverns. From recent research, suitable geological formations

include underground salt layers, underground hard rock layers, and underground porous rock layers. In Table 2, the capital cost of an air reservoir for various storage media and plant configurations are listed [10]. The cost is related to the types of storage (containers/caverns), power rating and the duration of storage. Therefore, in Table 2, the cost of power related components such as turbine, expander etc. is listed as \$/unit power and the cost of storage components such as underground caverns and over ground cylinders is related to their capacity and listed as \$/unit energy stored. At present, the two commercial CAES plants both adopt underground salt caverns as air storage reservoirs, with storage capacities of 310,000 m³ (Huntorf) and 560,000 m³ (McIntosh), respectively. In the formation and maintenance of salt caverns, some challenges are presented such as rat holes, the damage caused by small animals, the treatment of salt water, etc. [24,25].

Table 2. Various storage media and plant configurations of air storage reservoir [9].

Reservoir	Size (MWe)	CPRC (\$/kW)	CESC (\$/kWh)	ST (h)	TC (\$/kWe)
Salt	200	350	1	10	360
Porous media	200	350	0.1	10	351
Hard rock	200	350	30	10	650
Surface piping	20	350	30	3	440

Abbreviations: CPRC, Cost for Power-Related Plant Components; CESC, Cost for the Energy Storage Components; ST, “Typical” hours of Storage for a Plant; TC, Total Cost.

The operation modes of an air reservoir are divided into sliding-pressure operation and constant-pressure operation.

- Sliding-pressure operation with a constant volume: the rising pressure leads to a change of the pressure ratio of the compressors causing an increase in irreversible losses. Also, at the end of the discharge, there will be remnant air, which will reduce the efficiency of the whole system.
- Constant-pressure operation at the charging and discharging stages: the compressors and expanders can keep the high efficiency under the rated conditions [26].

3. The Current Development of CAES Technologies

The motivation for developing CAES technology is to achieve energy sustainability and to reduce emissions, so current technology development aims to avoid using fossil fuel in CAES systems. Table 3 presents the comparison of various CAES technologies currently under development, which optimize the thermal process and integrate CAES with other subsystems to improve their efficiency [10].

Table 3. Comparison of various CAES technologies [10].

Technology	Energy Density (Wh/L)	Power Rating (MW)	Storage Duration	Lifetime (Years)	Discharge Time	Cycling Times (Cycles)
Large CAES	2–6	110 & 290	Hours-months	20–40	1–24+ h	8000–12,000
AA-CAES	2–6	110 & 290	Hours-months	20–40	1–24+ h	-
LAES	8–24	0.3 & 2.5	-	20–40	1–12+ h	-
SC-CAES	8–24	110 & 290	Hours-months	20–40	1–24+ h	-
Small CAES	2–6	0.003 & 3	Hours-months	23+	Up to ~hour	Test 30,000

Abbreviations: AA-CAES, Advanced Adiabatic Compressed Air Energy Storage; LAES, Liquid Air Energy Storage; SC-CAES, Supercritical Compressed Air Energy Storage; Cycling times—number of cycles.

3.1. Advanced Adiabatic Compressed Air Energy Storage (AA-CAES)

In a traditional CAES system, a large amount of heat generated during the compression process is discharged through radiators or coolers directly to the atmosphere. During the expansion stages, a lot of heat is required to boost the power, which is sourced from fossil fuel combustion (or other heat sources) to increase the air temperature inside the expanders to improve the power capability.

Therefore, the utilization of the compression heat can avoid using, or reduce fossil fuel use and improve the efficiency of the whole cycle [27,28]. For an AA-CAES with thermal storage integration, heat released from compression stages can be stored in adiabatic containers and reused during the expansion stages. The typical working principle of AA-CAES is illustrated in Figure 6, from which it can be seen that the thermal storage is in use before the air enters the air reservoir.

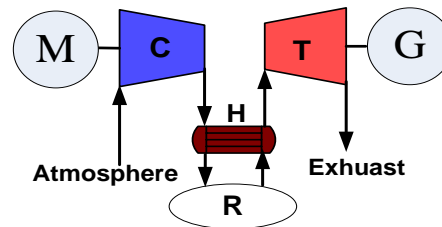

Figure 6. Schematic diagram of AA-CAES system (C—Compressor, T—Turbine, G—Generator, M—Motor, R—Reservoir, H—Thermal storage).

Yang et al., pointed out that the fewer the compression stages that are used with the same expansion pressure, the larger the system output power will be; and the more expansion stages that are used with the same compression pressure, the more the output power of the air unit mass will be, so two-stage compression and three-stage expansion are chosen for the CAES systems under a fixed total pressure ratio [29,30]. Zhao et al., designed a dynamic model of the hybrid energy storage with wind, which combined AA-CAES and a flywheel energy storage system (FESS), and the simulation results showed that the power output could meet the load demand [31].

Compared with the traditional CAES, there are added heat exchanger units and storage units, which are the key parts of AA-CAES. Luo et al. built an AA-CAES model with a low-temperature thermal storage system (Figure 7), and the parameters of the whole system were optimized by simulation study [32]. From the study of Liu et al., it is shown that the exhaust temperature is still too high from the AA-CAES low pressure turbine, causing a lot of waste, and an approach was proposed for improvement of exergy efficiency of AA-CAES systems [33].

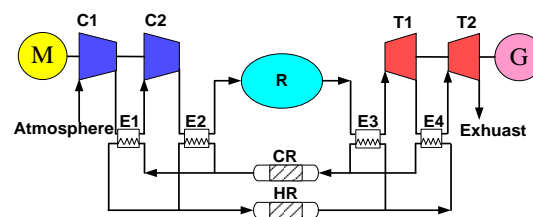

Figure 7. Schematic diagram of AA-CAES system with a low-temperature thermal storage (C—Compressor, T—Turbine, G—Generator, M—Motor, R—Reservoir, HR—Thermal storage, CR—Low-temperature thermal storage, E—Heat Exchanger) [32].

As shown in Figure 8, Barbour et al., proposed to use packed bed (PCB) heat exchangers instead of indirect heat exchangers in the AA-CAES system, and the whole cycle thermal efficiency was claimed up to be 70% with the energy stored and utilized by the cascades structure [34]. Sciacovelli et al., designed a dynamic model of the AA-CAES with PCB thermal energy storage, and then studied the transient characteristics of the thermal energy storage stages, caves, compression and expansion stages and integrated system. The results showed that the whole efficiency of the system reached 70%, when thermal efficiency of the reservoir reached 95% [35]. Tessier et al., designed a new type AA-CAES with cascades of phase change materials (PCMs), and the melting temperature and enthalpy of the PCMs were optimized for the entire system to improve efficiency and 85% efficiency is shown by the simulation results [36].

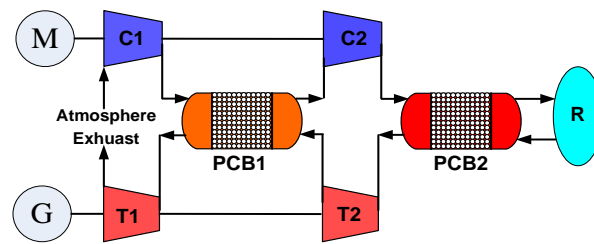

Figure 8. Schematic diagram of AA-CAES system with PCB units (C—Compressor, T—Turbine, G—Generator, M—Motor, R—Reservoir) [34].

3.2. Liquid Air Energy Storage (LAES)

LAES can be considered as one type of CAES system which aims to increase the energy storage density. As shown in Figure 9, there are two stages of the cycle operation: the charging stage (the air with a certain pressure from compressors was liquefied and then stored in low-temperature storage tanks) and the discharge stage (the liquefied air becomes high pressure air with high temperature in the expanders to drive motors) [37].

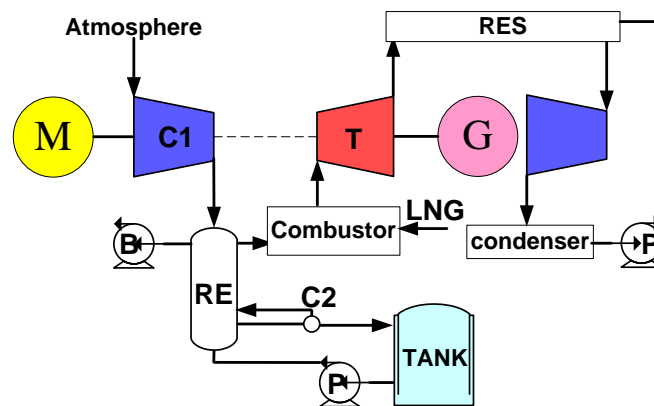

Figure 9. Schematic diagram of LAES system (B—Blower, C—Compressor, T—Turbine, G—Generator, M—Motor, P—Pump, RE—Heat regenerator, RES—Waste heat generator) [37].

Liu et al., introduced a new liquid air energy storage technology [38], and the structure designs of wind/LAES systems were discussed for applications in the field of wind power. It is considered a promising way of solving the problems of the intermittence of wind power or other types of renewable energy integration in the power grid. Chino et al., modified LAES on the basis of the original gas turbine plant format. From the calculation and analysis results, it is found that the energy storage efficiency may go up to 73%, when the inlet temperature of throttling-expansion valve is higher than the temperature of liquid air at 20 K, which is of great significance for the follow-up studies [39]. Morgan et al., analyzed that the theoretical round trip efficiency is between about 40–80%, and the round-trip efficiency is only 8% on the pilot test plant designed by Highview Power Storage. The reason for the low measured efficiency is that the air liquefier is smaller than the commercial scale air liquefier and only 51% of an available cold thermal energy was recycled [40,41]. Kantharaj et al., made full use of CAES and LAES, where LAES was used to supplement the CAES system, and highlighted the economic benefits of the hybrid system in charging and discharging time span or under limited geographical positions [42,43]. Ameel et al., studied a more complex combined cycle according to the thermodynamics of the basic cycle, and found that taking real expander efficiency reduction into account considerably reduced the actual output, unless isothermal expansion could be well approached [44].

3.3. Supercritical Compressed Air Energy Storage (SC-CAES)

The SC-CAES system is a new type of CAES system which integrates the advantages of both AA-CAES and LAES: environmental protection, high energy density and high thermal efficiency. Figure 10 shows a typical SC-CAES system. The air is compressed to reach to its supercritical state ($p > 37.9$ bar, $T > 132$ k); and then the supercritical compressed air is stored in tanks after a heat exchanger collects the compression heat; the liquid air becomes its gas state and generates power after being pumped to supercritical pressure and heated by the heat exchangers [37].

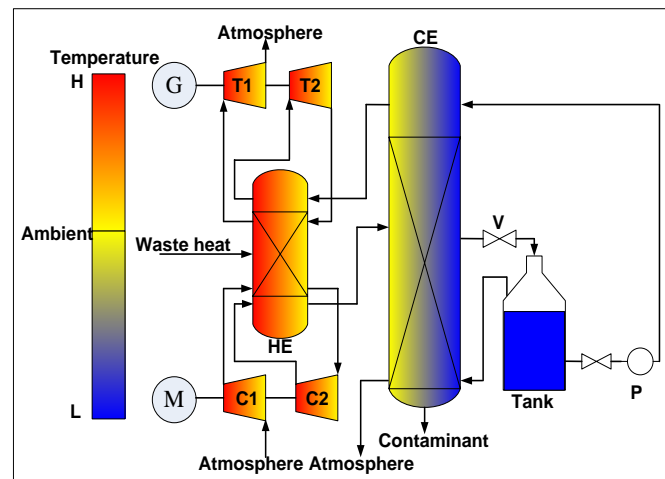

Figure 10. Schematic diagram of SC-CAES system (V—Throttle valve, C—Compressor, T—Turbine, G—Generator, M—Motor, P—Pump, HE—Heat storage & Exchanger, CE—Cold storage & Exchanger) [37].

There are two ways to perform liquefaction: throttle liquefaction valve and liquefied expander. The cooled effect of air is used by the throttle valve to obtain liquid air in the throttling process, in which the temperature is reduced. Because it is a kind of typical irreversible process, it will not only consume large amounts of energy, but also cause cavitation. The liquid expander is used to replace the throttle valve to achieve the throttling depressurization effect [37].

In order to understand and improve the SC-CAES system, Guo et al., built a thermodynamic model. The basic simulation parameters, which are derived from practical cases in the industry, are shown in Table 4. From the study, it is found that the energy densities ($3.2581\text{--}3.4602 \times 10^5$ KJ/m³) could be 18 times higher than that of conventional CAES, and the round-trip efficiency could reach 67.41% [45].

Table 4. Basic simulation parameters [45].

Parameter	Parameter Value
Total power output of four expanders (MW)	10
Energy releasing time (h)	1
Energy storage pressure (bar)	100
Energy releasing pressure (bar)	57.9 (V-SC-CAES)/78.5 (LE-SC-CAES)
Isentropic efficiency of compressor (%)	85
Isentropic efficiency of expander (%)	88
Isentropic efficiency of cryopump (%)	84
Isentropic efficiency of liquid expander (%)	78
Temperature difference of intercooler and reheater (K)	2
Pressure loss of each intercooler (bar)	0.2
Pressure loss of each reheater (bar)	0.2
Minimum temperature difference inside cold storage/heat exchanger (MTD _{CS/HE}) (K)	3

Abbreviations: V-SC-CAES, SC-CAES with throttle valve; LE-SC-CAES, SC-CAES with liquefied expander.

4. Applications of CAES

Recently, the application prospects and the potential of CAES in supporting power system operation have become widely recognized. It is predicted that CAES will play an increasingly important role in the energy management of the time of separation between generation and the usage of power. The potential applications of CAES are generally considered twofold: suppliers and consumers (behind the meter). For the power supply side, the transmission and distribution network operators can use CAES for bulk energy rescheduling for maintaining the load balance. "Behind the meter" refers to the consumer side, that is, the users can use CAES to regulate the electricity usage taken from the suppliers based on the energy price to minimize their energy bill. The potential applications of CAES are explained below.

(1) Peak Shaving and Demand Side Management

For electric power enterprises, peak shaving means the process of storing energy during off-peak periods and compensating electrical power generation shortfalls during the periods of high demand. In the different price tariff periods associated to the peak and off-peak durations, users can use CAES to manage the demand side energy by storing energy at the lower price and releasing the stored electrical energy during the periods of higher electricity price. In this way, the consumers can reduce their electricity costs. Considering the durations of long and medium term storage, Wang et al., established a demand response dynamic analysis model, which can help the owners of CAES design a target incentive mechanism that can attract the support at the project development early stage and also estimate the potential operation revenue generation [46]. Li et al., established an optimal time-of-use pricing response model, which can improve the load curve and obtain better resolution for load shifting effectively which is verified by many tests [47].

(2) Integration of More Renewable Power Generation Plants

CAES can support the seamless integration of renewable power generation plants into the existing power network to realize the goal of stable power grids, which can help solve the problems of the inherent intermittence and instability of renewable power generation [48]. In the micro-grid concept, CAES can rapidly suppress the micro-grid power fluctuations and improve power supply quality, which is important for the reliable operation of micro-grids [49,50]. Tang et al., established a simulation and experimental platform, including energy storage, photovoltaic, asynchronous wind turbines and typical load in micro-grids. The results from their study showed that effective control of energy storage could help micro-grids maintain good voltage and frequency stability during the switching process patterns of off-grid/grid pattern [51].

(3) Applications to Smart-Grids and Wind Energy Network

Smart-grids, as the future direction and trend of the electric power industry, aim to achieve energy management in both directions, that is, from both supply and consumption with the support of internet and big data technology [52,53]. Traditionally, consumers have passively accepted the electricity supplied to them so it is a direction of supply and consumption relationship; however, smart-grids will transform this structure by involving the active selection of supply, integration of local generation and dispatching energy storage sources. Rifkin, a famous American economist, believed that energy internet would be the core in the third industrial revolution, which will have a great influence on the development of society [54]. The energy internet is called smart-grid V2.0 by Li, et al., and energy storage is considered as the key enabling technologies of energy conversions and integrated applications [2].

(4) Applications to Compressed Air Engines

The compressed air energy can be converted into other forms of mechanical energy through compressed air engines, which are mainly used in air-powered vehicles [55,56]. Chen et al., conducted

a detailed review on the research and development of air-powered vehicles and pointed out that the current work should be focused on the principle and the structure optimization of air-powered automobile engines, the distribution forms and the control technology for reducing pressure [55].

(5) Applications in Other Fields

In the case of power supply system failure, CAES systems can be used as a back-up power or uninterrupted power supply (UPS), which can supply adequate power to important users, such as banks, data processing centers, hospitals and other important sectors [6,19]. CAES systems could provide the capacity of black-start in a power shutdown condition. For example, the Huntorf plant offers black-start power to the nuclear units located near the North Sea [57].

5. Current CAES Projects

With a wide search on current reports about CAES projects, this section provides updated information in this area. A detailed comparison of the key operation parameters between the Huntorf and McIntoch CAES plants is listed in Table 5 [10,19,58]. These are two CAES power plants currently in commercial operation. The common feature of these two power plants is the requirement for fossil fuel (natural gas), which is not desirable for the current clean energy agenda. Low energy conversion efficiency is another key factor heavily criticized. All the current projects and researchers are attempting to avoid using fossil fuel and improve energy efficiency.

Table 5. Information data about the commercial CAES facilities [10,19,58].

Location	Manufacturer	Year of Operation	Power Rating (MW)	Charge Time/Discharge Time (h)	Air Pressure (bars)	Heat Sources	Efficiency
Huntorf. Germany	Browne Boveri	1978	290	8/2	46-66	Natural Gas	42%
McIntosh. USA	Dresser-Rand	1991	110	40/46	45-74	Natural Gas	54%

5.1. Demonstration Projects

Demonstration projects are one of key steps in the development of CAES plants and this subsection gives an overview of some built and on-going demonstration projects and facilities. Highview Power Storage started developing a LAES nearly 10 years ago and the company has mastered many key technologies in this particular area. The first 350 KW/2.5 MWh LAES pilot plant with packed bed cold and thermal storage has demonstrated its value by connection with the local distribution network as shown in Figure 11. The demonstration plant has now been transferred to the University of Birmingham in the UK to form a living laboratory for research and education purposes. It will also be used to develop innovative designs, such as thermal storage, with the potential to overcome the undiscovered drawbacks for the next generation of LAES. From the demonstration project, the theoretical performance and detailed cycle analysis was conducted using a classical analysis method by Morgan et al. [40,41]. As predicted, it is found that the thermal storage played a core role in improving the system efficiency, the links between the component characteristics and the system performance were elucidated by Sciacovelli, et al. [59].



Figure 11. 350 KW/2.5 MWh LAES pilot plant at Birmingham [59].

A multi-stage regenerative 500 KW demonstration system, named TICC-500 (Figure 12), was designed jointly by Tsinghua University, Institute of Physics and Chemistry, Chinese Academy of Science and China Electric Power Research Institute and is the first such kind of facility in China. The system, which could achieve a maximum system efficiency of 33.3%, passed the various load tests and its interconnection with power grid occurred in 2014. Through the study of the demonstration system, Mei et al., revealed the conversion mechanism of energy in various air forms, and designed the protection, control systems and cooperative self-control center for achieving the security and reliability of the power system [58].



Figure 12. TICC-500 pilot plant [58].

Figure 13 show a 1.5 MW SC-CAES demonstration project from 2013 which was designed by Macaoenergy (Bijie) Industrial Park Development Co. Ltd and Institute of Engineering Thermophysics of the Chinese Academy of Sciences. All the performance indexes have reached or exceeded the designed targets. At present, the 1.5 MW SC-CAES system has been running for more than 3000 h successfully and the system efficiency is about 55%. With the experience gained from this demonstration project, in September 2016, the first 10 MW AA-CAES project has been assembled as shown in Figure 14 and the system operation is scheduled for testing at the beginning of the 2017 [60].



Figure 13. 1.5 MW SC-CAES pilot plant in China [60].



Figure 14. 10 MW AA-CAES pilot plant in China [60].

5.2. Projects under Preparation and Construction

As described above, CAES is expected to play an important role in the future electric power system operation, so a number of projects around the world are planned or in construction. In Germany, as shown in Figure 15, the world's first large-scale AA-CAES project—ADELE—with 70% cycle efficiency has been designed by RWE Power, General Electric and other partners. The aim of this project is to optimize the co-existence and smooth interaction of the individual energy sources, especially for wind power. It is planned to have 1 GWh storage capacity and be capable of generating up to 200 MW, said the RWE power. The ADELE project could provide backup capacity within a very short time and replace forty state-of-the-art wind turbines for a period of 5 h. The project is now on hold due to uncertain business conditions [61].

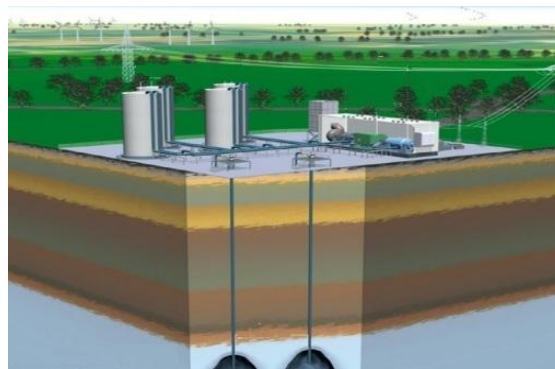

Figure 15. Visualization of the ADELE storage plant [61].

In America, Ridge Energy Storage has proposed a CAES system in Matagorda, Texas. The economic and technical feasibility of the wind/CAES system has been studied by Fertig and Apt, using wind power data, electricity prices hourly, and natural gas prices monthly [62]. Extensive research was conducted for profit analysis through incorporating a multiparameter vector of the integrated CAES system with wind power, such as the size, transmission capacity, and dispatch strategy and the results are very positive [62]. Park and Baldick also investigated the long-term impacts of CAES operation through a 4-week optimal operation model of the CAES with wind farms, and then a mixed integer programming (MIP) formulation for the simulation of integrating CAES in the transmission system to increase wind power production, satisfying 20% renewable portfolio standard target [63]. Liu et al., found CAES systems financially attractive in its development for integrating a large share of wind power after the use of nodal pricing [64]. However, the project stopped as it is found that the underground geological condition does not satisfy the requirement of compressed air storage, although big spending has incurred. This provides an example for the importance of geological survey for a suitability study of underground storage.

In China, there is a 100 MW SC-CAES project planned to be in operation before 2020, which is designed by Institute of Engineering Thermophysics, Chinese Academy of Sciences and its partners [63]. There is another 50 MW AA-CAES project underway in Jiansu, China, in 2017, which is certified by the consulting panel. In this 50 MW AA-CAES system, underground salt caverns are adopted as the air reservoirs [65]. The final objective is to build 100 MW AA-CAES informed by the learnings from the 50 MW system.

In 2015, Hydrostor has planned a pilot project for the World's First Offshore Compressed-Air Energy Storage Project in Toronto (Canada) [66]. It would be the first test of an underwater compressed-air energy storage system. The project uses drilling techniques that reduce the demand for boats and cranes at the surface to deploy the pipes and storage balloons.

On land, electricity runs a compressor to produce the compressed air. During that process, waste heat is captured and could be used to increase the round-trip efficiency from about 60 percent to as

high as 80 percent. The compressed air is pressurized to match the pressure at the ocean floor where the balloons are located. The air is then pumped down to fill those balloons. It is predicted that the cost for such a technique is lower than many other techniques for CAES.

The Bonneville Power Administration has teamed with the Pacific Northwest National Laboratory and a full complement of industrial and utility partners to conduct a study to evaluate the technical and economic feasibility of developing CAES in the unique geologic setting of the islands of Washington and Oregon from 2013 [67]. The project team extended analysis of the traditional CAES storage in salt caverns to much more prevalent underground porous and permeable rock structures. The study found that Eastern Washington and Oregon are rich with potentially suitable sites for CAES. A conventional CAES plant was designed and analyzed for a first site located at Columbia Hills. The plant design offers the power rates of 231 MW for storage and 207 MW for generation and the storage capacity can provide over 400-h electricity from the local storage capacity. Also, a new type of no-fuel hybrid geothermal CAES plant was designed for a site located near Yakima Canyon north of Selah (Yakima Minerals). The future will depend on favorable market conditions and the energy policy.

Gaelectric, partnered with Dresser-Rand is to build a CAES plant to generate 330 MW of power for up to 6 h in the area of Antrim (North Ireland, UK) [68]. The project is called “CAES Lame” and plans to create two salt caverns for compressed air storage at the depth of greater than 1400 m underground. The salt source was confirmed in November 2013 and the project has been through seven stages of public consultation. The planning application and Environment Impact Assessment (EIA) were submitted to the government Strategic Planning Division in December 2015 and is still waiting for the local authority’s decision. If the CAES Lame is built, it will be capable of providing a range of services and support to power network operation and management.

6. Future Development of CAES Technology

CAES has demonstrated its unique merits and advantages but it has also shown its weakness in terms of low round trip efficiency and lower energy density. The future technology development is currently focusing on improving its efficiency. Such technology developments are presented here.

6.1. Optimal Design of Turbo Machinery

Innovations and breakthroughs are important in the technologies concerned with high-pressure compressors and turbines, which are the core components in the whole CAES systems. Due to the higher operation pressure than those used in gas turbine plants, the internal leakage and energy losses are the key factors in reducing the efficiency and as such are seriously addressed future development research.

(1) Compressors

Although the manufacturing technology of compressors is relatively mature, the coupling relationship and the control strategy with air receivers can improve the system efficiency further. Corvaro and his team studied the procedures, which integrated the reliability, availability and maintainability (RAM) into manufacturing reciprocating compressors API 618. The ultimate aim of the procedure is devoted to on-site measurement and real data acquisition under working conditions [69]. The heat transfer enhancement is also an advanced research focus. As shown in Figure 16, Zhang et al., employed the “open accumulator” in a fluid power wind turbine system. To achieve the efficient compression and expansion under near-isothermal conditions, the team inserted porous media in the compressor’s chamber, such as foams and interrupted-plate inserts. The computational results confirmed that inserts were very effective in suppressing temperature rises during compression [70].

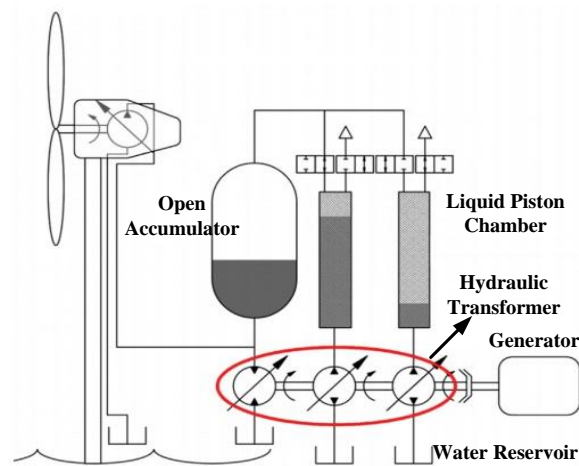

Figure 16. Schematic of CAES system for offshore wind energy storage and generation [70].

(2) Turbines/Expanders

Table 6 presents a review of expanders. Expanders, in general, can be categorized in two types: velocity type, such as axial turbine expanders; and volume type, such as screw expanders, scroll expanders, and reciprocal piston expanders [71].

Table 6. Information data about the turbines [69].

Type	Rotate Speed (rpm)	Cost	Advantages	Disadvantages
Radial-inflow turbine	8000–80000	High	Light weight, mature manufacturability and high efficiency	High cost, low efficiency in off-design conditions and cannot bear two-phase
Scroll expander	<6000	Low	High efficiency, simple manufacture, light weight, low rotate speed and tolerable two-phase	Low capacity, lubrication and modification requirement
Screw expander	<6000	Medium	Tolerable two-phase, low rotate speed and high efficiency in off-design conditions	Lubrication requirement, difficult manufacture and seal
Reciprocating piston expander	-	Medium	High pressure ratio, mature manufacturability, adaptable in variable working condition and tolerable two-phase	Many movement parts, heavy weight, have valves and torque impulse
Rotary vane expander	<6000	Low	Tolerable two-phase, torque stable, simple structure, low cost and noise	Lubrication requirement and low capacity

Xue adopted a single valve piston expander and formulated the mathematical models for different projects of miniature CAES with the assumption of 14.8 MPa of storage pressure which are reported in the literature. The best project of the miniature CAES systems can be obtained: when the pressure of inlet air is lower than the rated pressure, it will be injected into the expander until the indicated work less than the friction power of single piston cylinder [72]. Wang has conducted comprehensive research on scroll expanders, including scroll formation, chamber volumes and output torque calculations, and the energy conversion efficiency of scroll expanders was analyzed and showed high energy efficiency on the basis of complete dynamic mathematical model [73,74].

(3) Rotors

During the expansion process, the rotating speed of a turbine is high, so the stability of the rotor is crucial. For example, when the frequency of the turbine is designed near to the first order critical speed and the second order critical speed, there will be strong vibration and noise, even leading to the instability of the high-speed rotor and the damage of the rotor bearing systems.

A multi-axis coupling and high-speed rotor dynamic test platform was designed and built in 2017, by Chinese Academy of Sciences Institute of Engineering Thermophysics. It consists of a power system, lubrication system, control system, vibration system and other miscellaneous parts, and the transmission ratio could be up to 30 and the highest rotational speed could be up to 45,000 r/min (Figure 17). Through the platform, experiments of multi-rotors structure dynamics of large scale CAES and multi-axis high-speed machines can be carried out [75].



Figure 17. Multi-axis coupling and high-speed rotor dynamic test platform [75].

6.2. Thermal Storage and Cold Storage

Applications of Thermal Energy Storage (TES) have been found in the building industry, the automotive industry and solar energy installation. Recently, more applications are being explored, such as integration of TES with CAES, recycling industrial waste heat, and emissions reduction via replacing non-renewable energy. Generally, TES could be considered to have two kinds, that is, heat energy storage (HES) and cold energy storage (CES) [76]. TES includes the sensible heat storage and the latent heat storage: the sensible heat storage (SHS) uses the heat capacity of the materials for storage/release of heat; the latent heat storage (LHS) uses phase change materials (PCM) to achieve heat storage/release heat.

Compared with the SHS, there are many advantages of LHS, such as high-heat storage capacity, constant heat source at the phase-changing temperature point, and the reversible phase-changing process for repeated uses [76–79]. Reference [76] concludes that the choice of storage material depends on the desired temperature range, applications of the thermal storage unit and the size of thermal storage system. As shown in Table 7, there are three kinds of phase change materials that could meet the high-temperature requirements: organic, molten salts, and alloys [77]. PCMs for cold thermal energy storage (less than 20 °C) applications are reviewed in [79] and the results are listed in Table 8. The composites are also reported in many publications and applications [80,81]. Li et al., has researched the heat transfer behavior of thermal energy storage components using composite phase change materials, and established a mathematical model considering different material properties and geometrical designs, which showed a reasonably good agreement with the experimental data [81].

For sophisticated CAES systems, TES, as a subsystem for reusing the compression heat energy and the expansion cold energy to enhance the round-trip efficiency, is attractive for both research and industry. The research reports in this area have rapidly increased in recent years. For example, cold thermal energy

storage is considered to be a cornerstone role in LAES, and its impact on future commercial scale LAES plants is addressed by Sciacovelli, Vecchi and Ding through studying a 100 MW/300 MWh standalone LAES plant with SHS through the LAES pilot plant in the University of Birmingham [59].

Table 7. Thermophysical properties of organic, molten salts and alloys [77].

Material	Melting Point (°C)	Advantages	Disadvantages	Status of Development	Future
D-threitol	87	Large latent heat; Non-toxic; Non-flammable; Non-chemical corrosion	Low-thermal conductivity; Less thermal endurance	Commercial plant	Focusing on the Mannitol
Erythritol	118				
D-mannitol	167				
Pentaerythritol	188				
NaNO ₃	307	High-heat storage density; Low cost; Wide-temperature ranges	Low-thermal conductivity; High-volume expansion; High level-chemical corrosion	Pilot scale heat exchange study	Focusing on the Chloride and Carbonate
NaOH	318				
KNO ₃	337				
MgCl ₂	714				
NaCl	800				
NaCO ₃	858				
Zn-Al (96–4 wt %)	381	High-heat storage density;	High level- chemical corrosion; Non-toxic	Under development	Material development
Al-Cu (67–33 wt %)	548				
Al-Si (75–25 wt %)	557	High-thermal conductivity;	Low-volume expansion		
Al	660				
Cu-Si (80–20 wt %)	802				
Cu	1084				

Table 8. Thermophysical properties of materials for cold storage (melting temperature up to 20 °C) [79].

Material	Melting Point (°C)	Heat of Fusion (kJ/kg)	Density (kg/m ³)	Commercial Products
Organic	Dodecane	−9.6	216	-
	Triethylene glycol	−7	247	1200(l)
	Isopropyl palmitate	11	95–100	-
	Paraffin C ₁₆	16.7	237.31	-
Eutectic water-salt solution	24.8 wt % HCl	−86	−73.77(kJ/mol)	-
	24 wt % LiCl	−67	−36.26(kJ/mol)	-
	19.7 wt % KCl	−10.6	18.43(kJ/mol)	-
	4.03 wt % Na ₂ SO ₄	−1.2	−1.07(kJ/mol)	-
	H ₂ O	0	333	998(l)
		0	333	917(s)
Others	Tetradecane + octadecane	−4.02	227.52	-
	Mn(NO ₃) ₂ ·6H ₂ O + MgCl ₂ ·6H ₂ O	15–25	125.9	1738(l)
	Caprylic acid (Fatty acid)	16	148.5	981(l)
		16.3	149	

6.3. Integrated and Hybrid CAES Systems

(1) Integration of CAES with Renewable Energy

CAES systems can solve some problems effectively. As shown in Figure 18a,b, Xu and Chen presented a new coupling scheme with complementary wind and solar elements, which use the compression heat, exhaust waste heat, and solar energy instead of traditional gas heating, in order to improve the overall efficiency of the system [4]. Sun et al., built a new mathematical integration model of wind power and CAES systems, and indicated that the efficiency of the system could be up to 55% under a well-controlled operation condition [82]. Minutillo et al., accessed the optimal operating parameters of the integration system of AA-CAES and a photovoltaic power system in terms of average storage pressure and operating pressure range of the air tank [83]. Ghalelou et al., proposed a stochastic self-scheduling program of renewable energy sources (RESs) considering CAES based on a demand response mechanism. The incorporation of CAES and demand response program could help the decision maker to reduce the expected operation cost, which was verified by the optimization

models considering the market price, load, wind speed, temperature and irradiance [48]. A two stages optimization method is proposed in order to minimize the system operational costs including thermal power units operation cost, wind power and photovoltaic power curtailment cost and price-based demand response scheduling costs by Li et al. [84,85].

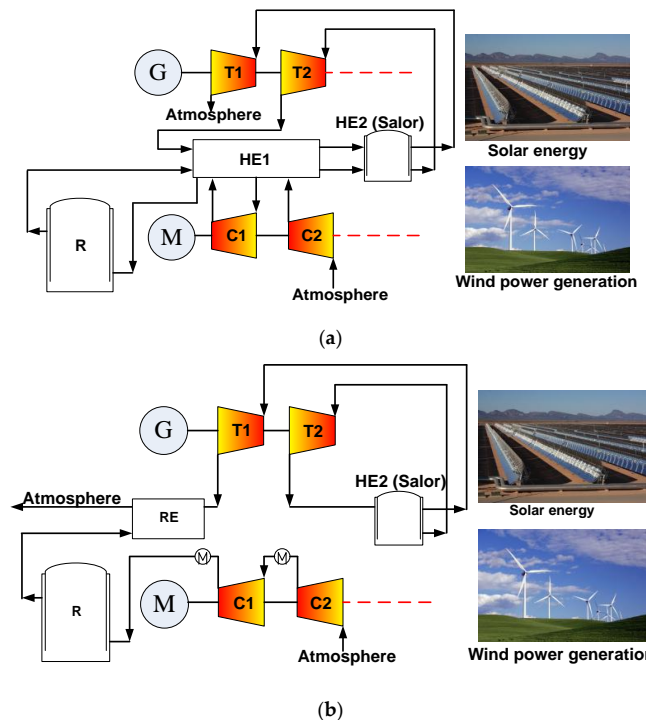

Figure 18. Schematic diagrams of CEAS with wind power generation and solar energy: (a) Reusing heat from compression; (b) Reusing waste heat from outlet of turbines (C—Compressor, T—Turbine, G—Generator, M—Motor, RE—Heat regenerator, HE—Heat storage & Exchanger) [4].

(2) Integration with Gas Turbine

When air pressure is within 1–2 MPa, compressed air and fuel are sprayed into the combustion chamber, and high temperature gas with high pressure drives the gas turbine which in turn drives the generator to generate electricity [26]. Bai et al., established a mode for coordinated control of micro grids with micro gas turbines and energy storage systems; the simulation results showed that the coordinated control model could guarantee seamless switching [86]. Amin designed a new system for domestic applications, in which a micro gas turbine, a CAES system and a solar dish collector are integrated. The new system could achieve higher exergy efficiency (up to 53.36%) than systems' efficiencies presented in available literatures [87]. Li et al., designed a set of CAES systems for remote areas integrated with off-grid diesel generating systems. There were three main parts in the system: a diesel engine, a piston compressor and an expander. The coupling system could not only meet the needs of energy transformation, but also generate more electricity because of the recovery of waste heat [88]. A zero-carbon-emission energy internet architecture to utilize power and heat in an integrated manner was proposed. A typical 1 MW non-supplementary fired CAES (NSF-CAES) hub was designed to show the effectiveness of the proposed NSF-CAES dispatch model in reducing operation cost, considering the pressure behaviors and temperature dynamics [89].

(3) Integration with Solid Oxide Fuel Cells (SOFCs)

The integration of SOFCs (to provide base-load power) and a CAES system (to follow peaking demand) with zero direct CO₂ emissions was proposed by Nease and Adams. It was found that the

integrated system could provide satisfying load-following capabilities with relatively small penalties to efficiencies and leveled electricity costs [90,91]. To solve the limitation of SOFC output and the finite of CAES storage capacity, a two-level rolling horizon optimization scheme was also presented by Nease, Monteiro and Adams [92].

(4) Integration with Other Systems

There are many complicated integrated CAES systems, such as fuel engine, refrigeration system, etc. in order to improve the overall system and energy conversion efficiency. The integrated system with the fuel engine mainly provides hybrid power for vehicles to improve their efficiency, which could also boost the output power of the vehicles simultaneously [93,94].

7. Conclusions

The paper explained the operation principles of CAES and provided comprehensive information on CAES technology development. The paper provided the essential and critical information for CAES plant planning, design, investment and building. The updated review of current CAES plants under planning and construction evidences the importance of CAES and demonstrated confidence for its future development. Compared with previously published overviews of CAES, this paper covers the most up-to-date materials and knowledge in CAES development, projects and efforts in recent years. The key technology development recommendation can shape the focus of industry and research. This should provide a foundation and valuable references for researchers and developers for the coming years.

Acknowledgments: The authors would like to thank to the research grant support from China National Basic Research Program 973 (2015CB251301) to enable the collaborative research between UK and China researchers. The authors also would like to give their thanks to EPSRC UK for funding support (EP/L019469/1) and Huazhong University of Science and Technology State Key Laboratory of Advanced Electromagnetic Engineering and Technology for open funding support (2017KF004).

Author Contributions: All authors contributed to this work in collaboration. Jidai Wang, Kunpeng Lu and Jihong Wang conducted a wide search of literature in compressed air energy storage and performed their analysis. All the authors contributed to the discussion, information collection and the manuscript preparation.

Conflicts of Interest: The authors declare no conflict of interest.

Abbreviations

AA-CAES	Advanced adiabatic compressed air energy storage
CAES	Compressed air energy storage
CES	Cold energy storage
CESS	Cost for the energy storage components
CPRC	Cost for power-related plant components
FESS	Flywheel energy storage system
HES	Heat energy storage
LAES	Liquid air energy storage
LCC	Life cycle cost
LE-SC-CAES	SC-CAES with liquefied expander
LHS	Latent heat storage
MIP	Mixed integer programming
NSF-CAES	Non-supplementary fired CAES
PCB	Packed bed
PCMs	Phase change materials
PHS	Pumped hydroelectric storage
SC-CAES	Supercritical compressed air energy storage
SHS	Sensible heat storage

SMES	Superconducting magnetic energy storage
SOFCs	Solid oxide fuel cells
ST	“Typical” hours of storage for a plant
TC	Total cost
TES	Thermal energy storage
V-SC-CAES	SC-CAES with throttle valve

References

1. Wang, S.; Lai, X.; Cheng, S. An analysis of prospects for application of large-scale energy technology in power systems. *Autom. Electr. Power Syst.* **2013**, *37*, 3–8. [CrossRef]
2. Li, J.; Tian, L.; Lai, X. Outlook of electrical energy storage technologies under energy internet background. *Autom. Electr. Power Syst.* **2015**, *39*, 15–25.
3. Xu, Y.; Chen, H.; Liu, J. Performance analysis on an integrated system of compressed air energy storage and electricity production with wind-solar complementary method under energy internet background. *Proc. CSEE* **2012**, *32*, 88–95.
4. Liu, C.; Xu, Y.; Hu, S.; Chen, H. Techno-economic analysis of compressed air energy storage power plant. *Energy Storage Sci. Technol.* **2015**, *4*, 158–168.
5. China Energy Storage Alliance Steering Committee. *Energy Storage White Paper 2016*; China Energy Storage Alliance: Beijing, China, 2016.
6. Luo, X.; Wang, J.; Ma, Z. Overview of energy storage technologies and their application prospects in Smart Grid. *Smart Grid* **2014**, *2*, 7–12.
7. Sameer, H.; Johannes, L. A review of large-scale electrical energy storage. *Int. J. Energy Storage* **2015**, *39*, 1179–1195.
8. Kousksou, T.; Bruel, P.; Jamil, A.; Rhafiki, T.; Zeraouli, Y. Energy storage: Applications and challenges. *Sol. Energy Mater. Sol. Cell.* **2014**, *120*, 59–80. [CrossRef]
9. Mahlia, T.M.I.; Saktisahdan, T.J.; Jannifar, A.; Hasan, M.H.; Matseelar, H.S.C. A review of available methods and development on energy storage; technology update. *Renew. Sustain. Energy Rev.* **2014**, *33*, 532–545. [CrossRef]
10. Venkataramani, G.; Parankusam, P.; Ramalingam, V.; Wang, J. A review on compressed air energy storage—A pathway for smart grid and polygeneration. *Renew. Sustain. Energy Rev.* **2016**, *62*, 895–907. [CrossRef]
11. Zakeri, B.; Syri, S. Electrical energy storage systems: A comparative life cycle cost analysis. *Renew. Sustain. Energy Rev.* **2015**, *42*, 569–596. [CrossRef]
12. Geng, X.; Zhu, Q.; Guo, H.; Duan, C.; Cui, H. Energy storage technology and application in Power system. *Smart Grid* **2016**, *4*, 54–59.
13. Pickard, W.F. The history, present state, and future prospects of underground pumped hydro for massive energy storage. *Proc. IEEE* **2012**, *100*, 473–483. [CrossRef]
14. Jan, O.; Kasper, P.; Benny, L.; Christian, V. A new principle for underground pumped hydroelectric storage. *J. Energy Storage* **2015**, *2*, 54–63.
15. U.S. Energy Information Administration. Available online: <https://www.eia.gov/todayinenergy/detail.php?id=6910> (accessed on 9 May 2017).
16. Ter-Gazarian, A.G. *Energy Storage for Power System*, 2nd ed.; The Institution of Engineering and Technology: London, UK, 2011; pp. 99–119.
17. Lu, Y.; Liu, G.; Ma, C.; Lv, P. Thermo-economic comparison of compressed air energy storage. *J. Eng. Ther. Energy Power* **2011**, *26*, 397–401.
18. Chen, H.; Cong, T.N.; Yang, W.; Tan, C.; Li, Y.; Ding, Y. Progress in electrical energy storage system: A critical review. *Prog. Nat. Sci.* **2009**, *19*, 291–312. [CrossRef]
19. Luo, X.; Wang, J.; Dooner, M.; Clarke, J. Overview of current development on electrical energy storage technologies and application potential in power system operation. *Appl. Energy* **2015**, *137*, 511–536. [CrossRef]
20. Wang, J.; Luo, X.; Dooner, M.; Clark, J. *Chapter 3 of Volume in the World Scientific Series on Current Energy Issues-Energy Storage*; World Scientific: Hackensack, NJ, USA, 2017.
21. Yao, E.; Wang, H.; Wang, L.; Xi, G.; Marechal, F. Thermal-economic optimization of a combined cooling, heating and power system based on small-scale compressed air energy storage. *Energy Convers. Manag.* **2016**, *118*, 377–386. [CrossRef]

22. Zhang, X.; Chen, H.; Liu, J.; Li, W.; Tan, C. Research process in compressed air energy storage system: A review. *Energy Storage Sci. Technol.* **2012**, *1*, 26–40.
23. Wasbari, F.; Bakar, R.A.; Gan, L.M.; Tahir, M.M.; Yusof, A.A. A review of compressed-air hybrid technology in vehicle system. *Renew. Sustain. Energy Rev.* **2017**, *67*, 935–953. [[CrossRef](#)]
24. Greenblatt, J.B.; Succar, S.; Denkenberger, D.C.; Williams, R.T.; Robert, H.S. Baseload wind energy: Modeling the competition between gas turbines and compressed air energy storage for supplemental generation. *Energy Policy* **2007**, *35*, 1474–1492. [[CrossRef](#)]
25. Pei, P.; Korom, S.T.; Ling, K.; He, J.; Gil, A. Thermodynamic impact of aquifer permeability on the performance of a compressed air energy storage plant. *Energy Convers. Manag.* **2015**, *97*, 340–350. [[CrossRef](#)]
26. Guo, C.; Zhang, K.; Li, C. Subsurface system design and feasibility analysis of compressed air Energy storage in aquifers. *J. Tongji Univ. Nat. Sci.* **2016**, *44*, 1107–1112.
27. Jakiel, C.; Zunft, S.; Nowi, A. Adiabatic compressed air energy storage plants for efficient peak load power supply from wind energy: The European project AA-CAES. *Energy Technol. Policy* **2007**, *5*, 296–306. [[CrossRef](#)]
28. Grazzini, G.; Milazzo, A. A thermodynamic analysis of multistage adiabatic CAES. *Proc. IEEE* **2012**, *100*, 461–472. [[CrossRef](#)]
29. Yang, K.; Zhang, Y.; Li, X.; Xu, J. Design and calculation of advanced adiabatic compressed air energy storage system. *J. Eng. Thermophys.* **2012**, *33*, 725–728.
30. Li, X.; Yang, K.; Zhang, Y. Optimization design of compression and expansion stages in advanced adiabatic compressed air energy storage system. *J. Eng. Thermophys.* **2013**, *34*, 1649–1653.
31. Zhao, P.; Wang, M.; Wang, J.; Dai, Y. A preliminary dynamic behaviors analysis of a hybrid energy storage system based on adiabatic compressed air energy storage and flywheel energy storage for wind power application. *Energy* **2015**, *84*, 825–839. [[CrossRef](#)]
32. Luo, X.; Wang, J.; Krupke, C.; Wang, Y.; Li, J.; Xu, Y.; Wang, D.; Miao, S.; Chen, H. Modelling study, efficiency, analysis and optimization of large-scale adiabatic compressed air energy storage systems with low-temperature thermal storage. *Appl. Energy* **2016**, *162*, 589–600. [[CrossRef](#)]
33. Liu, J.; Wang, J. A comparative research of two adiabatic compressed air energy storage systems. *Energy Convers. Manag.* **2016**, *108*, 566–578. [[CrossRef](#)]
34. Barbour, E.; Mignard, D.; Ding, Y.; Li, Y. Adiabatic compressed air energy storage with packed bed thermal energy storage. *Appl. Energy* **2015**, *155*, 804–815. [[CrossRef](#)]
35. Sciacovelli, A.; Li, Y.; Chen, H.; Wu, Y.; Wang, J.; Garvey, S.; Ding, Y. Dynamic simulation of adiabatic compressed air energy storage (A-CAES) plant with integrated thermal storage- Link between components performance and plant performance. *Appl. Energy* **2017**, *185*, 16–28. [[CrossRef](#)]
36. Tessier, M.J.; Floros, M.C.; Bouzidi, L.; Narine, S.S. Exergy analysis of an adiabatic compressed air energy storage system using a cascade of phase change materials. *Energy* **2016**, *106*, 528–534. [[CrossRef](#)]
37. Guo, H. Performance Study on Novel Compressed Air Energy Storage System. Master's Thesis, University of Chinese Academy of Sciences, Beijing, China, 2013.
38. Liu, J.; Xia, H.; Chen, H.; Tan, C.; Xu, Y. A novel energy storage technology based on liquid air and its application in wind power. *J. Eng. Thermophys.* **2010**, *31*, 1993–1996.
39. Chino, K.; Araki, H. Evaluation of energy storage method using liquid air. *Heat Transf. Asian Res.* **2000**, *29*, 347–357. [[CrossRef](#)]
40. Morgan, R.; Nelmes, S.; Gibson, E.; Brett, G. Liquid air energy—Analysis and first results from a pilot scale demonstration plant. *Appl. Energy* **2015**, *137*, 845–853. [[CrossRef](#)]
41. Morgan, R. Liquid air energy storage—From theory to demonstration. *Int. J. Environ. Stud.* **2016**, *73*, 469–480. [[CrossRef](#)]
42. Kantharaj, D.; Garvey, S.; Pimm, A. Compressed air energy storage with liquid air energy capacity extension. *Appl. Energy* **2015**, *157*, 152–164. [[CrossRef](#)]
43. Pimm, A.J.; Garvey, S.D.; Kantharaj, B. Economic analysis of a hybrid energy storage system based on liquid air and compressed air. *J. Energy Storages* **2015**, *4*, 24–35. [[CrossRef](#)]
44. Ameel, B.; Tjoen, C.; Kerpel, K.; Jaeger, P.; Huisseune, H.; Bellegheem, M.V.; Paepe, M.D. Thermodynamic analysis of energy storage with a liquid air Rankine cycle. *Appl. Ther. Eng.* **2013**, *52*, 130–140. [[CrossRef](#)]
45. Guo, H.; Xu, Y.; Chen, H.; Zhou, X. Thermodynamic characteristics of a novel supercritical compressed air energy storage system. *Energy Convers. Manag.* **2016**, *115*, 167–177. [[CrossRef](#)]

46. Wang, B.; Yang, X.; Yang, S. Demand response performance and potential system dynamic analysis based on the long and medium time dimensions. *Proc. CSEE* **2015**, *35*, 6368–6377.
47. Li, C.; Xu, Z.; Ma, Z. Optimal time-of-use electricity price model considering customer demand response. *Proc. CSU-EPSCA* **2015**, *27*, 11–16.
48. Ghalelou, A.; Fakhri, A.P.; Nojavan, S.; Majidi, M.; Hatami, H. A stochastic self-scheduling program for compressed air energy storage (CAES) of renewable energy sources (RESs) based on a demand response mechanism. *Energy Convers. Manag.* **2016**, *120*, 388–396. [[CrossRef](#)]
49. Yang, X.; Su, J.; Lv, Z.; Liu, H.; Li, R. Overview on micro-grid. *Proc. CSEE* **2014**, *34*, 57–70.
50. Lu, Z.; Wang, C.; Min, Y.; Zhou, S.; Lv, J.; Wang, Y. Overview on microgrid research. *Autom. Electr. Power Syst.* **2007**, *31*, 100–107.
51. Tang, X.; Deng, W.; Qi, Z. Research on Grid-connected/islanded seamless transition of microgrid based on energy storage. *Trans. China Electrotech.* **2011**, *26*, 279–284.
52. Zhang, D.; Miao, X.; Liu, L.; Zhang, Y.; Liu, K. Research on development strategy for smart grid big data. *Proc. CSEE* **2015**, *35*, 2–12.
53. Wang, C.; Sun, W.; Yi, T.; Yan, Z.; Zhang, Y. Review on energy storage application planning and benefit evaluation methods in smart grid. *Proc. CSEE* **2013**, *33*, 33–41.
54. Rifkin, J. *The Third Industrial Revolution: How Lateral Power Is Transforming Energy, the Economy, and the World*, 3rd ed.; Palgrave Macmillan: New York, NY, USA, 2011; pp. 107–161.
55. Chen, Y.; Xu, H.; Tao, G.; Wang, X.; Liu, H.; Jia, G. Research and progress of the compressed air power vehicle. *Chin. J. Mech. Eng.* **2002**, *38*, 7–11. [[CrossRef](#)]
56. Xu, H.; Yu, X.; Wang, L.; Fang, Y.; Fan, Z.; Dou, W.; Li, D. Exergy analysis on compressed air engine. *Trans. Chin. Soc. Agric. Eng.* **2016**, *32*, 42–49.
57. Raju, M.; Khaitan, S.K. Modeling and simulation of compressed air storage in caverns: A case study of the Huntorf plant. *Appl. Energy* **2012**, *89*, 474–481. [[CrossRef](#)]
58. Mei, S.; Wang, J.; Tian, F.; Chen, L.; Xue, X.; Lu, Q.; Zhou, Y.; Zhou, X. Design and engineering implementation of non-supplementary fired compressed air energy storage system: TICC-500. *Sci. China* **2015**, *58*, 600–611. [[CrossRef](#)]
59. Sciaovelli, A.; Vecchi, A.; Ding, Y. Liquid air energy storage (LAES) with packed bed cold thermal storage—From component to system level performance through dynamic modeling. *Appl. Energy* **2017**, *190*, 84–98. [[CrossRef](#)]
60. Macaoenergy Industry. Available online: <http://www.macaoenergy.com/> (accessed on 9 May 2017).
61. Modern Power Systems. Available online: <https://www.eia.gov/todayinenergy/detail.php?id=6910> (accessed on 9 May 2017).
62. Fertig, E.; Apt, J. Economics of compressed air energy storage to integrate wind power: A case study in ERCOT. *Energy Policy* **2011**, *39*, 2330–2342. [[CrossRef](#)]
63. Park, H.; Baldick, R. Integration of compressed air energy storage systems co-located with wind resources in the ERCOT transmission system. *Electr. Power Energy Syst.* **2017**, *90*, 181–189. [[CrossRef](#)]
64. Liu, Y.; Woo, C.; Zarnikau, J. Wind generation's effect on the ex post variable profit of compressed air energy storage: Evidence from Texas. *J. Energy Storage* **2017**, *9*, 25–39. [[CrossRef](#)]
65. ESCN. Available online: <http://www.escn.com.cn/index.html> (accessed on 9 May 2017).
66. Greentech Media: A Wood Mackenzie Business. Available online: <https://www.greentechmedia.com/articles/read/toronto-hydro-pilots-worlds-first-offshore-compressed-air-energy-storage> (accessed on 5 May 2017).
67. Department of Energy. USA Techno-Economic Performance Evaluation of Compressed Air Energy Storage in the Pacific Northwest. Report. Available online: <http://caes.pnnl.gov/pdf/PNNL-22235.pdf> (accessed on 5 May 2017).
68. Large CAES Power Plant in Antrim Northern Ireland. Available online: <http://www.gaelectric.ie/energy-storage-projects/project-caes-larne-ni/> (accessed on 5 May 2017).
69. Corvaro, F.; Giachetta, G.; Marchetti, B.; Recanati, M. Reliability, availability, maintainability (RAM) study, on reciprocating compressors API 618. *Petroleum* **2016**, *3*, 1–7. [[CrossRef](#)]
70. Zhang, C.; Yan, B.; Weiberdink, J.; Li, P.Y.; Ven, J.D.; Loth, E.; Simon, T.W. Thermal analysis of a compressor for application to compressed air energy storage. *Appl. Ther. Eng.* **2014**, *73*, 1402–1411. [[CrossRef](#)]
71. Bao, J.; Zhao, L. A review of working fluid and expander selections for organic Rankine cycle. *Renew. Sustain. Energy Rev.* **2013**, *24*, 325–342. [[CrossRef](#)]
72. Xue, H.; Zhang, X.; Chen, H.; Xu, Y.; Li, W.; Tan, C. Analysis of energy release process of micro-compressed air energy storage systems. *J. Eng. Thermophys.* **2014**, *35*, 1923–1929.

73. Wang, J.; Yang, L.; Luo, X.; Mangan, S.; Derby, S. Mathematical modeling study of scroll air motors and energy efficiency analysis—Part 1. *AIIEE/ASME Trans. Mech.* **2011**, *16*, 112–121. [[CrossRef](#)]
74. Wang, J.; Yang, L.; Luo, X.; Mangan, S.; Derby, S. Mathematical modeling study of scroll air motors and energy efficiency analysis—Part 2. *AIIEE/ASME Trans. Mech.* **2011**, *16*, 122–132. [[CrossRef](#)]
75. Institute of Engineering Thermophysics, Chinese Academy of Sciences. Available online: http://www.etp.ac.cn/xwtdt/kydt/201703/t20170313_4757685.html (accessed on 9 May 2017).
76. Dinker, A.; Agarwal, M.; Agarwal, G.D. Heat storage materials, geometry and applications: A review. *J. Energy Inst.* **2017**, *90*, 1–11. [[CrossRef](#)]
77. Nomura, T.; Akiyama, T. High-temperature latent heat storage technology to utilize exergy of solar heat and industrial exhaust heat. *Int. J. Energy Res.* **2017**, *41*, 240–251. [[CrossRef](#)]
78. Nomura, T.; Tsubota, M.; Oya, T.; Okinaka, N.; Akiyama, T. Heat storage in direct—Contact heat exchanger with phase change material. *Appl. Ther. Eng.* **2013**, *50*, 26–34. [[CrossRef](#)]
79. Oro, E.; Gracia, A.; Castell, A.; Farid, M.M.; Cabeza, L.F. Review on phase change materials (PCMs) for cold thermal energy storage applications. *Appl. Energy* **2012**, *99*, 513–533. [[CrossRef](#)]
80. Leng, G.; Lan, Z.; Ge, Z.; Qin, Y.; Jiang, Z.; Ye, F.; Ding, Y. Recent progress in the thermal energy storage materials. *Energy Storage Sci. Technol.* **2015**, *4*, 119–130.
81. Li, C.; Ge, Z.; Jin, Y.; Li, Y.; Ding, Y. Heat transfer behavior of thermal energy storage components using composite phase change materials. *Energy Storage Sci. Technol.* **2015**, *4*, 169–175.
82. Sun, H.; Luo, X.; Wang, J. Feasibility study of a hybrid wind turbine system—Integration with compressed air energy storage. *Appl. Energy* **2015**, *137*, 617–628. [[CrossRef](#)]
83. Minutillo, M.; Lavadera, A.L.; Jannelli, E. Assessment of design and operating parameters for a small compressed air energy storage system integrated with a stand-alone renewable power plant. *J. Energy Storage* **2015**, *4*, 135–144. [[CrossRef](#)]
84. Li, Y.; Miao, S.; Luo, X.; Wang, J. Optimization model for the power system scheduling with wind generation and compressed air energy storage combination. In Proceedings of the 22nd International Conference on Automation and Computing, Colchester, UK, 7–8 September 2016.
85. Li, Y.; Miao, S.; Luo, X.; Wang, J. Optimization scheduling model based on source-load-energy storage coordination in power systems. In Proceedings of the 22nd International Conference on Automation and Computing, Colchester, UK, 7–8 September 2016.
86. Bai, Y.; Cheng, C.; Wu, K.; Wang, H.; Zhao, J. Coordinated control of storage battery and microturbine in islanded AC microgrid. *Electr. Power Autom. Equip.* **2014**, *34*, 65–70.
87. Amin, M.; Mehdi, M. Exergy analysis and optimization of an integrated micro gas turbine, compressed air energy storage system and solar dish collector process. *J. Clean. Prod.* **2016**, *139*, 372–383.
88. Li, Y.; Sciacovelli, A.; Peng, X.; Radcliffe, J.; Ding, Y. Integrating compressed air energy storage with a diesel engine for electricity generation in isolated areas. *Appl. Energy* **2016**, *171*, 26–36. [[CrossRef](#)]
89. Li, Y.; Chen, L.; Yuan, T.; Li, C. Optimal dispatch of zero-carbon-emission micro Energy Internet integrated with non-supplementary fired compressed air energy storage system. *J. Mod. Power Syst. Clean Energy* **2016**, *4*, 566–580. [[CrossRef](#)]
90. Nease, J.; Adams, T.A. Systems for peaking power with 100% CO₂ capture by integration of solid oxide fuel cells with compressed air energy storage. *J. Power Sources* **2013**, *228*, 281–293. [[CrossRef](#)]
91. Nease, J.; Adams, T.A. Coal-fuelled systems for peaking power with 100% CO₂ capture through integration of solid oxide fuel cells with compressed air energy storage. *J. Power Sources* **2014**, *251*, 92–107. [[CrossRef](#)]
92. Nease, J.; Monteiro, N.; Adams, T.A. Application of a two-level rolling horizon optimization scheme to a solid-oxide fuel cell and compressed air energy storage plant for the optimal supply of zero-emissions peaking power. *Comput. Chem. Eng.* **2016**, *94*, 235–249. [[CrossRef](#)]
93. Fang, Q.; Liu, H.; Chen, Y.; Tao, G. Thermodynamics simulation of a new hybrid compressed air and fuel engine concept. *China Mech. Eng.* **2008**, *9*, 1123–1127.
94. Fang, Q.; Liu, H.; Chen, Y.; Tao, G. Modeling and simulation of a new hybrid compressed air and fuel engine concept. *Trans. CSICE* **2007**, *25*, 550–555.

