

PHYS-E0525 Microscopy of Nanomaterials P (5 cr)

Prof. Janne Ruokolainen (nanotalo 102)

Email: Janne.Ruokolainen@aalto.fi

First lecture 17.1. 2023

Tuesday 12.15 – 14

Assistant: Shruti Shandilya Email: shruti.shandilya@aalto.fi

Course overview:

The course gives basic knowledge of the microscopy of materials nanoscale structures - including soft and hard materials. Lectures will concentrate on **transmission electron microscopy (TEM, STEM)**: high resolution imaging, electron diffraction and analytical microscopy by using elemental analyses (EDX, EELS), **cryo-electron microscopy** and **3D electron tomography**. Additionally, **scanning electron microscopy (SEM and FIB)**, **atomic force microscopy (AFM)** and **methods to prepare samples** are lectured..

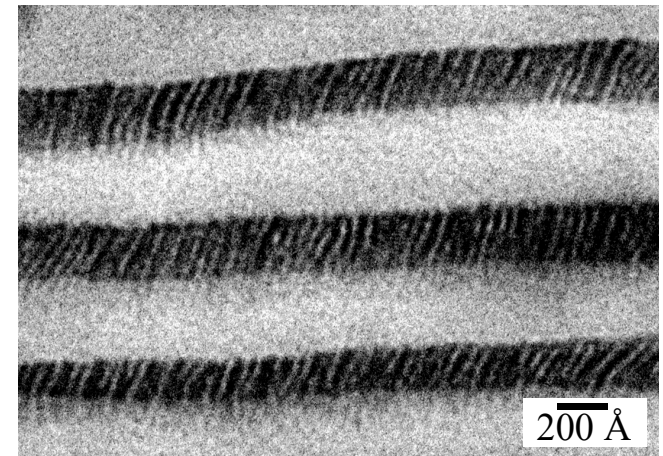
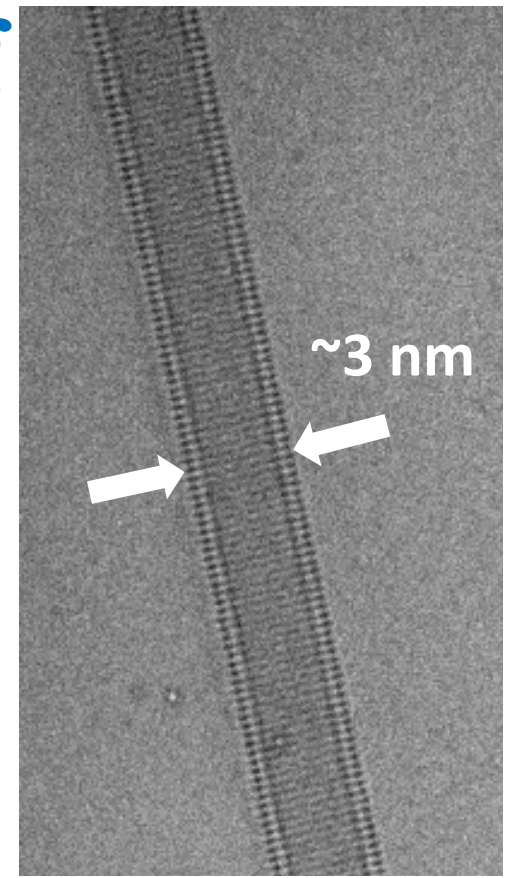

Lectures:

Prof. Janne Ruokolainen, Dr. Hua Jiang, Dr. Jani Seitsonen, Dr. Ramzy Abdelaziz, Prof. Peter Liljeroth, Dr. Lide Yao

Tentative Schedule

- 17. 1. Introduction & Nanomicroscopy center (JR)
- 24. 1. TEM Basics (JR)
- 31. 1. Advanced TEM 1 (Hua)
- 7. 2. Advanced TEM 2 (Hua)
- 14. 2. Advanced TEM 3 (Hua)
- 21. 2. *no lecture (exam period at Aalto)*
- 28. 2. Cryo-TEM and Soft matter Sample preparation (JR)
- 7. 3. SEM (Ramzy)
- 14. 3. 3D-TEM-Tomography (Jani)
- 21. 3. FIB and Sample preparation (Lide)
- 28. 3. STM/AFM (Peter)

Summary:

Intro, Basic TEM, Cryo TEM ~ 3 lectures
Advanced TEM 2-3 lectures
(High resolution TEM and STEM,
diffraction, spectroscopy EDX, EELS)
STM/AFM
FIB/sample preparation
SEM
Tomography

Additional Literature: (optional)

Book 1: *Transmission electron microscopy Basics I* (David William and Barry Carter)
2nd edition

Book 2: *G.H. Michler "Electron microscopy of polymers" (TEM, SEM, AFM..)*

Book 3: *A practical Guide to Transmission Electron Microscopy* (Zhiping Luo)

PHYS-E0526 Microscopy of Nanomaterials, laboratory course P (5 cr)

Assistant: Shandilay Shruti and **other teachers:** Dr. Jani Seitsonen (TEM & Tomography), Dr. Hua Jiang (HR-TEM), Dr. Ramzy Abdelaziz (SEM), Dr. Lide Yao (FIB)

As practical exercises nanostructured materials are studied with various microscopy methods. Course includes practical microscopy exercises by using transmission electron microscopy (TEM), scanning electron microscopy (SEM) and Focused ion beam (FIB).

Number of students participating to the course will be limited. (max. ~18) Based on applications... nmc-contact-sci@aalto.fi Deadline 6. 2. 2023

Basic exercises – Demos:

(6 persons per group):

- 1) High resolution TEM (Jeol 2200FS Cs-corrected TEM)
- 2) 3D tomography data collection (Jeol 3200FSC liquid helium cryo TEM or Jeol2800) + Tomography data processing (Computer room)

Small group exercises: (Select 2)

(3 persons per group)

- 1) basic-TEM imaging
- 2) SEM imaging or
- 3) FIB -SEM processing/imaging

Independent Small group exercises (without supervision.. 3 person per group)

(2 exercises)

- 1) TEM imaging
- 2) SEM imaging
- 3) ...

Electron microscopy TEM and STEM

Transmission electron microscopy TEM

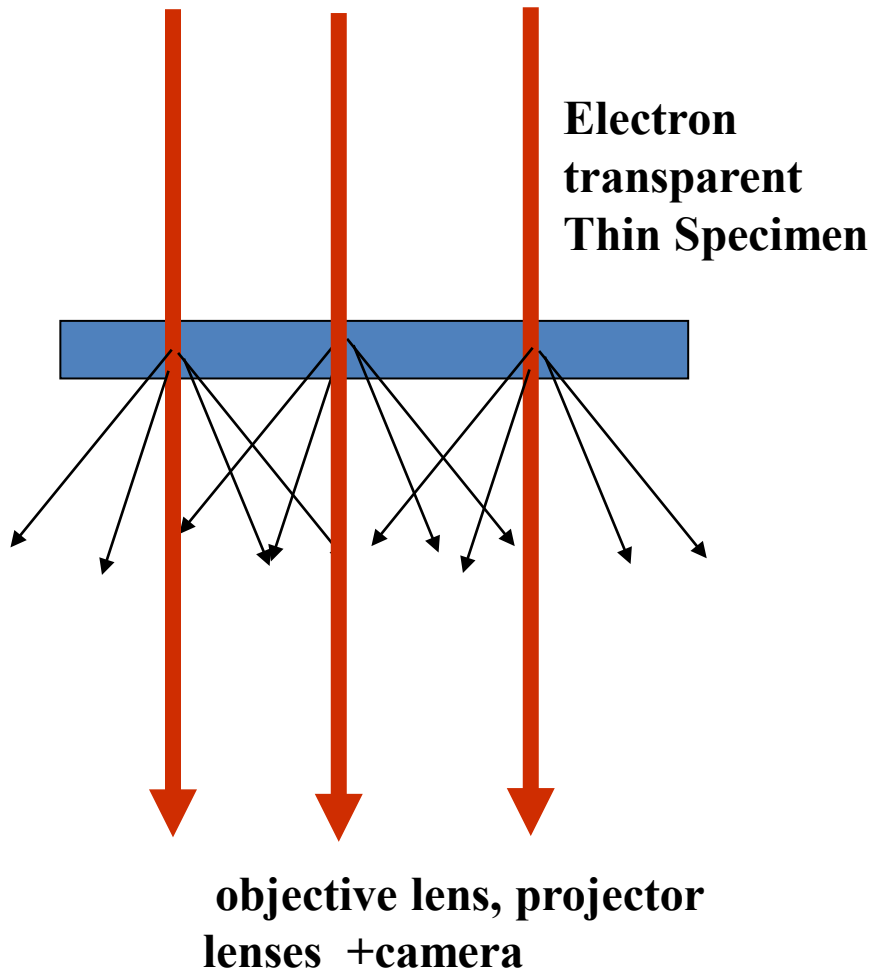

Scanning Transmission electron microscopy STEM

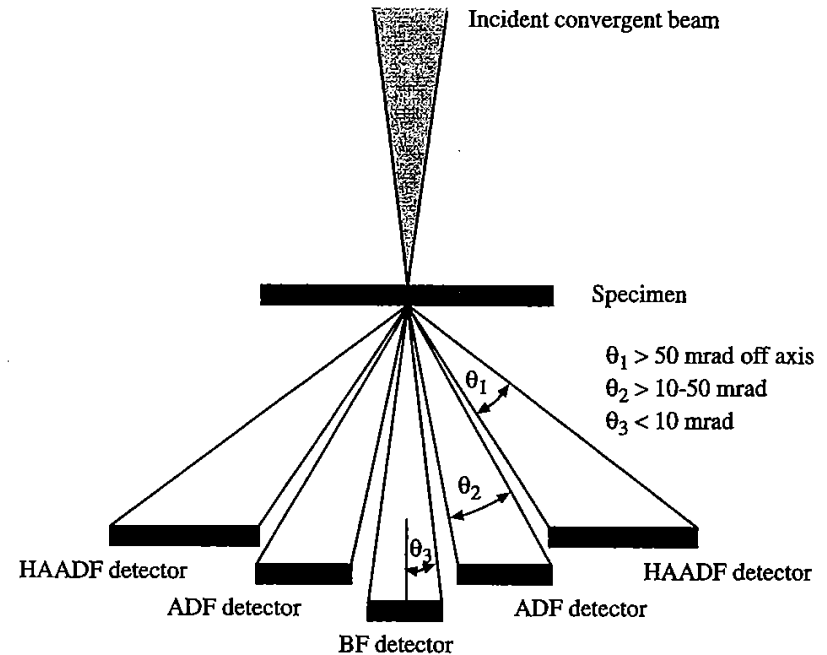
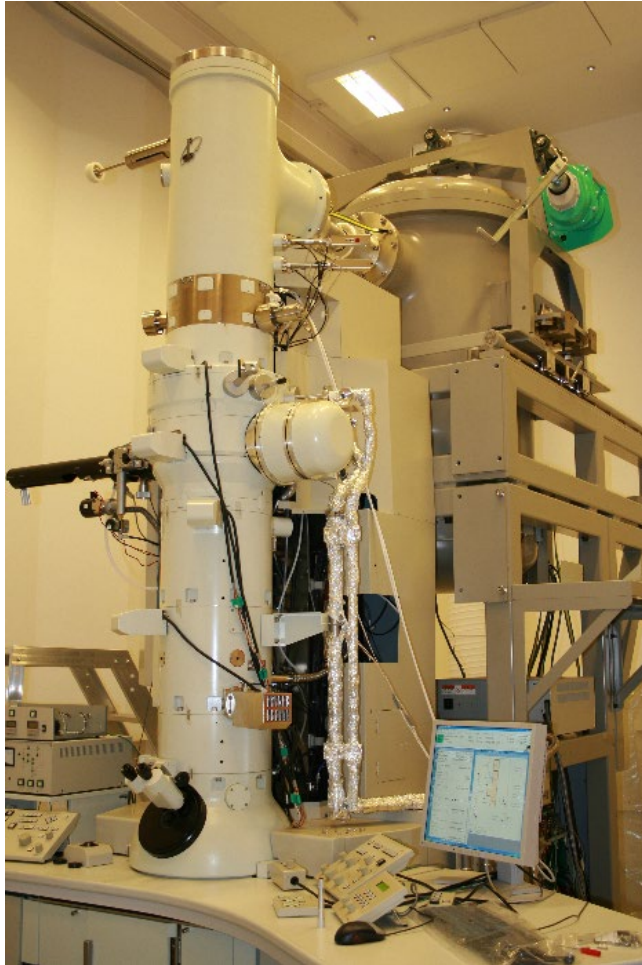

Figure 22.13. Schematic of the HAADF detector set-up for Z-contrast imaging in a STEM. The conventional ADF and BF detectors are also shown along with the range of electron scattering angles gathered by each detector.

**STEM: no objective lens etc.
– just detectors**

Lecture: Transmission Electron Microscopy (TEM) - Introduction



- 1) JEOL JEM-3200FSC 300 kV Cryo-Transmission Electron Microscope (EELS)
- 2) JEOL JEM-2800 200 kV Transmission Electron Microscope (EDX) +STEM



- 3) JEOL JEM-2200FS 200 kV Double Cs corrected Transmission Electron Microscope +STEM and EDX and EELS
- 4) FEI Tecnai 120 kV Transmission Electron Microscope

Lens System of TEM

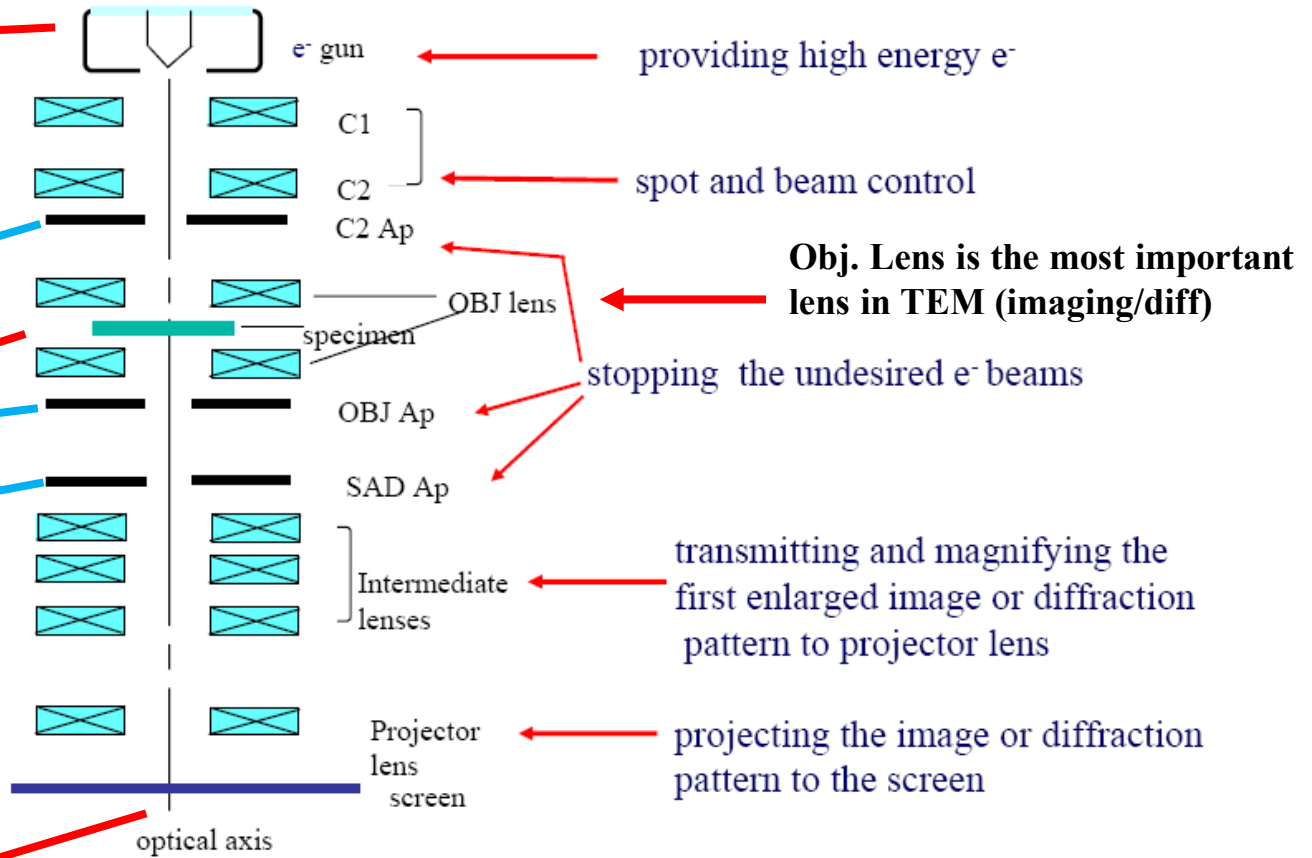
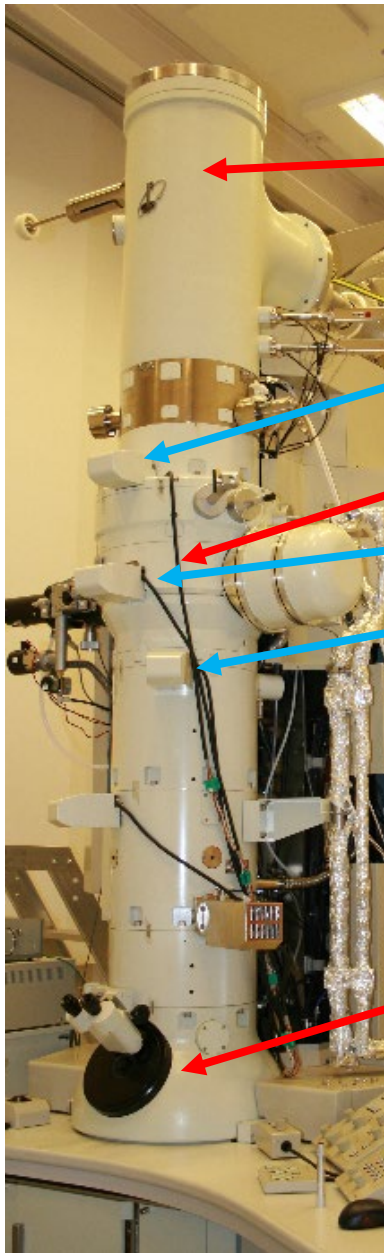

Book 1:

Chapter 5: Electron Sources

Chapter 6: Lenses, Apertures, and Resolution

Chapter 7: "How to see electrons"

Chapter 8: Vacuum pumps and Holders

Chapter 9: The Instrument

Transmission electron microscopy (TEM) vs. Optical microscope (Transmission mode)

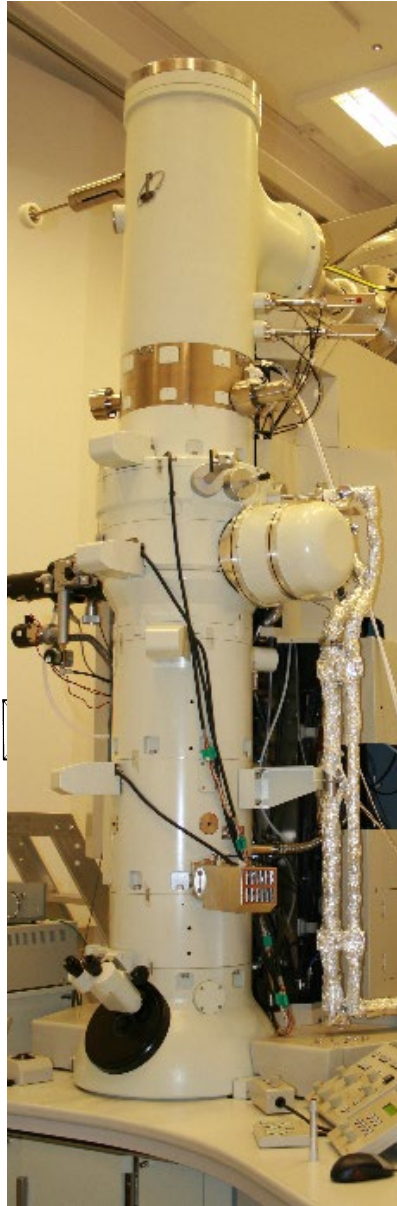

(OM)

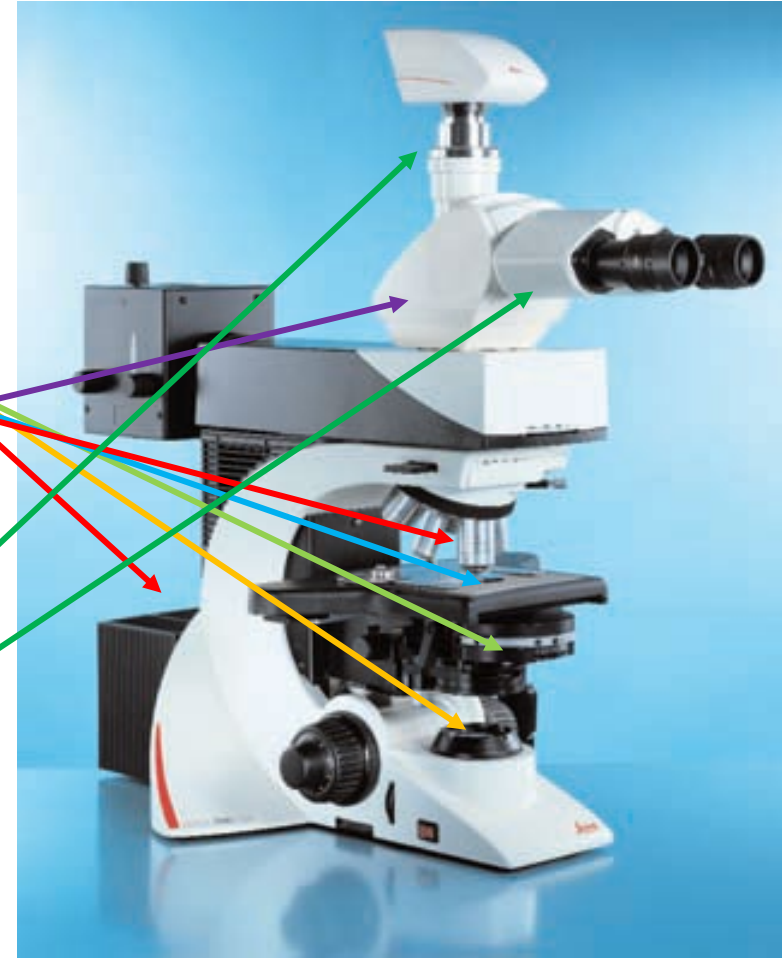
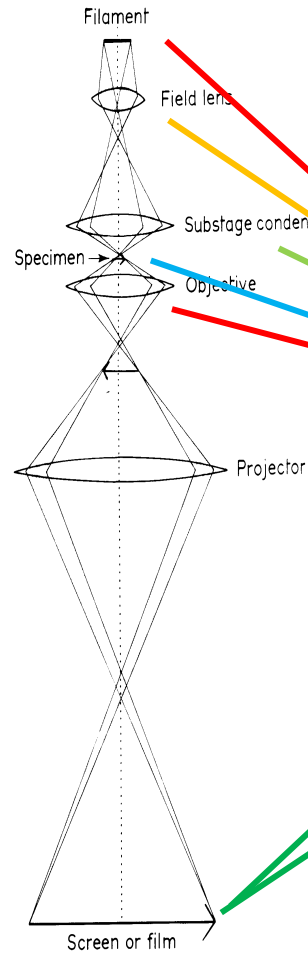

B

Resolution $\delta = \frac{0.61 * \lambda}{\mu \sin \beta}$

$\lambda = 400 - 700 \text{ nm}$, Optical microscope numerical aperture $\mu \sin \beta \sim 1$

→ Resolution $\sim 200 - 300 \text{ nm}$

Electron Sources

5

5.1. The Physics of Different Electron Sources	69
5.1.A. Thermionic Emission	69
5.1.B. Field Emission	70
5.2. The Characteristics of the Electron Beam	70
5.2.A. Brightness	70
5.2.B. Temporal Coherency and Energy Spread	71
5.2.C. Spatial Coherency and Source Size	72
5.2.D. Stability	72
5.3. Electron Guns	72
5.3.A. Thermionic Guns	72
5.3.B. Field-Emission Guns (FEGs)	76
5.4. Comparison of Guns	77
5.5. Measuring Your Gun Characteristics	78
5.5.A. Beam Current	78
5.5.B. Convergence Angle	78
5.5.C. Calculating the Beam Diameter	79
5.5.D. Measuring the Beam Diameter	79
5.5.E. Energy Spread	82
5.5.F. Spatial Coherency	82
5.6. What kV Should You Use?	82

Electron sources

Thermionic Sources

Electrons emitted by heating

Richardson's law

$$J = AT^2 e^{-\Phi/kT}$$

→ High emission current either at *high temperature* T or materials with *low work function* Φ

Tungsten hairpin
(**high T**)

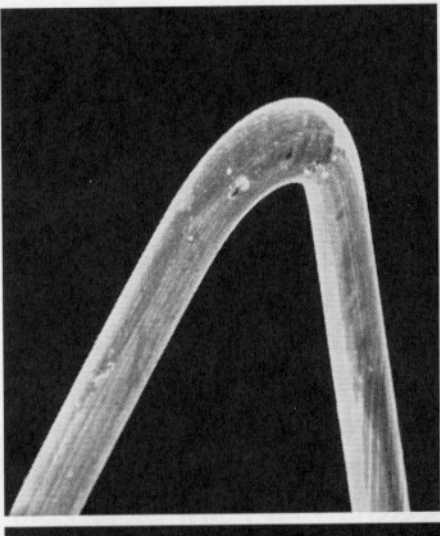

Lanthanum Hexaboride single crystal LaB₆ (**Low Φ**)

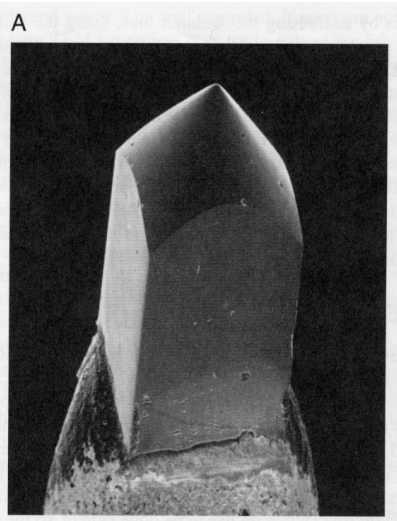

Field Emission - electrons emitted by high electric field

Electric field at the sharp point with radius r

$$E = \frac{V}{r}$$

radius typically $< 0.1 \mu\text{m}$

Field emission
(**Tungsten single crystal**)

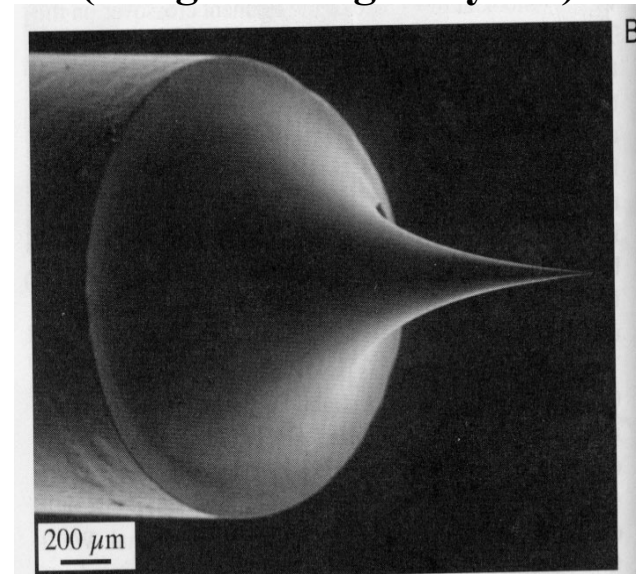

Thermionic Sources: Electrons are emitted by heating

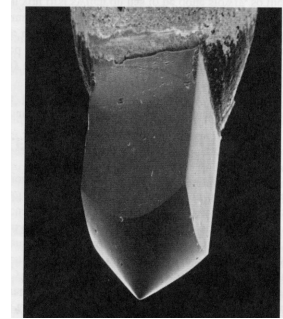
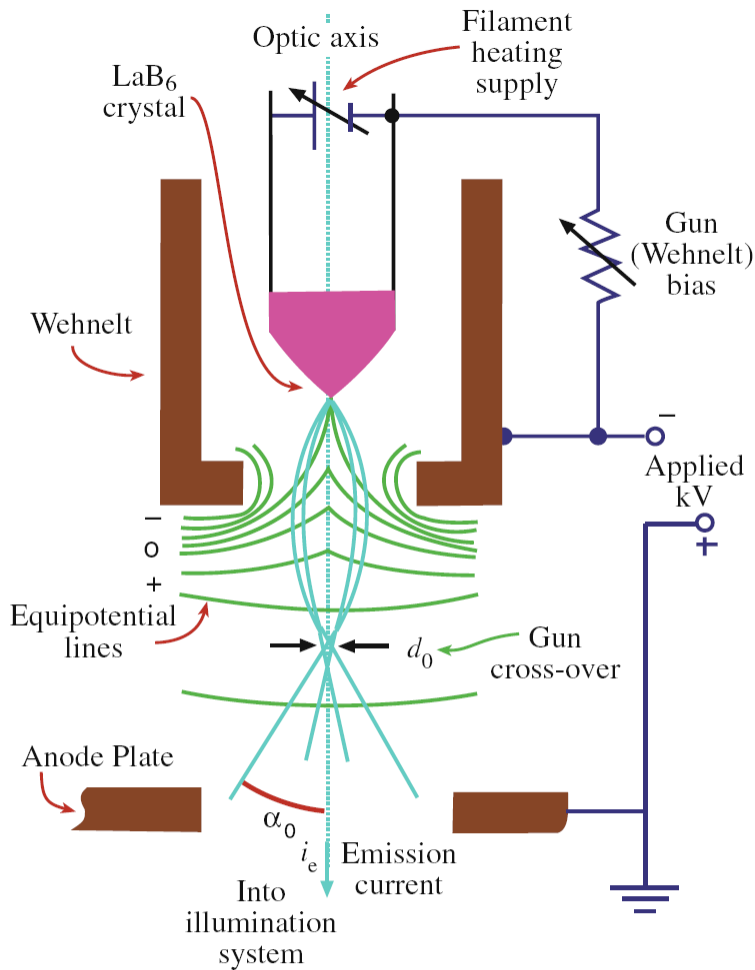

LaB₆ filament



FIGURE 5.2. The three major parts of a thermionic gun, from top to bottom: the cathode, the Wehnelt cylinder and the anode shown separated. The Wehnelt screws into the cathode support and both are attached to the high-voltage cable which also contains power supplies for heating the cathode and biasing the Wehnelt. The anode sits just below the Wehnelt and the whole assembly sits on the top of the column of lenses that make up the rest of the TEM.

FIGURE 5.1. Schematic diagram of a thermionic electron gun. A high voltage is placed between the cathode and the anode, modified by a potential on the Wehnelt which acts as the grid in a triode system. The electric field from the Wehnelt focuses the electrons into a crossover, diameter d_0 and convergence/divergence angle α_0 which is the true source (object) for the lenses in the TEM illumination system.

Lanthanum Hexaboride single crystal LaB_6 Filament heating to Saturation point..

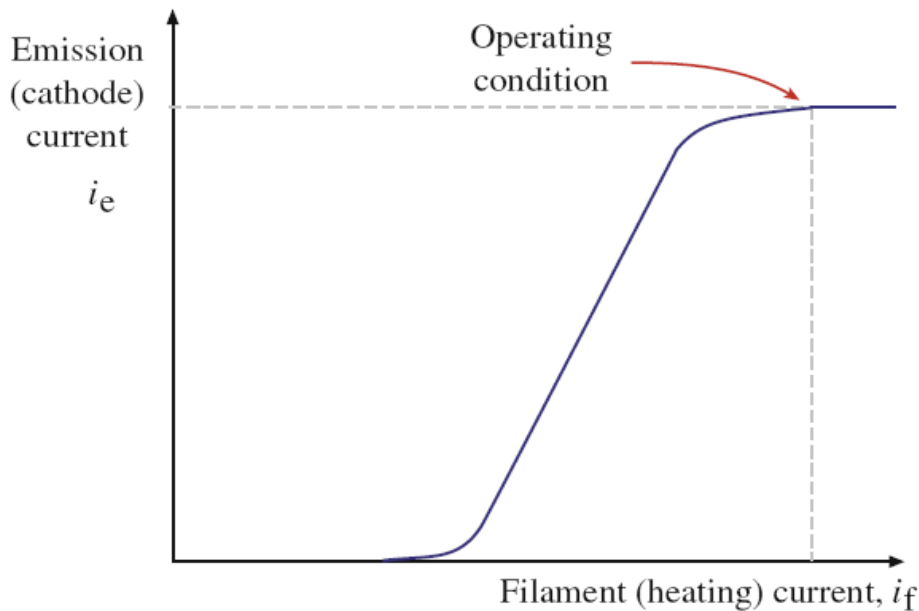

FIGURE 5.3. The relationship between the current emitted by the electron source and the source heating current for a self-biasing gun. Increasing the source current results in a maximum emission current termed saturation.

For the thermionic gun the **emission current increases with the filament heating** current applied. However, **once saturation is achieved, the brightness does not increase further** even at a higher filament heating current. It is very important to notice that with *increasing the filament heating current above the saturation point, the filament lifetime is significantly reduced.*

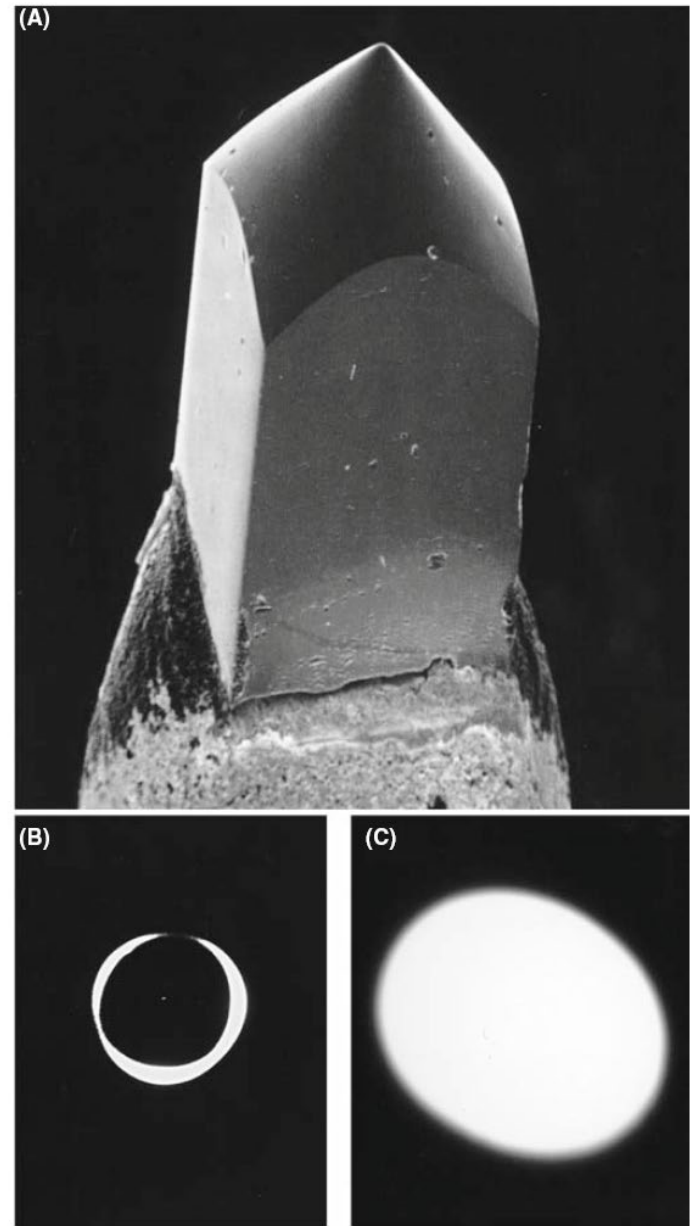

FIGURE 5.5. (A) An LaB_6 crystal and the electron distribution when the source is (B) undersaturated and (C) saturated.

Field Emission Source: electrons are emitted by high electric field

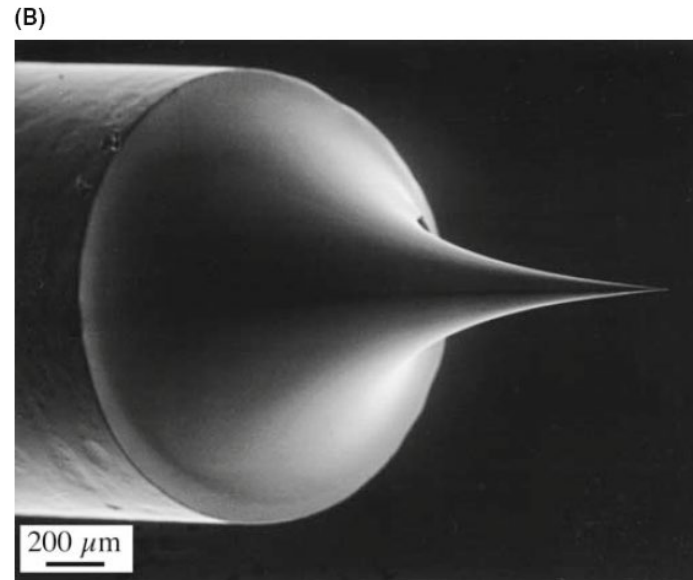
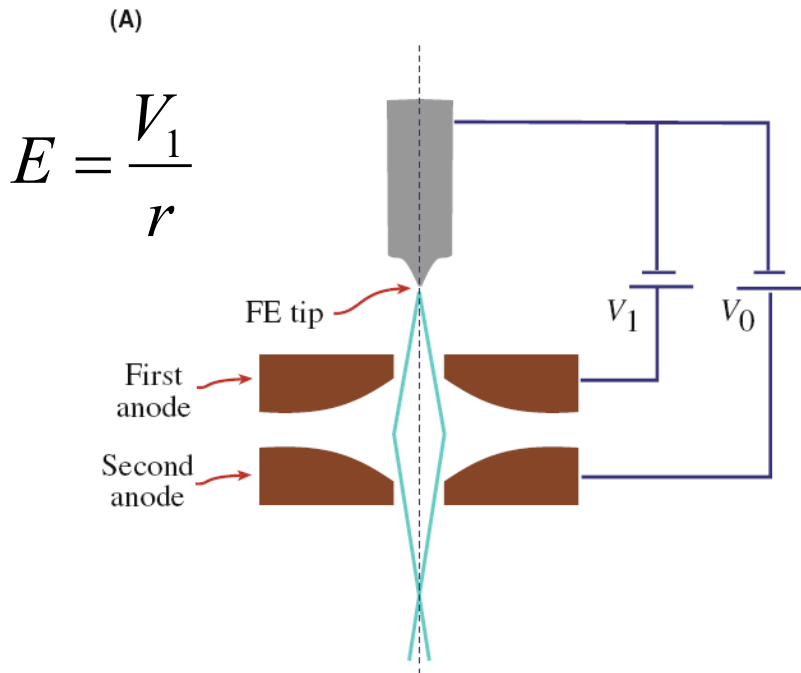

FIGURE 5.6. (A) Electron paths from a field-emission source showing how a fine crossover is formed by two anodes acting as an electrostatic lens. Sometimes an extra (gun) lens is added below the second anode. (B) A FEG tip, showing the extraordinarily fine W needle.

- Anode 1 provides the extraction voltage to pull electrons out of the tip.
- Anode 2 accelerates the electrons to 100 kV or more.

VACUUM IS IMPORTANT

In a vacuum of 10^{-5} Pa, one monolayer of contaminants will form on a substrate in less than a minute. At 10^{-8} Pa, it will take 7 hours to form a monolayer.

For FE to occur, the **surface** has to be pristine, i.e., it **must be free of contaminants** and oxide. We can achieve this by operating in ultra-high vacuum (**UHV**) conditions ($<10^{-9}$ Pa). In this case the tungsten is operated **at ambient temperatures** and the process is called '**cold**' FE.

Alternatively, we can keep the surface in a pristine condition at a poorer vacuum by heating the tip – i.e using **Schottky emitters**, which are made by coating a tungsten tip with a layer of zirconium oxide (also lowers the work function)

TABLE 5.1 Characteristics of the Principal Electron Sources

	Units	Tungsten	LaB ₆	Schottky FEG	Cold FEG
Work function, Φ	eV	4.5	2.4	3.0	4.5
Richardson's constant	A/m ² K ²	6×10^9	4×10^9		
Operating temperature	K	2700	1700	1700	300
Current density (at 100 kV)	A/m ²	5	10^2	10^5	10^6
Crossover size	nm	$> 10^5$	10^4	15	3
Brightness (at 100 kV)	A/m ² sr	10^{10}	5×10^{11}	5×10^{12}	10^{13}
Energy spread (at 100 kV)	eV	3	1.5	0.7	0.3
Emission current stability	%/hr	<1	<1	<1	5
Vacuum	Pa	10^{-2}	10^{-4}	10^{-6}	10^{-9}
Lifetime	hr	100	1000	>5000	>5000

~ 1-2 years

~ 3-7 years

~ 5-15 years

Schottky FEG :

Is most common - Good resolution, high lifetime, high total current

Cold FEG:

Low energy spread and small crossover size → higher image resolution and higher EELS and EDX resolution
 But higher vacuum = higher price, and also total current is smaller - therefore in lower magnifications and some analytical work which requires high intensities – Schottky is better

LaB6:

Cheap (1000 €), and works in low vacuum (i.e. microscope is also much cheaper) – not the best for high resolution work – total current is high – so it is also good for analytical work in SEM's.

IN NMC we have:

- 1 Cold FEG (SEM)
- 7 Schottky FEG's (4 TEM's, 2 SEM's, and FIB-SEM)
- 2 LaB6 (1 TEM and 1 SEM)

New TEM's will have:

- Cold FEG (300kv high resolution TEM)
- LaB6 for basic 200kv TEM

5.6 WHAT kV SHOULD YOU USE?

For the materials scientist and nanotechnologist, this is usually an easy question to answer: we'll call it the kV axiom.

However, there are exceptions to this axiom and the most obvious is avoiding knock-on beam damage, but we'll see others later in the book. So don't forget that you can always operate a modern 300-kV TEM at 100 kV. It's like being able to change the wavelength of a monochromatic light source in a visible-light microscope. As we saw in Chapter 4, the threshold for displacement damage for most metals is less than 400 kV, which is the highest available voltage on 'off-the-shelf' TEMs. For lighter and more beam-sensitive materials such as some ceramics and polymers, lower kV may be better. For most materials specimens, there is not much use going below 100 kV since the images will be rather dim and you'll have to make *very* thin specimens to see anything useful. However, when studying a crystalline specimen by diffraction contrast, 100 kV is better than 200 kV is better than 300 kV, providing you can still see through the specimen! For biological specimens, there is significant advantage to the increased contrast available in lower-kV images and STEM in (30-kV) SEMs is an increasingly useful imaging tool.

THE kV AXIOM

You should always operate at the maximum available kV (unless you shouldn't).

Apart from these exceptions, the reasons for choosing the highest kV are

- The gun is brightest so you get the most signal to put into your specimen.
- The wavelength is shortest; the image resolution is potentially better.
- The cross section for elastic scatter is also reduced so beam broadening is reduced and analytical spatial resolution is enhanced.
- The cross section for inelastic scatter is smaller, so heating effects may be smaller.
- You can 'see' through thicker specimens.
- The peak to background ratio in X-ray spectra is improved (see Chapter 36).

And for **carbon nanotubes** quite low voltage i.e. **80 kV** is a better (below ~120 kV) Carbon and other 2D materials have knock-out damage due to high energy electrons..

Low contrast samples – lower voltage is better to increase contrast – however there is more beam damage in TEM for lower voltages due to heating effects...(more inelastic scattering)

6	Lenses, Apertures, and Resolution	91
	Chapter Preview	91
6.1	Why Learn About Lenses?	91
6.2	Light Optics and Electron Optics	92
6.2.A	How to Draw a Ray Diagram	92
6.2.B	The Principal Optical Elements	94
6.2.C	The Lens Equation	94
6.2.D	Magnification, Demagnification, and Focus	95
6.3	Electron Lenses	96
6.3.A	Polepieces and Coils	96
6.3.B	Different Kinds of Lenses	97
6.3.C	Electron Ray Paths Through Magnetic Fields	99
6.3.D	Image Rotation and the Eucentric Plane	100
6.3.E	Deflecting the Beam	101
6.4	Apertures and Diaphragms	101
6.5	Real Lenses and their Problems	102
6.5.A	Spherical Aberration	103
6.5.B	Chromatic Aberration	104
6.5.C	Astigmatism	106
6.6	The Resolution of the Electron Lens (and Ultimately of the TEM)	106
6.6.A	Theoretical Resolution (Diffraction-Limited Resolution)	107
6.6.B	The Practical Resolution Due to Spherical Aberration	108
6.6.C	Specimen-Limited Resolution Due to Chromatic Aberration	109
6.6.D	Confusion in the Definitions of Resolution	109
6.7	Depth of Focus and Depth of Field	110
	Chapter Summary	111

Lenses, apertures, and resolution

- Why can we see finer detail with an electron microscope than with a light microscope?
- Why can't we see as much detail as we might expect from physics?
- Why does the TEM have a better depth of field and depth of focus than the light microscope?

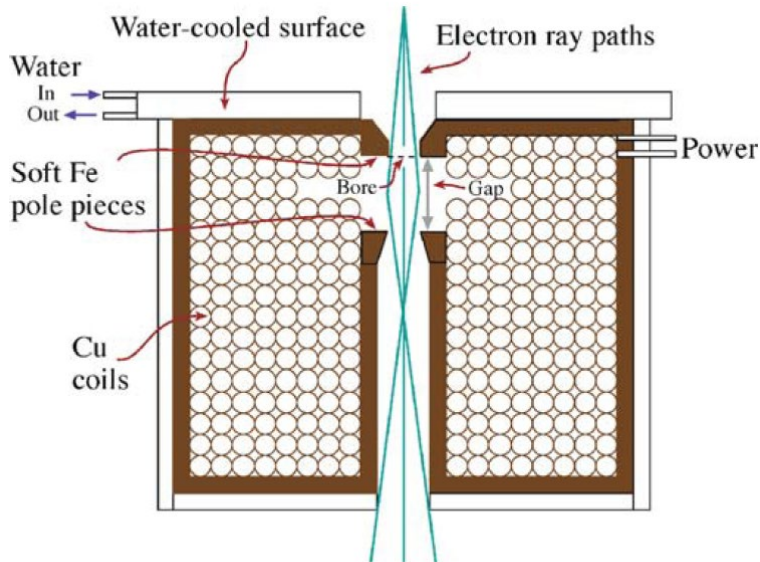
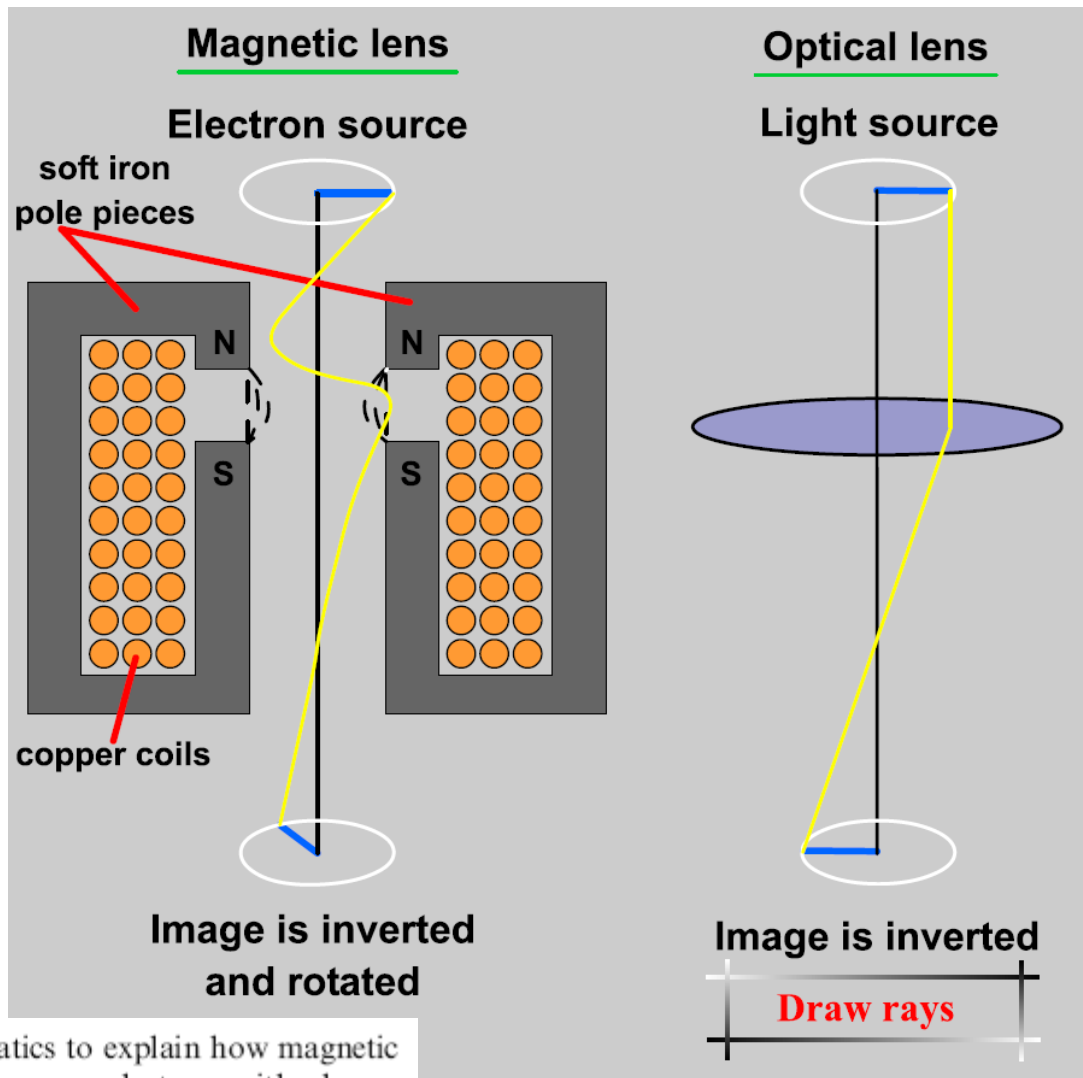

FIGURE 6.6. Schematic diagram of a magnetic lens. The soft-iron polepieces sit in the hole down the middle of the lens and are surrounded by the copper coils through which the current runs to magnetize the polepieces. When viewed in cross section, the bore and the gap between the polepieces are visible. The magnetic field is weakest on axis and increases in strength toward the sides of the polepiece, so the more the electrons travel off axis the more strongly they are deflected.

Magnetic lenses



FIGURE 6.7. A real lens: the cylindrical shape conceals the copper wire coils. The two conical polepieces beside the lens sit inside the central hole in the lens. The three-pin electrical connections provide current to the coil to magnetize the polepieces, and cooling water is circulated in and out of the two holes in the top plate of the lens to dissipate the resistive heat generated in the coils. Compare this picture with the schematic in Figure 6.6.



We need a bit of mathematics to explain how magnetic lenses actually work. When an electron with charge $q (= -e)$ enters a magnetic field with a strength \mathbf{B} (Tesla) and an electric field of strength \mathbf{E} , it experiences a force \mathbf{F} , known as the Lorentz force, which depends on the velocity of the electron, \mathbf{v} . All these factors are related through the equation

$$\mathbf{F} = q(\mathbf{E} + \mathbf{v} \times \mathbf{B}) = -e(\mathbf{E} + \mathbf{v} \times \mathbf{B}) \quad (6.3)$$

CHANGING THE LENS

We change focus, change the intensity of illumination or change magnification by changing the strength of the lenses.

Optical lens we change the position (i.e. distance from the sample etc.)

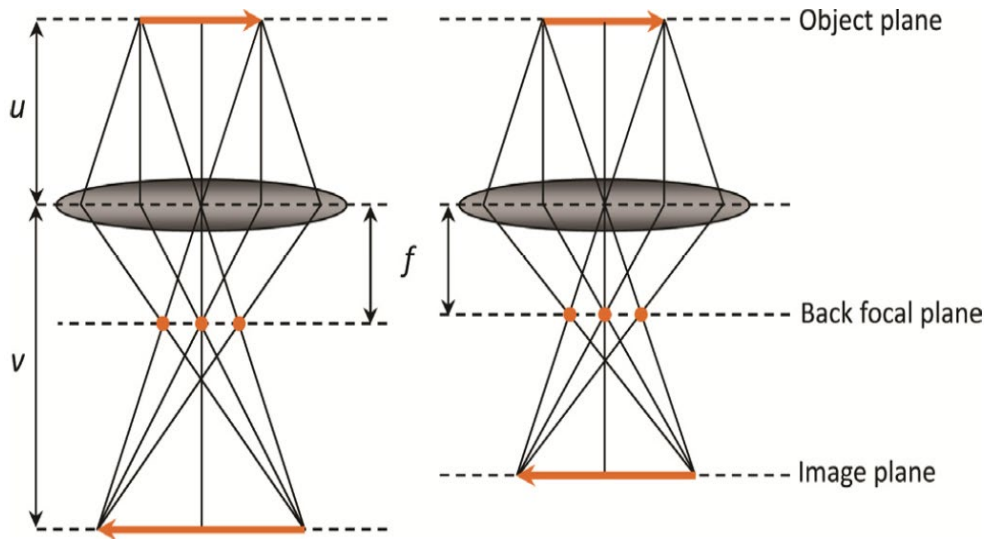

Relationship between object distance u , image distance v and focal length f . (a, b) u remains the same, while f is changed

APERTURES

We use apertures in the lenses to control the divergence or convergence of electron paths through the lenses which, in turn, affects the lens aberrations and controls the current in the beam hitting the specimen.

TEM has 3 important apertures: *Objective*, *Condenser*, selected area *diffraction*

EXAGGERATE ANGLES

In practice, a typical value of β is maybe a few tens of milliradians ($10 \text{ mrad} \sim 0.57^\circ$) so if the diagrams were drawn to scale they would be many times longer than they were wide and all the ray paths would be exceedingly narrow. Since drawing to scale is impractical, we always exaggerate the angles considerably in all electron ray diagrams.

Small collection angle \rightarrow

- Depth of field (sample in focus)
 - Depth of Focus (image in focus)
- are very high.**

Optical microscope β can be > 70 degrees – therefore depth of field is very small.

General features of magnetic lenses

1. They focus near-axis electron rays with the same accuracy as a glass lens focuses near-axis light rays
2. They suffer from the same aberrations as glass lenses e.g. “chromatic aberration, spherical aberration, astigmatism, to name the three most important
3. They produce a rotation of the image, unlike glass lenses
4. Focal length can be varied by changing the field between the pole piece, i.e. by changing the current through the windings \Rightarrow the magnification of an electron image can be varied very easily simply by rotating the knob on a rheostat
5. They are always converging lenses
6. Typical size: Bore of pole piece in objective lens ~ 4 mm; objective, 100kv, focal length could be $=1.5$ mm, $C_s = 1.2$ mm

TEM's most important lenses and Apertures

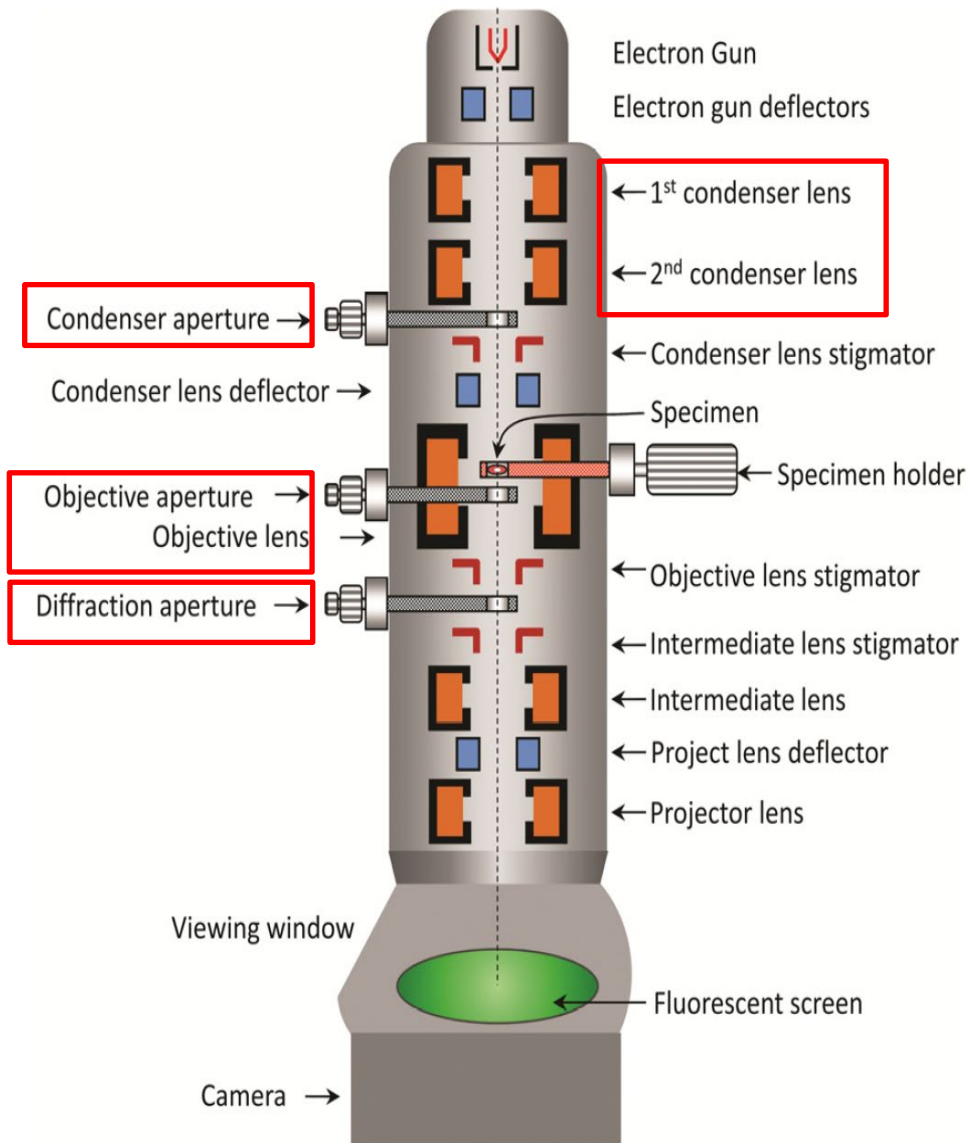

Condenser lenses are used to control the beam: i.e parallel or focused.

- **C1 is spot size** – for beam sensitive samples small spot and small Condenser aperture
- **C2** controls the beam spreading (focused or parallel)

Objective lens and aperture is important in image formation

Diffraction aperture for diffraction work..

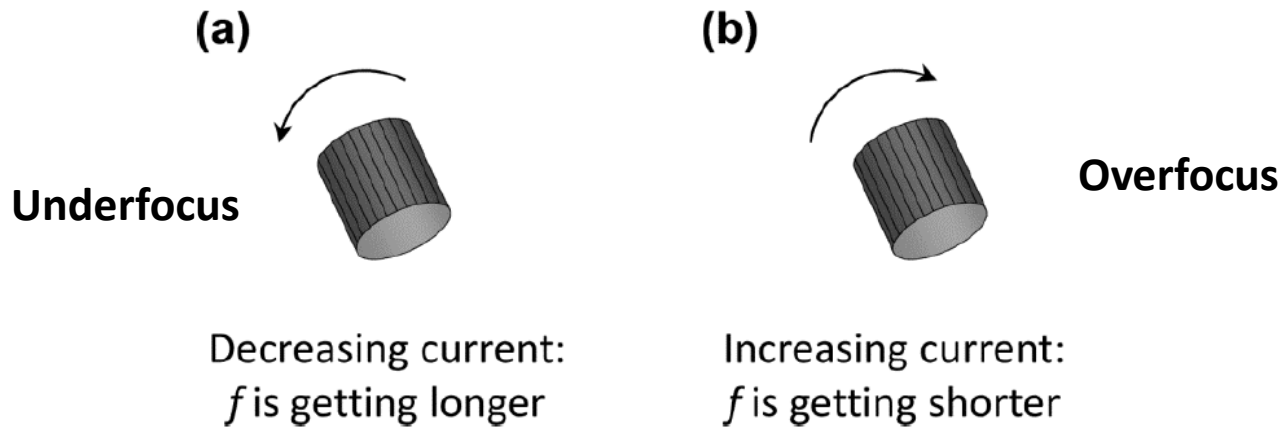

Fig. 3.6 Adjusting focal length f by changing lens current.
(a) Decreasing current; (b) increasing current.

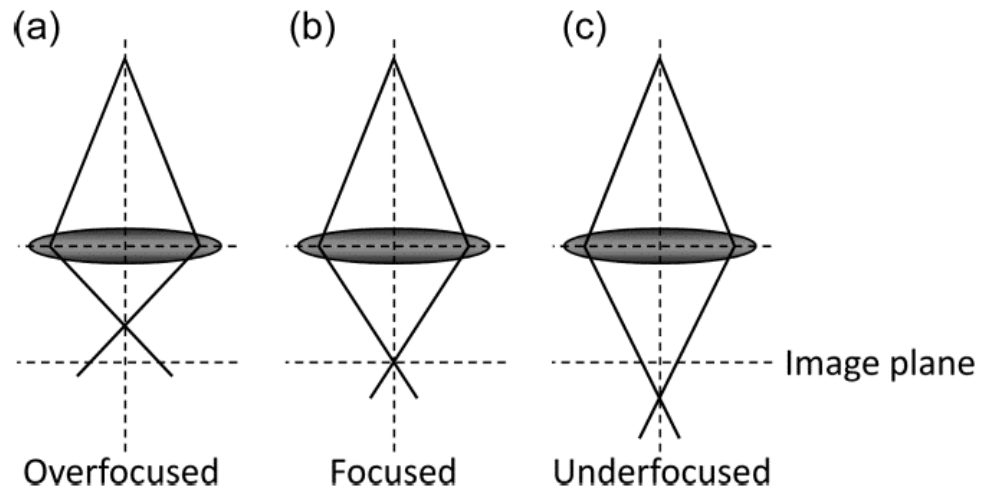

Fig. 3.7 Focus of lens. (a) Overfocused; (b) focused; (c) underfocused.

Condenser lenses C1 and C2

C1 is spot size – for beam sensitive samples small spot (overfocus → small spot – focus for this lens is steps 1,2,3 ... number 1 spot is the largest beam intensity, and the highest number is smallest)

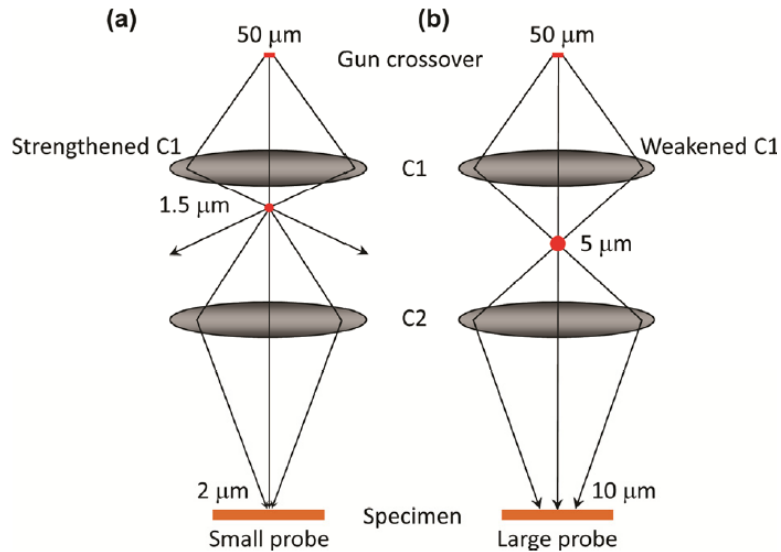

Fig. 3.8 Condenser lens 1 (C1) that controls the beam size.
 (a) Strengthened C1 to get a small probe on the specimen;
 (b) weakened C1 to get a large probe on the specimen.

C2 controls the beam spreading (focused or parallel)

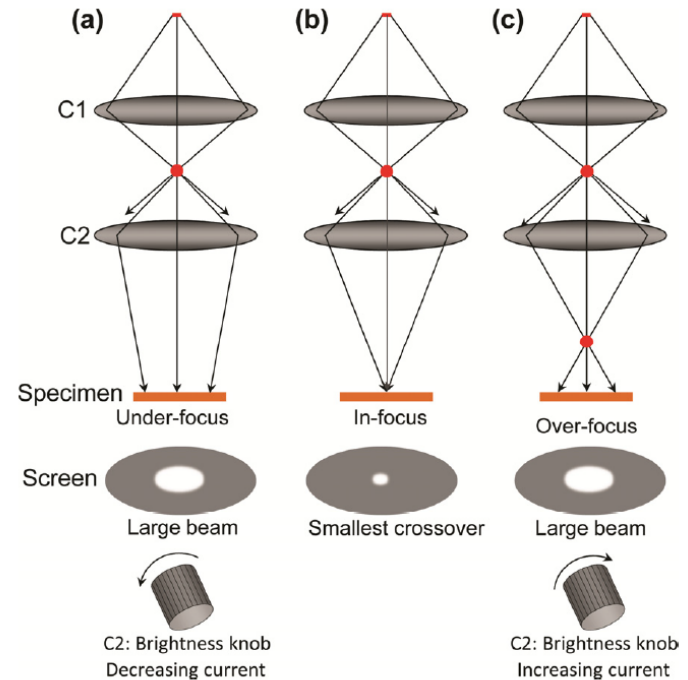

Fig. 3.9 Condenser lens 2 (C2) that controls the beam brightness.
 (a) Underfocus the beam to get a larger area illumination; (b) in-focus the image to get the smallest beam crossover on the specimen; (c) overfocus the beam to get a larger area illumination. The brightness knob controls C2.

It is very important to keep **C2 overfocused for imaging** – in that case - after the upper objective lens, the rays become more **parallel** before reaching the specimen. Therefore, during the TEM experiment, keep in mind to leave C2 overfocused (turn the brightness knob clockwise CW beyond the crossover point)

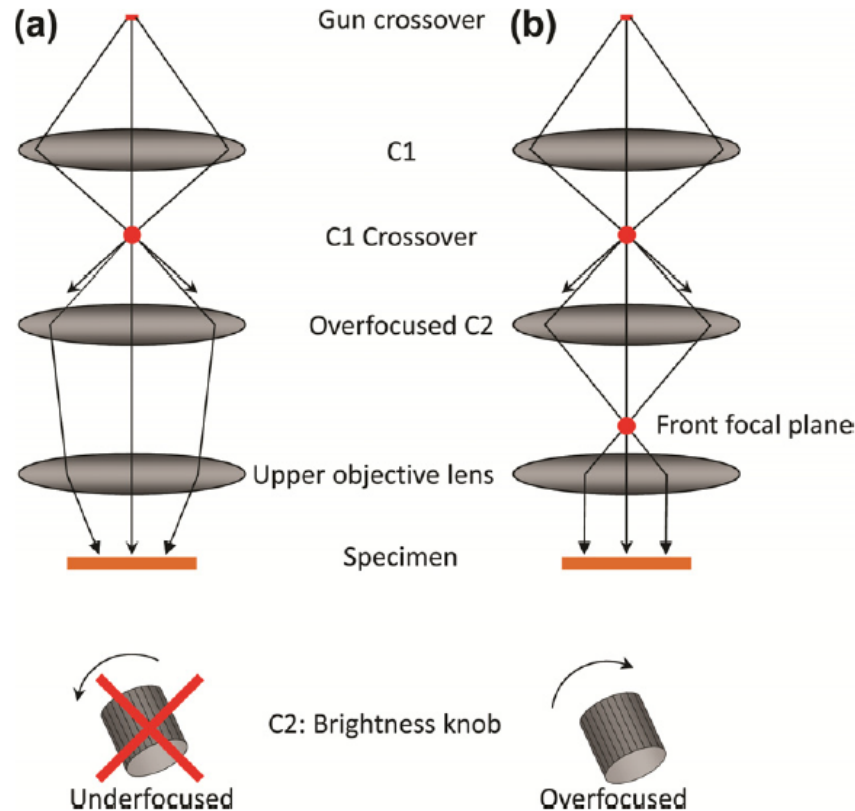

Fig. 3.10 (a) Underfocusing C2 (turning the brightness knob CCW beyond the crossover) results in nonparallel illumination on specimen; (b) overfocusing C2 produces parallel illumination.

Also condenser aperture can be used to control the beam intensity – addition to spot size (C1-lens). Small aperture \rightarrow less intensity and also more parallel beam (if that's which needs to be optimized..)

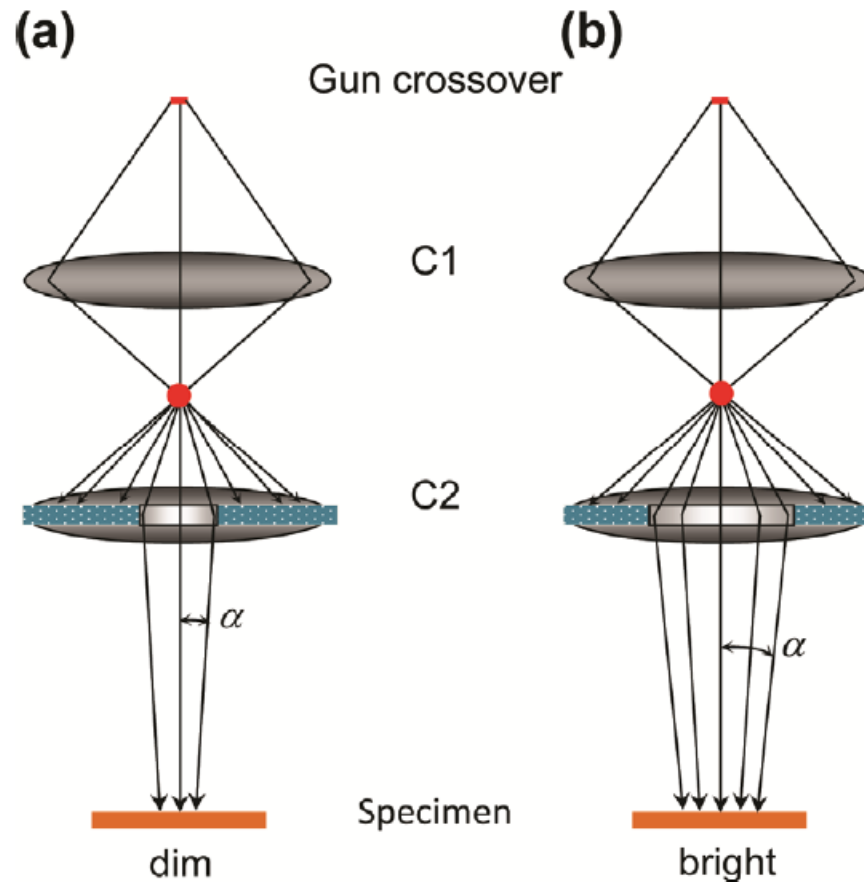
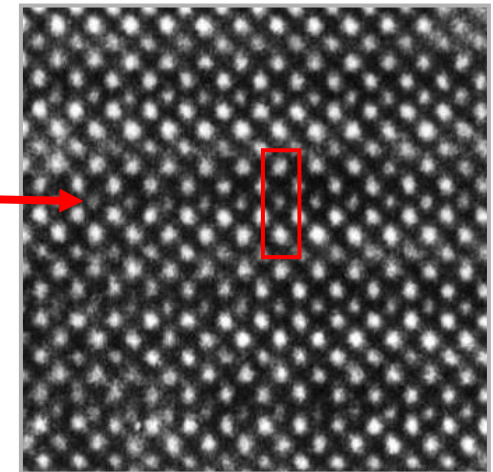
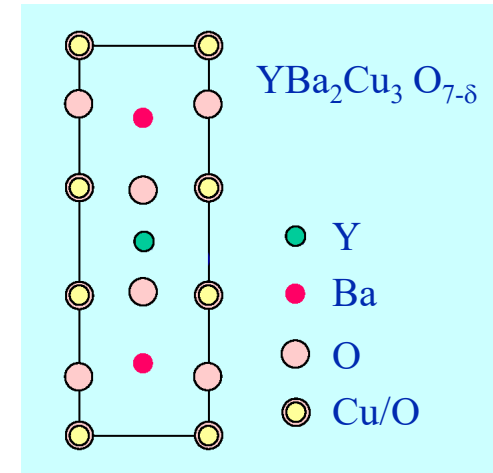
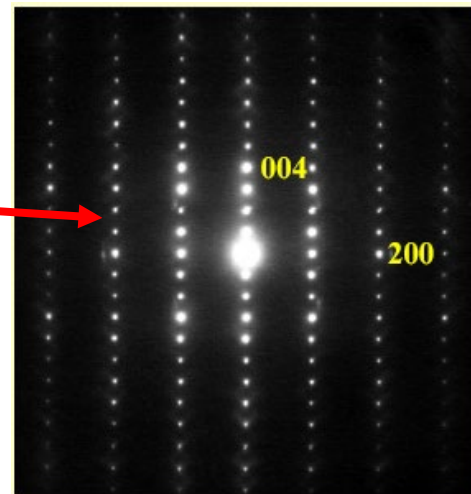
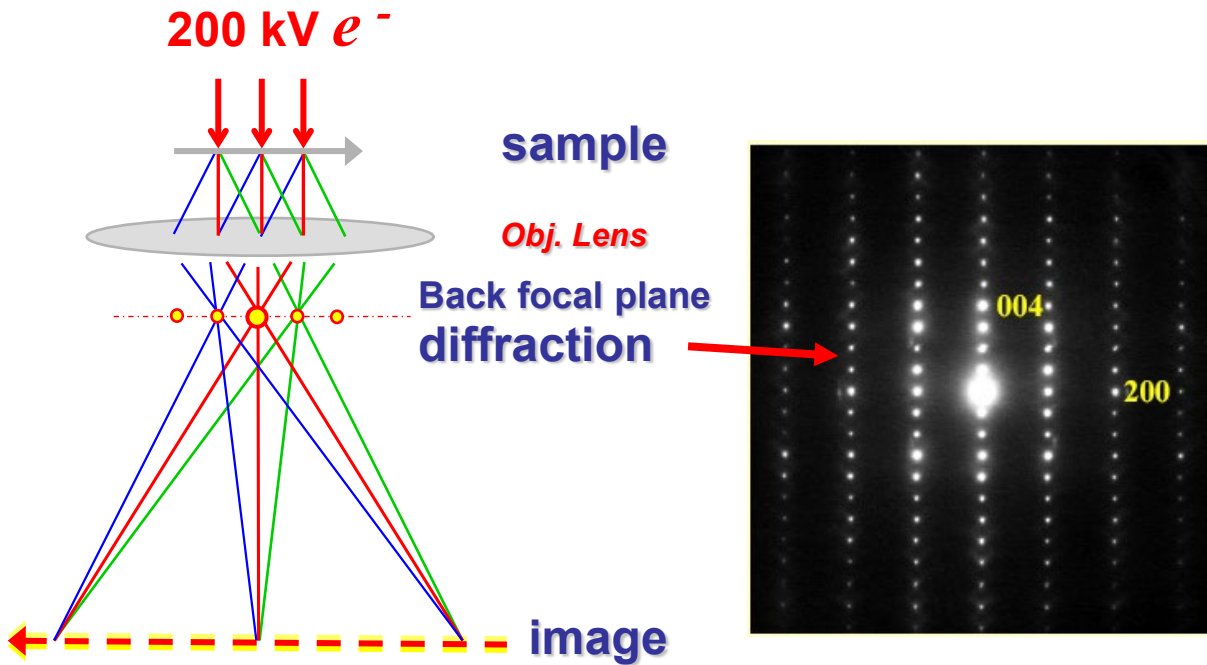

Fig. 3.11 Condenser aperture. (a) Smaller aperture; (b) larger aperture.

Image formation and contrast in TEM

TEM: Imaging Vs. Diffraction (Direct beam and elastic scattering..)



- An **image** represents the structure in real space at a certain resolution;
- The **diffraction** is an reproduction of the structure in reciprocal space.

Imaging Vs. Diffraction

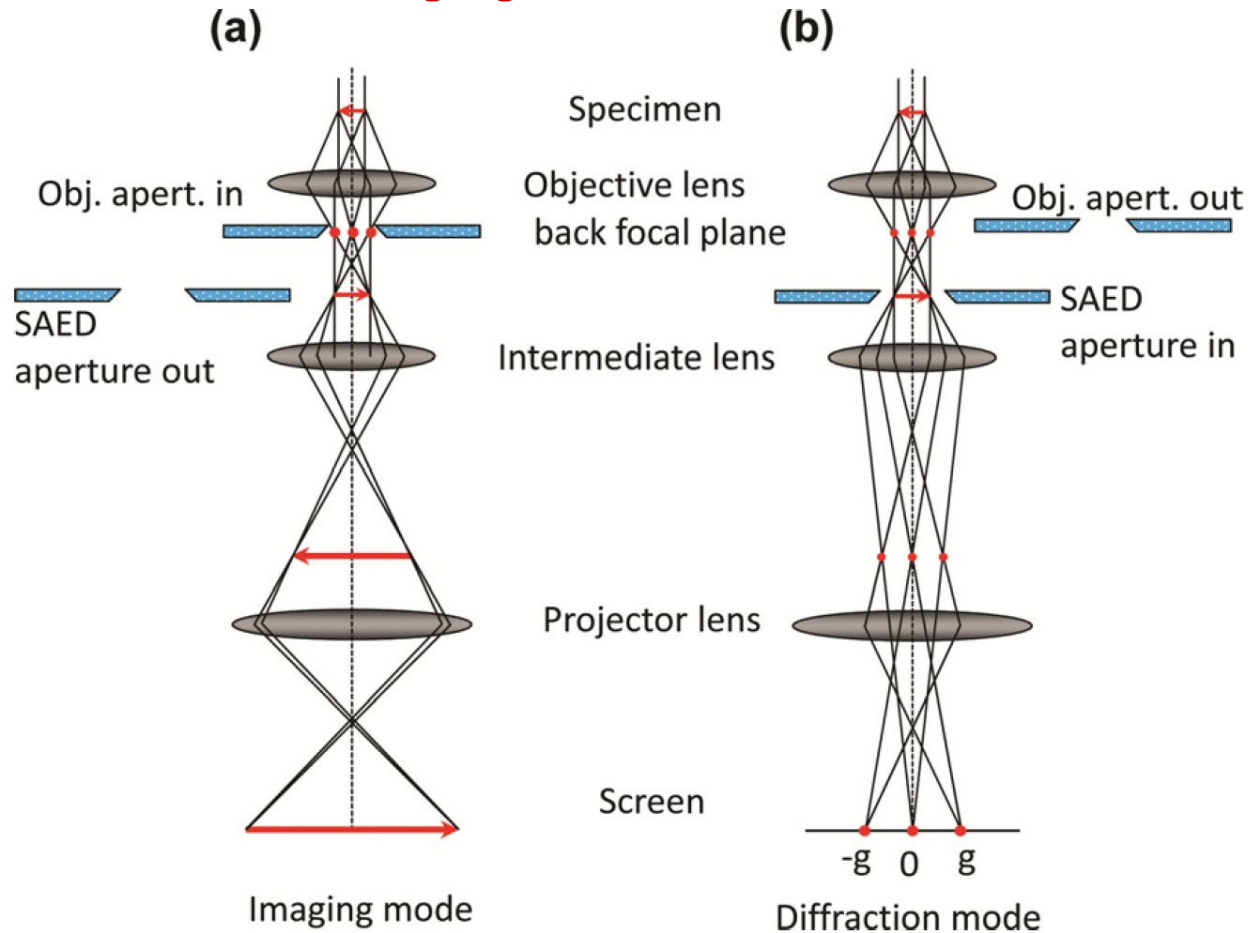

The **intermediate lens** is used to magnify the image and for selection between imaging and diffraction mode. After the electrons pass through the specimen, a diffraction pattern is formed in the back focal plane, and then the first image is formed. **If the intermediate lens focuses on the first image (a)** this image is further magnified by the following lenses, so that a magnified **image appears on the screen**. However, if the *intermediate lens focuses on the first diffraction pattern* in the back focal plane of the specimen, as shown in (b), this pattern is further magnified by the following lenses, so that a *diffraction pattern appears on the screen*.

Image formation and contrast

In TEM imaging mode we use parallel beam set by Condenser C2 lens

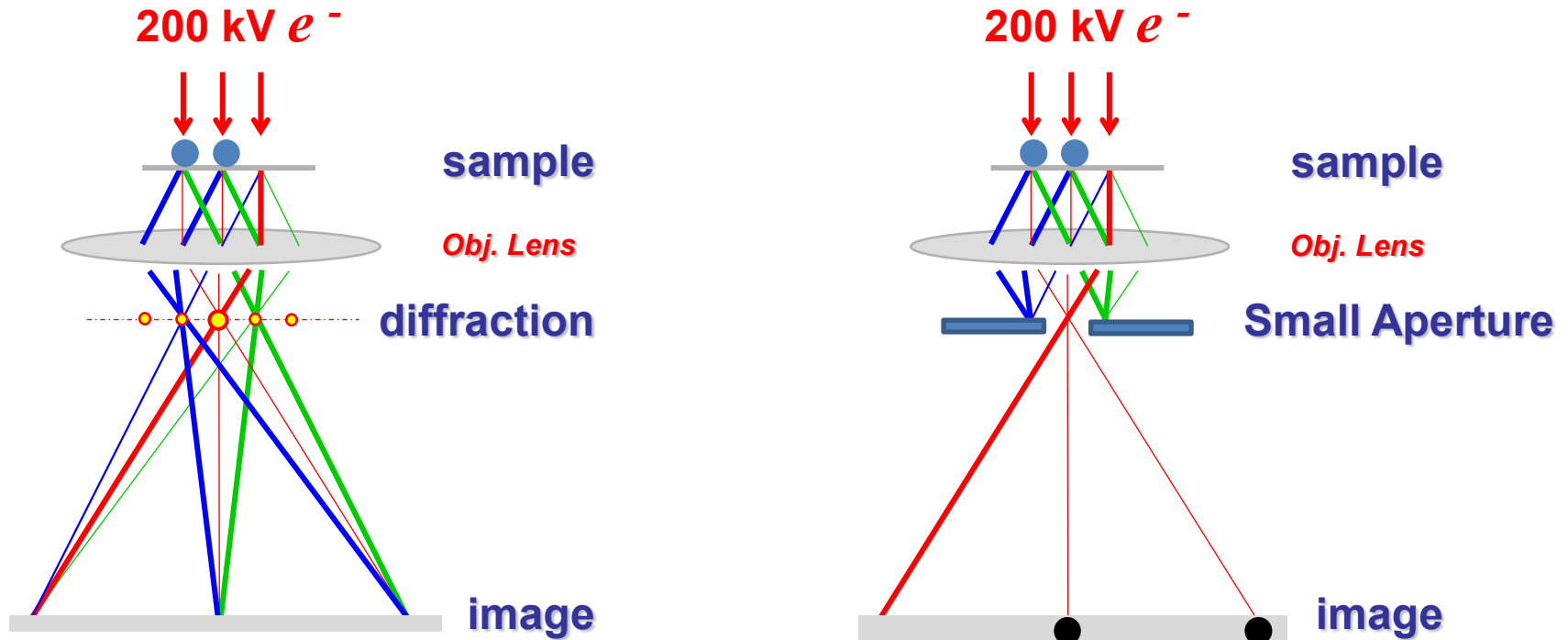

No contrast when *in focus* –
Note that when under/over focus
then there is normally phase
contrast

1) Bright field (BF) image

Contrast: mass-thickness/Diffraction contrast

Typical for soft materials which are **selectively stained**

Or for low resolution imaging of **crystalline materials**

(crystals oriented in the *Bragg angle* are black in the image)

Example 1: Bright field (BF) image from holey carbon film
No objective aperture

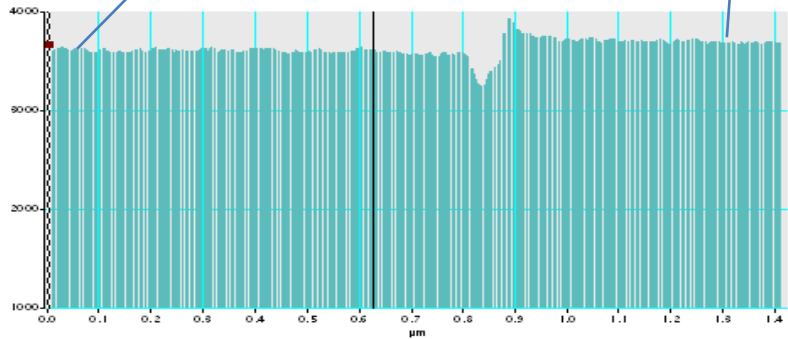
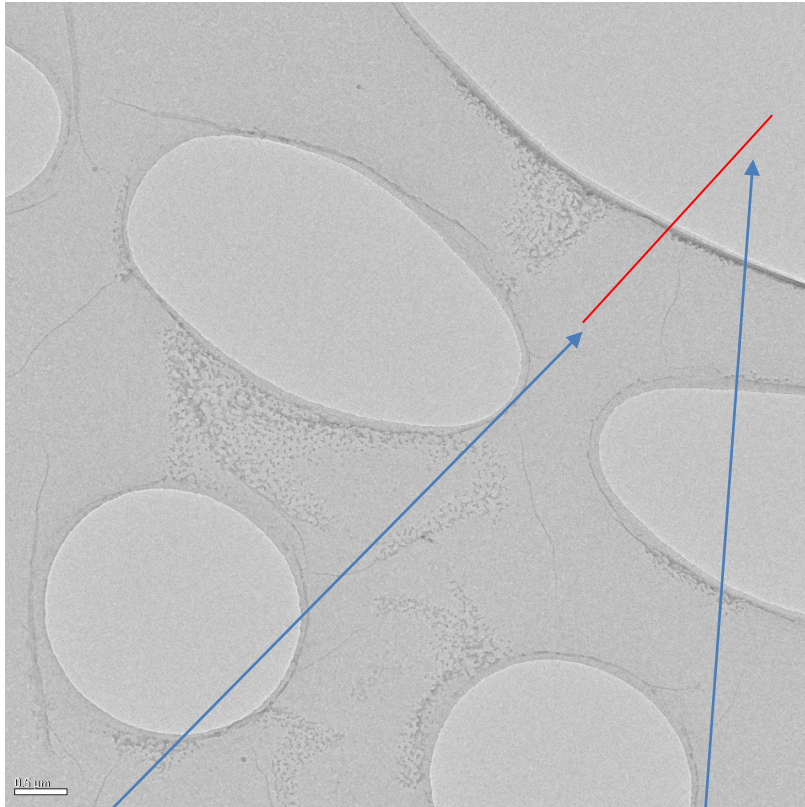

Intensity profile along the line – very small difference between the hole and carbon film

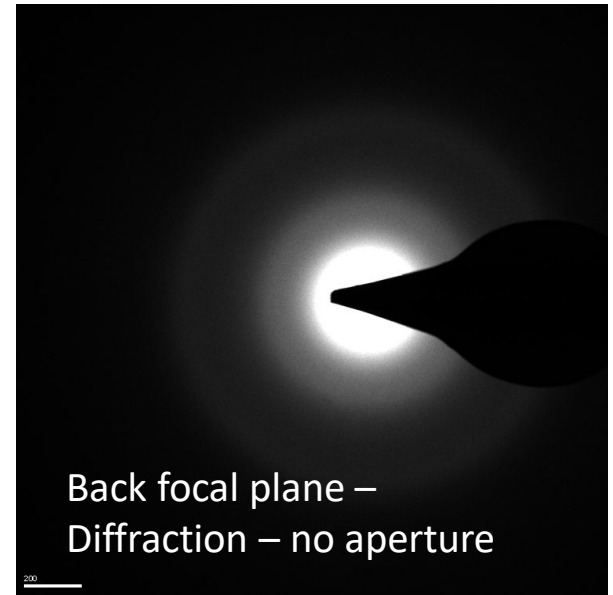

Back focal plane –
Diffraction – no aperture

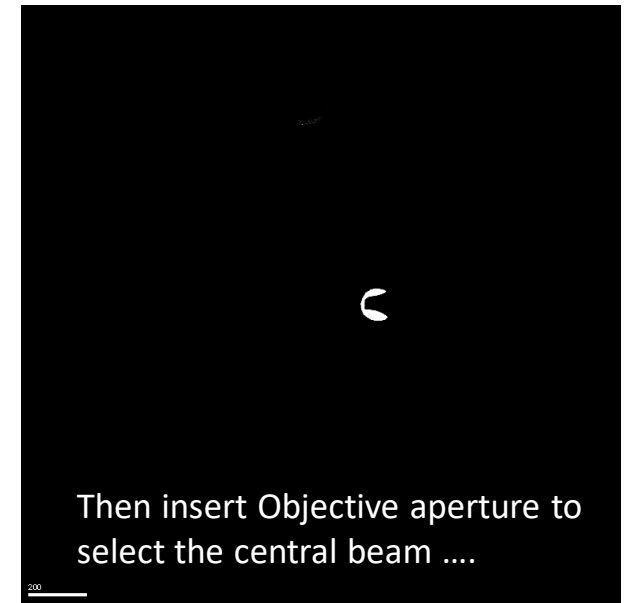

Then insert Objective aperture to
select the central beam

No objective aperture

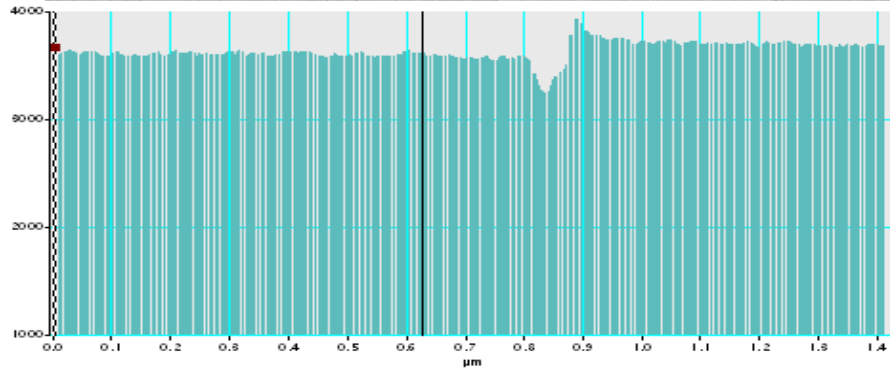
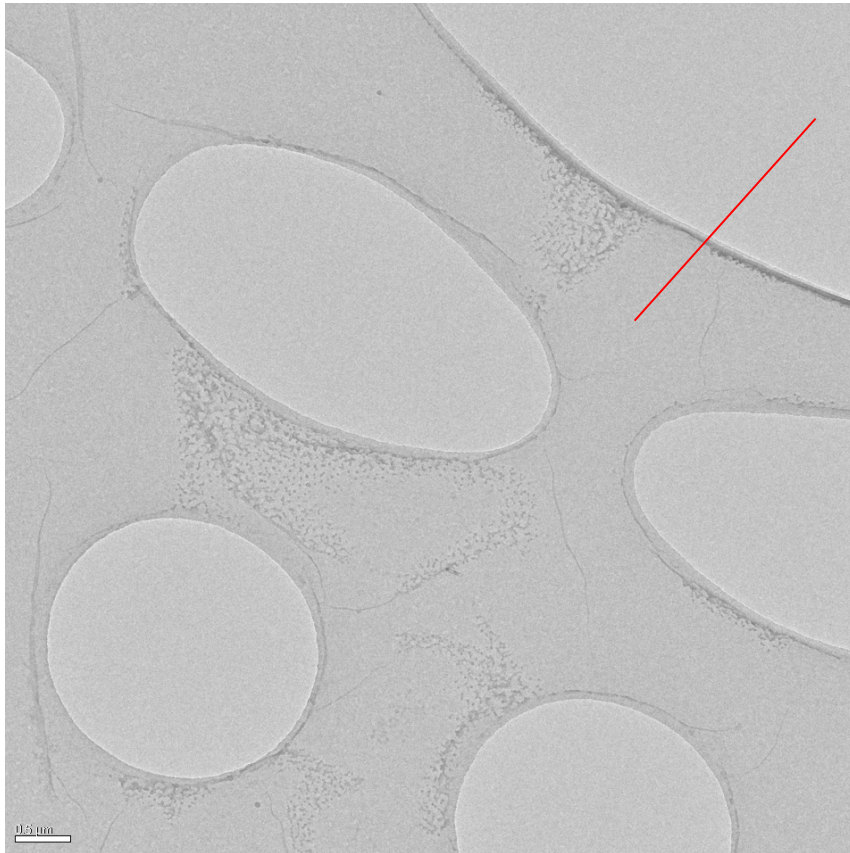

Objective Aperture inserted to select the central direct unscattered beam

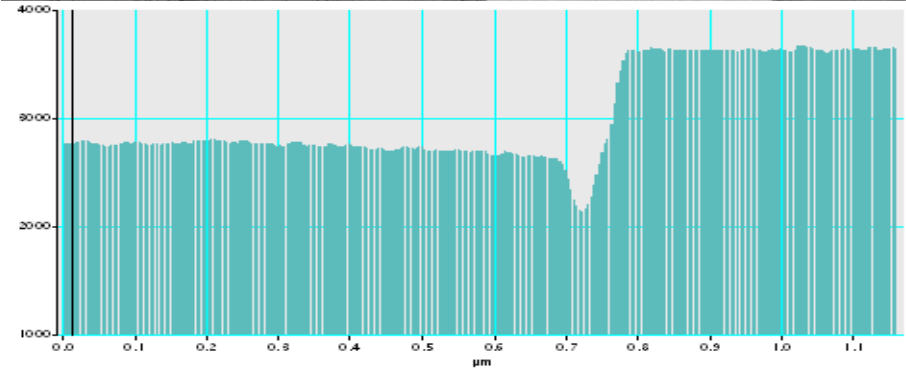
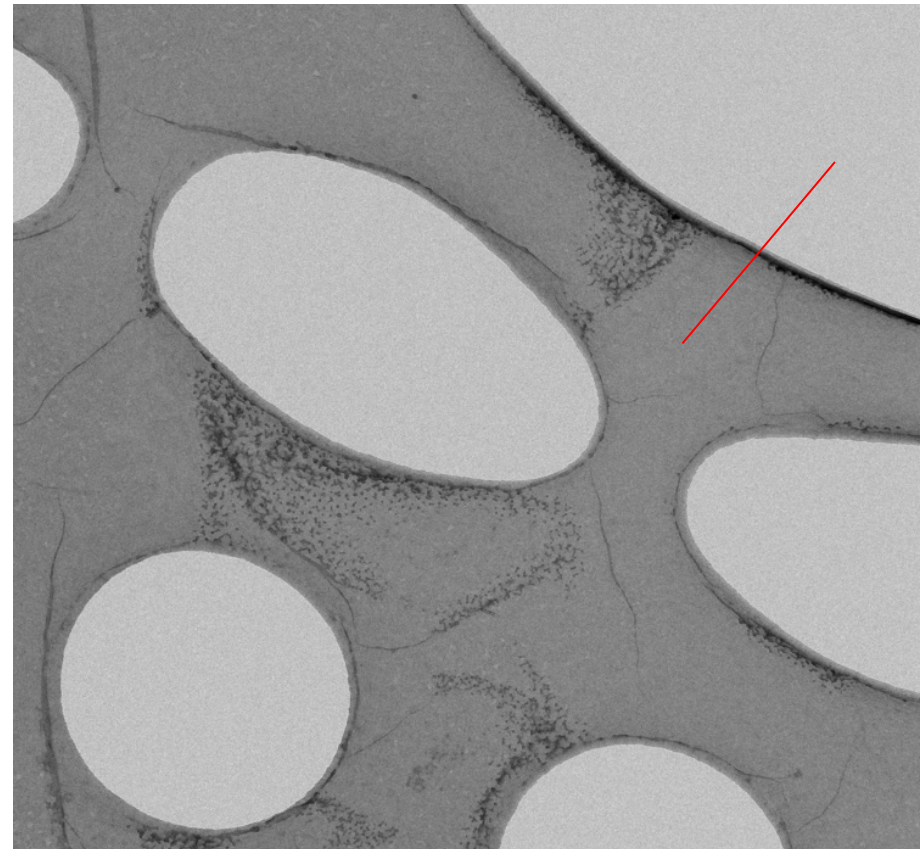

Intensity profile along the line – No we have clear intensity difference between the hole and carbon film

Example 2: Mass-Thickness contrast

Latex particles on a support carbon film

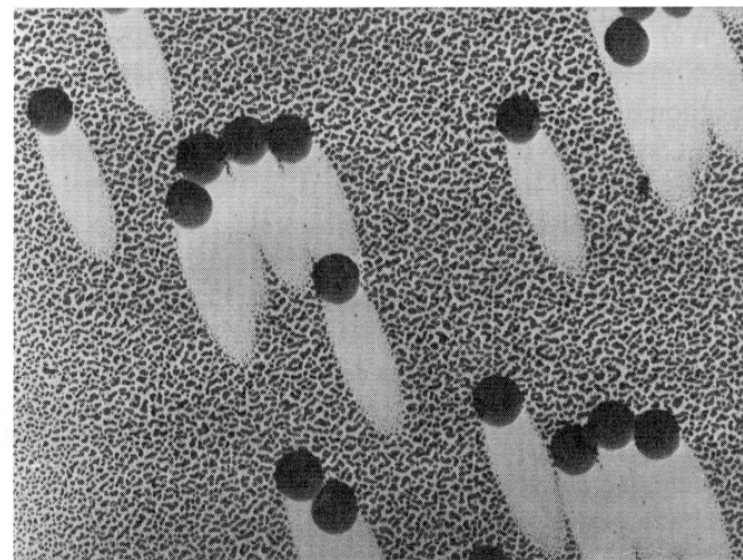
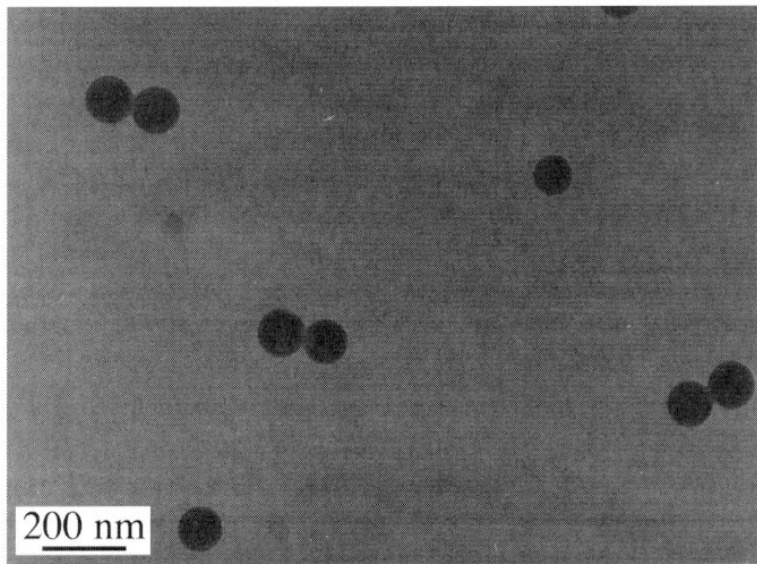
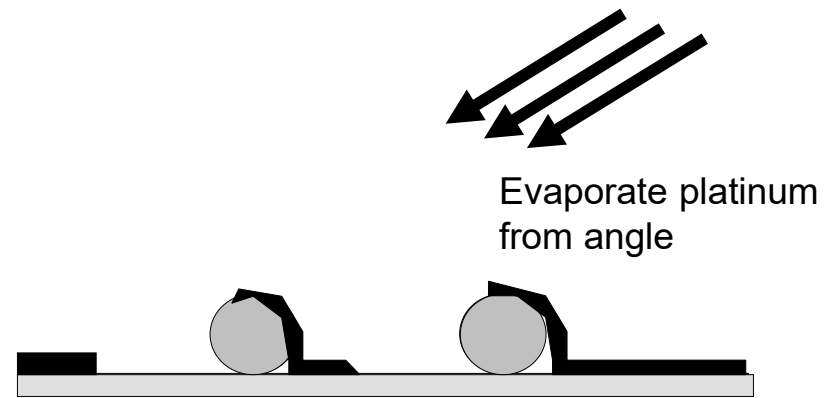
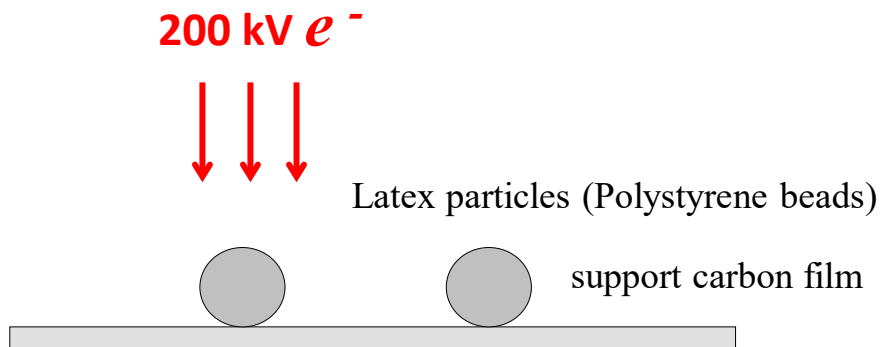

Example 3: Mass-Thickness contrast - Latex particles on a support carbon film and Gold particles

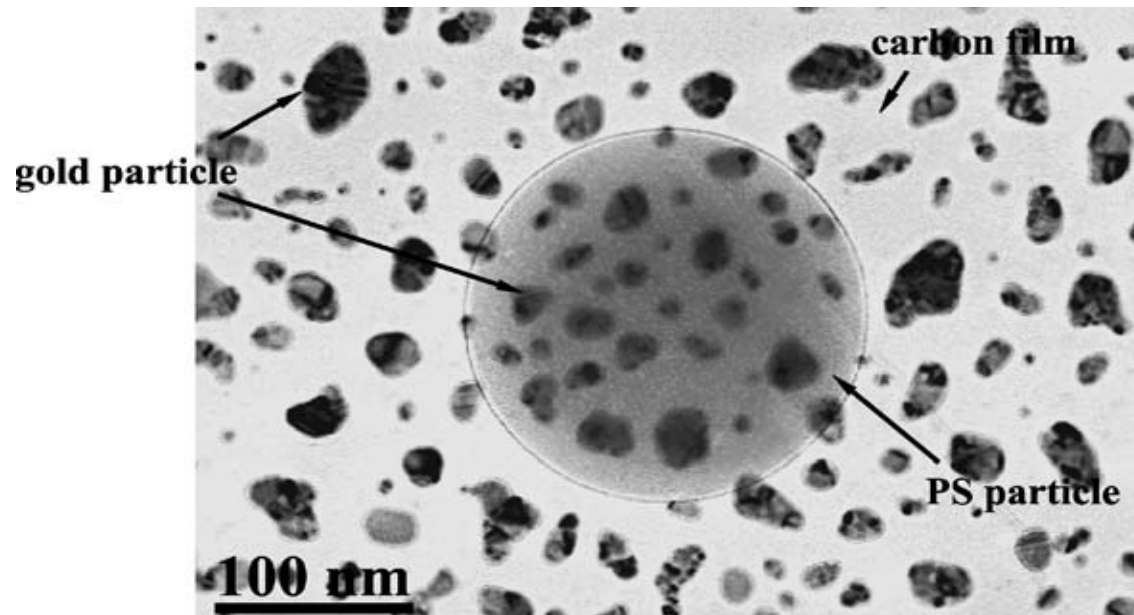
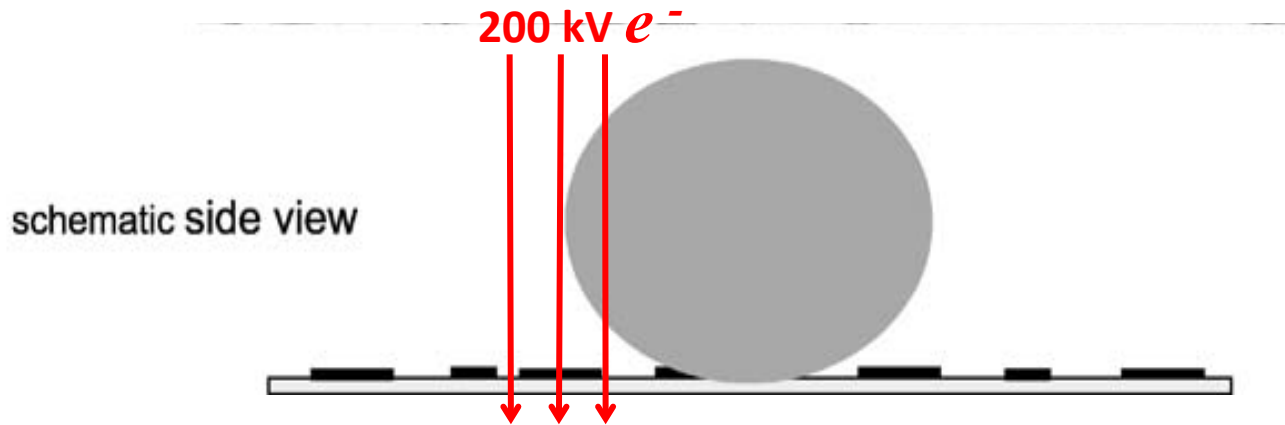

mass-thickness contrast: TEM micrograph of a test specimen with small gold particles and polystyrene latex spheres distributed on a thin carbon support

Image formation and contrast (Dark field)

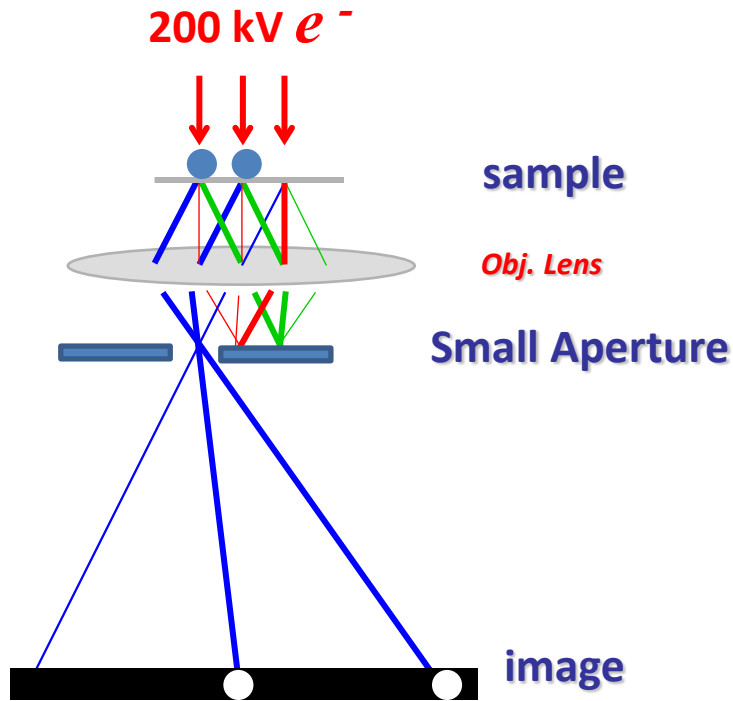

2) Dark field (DF) image

Contrast: Scattering and Diffraction contrast
Areas which scatter more are more bright
in the image

Example: Bright field (BF) vs Dark field (DF)

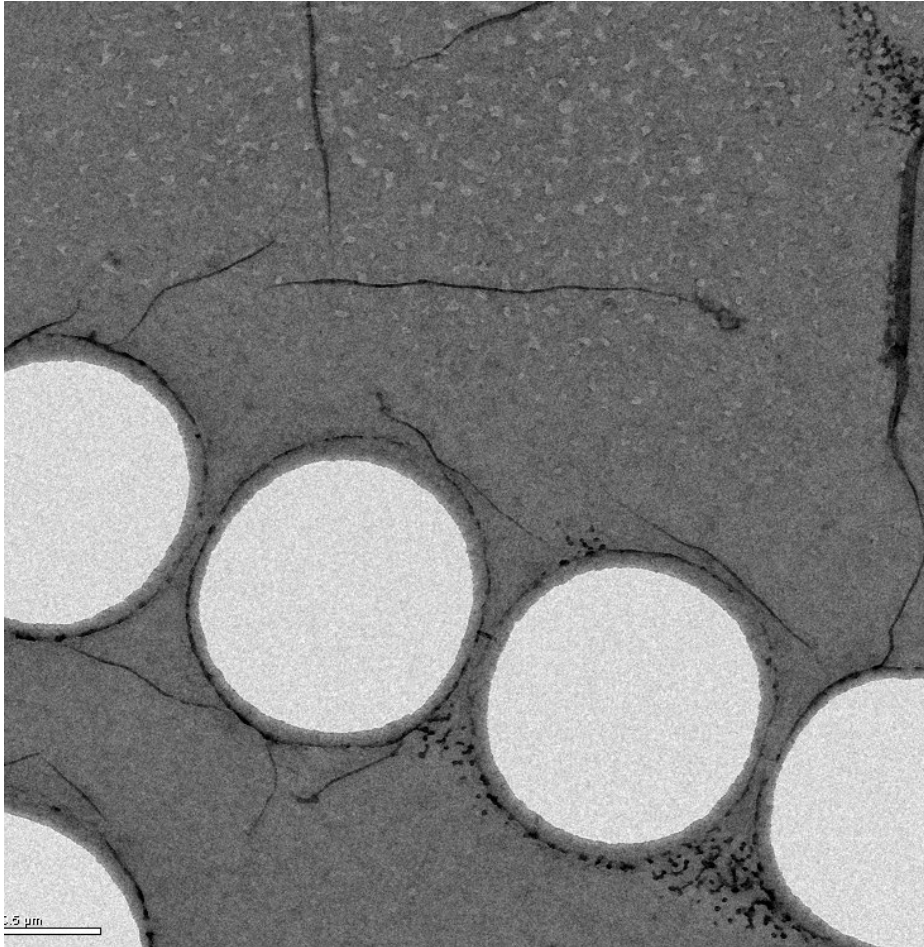

Bright field (BF) image from holey carbon film

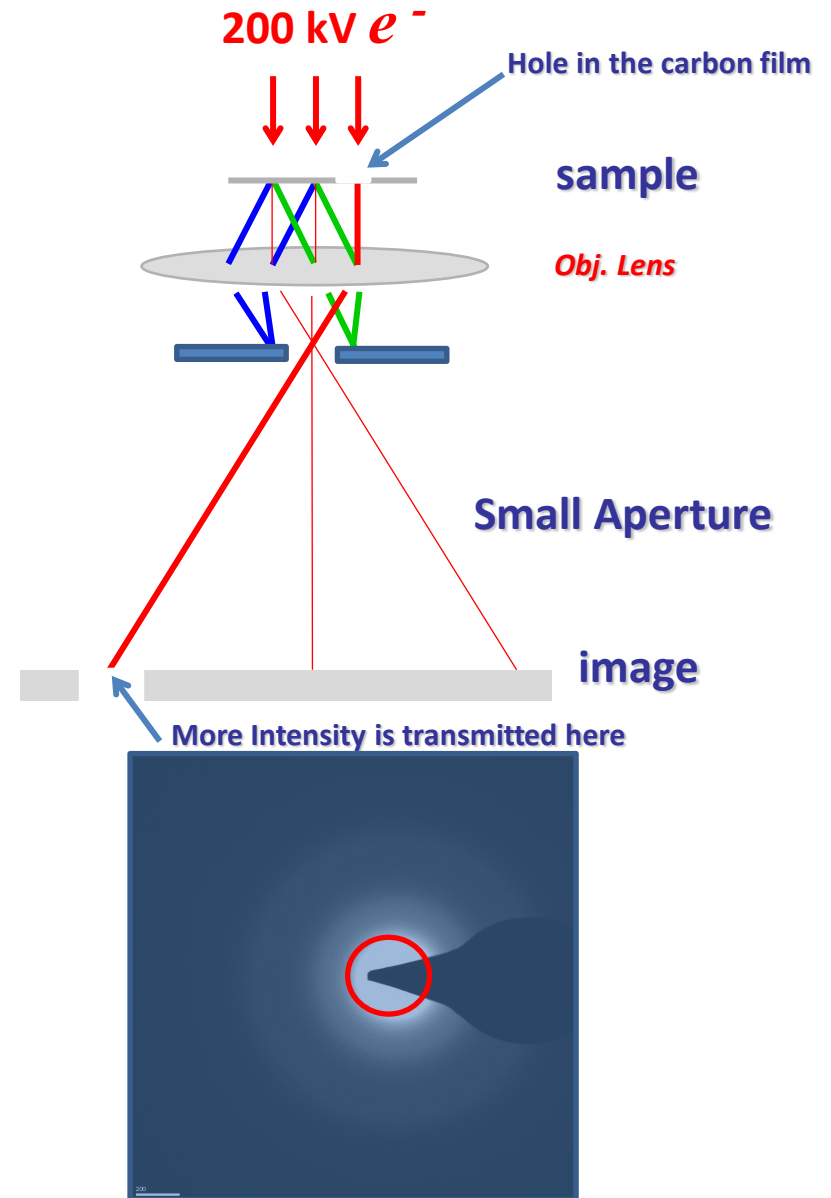

Bright field (BF) vs Dark field (DF)

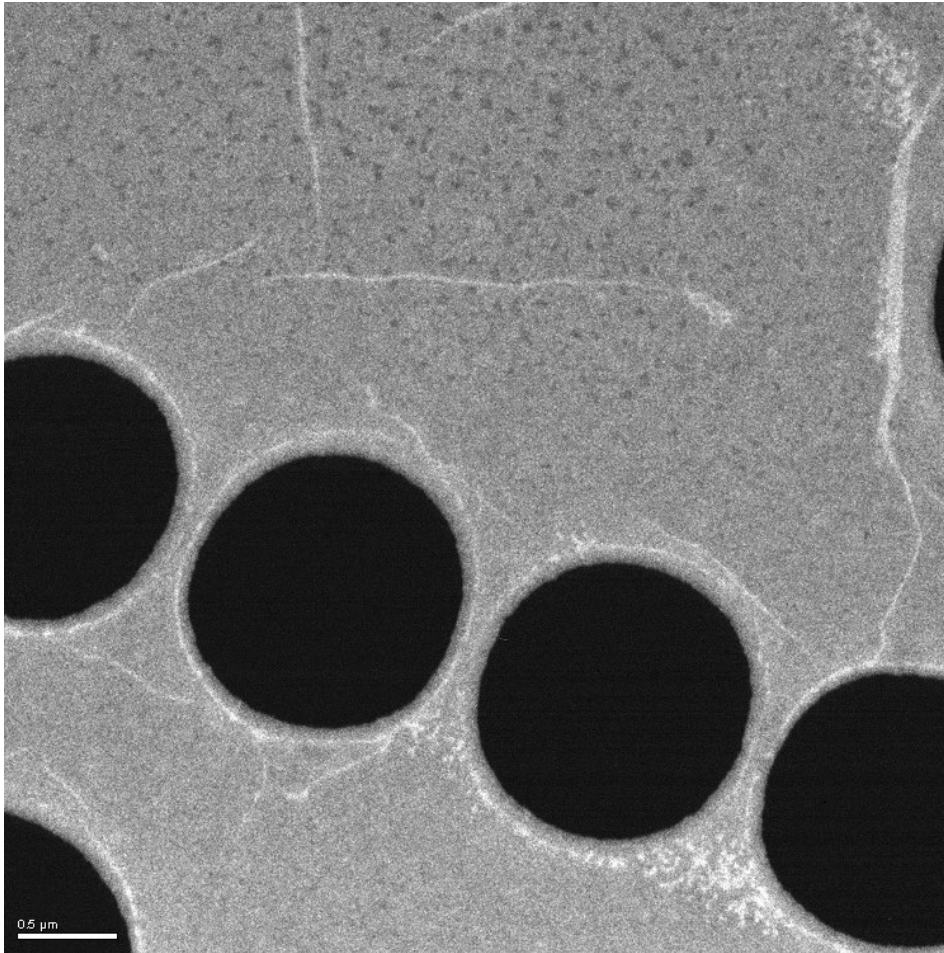

Dark field (DF) image from holey carbon film

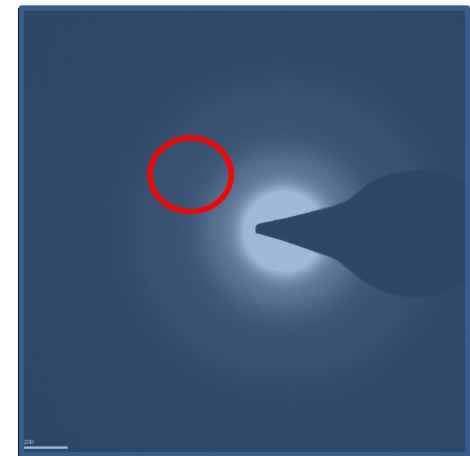
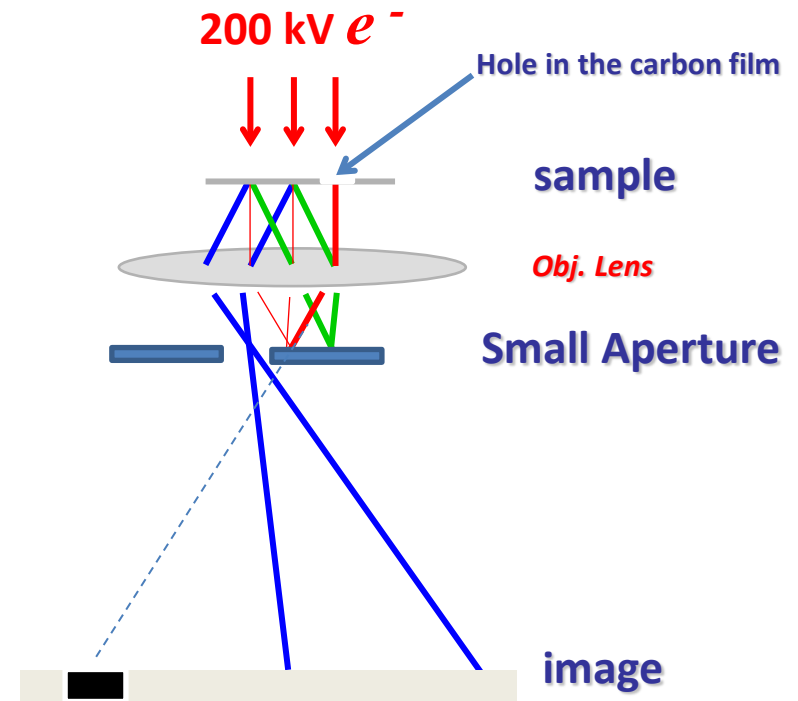

STEM dark field vs. Bright field imaging

In STEM imaging mode e-beam is very focused to form narrow beam

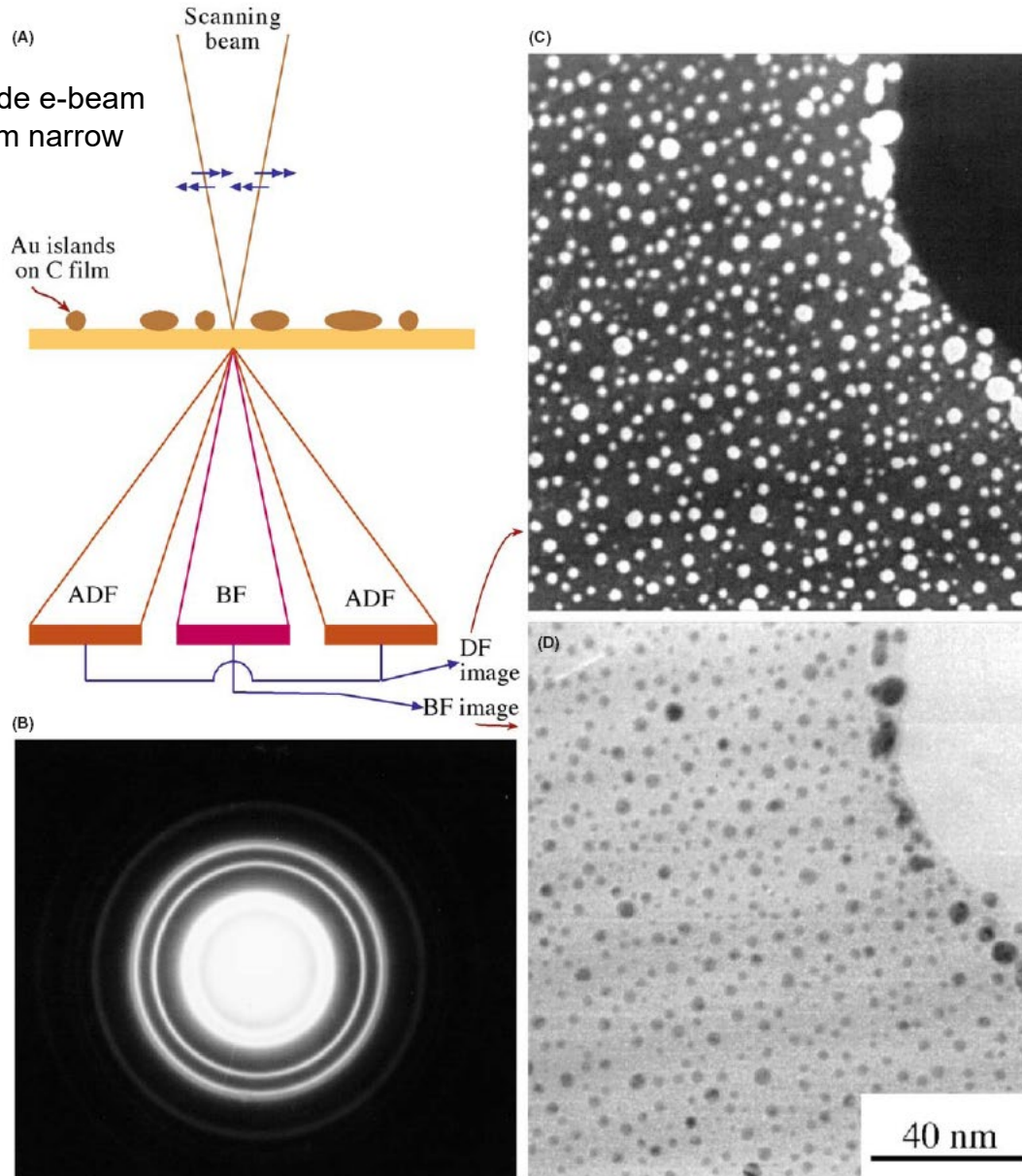
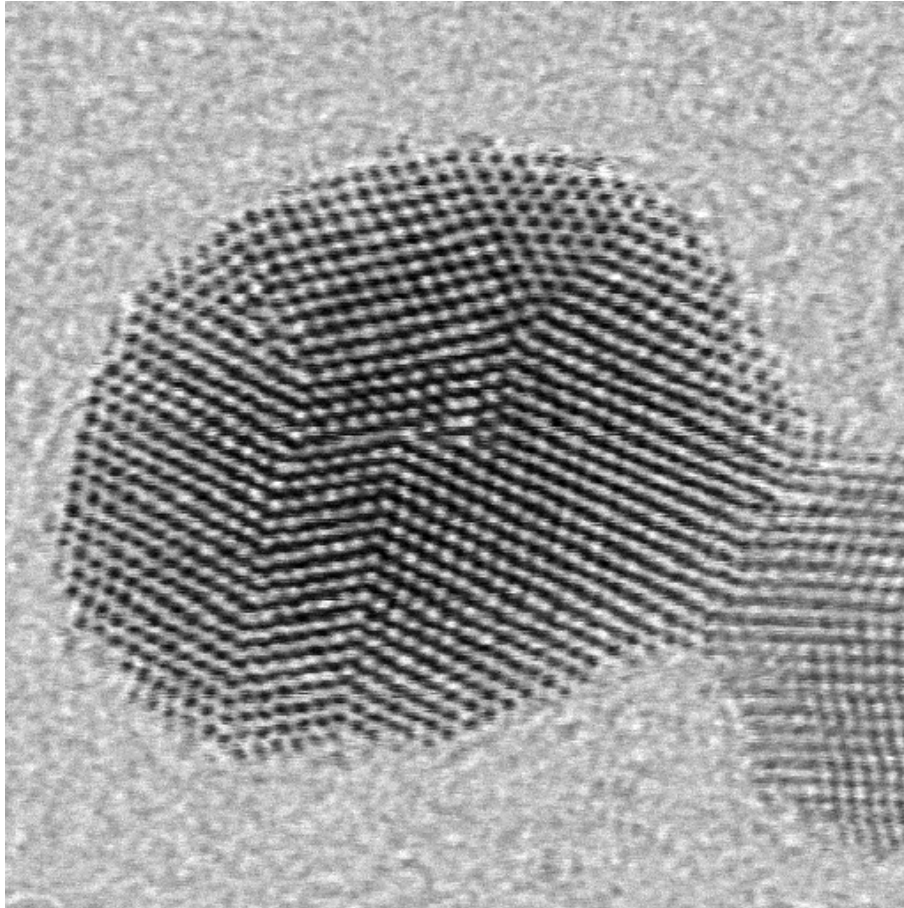
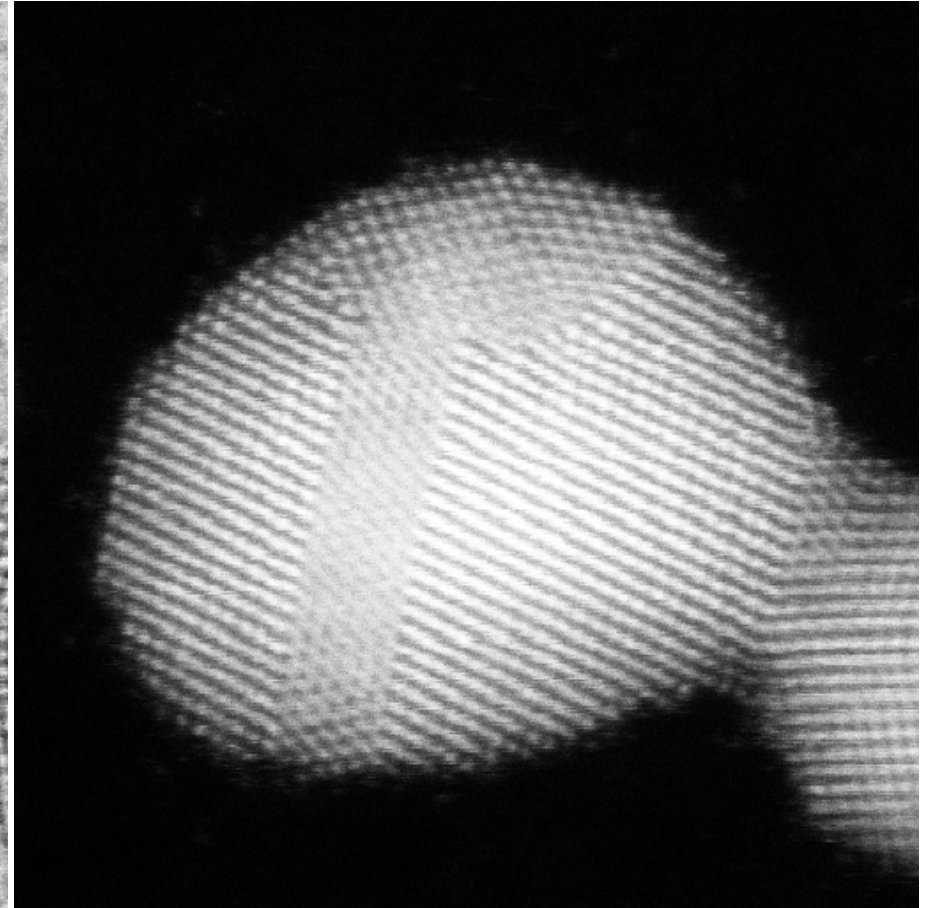

FIGURE 9.19. STEM image formation: A BF detector is placed in a conjugate plane to the BFP to intercept the direct beam (A) and a concentric annular DF detector intercepts the diffracted electrons whose distribution is shown in the SAD pattern in (B). The signals from either detector are amplified and modulate the STEM computer display. The specimen (Au islands on a C film) gives complementary ADF (C) and BF (D) images.

Cs-corrected STEM image of Au particles BF vs. DF



Bright-field image – Atom columns are “dark” since they scatter more.. And we get less signal to bright field detector



Dark-field image Atom columns are white since due to scattering there is more signal in Dark field detector

Contrast in TEM

Contrast definition:
$$C = \frac{(I_1 - I_2)}{I_2} = \frac{\Delta I}{I_2}$$

Main contrast mechanism in TEM

1. Mass-thickness, 2. Diffraction, 3. Phase contrast

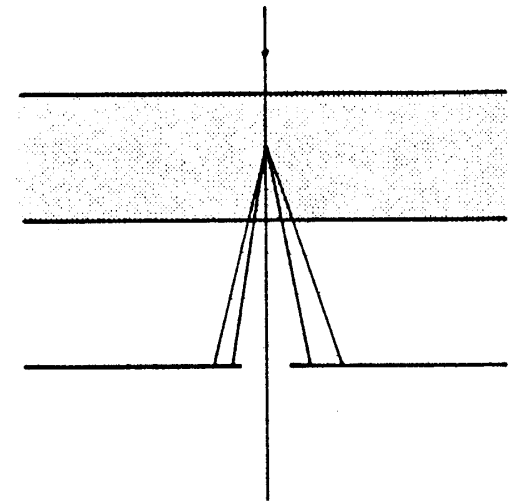
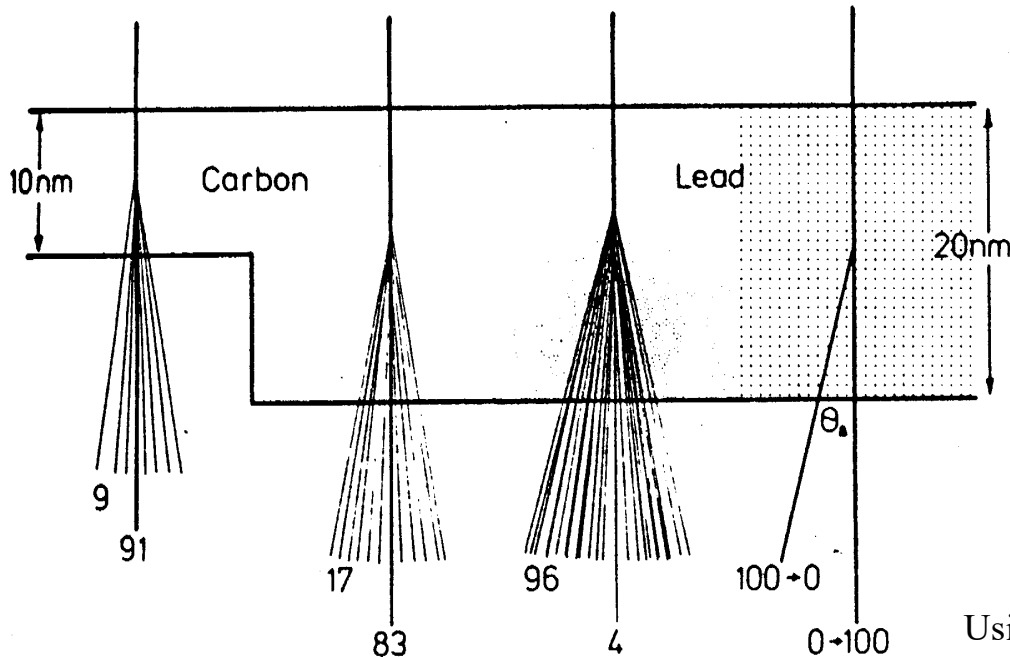
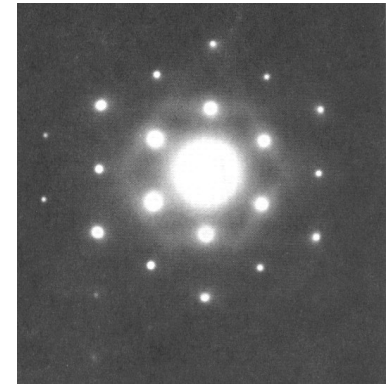

Using objective aperture we can block the scattering signal and get mass-thickness contrast. Or for crystalline materials we can select different beams (central beam or diffracted beams)

Mass-thickness contrast:

More thickness, or density, or higher atomic number (high Z-elements) → More scattering and more contrast

Diffraction contrast:

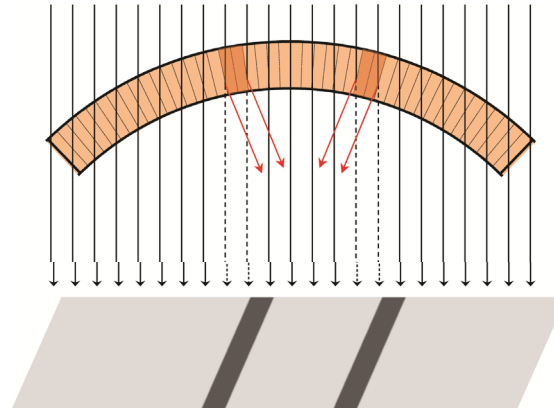
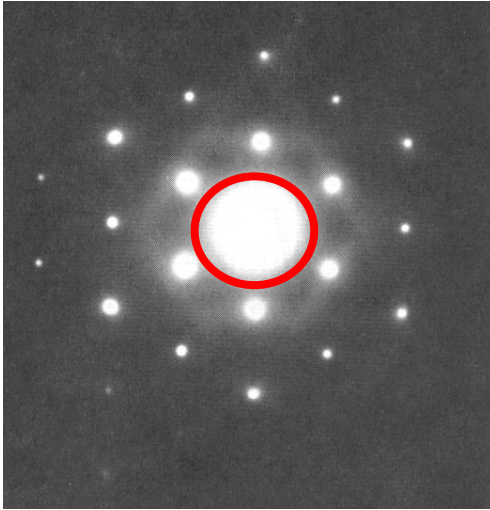

If crystalline sample is bent. Under parallel beam illumination condition, in certain areas the Bragg diffraction conditions are satisfied, yielding strong diffraction beams in these areas. Therefore, in the BF image using direct beam only, these areas appear as dark fringes.

If we select the central beam (Bright field mode) – then all the crystals which are in the Bragg angle orientation will be dark...

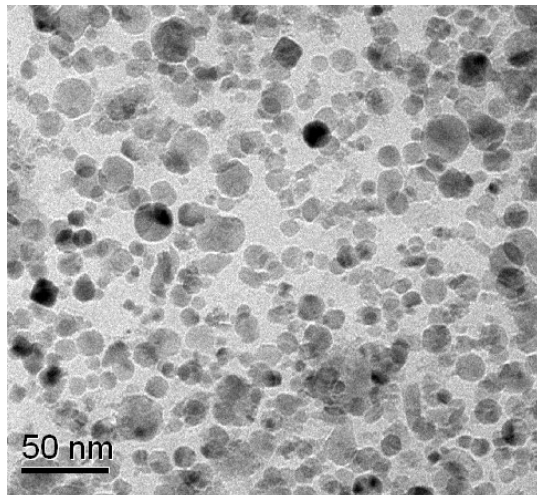

Crystalline nanoparticles – particles which are Bragg orientation respect to the beam are black

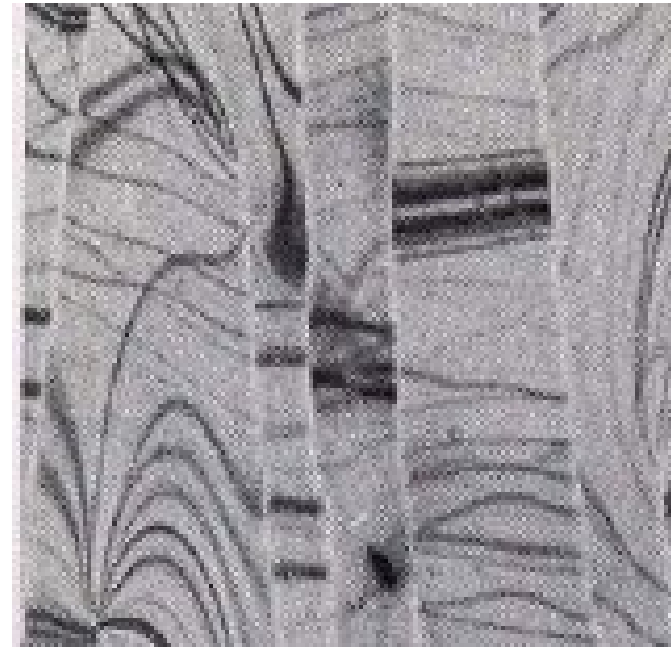

Hexagonal ice crystals

3. Phase contrast

Intensity depends also from the electron wave phase:

The incident beam can be described as a wave of amplitude ψ_0 and phase $2\pi kr$

$$\psi = \psi_0 e^{2\pi i kr} \quad [3.11]$$

For the phase contrast we need (in the image) two electron beams with different phases to form the image:

Typically

- 1) Non scattered electrons
- 2) Scattered (diffracted) electrons

Similar principle in phase contrast Optical microscope:

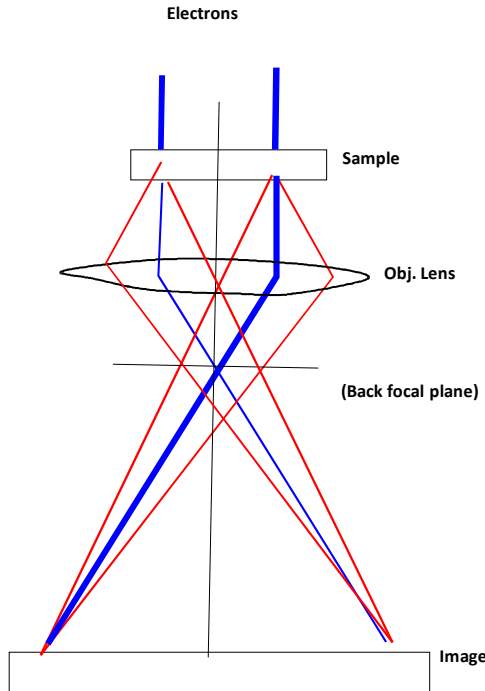

Phase Contrast Microscope Optical Train

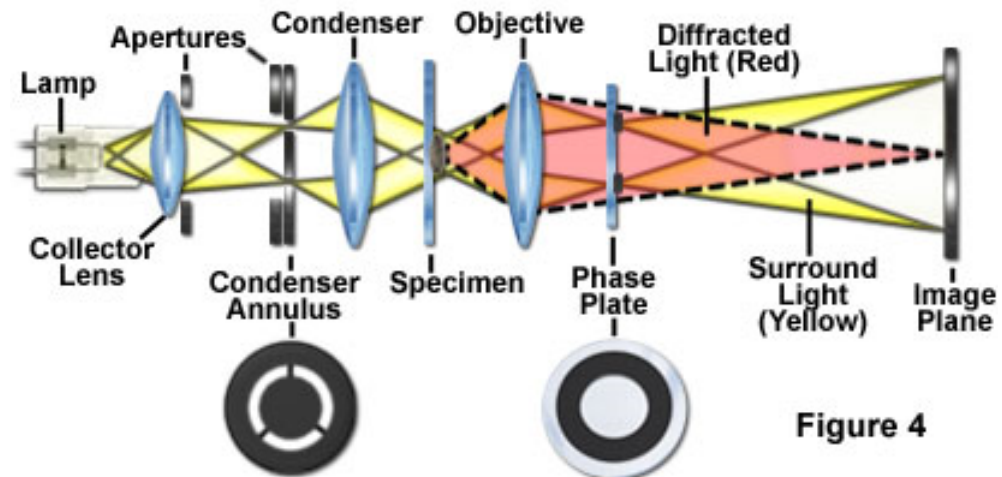
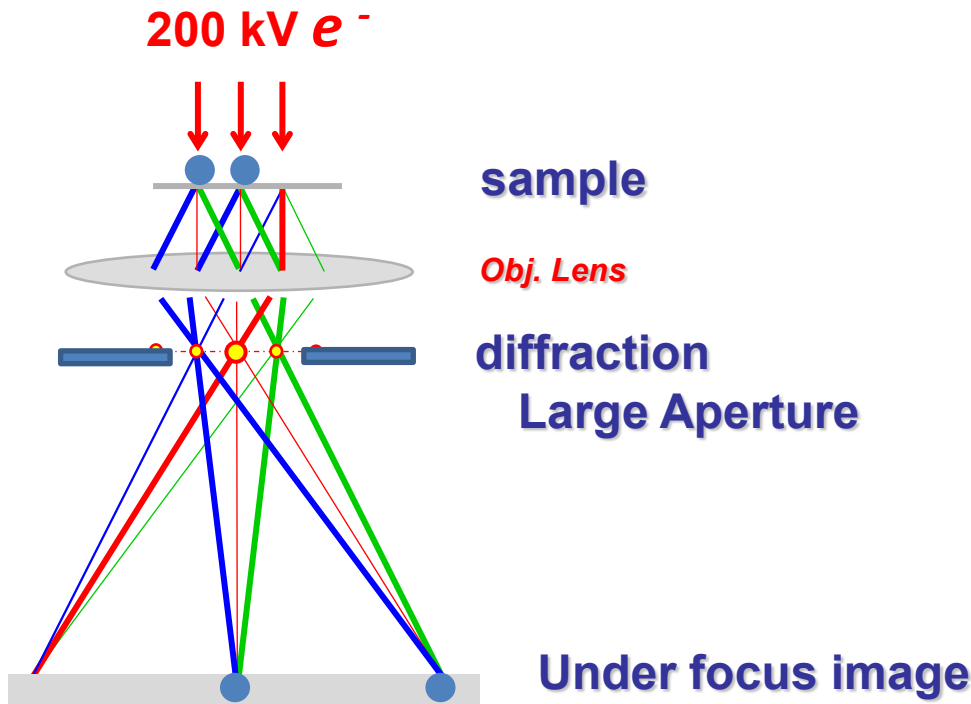

Figure 4

Image formation and contrast: Phase Contrast



3) High resolution lattice imaging: *Phase contrast*

No contrast when *in focus* –

But when under focusing there is a phase shift in diffracted beams – therefore lattice image can be obtained

In reality: mass-thickness and phase contrast mechanism are present at the same time – especially for typical polymer nanostructures, which are quite large (1nm to 100 nm) and diffraction angle is proportional to $\sim 1/\text{size}$, therefore diffracted beams are so close to the direct beam that even the smallest aperture allows them to pass into image and contribute to the phase contrast

3. Phase contrast

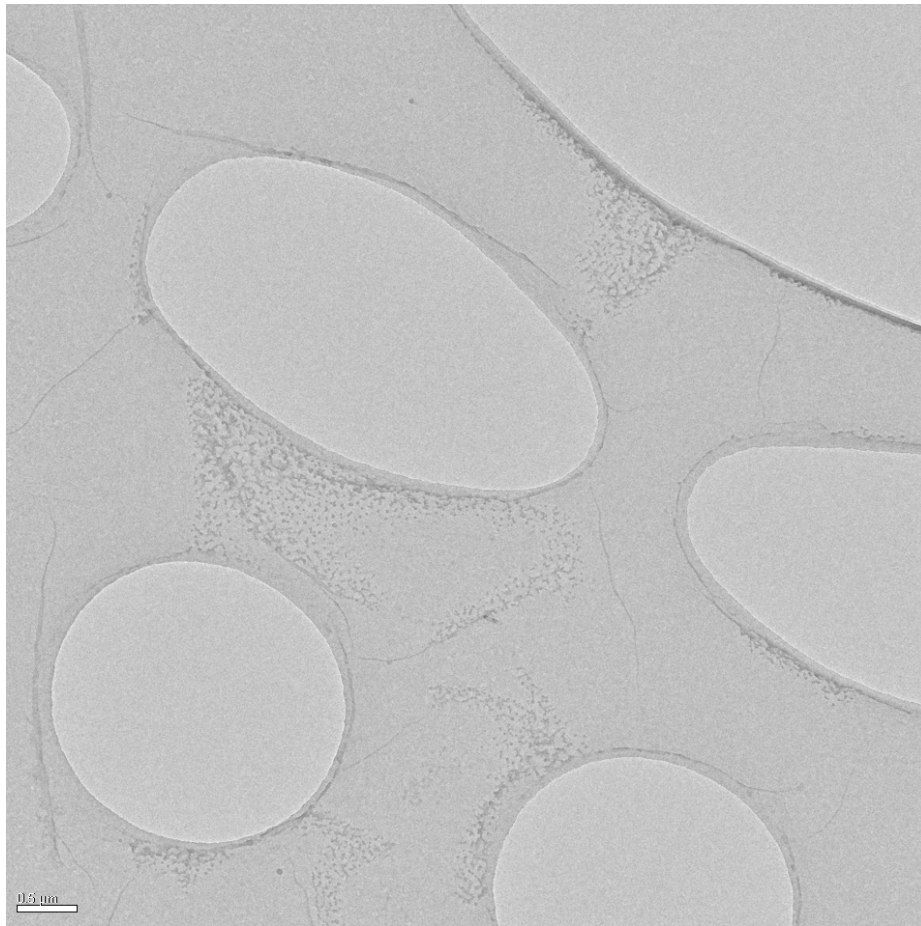

No objective aperture and in-focus

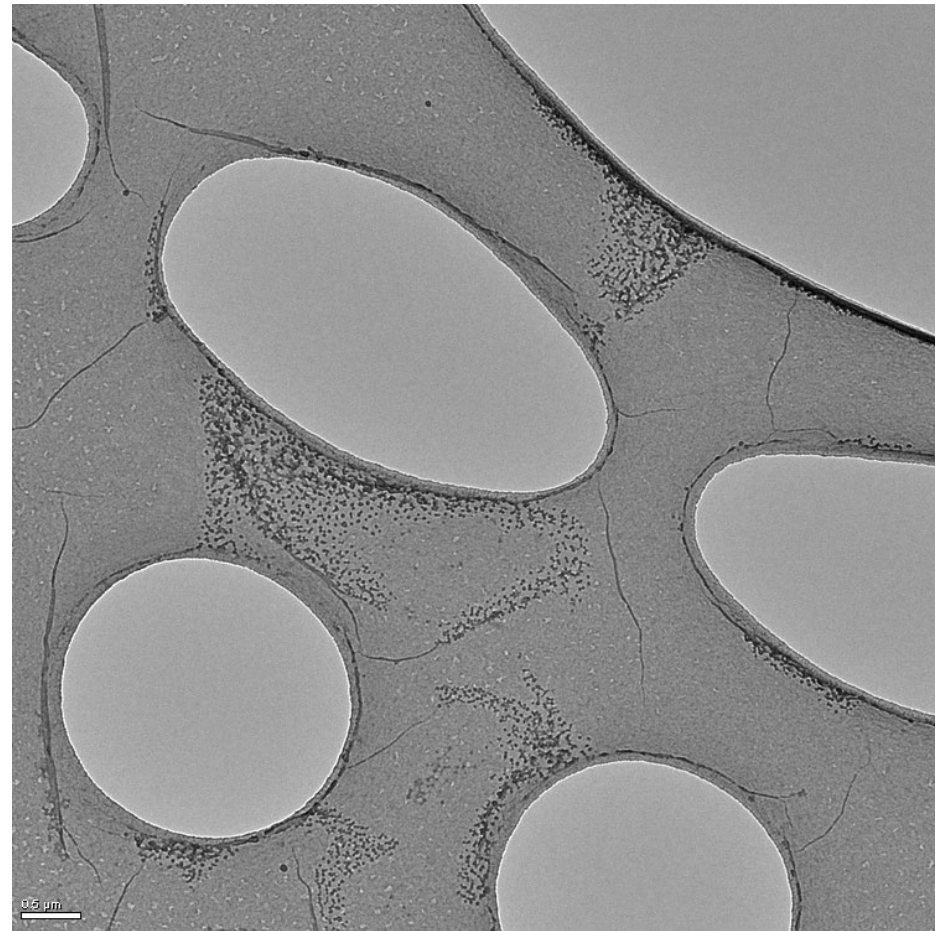

No objective aperture and under focus

Example (phase contrast): Polymer-amphiphile nanostructures

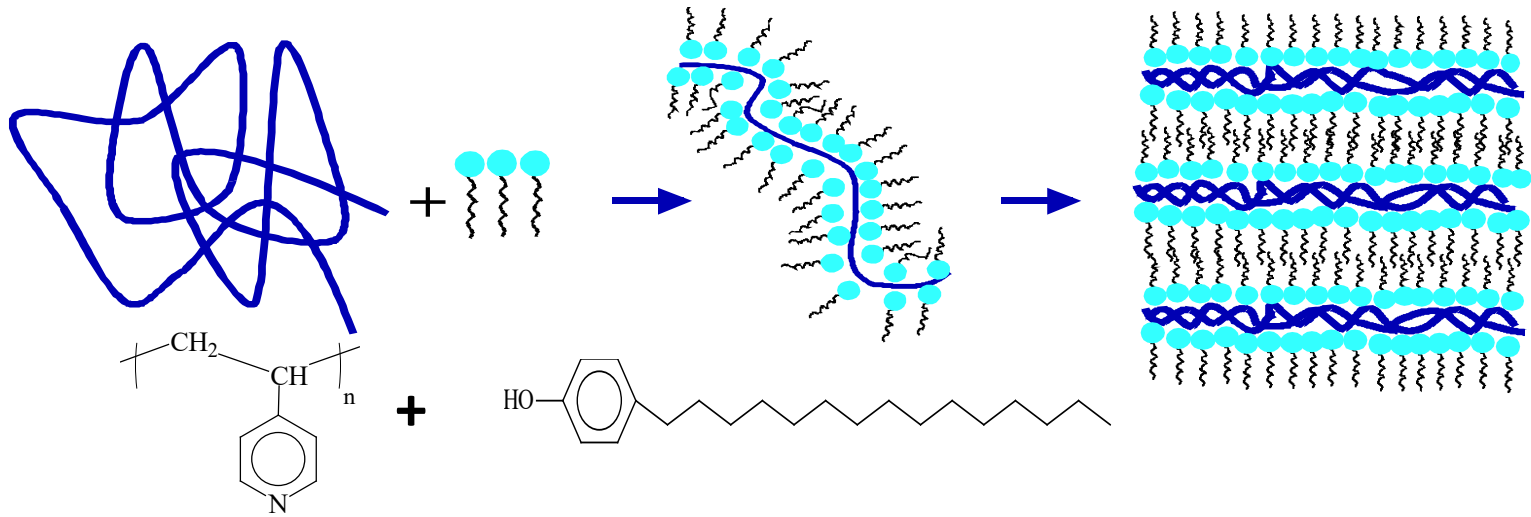

300 nm

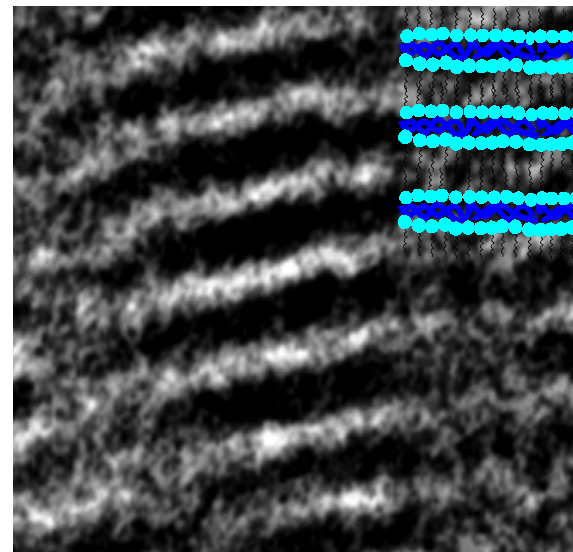

30 nm

Image formation and contrast: Phase Contrast

Real TEM Image

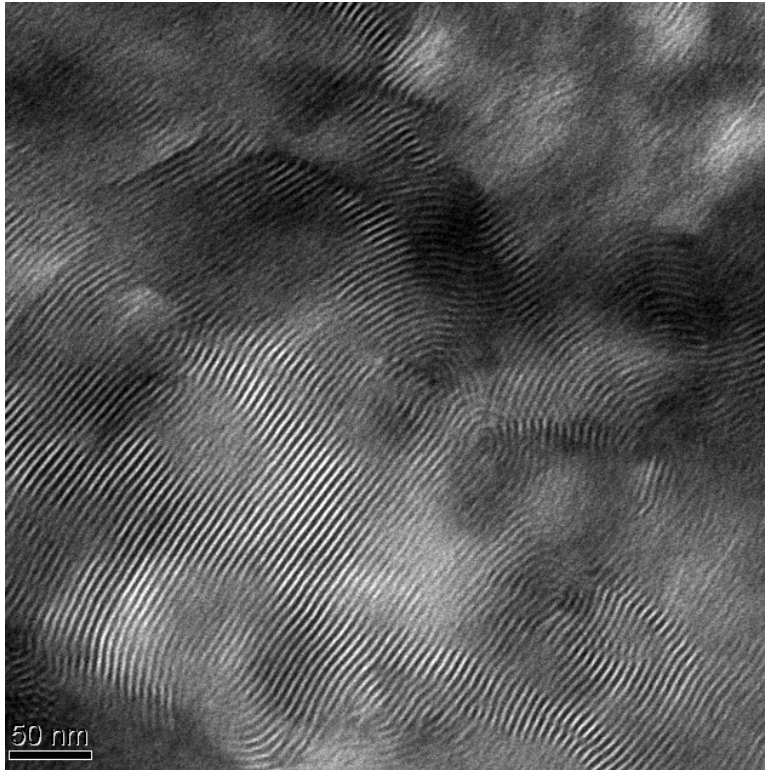

FFT from TEM Image or Diffraction would look the same

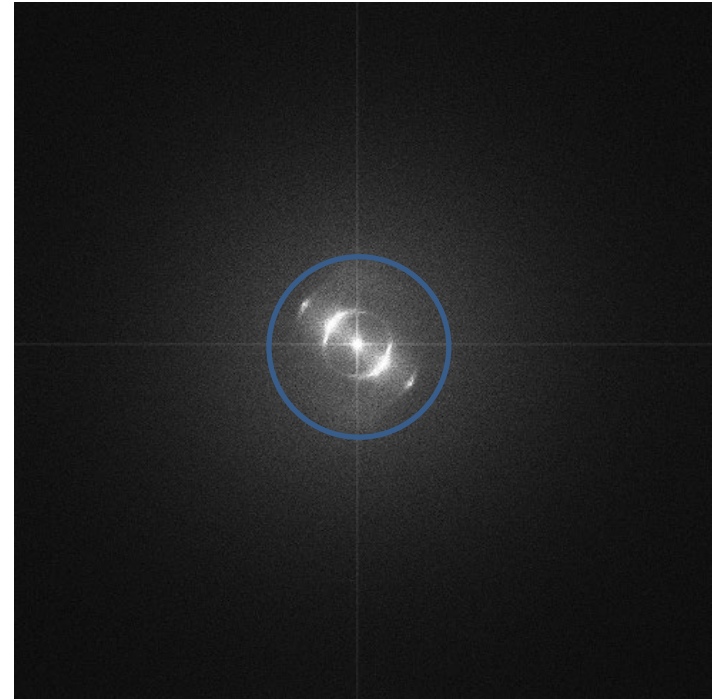

For the **phase contrast imaging** – we would like to have aperture so that also diffracted beams contribute the image - and then **defocusing the Objective lens** to get optimum contrast

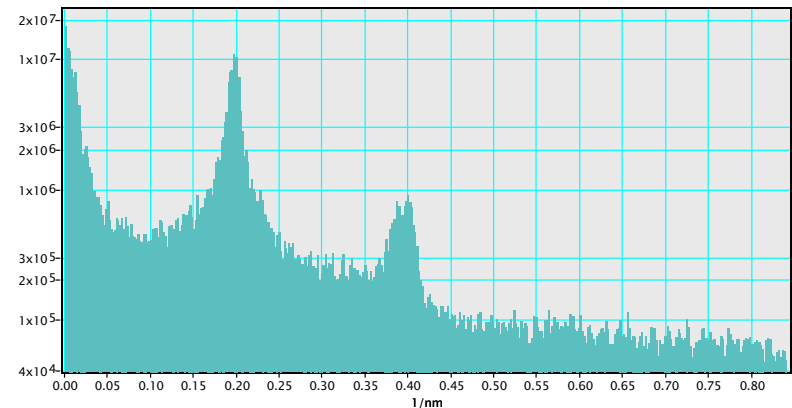

1D Intergrated intensity from FFT

Example: Phase contrast

Sample: Poly(4-vinylpyridin)+nonadekylfenol, I_2 staining

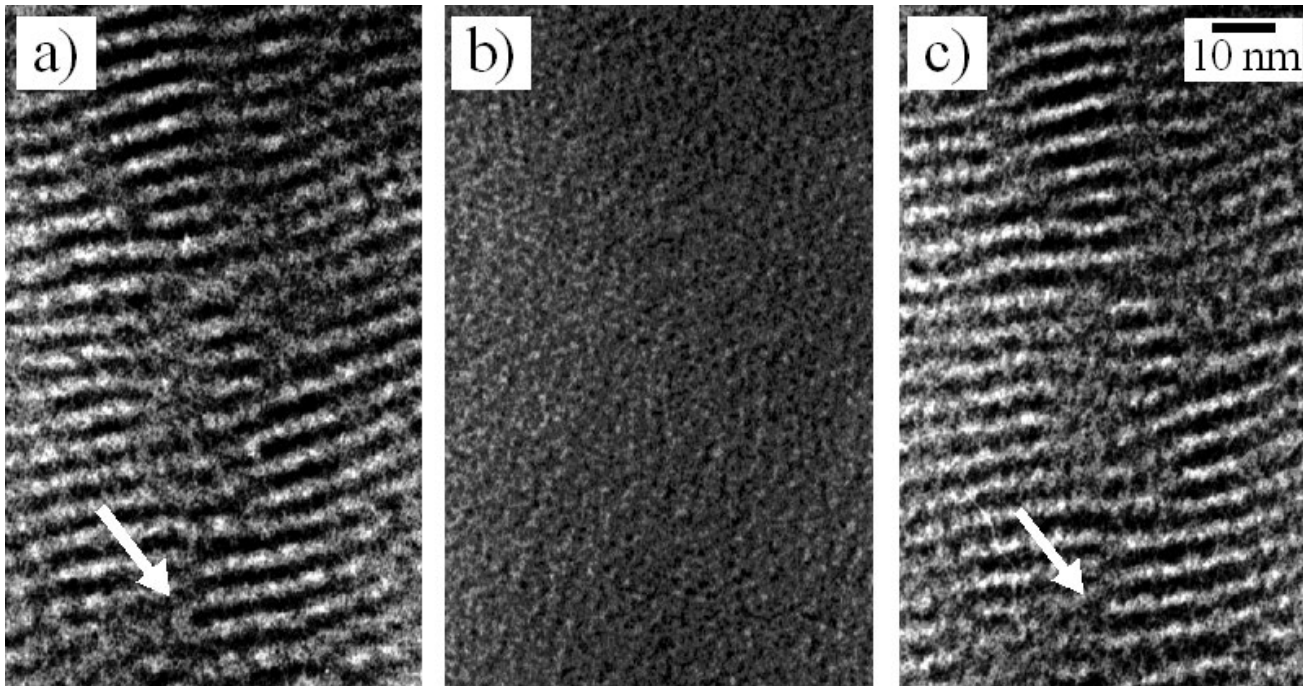

“under focus”

“in focus”

“over focus”

Resolution

Classical Rayleigh criteria for optical microscope: The smallest distance between two points which can be resolved is

$$\delta = \frac{0.61 * \lambda}{\mu \sin \beta}$$

For light microscope::

$$\mu \sin \beta \approx 1$$

(= numerical aperture)

visible light 400 - 700 nm

⇒ **Resoluutio** $\delta \approx 300 \text{ nm}$

TEM: $\mu \approx 1$ (vacuum)

$$\Rightarrow \delta = \frac{0.61 * \lambda}{\sin \beta} \quad \beta \text{ small} \Rightarrow \sim \frac{0.61 * \lambda}{\beta}$$

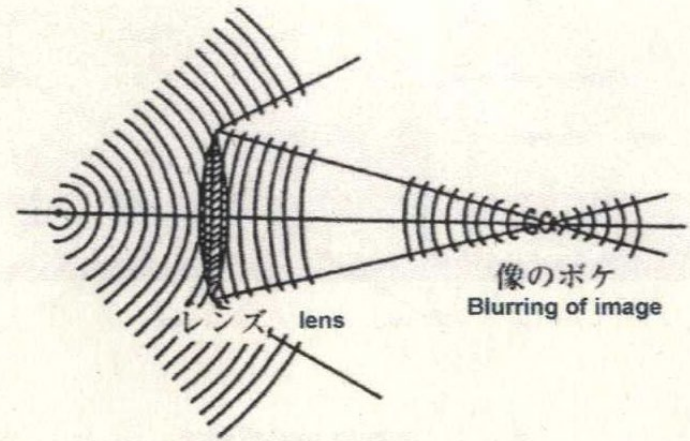

Diffraction limited in an optical lens

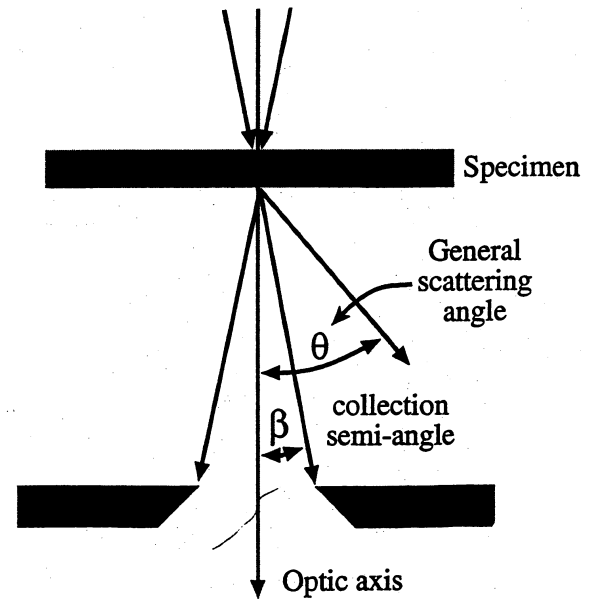

Figure 2.10. Definition of the major semiangles in TEM. Any incidence/convergence semiangle of the beam is termed α ; any collection semiangle is β and general scattering semiangles are θ .

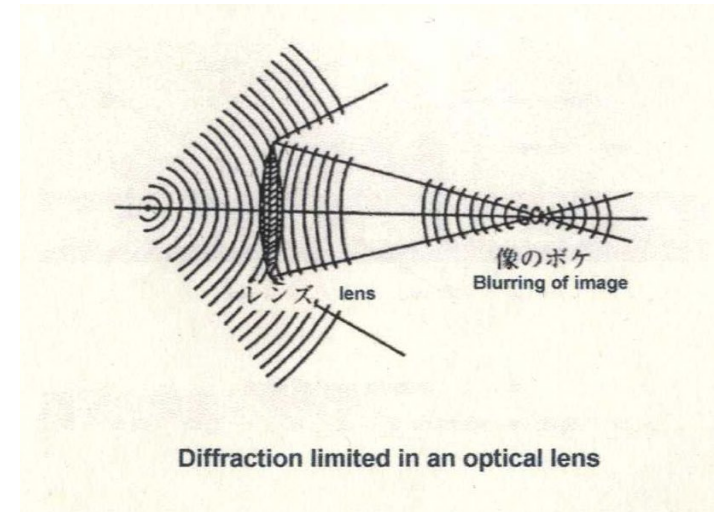
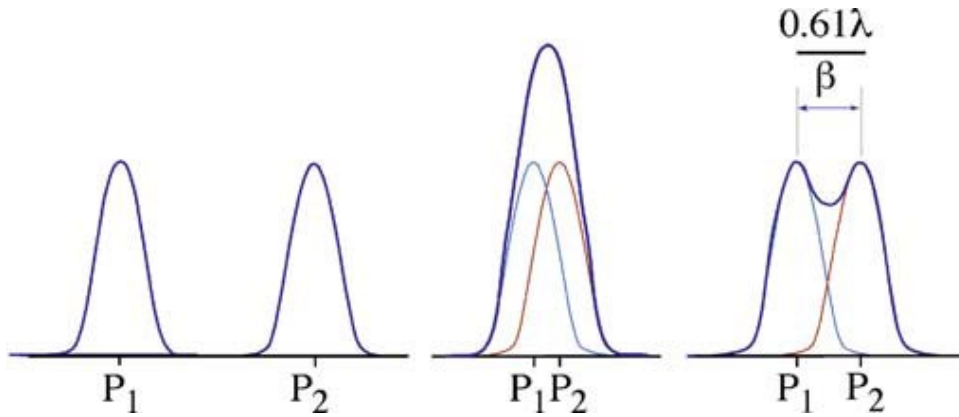

FIGURE 6.14. (A) The Airy-disk intensity profiles from two clearly separated point sources P_1 and P_2 . In (B) the two Airy disks are so close that they cannot be distinguished, but in (C) the two are separated **such that the maximum in the image of P_1 overlaps the minimum in P_2** . This latter situation **is the definition of resolution defined by the Rayleigh criterion** and is the best (diffraction-limited) resolution.

$$\delta = \frac{0.61 * \lambda}{\mu \sin \beta}$$

Electron wavelength?

De Broglie: (Electron wave-particle duality)

And relation between electron wavelength and acceleration voltage:

$$\lambda = \frac{h}{(2m_0eV)^{1/2}}, \quad \text{Nonrelativistic,} \quad \lambda = \frac{h}{\left[2m_0eV\left(1 + \frac{eV}{2m_0c^2}\right)\right]^{1/2}}, \quad \text{Relativistic}$$

Table 1.2. Electron Properties as a Function of Accelerating Voltage

Accelerating voltage (kV)	Nonrelativistic wavelength (nm)	Relativistic wavelength (nm)	Mass ($\times m_0$)	Velocity ($\times 10^8$ m/s)
100	0.00386	0.00370	1.196	1.644
120	0.00352	0.00335	1.235	1.759
200	0.00273	0.00251	1.391	2.086
300	0.00223	0.00197	1.587	2.330
400	0.00193	0.00164	1.783	2.484
1000	0.00122	0.00087	2.957	2.823

Resolution $\delta = \frac{0.61 * \lambda}{\sin \beta}$ but in practice lens aberrations limits the point-to-point resolution about 0.2 nm (lattice resolution 0.1 nm)

Note: new spherical aberration corrected TEM's resolution is already < 0.1 nm

Lens aberrations:

1. Spherical aberration

The electrons which are farther away from the lens center are bent more (focused more) than the electrons traveling near the lens center.

→ point object is seen as a disk

$$r_{sph} \sim C_s \beta^3$$

CONFUSION

Beware when reading about TEM image resolution because of the confusion between the definition that refers to the Gaussian image plane and that referring to the plane of least confusion.

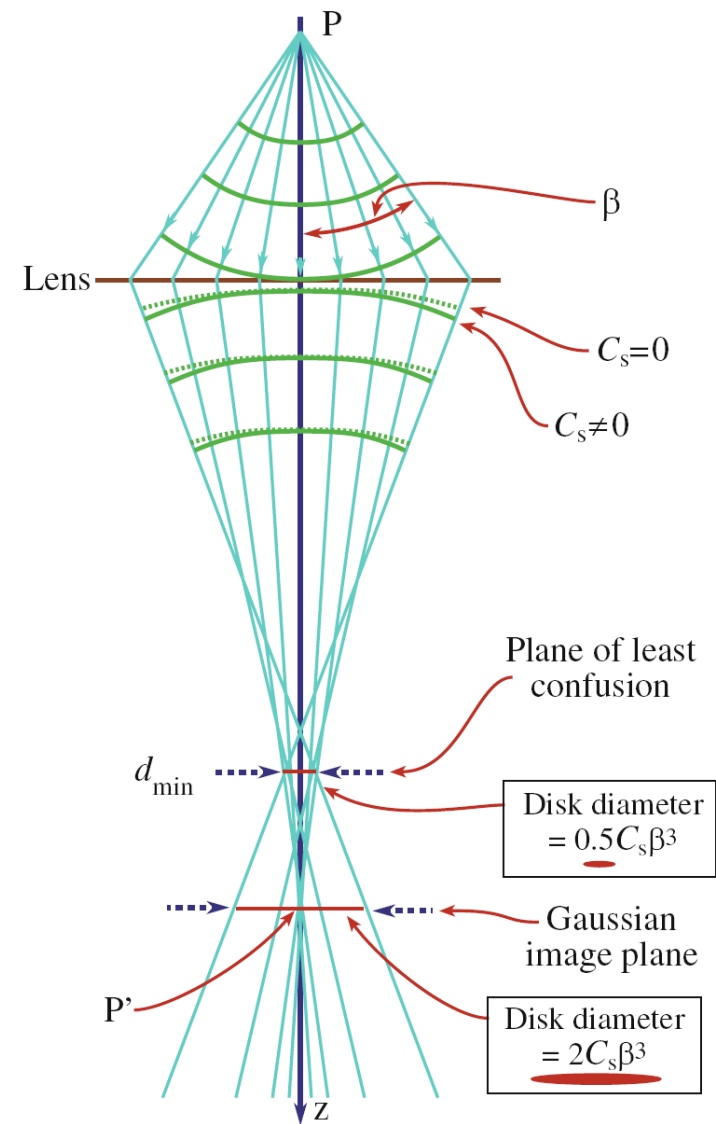
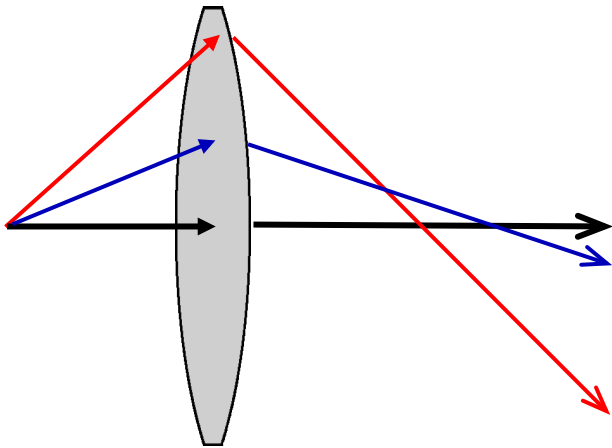

FIGURE 6.11. Spherical aberration in the lens causes wavefronts from a point object P to be spherically distorted by bending the rays at the outside of the lens more than those close to the axis. The point is thus imaged as a disk with a minimum radius in the plane of least confusion and a larger disk at P' in the Gaussian-image plane. The plane of least confusion is where the smallest image of the object is formed. Schematic intensity distributions at these two important planes are shown beside the ray diagram.

Cs-Aberration correction for optical lens

A converging lens



A doublets of a converging and a diverging lens

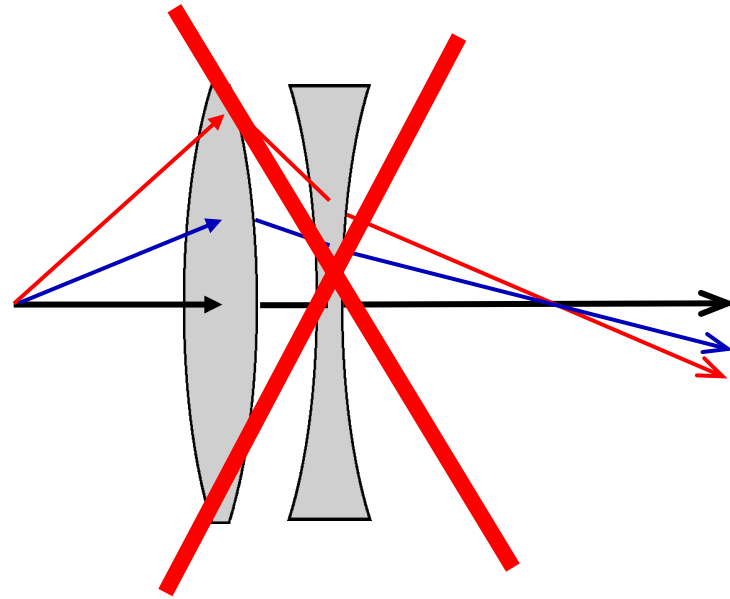

No diverging round lenses available for electrons !

Cs Aberration correction for TEM

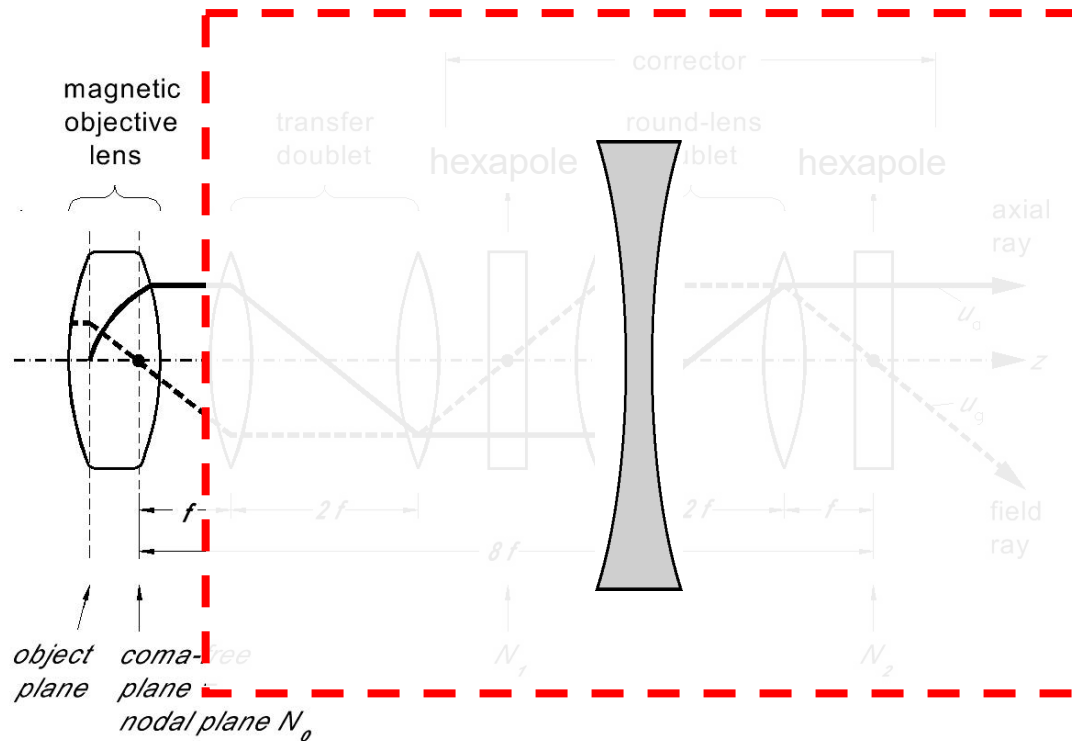

After 50 years endeavor, Cs aberration corrector for TEM has been successfully developed, which acts like a diverging lens to compensate the spherical aberration.

JEOL-2200FS Double Cs-corrected TEM high resolution microscope

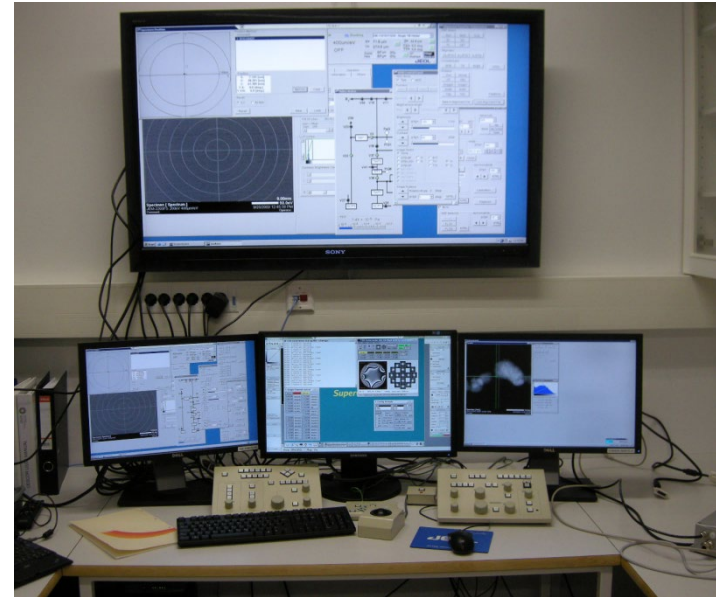
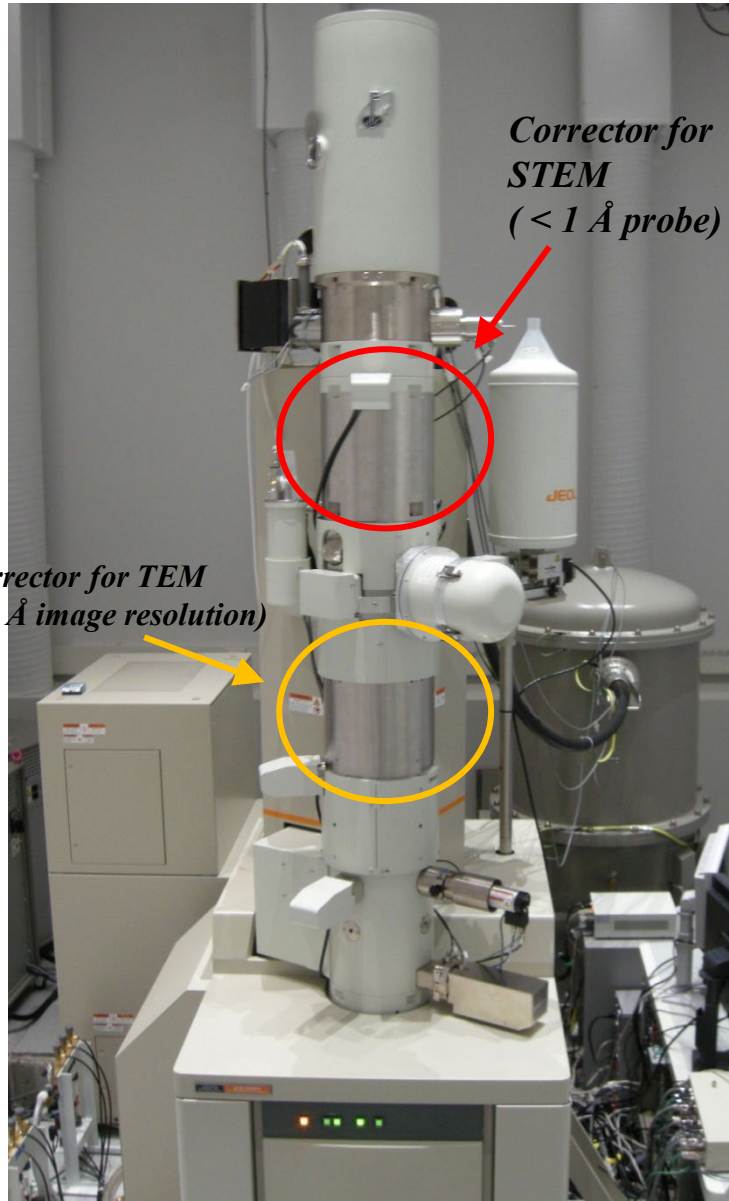

An state-of-the-arts atomic resolution (was in 2009) analytical microscope, delivers down to $\sim 1 \text{ \AA}$ resolution in both TEM and STEM with advanced aberration-correction technology.

- *Field-emission Gun*
- *Operating voltage: 80-200 kV*
- *In-column Omega-type energy filter*
- *Information limit: 1 \AA*
- *Energy spread: 0.7 eV*

Lens aberrations:

2. Chromatic aberration

Electrons which has less energy will be bend more in a magnetic lens

This aberration is biggest problem for thick samples because electrons will lose energy in inelastic scattering when travelling through the thick samples. →

For the best resolution – thin samples

$$r_{chr} = C_0 \frac{\Delta E}{E_0} \beta$$

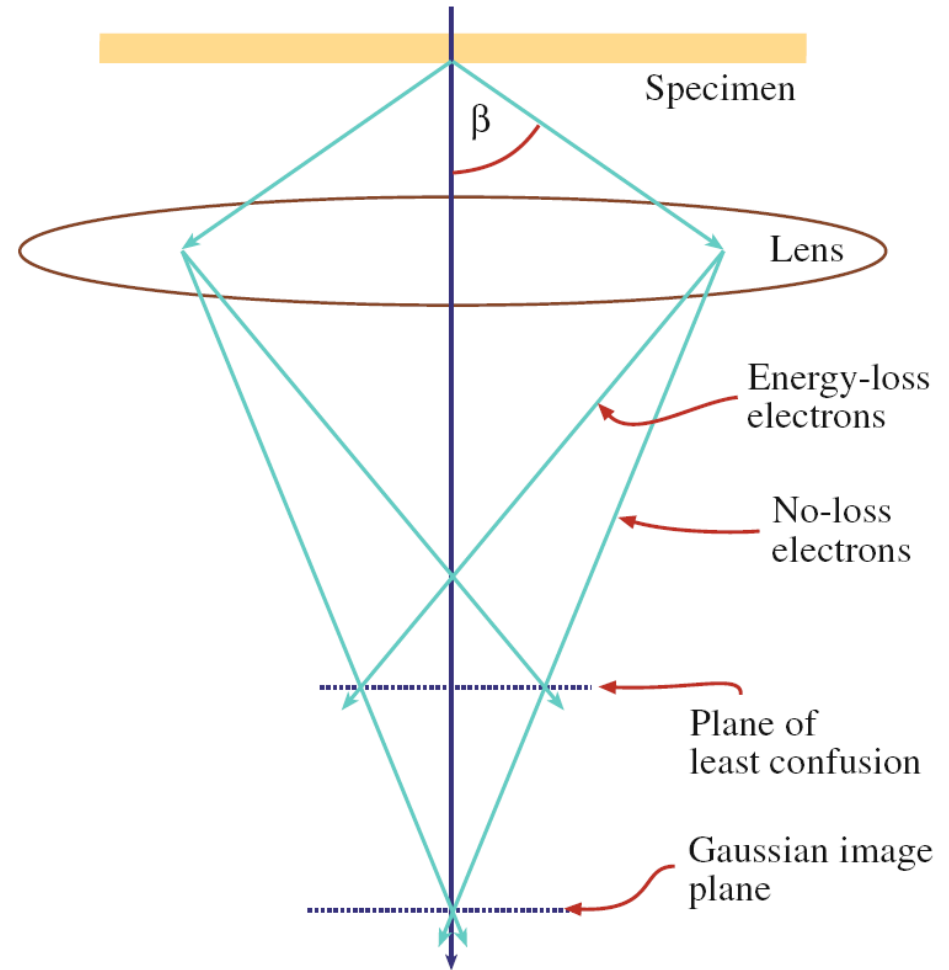

FIGURE 6.13. Chromatic aberration results in electrons with a range of energies being focused in different planes. Electrons emerging from the specimen with no loss of energy are less strongly focused than those that suffered energy loss within the specimen. So, as in Figure 6.11, a point in the object is imaged as a disk in the Gaussian image plane and there is a plane of least confusion.

Lens aberrations: 3. Astigmatism

Astigmatism occurs when the electrons sense a non-uniform magnetic field as they spiral round the optic axis.

- This defect arises because polepieces are not perfectly cylindrically symmetrical.
- If apertures they are not precisely centered around the axis.
- If the apertures are not clean, the contamination charges up and deflects the beam.

Astigmatism distorts the image by an amount

$$r_{ast} = \beta \Delta f$$

Fortunately, **astigmatism is easily corrected using stigmators**, which are small octupoles that introduce a compensating field to balance the inhomogeneities causing the astigmatism. There are stigmators in both the illumination (condenser lenses) system and the imaging system (objective lens)

Condenser lens

Under focus

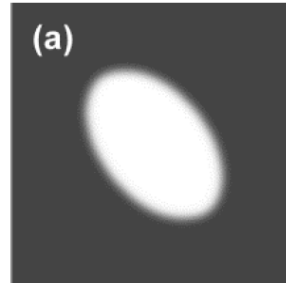

Astigmatic

Over focus

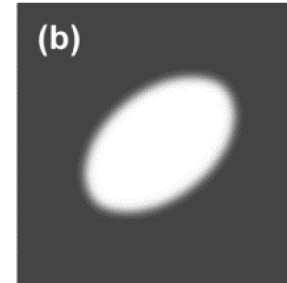

Astigmatic

no distortions at either underfocus or overfocus conditions

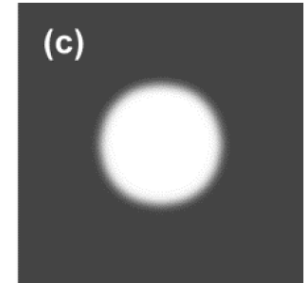

Stigmatized

Objective lens

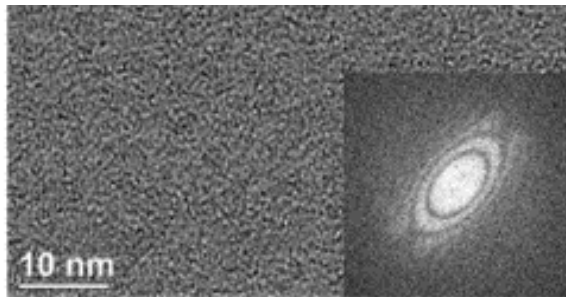

With small astigmatism, $\Delta f = -58$ nm

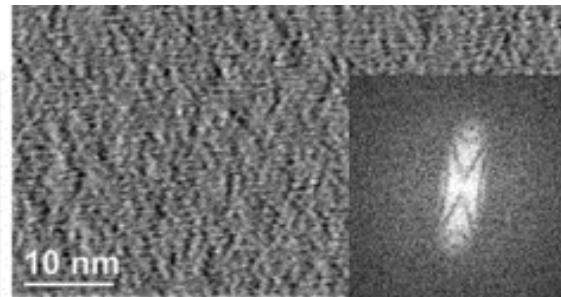

With large astigmatism, $\Delta f = -58$ nm

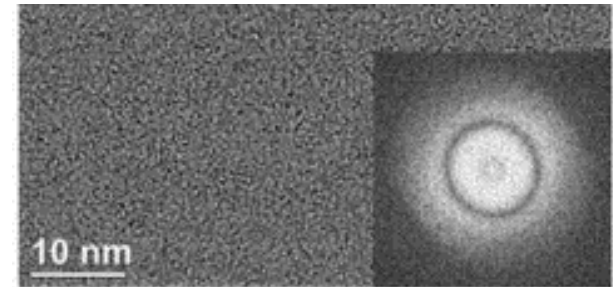

No astigmatism, $\Delta f = -58$ nm

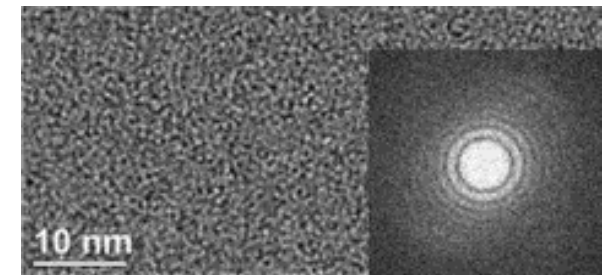

No astigmatism, $\Delta f = -116$ nm

Electron microscope resolution:

Theoretical resolution
(Classical Rayleigh criteria)

$$r_{th} = \frac{0.61 * \lambda}{\mu \sin \beta} \approx \frac{0.61\lambda}{\beta}$$

Electron wave length 300 kV ~ 0.002 nm !!!

Spherical aberration

$$r_{sph} = C_s \beta^3$$

Chromatic aberration

$$r_{chr} = C_c \frac{\Delta E}{E_0} \beta$$

Example Jeol 3200FSC cryo-TEM:

300 kV, $C_s = 4.1$ mm, $C_c = 3.4$ mm

→ point resolution ~2.6 Å

Jeol 2200FS $C_s = 1.0$ mm $C_c = 1.4$ mm, 200kV

Point resolution 2.3 Å (without C_s correctors)

Jeol 2800 200kV $C_s = 0.7$ mm

Point resolution 2.0 Å

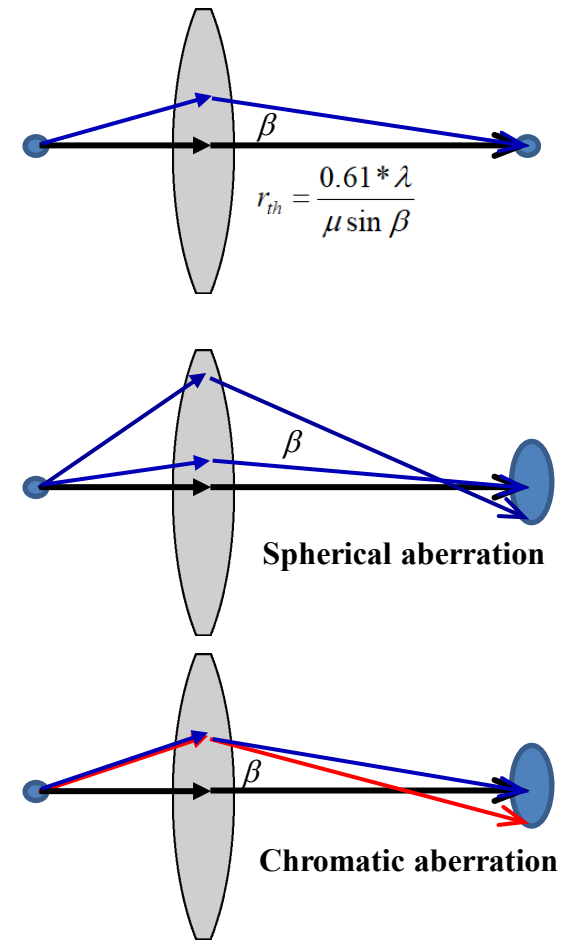

$$r_{total} = \sqrt{(r_{th})^2 + (r_{sph})^2 + (r_{chr})^2 + \dots}$$

If spherical aberration could be corrected

$C_s \sim 0 \rightarrow$ resolution < 1 Å

If also chromatic aberration could be corrected or minimized \rightarrow resolution < 0.5 Å

6.6.B. Spherical Aberration-Limited Resolution (The Practical Resolution)

We'll start by summing the radii of the Rayleigh disk and spherical-aberration disk (in the Gaussian image plane) in quadrature (remember it's radii for image resolution, diameters for probe-limited resolutions)

$$r = (r_{\text{th}}^2 + r_{\text{sph}}^2)^{1/2} \quad (6.19)$$

Therefore, since both these terms are approximate

$$r(\beta) \approx \left[\left(\frac{\lambda}{\beta} \right)^2 + (C_s \beta^3)^2 \right]^{1/2} \quad (6.20)$$

Since the two terms vary differently with the aperture collection angle β , a compromise value exists when the differential of $r(\beta)$ with respect to β is set to zero and we find that

$$\frac{\lambda^2}{\beta^3} \approx C_s^2 \beta^5 \quad (6.21)$$

So we come up with an optimum expression for β which Hawkes (1972) gives as

$$\beta_{\text{opt}} = 0.77 \frac{\lambda^{1/4}}{C_s^{1/4}} \quad (6.22)$$

The exact value of the numerical factor depends on the assumptions made about the various terms included in the definition of resolution and so is often written simply as A . Sometimes, this compromise value is determined by simply equating the equations for r_{th} and r_{sph} rather than going through the summation in quadrature. A quick calculation for 100-keV electrons ($\lambda = 0.0037$ nm) for an instrument with $C_s = 3$ mm gives a β_{opt} value of ~ 4.5 mrad.

If this expression for β_{opt} in equation 6.22 is substituted into equation 6.20 we get a minimum value of $r(\beta)$

$$r_{\text{min}} \approx 0.91 (C_s \lambda^3)^{1/4} \quad (6.23)$$

This is the expression we want; it gives the *practical* resolution of the TEM.

Resolution

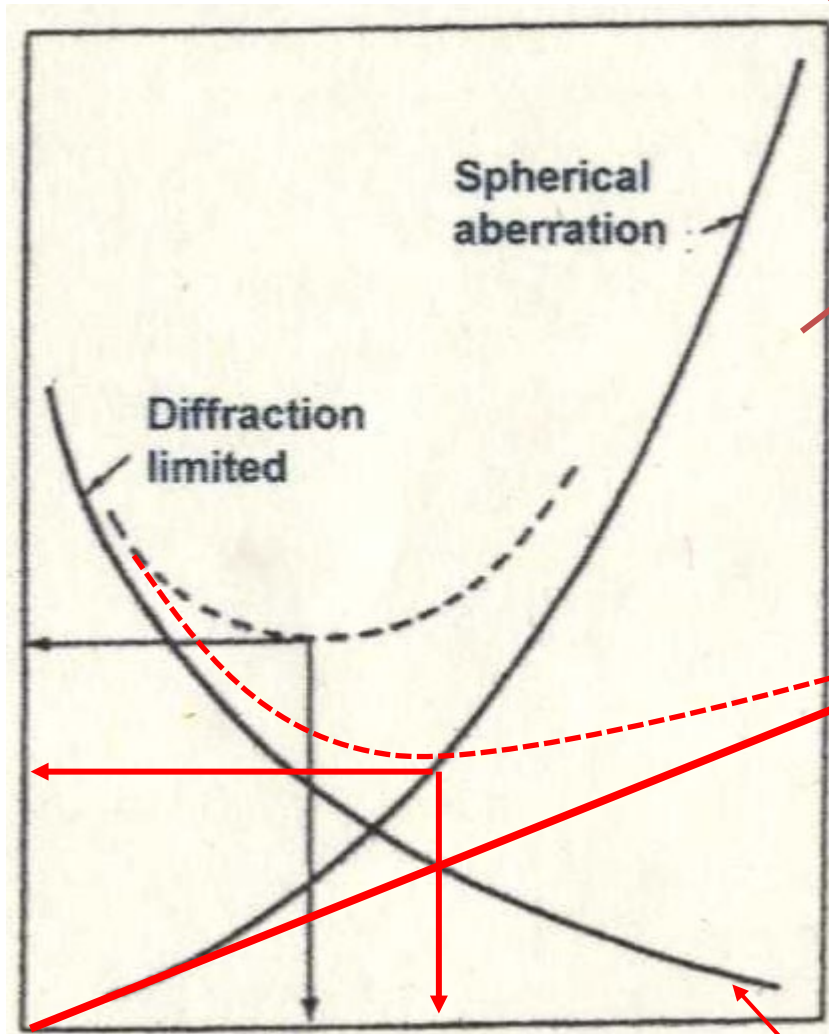

Collection semiangle β

~~Aberrations:
 $r_{sph} = C_s \beta^3$~~

$$r_{chr} = C_c \frac{\Delta E}{E_0} \beta$$

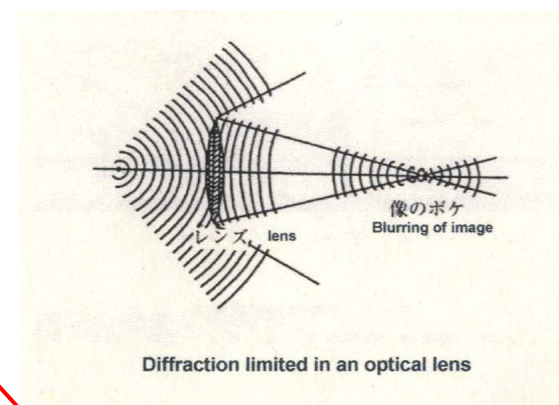

$$\delta = \frac{0.61 * \lambda}{\sin \beta}$$

Resolution: summary

Resolution:

(Classical Rayleigh criteria) $\delta \approx \frac{0.61\lambda}{\beta}$

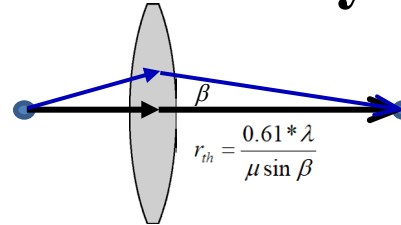

Lens aberrations:

Spherical $r_{sph} \sim C_s \beta^3$

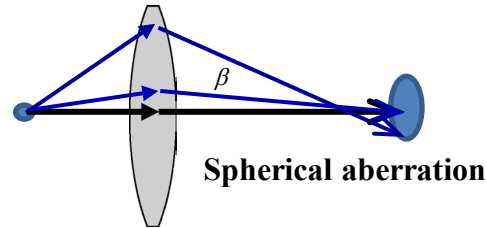

Chromatic $r_{chr} \sim C_0 \frac{\Delta E}{E_0} \beta$

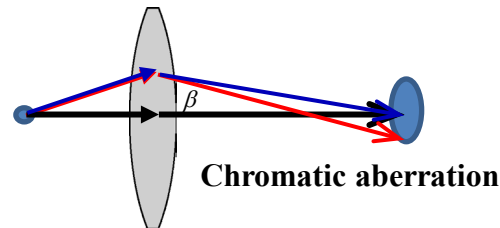

For high resolution TEM work: large β (= large objective aperture) and very low C_s value for the lens (This can be even now corrected close to zero using C_s correctors) and also thin specimen (lower r_{chr} and less overlapping structures).

Soft materials samples soft materials microscopes typically have large C_s . Also some times samples are typically quite thick \rightarrow chromatic aberration is large. \rightarrow Energy filtering is important and small aperture gives normally the best resolution and best contrast – which is typically the biggest problem.

7

How to ‘See’ Electrons

CHAPTER PREVIEW

If we are studying the structure of a material, when all is said and done, all we have to show for learning how to operate our expensive TEM, the many hours spent in specimen preparation, etc., is an image or a DP. These images and DPs, which are just different distributions of electron intensity, have first to be viewed in some manner. After viewing, we have to decide if we want to save the results for future reference, perhaps so we can print out the data for a presentation, technical report, or scientific publication. Since, as we noted in the opening chapter, our eyes are not sensitive to electrons, we have to find ways to translate the electron-intensity distributions generated by the specimen into visible-light distributions, which we can see. This chapter will explain how we ‘see’ electrons.

We’ll break the process down into two parts: first, detection (and display) of the image, and second, recording of the image. Both these areas are undergoing rapid change because of ongoing advances in electronic imaging and storage technology, and so this chapter will undoubtedly contain anachronisms by the time you read it. In particular, numbers are favored over photographic data; how can we quantitatively compare two photographs? Comparing two sets of numbers is routine.

How to "see" electrons ?

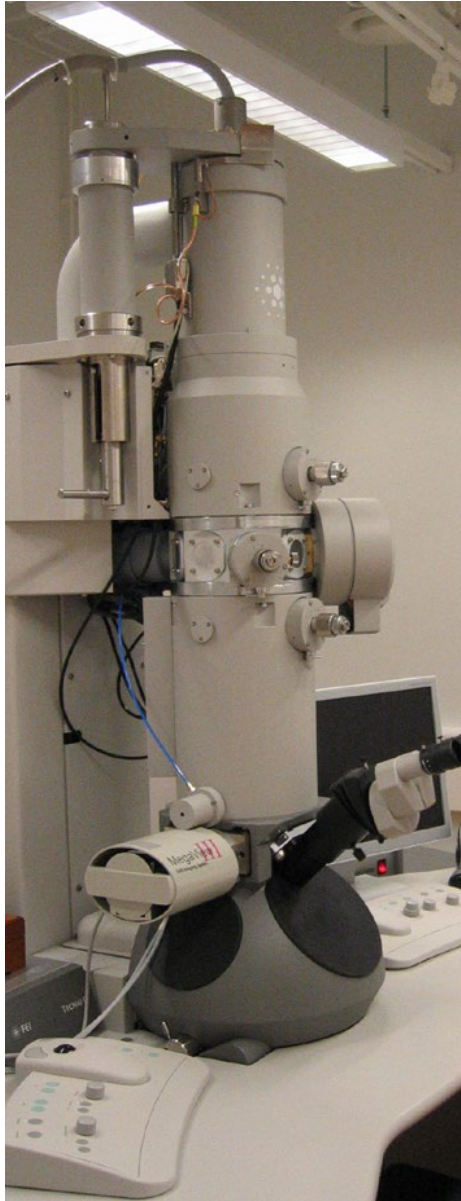

Viewing screens:

Coated with materials that emits green light

ZnS emission ~ 450 nm

(some impurities added ~ 550 nm)

Types of CCD/CMOS cameras & principals of Operation

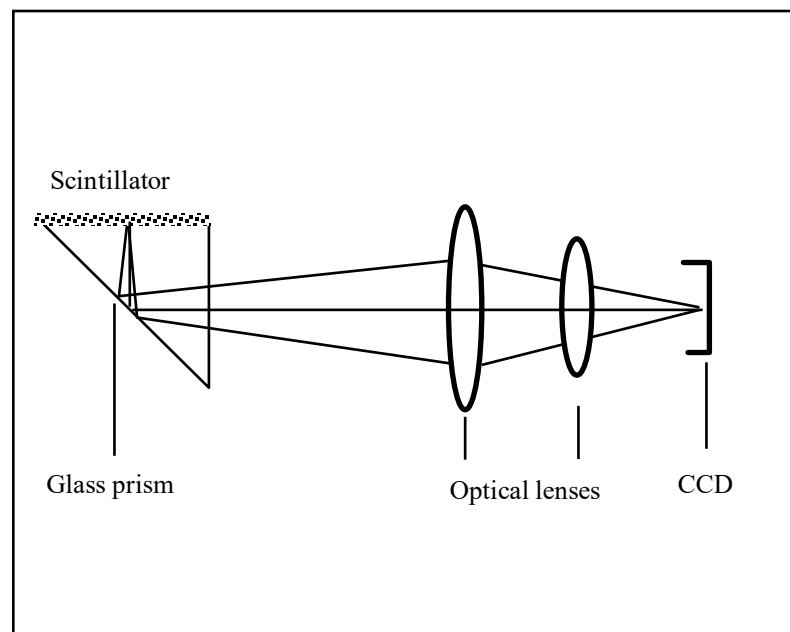
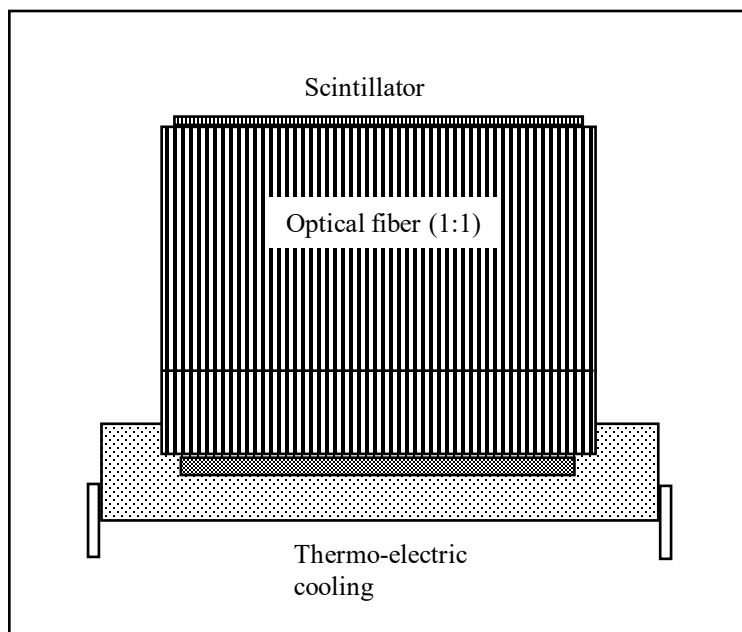
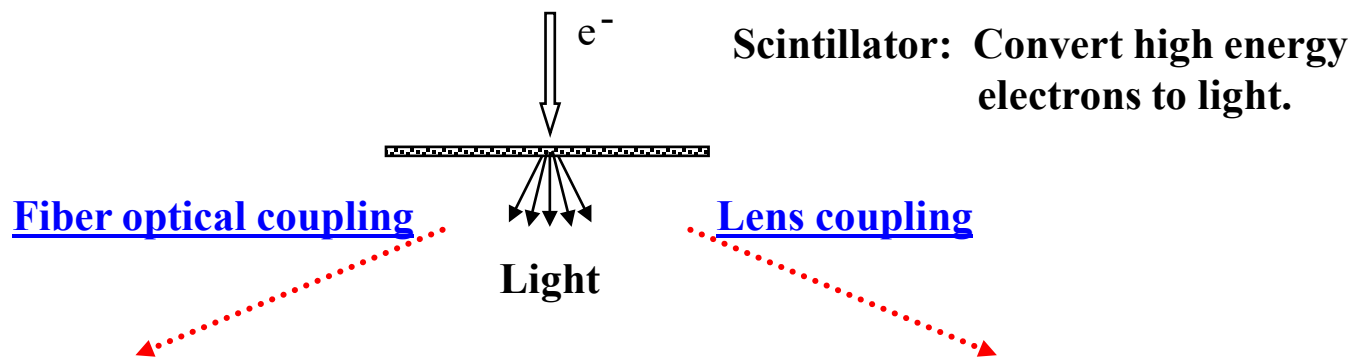

CCD (charge-coupled device) charge storage and pixel readout

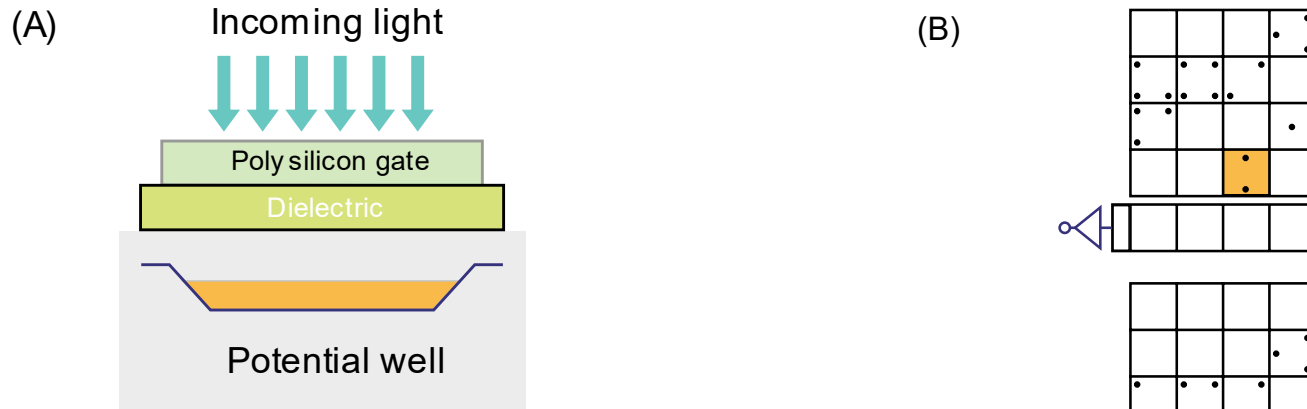
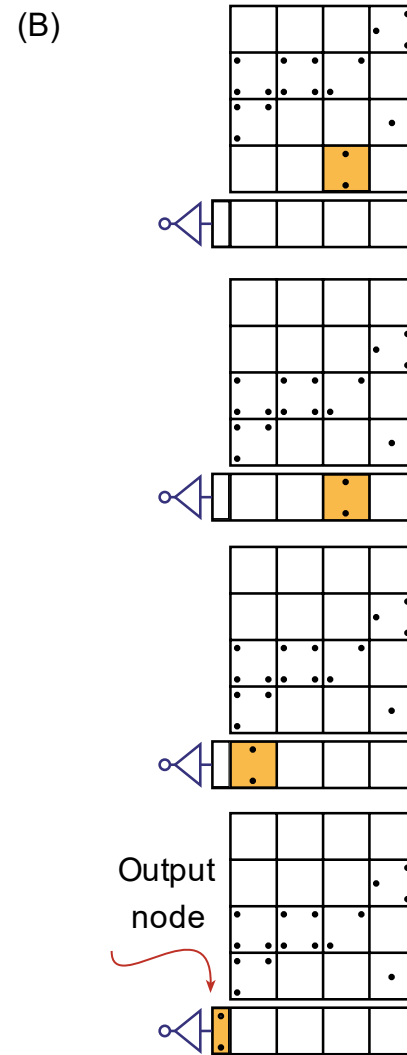
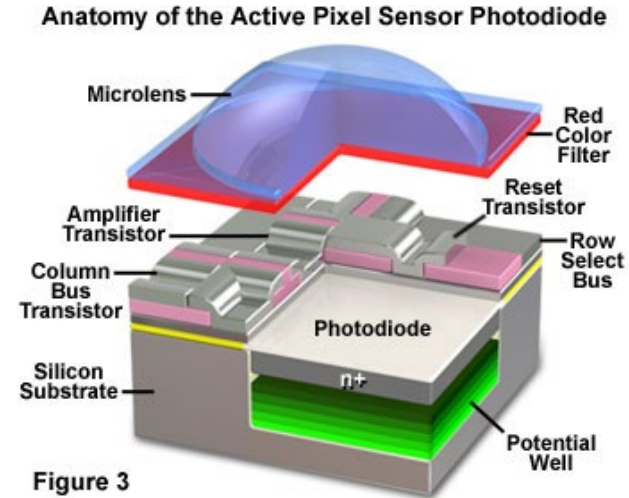
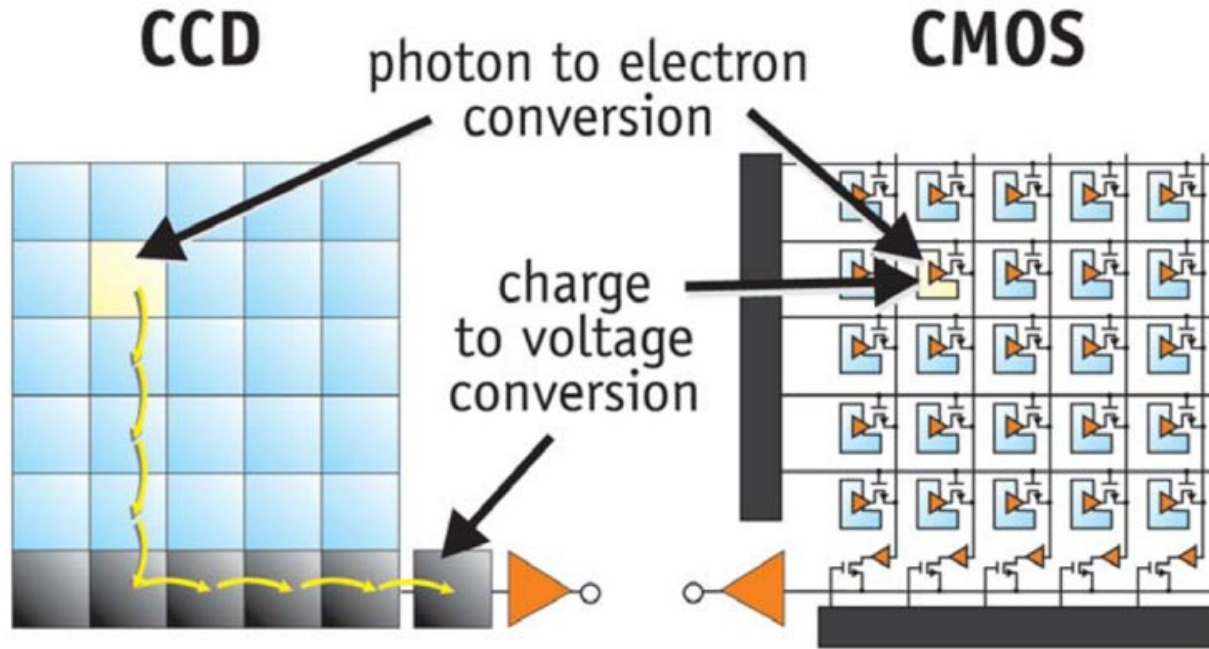

FIGURE 7.3. (A) A single cell in a CCD array showing the **storage of charge in the potential well under one pixel**. If we vary the applied potential to rows of pixels in sequence as in (B), **one pixel row** is shifted to the parallel register and **is read out pixel by pixel**, after which **the next row** is moved to the parallel register, and so on. The stored charge in each pixel is thus fed into an amplifier and digitized.

CCD reading is quite slow and therefore typically it is done same time for 4 quadrants i.e in our 4k*4k camera each 2k*2k quadrant is read simultaneously – but still reading the one full resolution frame takes more than a second...



CCD (charge-coupled device) and CMOS (complementary metal-oxide semiconductor)



CCDs move photogenerated charge from pixel to pixel and convert it to voltage at an output node. CMOS imagers convert charge to voltage inside each pixel.

Now most of the cameras are CMOS

CMOS camera converts the charge to voltage inside each pixel and therefore reading can be done much faster – therefore it can take hundreds of images per second, and also it is cheaper to make than CCD. *Active area in each pixel is bit smaller* due to electronics inside the pixel – however new CMOS cameras are almost similar in sensitivity than CCD's

On-Chip Binning of CCD/CMOS

2 x 2 Binning

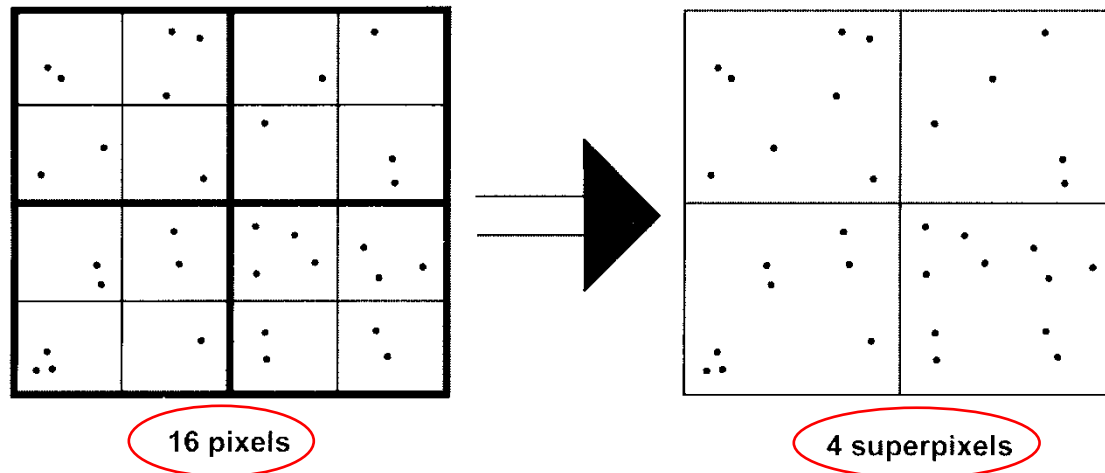

- Improve “signal-to-noise” (S/N) ratio for the same exposure time
- Reduce readout noise CCD/CMOS (*If binning is done “on Chip” instead on computer*).
- Allows fast viewing of CCD (suitable for sample search) and increase CMOS speed for insitu work >1000 frames per second
- Reduce spatial resolution (effective pixel larger)
- Field of view remains the same

DigitalMontage

Increased Field of View without Sacrificing Resolution

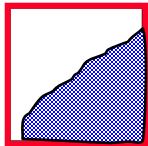

▶ Regular 4k x 4k image

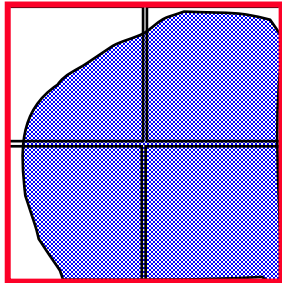

▶ 8k x 8k montage

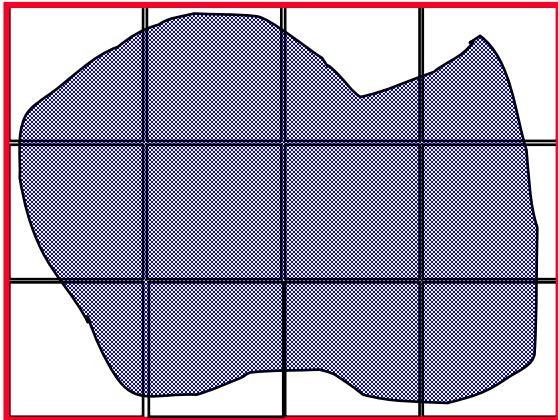

▶ 16k x 12k montage

TEM Automation - DigitalMontage

Unstained
liver sample

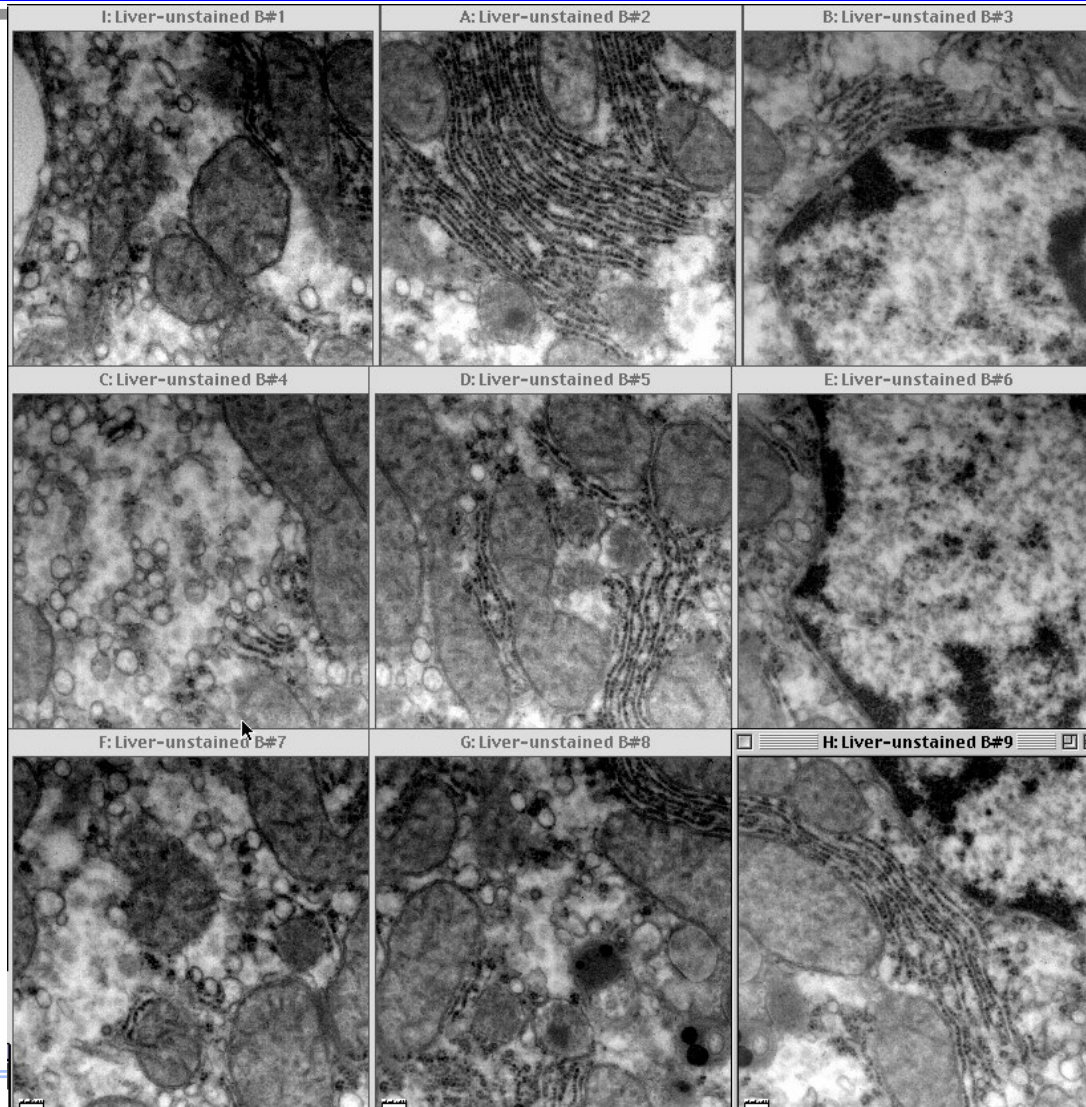

TEM Automation - DigitalMontage

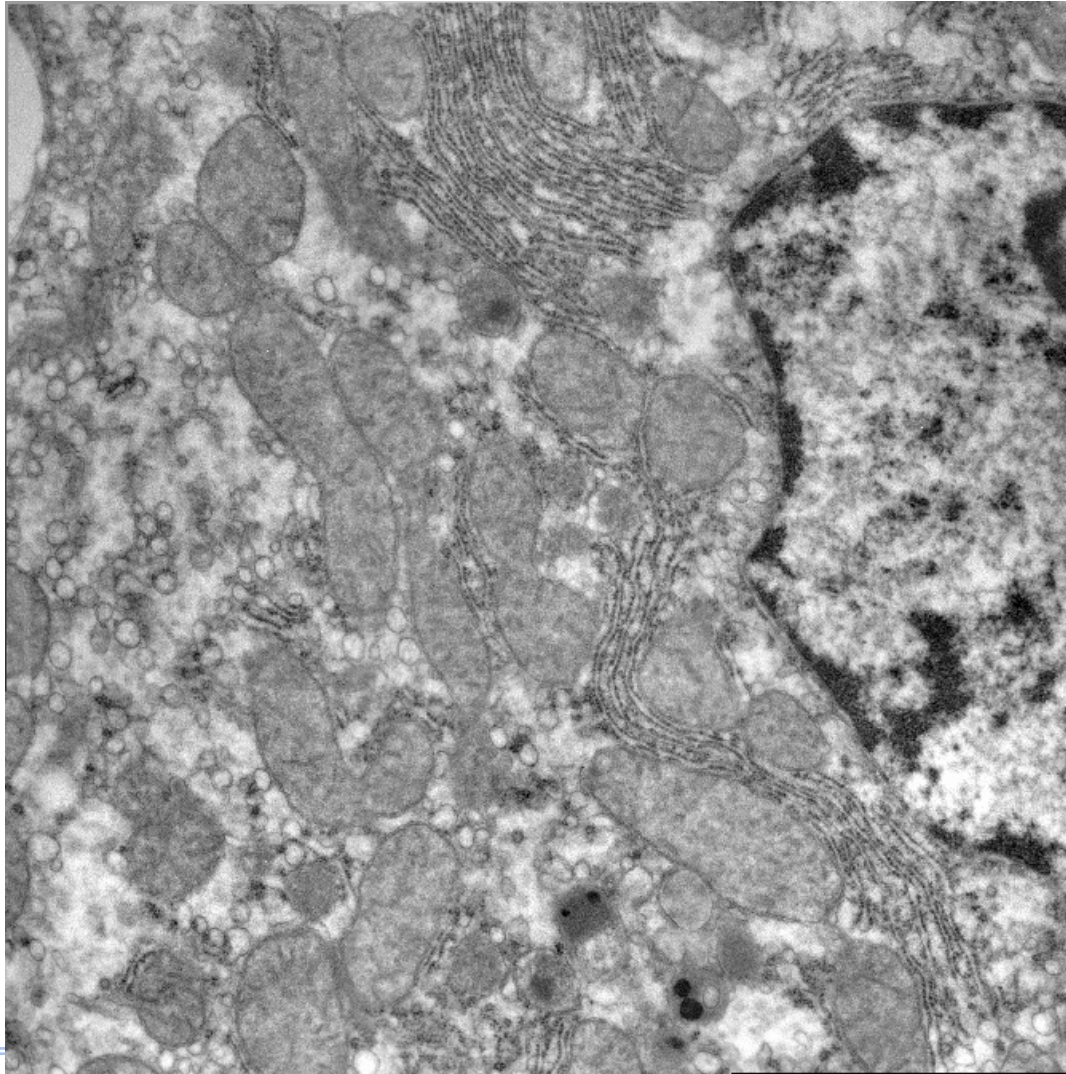

2011 - 2012 first new direct detection cameras came to market and now they are getting more popular and replacing CMOS cameras in high end applications ... **no electron to light conversion needed** – Faster reading (up to 1600 frames per second) and much **better sensitivity** ... but still very expensive ~500k€ (and ~1000k€ best models) – but 2020 - 2021 new less expensive models are coming.

New development for low dose applications: Gatan has **Direct detection camera K3** (fits all TEM's) www.gatan.com. And Thermo fischer (FEI) has Falcon **Direct detection camera** (available only for FEI microscopes) also **Direct Electron company** has these Cameras (www.directelectron.com)

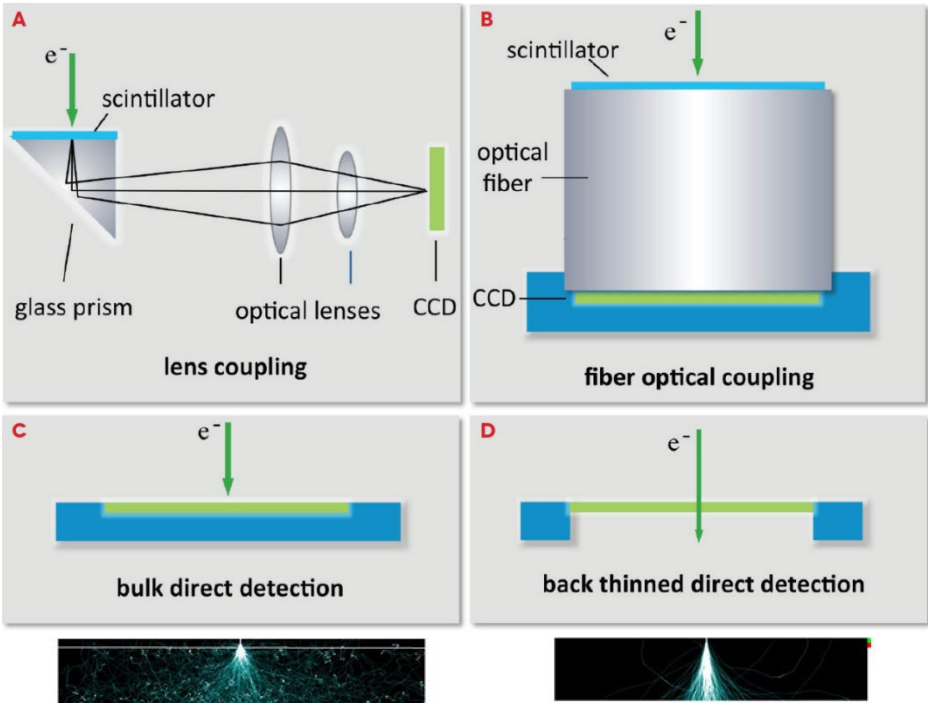

Conventional CCD or CMOS. Electrons are converted to light and then light is converted to Voltage



Direct detection camera = back thinned CMOS camera
And electrons are directly detected without light conversion

Direct electron detectors - Electron Counting: In counting mode, individual electron events are identified at the time that they reach the detector. To do this efficiently the *camera must run fast enough* so that individual electron events can be identified separately (Low dose and high speed 200 – 1600 fps)

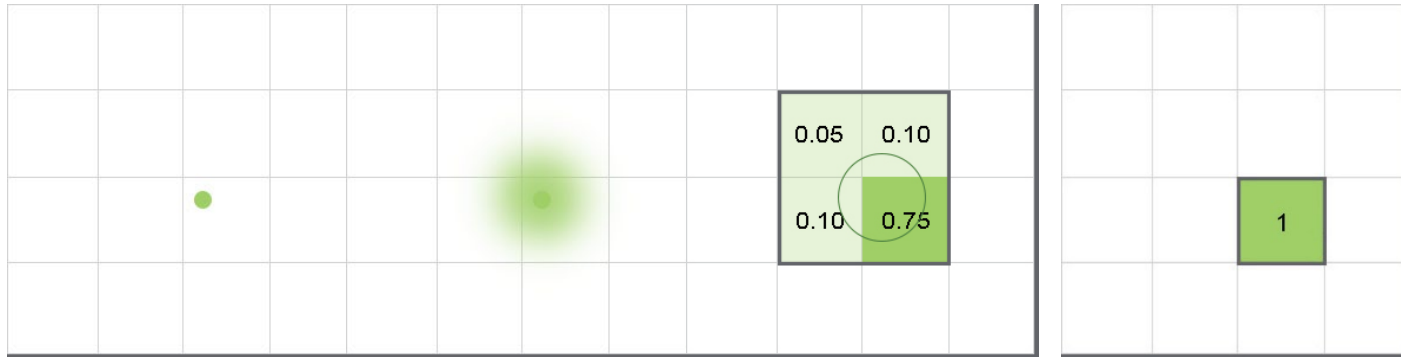

Integrating (Linear) Mode

best for in situ TEM, 4D-STEM, diffraction, & high-dose imaging

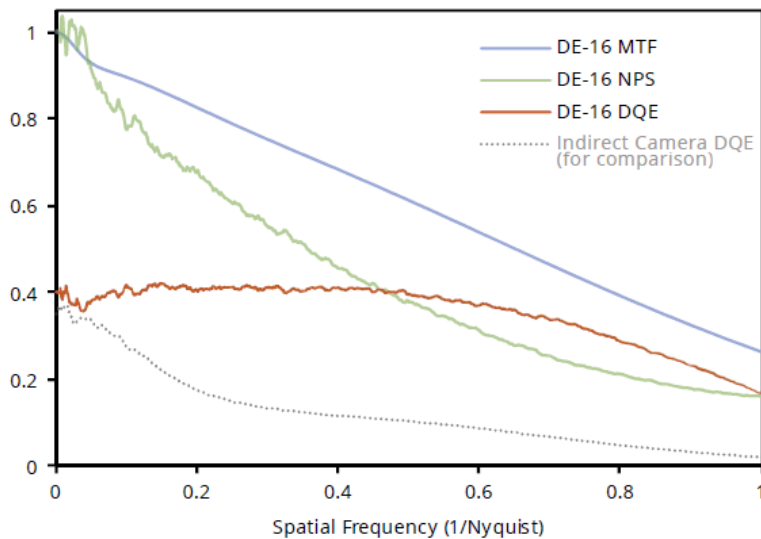

Electron Counting Mode

best for low-dose imaging, holography, & DTEM/UTEM

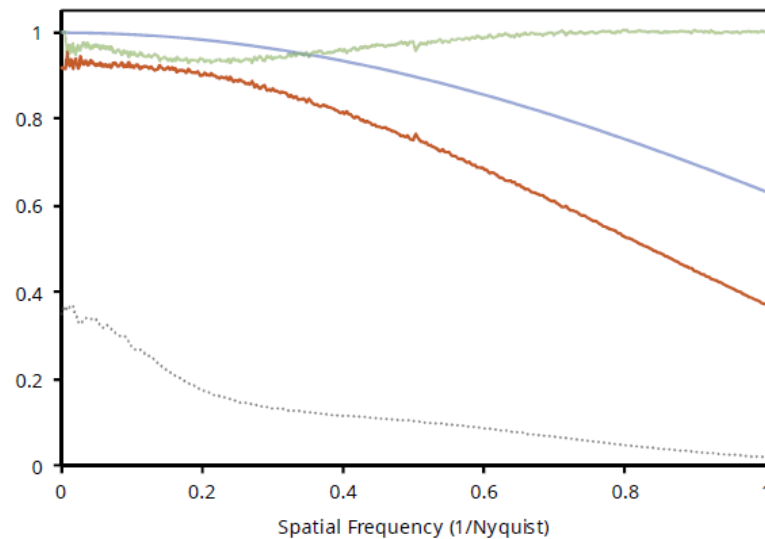

Direct electron detection cameras: Quantum efficiency DQE (Red curve) is clearly higher in integrating mode and much higher in counting mode compared to conventional CCD or CMOS cameras (lowest curve)

Other electron detectors

Semiconductor detectors are mostly used for STEM detectors and SEM back scattering detector

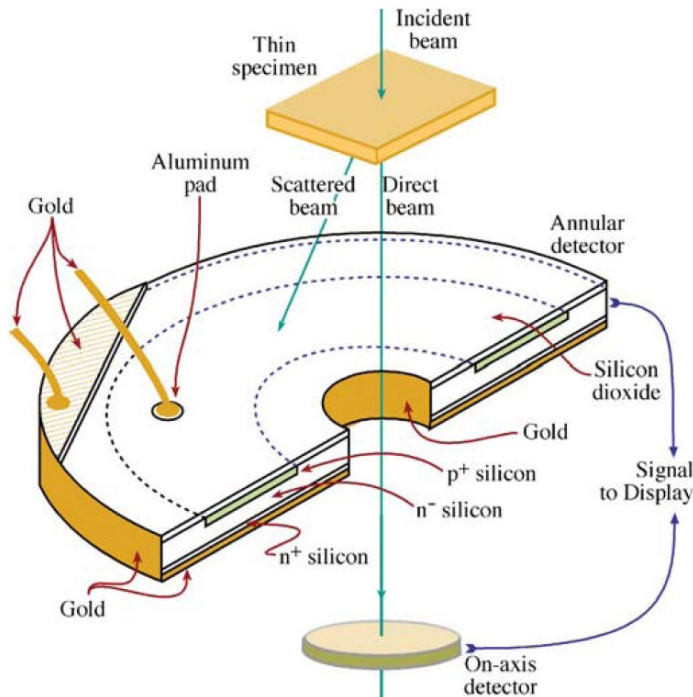

FIGURE 7.1. Semiconductor detector of the surface-barrier type, shown in a configuration where it would be used to detect high-energy, forward-scattered electrons. The direct beam is detected by a small circular detector on the optic axis of the microscope surrounded by a concentric wide-angle annular detector, which detects any scattered electrons.

Semiconductor detectors have several advantages:

- We can easily fabricate them.
- They are cheap to replace.
- They can be cut into any shape, as long as it is flat.

There are also some drawbacks to semiconductor detectors:

- They have a large dark current (the current registered when no signal is incident on the detector). This dark current arises from thermal activation of electron-hole pairs, or from light falling on an uncoated detector. Since the detectors in a TEM invariably have a metal ohmic contact, the light problem is minimal. Now we could minimize thermal activation by cooling the detector to liquid-nitrogen temperatures, but that step is impractical and introduces a cold surface into the vacuum which would simply collect contamination, so we live with noise due to the thermal activation.
- Because noise is inherent in the semiconductor detector, its DQE is poor for low-intensity signals, but rises almost to unity for high-intensity signals.

- The electron beam can damage the detector, particularly in intermediate voltage microscopes. In these circumstances a doped *p-n* detector is less sensitive than the surface-barrier detector, because the depletion region is deeper in the Si.
- They are insensitive to low-energy electrons such as secondary electrons.

Scintillator-PM system

These detectors are typical in SEM for low energy electron applications – like secondary electron detector SE but can be used also for STEM detectors

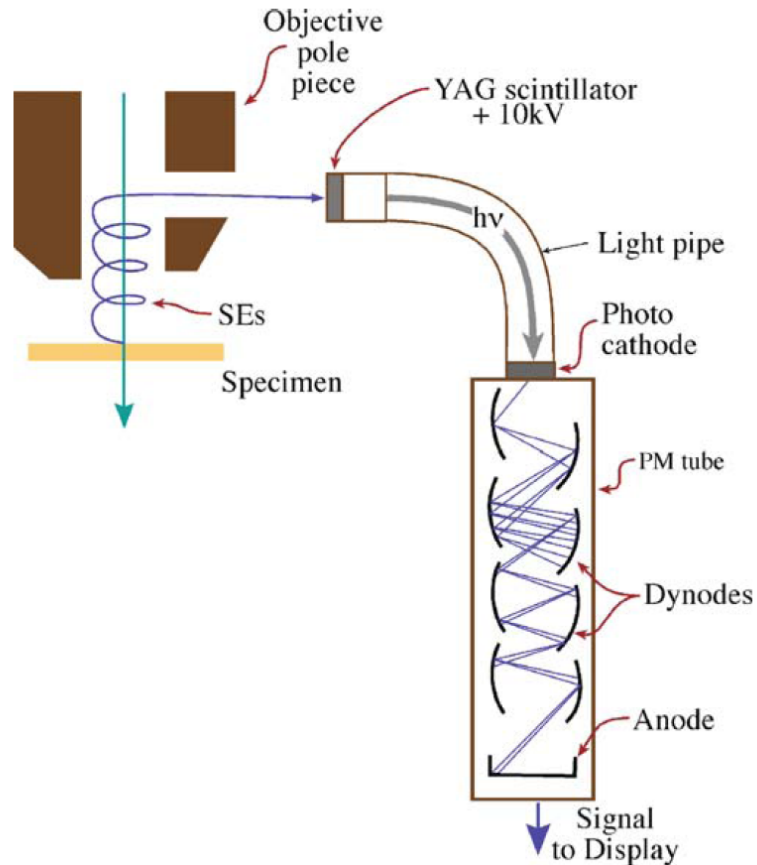

FIGURE 7.2. Scintillator-photomultiplier detector system for SE detection in a TEM. SEs from the specimen spiral back up through the objective lens polepiece and are accelerated by the high voltage onto the scintillator, generating visible light which travels via fiber optics to a photocathode. There the light is re-converted to electrons. The electron signal is then multiplied by several electrodes (dynodes) in the PM tube before being used to modulate the display screen.

The advantages of the scintillator-PM system are

- The gain of the system is very high. The gain for the total detector system is of the order of 10^n , depending on the number (n) of electrodes (often called dynodes) in the PM. A value of 10^8 is not unusual (compare with $\sim 10^4$ for the semiconductor detector). This performance is reflected in a typical DQE of close to 0.9 for several commercial scintillators.
- The noise level in a scintillator is low compared with semiconductor detectors, and the bandwidth of the scintillator is in the MHz range. As a result, both low-intensity images and TV-rate images are easily displayed. There is a tremendous practical advantage to TV-rate imaging of digital signals, because such images, when suitably processed and displayed can be viewed, stored, and recorded under normal conditions of room illumination. So you don't have to work in the dark while operating your (S)TEM.

The disadvantages of the scintillator-PM system are

- The scintillator is not as robust as the semiconductor detector, being even more susceptible to radiation damage, particularly after longtime exposure to the beam.
- The scintillator-PM combination is also substantially more expensive and bulky compared to semiconductor detectors and therefore it does not fit well within the TEM stage, nor is it easily manufactured into multi-detector configurations; it is also more expensive. However, plastic scintillators can be shaped to give large collection angle, such as the Robinson BSE detector used in many SEMs.
- The energy-conversion efficiency of a scintillator is also rather low ($\sim 2\%$ – 20%) compared to a semiconductor detector and, typically, we only get about 4000 photons per incident 100-keV electron, $\sim 7\times$ less than for the semiconductor detector. This low efficiency is offset by the gain in the PM tube.

7.3.D Faraday Cup

In conventional TEM there isn't much need to know the beam current, but for X-ray analysis in the AEM, it is essential, since there is often a need to compare analytical results obtained under identical beam current conditions. A Faraday cup is a detector that simply measures the total electron current in the beam. We don't use it for any imaging process, but rather as a way of characterizing the performance of the electron source as we saw in Chapter 5. Once the electrons enter the Faraday cup, they cannot leave except by flowing to ground through an attached picoammeter that measures the electron current.

FIGURE 7.4. (A) Schematic diagram of a dedicated Faraday cup in the end of a side-entry specimen holder (more details about these holders in Chapter 8). The entrance aperture has to be found by imaging the top surface using SEs or BSEs. In (B) the specimen holder is retracted so the electrons fall into a cup on the tip of the holder (in which position of course the TEM image of your specimen cannot be seen). In either case, the electron current is measured as it goes to ground through a picoammeter attached to the outside of the holder.

FARADAY CUP
Remember: A Faraday Cup is a Black Hole for Electrons.

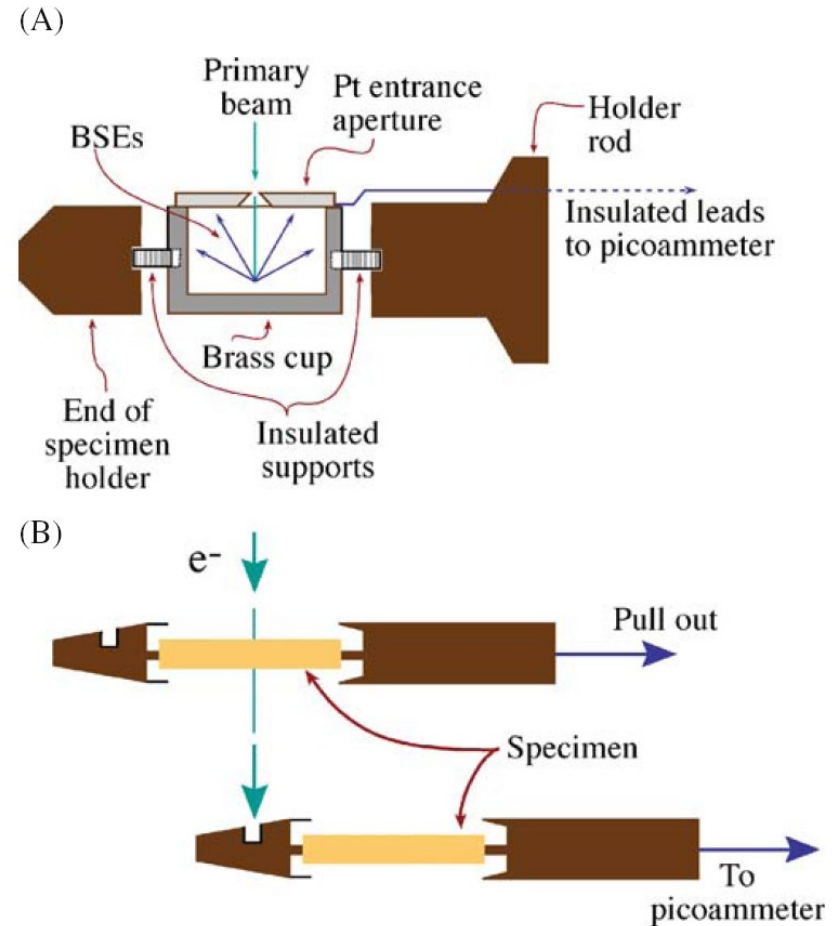

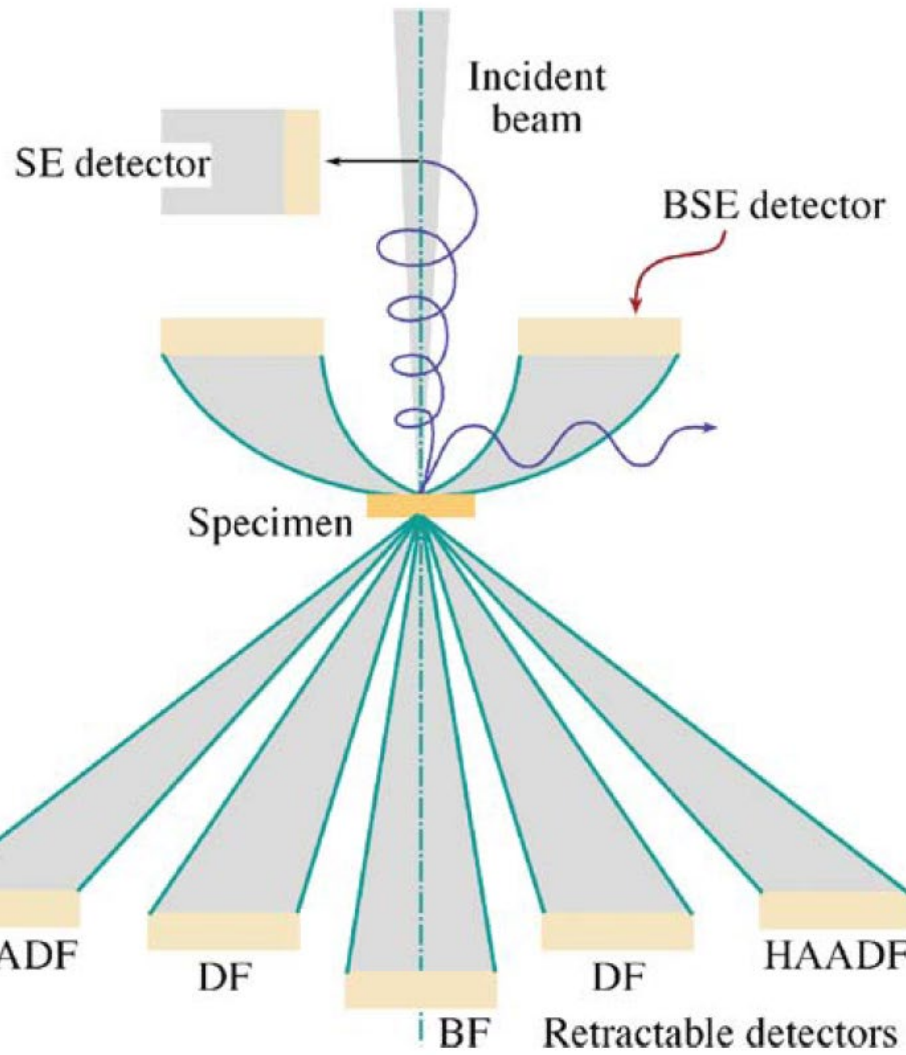
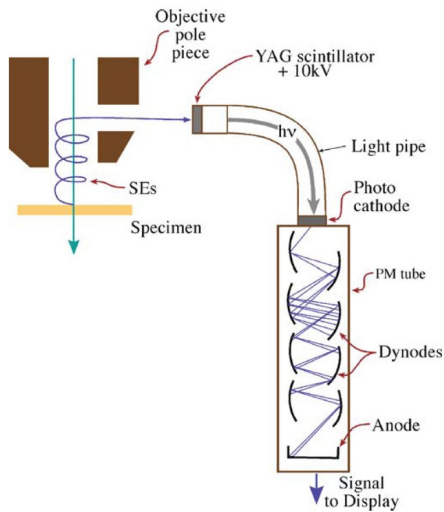

SEM detectors

STEM detectors

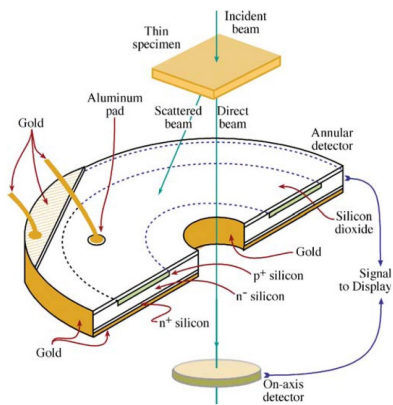

FIGURE 7.5. The various electron detectors in a STEM. Scintillator-PM detectors are invariably used for SE detection and semiconductor detectors for the BSE. The on-axis and annular forward-scattered and high-angle dark field detectors may be either type, depending on the microscope. The SE detector is rare, the BSE detector is a waste of time: only the forward-scattered electron detectors are standard.

8

Pumps and Holders

CHAPTER PREVIEW

In the past three chapters we've described the sources, lenses, and detectors that make up a TEM. The only other parts of the instrument you need to know about in detail are those that, if you are not careful, can seriously degrade the quality of the information you generate even if the rest is perfect. These two parts are the holder in which you put your specimen and the vacuum that surrounds it. While there isn't much you can do to improve the vacuum, beyond buying a better microscope, there is a lot you can do that will degrade the quality of the vacuum in the column and, in doing so, contaminate your specimen. So we'll tell you a few basics about how the vacuum pumps work, and how the vacuum system is put together. Although the vacuum system is under computer control in most TEMs, you still affect the vacuum by what you put in the microscope. Consequently, you need to know what not to do on those occasions when you might otherwise degrade the vacuum.

The vacuum in the stage of a typical TEM is $\sim 10^{-5}$ Pa, compared with atmospheric pressure of $\sim 10^5$ Pa. It is quite remarkable that we can transfer a specimen into the TEM, reducing the ambient pressure at its surface by 10 orders of magnitude in a matter of a few seconds. This rapid transfer is a testament to the skills of TEM designers, and particularly the construction of the specimen holder and the airlock system. Specimen holders are the physical contact between you and your specimen across this extraordinary vacuum range. You must transmit all the experimental variables that you want to inflict on your specimen by way of the holder. The most basic requirement is that you should be able to move the specimen laterally to look at different areas; to optimize the imaging you should also be able to move the specimen vertically. In addition we'll describe how you can tilt, rotate, heat, cool, strain, and bias the materials that you are studying. Unfortunately, the holder also transmits vibrations, drift, and contamination to the specimen and may be a source of X-rays that can degrade any analysis that you want to perform. Care of your specimen holders is extremely important since damaged or worn holders reduce the quality of the data generated by the microscope. If you are not careful, a \$10,000 holder can easily limit the information generated by a million-dollar TEM.

PRESSURE

1 Torr is ~ 133 Pa

1 Pa is 7.5×10^{-3} Torr

One bar is atmospheric pressure (~ 760 Torr) and is equivalent to $\sim 10^5$ Pa.

The name is the torr; the unit is the Torr, but either way the torr is not an accepted SI unit.

$100-0.1$ Pa ($\sim 1-10^{-3}$ Torr) is a rough vacuum.

$0.1-10^{-4}$ Pa ($\sim 10^{-3}-10^{-6}$ Torr) is low vacuum.

$10^{-4}-10^{-7}$ Pa ($\sim 10^{-6}-10^{-9}$ Torr) is high vacuum (HV).

$<10^{-7}$ Pa ($\sim 10^{-9}$ Torr) is ultrahigh vacuum (UHV).

Be careful when you hear a phrase like “the vacuum in the gun is 10^{-8} ” and remember the pascal unit is Pa and the torr unit is Torr.

Water boiling point at RT
 ~ 25 mbar

$1-10^{-3}$ mbar rough vacuum

$10^{-3}-10^{-6}$ mbar low vacuum

$10^{-6}-10^{-9}$ mbar HV

$<10^{-9}$ mbar UHV

10^3 mbar = 1 bar = 100 000 Pa (Normal atmosphere pressure)

1 mbar = 100 Pa

10^{-8} mbar = 10^{-6} Pa (normally column/sample area $10^{-5}-10^{-6}$ Pa)

10^{-10} mbar = 10^{-8} Pa (FEG Gun area or even higher vacuum)

There are 4 different vacuum pump types used in Electron microscopes ..
Which are briefly introduced in next few slides

1. Mechanical pump: atm - 10^{-1} Pa ($\rightarrow 10^{-3}$ mbar)

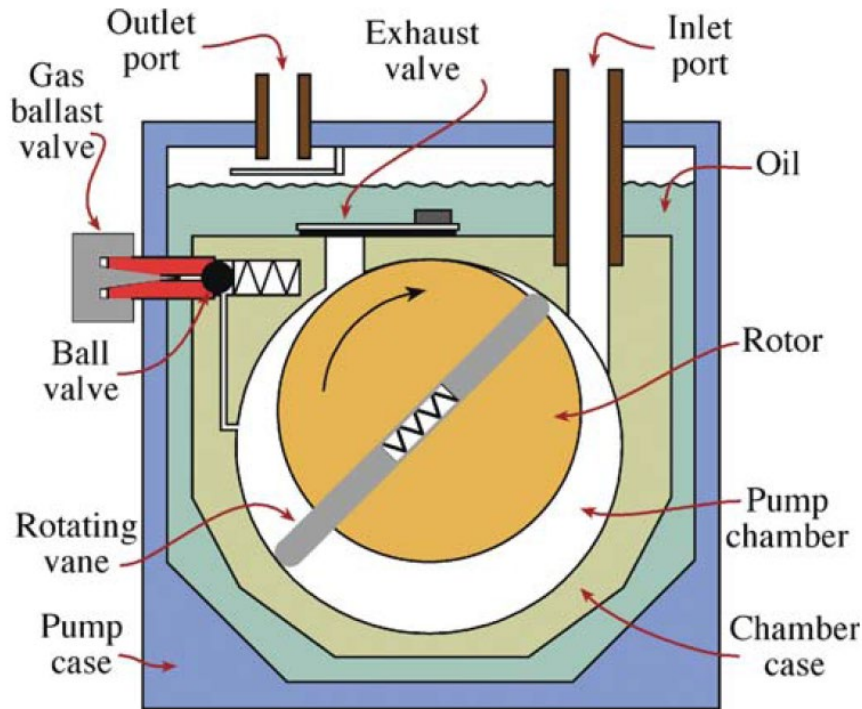

FIGURE 8.1. A mechanical pump for roughing vacuums. The eccentric motion of the pump creates a vacuum in the RH side when it rotates and the vacuum sucks air into the inlet valve. As the cylinder rotates further, it cuts off the inlet and forces the air through the outlet on the LH side, creating a vacuum again on the inlet side as it does so. Because of the constant contact between the rotating cylinder and the inside of the pump, oil is needed to reduce frictional heating.

Figure 5.2 shows four stages in one revolution of the rotor. The cycle is divided into induction, isolation, compression and exhaust phases. During operation gas molecules entering the inlet of the pump pass into the volume created by the eccentric mounting of the rotor in the stator. The crescent-shaped gas volume is then compressed, forcing the exhaust valve open and

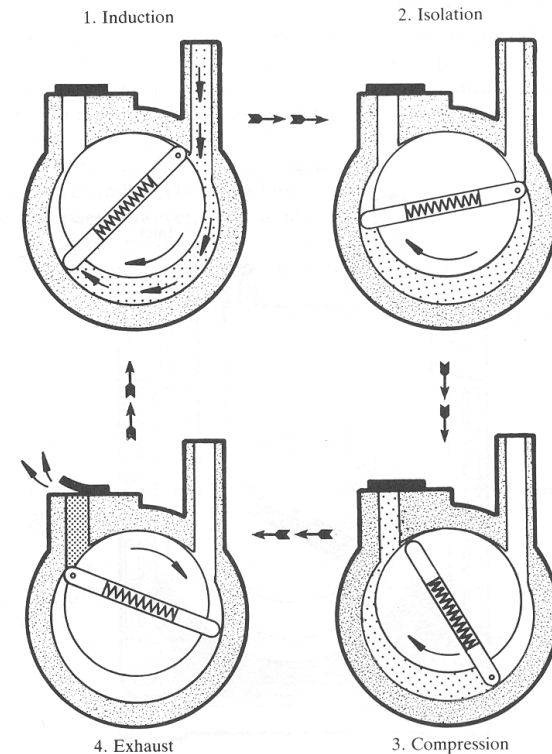

Figure 5.2 Four stages in the cycle of a rotary-vane pump

Book: N. Harris, Modern vacuum practice

Can be also oil free (i.e Scroll or **multi stage roots pump**) if the possible oil contamination in the vacuum system is a problem

2. Oil diffusion pumps ($1 - 10^{-8}$ Pa) ($10^{-2} - 10^{-10}$ mbar)

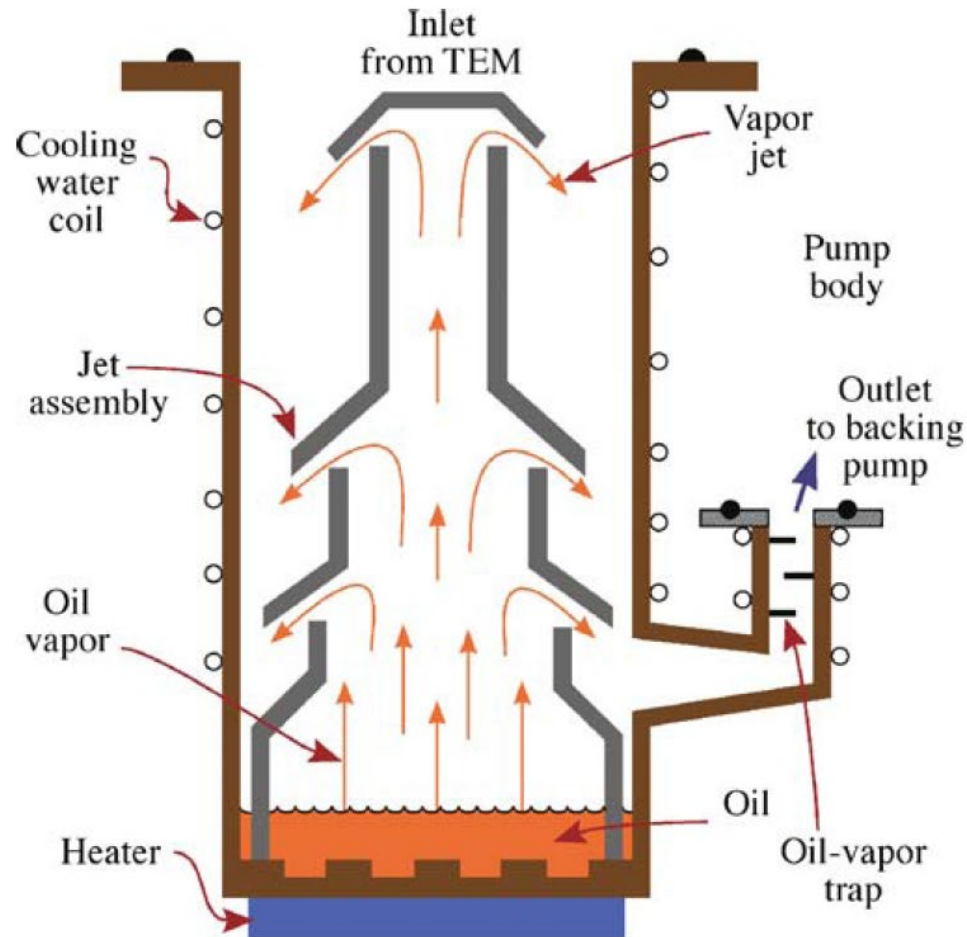

FIGURE 8.2. Principles of diffusion pump operation. A heater plate at the base of the pump boils synthetic oil. The expansion of the oil vapor on boiling creates a pressure which forces the vapor up the central column and out of several holes. The stream of oil vapor pulls gas molecules out of the top of the pump down to the base where the oil condenses and the air is pumped out of the base by a mechanical backing pump.

3. Turbomolecular pump: 10^{-2} - 10^{-10} mbar



A **turbomolecular pump** is a type of **high vacuum pump**. These pumps create a vacuum by giving gas molecules momentum by repeated collision with a rapidly spinning turbine rotor. The rotor blades collide with gas molecules from the inlet of the pump which propels them towards the exhaust in order to create or maintain a state of low pressure (a vacuum).

Rotating rotor and fixed stator blades

Rotor rotates typically 60 000 – 90 000 RPM
i.e. 1500 full rotations in second !!!

Turbomolecular pump: 10^{-2} - 10^{-10} mbar

8.1 How turbomolecular pumps work

A turbomolecular pump is a gas transfer pump which operates like an axial flow compressor used on a jet engine. Sets of moving blades, separated by stationary blades, rotate at high speed (up to $60\,000\text{ rev min}^{-1}$), receiving and compressing gas from a high vacuum chamber and delivering it to a rotary pump on the outlet side. Turbomolecular pumps are designed to operate under molecular flow conditions.

The physical basis for the pumping action is the interaction effect between a molecule and a moving surface. The short but finite residence time occurring when a molecule strikes a surface results in the molecule acquiring an additional velocity component in the direction of the moving surface (see Figure 8.1).

The orientation of the moving (rotor) blades and stationary (stator) blades to the axial direction in a turbomolecular pump is as shown in Figure 8.2. The molecule shown incident on a rotor blade will reside on the surface for a short time and then will probably leave in the direction shown due to the lateral movement of the blade and its pitch. The stator blades are also pitched. Their pitch direction is such that they preferentially transmit molecules that have left the rotors and are moving axially down the pump. Molecules moving in the reverse direction (back-diffusion) are likely to be reflected back (as shown). The other major effect of the stators is to stop the sideways movement of molecules that have been struck by the rotors, directing the molecule velocities further into the axial direction down the pump. It is rather difficult to explain the pumping mechanism of a turbomolecular pump diagrammatically because of the high rotational speed involved. However, as

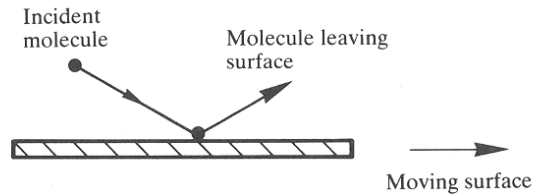

Figure 8.1 Interaction between a moving surface and an incident molecule

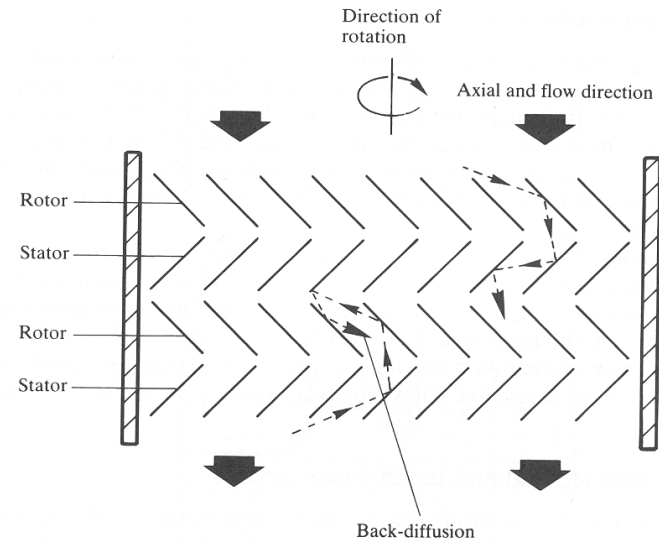

Figure 8.2 Orientation of rotors and stators in a turbomolecular pump

a result it is more probable that the molecules will be driven towards the direction of the exhaust of the pump rather than towards the inlet.

For the blades to be effective with rapidly moving molecules, the blade speeds must approach the molecule speeds; otherwise the molecules will pass through the rotor regions without being struck.

For a rotor travelling at $60\,000\text{ rev min}^{-1}$ and with a mean blade diameter of 7.5 cm , its blade tip speed is around 236 m s^{-1} (527 miles h^{-1}). By comparison, the average speed for nitrogen molecules at 20°C is 470 m s^{-1} . Heavier molecules will be slower, lighter molecules faster, such as hydrogen at 1900 m s^{-1} . Thus lighter molecules are more difficult for turbomolecular pumps to pump, because they are more likely to pass through the rotors without being hit by a blade, increasing the likelihood of back-diffusion of the gas.

Pump performance depends on blade design as well as rotor speed. Variables include the pitch angle, blade width and the distance between blades. Overall performance is optimized by varying the blade geometry through the pump. Most modern turbomolecular pump designs use a low compression, high pumping speed, open blade structure at the intake end of the pump and a high compression, low pumping speed, closed or overlapping blade configuration at the outlet end. This combination provides a good pumping speed and overall compression ratio.

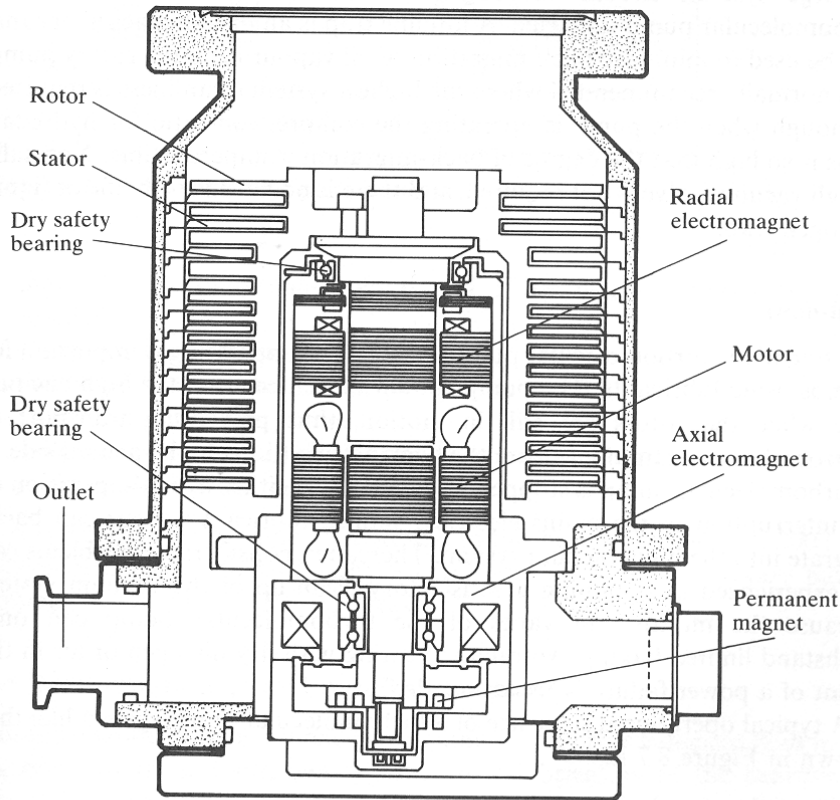

Figure 8.6 Turbomolecular pump with magnetically levitated rotor assembly



FIGURE 8.3. A turbopump (with and without its casing), which is nothing more than a small turbine that rotates at high speed. Like a jet turbine it pulls air in at the front end and forces it out of the back. The blades are designed like airfoils to enhance the flow of gas through the system.

EXHAUST PUMPS

Mechanical, diffusion, and turbopumps are all exhaust pumps; they pull in air from one end and expel it from the other.

4. Ion-pumps 10^{-5} - 10^{-11} mbar

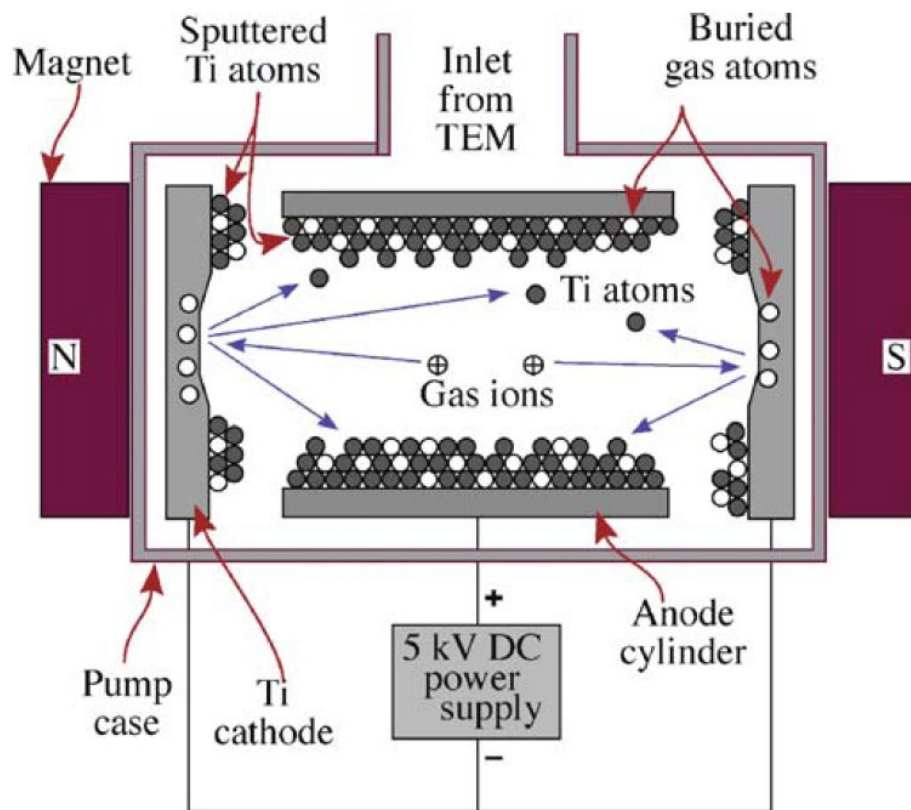

FIGURE 8.4. Schematic diagram showing how ion pumps trap ionized gas atoms by layers of Ti atoms at electrodes. Once trapped, the ions cannot escape until the pump is turned off.

8.3.C Ion Pumps

Ion pumps do not contain oil, so they cannot contaminate the TEM column. They also have no moving parts, relying solely on the ionization process to remove air. The ion pump emits electrons from a cathode. These ions spiral in a magnetic field (see Section 6.3) and ionize air molecules, which are then attracted to the cathode. The energetic gas ions sputter Ti atoms from the cathode and they condense throughout the pump chamber, mainly on the cylindrical anode, trapping gas atoms. Thus ion pumps remove gas atoms in two ways; by chemisorption on the anode surfaces and by electrical attraction to the cathodes. The smaller the ion current between the electrodes, the lower the vacuum, so the pump acts as its own vacuum gauge. Ion pumps are only efficient at high vacuums, so they are usually switched on after a diffusion pump has lowered the pressure to $< \sim 10^{-3}$ Pa (10^{-5} Torr). It is common to add ion pumps directly to the stage or gun chambers of TEMs to focus their pumping action on these important regions. Since these pumps are very common on TEMs, we include a diagram (Figure 8.4) showing how they operate.

Ion-pumps 10^{-5} - 10^{-11} mbar

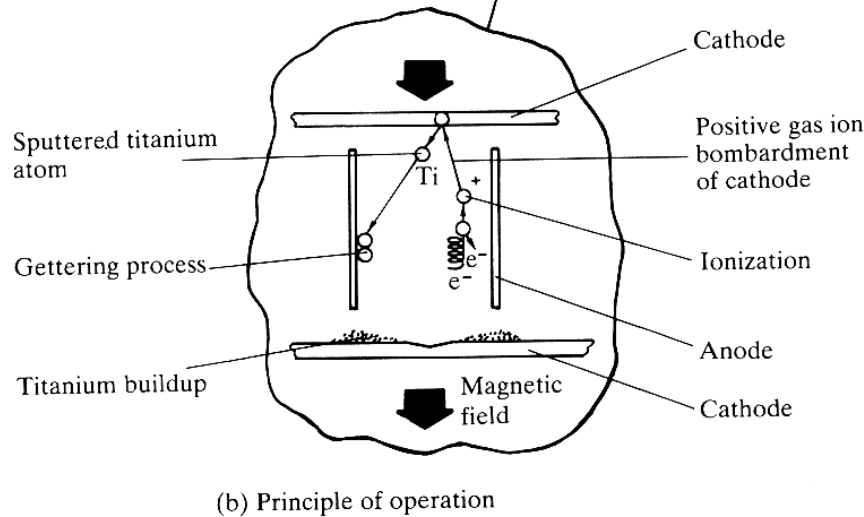
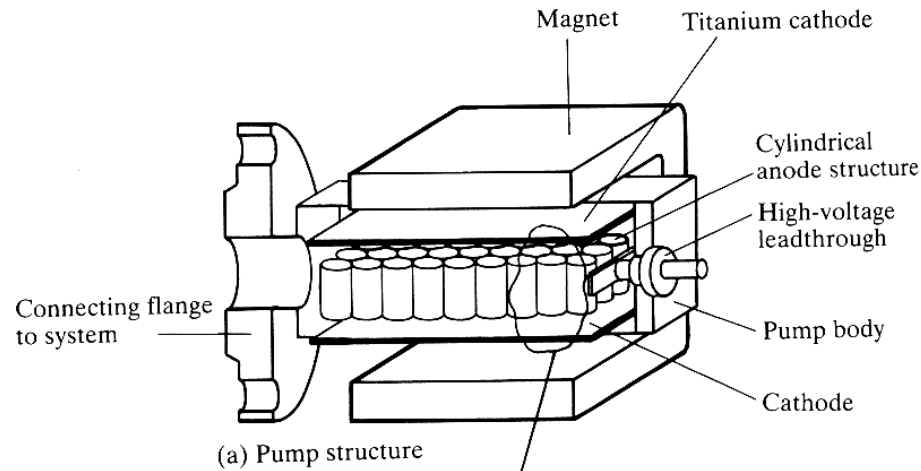
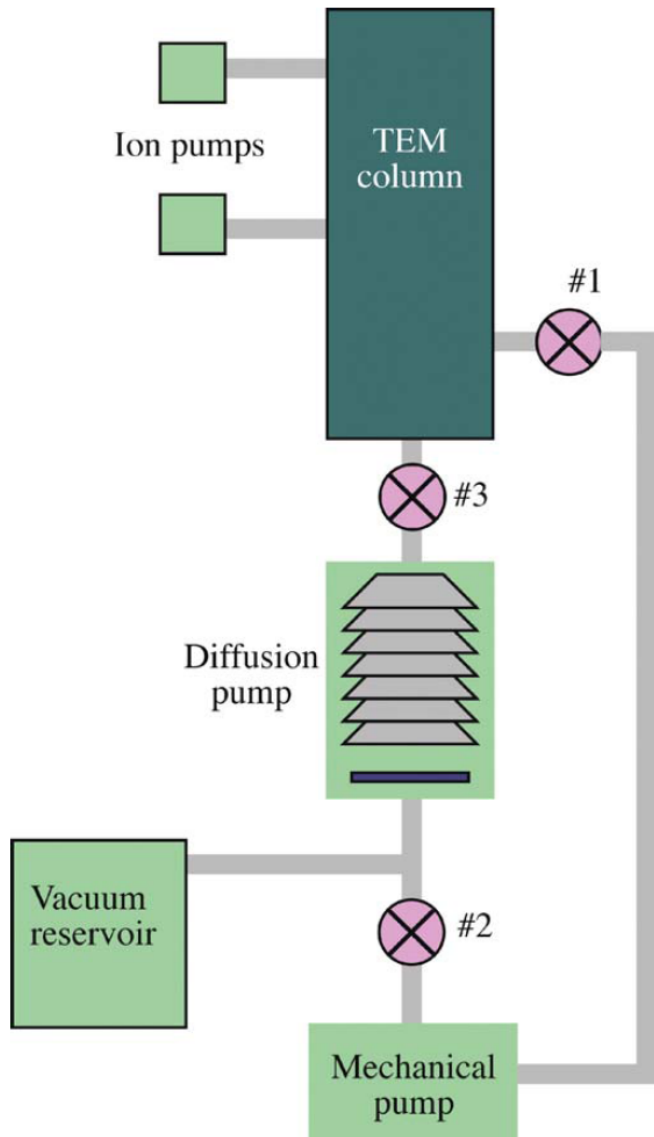

Figure 10.3 Sputter-ion pump

There are short video showing the operation principle

<https://www.gammavacuum.com/ion-pump-technology/theory-of-operation/>

Typical vacuum systems in our microscopes



TEM 120kV LaB6
(vacuum 10^{-7} mbar)

1 Ion-pump
1 Oil Diffusion pump
1 Rotary oil pump

HR-TEM FEG
(vacuum Gun 10^{-10} mbar
Column 10^{-8} mbar)

4 Ion-pump
3 Turbomolecular pumps
3 Dry pumps

FEG-SEM cold emitter
(vacuum 10^{-9} mbar)

3 Ion-pump
1 Turbomolecular pump
1 Rotary oil pump

Cryo-TEM FEG

3 Ion-pump
2 Turbomolecular pumps
2 Oil Diffusion pumps
5 Rotary oil pumps

i.e. Fully oil free system

FIGURE 8.5. The principles of the TEM vacuum system. Often, the console display on the TEM will show a similar diagram. The mechanical pump can pump the column directly or back out the diffusion pump, which is connected directly to the base of the microscope. Ion pumps are often interfaced directly to the stage and gun areas. Computer-controlled valves separate the pumps from the column and from each other.

Example – high vacuum cold-FEG system.. Low energy spread – high resolution ..

Development of a Cold Field-Emission Gun for a 200kV Atomic Resolution Electron Microscope

Yuji Kohno,¹ Eiji Okunishi,¹ Takeshi Tomita,¹ Isamu Ishikawa,¹ Toshikatsu Kaneyama,¹ Yoshihiro Ohkura,¹ Yukihito Kondo¹ and Thomas Isabell.² 1. JEOL Ltd., Akishima, Tokyo, Japan. 2. JEOL USA Inc., Peabody, Boston, MA, USA.

MICROSCOPY AND ANALYSIS NANOTECHNOLOGY SUPPLEMENT **NOVEMBER 2010**

Jeol JEM-ARM200F
**World's highest STEM (HAADF)
resolution of 0.07 nm guaranteed**
(among the commercial transmission
electron microscopes.)



2020: Jeol JEM-Grand ARM300F
Resolution guaranteed **0.045 nm** ..

VACUUM IS IMPORTANT

In a vacuum of 10^{-5} Pa, one monolayer of contaminants will form on a substrate in less than a minute.
At 10^{-8} Pa, it will take 7 hours to form a monolayer.

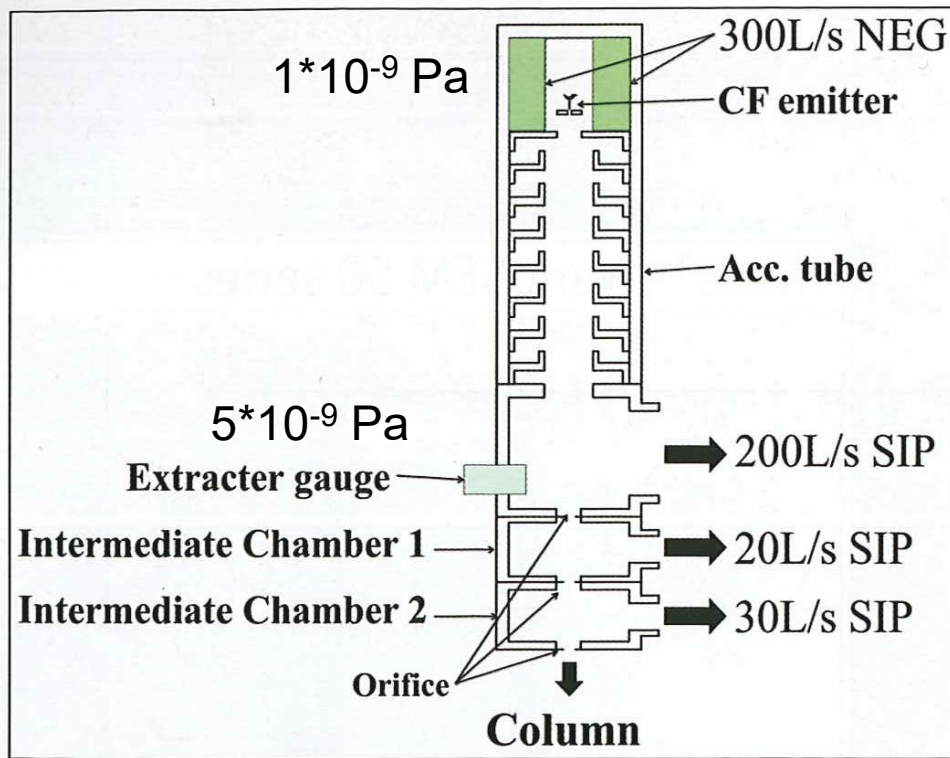

Column vacuum
typically $5 \cdot 10^{-6} - 1 \cdot 10^{-5}$ Pa

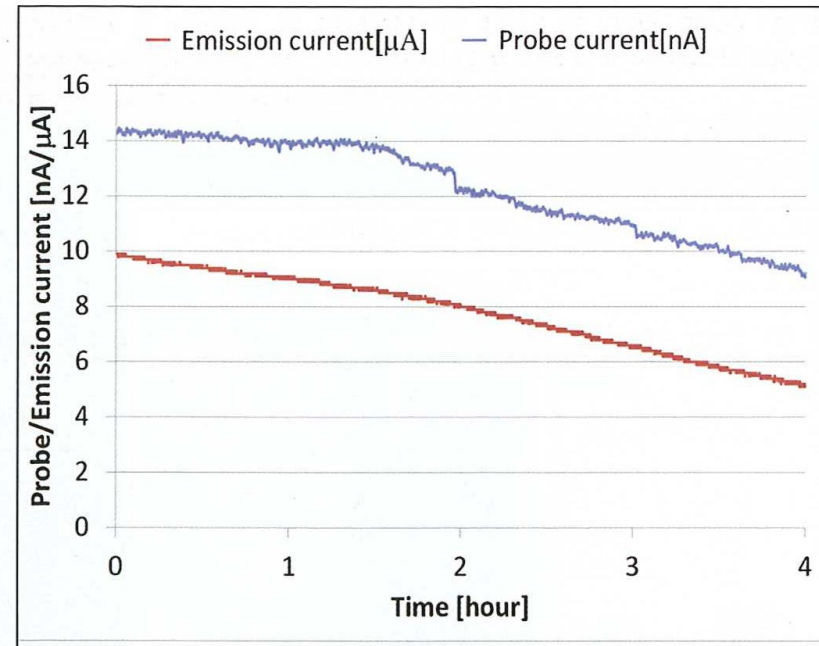

Figure 3:
Drift of the probe (blue) and emission (red) currents after flashing.

Note for NEG = Non-Evaporable Getter pump
NEGs are reactive metals that absorb Hydrogen and other atoms to surface
See example video in a page:
<https://www.ibericavacuum.com/pages/neg>

Resolution:

(Classical Rayleigh criteria)

$$\delta \approx \frac{0.61\lambda}{\beta}$$

~~Spherical
aberration~~

$$r_{sph} \sim C_s \beta^3$$

Chromatic
aberration

$$r_{chr} \sim C_0 \frac{\Delta E}{E_0} \beta$$

Figure 5a shows a raw high-angle annular dark field (HAADF) STEM image of GaN (211) at 200 kV. The 63 pm spacing between Ga-to-Ga in each dumbbell was well resolved in the intensity profile shown in Figure 5c. The Fourier transform (Figure 5b) clearly shows the information transfer to 63 pm which corresponds to this dumbbell spacing. The convergence semi angle is 29 mrad, which is experimentally confirmed to be optimum and is larger than that of the Schottky case (23 mrad). This indicates that the reduction in chromatic aberration contributes to an improved probe size.

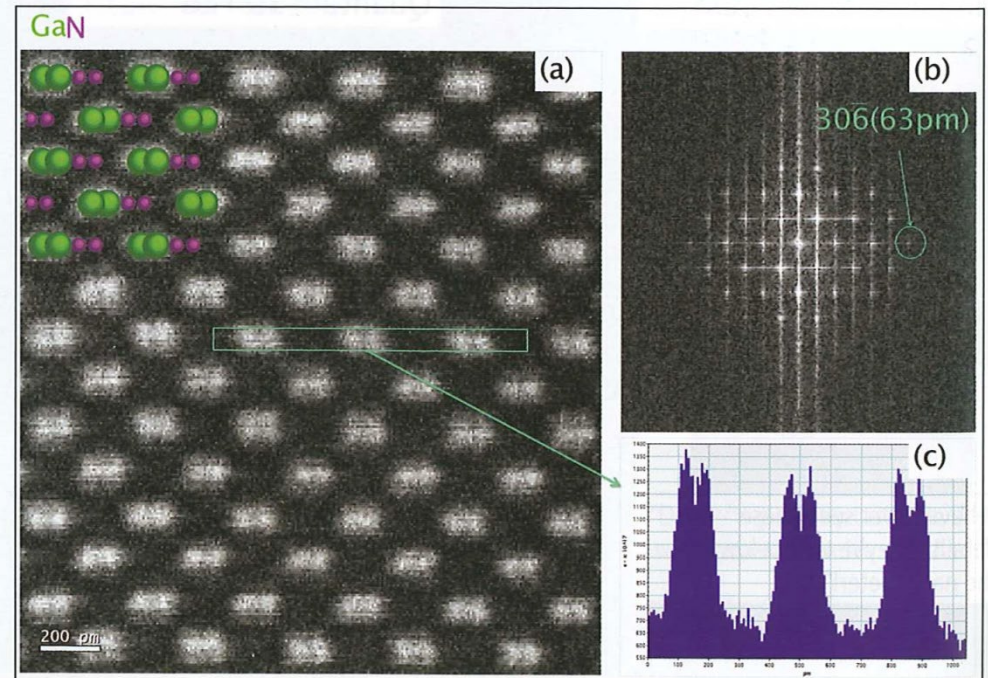
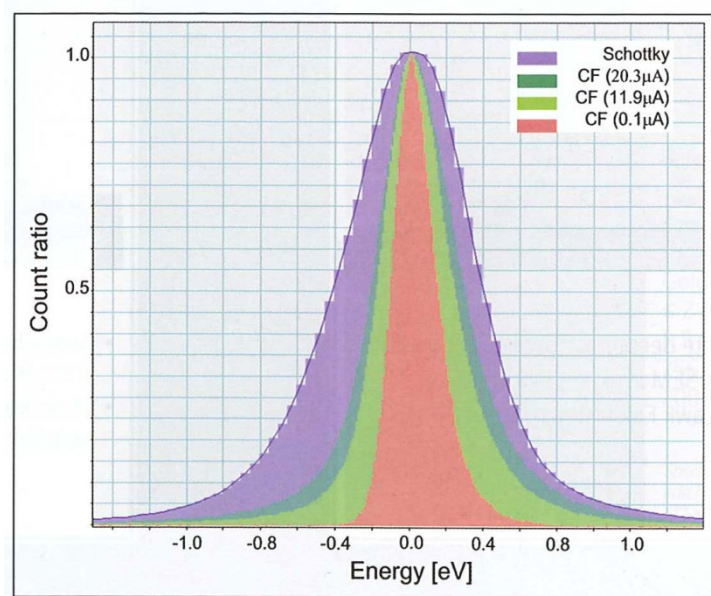

Figure 5: (a) Raw HAADF-STEM image of GaN (211) taken at 200 kV. Spacing between Ga-to-Ga is 63 pm. (b) Fourier transform of the raw image shows 306 spot which corresponds 63 pm. (c) The intensity profile of the indicated rectangular region in the raw image shows that the dumbbells are well resolved.

Grand ARM 300F resolution

Achieves STEM-ADF resolution of 40.5 pm

Figures 1 (a) and (c) show STEM-HAADF images of a GaN crystal projected along the [212] direction. (a) was acquired in single frame scan, and (c) acquired by 20 frames integration. (b) and (d) are the FFT patterns for those STEM-HAADF images. In Fig. 1(a), which was acquired in single frame, the dumbbell, which shows Ga-Ga interatomic distance of 40.5 pm is resolved. Also, in its FFT pattern (Fig. 1(b)) show the spot corresponding to 39.3 pm, as well as, one corresponding to 40.5 pm. In the STEM-HAADF image obtained by 20 frames integration in Fig. 1(c), shows the Ga-Ga dumbbell distance more clearly. And its FFT pattern, shown in Fig. 2(d), shows the spot at 36.1 pm, which is further far from one obtained in Fig. 1(b). These results show that this microscope provides exactly the highest resolution.

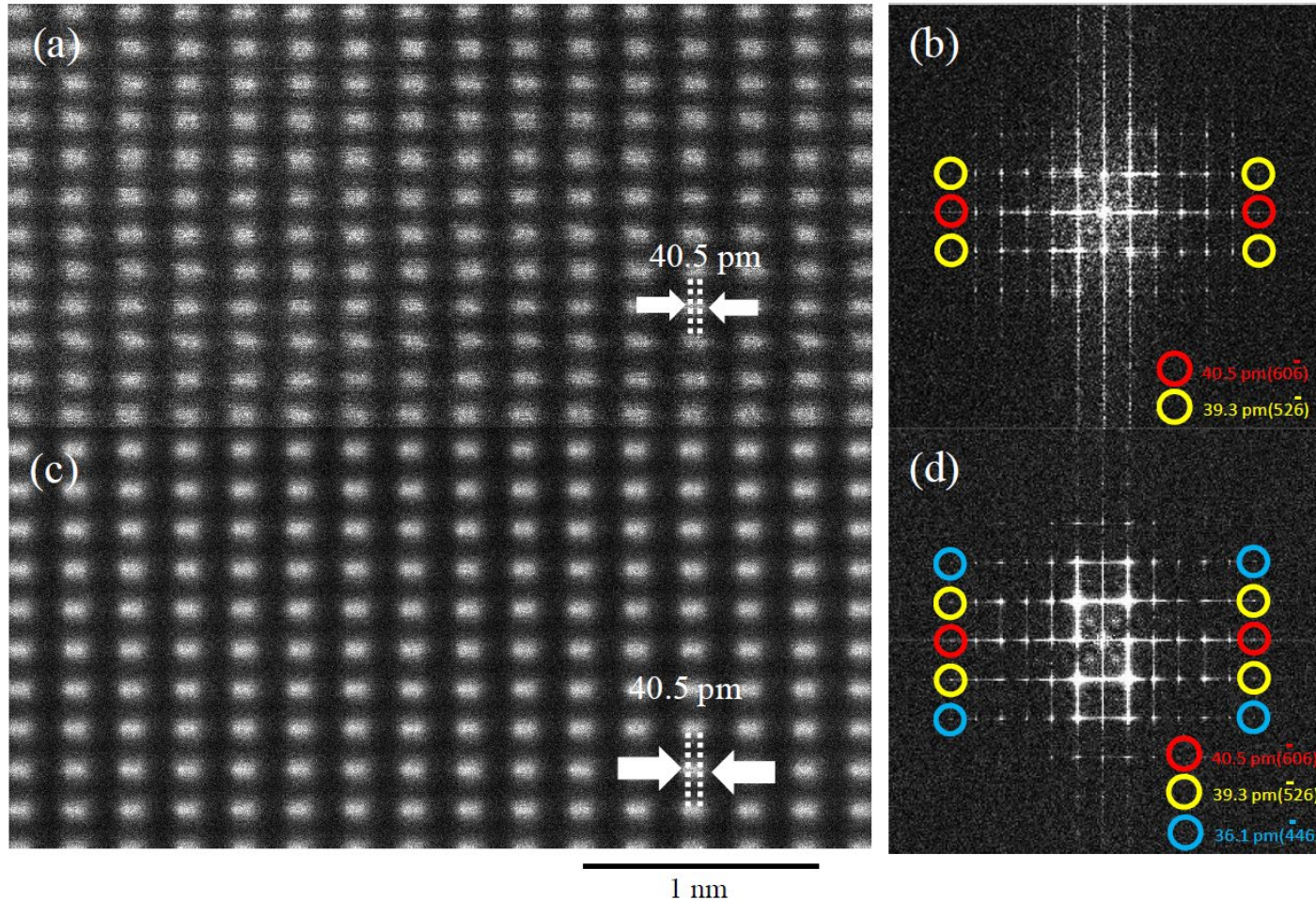

Fig. 1. (a) STEM-HAADF image of GaN [212] obtained by single frame acquisition. (b) FFT pattern of the image shown in (a). (c) STEM-HAADF image obtained by 20 frame integration. (d) FFT pattern of the image shown in (c).

8.7 SPECIMEN HOLDERS AND STAGES

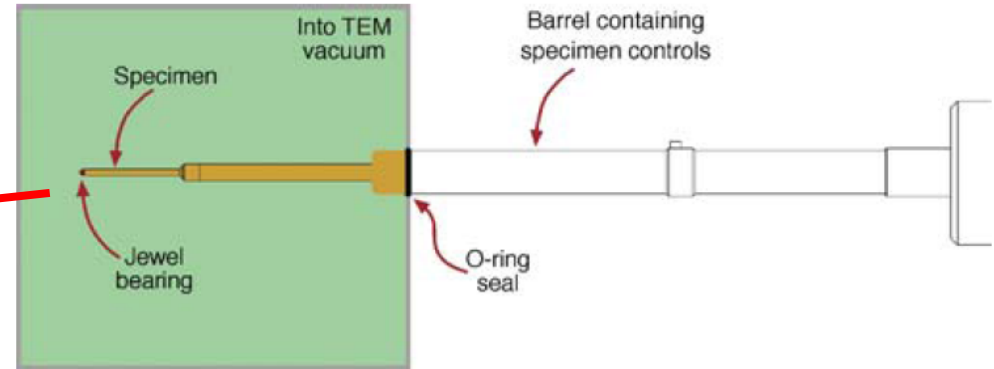

FIGURE 8.6. Principal parts of a side-entry holder that is held in the goniometer stage. The specimen is clamped into the cup at the end of the rod. A small jewel at the end of the rod (usually sapphire) fits into another jewel bearing in the stage to provide a stable base for manipulating the specimen. The O-ring seals the end of the holder inside the vacuum. Manipulating the specimen is accomplished from outside the column via controls within the rod. (See Figures 8.8–8.11 to see just where the specimen goes.)

Specimen holders:

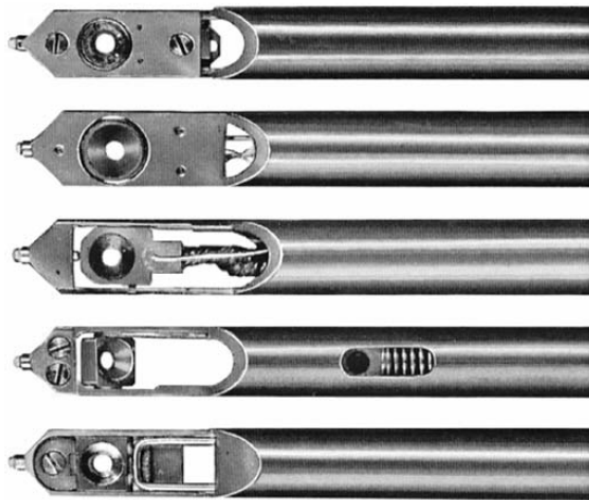
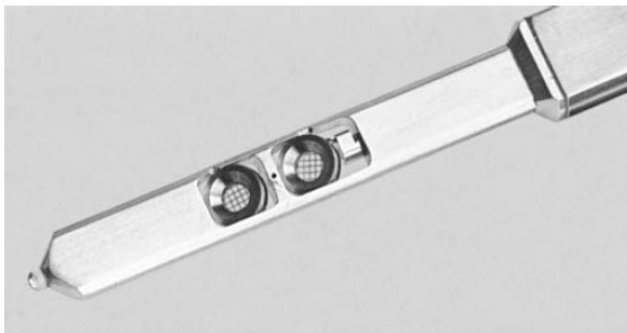

FIGURE 8.8. Examples of different designs for the side-entry holder. From the top, they are: a rotation holder, a heating holder, a cooling holder, a double-tilt holder, and a single-tilt holder.

(A)



(B)

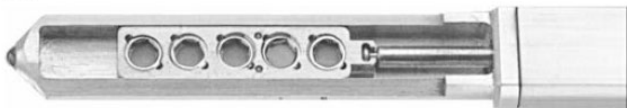

FIGURE 8.9. Multiple-specimen holders: (A) two-specimen double-tilt and (B) five-specimen single-tilt.

- *Single-tilt holder:* This is the basic holder with which any novice should start practicing. You can only tilt around the axis of the rod. It is relatively cheap, robust, and can at least give you some idea of the usefulness of tilting a specimen for diffraction contrast studies.

- *Multiple-specimen holder:* This is usually a single-tilt holder, but you can load up to five specimens into the column at one time, as shown in Figure 8.9A. A two-specimen, double-tilt version is also available (Figure 8.9B). Such holders can be useful if you are not very good at specimen preparation, or you want to compare different specimens under identical conditions without turning off the beam. However, in modern TEMs, specimen exchange is relatively quick, except in UHV instruments where the multiholder is probably more valuable.

- *Double-tilt holder:* This is the most popular holder since it gives you the most flexibility in orienting the specimen. It is absolutely essential for imaging and diffraction studies of crystalline specimens. The tilt axes are fixed as two orthogonal directions. In some designs, you can

remove the cup while the specimen is in place, which means that you can reinsert your specimen in the same orientation. This feature is extremely useful if your specimen is robust.

- *Tilt-rotate holder:* You would often like to be able to select the tilt axis. This holder lets you do just that and is particularly advantageous for the side-entry holder, since the tilt axis is then always parallel to the rod of the holder which also gives the largest tilt angle.
- *Low-background holder:* The cup and clamping ring are made of Be to minimize the generation of bremsstrahlung X-rays and characteristic X-rays. So they are required for XEDS studies. They can be double or single tilt and may be cooled also.
- *Heating holder:* Such holders in a conventional TEM can go to $\sim 1300^\circ\text{C}$, which is measured by a thermocouple attached to the cup. In HVEMs, the temperature can go higher because of the larger gap between the polepieces. You have to be careful to calibrate the temperature and remember that the temperature may be different for different specimens. You should also be sure that the material you are studying does not form a eutectic alloy with the material forming the holder! If the eutectic does form, it will have a lower melting point, so you may deposit part of your specimen and the holder on the objective lens, or down onto the screen, if the microscope is well aligned.
- *Cooling holder:* This is available for either liquid- N_2 or liquid-He temperatures. These holders, which can be single or double tilt, are a great asset for XEDS, EELS, and CBED studies since they minimize surface-borne contamination. They are also essential for *in situ* studies of superconducting materials (both high and low T_c) and ideal for polymers or biological tissue. However, you should remember that the cold holder can also act as a small cryopump, so that it actually attracts contamination. Since you are necessarily changing the temperature at the specimen relative to its surroundings, be prepared for specimen drift. It takes time for the whole system to stabilize.
- *Cryo-transfer holder:* Certain specimens are prepared at cryogenic temperatures such as liquids, latex emulsions, and tissue in general. This holder permits you to transfer such cold specimens into the TEM without water vapor from the atmosphere condensing as ice on the surface.
- *Straining holder:* This holder clamps the specimen at both ends and then applies a load to one

Some examples of Gatan Holders

Analytical

- [643 Single Tilt Analytical Holder](#)
- [646 Double Tilt Analytical Holder](#)
- [650 Single Tilt Rotation Analytical Holder](#)
- [925 Double Tilt Rotation Analytical Holder](#)

Cooling

- [613 Single Tilt Liquid Nitrogen Cooling Holder](#)
- [UHRST3500 Single Tilt Liquid Nitrogen Cooling Holder](#)
- [HCHST3008 Single Tilt Liquid Helium Cooling Holder](#)
- [ULTST Single Tilt Ultra Low Temperature Liquid Helium Cooling Holder](#)
- [UHRTR3500 Single Tilt Rotation Liquid Nitrogen Cooling Holder](#)
- [HCHTR3000 Single Tilt Rotation Liquid Helium Cooling Holder](#)
- [636 Double Tilt Liquid Nitrogen Cooling Holder](#)
- [CHDT3504 Double Tilt Liquid Nitrogen Cooling Holder](#)
- [HCHDT3010 Double Tilt Liquid Helium Cooling Holder](#)
- [ULTDT Double Tilt Ultra Low Temperature Liquid Helium Cooling Holder](#)
- [HC3500 Single Tilt Heating and Cooling Holder](#)
- [671 Single Tilt Liquid Nitrogen Cooled Straining Holder](#)
- [CHVT3007 Single Tilt Liquid Nitrogen Vacuum Transfer Cooling Holder](#)

Cryotransfer

- [626 Single Tilt Liquid Nitrogen Cryo Transfer Holder](#)
- [CT3500 Single Tilt Liquid Nitrogen Cryo Transfer Holder](#)
- [CT3500TR Single Tilt Rotation Liquid Nitrogen Cryo Transfer Holder](#)
- [910 Multi-Specimen Single Tilt Cryo Transfer Holder](#)
- [914 High Tilt Liquid Nitrogen Cryo Transfer Tomography Holder](#)
- [915 Double Tilt Liquid Nitrogen Cryo Transfer Holder](#)

Environmental

- [HHST4004 Environmental Cell Single Tilt Heating Holder](#)
- [HFST4005 Single Tilt Vacuum Transfer Holder and Furnace](#)

Vacuum Transfer

- [VTST4006 Single Tilt Vacuum Transfer Holder](#)
- [648 Double Tilt Vacuum Transfer Holder](#)
- [CHVT3007 Single Tilt Liquid Nitrogen Vacuum Transfer Cooling Holder](#)
- [HFST4005 Single Tilt Vacuum Transfer Holder and Furnace](#)

- **Heating**

- [628 Single Tilt Heating Holder](#)
- [HC3500 Single Tilt Heating and Cooling Holder](#)
- [652 Double Tilt Heating Holder](#)
- [HHST4004 Environmental Cell Single Tilt Heating Holder](#)
- [HFST4005 Single Tilt Vacuum Transfer Holder and Furnace](#)

- **Multiple Specimen**

- [677 Single Tilt Multiple Specimen Holder](#)
- [677FIB Single Tilt Multiple Specimen Holder for FIB](#)

- **Straining**

- [654 Single Tilt Straining Holder](#)
- [671 Single Tilt Liquid Nitrogen Cooled Straining Holder](#)

Tomography

- [916 High Tilt Room Temperature Tomography Holder](#)
- [927 Dual Orientation Room Temperature Holder](#)
- [912 Ultra High Tilt Room Temperature Tomography Holder](#)
- [914 High Tilt Liquid Nitrogen Cryo Transfer Tomography Holder](#)

Also more exotic holders are available..

In-situ holder for – liquid, gas, fast heating, electro chemistry, electrical probing...

See more e.g www.protochips.com and www.denssolutions.com



Our solutions all include a TEM holder equipped with a patented 3D probe scanner, a full control system with data acquisition software and a PC. The modular design supports the integration of add-ons and new functionalities.



We have the following holders..

Jeol High resolution 2200 FS and 2800 microscope:

1. Double tilt analytical holder
2. Single tilt holder
3. Heating holder
4. Cryo holder
5. *in-situ* STM conductivity/transport holder
6. *in-situ* STM conductivity/transport with double tilt
7. *in-situ* Heating and conductivity/transport with double tilt
8. Vacuum/inert gas transfer Holder “new for 2021”

Next one we want to buy is In-situ holder for liquids and electro chemistry

FEI 120kV and 200kV microscope:

- 1) Single tilt
- 2) Double tilt
- 3) Single Tilt Multiple Specimen Holder
- 4) Multi-Specimen Single Tilt Cryo Transfer Holder
- 5) Single Tilt Rotation Cryo Transfer Holder
- 6) Single Tilt Heating Holder