



Aalto University
School of Engineering

MEC-E1004 Principles of Naval Architecture

Lecture 8 – Ship power, machinery & equipment

Learning points !

After the lecture, you will be able to :

- ❑ *List and explain the function of the main components of a ship's machinery the main characteristics of common types of ship engines, machinery configurations, power transmission, and propulsion systems*
- ❑ *Recognise the methods that can help you*
 - ✓ Create and justify a machinery for your project ship
 - ✓ Define basic ship outfitting systems and explain their purpose and function
 - ✓ Select appropriate outfitting systems for your project ship considering its mission
 - ✓ Integrate the selected outfitting systems into your project ship design

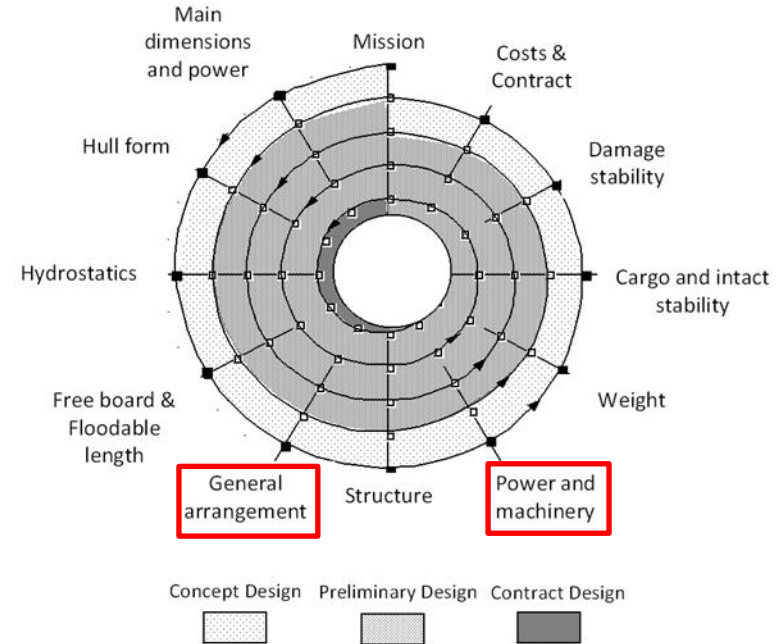

Assignment 8 (1)

- ❑ Define an example operating profile for your ship. This profile should be able to fulfill her mission. The operating profile should show how the speed of the ship varies during a typical round trip / voyage).
- ❑ Estimate your ship's resistance as a function of speed. Consider also other than hydrodynamic resistance components (e.g., wind resistance).
- ❑ Based on your resistance calculations, determine the required propulsion power to obtain the maximum speed as defined by the ship contract. Specify your reserve speed.
 - ✓ *If your ship requires an ice class, determine the required propulsion power in accordance with the Finnish-Swedish ice class rules.*
- ❑ Estimate your ship's total power demand also considering the hotel load as well as auxiliary consumers.

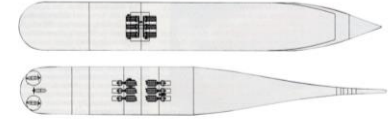

Image credit M. Bergström



Image credit Passengerships.info

Assignment 8 (2)

- Select the type and number of propulsors.
- Select energy source(s), i.e., the type(s) of engine(s) and fuel(s) used to power the ship.
- Determine a machinery for your ship. In specific :
 - ✓ *Number and types of engines*
 - ✓ *Type of power transmission*
 - ✓ *Engine room general arrangement*
 - ✓ *Check the space requirements for each component/system*
- Select and list the required equipment for your ship considering its mission.
- Define/present the properties (size, weight, etc.) of the main pieces of equipment.
- Mark the location of the equipment on the GA.

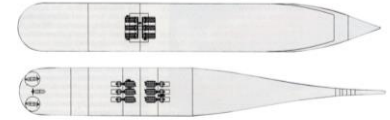

Image credit M. Bergström



Image credit Passengerships.info

Ship Machinery

❑ The purpose of a ship's machinery is to produce energy needed for ship operation (propulsion, maneuvering, and accommodation energy)

❑ General criteria

- *High power/weight ratio*
- *Limited space demand (including space for fuel tanks)*
- *High energy/cost-efficiency*
- *Environmental friendliness*
- *Safety*

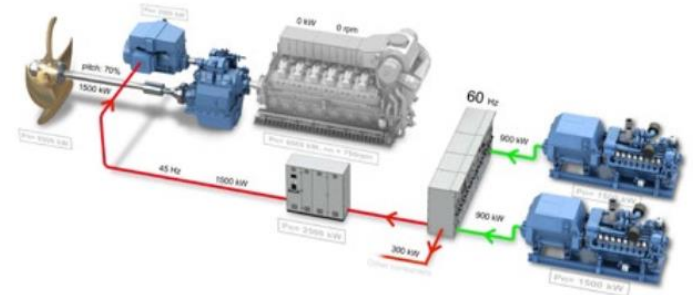

Ship Operational profile

Helps determine a ship's speed and power demand over a specific period of time (often a typical voyage)

❑ Needed to determine a ship's total power demand

- *What is the maximum peak load?*

❑ Must be considered when determining a ship's machinery configuration (e.g. number and types of engines)

- *The specific fuel consumption (SFC) and emissions of a typical marine engine depends on the engine load*

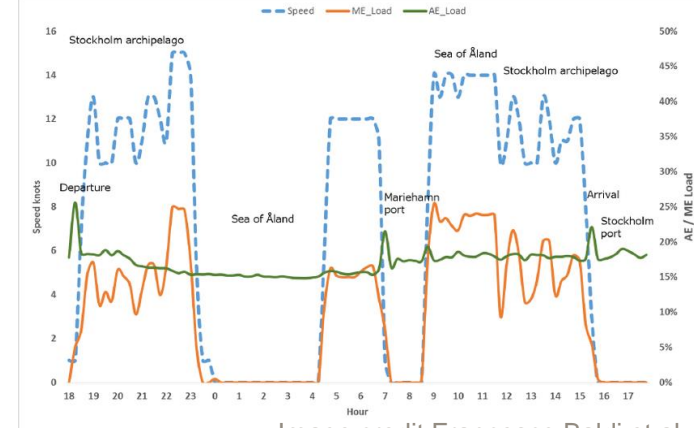

Image credit Francesco Baldi et al.

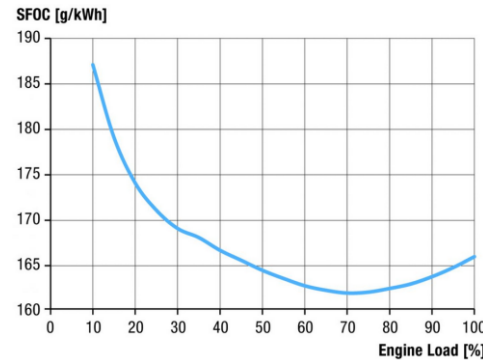

Image credit Motorship.com

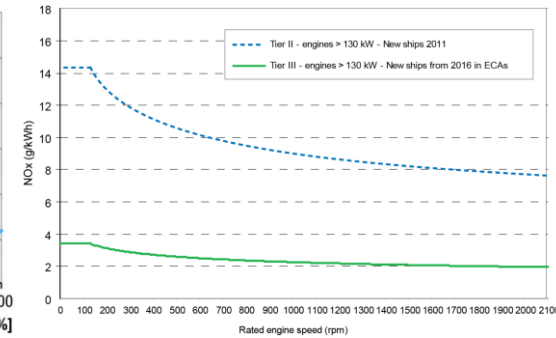

Image credit Wärtsilä

Assessment of power demand

❑ Resistance

- ✓ *A ship's total resistance on calm water can be divided into three main components: frictional, residual (wave), and air resistance*
- ✓ *Several available resistance calculation methods*
 - Holtrop, BSRA, SERIES 60, TAYLORGERTLER, etc.
 - Each method has a limited range of validity with regards to speed and hull form
- ✓ *Ice resistance dominating for icebreaking ships*

❑ Propulsion power demand

- ✓ *Determined considering speed requirements, resistance, transmission losses, propeller efficiency,...*

❑ Hotel (accommodation) demand

❑ Auxiliary power demand

- ✓ *Bow thrusters needed for maneuvering*

❑ A speed margin

- ✓ *To make sure that the contract speed is achieved and to account for fouling*

Ship Resistance (see tutorial & *.xlsx)

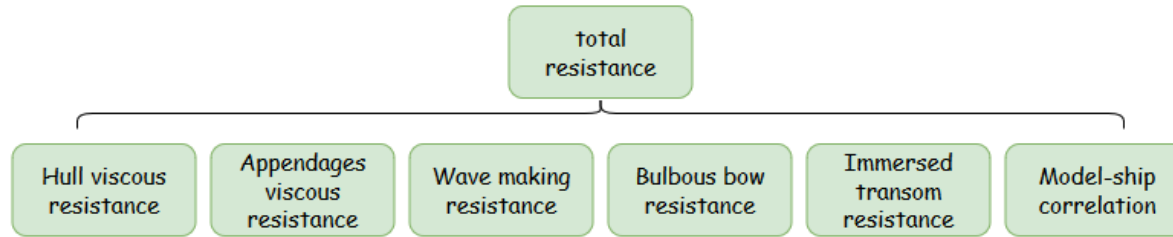

$$R_{total} = R_v + R_{APP} + R_w + R_B + R_{TR} + R_A$$

- ❑ Holtrop, J. and Mennen, G.G.J, “*A statistical power prediction method*”, International Shipbuilding Progress, Vol. 25, 1978.
- ❑ Oosterveld, M.W.C. and Oossanen, P. van, “Further computer analyzed data of the Wageningen B-screw series”, International Shipbuilding Progress, July 1975.
- ❑ Bertram, Volker, “Practical Ship Hydrodynamics”, Elsevier, 2012.

Ship Energy sources

- Fuel oil
 - ✓ Various qualities: HFO, MDO, MGO,...
- Natural gas (LNG)
- Bio-fuels
 - ✓ Ethanol, methanol,...
- Nuclear fuel
- Wind
- Sun

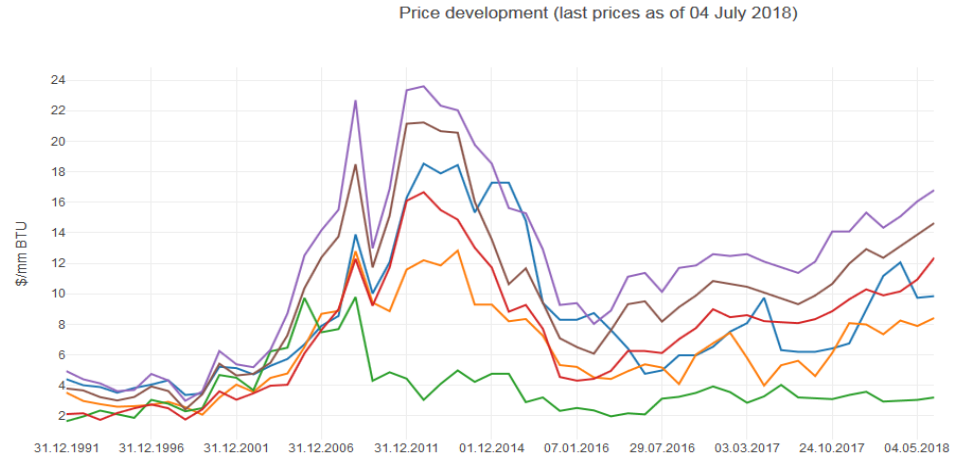

Factors to be considered when choosing an energy source

- Energy density
- Price
- Availability
- Operational profile

— Japan gas price (ltv, \$/mmBTU, y)
— EU gas prices (ltv, \$/mmBTU), y
— Henry Hub (ltv, \$/mmBTU), y
— IFO 380 (\$/mmBTU), y
— 0,1 MGO BW (\$/mmBTU), y
— Crude oil (brent) \$/mmBTU, y

Image credit DNVGL

Energy sources – different energy densities

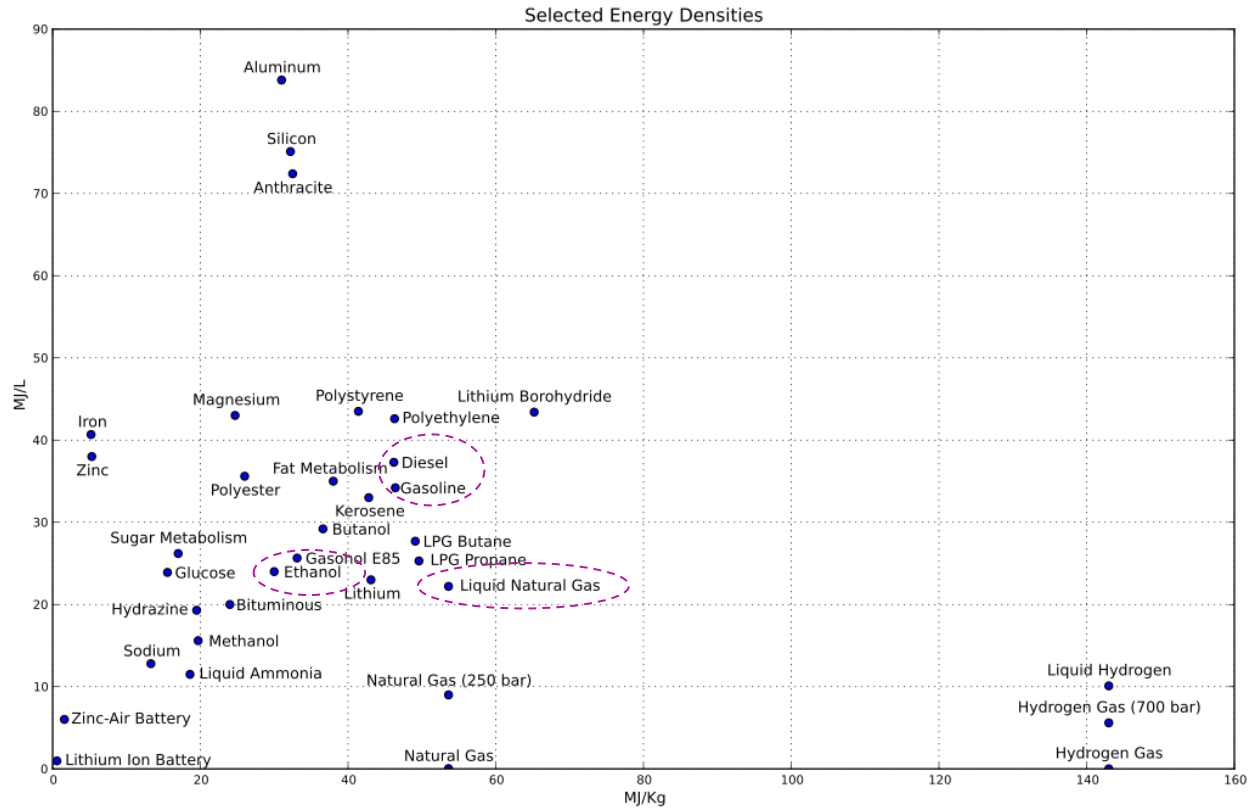

Machinery components

❑ Main engine(s) + Auxiliary engine(s)

✓ Options include

- Slow/medium/high speed diesel
- Steam/gas turbine
- Dual fuel engines (diesel, LNG)

❑ Power transmission

✓ Options include

- Mechanical direct and gear-drives
- Electric
- Hydraulic

❑ Propulsion device(s)

✓ Options include

- Fixed / controllable pitch propellers
- Thruster, waterjet
- Paddle wheel, air propulsion

❑ Fuel tanks/systems

❑ Control/automation systems

❑ Auxiliary systems

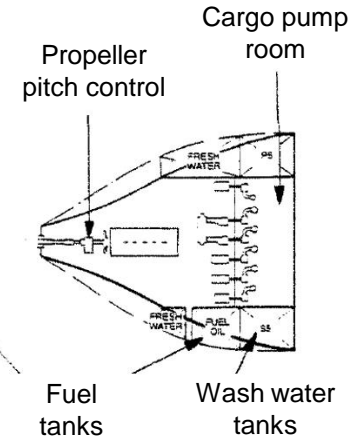
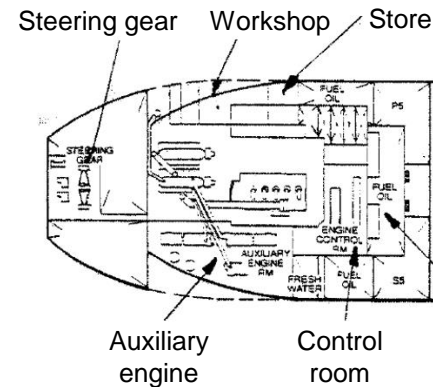
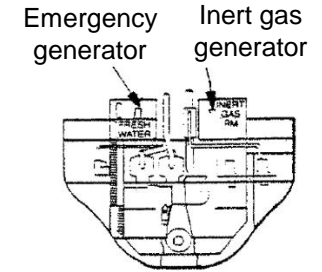
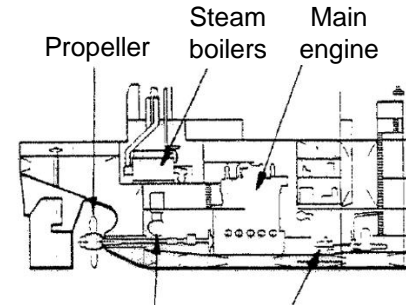

History – Steam engines

Early 1800s → End of WW2

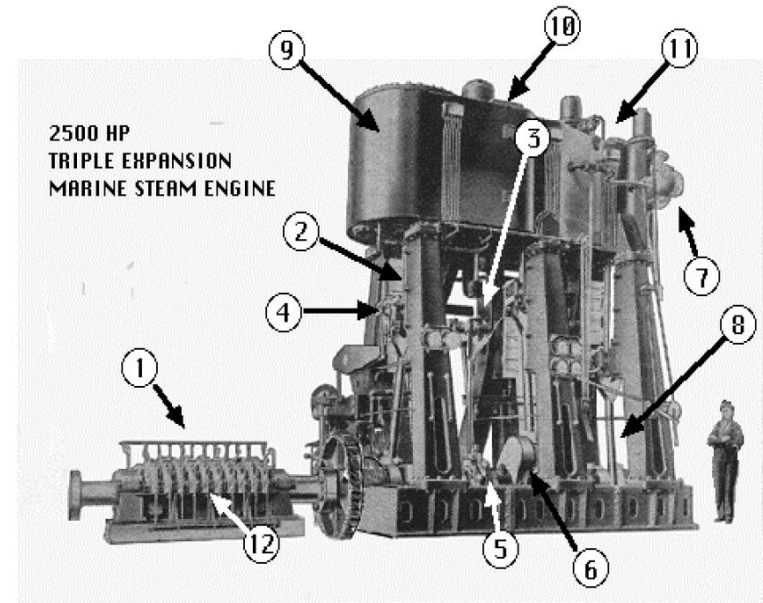
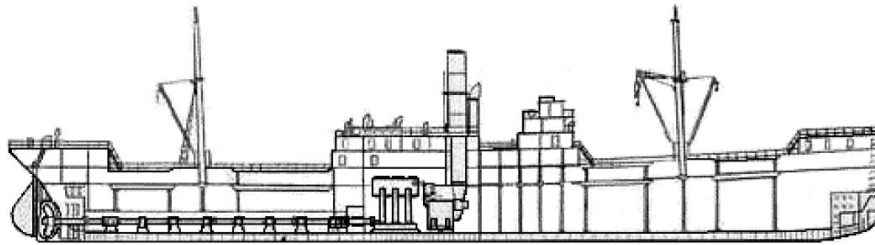

Different types of marine engines

❑ Diesel engines

✓ *Classified based on*

- Based rotating speed
 - Low speed engine (< 400 rpm)
 - Medium speed engine (400 – 1,200 rpm)
 - High speed engine (> 1,400 rpm)
- Operating principle
- Two-stroke
- Four-stroke



High speed engine. Image credit Caterpillar



Low speed engine. Image credit Wärtsilä



Steam turbine. Image credit MHI



Gas turbine. Image credit General Electric



Medium speed engine. Image credit Wärtsilä

❑ Steam turbines

❑ Gas turbines

Low-speed 2 - stroke diesel engine

- ❑ Rotational speed: 60 - 250 rpm
- ❑ Enables direct drive (no transmission)
- ❑ High fuel-efficiency
 - ✓ *SFC 160 g/kWh - 180 g/kWh (with HFO)*
- ❑ High power
 - ✓ *1-50 MW (0.7-4 MW per cylinder)*
 - ✓ *Number of cylinders: 4 -12*
- ❑ Quite heavy
 - ✓ *20 - 40 kg/kW*
- ❑ Expensive to build/purchase
 - ✓ *400 - 500 USD/kW*
- ❑ Large in size
- ❑ Common on large cargo ships excluding RORO ships

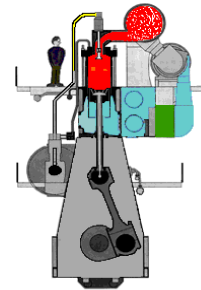
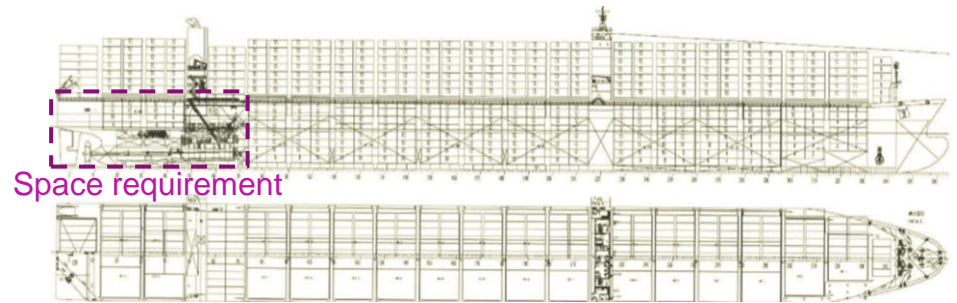

Example

- Main Engine for 8200 TEU container ship
 - *Max. power: 68,7 MW*
 - *Fuel consumption: 230 t/day at 25 kn*

Medium-speed 4 - stroke diesel engine

- ❑ Rotational speed: 400 - 800 rpm
 - ✓ Reduction gear / transmission needed
 - ✓ Often electric power transmission
- ❑ Medium fuel-efficiency
 - ✓ SFC 170 g/kWh - 190 g/kWh (with HFO)
- ❑ Medium power
 - ✓ 0.4-1.3 MW per cylinder
 - ✓ In line engine with 6,9, or 12 cylinders
 - ✓ V-engines with 12,16, or 18 cylinders
- ❑ Relatively low weight
 - ✓ 8 - 20 kg/kW
- ❑ Relatively low price
 - ✓ 200 - 300 USD/kW
- ❑ Relatively small in size
- ❑ Flexible, often used in multi-engine installations
- ❑ Common on passenger ships, RORO ships, and icebreakers

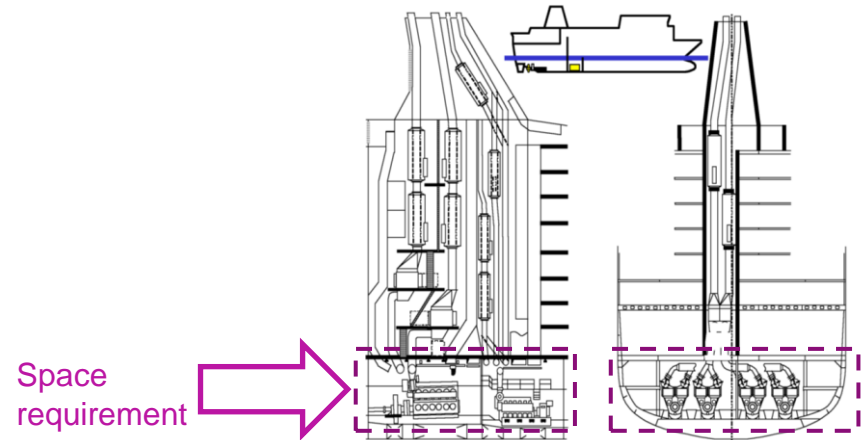

Image credit ship-technology.com

High-speed 4 - stroke diesel engine

- ❑ Rotational speed: $>1,400$ rpm
 - ✓ *Reduction gear / transmission needed*
- ❑ Relatively low fuel-efficiency
 - ✓ *SFC 220 g/kWh - 240 g/kWh (with MDO, HFO generally not suitable)*
- ❑ Power range
 - ✓ *100 - 7,500 kW*
- ❑ Often V-engines, up to 20 cylinders
 - ✓ *Relatively complicated and expensive engines*
- ❑ Low weight and small size
 - ✓ *4 - 7 kg/kW*
- ❑ Relatively expensive
 - ✓ *200 - 300 USD/kW*
- ❑ Common on fast ships, naval ships, small vessels / boats
- ❑ Also used as (emergency) generators on bigger ships



Medium speed engine. Volvo Penta

Steam turbines

- ❑ Require a steam generating plant (boiler)
 - ✓ *Steam pressure approx. 60 bar, steam temperature approx. 510 C*
 - ✓ *Flexibility with regard to fuel types*
- ❑ Relatively low fuel-efficiency
 - ✓ *SFC 230 g/kW - 290 g/kW, depending on steam circulation and power*
- ❑ Engine price is comparable to the price of a medium speed diesel engine
- ❑ Qualitative attributes: large and heavy boiler facility, simple, reliable, high power
- ❑ Used on: large tankers, LNG-ships, warships, nuclear powered ship



Image
Kawasaki Heavy Industries

Gas turbines

- ❑ Many different names: Jets, turbojets, turbofans, and turboprops (in aviation applications)
- ❑ Also industry applications
- ❑ Main components
 - ✓ *Compressor, combustion chamber, turbine and power turbine*
- ❑ Relatively low fuel efficiency
 - ✓ *220 - 260 g/kWh depending on operating conditions*
 - ✓ *Required high quality Marine Gas Oil (MGO)*
- ❑ Low weight power ratio, and high unit power
 - ✓ *0,8 - 1,2 kg/kW,*
 - ✓ *10 - 30 MW/unit*
- ❑ Price around
 - ✓ *280 USD/kW*
- ❑ Qualitative attributes
 - ✓ *Light, small, high fuel consumption, reliable, environmentally friendly*
- ❑ Used on
 - ✓ *Fast ships, naval vessels, ships with multi-engine machineries, cruise vessels*



Image - MHI, Japan

Diesel-electric machinery

- ❑ Diesel-driven machinery with electric power transmission
- ❑ Main components
 - ❑ *Diesel generator(s) (also referred to as genset), electric switchboard(s), electric propulsion motors, control room*
- ❑ Power plant principle
- ❑ Well suited for
 - ✓ *Passenger/cruise ships*
 - Significant electricity demand for hotel operations, varying ship speed
 - ✓ *Icebreakers*
 - High torque on propeller shaft in ice, rpm –control
 - ✓ *Cable and drill ships*
 - Onboard equipment that requires lots of electricity

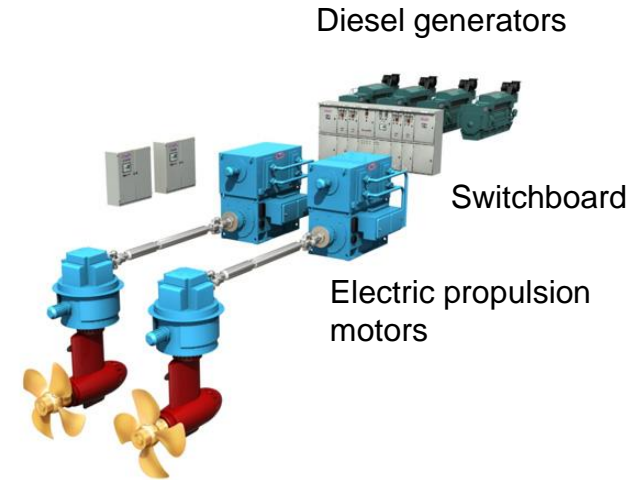

Image credit Marineinsight.com

Electric/hybrid propulsion

Pros

- ❑ No aerial emissions when operating on electric power
- ❑ Simple, reliable, and low-maintenance machinery (if pure electric solution)
- ❑ A hybrid solution enables (short) power bursts
 - *Relevant for instance for icebreakers, tugs*

Cons

- ❑ Heavy batteries
- ❑ Limited energy storage capability of batteries
- ❑ Price (hybrid = double systems)



Hybrid car ferry Elektra. Image credit Yle

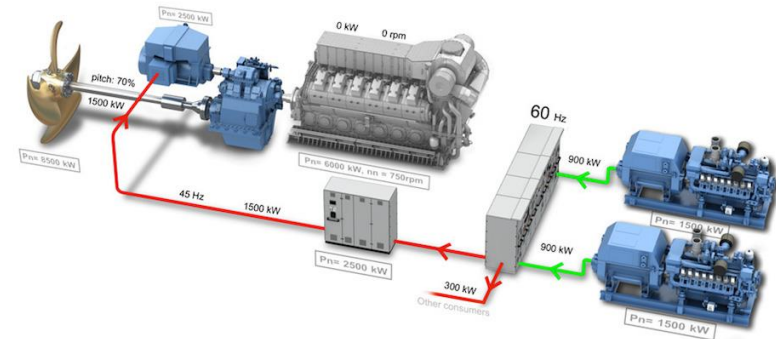

Hybrid propulsion system. Image credit Berger Maritiem

Machinery design

General Arrangement

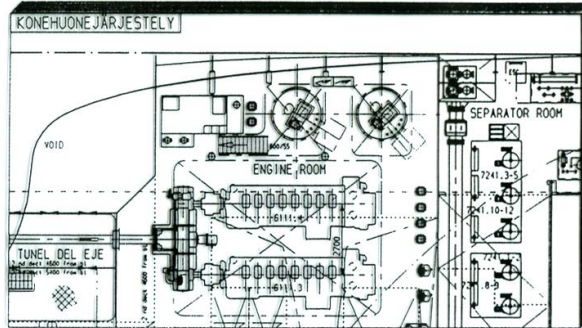

System diagrams

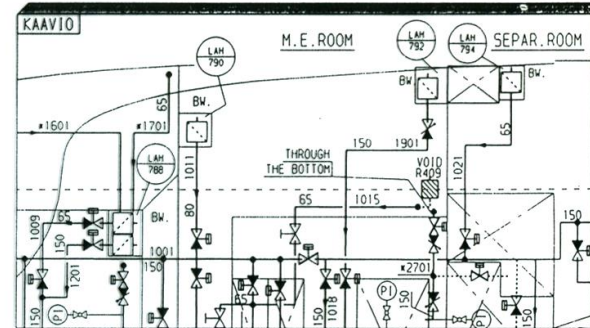

3D-collision analyses

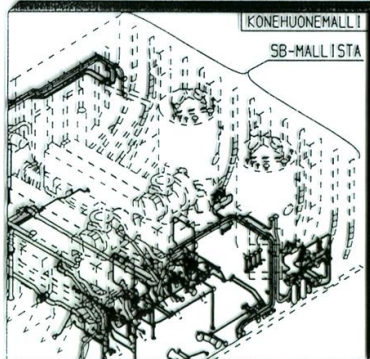

Installation drawings

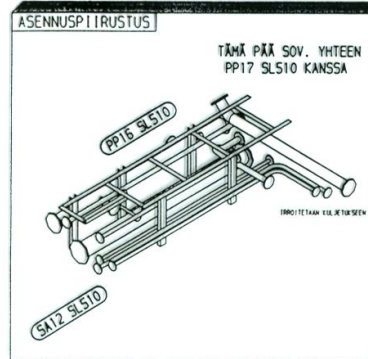

Production drawings

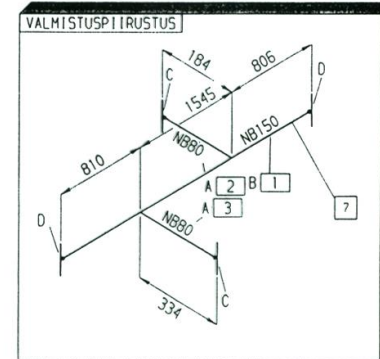

Electric system design

System diagram

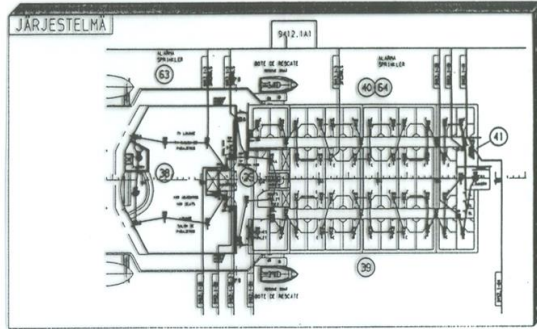

Cabling

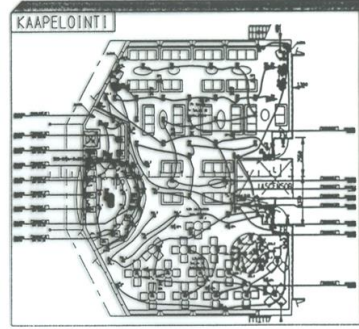

KAAPELINVETO

SLAIVA L1318	AJOPIN 920902
SLAIVA L1318	AJOPIN 920902
KAAPELINO	KAAPELITYPPI
KAAPELINO	KAAPELITYPPI
#211.1-57	LINJUSI.5
	1.216.318.8211.901 BSC
700 600 500.1 500	450 469 467
418.1 409.5 475	476 492 493 484
#211.1-58	LINJUSI.5
	1.216.318.8211.901 BSC
700 600 500.1 500	450 469 467
418.1 409.5 475	476 492 493 484
#211.1-68	LINJUSI.5
	1.216.318.8211.901 BSC
822 704 701 700	600 500.1 500
416 417 418 418.1 409.5	475 476

Circuits

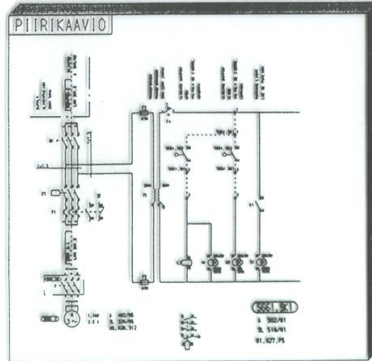

Layout

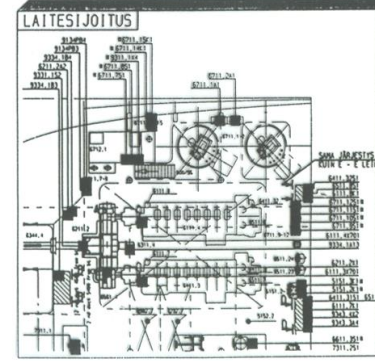
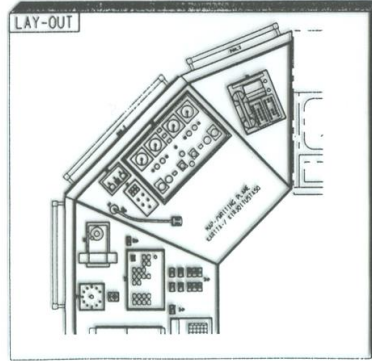

24.9.92

Steering and manoeuvring

Question: By what means can a ship be manoeuvred?

Steering and manoeuvring

❑ System components

- ✓ *Steering device, transverse thrusters, control systems (hydraulics, etc.)*

❑ Different types of steering devices

- ✓ *Rudder*
- ✓ *Steering propeller (azimuth thruster)*

❑ Rudder

- ✓ *Purpose: To generate a lateral force that adjusts/maintains the bearing of a ship*
- ✓ *Location: At the stern of the ship, behind the propeller(s), so that it directs the propeller stream*
 - One rudder behind each main propeller
- ✓ *Important measures*
 - The lateral (turning) force (lift) as a function of the rudder angle
 - The required moment to turn the rudder
 - Rudder area, which should be about $0.02 \cdot L \cdot T$
 - The maximum rudder angle (typically 35°)
 - Cross section profile (standard profiles developed by the National Advisory Committee for Aeronautics (NACA) are commonly used)

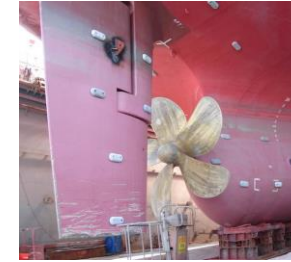
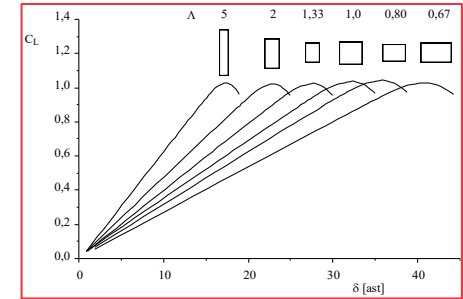
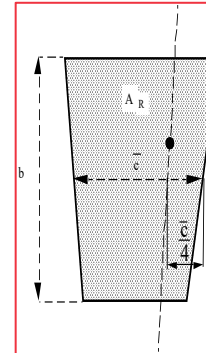

Image credit
marineinsight.com



Image credit RM propulsion



Effect of rudder angle (δ) and area ratio (L) on the rudder's lift coefficient (C_L)

Propulsors (Propeller)

Convert rotational motion into thrust by producing a pressure difference between the forward and rear surfaces of the propeller blades

- ❑ Most marine propellers are screw propellers with fixed helical blades rotating around a propeller shaft
- ❑ Controllable-pitch propellers are also common

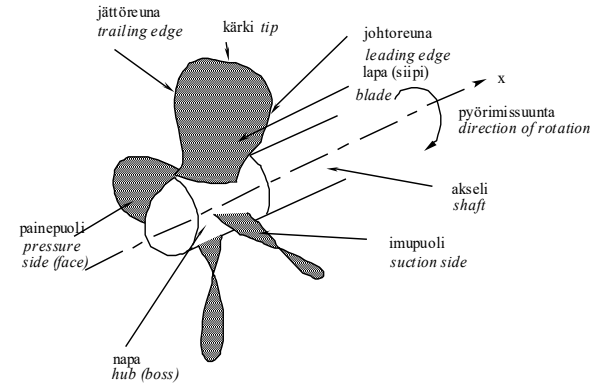

Image credit Wärtsilä

Propulsors (Azimuth thrusters / Pods)

- ❑ Mechanical or electric drive
- ❑ Product names
 - ✓ *Azipod (ABB), Merimaid (Rolls-Royce),...*
- ❑ Advantages
 - ✓ *Rotating 360°, excellent maneuvering capability*
 - ✓ *Good hydrodynamics*
 - ✓ *Low vibration*
 - ✓ *Efficient use of on-board space (with electric transmission)*
- ❑ Disadvantages
 - ✓ *High price*
 - ✓ *Lower energy efficiency than traditional mechanical transmission*
- ❑ Common on cruise ships, ice-going/breaking ships, supply ships

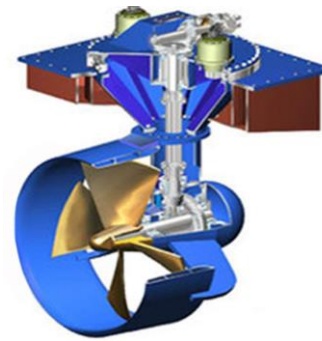

Image credit Hi-SEA

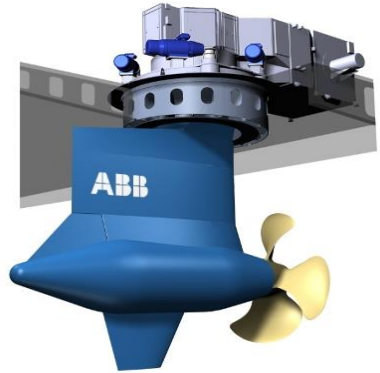

Image credit Meyer Werft

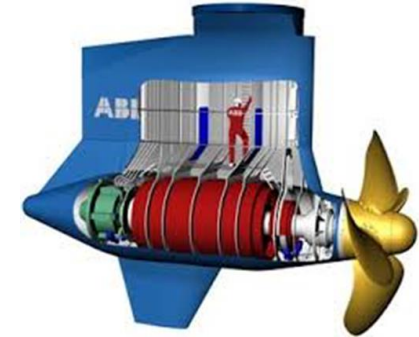

Image credit ABB

Water jet propulsion

- ❑ Low hydrodynamic resistance
 - ✓ *Efficient for fast vessels (approx. 25-40 kn)*
- ❑ Provides excellent maneuvering capability
- ❑ Tough, reliable
- ❑ Well suited for
 - ✓ *Navy ships, SAR vessels, yachts, fast catamarans*

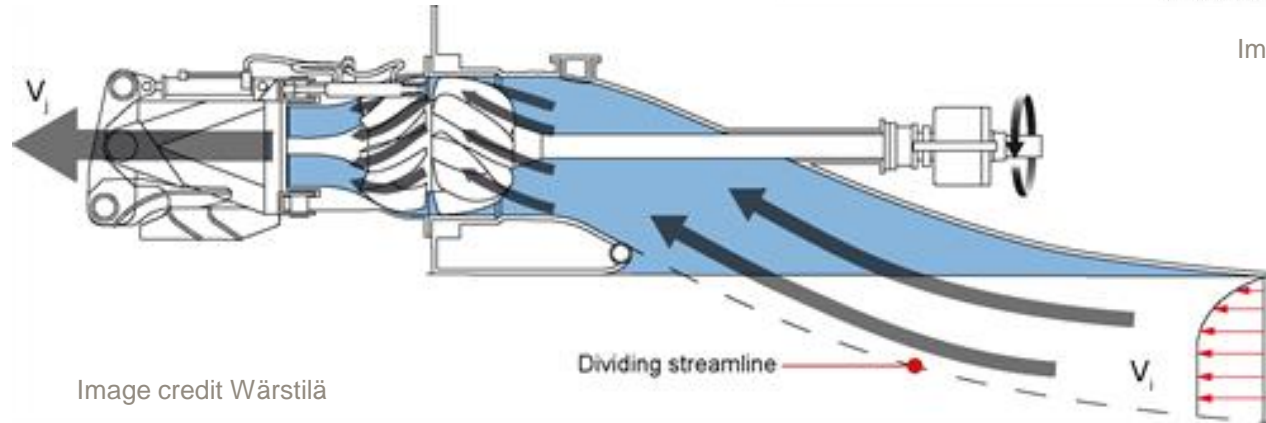
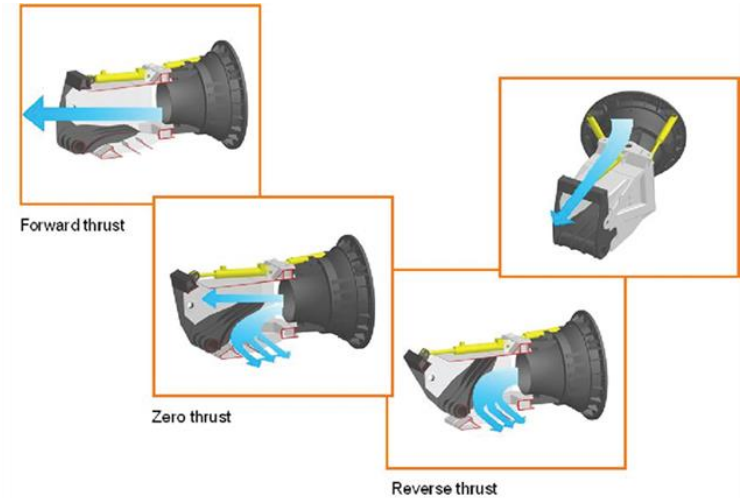

Image credit Wärstilä

Image credit Wärstilä

Steering and manoeuvring - Rudders

❑ Spade / Balanced rudder

- ✓ *Balanced* → requires little steering energy

❑ Unbalanced rudder

- ✓ *Poor hydrodynamic characteristics*
- ✓ *Makes it difficult to maintain the propeller shaft*
- ✓ *Uncommon nowadays*

❑ Semi-balanced rudder

- ✓ *Good hydrodynamics*
- ✓ *Facilitates maintenance of the propeller shaft*
- ✓ *Returns to the centerline orientation on its own if the steering gear equipment fails during a turn*

❑ Flaps rudder

- ✓ *Provides improved maneuverability*

Spade / Balanced rudder

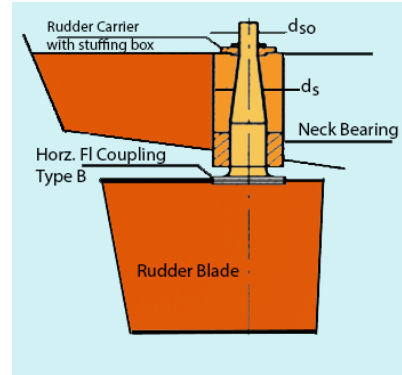

Unbalanced rudder

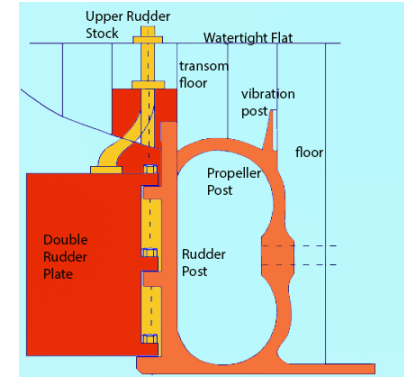

Semi-balanced rudder

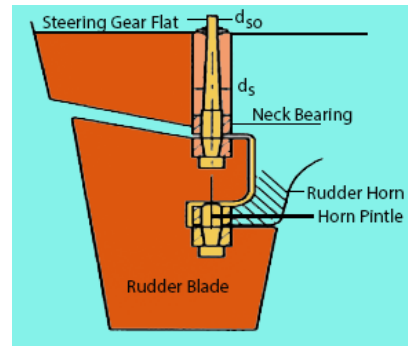

Flaps rudder

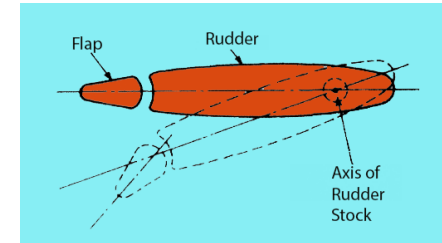

Image credit marineinsight.com

Steering and manoeuvring - Thrusters

- ❑ Typically located in the bow (bow thruster) and aft (aft thruster)
- ❑ Purpose: to produce lateral force to assist maneuverings at very low speed (< 5 kn, primarily in port areas)



Image credit marineinsight.com

Equipment

Anchoring systems

❑ Anchoring system components

- ✓ *Anchor, anchor chain, anchor handling equipment*

❑ Purpose of anchoring

- ✓ *To maintain a ships position in shallow water without the use of the ship machinery*
- ✓ *In emergency, to prevent grounding, collision or allusion (the running of one ship upon another ship that is stationary)*

Ships typically have two bow anchors for high operational reliability and low yawing
Ships operating on rivers and/or channels are typically also fitted with a stern anchor

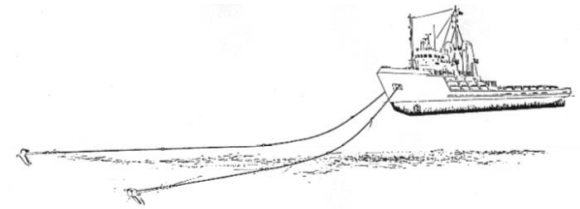

Image credit Marine Insight

Anchoring system

- ❑ **The forces exerted on a ship's anchor system originate from the forces caused by wind, current and waves as well as the ship motions**

- ✓ *The force acting on an holding anchor is acting along the sea bottom, i.e. horizontally. If the force acts in vertical direction, it will act upon heaving the anchor up from the sea bottom*

- ❑ **The weight of a ship anchor is measured in tons and it is based on the ship size (wind area) and anchor type**

- ✓ *The holding capacity of an anchor is measured by the relationship of its holding power (force!) and its weight*
 - The seabed characteristics affect on the holding force of an anchor
- ✓ *Anchor types*
 - Stockless anchor (most common)
 - Stock anchor

Stockless anchor

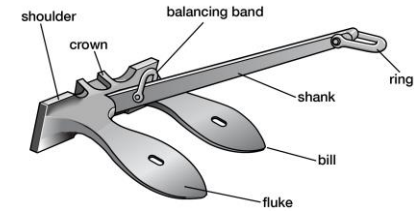

Stock anchor

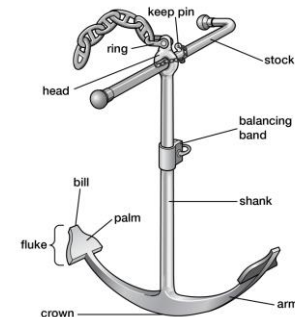

Image credit Encyclopedia Britannica

Anchoring chain

❑ The length and weight of the anchor chain significantly affect the holding capacity of an anchor

- *The chain must be long enough*
 - to act on the anchor horizontally
 - to dampen stopping forces (a section of the chain is lifted upwards from its resting position on the sea bottom)
 - The behavior of an anchor chain can be modeled by applying the *catenary curve*

❑ Chain dimensions and length are determined considering class rules

- *The required chain length is determined in hundreds of meters*

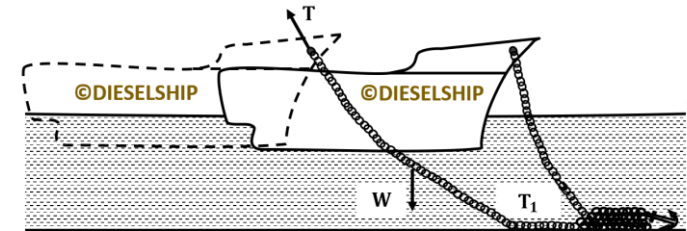
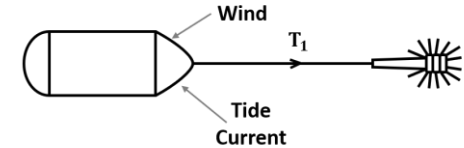

Image credit BP shipping



Anchoring chain dynamics

The forces acting at both ends of a chain can be assessed using the *catenary curve*

1. The horizontal force (F_x) is constant along the chain
2. The vertical force (F_y) at any point is equal to the weight of cable that that point is carrying ($\rightarrow F_y = 0$ at the bottom of the loop)

The angle of the cable at any point is determined by resolving these forces, e.g. $\text{TAN}^{-1}(F_y/F_x)$

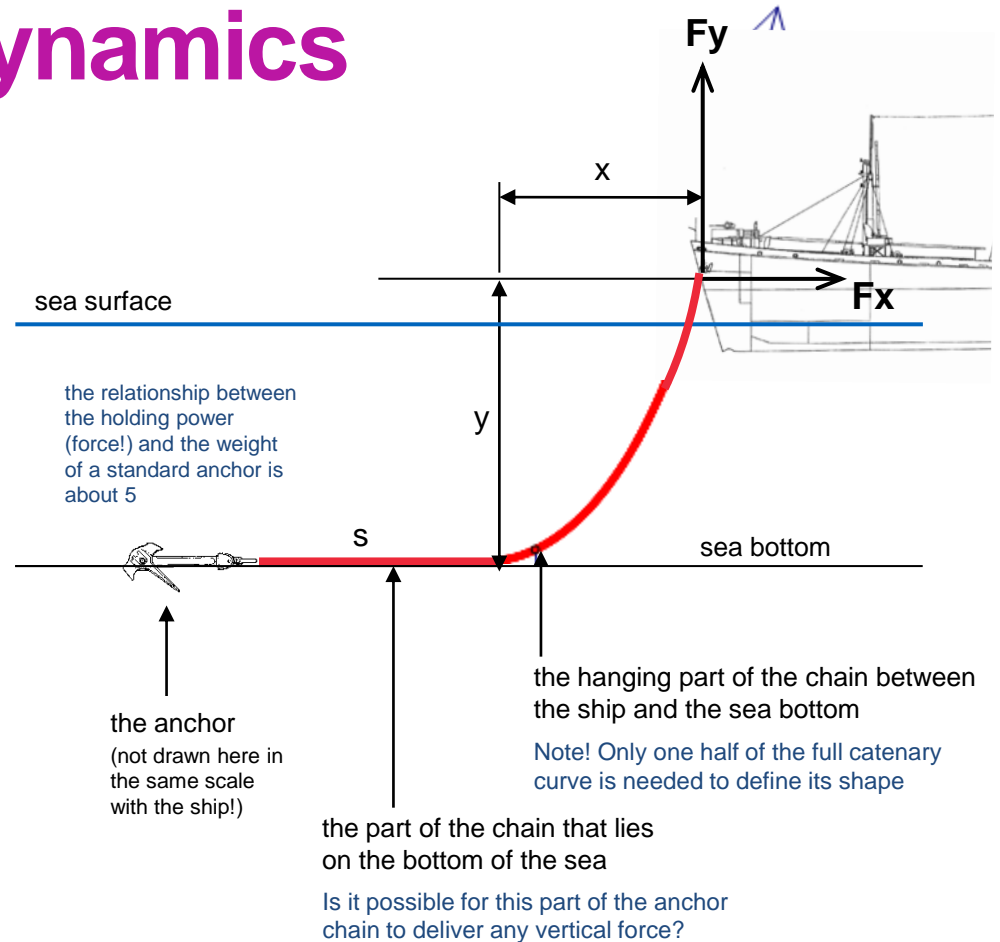

Anchoring systems

Bow anchor equipment (lift etc.) are typically located on the forecastle

- Typically open, sometimes covered.

Anchors are generally remotely controlled from the bridge
Ship's anchoring systems are regulated by class societies

- The geometry of the chain locker must allow the chain to run freely
 - *Cylindrical chain locker are well-proven*
- There must be no obstacles preventing the anchor and chain from being dropped into the sea
- When heaved, the anchor has to settle into the correct position in the anchor pocket
- In ice class ships, towing requirements must be taken into account

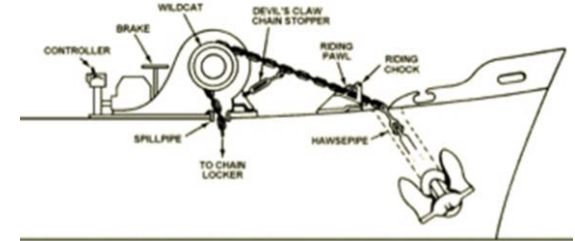

Mooring systems

Mooring system components

- Mooring lines, line-handling systems

Mooring lines

- Bow and stern lines are used to guide a ship to its correct quay location, and to hold a ship fixed in lateral and in longitudinal direction
- Breast lines perpendicular to the quay might be added to counteract high environmental forces
- Spring lines prevents a moored ship from moving along the quay
- Based on synthetic materials
 - *Nailon (strong, elastic), polyester (durable), polypropylene (light, affordable)*
- Mooring lines are stored on reels
- Mooring lines (or separate towing lines) can be used for towing

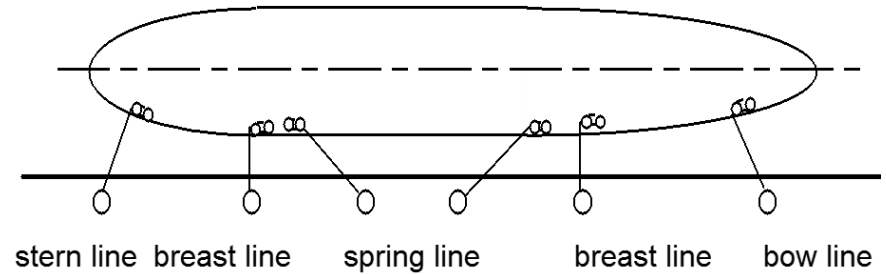

Image credit ship-technology.com

Mooring systems

Line-handling system

- Handled using mooring winches or capstans
- The direction of the pull force can be adjusted using chocks and rollers
- The track of a line should always be without obstacles and tight bends
- Located so that their total number can be minimized (e.g. so that they serve both sides of a ship)
- A direct view from the winch controls to the mate in charge of the operation needed
- Remote control is possible
- Fixed to bitts (onboard) and bollards (on the quay)

Mooring systems are designed considering forces acting on a ship caused by wind, waves and currents

- Design value for wind speed: at least 25 m/s
- Design value for current: at least 2-3 kn
- Necessary to consider that a ship's draught, heel and trim might vary due to loading/unloading of cargo

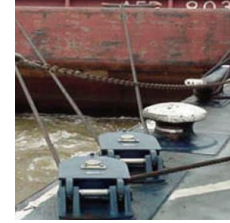

Roller chock. Image credit Wintech



Mooring winch. Image credit Wärtsilä



Doors and hatches

All spaces in a ship must be accessible

- The consideration of passages and openings is an important when determining a ship's general arrangement (GA)

Hull closures

- Watertight doors
 - Will not leak under constant water pressure
 - Generally located between separate watertight compartments
- Weathertight doors
 - Intended to seal the accommodation (superstructure) or an compartment from ingress of water or flooding during bad weather, but they cannot remain water tight when submerged / under long-lasting water pressure
 - Hatch covers (cargo space doors) are typically weathertight, not watertight
- Manhole cover
 - Often bolted



Watertight door. Image credit marineandoffshoreinsight.com



Weathertight door. Image credit marineandoffshoreinsight.com



Manhole cover. Image credit Marine Planet Studio

Doors and hatches

Different types of watertight doors(WTD)

- Normal WTD
 - Located below bulkhead deck
- Light WTD
 - Reduced scantlings, otherwise like normal WTD
- Semi-WTD
 - To be used within the GZ range only, not below immersion line

At sea, the use of WTD doors might vary

- Semi-WTDs (and fire doors) may be kept open
- WTDs should be closed at all time

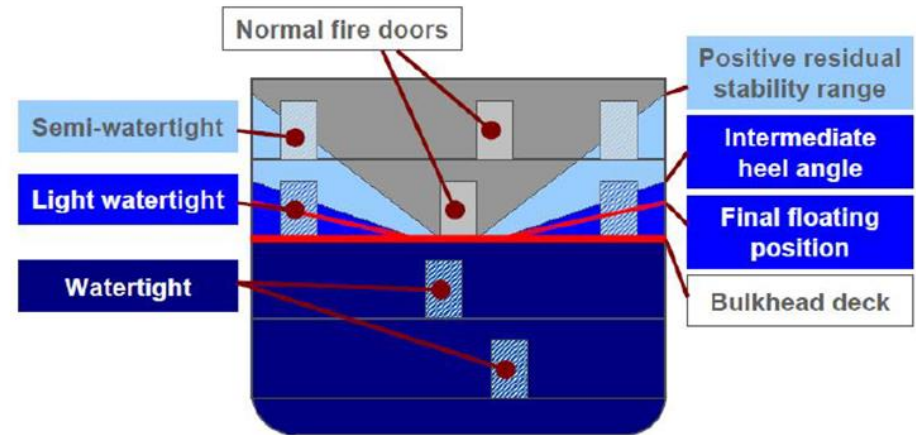

Doors and hatches – Safety Risks

- Watertight doors and occupational safety
 - *There have been several cases of crew members, passengers, or shore workers being badly or fatally injured by watertight doors operated by remote control*
- Watertight doors and ship safety
 - *There have been cases of ships sinking / almost sinking because of watertight doors left open*
 - In September 2000 the ro-ro passenger ferry Express Samina ran aground, resulting in flooding of the engine room and black out. Because 9 of 11 watertight doors were left open, the ship sank rapidly, resulting in 82 casualties.
 - In February 2004, the ro-ro passenger ferry Stena Nautica, with 128 people on board, collided with a dry cargo ship. Although its watertight doors were in remote operation mode following the collision, many of them failed to close and the vessel almost sank.

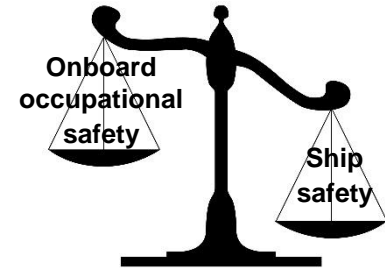

Evacuation systems

Question: What components does a ship's evacuation system consists of?

Evacuation system

Evacuation/safety system components

- Escape routes, muster stations, life boat/rafts and related launch systems, life vests, ...
- Related system: Ship condition monitoring
 - *Detection/analysis of damages/faults*
 - E.g. determination of the number of damaged watertight compartments following a grounding/collision

Evacuation systems and equipment must enable / support

- Mustering (to muster stations)
 - *Requires efficient evacuation routes*
- Loading of lifeboats/life rafts
- Launching of lifeboats / life rafts
- Moving away from /disconnecting from evacuated ship
- Survival
- Rescue



Mustering onboard Grandeur of the Seas. Image credit AP



Evacuation from Costa Concordia. Image credit Giuseppe Modesti/AP



Life raft from MS Estonia (sank 29.09.1994). Image credit Jonas Lemberg

Evacuation system

Different types of lifesaving appliances / systems

- Lifeboats and davits (small onboard cranes for launching lifeboats)
- Free fall lifeboats
- Life rafts
- Life jackets
- Life buoys
- Survival suits
- Evacuation slides & chutes
- Rope ladders
- ...



Evacuation system

Requirements for lifesaving appliances are determined by ship type and operating area

- General requirements set by SOLAS
 - *Special requirements for passenger ships*
- The Polar Code set special requirements for Arctic ships

Evacuation is always risky

- Post evacuation and survival and rescue challenging
- The ship is often the best life boat
 - *'Safe Return to Port' (SOLAS regulation)*
- A significant number of accidents during evacuation drills
 - *Most fatal accidents have been caused by the failures in the lifeboat release mechanism (accidental release of one or more hooks → lifeboat falls into the water)*



Carnival Ecstasy (launched in 1990). Image credit Carnival Cruises



Location of life boats (old vs. new)



Ovation of the Seas (launched in 2015). Image credit Wikimedia Commons

Summary - Ship Machinery

- The purpose of a ship's machinery is to produce energy needed for ship operation (propulsion, maneuvering, and accommodation energy).
- General criteria
 - *High power/weight ratio*
 - *Limited space demand (including space for fuel t*
 - *High energy/cost-efficiency*
 - *Environmental friendliness*
 - *Safety*

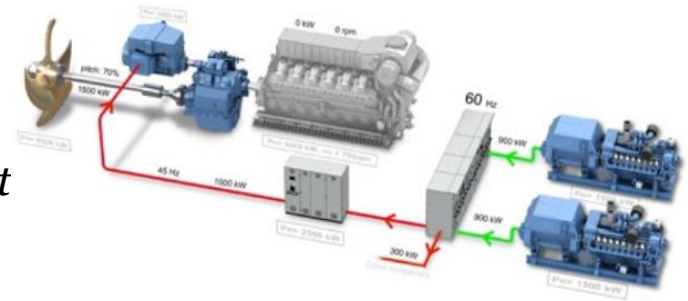

Image credit Rolls-Royce

Summary (Engines and Powering)

- Engine(s)

- *Main and auxiliary engines*
- *Main ship engine types*
 - Diesel engine (dominant)
 - Steam turbine
 - Gas turbine
 - Electric motor

- Power transmission

- *Mechanic*
- *Electric*
- *Hydraulic*

- Propulsion device(s)

- *Shaft propeller*
 - Fixed pitch propeller (FPP)
 - Controllable Pitch Propeller (CPP)
- *Azimuth thruster*
- *Water jet*

- Control and monitoring system

- Auxiliary systems

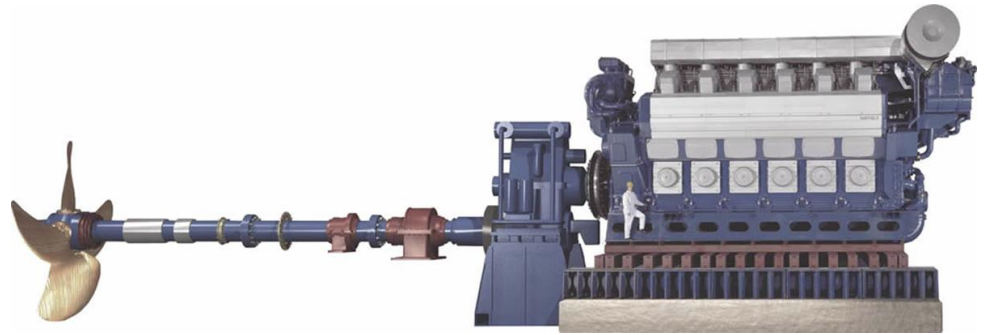

Summary (Equipment)

Safe and efficient ship operations require many different types of systems and equipment

- Anchoring system, mooring system, doors and hatches, evacuation system, steering and maneuvering,...
- *Most of these systems are required by all ships, independent of size and type*

The equipment must be considered when determining the general arrangement





Aalto University
School of Engineering

Thank you !