

Apostolos Papanikolaou

Ship Design

Methodologies of Preliminary Design

 Springer

Ship Design

Apostolos Papanikolaou

Ship Design

Methodologies of Preliminary Design

 Springer

Apostolos Papanikolaou
School of Naval Architecture & Marine
Engineering—Ship Design Laboratory
National Technical University of Athens
Zografou—Athens
Attiki
Greece

Originally published in the Greek language by SYMEON Publishers, Athens, Greece, as “Papanikolaou, Apostolos”; Μελέτη Πλοίου—Μεθοδολογίες Προμελέτης—Τεύχος 1 & Τεύχος 2.

ISBN 978-94-017-8750-5 ISBN 978-94-017-8751-2 (eBook)
DOI 10.1007/978-94-017-8751-2
Springer Dordrecht Heidelberg New York London

Library of Congress Control Number: 2014947529

© Springer Science+Business Media Dordrecht 2014

This work is subject to copyright. All rights are reserved by the Publisher, whether the whole or part of the material is concerned, specifically the rights of translation, reprinting, reuse of illustrations, recitation, broadcasting, reproduction on microfilms or in any other physical way, and transmission or information storage and retrieval, electronic adaptation, computer software, or by similar or dissimilar methodology now known or hereafter developed. Exempted from this legal reservation are brief excerpts in connection with reviews or scholarly analysis or material supplied specifically for the purpose of being entered and executed on a computer system, for exclusive use by the purchaser of the work. Duplication of this publication or parts thereof is permitted only under the provisions of the Copyright Law of the Publisher's location, in its current version, and permission for use must always be obtained from Springer. Permissions for use may be obtained through RightsLink at the Copyright Clearance Center. Violations are liable to prosecution under the respective Copyright Law.

The use of general descriptive names, registered names, trademarks, service marks, etc. in this publication does not imply, even in the absence of a specific statement, that such names are exempt from the relevant protective laws and regulations and therefore free for general use.

While the advice and information in this book are believed to be true and accurate at the date of publication, neither the authors nor the editors nor the publisher can accept any legal responsibility for any errors or omissions that may be made. The publisher makes no warranty, express or implied, with respect to the material contained herein.

Printed on acid-free paper

Springer is part of Springer Science+Business Media (www.springer.com)

Preface

This book elaborates on theoretical approaches and practices of the preliminary design of ships. It is intended to support introductory courses to ship design as a text book. In this respect, it may be useful to university or college students of naval architecture and related disciplines; it may also serve, more generally, as a reference book for naval architects, practicing engineers of related disciplines and ship officers, who like to enter the ship design field systematically or to use practical methodologies for the estimation of ship's main dimensions and of other ship main properties and elements of ship design.

The book is based on the author's lecture notes, which were developed over the past two and a half decades (1985–2012) for the needs of teaching the undergraduate course on *Ship Design and Outfitting I* at the School of Naval Architecture and Marine Engineering of National Technical University of Athens (NTUA). For the understanding of the material presented in this book, the reader is assumed to have basic knowledge of certain fundamental disciplines of ship design, in particular, of “Hydrostatics & Stability of Ships”, “Ship Resistance and Propulsion” and “Ship Strength”, which are commonly taught in prerequisite courses in Schools of Naval Architecture and Marine Engineering, as at NTUA.

The present book is a thoroughly updated and enhanced, new edition of a book published originally in Greek language by the author (*Papanikolaou, A., Ship Design—Methodologies of Preliminary Ship Design*, in Greek: Μελέτη Πλοίου—Μεθοδολογίες Προμελέτης Πλοίου, SYMEON Publisher, Athens, October 2009). The Greek version of the book is supplemented by a *Handbook of Ship Design* of the author (Volume II, SYMEON Publisher, Athens, 1989) and the *Collection of Ship Design Supportive Materials* (*A. Papanikolaou, K. Anastassopoulos*, NTUA publications, Athens, 2002), which cover specific elements, methods and examples of application of ship design and are being used by students of NTUA for the elaboration of the assigned *Ship Design Project* work. Elements of the detailed design of ships are presented in the author's lecture notes on *Ship Design and Outfitting II—General Arrangements, Accommodation, Outfitting and Design of Special Ship Types* (*A. Papanikolaou*, NTUA publication, 2002), which supplement the teaching material of the Ship Design module of the School of Naval Architecture and Marine Engineering of NTUA.

The methodology adopted in the writing of this book has been greatly influenced by the teaching experience of the author and the curriculum of NTUA, particularly in view of the requirement for the elaboration of the “Ship Design project” by final year NTUA students of naval architecture. An inexperienced student needs to be introduced gradually to ship design, until he is capable of developing by himself (under certain guidance, in the preliminary design stage) the design of a ship, which is assigned to him by a hypothetical ship-owner, specifying a merchant ship’s main owner’s requirements (in terms of ship type, transport capacity and speed).

The book consists of six (6) main chapters and five (5) appendices with supportive materials.

Chapter 1 gives an introduction to maritime transport and to marine vehicles in general, defines the objectives and elaborates on the basic methods of ship design. Chapter 2 deals with the selection of ship’s main dimensions and elaborates on the preliminary calculation and approximation of the fundamental characteristics and properties of the ship. Chapter 3 covers the criteria of forming ship’s hull form and elaborates on the characteristics of alternative ship sectional forms, the form of ship’s bow and stern. Chapter 4 deals with methods of developing ship’s lines and also elaborates on the development of the other main drawing plans of ship design (general arrangements and capacity plan). Chapter 5 covers the criteria for selecting the engine installation, the propulsion plant and steering devices of the ship. Finally, Chapter 6 deals with the estimation of ship’s construction cost and related uncertainties. The book is complemented by a basic bibliography and five appendices with useful updated design charts for the selection of the main dimensions and other basic values of different types of ships (Appendix A), the determination of ship’s hull form from the data of systematic series (Appendix B), the detailed description of the relational method for the estimation of ship’s weight components and displacement from the data of similar/parent ships (Appendix C), a brief review of the historical evolution of shipbuilding from the prehistoric era to date (Appendix D) and finally a historical review of regulatory developments of ship’s damage stability to date (Appendix E).

The author used in the development of the original form of this book material of *classical* ship design, as he was taught it in the early 70ties by the memorable Professor *Erwin Strohbusch* at the Technical University of Berlin. This material was later complemented by valuable elements from the lecture notes of Professors *H. Schneekluth* (Technische Hochschule Aachen) and *H. Linde* (Technical University of Berlin), who happened to be both also students and associates of the late Prof. *Strohbusch*, and *A. Friis—P. Anderson—JJ Jensen* (Technical University of Denmark). Also, the classical naval architectural books of the Society of Naval Architects and Marine Engineers (SNAME) of USA, namely *The Principles of Naval Architecture* (*EV Lewis*, ed.) and *Ship Design and Construction* (*R Taggart* and *T Lamb*, eds.), were frequently used as references. However, the synthetic nature of the subject, the rapid developments of shipbuilding science and technology, the frequent amendment of relevant maritime safety regulations and the rapid development of modern design methods and tools, which to a large extent were coded in specialized computer software, as well as the peculiarity of educating students in a

synthetic discipline like ship design demanded a thoroughly thought new structure/presentation of the book's material, apart from the continuous enrichment with contemporary design data.

A major objective of this book and of the associated supportive material is to cover, as a self-contained information source, the necessary knowledge for students of naval architecture to approach satisfactorily a ship design project. To some extent, this applies also to young professionals of naval architecture and related disciplines, for whom the access to the necessary technical knowledge and required data for the study and design of a ship are often limited. Certainly, the rapid growth of internet in recent years has improved significantly the accessibility to a large amount of information relevant to the design of ships by search in the www.

A useful State of the Art report on the status of the international marine design education can be found in the following reference: *Papanikolaou, A., Kaklis, P., Andersen, P., Birmingham, R., Sortland, B., Wright, P.*, State of the Art Report on Marine Design Education, Proc. 9th International Marine Design Conference-IMDC06, Ann Arbor-Michigan, May 2006.

The author likes to thank SPRINGER for the efficient cooperation in publishing this work. He is also indebted to his associates MSc Dipl.-Eng. Naval Arch. & Marine Eng. Aimilia Alisafaki, MSc Dipl.-Eng. Naval Arch. & Marine Eng. George Papatzanakis, Dr.-Eng. Shukui Liu, Dr.-Eng Eleftheria Eliopoulou and Assoc. Prof. George Zaraphonitis for their help in the thorough update and translation of this book into English, and also in checking the final manuscript.

June 2014

Apostolos Papanikolaou
Professor of NTUA
Director of Ship Design Laboratory
<http://www.naval.ntua.gr/sdl>

Contents

| | | |
|----------|---|-----|
| 1 | General on Ship Design | 1 |
| 1.1 | Conventional and Advanced Marine Vehicles | 1 |
| 1.2 | Maritime Transport—Innovative Design Concepts, Energy Efficiency and Environmental Impact | 4 |
| 1.3 | Introduction to Ship Design | 14 |
| 1.3.1 | Main Approach to Ship Design | 14 |
| 1.3.2 | Main Phases of Ship Design | 16 |
| 1.3.3 | Objectives of Preliminary Design | 17 |
| 1.3.4 | Design Procedure: Design Spiral | 19 |
| 1.3.5 | Owner’s Requirements: Statement of Work..... | 27 |
| 1.3.6 | Preliminary Ship Design Methods | 34 |
| 1.3.7 | Basic Design Procedures for Main Ship Categories | 59 |
| | References..... | 66 |
| 2 | Selection of Main Dimensions and Calculation of Basic Ship Design Values | 69 |
| 2.1 | Preliminary Estimation of Displacement..... | 69 |
| 2.2 | Selection of the Main Dimensions and Form Coefficients..... | 73 |
| 2.3 | Selection of Length | 76 |
| 2.3.1 | Effect of Length on Resistance | 77 |
| 2.3.2 | Effect of Length on the Ship’s Strength and Structural Weight..... | 90 |
| 2.3.3 | Effect of Length on the Outfitting Weight | 98 |
| 2.3.4 | Effect of Length on the Weight of Propulsion System and Fuel Consumption..... | 98 |
| 2.3.5 | Effect of Length on the Exploitation of Spaces and General Arrangement | 99 |
| 2.3.6 | Other Factors Affecting the Selection of Length | 100 |
| 2.3.7 | Ship Length Estimation Using Empirical Formulas | 100 |
| 2.4 | Slenderness Coefficient $L/\nabla^{1/3}$ | 114 |
| 2.4.1 | Influence on the Ship’s Resistance..... | 114 |
| 2.4.2 | Effect on the Ship’s Structure | 115 |
| 2.4.3 | Approximate Values | 115 |

| | | |
|--------|---|-----|
| 2.5 | Selection of Other Main Dimensions..... | 115 |
| 2.6 | Selection of Beam..... | 119 |
| 2.6.1 | Effect of Beam on the Ship's Stability..... | 121 |
| 2.6.2 | Effect of Beam on the Ship's Resistance..... | 124 |
| 2.6.3 | Effect of Beam on the Ship's Structural Weight..... | 127 |
| 2.6.4 | Other Factors Affecting the Selection of the Beam..... | 129 |
| 2.7 | Selection of the Side Depth..... | 132 |
| 2.7.1 | Effect of Safety Regulations on Side Depth..... | 132 |
| 2.7.2 | Effect of Side Depth on Hold Volume and Arrangement..... | 133 |
| 2.7.3 | Effect of Side Depth on the Ship's Stability..... | 133 |
| 2.7.4 | Effect of Side Depth on the Ship's Structural Weight..... | 134 |
| 2.8 | Selection of the Draft..... | 136 |
| 2.8.1 | Effect of Draft on Resistance and Propulsion..... | 136 |
| 2.8.2 | Effect of Draft on Stability..... | 136 |
| 2.8.3 | Influence of Draft on Seakeeping and Maneuverability..... | 137 |
| 2.8.4 | Influence of Draft on Strength..... | 138 |
| 2.8.5 | Effect of Route Limits..... | 138 |
| 2.9 | Selection of Hull Form Coefficients..... | 140 |
| 2.10 | Selection of Block Coefficient C_B and Prismatic Coefficient C_p | 142 |
| 2.10.1 | Effect of C_p and C_B on the Ship's Resistance..... | 144 |
| 2.10.2 | Effect on the Seakeeping Performance..... | 146 |
| 2.10.3 | Effect on the Construction Cost..... | 147 |
| 2.10.4 | Effect on the Exploitation of Spaces..... | 148 |
| 2.10.5 | Effect on the Stability..... | 149 |
| 2.10.6 | Approximate/Semiempirical Formulas..... | 150 |
| 2.11 | Midship Section Coefficient C_M | 151 |
| 2.11.1 | Effect on Resistance..... | 152 |
| 2.11.2 | Effect on Construction Cost..... | 154 |
| 2.11.3 | Effect on Space Exploitation..... | 155 |
| 2.11.4 | Effect on Stability..... | 155 |
| 2.11.5 | Effect on Seakeeping Performance..... | 156 |
| 2.11.6 | Approximation Formulas..... | 158 |
| 2.12 | Waterplane Area Coefficient C_{WP} | 160 |
| 2.12.1 | Effect on Stability..... | 160 |
| 2.12.2 | Effect on Resistance, Propulsion, and Seakeeping Performance..... | 162 |
| 2.12.3 | Approximation Formulas..... | 163 |
| 2.12.4 | Conclusions..... | 164 |
| 2.13 | Determination of the Main Dimensions Through the Ship Design Equation..... | 164 |
| 2.14 | Preliminary Estimation of Propulsive Power..... | 165 |
| 2.15 | Estimation of Ship Weights..... | 175 |
| 2.15.1 | Definitions of Ship Weight Components..... | 175 |
| 2.15.2 | Initial Estimation of Weights and Their Centroids..... | 177 |
| 2.15.3 | Factors That Affect the Values of the Weight Coefficients..... | 178 |

| | | |
|----------|--|------------|
| 2.15.4 | Structural Weight..... | 185 |
| 2.15.5 | Weight of Equipment and Outfit..... | 214 |
| 2.15.6 | Weight of Machinery Installation..... | 231 |
| 2.15.7 | Analysis of Deadweight DWT..... | 239 |
| 2.16 | Verification of Displacement..... | 245 |
| 2.17 | Verification of Holds' Capacity..... | 246 |
| 2.17.1 | Definitions..... | 246 |
| 2.17.2 | Calculation of Hold Volume..... | 251 |
| 2.18 | Verification of Stability and Trim..... | 255 |
| 2.18.1 | Vertical Position of Buoyancy Center..... | 256 |
| 2.18.2 | Metacentric Radius..... | 257 |
| 2.18.3 | Vertical Position of Metacenter..... | 258 |
| 2.18.4 | Approximation of Stability at Large Inclination Angles..... | 259 |
| 2.18.5 | Using the Hydrostatic Data of Similar Ships..... | 260 |
| 2.18.6 | Effect of Changing the Main Dimensions..... | 260 |
| 2.18.7 | Typical Values of Metacentric Height..... | 262 |
| 2.18.8 | Verification of Stability..... | 264 |
| 2.18.9 | Verification of Trim and Bow Height..... | 271 |
| 2.19 | Freeboard and Sheer..... | 273 |
| 2.19.1 | Factors Affecting the Freeboard..... | 273 |
| 2.19.2 | Verification of Freeboard..... | 275 |
| 2.19.3 | Sheer..... | 280 |
| 2.19.4 | Critical Review of the Load Line Regulations..... | 289 |
| | References..... | 291 |
| 3 | Ship's Hull Form..... | 293 |
| 3.1 | Distribution of Displacement..... | 295 |
| 3.1.1 | Shape of Sectional Area Curve..... | 295 |
| 3.1.2 | Longitudinal Centre of Buoyancy (LCB)..... | 297 |
| 3.1.3 | Parallel Body Length (L_p)..... | 301 |
| 3.1.4 | Length of Entrance (L_E) and Length of Run (L_R) of the Sectional Area Curve..... | 303 |
| 3.1.5 | Angle of Entrance/Run of Sectional Area Curve..... | 305 |
| 3.2 | Form of Waterlines..... | 307 |
| 3.3 | Form of Sections..... | 312 |
| 3.3.1 | Types of Sections..... | 312 |
| 3.3.2 | Midship Section Form..... | 312 |
| 3.3.3 | Form of Bow and Stern Sections..... | 314 |
| 3.3.4 | Bow Sections Below Waterline..... | 316 |
| 3.3.5 | Stern Sections Below Waterline..... | 317 |
| 3.3.6 | Form of Sections Above Waterline..... | 321 |
| 3.4 | Form of Bow..... | 323 |
| 3.4.1 | Types of Bow..... | 323 |
| 3.4.2 | Bulbous Bow..... | 331 |
| 3.4.3 | Parabolic Bow..... | 345 |

- 3.5 Form of Stern 347
 - 3.5.1 Forms of Stern..... 347
 - 3.5.2 Elliptic or Elevated Stern 349
 - 3.5.3 Cruiser Stern..... 349
 - 3.5.4 Transom Stern 353
- References..... 357
- 4 Naval Architectural Drawings and Plans..... 359**
 - 4.1 General..... 359
 - 4.2 Ship Lines Plan 360
 - 4.3 Introduction to the Development of Ship Lines Plan..... 370
 - 4.4 Design Based on Data of Systematic Ship Hull Form Series 377
 - 4.5 General Arrangement Plan..... 379
 - 4.6 Capacity Plan 389
 - References..... 391
- 5 Machinery Installation, Propulsion and Steering Devices 393**
 - 5.1 Selection of Main Machinery..... 393
 - 5.2 Selection of Propeller..... 407
 - 5.3 Selection of Rudder..... 425
 - References..... 437
- 6 Estimation of Building Cost 439**
 - 6.1 Statement of the Optimization Problem..... 439
 - 6.2 Building Cost Analysis 440
 - 6.3 Cost of Built/Processed Steel 442
 - 6.4 Cost of Machinery and Propulsive Installation..... 445
 - 6.5 Accommodation/Equipment/Outfitting Cost 446
 - References..... 447
- Appendix..... 449**
 - Appendix A: Diagrams of Regression Analysis of Basic Design
 - Values for Merchant Ships..... 449
 - Bulk Carriers 450
 - OBO Carriers 459
 - Containerships..... 462
 - Tankers 472
 - Product Carriers 476
 - Chemical Carriers 482
 - General Cargo Carriers 485
 - RO-RO Cargo Ships..... 488
 - RO-RO Passenger Ferries..... 493
 - Single-Hull Fast Ferries 496
 - Car Carrying Catamarans 499

| | |
|--|------------|
| Reefer Ships | 501 |
| Passenger/Cruise Ships | 505 |
| Offshore Tug/Supply Ships | 508 |
| Fishing Vessels | 511 |
| References | 516 |
| Appendix B: Systematic Hull Form—Model Series | 517 |
| Wageningen-Lap Series..... | 518 |
| Series 60 Hull Form—Todd et al. | 519 |
| FORMDATA Series..... | 525 |
| MARAD Series | 547 |
| References | 560 |
| Appendix C: Determination of Ship’s Displacement with the Relational Method of Normand | 561 |
| Equation of Displacement for Small Deviations..... | 562 |
| Displacement Equation for Larger Deviations..... | 565 |
| Normand’s Number | 575 |
| Accuracy of the Displacement Equation..... | 580 |
| References | 581 |
| Appendix D: Historical Evolution of Shipbuilding | 582 |
| Before Christ Era..... | 583 |
| Middle Ages—Renaissance | 586 |
| Industrial Revolution..... | 587 |
| First Half of the Twentieth Century | 593 |
| Second Half of the Twentieth Century..... | 595 |
| Contemporary Period | 598 |
| Appendix E: Subdivision and Damage Stability of Ships— Historical Developments and the Way Ahead..... | 610 |
| The Evolution of Deterministic Damage Stability Standards..... | 610 |
| Present Status: Probabilistic Assessment | 613 |
| Future Developments of International Regulations and Concepts: Risk and Goal based standards..... | 616 |
| Conclusions | 617 |
| References | 620 |
| Index | 623 |

Chapter 1

General on Ship Design

Abstract A ship is designed to serve specific requirements of her owner or a mission of an authority or society, disposing certain functional characteristics, specific hull form and powering, space and weight distribution, while demonstrating certain technical and economic performance.

This book deals with the first phases of ship design, namely the basic design, which is often also known as preliminary design. The first chapter deals with basic definitions and characteristics of conventional ships and Advanced Marine Vehicles (AMVs); it compares the transport efficiency and environmental impact of conventional ships and AMVs with the performance of representatives of land and air transport vehicles; it provides a brief introduction to maritime transport and its relationship to innovative design concepts, to the energy efficiency and the environmental impact of ship operations; it introduces the main approaches to and the main phases of ship design; it defines the objectives of preliminary ship design; it comments on the main steps of the design procedure and their illustration by the design spiral; it includes a categorization of common ship types into main ship categories, enabling uniform approaches to their design; finally, after introducing the main ship types, it elaborates on alternative methods for determining ship's main dimensions and other basic ship design characteristics.

1.1 Conventional and Advanced Marine Vehicles

Man has travelled for thousands of years through the oceans without first knowing how and why this was possible. Archaeological findings indicate that first ship-like floating devices were operating in the Aegean Sea 7000 B.C. The Phoenicians and Egyptians appear to have been the leaders in the art of early shipbuilding, followed by the Greeks of the Cycladic and Crete islands (Minoan period, 1700–1450 B.C.). However, it was the work of great Archimedes in the third century B.C. that explained a ship's floatability and stability; even this work remained practically unexploited until relatively modern times (eighteenth century A.D.) (see Nowacki and Ferreiro 2003).

Having in mind the Archimedean principle of carrying a ship's weight by hydrostatic forces, the various types of modern ship concepts, ranging from conventional ships and up to unconventional, innovative ship concepts (which we call Advanced Marine Vehicles, AMVs), may be illustrated through a comprehensive ship development chart (Fig. 1.1, Papanikolaou 2002). This chart is based on a categorization

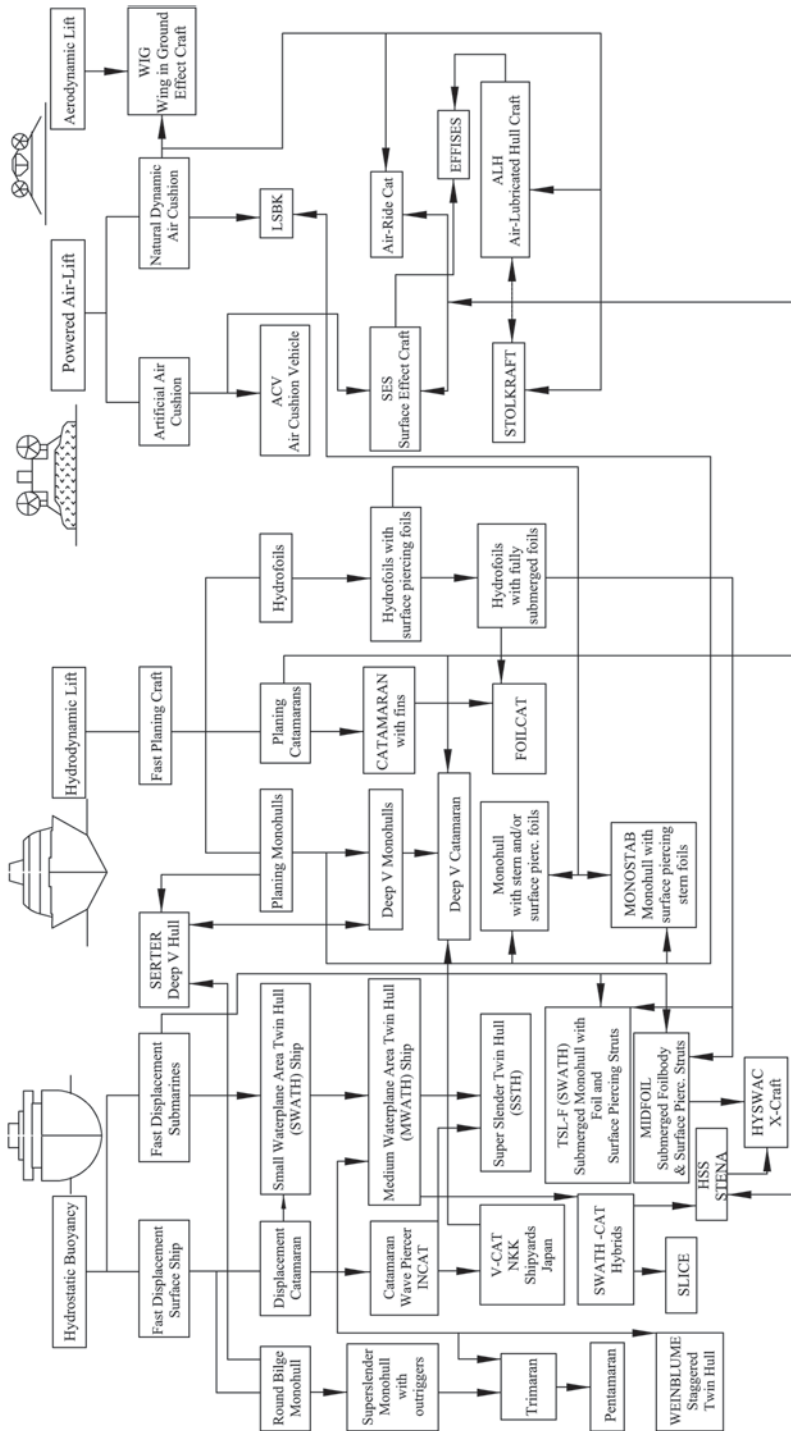

Fig. 1.1 Development of basic types and hybrids of advanced marine vehicles (Papamikolaou 2002)

Comments on the Chart of AMVs (Fig. 1.1) and Explanation of Used Acronyms. 1 *ACV*: air cushion vehicle—Hovercraft, excellent calm water and acceptable seakeeping (limiting wave height), limited payload capacity. 2 *ALH*: air lubricated hull, various developed concepts and patents, see type STOLKRAFT. 3 *Deep V*: ships with *Deep V* sections of semidisplacement type according to E. Serter (USA) or of more planing type, excellent calm water and payload characteristics, acceptable to good seakeeping, various concepts AQUASTRADA (RODRIQUEZ, Italy), PEGASUS (FINCANTIERI, Italy), MESTRAL (former BAZAN, Spain), CORSAIR (former LEROUX & LOTZ, France). 4 *EFFISES*: hybrid ALH twin hull with powered lift, patented by SES Europe A.S. (Norway). 5 *FOILCAT*: twin-hull (catamaran) hydrofoil craft of KVAERNER (Norway), likewise MITSUBISHI (Japan), excellent seakeeping (but limiting wave height) and calm water characteristics, limited payload. 6 *HYSWAC—X-Craft*: hybrid SWATH with midfoil, prototypes currently tested by US Navy. 7 *LWC*: low wash catamaran, twin-hull, superslender, semidisplacement catamaran with low wave-wash signature of FBM Marine Ltd. (UK), employed for river and closed harbour traffic. 8 *LSBK*: Längs Stufen-Bodenkanalboot-Konzept, optimized air-lubricated twin hull with stepped planing demihulls, separated by tunnel, aerodynamically generated cushion, patented in Germany. 9 *MIDFOIL*: submerged foil body and surface-piercing twin struts of NAVATEK-LOCKHEED (USA). 10 *MONOSTAB*: semiplaning monohull with fully submerged stern fins of RODRIQUEZ (Italy). 11 *MWATH*: medium waterplane area twin-hull ship, as type SWATH, however with larger waterplane area, increased payload capacity and reduced sensitivity to weight changes, worse seakeeping. 12 *PENTAMARAN*: Long, slender monohull with four outriggers, designs by Nigel Gee (UK) and former IZAR (Spain). 13 *SES*: surface effect ship, air cushion catamaran ship, similar to ACV type concept, however without side skirts, improved seakeeping and payload characteristics. 14 *SLICE*: staggered quadruple demihulls with twin struts on each side, according to NAVATEK-LOCKHEED (USA), currently tested as a prototype. 15 *SSTH*: superslender twin-hull, semidisplacement catamaran with very slender, long demihulls of IHI shipyard (Japan), similar to type WAVEPIERCER. 16 *STOLKRAFT*: optimized air-lubricated V-section shape catamaran, with central body, reduced frictional resistance characteristics, limited payload, questionable seakeeping in open seas, patented by STOLKRAFT (Australia). 17 *Superslender monohull with outriggers*: long monohull with two small outriggers in the stern part, EUROEXPRESS concept of former KVAERNER-MASA Yards (Finland), excellent calm water performance and payload characteristics, good seakeeping in head seas. 18 *SWATH Hybrids*: SWATH-type bow section part and planing catamaran stern section (STENA's HSS of Finyards, Finland, AUSTAL hybrids, Australia), derived from original type SWATH & MWATH concepts. 19 *SWATH*: small waterplane area twin-hull ship, synonym to SSC (semisubmerged catamaran of MITSUI Ltd.), ships with excellent seakeeping characteristics, especially in short-period seas, reduced payload capacity, appreciable calm water performance. 20 *TRICAT*: twin-hull semidisplacement catamaran with middle body above SWL of FBM Marine Ltd. (UK). 21 *TRIMARAN*: long, slender monohull with small outriggers at the centre, introduced by Prof. D. Andrews—UCL London (UK), built as large prototype by the UK Royal Navy (TRITON), similarities to the superslender monohull with outriggers concept of former KVAERNER-MASA (Finland). 22 *TSL-F—SWASH*: techno-superliner foil version developed in Japan by shipyard consortium, submerged monohull with foils and surface piercing struts. 23 *V-CAT*: semidisplacement catamaran with V section-shaped demihulls of NKK shipyard (Japan), as type WAVEPIERCER. 24 *WAVEPIERCER*: semidisplacement catamaran of INCAT Ltd. (Australia), good seakeeping characteristics in long-period seas (swells), good calm water performance and payload characteristics. 25 *WEINBLUME*: displacement catamaran with staggered demihulls, introduced by Prof. H. Söding (IfS-Hamburg, Germany), very good wave resistance characteristics, acceptable seakeeping and payload, name in the honour of late Prof. G. Weinblum (IfS Hamburg—DTMB Washington). 26 *WFK*: wave-forming keel, high-speed catamaran craft, employment of stepped planing demihulls, like type LSBK, but additionally introduces air to the planing surfaces to form lubricating film of microbubbles or sea foam with the effect of reduction of frictional resistance, patented by A. Jones (USA). 27 *WIG*: wing in ground effect craft, various developed concepts and patents, passenger/cargo-carrying and naval ship applications, excellent calm water performance, limited payload capacity, limited operational wave height, most prominent representative is the ECRANOPLANS of the former USSR

of the various marine vehicles by considering the main physical concepts leading to the force balancing the weight of the ship, namely the *hydrostatic buoyancy force*, the *hydrodynamic lift force*, the *powered fan-lift force* and the *aerodynamic lift force*. In the chart (Fig. 1.1), we may distinguish on the first row the fundamental ship concepts; the *derivatives* of these basic concepts (so-called *hybrids*) are filed column-wise according to the *major* physical force balancing the ship's weight, notwithstanding the fact that during operation, forces derived from other physical concepts might as well contribute to their weight balance. For example, the weight of a planing craft is not entirely carried by the hydrodynamic lift force, but to a certain degree, depending on the speed of operation, also by the hydrostatic, buoyancy force, according to the displaced water volume. Historically/chronologically, technological developments are understood to have taken place from the upper left corner (Archimedean principle) towards the right and downward (Papanikolaou 2002).

1.2 Maritime Transport—Innovative Design Concepts, Energy Efficiency and Environmental Impact

Ships are built for covering the needs of society through the provision of specific services. These services may be on a commercial or noncommercial basis; whereas in the first case (commercial ships) the objective is to generate profit for the ship-owner, the latter case is related to a public service of some kind, the cost of which is in general carried by a governmental authority. The main bulk of commercial ships are cargo ships, which carry all types of cargo (solid and liquid cargo or passengers) and provide in fact the largest (by volume of cargo and transport distance in ton-miles) worldwide transportation work, compared to other modes of transport. Regarding the categorization of ships, we come to it later in Sect. 1.3.6.

The transport efficiency of ships and of marine vehicles in general may be defined in various ways and many researchers have addressed this in the past. In particular, when introducing efficiency indicators (efficiency indices or metrics), we need to ensure an as-wide-as-possible applicability of the introduced *performance indices* (or *merit functions*) on a 'fair' basis, when assessing sometimes competing alternative transport concepts (and modes of transport). In the following, a brief review of related past work is conducted and complemented by more recent work of the author.

The transport efficiency may be defined as a function of the vessel's deadweight W_d (\equiv DWT), service speed V_s in knots and total installed power P in kW.

$$E_1 = \frac{W_d \cdot V_s}{P} \quad (1.1)$$

Noting the difference between the deadweight and payload,¹ the transport efficiency may be also expressed in terms of the vessel's payload W_p , instead of deadweight:

¹ Deadweight=sum of weights of...payload (weight of cargo of any type)+fuel+lubrication oil+crew (including luggage)+passengers (including luggage, for passenger ships only)+water supplies (fresh and drinking water) + consumables/food supplies and other effects+water ballast (as necessary for the particular loading condition).

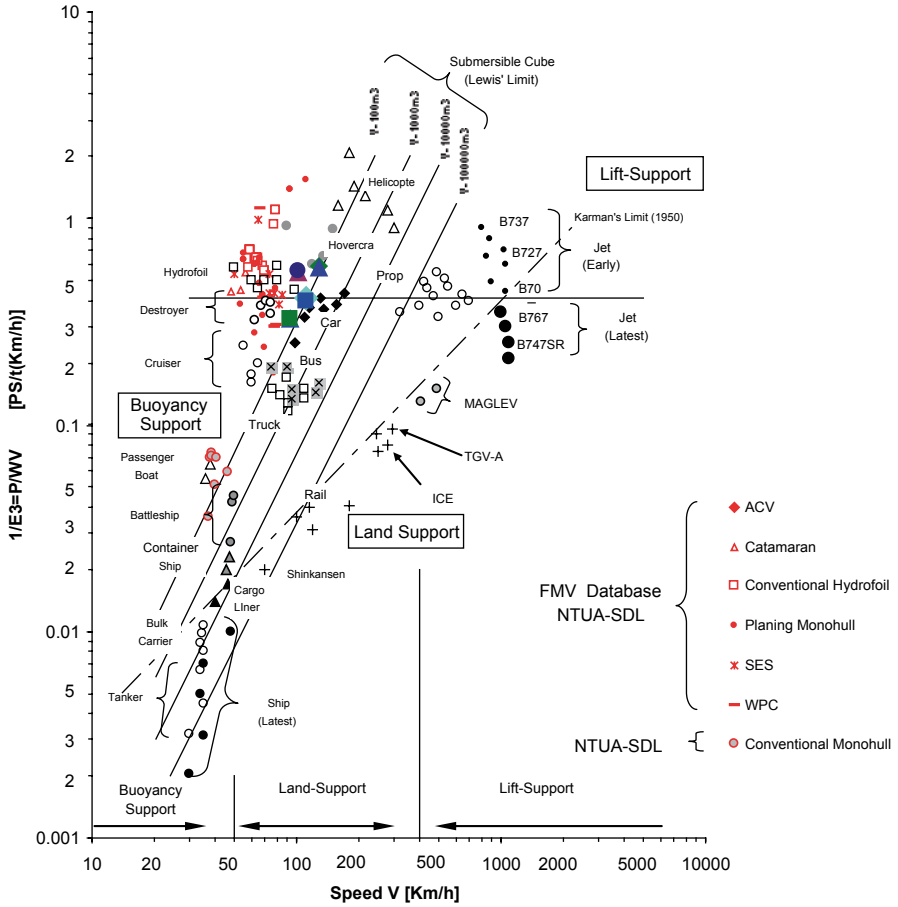

Fig. 1.2 Reciprocal transport efficiency of alternative modes of transport according to S. Akagi (1991); data supplemented by NTUA-SDL. (Papanikolaou 2005)

$$E_2 = \frac{W_p \cdot V_s}{P} \tag{1.2}$$

When comparing the transport efficiency of marine vehicles with that of alternative modes of transport (land and airborne), it is very useful to employ the well-known *von Karman–Gabrielli* transport efficiency diagram.² Akagi (1991) has replotted the original Karman–Gabrielli diagram, in terms of the *reciprocal transport efficiency* as the ratio of the total installed power P in PS to the product displacement W in tons times maximum speed V in km/h:

$$\frac{1}{E_3} = \frac{P}{W \cdot V} \tag{1.3}$$

² Introduced through their article: *What price speed? Specific power required for propulsion of vehicles*, G. Gabrielli and Th. von Kármán, *Mechanical Engineering* 72(1950), #10, pp. 775–781.

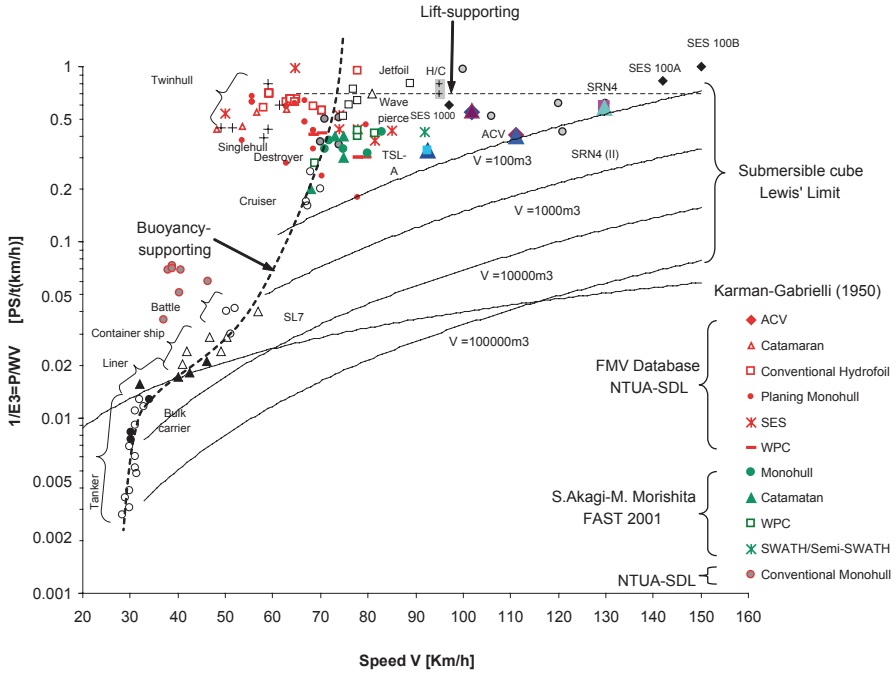

Fig. 1.3 Reciprocal transport efficiency of conventional and advanced marine vehicles. (Akagi and Morishita 2001; Papanikolaou 2005)

Akagi and Morishita (2001) have added also later developments of various transport vehicles. Figure 1.2 presents the reciprocal transport efficiency once more updated by more recent sample data of the NTUA-SDL database, whereas Fig. 1.3 focuses on the performance of the marine vehicles only.

The reciprocal transport efficiency (specific power), may be based also on payload W_p :

$$\frac{1}{E_4} = \frac{P}{W_p \cdot V^2} \quad (1.4)$$

and is presented in Fig. 1.4.

When comparing alternative modes of transport with respect to speed, it makes sense to plot the *payload ratio* (W_p/W), against their maximum speed (in km/h, Fig. 1.5), as the earnings and likely profit are directly related to payload.

Kennell (1998) introduced a different *transport factor*, namely:

$$TF = \frac{K_2 \cdot W}{SHP_{T1} / (K_1 \cdot V_K)} \quad (1.5)$$

where K_2 is a constant ($K_2 = 2240$ lb/LT), W is the ship's displacement in long tons, SHP_{T1} is the total installed power in HP, K_1 is a constant ($K_1 = 1.6878/550$ HP/lb-kn)

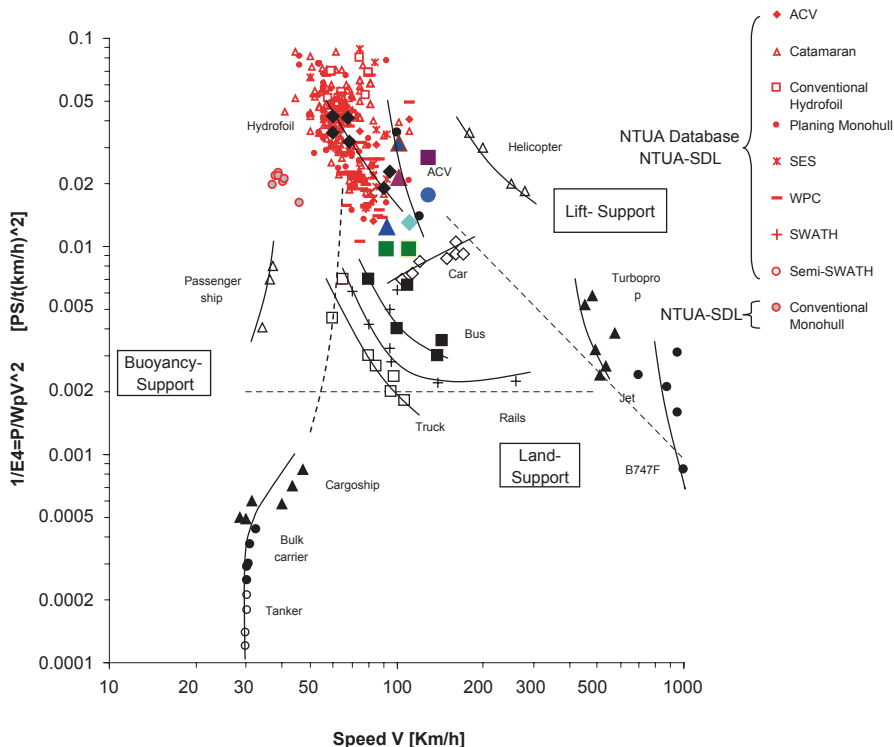

Fig. 1.4 Reciprocal payload efficiency of alternative transport systems. (Akagi 1991; Papanikolaou 2005)

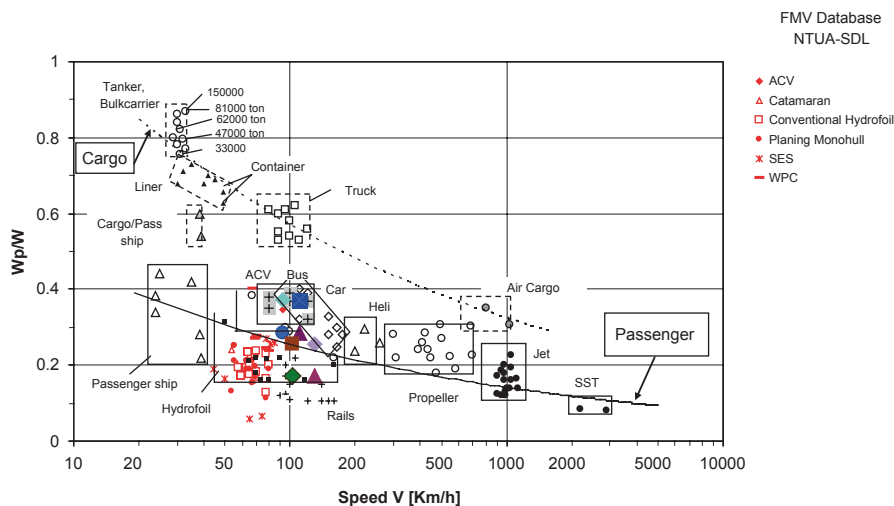

Fig. 1.5 Payload ratio of alternative transport systems. (Akagi 1991; Papanikolaou 2005)

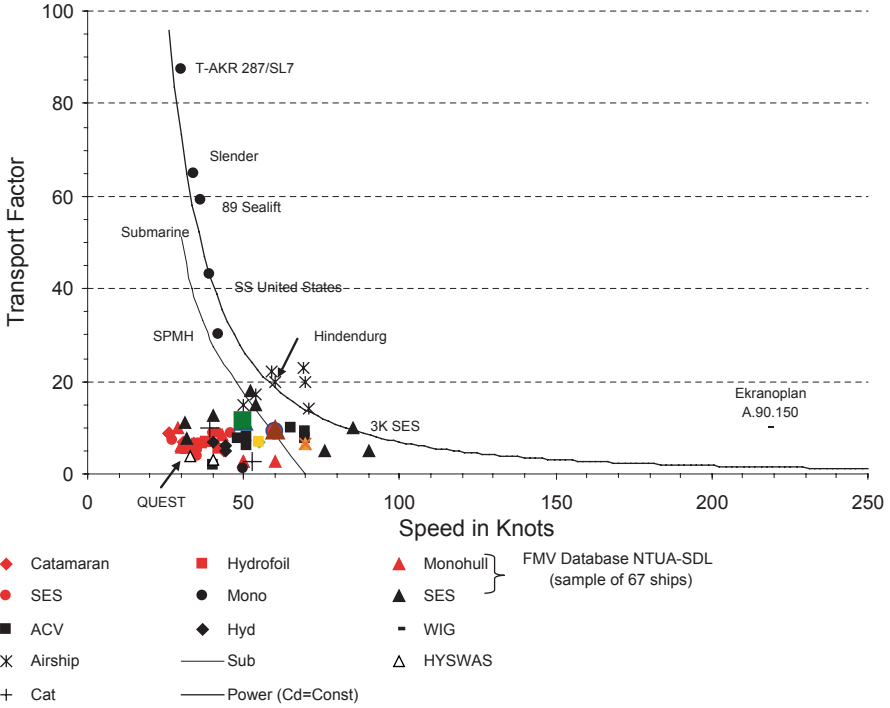

Fig. 1.6 Transport factor vs. speed according to Kennell (1998) and NTUA-SDL. (Papanikolaou 2005)

and V_k is the design speed in kn. Figure 1.6 presents Kennell’s transport factor vs. speed updated with the relevant NTUA-SDL database data.

Following Kennell’s (1998) approach, the displacement and transport factor may be decomposed as follows:

$$W_{ship} = W + W_{cargo} + W_{fuel} \tag{1.6}$$

$$TF = TF_{ship} + TF_{cargo} + TF_{fuel} \tag{1.7}$$

where W_{ship} , W_{cargo} and W_{fuel} are the lightship, cargo and fuel oil weight, respectively (in LT), and TF_{ship} , TF_{cargo} and TF_{fuel} are the transport factors, calculated for each weight group.

W_{ship} and W_{fuel} are obtained from the following equations:

$$W_{ship} = W - W_{cargo} - W_{fuel} \tag{1.8}$$

$$W_{fuel} = SFC_{avg} \cdot K_{SHP} \cdot SHP_{TI} \frac{R}{K_S \cdot V_K} \tag{1.9}$$

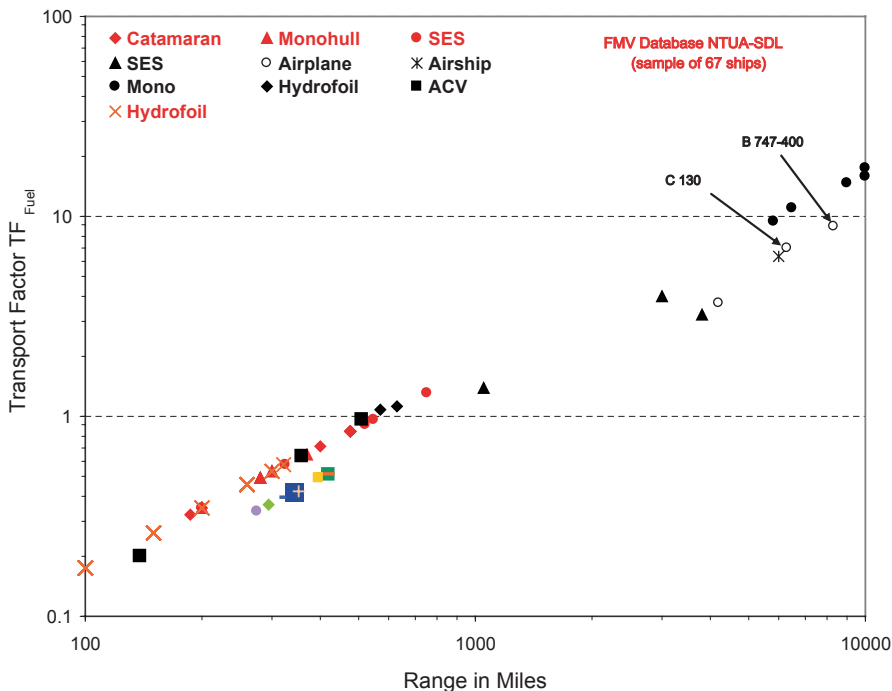

Fig. 1.7 Fuel transport factor vs. range according to Kennell (1998) and NTUA-SDL. (Papanikolaou 2005)

where SFC_{avg} is the average effective fuel consumption rate, K_{SHP} is the endurance power-to-design power ratio, R the range in knots, K_S the endurance speed-to-design speed ratio.

Figures 1.7–1.9 show the fuel transport factor vs. range and the trends of transport factors and various fractions thereof, as plotted by Kennell and updated by the NTUA-SDL database ships.

For some more general data regarding the *fuel efficiency* of transport of cargo and passengers by alternative modes of transport, Tables 1.1 and 1.2 may be consulted.

From the above comparison across all modes of transport, the high efficiency of waterborne transport is evidenced, followed by rail transport.³ However, comparing waterborne with other modes of transport (land and airborne), the speed of transport needs also to be taken into account, especially when dealing with the transport of so-called *JIT* (Just In Time) products and passengers, for which the *value of time* and the demand for high speed is of high importance, so that higher fuel and transport cost might be accepted (Akagi 1991; Papanikolaou 2002, 2005).

³ In this comparison, the high investments for the building and maintaining of rail network infrastructure, compared to the limited spending for ports’ infrastructure, are not considered.

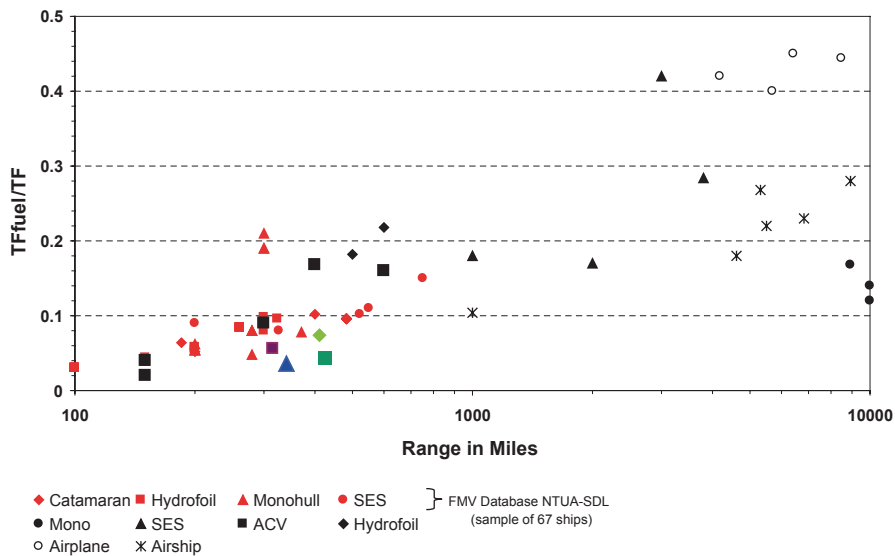

Fig. 1.8 Fuel transport factor ratio vs. range according to Kennell (1998) and NTUA-SDL. (Papanikolaou 2005)

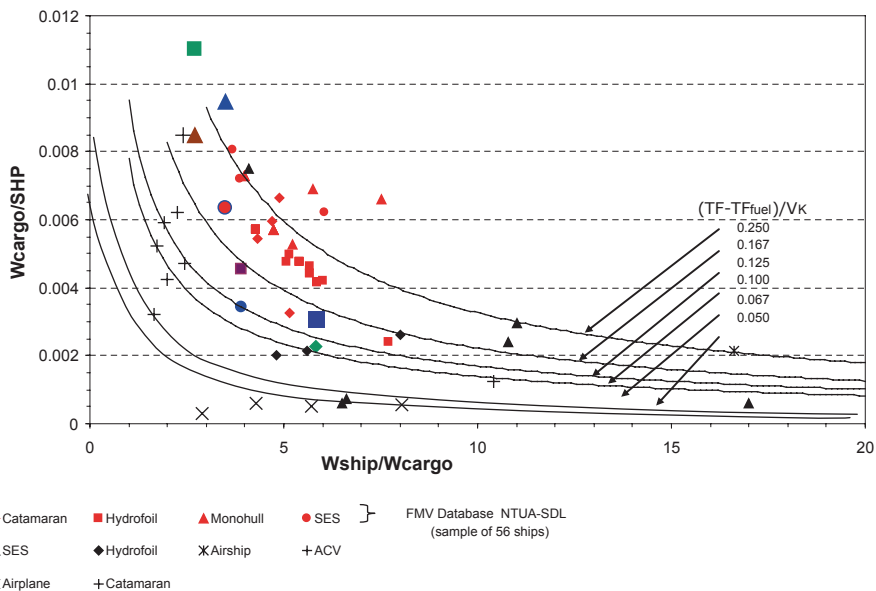

Fig. 1.9 Payload-to-horsepower ratio vs. weight of ship-to-payload ratio according to Kennell (1998) and NTUA-SDL. (Papanikolaou 2005)

Table 1.1 Specific fuel consumption for break cargo transport (Schneekluth 1985)

| | |
|----------|---|
| Ship | 0.4 kg/(ton 100 km) |
| Truck | 1.1 ÷ 1.6 kg/(ton 100 km) |
| Rail | 0.7 ÷ 1.6 kg/(ton 100 km) |
| Airplane | 6 ÷ 8 kg/(ton 100 km) |
| | It refers to tons payload and includes the weight of fuel |
| | 11 ÷ 14 kg/(ton 100 km) |
| | It refers to tons payload and includes the weight of fuel for transatlantic flights |

Table 1.2 Specific fuel consumption for passenger transport. (Schneekluth 1985)

| | |
|--|--------------------------|
| Private car, only driver | About 8 kg/(pers 100 km) |
| Bus (55 passengers, 100 km/h) | 1 kg/(pers 100 km) |
| Train type IC (10 wagons of 60 seats, 160 km/h) | 3 kg/(pers 100 km) |
| Train type D (14 wagons of 72 seats, 140 km/h) | 1.5 kg/(pers 100 km) |
| Airplane in transatlantic flight (including other cargo) | 17 kg/(pers 100 km) |
| Airplane in European flight (without other cargo) | 3.6 ÷ 6 kg/(pers 100 km) |
| Air cushion high-speed vehicle (600 passengers) | 5 kg/(pers 100 km) |
| Modern large cruise ships (500–1000 passengers) | 16 ÷ 18 kg/(pers 100 km) |
| RO-RO passenger ferry with deck passengers (1500 passengers) | 5 ÷ 6 kg/(pers 100 km) |
| Small riverboat, with deck passengers | 1.5 kg/(pers 100 km) |
| Large rivership, with deck passengers | 0.5 kg/(pers 100 km) |

Regarding the impact of shipping operations on the marine and atmospheric environments, there are mainly two major factors to consider, namely the likely pollution of the marine environment by crude and other oil products when transported by tankers and the toxic gas emissions of marine engines to the atmosphere. Both above factors are strictly regulated by international authorities (International Maritime Organisation, IMO, <http://www.imo.org>) and have a significant impact on ship design, outfitting and operation.

The likely pollution of the marine environment is regulated by International Convention for the Prevention of Pollution from Ships (MARPOL) 73/78, which is one of the major IMO conventions; in the course of the years, after its introduction in 1973, MARPOL underwent several amendments and improvements that contributed to today's quite satisfactory state of affairs in terms of tanker accidents and environmental consequences (Fig. 1.10,⁴ Eliopoulou and Papanikolaou 2007). Following a series of catastrophic single hull tanker accidents, current MARPOL regulations (IMO 2013a and long before US OPA90) recognize double hull tanker designs as the only acceptable solution for the safe carriage of oil in tanker ships. According to current MARPOL regulations, the tank arrangement of the cargo block of an oil tanker should be properly designed to provide adequate protection

⁴ The presented statistics cover the period 1978–2003; it is noted that the very low accidental rates achieved, as of year 2003, are confirmed by more recent statistical studies (Papanikolaou et al. 2009c).

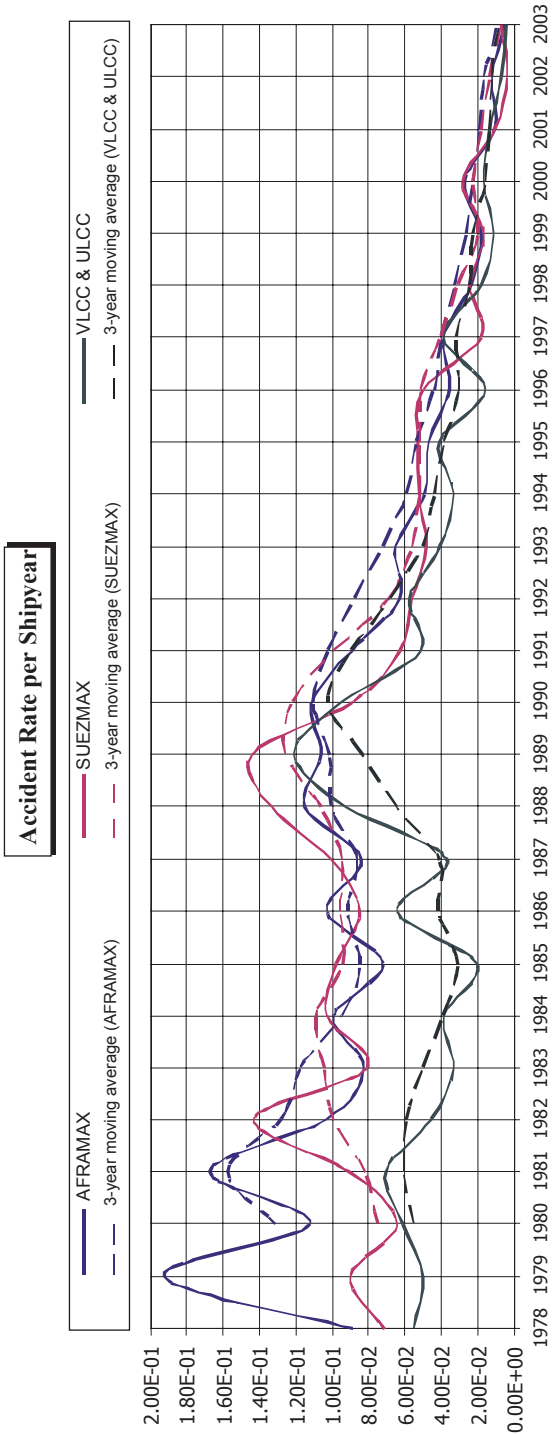
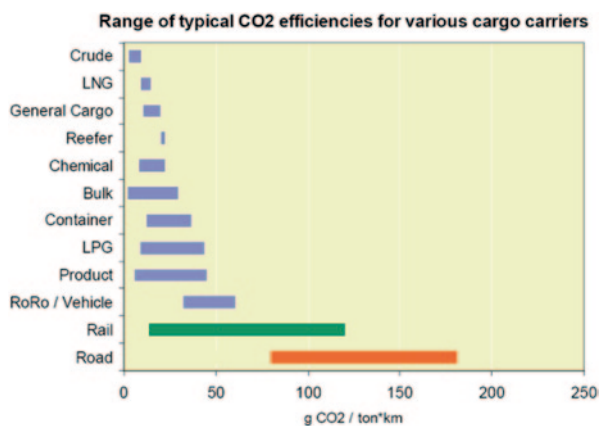

Fig. 1.10 Historical trends of accident rates (number of accidents per ship year) of large tankers (Eliopoulou and Papanikolaou 2007)

Fig. 1.11 Typical ranges of CO₂ efficiencies of ships compared with rail and road transport. (Buhaug et al. 2008)



against accidental oil outflow, as expressed by the so called ‘mean outflow parameter’. Further improvements of MARPOL may be expected in the future.

Finally, it is well established today that human activities have a significant impact upon the levels of greenhouse gases in the atmosphere, i.e. those gases that absorb and emit radiation within the thermal infrared range. The gases with the most important release to the atmosphere are in descending order: water vapour, carbon dioxide (CO₂), methane and ozone. The Intergovernmental Panel on Climate Change (IPCC) recently released a report stating that ‘most of the observed increase in global average temperatures since the mid-twentieth century is very likely due to the observed increase in anthropogenic greenhouse gas concentrations’ (Solomon et al. 2007). One of the main contributors of emissions of greenhouse gases due to human activity is the burning of fossil fuels. The total CO₂ emissions from shipping (domestic and international) amount about 3.3% of the global emissions from fuel consumption according to International Energy Agency (IEA; Buhaug et al. 2008; Fig. 1.11).

Climate stabilization will require significant reductions of CO₂ emissions by 2050 and the international shipping industry needs to participate in this process. Independently of the fact that maritime transport is the most efficient mode of transport (ton-kilometre) and least polluting in terms of greenhouse gas emissions, present discussions and expected regulatory measures suggest the collaboration of all major stakeholders of shipbuilding and ship operations to efficiently address this complex technoeconomical and highly political problem and calls eventually for the development of proper design and operational knowledge and assessment tools for the energy efficient design and operation of ships (Boulougouris and Papanikolaou 2009). In this respect, an Energy Efficiency Design Index (EEDI)⁵ has been

⁵ The Energy Efficiency Design Index (EEDI) was made mandatory for *new* ships, as of January 1, 2013; this was decided at MEPC 62 (July 2011) with the adoption of amendments to MARPOL Annex VI (resolution MEPC.203(62)) and went along with the introduction of a Ship Energy Efficiency Management Plan (SEEMP) for *all* ships. The EEDI provides a specific figure for an individual ship design, expressed in gram, of carbon dioxide (CO₂) per ship’s transport work, ex-

introduced for most types of merchant ships, which needs to be kept below a certain limiting value that is specific to ship's type and size.

Typical design and outfitting measures for reducing CO₂ emissions are related to hull form optimization for least powering (and fuel consumption), improved diesel engine combustion, improved fuel technology etc.; last, but not least, a drastic operational measure for reducing CO₂ emissions is reduction of service speed, with major impact on a ship's competitiveness and economy, especially when the ship is in liner service (e.g. for container and passenger ships).

Finally, societal concerns about the safety of human lives and of the environment have recently led the maritime industry to increased efforts in the design and operation of ships for enhanced safety. Applications of risk-based approaches in the maritime industry started actually in the early 60s with the introduction of the concept of probabilistic ship's damage stability. In the following years, they were widely applied within the offshore sector and are now being adapted and utilized within the ship technology and shipping sector. The main motivation to use more and more risk-based approaches in the shipping industry is twofold: implement novel ship designs which are considered safe but—for some formal reason—cannot be approved today (see mega cruise ships) and/or rationally optimize existing design concepts with respect to safety, without compromising on efficiency and performance. ('risk-based ship design' and 'design for safety', see, Papanikolaou 2009b).

1.3 Introduction to Ship Design

1.3.1 Main Approach to Ship Design

Ship design was in the past more art than science, highly dependent on experienced naval architects, with good background in various fundamental and specialized scientific and engineering subjects, next to practical experience. The design space (multitude of solutions to the design problem) was practically explored using heuristic methods, namely methods deriving from a process of trial and error often over the course of decades. Gradually, trial and error methods were replaced more and more by gained knowledge, which eventually formed a knowledge base, namely semiempirical methods and statistical data of existing ships and successful designs.

A modern, systems-based approach to ship design may consider the ship as a complex system integrating a variety of subsystems and their components, e.g. subsystems for cargo storage and handling, energy/power generation and ship propulsion, accommodation of crew/passengers, ship navigation etc. They serve well-

pressed by capacity miles (the smaller the EEDI the more energy efficient ship design). The EEDI is calculated by a formula which is based on ship's powering, deadweight and speed characteristics (see Chapter 5).

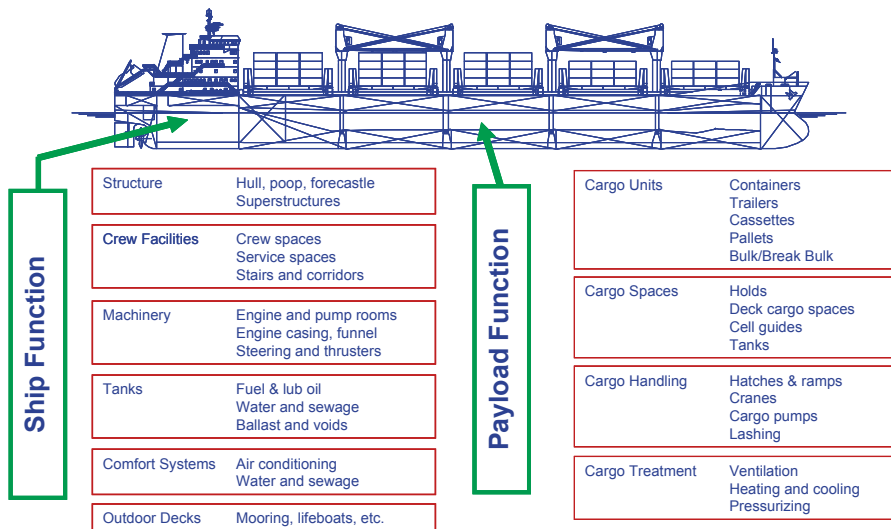

Fig. 1.12 Basic functions of a ship according to K. Levander (2009)

defined *ship functions*. Ship functions may be divided into two main categories, namely *payload functions* and *inherent ship functions* (Fig. 1.12). For cargo ships, the *payload functions* are related to the provision of cargo spaces, cargo handling and cargo treatment equipment. *Inherent ship functions* are those related to the carriage of payload, at specified speed and safely from port to port.

Considering that ship design should actually address the whole ship’s *life cycle*, we may consider ship design as being composed of various stages, namely besides the traditional concept/preliminary design, the contractual and detailed design, the stages of ship construction and fabrication process, ship operation for her economic life and scrapping/recycling. It is evident that the optimal ship with respect to her whole life cycle is the outcome of a *holistic*⁶ optimization of the entire, above-defined complex ship system for its entire life cycle (Papanikolaou 2010).

Mathematically, every constituent of the defined life cycle ship system and design stage forms a complex nonlinear optimization problem of the design variables, with a variety of constraints and criteria/objective functions to be jointly optimized. Even the simplest component of the ship design process, namely the traditional first loop (conceptual/preliminary design), is complex enough to be simplified (*reduced*) in practice. Also, inherent to ship design optimization are the conflicting requirements resulting from the design constraints and optimization criteria (merit or objective functions), reflecting the interests of the various ship design stake holders: ship owners/operators, ship builders, classification society/coast guard, regulators, insurers, cargo owners/forwarders, port operators etc. Assuming a specific set of

⁶ *Principle of holism* according to Aristotle (Metaphysics): ‘The whole is more than the sum of the parts’.

requirements (usually the shipowner's requirements for merchant ships or mission statement for naval ships), a ship needs to be optimized for lowest construction cost, for highest carrying capacity and operational efficiency or lowest required freight rate (RFR), for the highest safety and comfort of passengers/crew, for satisfactory protection of cargo and the ship herself as hardware and last but not least, for minimum environmental impact, particularly for oil carriers with respect to marine pollution in case of accidents, for high-speed vessels with respect to wave wash and recently for all ships with respect to engine emissions and air pollution. Many of these requirements are clearly conflicting and a decision regarding the optimal ship design for a set of design requirements needs to be rationally made.

To make things more complex but coming closer to reality, even the specification of a set of design requirements with respect to ship type, cargo capacity, speed, range etc. is complex enough to require another optimization (or decision making) procedure that satisfactorily considers the interests of all shareholders of the ship as an industrial product servicing the needs of international markets or others. Actually, the initial set of ship design requirements is the outcome of a compromise of intensive discussions between highly experienced decision makers, mainly by the shipbuilder's and end-users' side (shipowners) who attempt to promote their interests, while accepting some tradeoffs during contract negotiations. A way to undertake and consolidate this kind of discussions in a rational way has been advanced by the EU-funded project LOGBASED (2004–2007; Brett et al. 2006).

Modern approaches to ship design are reviewed by Andrews et al. (2009) and Papanikolaou et al. (2009d; on behalf of expert committees of the International Marine Design Conference (<http://www.imdc.cc>)).

1.3.2 Main Phases of Ship Design

Traditionally, ship design may be considered decomposed into four main phases, namely:

- a. Concept design—Feasibility study
- b. Preliminary design
- c. Contract design
- d. Detailed design

The present book deals with the first two phases of ship design (a and b), which are also known as *basic design*; they are often merged into the more general definition of preliminary design.⁷ Figure 1.13 sketches the course of the design of a ship, which is designed to service specific requirements or a mission (*Mission*), disposing certain functional (*Function*), form, space, weight (*Form*), technical performance (*Performance*) and economic characteristics (*Economics*).

⁷ The last two phases (c and d) are briefly commented on in Sect. 1.3.4.

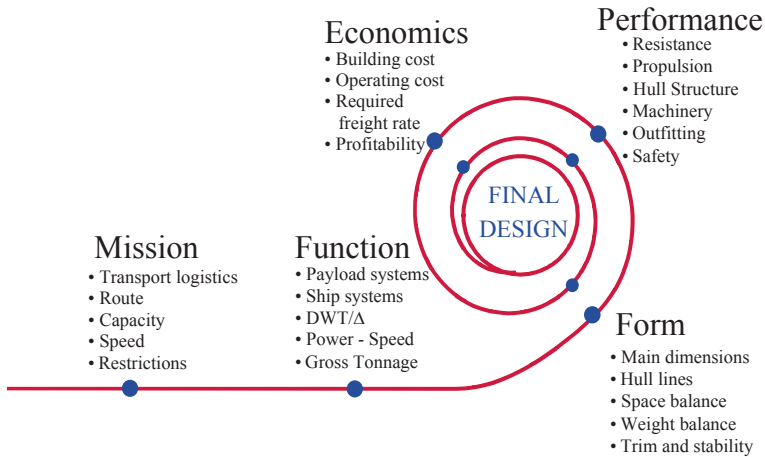

Fig. 1.13 Ship design procedure according to K. Levander (2009) and Papanikolaou et al. (2009d; coordinator)

Preliminary ship design is the early stage of design in which based on the ship-owner's or mission requirements and specifications, the main technical and economic ship characteristics are determined by optimization, particularly those ship characteristics that decisively affect the cost of shipbuilding (and indirectly the cost of acquisition) and the economy of operation.

1.3.3 Objectives of Preliminary Design

The preliminary ship design encompasses the following more detailed objectives:

- Selection of main ship dimensions
- Development of the ship's hull form (wetted and above-water parts)
- Specification of main machinery and propulsion system type and size (powering)
- Estimation of auxiliary machinery type and powering
- Design of general arrangement of main and auxiliary spaces (cargo spaces, machinery spaces and accommodation)
- Specification of cargo-handling equipment
- Design of main structural elements for longitudinal and transverse strength
- Control of floatability, stability, trim and freeboard (stability and load line regulations)
- Tonnage measurement (gross register tons)

It is understood that the determination of all above elements of ship design is subject to compliance with the specifications of various national and international maritime rules and regulations, which are enforced by national and international authorities

(flag and port states, IMO) or by an internationally recognized classification society. In cases of a lack of regulatory specifications, it is understood that the designed and built ship corresponds to the modern state of the art in shipbuilding science and technology.

Preliminary ship design is a technoeconomic feasibility study of the subsystem 'ship' as one of the most important 'earning' elements in the global maritime transportation system (or maritime network chain), of transport services and of the maritime operation (shipping) industry; trivially, a ship is also a high-investment product of the shipbuilding, maritime technology industry. Taking into account the most recent developments of shipbuilding and marine technology, the physical and technical constraints, the technoeconomic specifications of the shipowner, the national and international regulations and conventions regarding the building and safety of operation of ships, preliminary design aims at consolidating the various, partly conflicting requirements and determining the most economic design solution for the highest return of investment.

The main difficulties of ship design are due to the complexity of the various technoeconomic requirements, which are partly contradictory to each other and the in-force and in-foreseeable-future maze safety requirements of national and international regulations. In terms of fundamental fluid mechanics, the unique operation of the ship on the free sea surface, which represents an irregular boundary surface between two fluids of substantially different density (namely water and air, and so defines the surface profile of the sea waves, which is a priori unknown) and results to a time-varying (dynamic) loading on the ship's structure and to rigid body ship motions in six degrees of freedom, the complex flow around the ship's hull and a variety of other problems of ship hydrodynamics and of dynamic ship loading, form a series of unique scientific problems and of theoretical as well as technological solutions. The address of the above difficulties and proper solution of particular problems request the collaboration of scientists, designers and engineers of various disciplines, particularly when we address the development of new buildings (prototypes), without having empirical data of sister ships in hand.

The design of a ship crosses the strict boundaries of technology and science in many instances of development, coming closer to disciplines of arts. Here we understand beyond the aesthetics and architectural elements of ship design, which greatly affect the design of specific ship types (e.g. passenger cruise ships, yachts etc.), the many 'smaller and larger' problems arising in ship design and construction that are addressed more by the 'intuition' ('mastering') of the naval architect, following the tradition of small ship builders, rather than deciding rationally by use of modern decision support tools and systems. The reason for this approach in practice is namely: firstly, lack of time for an exhaustive investigation of all parameters of the set design problem, whereas a decision is due immediately; and secondly, the complexity of some problems, with manifold possible solutions, without having the certainty of a rationally optimal solution with respect to technology and economy. In this respect, the experience of the ship designer, ship builder or production manager complements lacking design data that would be obtained after tedious theoretical elaborations. Nevertheless, in recent years, information technology (IT) has been

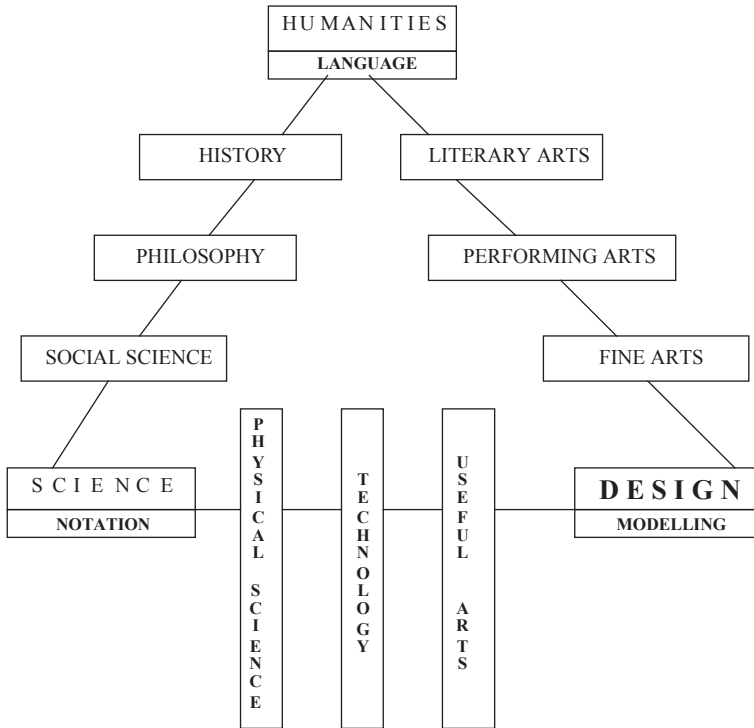

Fig. 1.14 Design in the scientific triangle

widely introduced to all phases of ship design, production and operations, closing more and more the gaps resulting from the nowadays often lack of experienced ship designers and engineers in many parts of the world.

Figure 1.14 represents schematically *DESIGN* as one of the corners of the scientific triangle, namely as a separate discipline next to *HUMANITIES* and *SCIENCES*. The design of a ship, like of any engineering object, is greatly influenced by *TECHNOLOGY*, an important part of which is *ENGINEERING* and *PHYSICAL SCIENCES*.

1.3.4 Design Procedure: Design Spiral

The design procedure described in the last section may be illustrated by the well-known *design spiral*, originally introduced by J. H. Evans (Taggart 1980; see Fig. 1.15). The design spiral effectively illustrates the sequential course of ship design through the various design steps, the repeating, iterative procedure for the determination of ship dimensions and of other properties and, finally, the gradual approach to the final stage of detailed ship design. In the figure, some *indicative ef-*

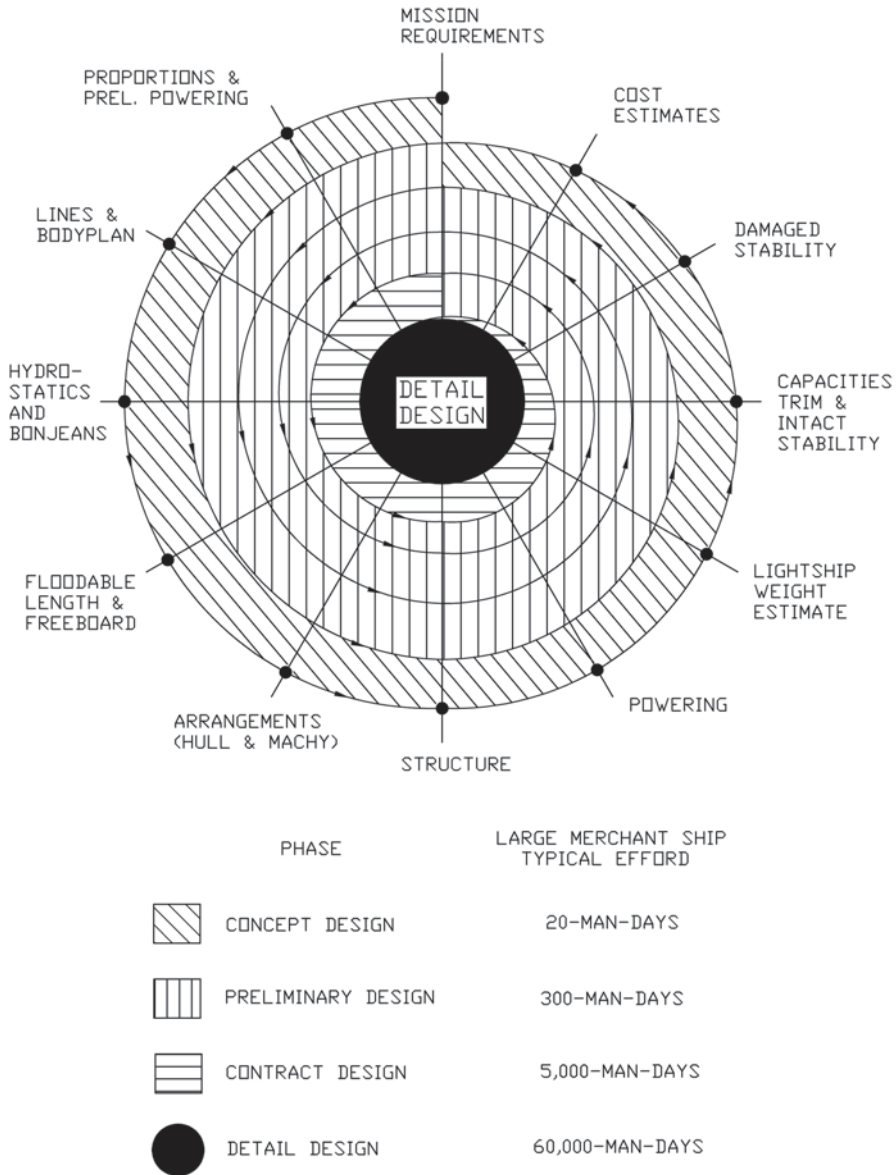

Fig. 1.15 Design spiral, J.H. Evans 1959. (see Taggart 1980)

fort in man-days for the completion of each stage of ship design is given, pertaining to the design of a large merchant ship in the late 1950s. The ship design procedure may be also illustrated by more modern and comprehensive graphical approaches, encompassing, besides the design, the manufacturing procedure as well, as illustrated in Figs. 1.16 and 1.17.

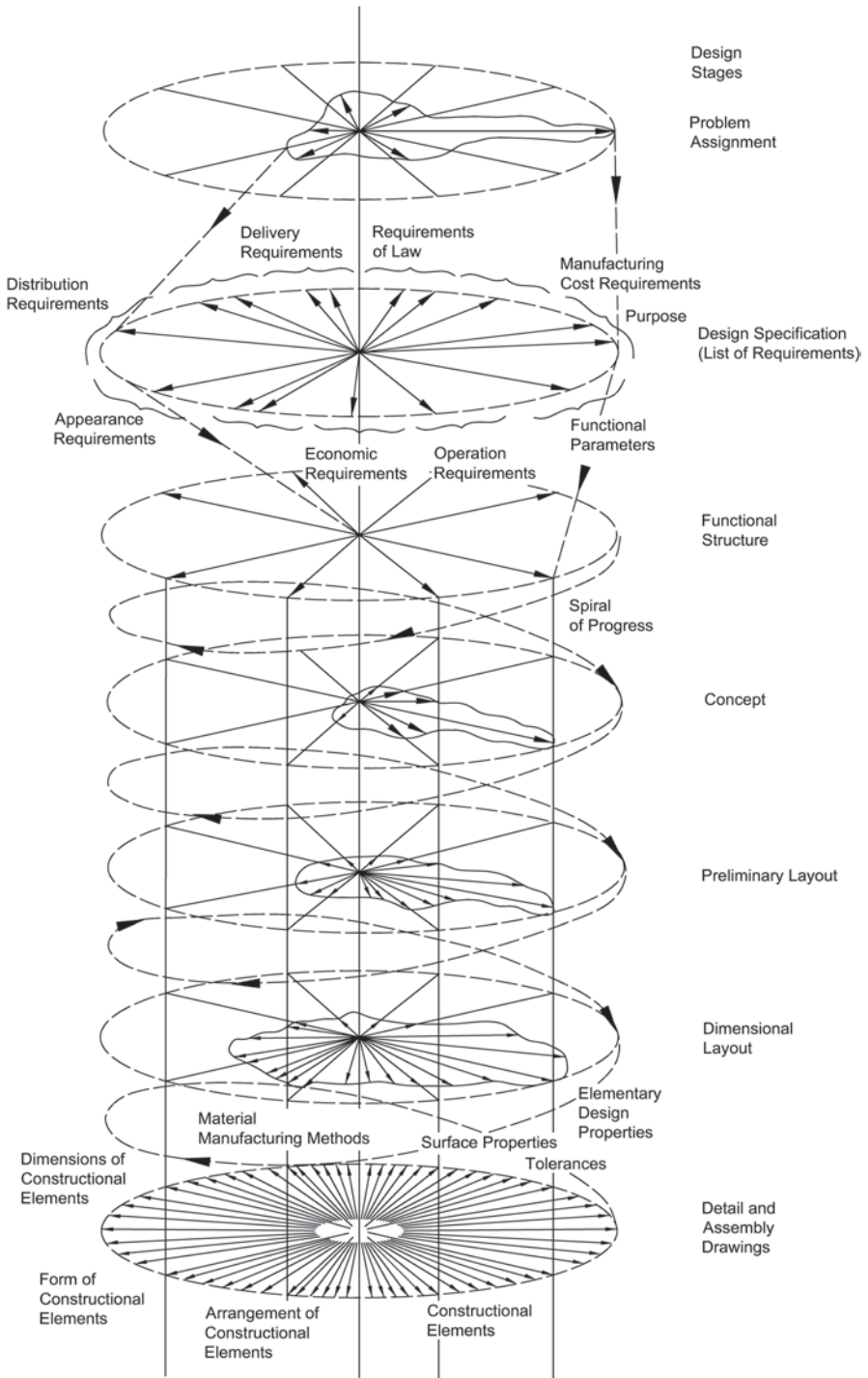

Fig. 1.16 3-D design spiral according to Sen and Birmingham (1997)

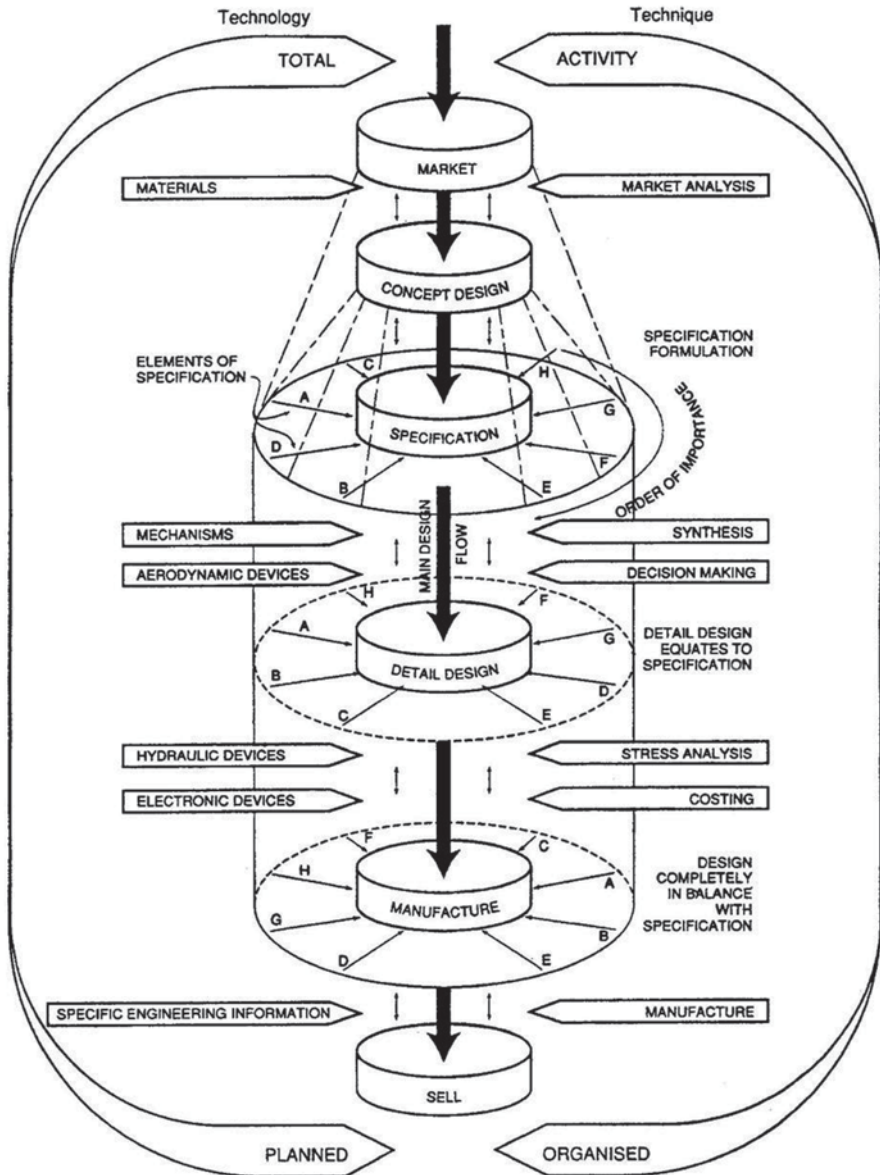

Fig. 1.17 3-D design spiral of ship design and construction, according to Sen and Birmingham (1997)

Figure 1.18 shows the results of a parametric investigation of the effect of different main dimensions and hull forms on ship's *annual cost* for given owner's requirements (according to R.D. Murphy et al., see Taggart 1980). The requirements given in this case are the hold capacity, deadweight, speed and range (endurance).

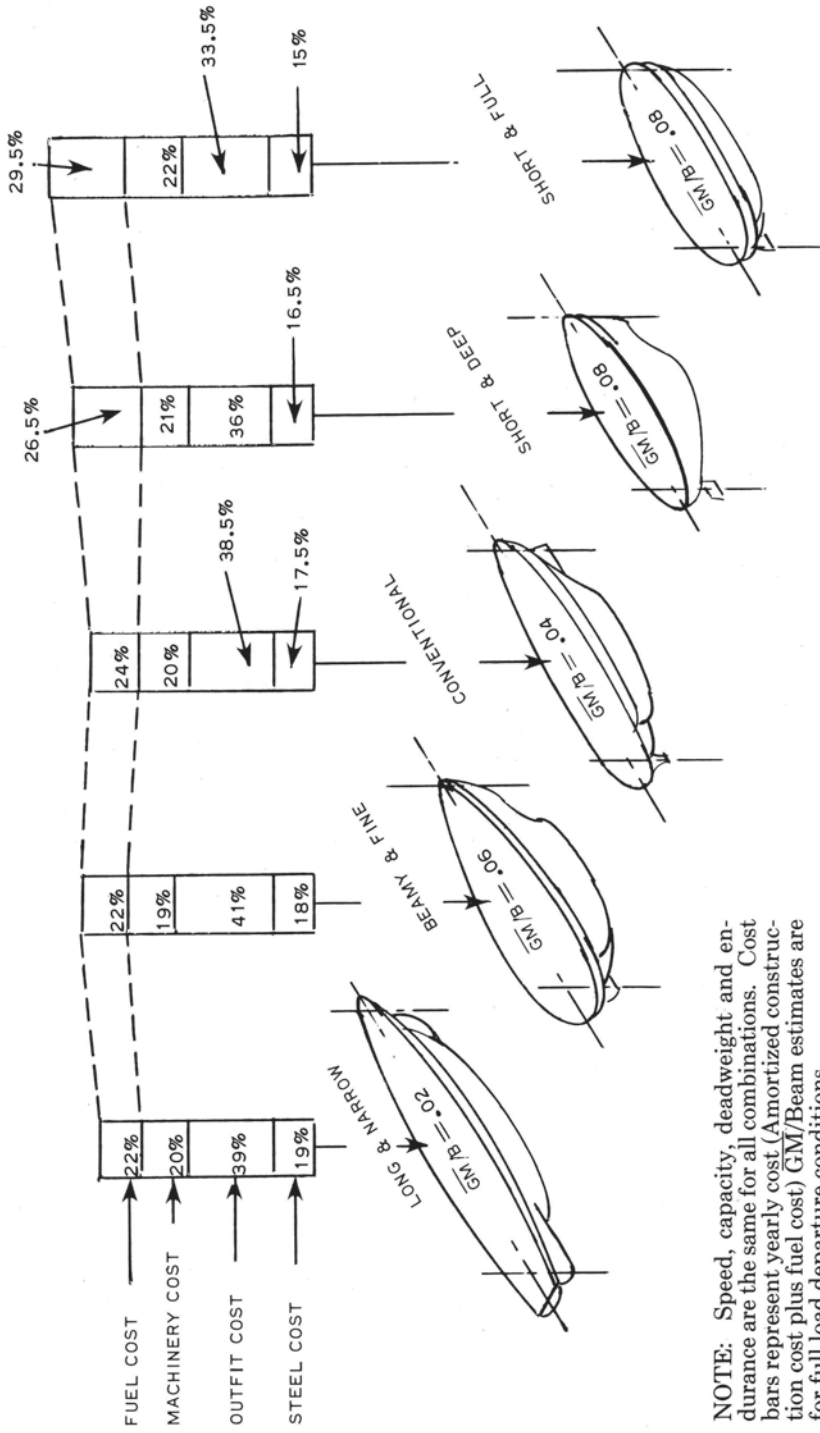

Fig. 1.18 Influence of the selection of main dimensions and hull form on the annual cost for given owner's requirements, according to Murphy et al. (see Taggart 1980)

The *annual cost*⁸ in this case is considered as the sum of amortized (depreciated) building cost plus the fuel cost. The comparison of costs for the various design alternatives is based on the differences to the corresponding values of a basic, ‘conventional’ ship. Generally it is observed that:

- *Long and narrow* designs (large length and small beam) have relatively *higher cost for steel construction and equipment*, but lower cost for machinery installation and fuel consumption.
- *Short and full* designs (small length and high block coefficient) have proportionally *lower cost for steel construction* and equipment, but higher cost for machinery installation and fuel consumption.

Note that Fig. 1.18 presents a qualitative comparison of costs and the specific absolute costs of alternative designs may vary according to the specific requirements of the shipowner (particularly in terms of the speed requirements); also, this fundamental study is using data of ships back to the 60s. However, the *qualitative characteristics of the effect of ship’s main dimensions and hull form on basic cost items remain unchanged*.

Commenting on the iterative ship design procedure illustrated by the design spiral (Fig. 1.15), the following is noted:

a. Concept Design Feasibility Study: First Iteration Loop In this design stage, the mission or (ship) owner’s requirements are translated in a first approach into technical ship characteristics (of naval architectural and marine engineering nature). This stage of ship design actually corresponds to a *feasibility study*. Preliminary estimations of the basic ship dimensions, such as length L , beam B , side depth D , draft T , block coefficient C_B , powering P_B etc. are made; alternative design solutions fulfilling the owner’s requirements are explored with respect to the identification of the most economical solution; however, the latter is not necessarily achieved at this stage, though the feasibility of satisfactory solutions is ensured.

According to R. K. Kiss (see Taggart 1980), the effort for this stage of design for a newly developed large merchant ship was, in the 50s, about 20 man-days. However, with the development of computers and software, this effort has been reduced today to about 1/20th. Thus, today, the feasibility–concept design may be accomplished in 1 day (or even less) by a naval architect, assuming a well-organized design office with proper software and ship database infrastructure.

b. Preliminary Design—Second to Fourth Iteration Loop This stage is a more comprehensive elaboration of the various ship design steps partly addressed in the first phase. It involves the accurate determination of the ship’s main characteristics, namely, length L , beam B , side depth D , draft T , block coefficient C_B and powering P_B , so as to satisfy the owner’s requirements and to correspond to an optimal solution with respect to a set economic criterion. The outcome of the preliminary design forms the basis for compilation of the *shipbuilding contract* between the owner and

⁸ The *total annual cost* of a ship includes some additional items, such as crew costs, port expenses, insurance cost etc.

Table 1.3 List of typically required naval architectural plans/drawings/studies to be developed during the contract design of merchant ships. (Taggart 1980)

| | |
|--|---|
| Outboard profile, general arrangement | Power and lighting system—one line diagram |
| Inboard profile, general arrangement | Fire control diagram by decks and profile |
| General arrangement of all decks and holds | Ventilation and air conditioning diagram |
| Arrangement of crew quarters | Diagrammatic arrangements of all piping systems |
| Arrangement of commissary spaces | Heat balance and steam flow diagram—normal power at normal operating conditions |
| Lines | Electric load analysis |
| Midship section | Capacity plan |
| Steel scantling plan | Curves of form |
| Arrangement of machinery—plan views | Floodable length curves |
| Arrangement of machinery—elevations | Preliminary trim and stability booklet |
| Arrangement of machinery—sections | Preliminary damage and stability calculations |
| Arrangement of main shafting | |

the shipbuilder. Typically, the effort for finishing the work of this stage is about 15 times larger than the estimated effort for the first phase.

The combination of phases a and b is also known as *basic design*.

c. Contract Design—Fifth Iteration Loop The objective of this stage is the completion of the necessary calculations and naval architectural drawings, as well as the drawing up of the technical specifications of the ship's building, which all form indispensable parts of the formal shipbuilding contract between the shipowner and the appointed shipyard. This design phase involves a detailed description of ship's hull form through the faired ship lines plan, the exact estimation of the powering for achieving the specified speed based on model tests in a towing tank, the theoretical or experimental analysis of the behaviour of the designed ship in waves (seakeeping studies, in general not conducted for common type merchant ships), the analysis of the ship's manoeuvring properties (not always performed, like with seakeeping), consideration of alternative propulsive systems (propeller-machine system), details of the ship's structural design, design of the ship's auxiliary/supply networks (electric, hydraulic, piping systems etc.) and finally, a more precise estimation of the individual ship weight components, of ship's total weight and the corresponding centroids.

It is estimated that this third phase requires an effort of roughly 17 times more than the second phase, which corresponded to roughly 5,000 man-days for a large merchant ship designed in the 50s according to Taggart (1980), whereas today the man-days effort has been reduced considerably to about 1/20th of the preceding value. The drawings, numerical studies and technical specifications, which are developed during contract design, are shown in Tables 1.3 and 1.4 (Taggart 1980).

d. Detailed Design In the last phase of the ship design procedure, a detailed design of all structural elements of the ship is conducted, along with the setup of the technical specifications for ship's construction and the fitting of equipment; recipients

Table 1.4 List of typically required main technical specifications to be developed during the contract design of merchant ships. (Taggart 1980)

| | |
|--|---|
| General | Forced draft system |
| Structural hull | Steam and exhaust systems |
| Houses and interior bulkheads | Machinery space ventilation |
| Sideports, doors, hatches, manholes | Air conditioning refrigeration equipment |
| Hull fittings | Ship's service refrigeration |
| Deck coverings | Cargo refrigeration—direct expansion system |
| Insulation, lining and battens | Liquid cargo system |
| Kingposts, booms, masts, davits, rigging and lines | Cargo hold dehumidification system |
| Ground tackle | Pollution abatement systems and equipment |
| Piping—hull systems | Tank level indicators |
| Air conditioning, heating and ventilation | Compressed air systems |
| Fire detection and extinguishing | Pumps |
| Painting and cementing | General requirements for machinery pressure piping systems |
| Navigating equipment | Insulation—lagging for piping and machinery |
| Life saving equipment | Emergency generator engine |
| Commissary spaces | Auxiliary turbines |
| Utility spaces and workshops | Tanks—miscellaneous |
| Furniture and furnishings | Ladders, gratings, floor plates, platforms and walkways in machinery spaces |
| Plumbing fixtures and accessories | Engineers' and electricians' workshop, stores and repair equipment |
| Hardware | Hull machinery |
| Protection covers | Instruments and miscellaneous cage boards—mechanical |
| Miscellaneous equipment and storage | Spares—engineering |
| Name plates, notices and markings | Electrical systems, general |
| Joiner work and interior decoration | Generators |
| Stabilization systems | Switchboards |
| Container stowage and handling | Electrical distribution. |
| Main and auxiliary machinery | Auxiliary motors and controls |
| Main turbines | Lighting |
| Reduction gears—main propulsion | Radio equipment |
| Main shafting, bearings and propeller | Navigation equipment |
| Vacuum equipment | Interior communications |
| Distilling plant | Storage batteries |
| Fuel oil system | Test equipment, electrical |
| Lubricating oil system | Centralized engine room and bridge control |
| Sea water system | Planning and scheduling, plans, instructions, books etc. |
| Fresh water system | Tests and trials |
| Feed and condensate systems | Deck, engine, and stewards' equipment and tools, portable |
| Steam generating plant | |

of this information are the yard's production units (panel–hull technicians, welders, fitters, machinists, riggers etc.), and the external suppliers of mechanical equipment and other outfitting.

A characteristic of this phase is that, while the generated drawings and specifications are the outcome of studies and work of expert engineers (naval architects and marine engineers), the subsequent implementation of the designs into practice depends solely on the capabilities of the shipyard's production units, in terms of both hardware infrastructure and human resources (foremen and technicians of the yards). According to data from Kiss (see Taggart 1980), this stage of design requires 60,000 man-days, a tremendous effort in the late 50s, whereas today it is a small fraction of it depending on the availability of experienced designers in the yard and the degree of applied IT technology in the yard's design and production departments.

Reviewing all the stages (a) to (d) of ship design, it may be concluded that, based on the results of the Basic Design (a and b), both the main technical features and the construction cost of an economically efficient vessel can be reliably estimated. Thus the shipyard may proceed with the preparation of a tender to the interested shipowner; and in case the tender is accepted, the more detailed and demanding third and fourth design phases are to be completed.

1.3.5 Owner's Requirements: Statement of Work

The main requirements of a ship owner with respect to the design and construction of a merchant ship are driven by a variety of factors that are all related to the attractiveness of a shipping business in terms of return on investment; this business opportunity might lead to a shipbuilding contract. A sample of these factors is listed below:

1. Replacement or conversion of aged or less competitive ships. These are ships with unsatisfactory payload, speed and/or operational cost characteristics or ships not complying with newly introduced safety regulations pertaining to the Safety Of Life At Sea (SOLAS), or the protection of the marine environment (MARPOL, OPA 90).
2. Extension or change of activities of a shipping service in an already serviced market (increase of competitiveness).
3. Development of new services in other geographical areas (geographic extension of business activities).
4. Transportation of new types of cargo in an existing line/market (increase of share in local trade).
5. Introduction of advanced marine technology in terms of
 - a. AMV: high speed and innovative design vessels
 - b. Innovative cargo handling systems: modern and innovative loading–unloading systems; transport of high-value cargo in standardized transport units (containers, pallets etc.)
 - c. Intermodal transport systems: integrated sea–land–river transport systems etc.

6. Development of special types of ships supporting shipping, offshore and ocean surveillance activities: tug boats, icebreakers, pilot boats, offshore supply vessels, Search And Rescue (SAR) vessel, hydrographic/research vessels etc.
7. Development of floating offshore structures in the framework of ocean/offshore technology.

Typical main requirements of a shipowner interested in a new shipbuilding contract are listed and commented in the following:

- a. *Transport capacity*, expressed by a ship's *deadweight*,⁹ capacity of cargo spaces (in terms of holds' volume), the number of transported containers, number and type of transported vehicles or/and passengers (in excess of crew), as applicable.
- b. *Speed in trial condition*, at 100% maximum continuous rating (MCR) of engine power.
- c. *Range or endurance* (expressed in sea miles or days of operation without refueling) for a specified routing scenario at service speed and with indication of ports for refueling and replenishment.
- d. *Class*: by an internationally recognized *classification society*.

These requirements are supplemented by national and international safety regulations (IMO, www.imo.org), which pertain to a ship's stability and floatability in intact condition and in the case of loss of the ship's watertight integrity, to fire safety, to the ship's navigational equipment, to lifesaving equipment, and to the ship's evacuation procedures (SOLAS); they refer, also, to the determination of the ship's load line¹⁰ and required freeboard (International Convention on Load Lines, ICLL), to ship's tonnage measurement (International Convention on Tonnage Measurement of Ships), to the protection of the marine environment from oil pollution and of the air from toxic gases released by ship engines (MARPOL), the number and type of crew (according to flag state regulations), the manner of transport of dangerous cargo/goods etc.

The extent and detailing of a shipowner's specific requirements depend on the organization/preparation of the shipping company's technical services and may vary between some general requirements, as stated earlier (in the case of small shipping companies) and up to a comprehensive technical specification of a ship's construction (in the case of large shipping companies, e.g. international oil companies etc.)

The procedure of awarding a shipbuilding contract to a yard begins with the shipowner's exploration of solicited tenders of competing yards. The tenders are de-

⁹ A ship's *deadweight* (occasionally called: deadweight tonnage or transport capacity, abbreviated DWT) is equal to the total sum of *additional weights* that may be added to the weight of the *entirely empty, but fully equipped and ready for operation ship*, such as payload, fuel, including lubrication oils, passengers and crew with luggage, various provisions, various waters of different quality and purpose (fresh and drinking water, cooling water, boiler feeder water), ballast water, variable equipment accessories. Note that the *light ship weight* of a ship corresponds to the empty (light), but fully equipped and ready-to-operate ship, without any load, fuel, provisions or supplies. *The sum of light ship weight and deadweight is equal to ship's displacement weight.*

¹⁰ Specifying ship's maximum loading and draft.

veloped in accordance to the set shipowner's requirements and consist in principle (at least) of an estimation of ship's main dimensions and of the other main design characteristics, a preliminary general arrangement of main spaces and equipment and a preliminary estimation of costs, along with a time schedule for the completion of works and ship delivery (*tender design*). In general, the shipowner awards the contract to the yard with the 'best' offer (*lowest building cost* or *best value for money*), considering, however, the offered financial terms by the yard (extent of down payment, support in securing competitive loans from banks etc.). It should be noted that if the tendering yards are likewise reliable in terms of offered technology and quality of production, the yard offer associated with the lowest-cost ship, complying with the set requirements, will be indeed the most attractive for the shipowner.

In the shipbuilding contract between the shipyard and the shipowner we have listed on one side the commercial terms and legal conditions (guarantees, financing terms, delivery date etc.) and on the other side the technical description of the ship. The technical details of the ship may be found in shipyard's initial design documentation (*tender design*), but are given in more details in the technical specifications booklet for the ship under construction, which is often prepared during the ship's construction (when it comes to new designs from scratch). Of course, the availability of a complete technical specification when signing the contract is not excluded, if the yard has corresponding information from own past standard ship designs, or when the owner has its own specifications from previous constructions or through the design by his own technical services.

Fig. 1.19 describes schematically the flow of the production planning for the successful design, construction and profitable operation of a ship (life cycle approach), relating to a series of necessary actions for the naval architect/ship designer, the shipyard and the ship operator/owner.

The preceding *main requirements* of an interested ship owner are now elaborated in the following:

- a. The *transport capacity* of a cargo ship is expressed by her DWT because the contracted tons DWT can be easily checked during (or shortly after) a ship's delivery by the difference in the ship's displacement weight in the fully loaded and light ship conditions (through readings of draft marks at the ship's bow, amidships and stern).

The shipowner may, to a certain degree, adjust/adapt the amount of carried payload to the actual market needs by corresponding changes in the amount of carried fuel without changing the ship's deadweight.

Regarding the degree of achievement of the contracted deadweight capacity, the following (or similar) provisions (*penalties*) are generally set in the shipbuilding contract: According to Schneekluth (1985), if the difference of specified and finally achieved deadweight is less than about 2%, no penalty provisions will apply; if the difference is up to about 5%, proportional reduction of shipbuilding price; in case of more than 5% less deadweight capacity, possible rejection of ship by the owner with full refund of down-payments or significant reduction of payments.

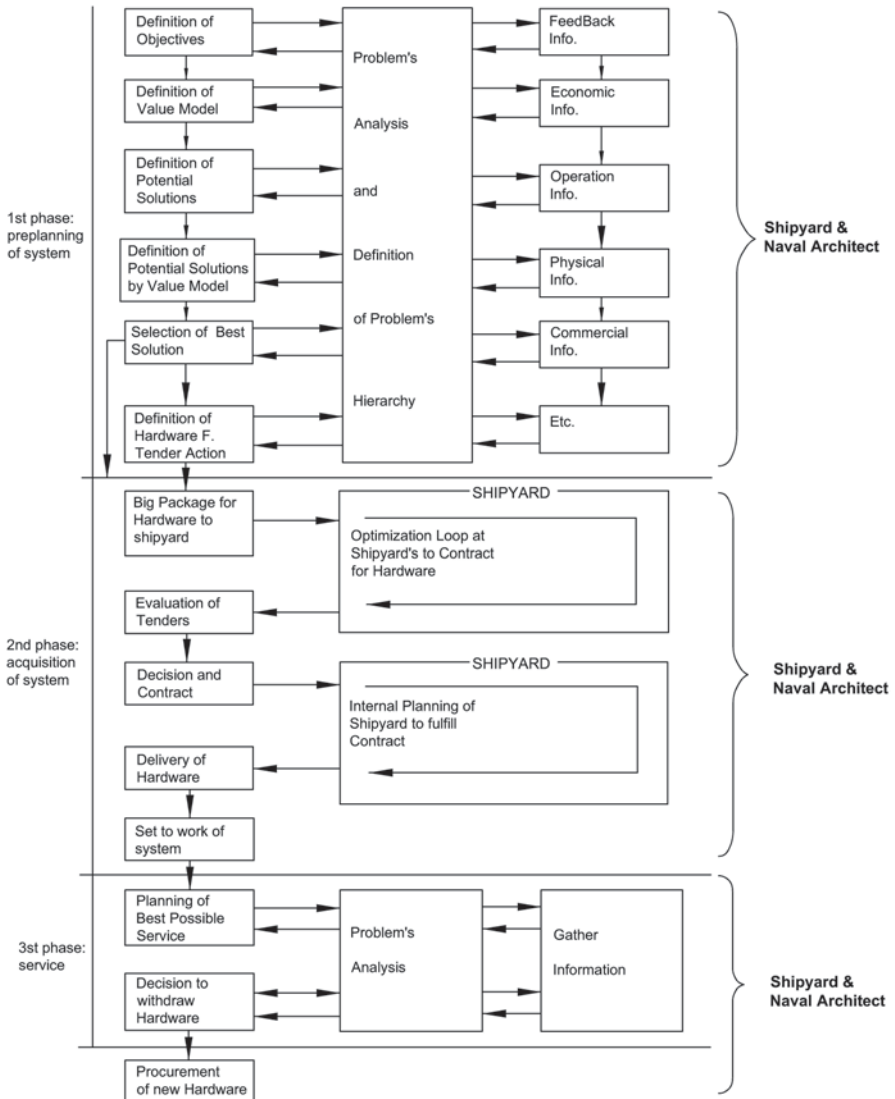

Fig. 1.19 Planning procedures for the design, construction and operation of a ship. (Sen and Birmingham 1997)

It is evident that for special types of ships with their main mission beyond cargo or passengers transportation, the deadweight as a main requirement is replaced by other ship characteristics, representing the essential value of the vessel, for example, for tugboats, a main requirement is the pulling force (or bollard pull) and propulsion power; for icebreakers, an additional factor is the maximum ice thickness in which the ship may operate at a certain speed (*ice class*).

Specification of the cargo *hold capacity* is set by the owner for covering the *stowage* needs of certain cargo. Thus, for tanker ships, the crude oil tank volume is specified; for ‘reefer’ cargo ships, the *net* hold volume for refrigerated cargo is specified; for general cargo ships, the additional tank volume for the carriage of animal or vegetable oil and other liquids may be specified.

The reference to the number of containers (*TEUs*: twenty feet equivalent units or *FEUs*, forty feet equivalent unit, cross section 8×8 feet, length 20 and 40 feet, respectively) or number of vehicles (private cars, trucks, trailers), or the *length of vehicle lanes* on car decks may be related to specialized ships for the carriage of these types of cargos (cellular type containerships or roll-on/roll-off ships), but also to multipurpose cargo ships carrying this type of cargo based on demand. The same applies to the number of carried passengers, in excess of crew, which refers to the combined type of cargo RO-RO passenger ships (ferry or ROPAX) with length over about 60 m, rather than to pure passenger ships (for shortsea services only). Pure passenger ships of large size are encountered today only as cruise ships, in contrast to the ocean liners for transatlantic/intercontinental transport services that dominated the transport of valuable goods and passengers between the continents until the late 50s.

It should be noted that today the combined cargo–passenger ship (a cargo ship carrying *more than 12 passengers* in excess of the crew¹¹) has practically disappeared as ship type, with few exceptions in specific routes and in some modern RO-RO cargo ships (carrying truck drivers).

- b. The owner’s requirement for a minimum *speed in trial conditions* (thus wind force up to a maximum 2–3 Beaufort, calm and deep water, without current or tide effects and a clean ship hull surface) at a specified draft (displacement) is founded on the easy control of ship’s propulsive efficiency (performance of main machinery and propulsion system) in relation to the ship’s hull form and displacement on the basis of the speed achieved. During delivery, the speed is commonly measured by the time to pass 1 nautical sea mile (1852 m), as it has been specified for a route near the shipyard and mutually agreed. The vessel’s speed is continuously recorded using nowadays differential global positioning system (GPS). The same route is sailed in the opposite direction to balance the effect of wind, currents and tide. The trial procedures are detailed in a separate document attached to the shipbuilding contract.

The specified trial speed refers in general to the *design* draft (and ship’s displacement) and to 100% or another rating of MCR of the main machinery. Because during the trials, except for tankers and some passenger ships, the design draft and displacement cannot be achieved, the trial speed may be measured for a reduced draft (e.g. at the ballast condition), and the measured speed may be scaled to the value at design draft by an agreed calculation procedure (e.g. by use of admiralty’s constant or similar). Regarding the possible deviations between the contracted speed

¹¹ A cargo ship may carry up to 12 passengers in excess of her crew. Any ship carrying more than 12 passengers needs to comply with the safety provisions of passenger ships (SOLAS).

and the speed at delivery, the following penalties (rarely premiums, similar to the provisions for deadweight deviations) apply in general: deviation up to about 2% or about ½ knot at 20 knots speed, no or small penalty applies; deviation up to 5% or about 1 knot less speed, significant reduction of shipbuilding price; deviation by more than 5%, shipowner reserves the right to reject the ship delivery; in case of achieving a higher speed than contracted, a *premium* might be paid to the yard. The same often applies for *early* ship delivery and achieved *higher transport capacity* (deadweight), if so agreed in the contract.

- c. Among the remaining main requirements, the *range or endurance*, i.e. given in sea miles/days of operation without refuelling/replenishment, determines the amount (weight) and required volume of fuel and other liquid tanks as necessary for the ship's operation (lubrication oil, fresh and drinking water etc.)
- d. The satisfaction of the construction regulations of an *internationally recognized classification society* is included in the main requirements; they refer to the award to the ship of a specific 'class', which is necessary for the various authorities to permit the ship's operation. The award of a 'class' essentially corresponds to the issuance of a series of safety certificates ensuring the integrity of the ship's structure and of the ship's vital equipment and outfitting (ship's machinery, propulsion and steering system, including auxiliary devices) that affect the ship's safety. Selection of the classification society is generally a matter of the shipowner to decide.

The internationally most important¹² class societies are members of the International Association of Classification Societies (IACS, www.iacs.org.uk) and are listed as follows:

- UK: Lloyd's Register of Shipping (LR, www.lr.org)
- Germany: Germanischer Lloyd (GL, www.gl-group.com)¹³
- Norway: Det Norske Veritas (DNV, www.dnv.com)
- USA: American Bureau of Shipping (ABS, www.eagle.com)
- France: Bureau Veritas (BV, www.bureauveritas.com)
- Italy: Registro Italiano Navale (RINA, www.rina.org)
- Japan: Nippon Kaiji Kyokai (NKK, www.classnk.or.jp)
- P.R. China: China Classification Society (CCS, www.ccs.org.cn)
- Korea: Korean Register of Shipping (KR, www.krs.co.kr)
- Russia: Russian Maritime Register of Shipping (RS, www.rusregister.ru)

¹² Mainly in terms of volume of activities, i.e. total fleet tonnage under class and R&D effort. As of 12 September 2013, DNV and GL have merged to form DNV GL.

¹³ For example, class notation *GL* ☒ *100 A5 E* means a ship classified by GL. ☒: The Maltese cross indicates that hull, machinery and/or special equipment have been constructed under the supervision and in accordance with the rules of GL. The square around the cross shows proof of subdivision and damage stability requirements for the hull. *100A5*: the ship's hull fully complies with the requirements of the Construction Rules of GL. The number 100 indicates the maintenance condition of the ship's hull in relation to the requirements of the construction rules, taking into account the permissible corrosion and wear tolerances. The number 5 indicates the duration of the class period in years. *E*: Hull and/or machinery have been designed such as to comply with the requirements for navigation in ice, with index 4 representing the highest notation.

In the common shipowner's requirements, the following terms may be also included: the number of propellers, the type and manufacturer of main machinery (for diesel engines according to engine listings, however, without specifying the machinery powering, which will be an essential result of ship design), the type, number and arrangement of the cargo handling system (for tankers, pump power), the quality of crew accommodations and especially passenger cabins and public spaces, if the ship is a cruise ship or ROPAX ferry.

Regarding the ship's main dimensions, there are in general no specifications or boundary limits set by the shipowner, except for navigational constraints (passing through canals and narrow channels: limits on maximum draft and beam, seldom on length; approaching harbours: limits mainly on draft, seldom on length). Also, normally, there are no specifications regarding a ship's stability properties in the various loading conditions, except for the initial stability (minimum \overline{GM}) for fishing vessels and sometimes for RO-RO passenger ships, containerships and 'reefer' ships; clearly, the built ship is assumed fulfilling all relevant international and national safety regulations, including those for intact and damage stability and floatability.

The preceding safety regulations specify in detailed form the requirements (criteria) pertaining to the safety of the global system 'ship' (vessel, crew, passengers, cargo) and 'marine environment' (marine biology and coastal areas) in normal and extreme ship operating conditions (dangerous/adverse weather conditions, collision with other ships, grounding, flooding, explosion and fire).

Finally, where the regulatory framework and the shipowner's requirements do not literally prescribe a specific ship performance measure or property, it is tacitly understood that the ship needs to perform according to contemporary shipbuilding technology and state of art of science.

Especially regarding the operability of the ship, the following are expected (without literally specifying them):

- a. Good seakeeping performance (seaworthiness)
- b. Good manoeuvring properties (stability of course keeping, small turning diameter, small distance for slowing down from maximum speed to zero—crash stop)
- c. Good arrangement of cargo spaces (easiness of cargo stowage and access to holds and lower decks)
- d. Good arrangement of functional spaces (easy access to spaces and ergonomic arrangement of equipment; arrangement of machinery space and navigational bridge)

Good arrangement of accommodations, public spaces and access ways (design of simple access ways to spaces, corridors etc., especially on passenger ships; optimization of pathways of crew from their cabins to working areas; comfortable accommodations for passengers and crew).

Finally, the design and construction of *naval ships* (warships) are governed by other types of criteria, namely, those referring to the fulfilment of a mission under specific operational/environmental conditions (especially wave and wind conditions) in the frame of needs of national defence of a country. The main factors af-

fecting the fighting capability and main requirements for the design of a naval ship are as follows:

1. Type of naval ship and mission (corvette, frigate, cruiser, destroyer, aircraft carrier, surveillance vessel etc.)
2. Type and extent of armament and electronic/operational outfitting
3. Number of crew, including ratings and accommodation requirements
4. Structural reinforcements, i.e. armour/shielding of the hull
5. Floatability and stability after damage, damage control
6. Sustained speed in calm waters and in specified seaways (top and cruise speeds at specific engine ratings)
7. Specification of seakeeping and manoeuvring capabilities
8. Range/endurance without replenishment

It is characteristic that the design, construction and operation of naval ships are governed by purely technological and physical performance criteria, because they result from the latest developments of science and technology and, to a lesser degree, are affected by economic considerations. The history of shipbuilding (as in other branches of technology) is rich in examples of innovative technological solutions applied first to naval ships and which were later successfully adapted to merchant ships (for example, the use of new construction materials: higher tensile steels, aluminium alloys, and synthetic materials; the use of gas turbines as main machinery; and the introduction of electronic control systems, onboard computers etc.).

1.3.6 Preliminary Ship Design Methods

1.3.6.1 General

The usual and recommended steps when the preliminary ship design is elaborated are listed below:

- a. *Critical Evaluation* of the ship owner's main requirements with emphasis on those which influence the main dimensions' selection.
- b. *Data Gathering* (by ship type, size, DWT, speed and main engine installed power) of built similar ships in available publications, including databases (i.e. Lloyd's Register Fairplay Database, recently renamed to IHS Fairplay World Shipping Encyclopedia, see <http://www.ihs.com/products/maritime-information/ships/world-shipping-encyclopedia.aspx> with technical data for over 1,160,000 ships of GT > 100, NTUA Ship Design Laboratory Database with technical details for over 700 European RO-RO Cargo and Passenger Ships of over 1000 GT). Designers working in the shipbuilding industry or design offices may exploit available technical information about built ships filed in the design department's records.
- c. *Identification and Study* of the relative/corresponding regulations concerning the specific ship type design, construction and operation: resolutions, national and international regulations, class society regulations, technical notes, guidelines and instructions.

1.3.6.2 Ship Types

Before presenting an outline of our generalized approach to ship design, it is rational to proceed to a categorization of the various ship types into some main ship categories that may be characterized by common design procedures. These categories, referring to common design features of various ship types, are as follows:

- a. *Deadweight carriers*, with their deadweight capacity as a decisive design characteristic. These are ships that carry relatively heavy cargos with a *Stowage Factor (SF)*¹⁴ that is less than about 1.3 m³/t (e.g. ores, cement, coal, grain, oil etc.). Typical representatives of this ship category are bulk carriers (bulk/ore carriers) and tankers (crude oil carriers); also included herein are general cargo ships on charter trade (tramp ships), transporting dry cargo with relatively low stowage factor in bulk or as break cargo. The common design characteristic of this type of ship is that there may be available space in the cargo holds to accept even more cargo; however, the *maximum allowable draft (or minimum required freeboard)* of the ship, according to the provisions of the Load Line Convention, restricts further loading. The ship's *Capacity Factor (CF)*¹⁵ is relatively low and generally less than about 1.5 m³/t DWT.
- b. *Volume carriers*, with the most significant design characteristic being their hold volume capacity. These are ships that carry relatively light weight cargos with a stowage factor of more than about 2.0 m³/t (e.g. cotton, tobacco, fruits, high-value industrial goods, electronic and electric equipment, cars etc.). Typical representatives of this ship category are the RO-RO cargo ships, car carriers in general (PCC: pure car carrier, PCTC: pure car and truck carrier), RO-RO passenger ships (ROPAX, ferries), containerhips, 'reefer' ships, general cargo ships in liner services (liners), and passenger/cruise ships; they dispose in general at least one continuous deck above the freeboard deck (bulkhead deck); they do not fully exploit, in general, the maximum allowable draft, as it results from the provisions of the Load Line Convention; they dispose in general excessive freeboard, because there is lack of available hold volume to accept more cargo; they dispose a relatively high capacity factor of more than about 2.5 m³/t DWT. Ships carrying intermediately heavy cargos (stowage factor between about 1.3 and 2.0 m³/t) or alternative cargos of strongly varying stowage factor may be designed as deadweight or volume carriers.
- c. *Linear dimension ships* with one linear dimension (length, beam, draft or side depth) restricted by physical external boundaries or constraints set by the carried cargo. These are ships with restrictions because of passing major canals, such as the canals of the St. Lawrence Seaway (Lake Ontario, Great Lakes bulk carriers) with a maximum allowable beam of 22.85 m; the Panama canal, with a maximum overall length of 294.13 m (965 ft), beam of 32.31 m (106 ft) and

¹⁴ *SF*, cargo property, expresses the required volume for the stowage of 1 ton of cargo.

¹⁵ *CF*, ship property, is the ratio of ship's cargo hold volume to ship's deadweight (German: Räumte).

draft of 12.04 m (39 ft 6 in), the so-called PANAMAX¹⁶ ships, or operating near the mouth of important rivers, for example, La Plata River (South America), of importance to ‘reefer’ banana ships, with a maximum draft of 8.2 m. Also, ships carrying standardized cargo units, such as containerships (i.e. cellular-type containerships), have a well-defined beam (and side depth height) that is determined by the number of stowed containers in the transverse (and in the vertical) direction, considering that the beam (and height) of the containers is standardized (cross section: 8×8 ft, 8 ft = 2.438 m; some containers may be 8.5 ft high). The same applies to other box-type cargo ships, such as ships carrying floating barges of standardized dimensions, LASH (lighter aboard ship) and SEABEE, ships carrying vehicles of standard size (RO-RO cargo and RO-RO passenger ships, rail-ferry ships etc.). Common characteristic of all these ship types is the step-wise (discontinuous) change of their beam and the relatively increased length, especially if the beam happens to be restricted (e.g. PANAMAX ships); thus in general these are ships for which the relationship between main dimensions and displacement is distorted and less optimal.

- d. *Special-purpose* ships. These are ships that cannot be categorized in the preceding main categories owing to specific conditions of their design and operational profiles, e.g. tugboats, icebreakers, fishing vessels, and offshore support vessels. Likewise, all *unconventional* ships are inherently special-purpose ships, and their design greatly depends on specific type, size and speed (high-speed craft in general, advanced marine vehicles, mono-, twin- and multihull vessels: catamarans, trimarans, pentamarans, air-cushion vehicles, submarines etc.).
- e. Other methods or criteria of categorization of ship types are according to:
 - Mission profile
 - Merchant ships
 - Naval and coast guard ships
 - Research/hydrographic vessels
 - Sport boats
 - Tug boats
 - Ice breakers
 - Dredgers
 - Support vessels of offshore activities: supply vessels, drilling ships, exploration and production floating platforms, floating production storage and offloading terminals (FPSO), crane ships etc.
 - Pilot boats
 - Cable ships
 - Operation area
 - Open/deep water ships
 - Inland ships—river and lake boats

¹⁶ An expansion of the Panama Canal is under way (expected completion in year 2014), in the way to allow the passing of ships (New Panamax) with maximum lengths of up to 366 m (1,200 ft), beam up to 49 m (160.7 ft), and draft up to 15.20 m (49.9 ft). These dimensions correspond to the size of the recent generation of MEGA(JUMBO)-containerships, with a carrying capacity of up to about 12,000 TEU.

- Floatability
 - Surface ships
 - Underwater vehicles
 - With forward speed (submarines)
 - Without or with very small forward speed (bathyscaphs)
- Type of power
 - Mechanical engine-driven
 - Wind sails
 - Oars/by rowing
- Propulsion type
 - Paddle wheel
 - Side-wheeler
 - Sern-wheeler
 - Propeller
 - Stern-vertical
 - Horizontal Voith—Schneider patent
 - Water jets
- Main machinery/engine type
 - Steam engines
 - Turbines
 - Steam-powered
 - Gas-powered
 - Diesel engines
 - Low-speed
 - Medium-speed
 - High-speed
 - Otto gas engines
 - Diesel/electric generator set
 - Combined diesel and gas turbines (CODAG)
 - Nuclear steam-powered turbines
 - ‘Green’ environmentally friendly prime or auxiliary energy sources
 - Wind and solar energy
 - Sail foils and solar cells
 - Fuel cells
 - LNG fuel cells
- Construction material
 - Steel
 - Aluminium alloys
 - Wood
 - Synthetic materials
 - Marine concrete

NYK Super Eco Ship 2030

- Type of transported cargo
 - General cargo ships
 - Bulk carriers
 - Tankers
 - Gas carriers
 - LPG tankers: transportation of petrochemical gas products in liquid form at low temperature and/or high pressure
 - LNG carriers: transport of natural gas in liquid form at very low temperatures, -163°C
 - Break bulk carriers
 - Break bulk cargo ships
 - Container ships
 - Floating barge carriers
 - Barge carriers
LASH
SEABEE
BACO (barge–container carrier)
 - Vehicle carriers
 - PCC and PCTC
 - RO-RO cargo ships
 - Passenger/RO-RO-RoPAX
Rail and combined RO-RO rail ships
 - Heavy lift transport ships
 - Multipurpose cargo ships
 - Passenger ships
 - Cruise ships
 - Day cruise ships
 - Overnight cruise ships
 - Short sea passenger transport ships
 - Day ships
 - Overnight ships
 - Excursion boats

Descriptions of the main types and their development are included in Volume II of Papanikolaou (2009a).

Table 1.5 presents a breakdown of the world fleet by basic ship types for the year of 2011 (existing, newly building and on order; IHS Fairplay WSE 2011).

Table 1.6 presents a breakdown of the Greek-owned fleet by basic ship types for the year of 2011 (existing, newly building and on order; IHS Fairplay WSE 2011).

Typical representatives of the different types of ship designs can be seen in Figs. 1.20, 1.21, 1.22, 1.23, 1.24, 1.25, 1.26, 1.27, 1.28, 1.29, 1.30, 1.31, 1.32, Fig. 1.44 to Fig. 1.51.

1.3.6.3 Methods for Determining Main Dimensions

There are two basic methods in ship design for the preliminary estimation of the main dimensions and the basic form characteristics, namely the *relational* or

Table 1.5 World cargo ship fleet for year 2011 according to ship types. (IHS Fairplay WSE 2011)

| Ship type/category | No. of ships | DWT (millions) | GT(millions) |
|---|--------------|----------------|--------------|
| <i>Reference year 2011 (Ships built since 2000, including ships on order)</i> | | | |
| Oil | 3,665 | 382.4 | 206.1 |
| Bulk dry | 7,182 | 571.0 | 310.0 |
| General cargo | 4,689 | 41.8 | 29.1 |
| Container | 3,715 | 195.8 | 173.6 |
| Chemical | 3,344 | 75.6 | 47.3 |
| Liquefied gas | 929 | 37.8 | 43.3 |
| Ro-Ro cargo | 219 | 2.4 | 4.5 |
| Other bulk dry | 242 | 6.0 | 4.8 |
| Refrigerated cargo | 81 | 0.6 | 0.5 |
| Passenger/Ro-Ro cargo | 725 | 1.5 | 7.2 |
| Other dry cargo | 91 | 1.6 | 1.5 |
| Passenger | 697 | 0.07 | 0.4 |
| Passenger/general cargo | 43 | 0.04 | 0.08 |

Table 1.6 Greek-owned cargo ship fleet for year 2011 according to ship types (IHS Fairplay WSE 2011)

| Ship type/category | No. of ships | DWT (millions) | GT (millions) |
|---|--------------|----------------|---------------|
| <i>Reference year 2011 (Ships built since 2000, including ships on order)</i> | | | |
| Oil | 489 | 66.7 | 35.3 |
| Bulk dry | 915 | 78.9 | 42.5 |
| Container | 151 | 11.9 | 9.2 |
| Chemical | 286 | 9.9 | 6.0 |
| Liquefied gas | 76 | 3.2 | 3.6 |
| RO-RO cargo | 70 | 1.1 | 3.2 |
| Passenger/RO-RO cargo | 93 | Not available | 1.0 |
| Passenger | 20 | Not available | 0.06 |



Fig. 1.20 Bulk carrier

empirical method and the *parametric method* (Fig. 1.33) or method of independent parameters:

a. Relational or Empirical Method The estimation of main dimensions is based on comparative data from a similar built ship, with the data stemming from open source/public information (web search), commercial and internal databases and



Fig. 1.21 Ultra large crude carrier (ULCC)



Fig. 1.22 LNG carrier

Fig. 1.23 Containership





Fig. 1.24 LASH (Ligther Aboard Ship)



Fig. 1.25 SEABEE



Fig. 1.26 BACO (Barge container)



Fig. 1.27 RO-RO (Roll-On Roll-Off cargo ship)



Fig. 1.28 Pure car carrier (PCC)

Fig. 1.29 Heavy lift carrier





Fig. 1.30 RO-RO/passenger (RoPax)



Fig. 1.31 High-speed catamaran of type SWATH ROPAX



Fig. 1.32 Mega cruise ship

available data files. A variation of this method is the use of empirical design formulas deduced through regression fitting of relevant statistical diagrams, or of properly defined design coefficients, with the help of which the sought data, e.g. ship's

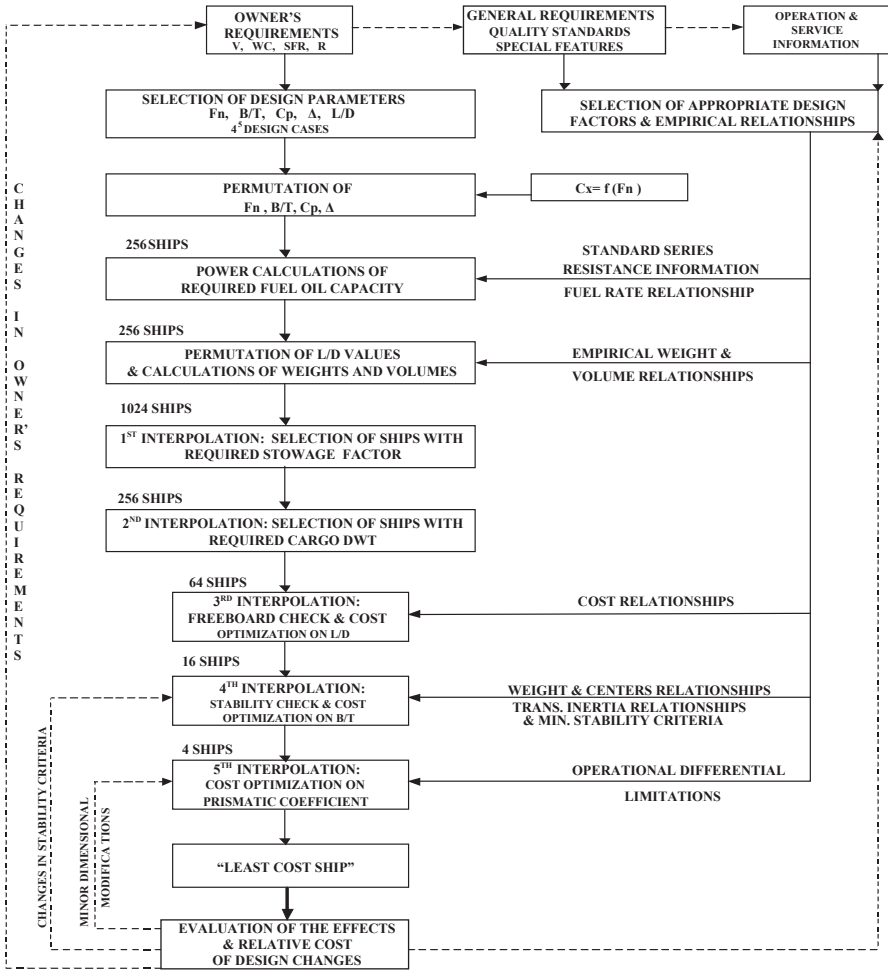

Fig. 1.33 Parametric optimization by permutation of main design parameters for the ‘least-cost’ cargo ship, according to R.D. Murphy et al. (Taggart 1980). Owner’s requirements: V (velocity), WC (weight of cargo), SFR (stowage factor required), R (range), $F_n = V/\sqrt{gL}$: Froude number

main dimensions, weight components and powering are brought into dependence on the initially given or earlier deduced data, e.g. relationship of length on ship’s deadweight or indirectly ship’s displacement. For successful application of the empirical method, it is assumed that the available comparative data or empirical relationships are sufficient and reliable for the type and size of the ship under investigation. Of course, it is additionally assumed that the comparative built ships represent economically competitive and reliable design solutions and that the relationship between the main design parameters and the assessment criteria is quite flat (of small gradient) in the region of interest for the actual design parameters, i.e. a small change in a design parameter does not lead to a significant change of

the assessment criterion (a small change of ship's length does not lead to a drastic change of ship's resistance and powering demand, for constant displacement).

b. Parametric Method When comparative data from similar ships are lacking, e.g. in case of innovative ship types, or when the absolute ship size exceeds common limits, it is necessary to conduct a study from scratch, namely to seek the best combination of main dimensions and main design characteristics for optimizing some selected design criteria. Based on the mathematical optimization model (algorithm and corresponding computer software) of an economic criterion, such as building cost, the required freight rate for 1 ton of transported cargo (RFR: required freight rate¹⁷), or return on investment, the absolutely optimal set of design parameters is identified, minimizing or maximizing a set criterion. It should be noted that modern ship design optimization methods may consider multiobjective optimization procedures, optimizing simultaneously a series of partly contradicting criteria and constraints, thus identifying the so-called Pareto front of best design solution (see Papanikolaou 2010).

The setup of a satisfactory mathematical model, in which the ship's main design parameters are rationally related to the ship's performance (physical and economic characteristics), is a very demanding task and obviously strongly related to the specific conditions of the ship type. The model may be (and often is) supported by systematic experimental data of model series. The identification of the optimal ship design solution is one fundamental task of computer-aided ship design (CASD) and, mathematically, a typical nonlinear multiparametric and multiobjective optimization problem with multiple constraints.

A classical and historic example of systematic parametric optimization for identifying the 'least-cost ship' is given in Fig. 1.33. It refers to the optimization procedure of a cargo ship on the basis of the main requirements of a hypothetical ship owner for speed (V : velocity), payload (W_C : weight of cargo), stowage factor (SF_R : stowage factor required), and range (R : range) according to R.D. Murphy et al. (Taggart 1980). It should be noted that this approach was developed in the early 1960s by use of very limited resources for computer hardware and software available at that time. In addition to the systematic change of various independent parameters ('brute force' approach), which essentially is possible only with the help of computers, the parametric method can be applied in a simplified form with few but essential changes in the basic parameters, provided that the design space of the optimal solutions is known to the researcher.

In practice, Murphy et al.'s methodology has already been replaced nowadays by modern optimization methods, which are supported by strong computer infrastructure; this enables the consideration of many more design parameters, objective functions and constraints. The identification of the optimal solution is achieved with a minimum number of parametric iterations compared to the 'brute force' para-

¹⁷ Definition of RFR=(annual costs+annual depreciation value of the ship)/annual transported amount of cargo. The definition applies strictly for uniform annual cash flow. Ships with smaller RFR are more competitive than others, as they may lead to more profit, in case actual freight rates are higher than RFR or to less loss in case actual freight rates are lower than RFR.

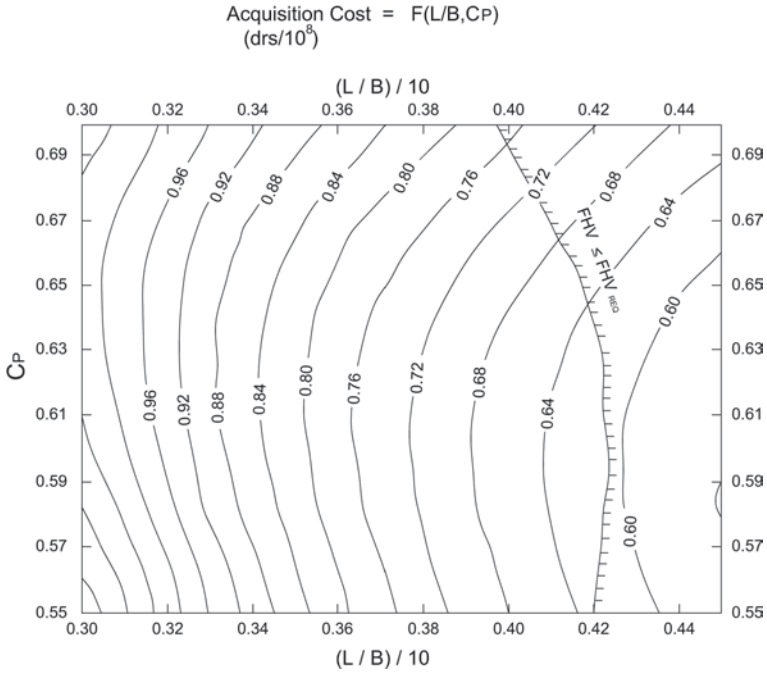

Fig. 1.34 Optimization of medium fishery vessel (stern trawler) with respect to shipbuilding/acquisition cost (Kariambas 1996)

metric optimization used in the initial stages of CASD (mathematical optimization method and nonlinear programming problems, see Papanikolaou and Zaraphonitis 1988; modern ship design optimization with genetic algorithms, see Boulougouris 2003, Papanikolaou (2010); State of the Art review, Nowacki 2010).

One example of mathematical design optimization of a fishing vessel is given in Fig. 1.34, showing the dependence of building cost (represented herein by isolines of 10^8 Greek Drachmas currency units in the early 90s) on the ship's prismatic form coefficient and the length-to-beam ratio; in this example the following owner's specifications are assumed: fish-hold volume= 45 m^3 , service speed 9 knots, range/endurance 13 days; present diagram holds for length= 20 m and B/D ratio= 2.0 .

Finally, in Figs. 1.35, 1.36, 1.37, 1.38, 1.39, 1.40 and 1.41, the process of modern ship design optimization is elaborated, along with an example of multiobjective optimization of the compartmentation and arrangements of a RoPax ship with respect to her structure weight, payload (as expressed by the length of lanes of carried vehicles) and the attained subdivision index A (representing ship's damage stability) by using genetic algorithms; examples are from recent years' research work of the Ship Design Laboratory of NTUA (Boulougouris 2003).

In Fig. 1.42, the ship design problem is formulated as a *decision process* in the frame of system theory, and its optimization is achieved by nonlinear programming methods.

Fig. 1.35 Basic steps of genetic algorithms (Sen and Yang 1998)

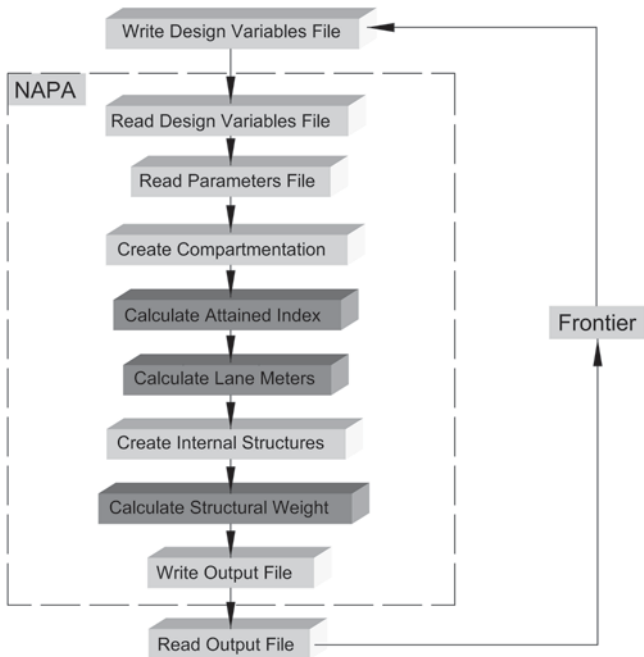
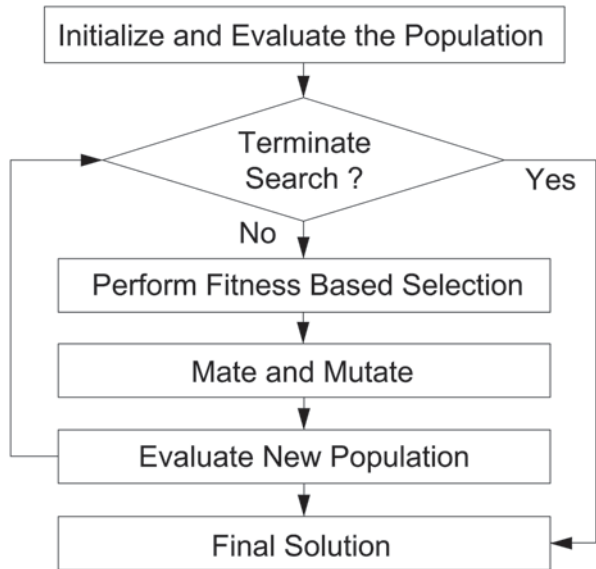

Fig. 1.36 Flowchart of multiobjective ROPAX optimization procedure (Ship Design Laboratory—NTUA; Boulougouris 2003)

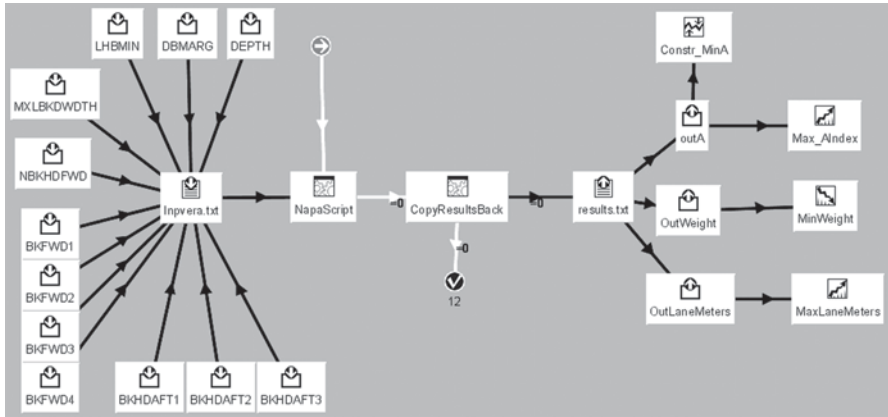

Fig. 1.37 Logistic interface of ship design software Napa[®] and optimization software FRON-TIER[®] (Ship Design Laboratory—NTUA; Boulougouris 2003)

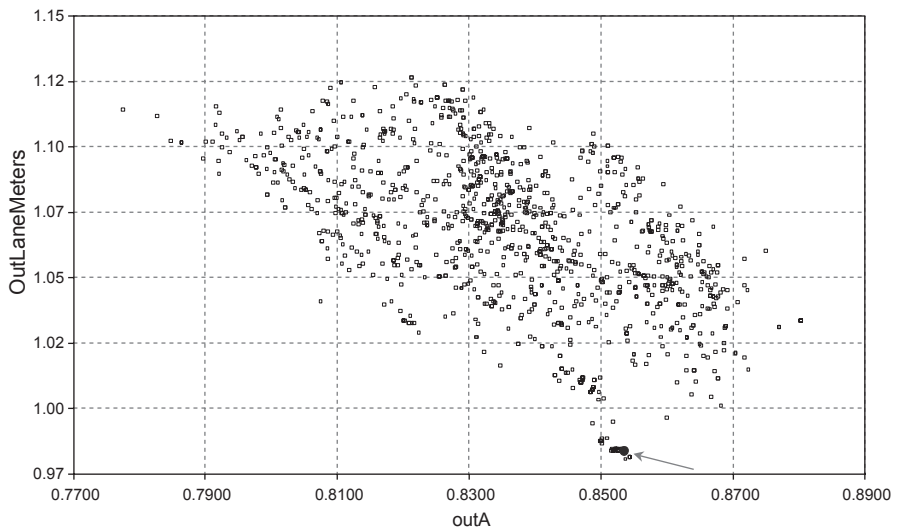

Fig. 1.38 Population of optimal design solutions (and Pareto front) of an RO-RO passenger ship with respect to the attained subdivision index A and the achieved length of vehicle lanes (Ship Design Laboratory—NTUA; Boulougouris 2003)

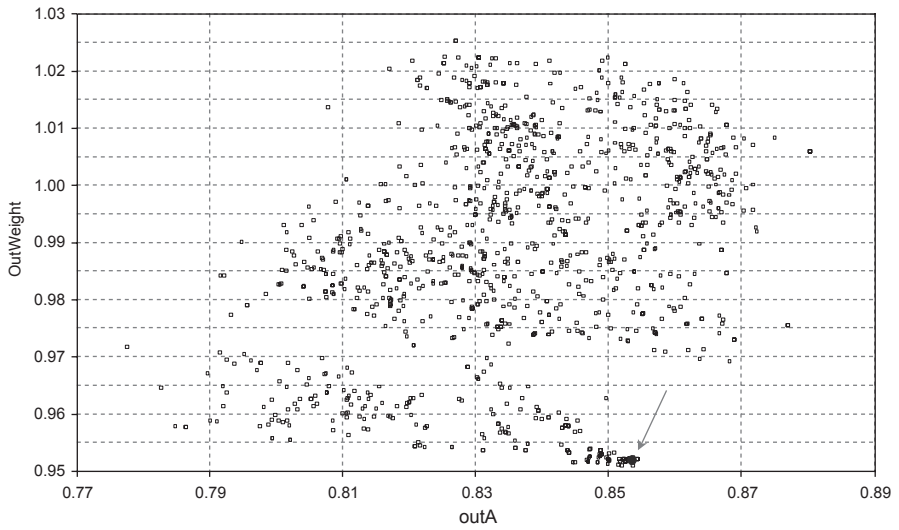

Fig. 1.39 Population of optimal design solutions (and Pareto front) of an RO-RO passenger ship with respect to the attained subdivision index A and a ship’s structural weight (Ship Design Laboratory—NTUA; Boulougouris 2003)

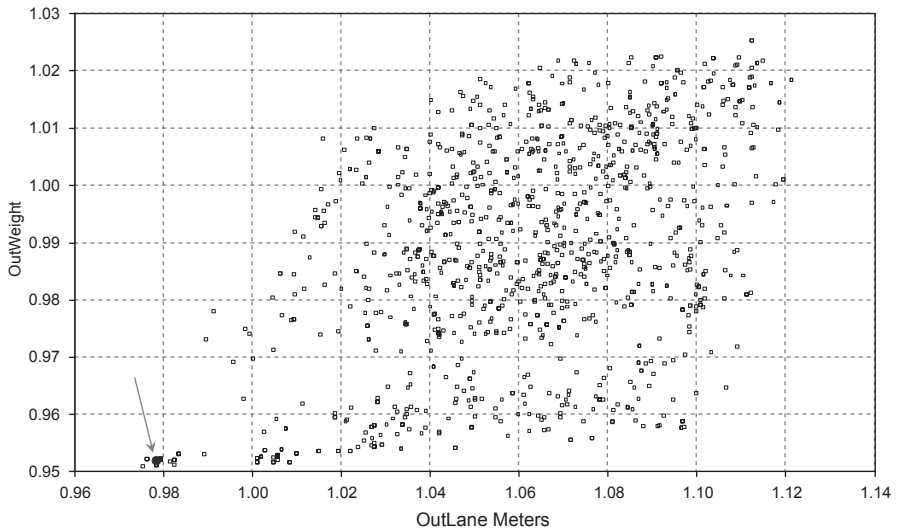

Fig. 1.40 Population of optimal design solutions (and Pareto front) of an RO-RO passenger ship with respect to the achieved length of vehicle lanes versus a ship’s structural weight (Ship Design Laboratory—NTUA; Boulougouris 2003)

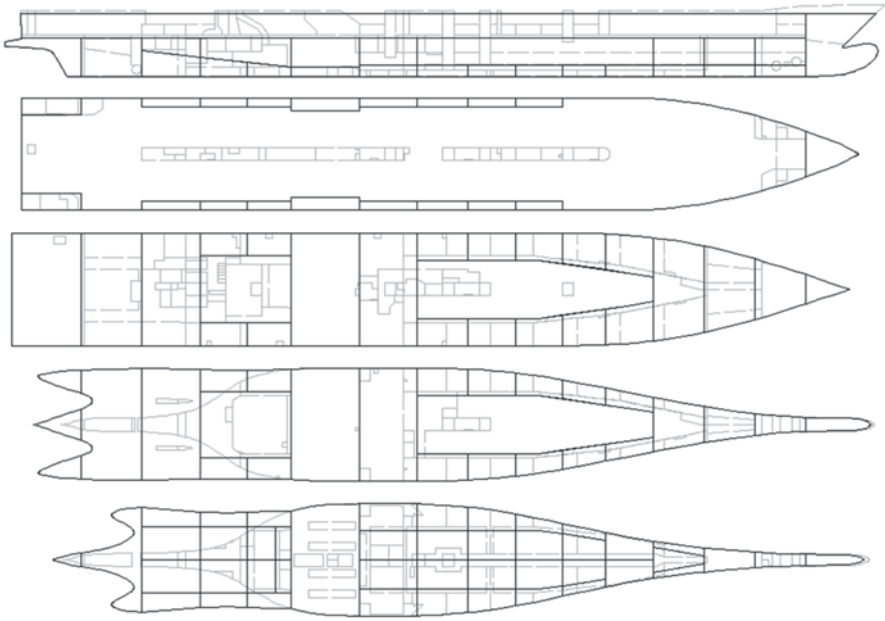
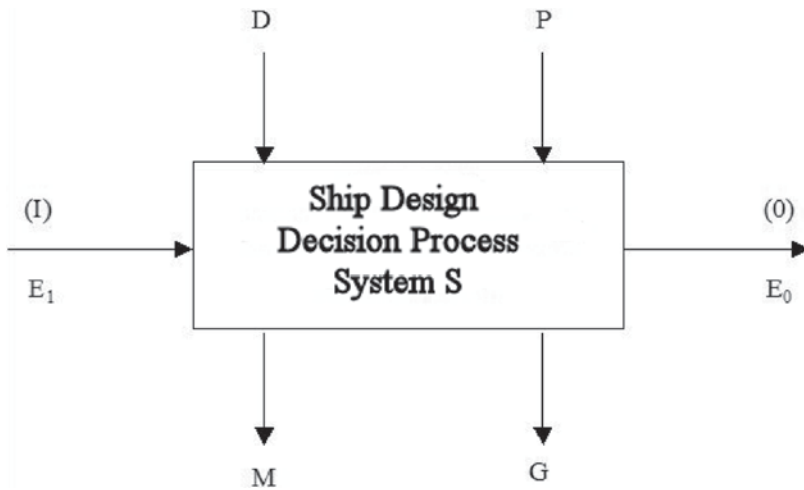

Fig. 1.41 Comparison of compartmentalization of optimal (*dark line*) vs. initial (*grey*) RO-RO passenger ship design (Ship Design Laboratory—NTUA; Boulougouris 2003)

Ship Design = Decision Process



E_i: entrance, (I): input=given data

= main owner's requirements (DWT, speed, range, operational conditions) and other conditions.

E_o: exit, (O): output

= data to be calculated – data under study based on technoeconomical ship characteristics

= technoeconomic optimized solution based on a certain decision criterion

D: decision – design variables

= all the variables that can be altered freely by the designer (independent or/and dependent variables, i.e. ship principal dimensions: length, breadth, draft, dimensions ratios)

P: Restriction – parameters, constraints

= all values that cannot be influenced (controlled) by the designer (decision maker), e.g., physical constraints, limiting dimensions of canals and ports, state of shipping market, weather conditions, etc.

M: Evaluation criteria – merit function = $M(D,P)$

= formulation of one or more assessment criteria in terms of an objective function (or multiple functions), which will be relating to the design and restriction parameters.

G: Constraint functions – constraints = $G(D,P)$

= formulation of constraint functions relating to the design and restriction parameters by linear or nonlinear algebraic equalities and non-equalities, for example, implementation of stability regulations (required minimum GM value), structural rules (requirement for minimum structural moment of inertia amidships), loadline convention (required minimum freeboard), etc.

S: Design of system S (ship) = decision process

= mathematic model relating the input variables and parameters E_i , D, P with the output data E_o , $M(D, P)$ and $G(D, P)$.

Fig. 1.42 System approach to ship design as a decision process

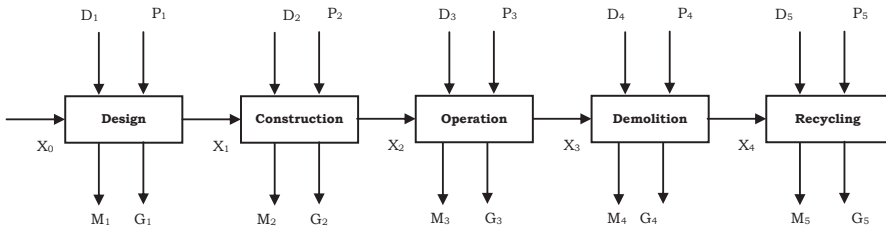

Fig. 1.43 Life-cycle approach to ship design

Actually, in a life-cycle approach to ship design (Fig. 1.43), the entire life of a ship from concept design to construction, operation and up to demolition and recycling needs to be considered and optimized.

1.3.6.4 Comments on Implementation of Design Methods

Regarding the practical application of the preceding basic design methods in practice, we may note the following:

A) Fundamental Principles

a₁. *Theory and practice (theoretical and empirical methods).* Only when considering both approaches we may arrive at good and possibly truly optimal design solutions.

a₂. *Exploitation of data of prototypes.* The use of empirical data from similar built ships greatly reduces the design work effort and serves also as validation of computer generated design data.

B) Selection of Similar Ships (Prototypes, Parents) and Use of Comparative Data

b₁. Typical comparative data for main ship types:

General cargo ships: deadweight, speed, trade type (tramp or liner), main machinery powering (Fig. 1.44).

Tankers and bulk carriers: Deadweight, speed, powering, passing limits through canals and narrow straits (Fig. 1.45).

'Reefer' ships: Deadweight, refrigerated cargo hold volume (net and net net), speed, powering (Fig. 1.46).

Container ships: Deadweight, number of containers (above and below deck, dry and 'reefer' containers, number of TEU and FEU), speed, powering, passing limits through canals (Fig. 1.47).

RO-RO passenger ships (Fig. 1.48): Speed, powering, number of passengers (with and without cabins), number of vehicles (private cars and lorries, lane meters), extent and quality of accommodations, type of service (day and overnight trips).



Fig. 1.44 General cargo ship



Fig. 1.45 Tanker



Fig. 1.46 Reefer ship



Fig. 1.47 Containership



Fig. 1.48 RO-RO passenger ship



Fig. 1.49 MEGA Cruise ship

Cruise ships: Speed, powering, number of passengers, extent and quality of accommodation and public spaces, type of service (day and overnight trips), passing limits through canals (Fig. 1.49).

Tugboats (Fig. 1.50): Operational area (open sea or harbour services), speed and powering, towing power (bollard pull).

Fig. 1.50 Tugboat**Fig. 1.51** Fishing vessel

Fishing vessels (Fig. 1.51): Free-running and fishing (net-towing) speeds, powering of main machinery, towing power, fish-hold volume, extent of accommodations, range, type of fishing vessel and fisheries (trawler, purse seiner, factory mother ship, coastal, oceanic etc.).

When even one of the above characteristics differs substantially from the comparative ship, then the direct use of the empirical data in hand is problematic and requires great caution. There are, however, methods for general cargo ships such as the relational method of Normand (see Appendix C), according to which by using some transfer functions the available comparative data may be still used (if better data are not available), assuming that the differences in main parameters are small (up to a maximum of 10%, exceptionally up to 20%).

b₂. *Use of comparative design data:* Assessment and exploitation of as much as possible comparative data from similar (parent) ships. The *interpolation* between comparative data in hand is in general seamless; however, *extrapolation* on the basis of comparative data may often prove problematic, unless for small exceedance of boundary limits.

b₃. *Use of empirical diagrams:* The ship design bibliography offers a plethora of design diagrams in which typical design data for various types of ships are presented and main ship features (length, beam, draft, side depth, deadweight etc.) are depicted as a function of a typical shipowner's requirements; for example, for cargo ships, main dimensions versus deadweight; for containerships, versus the number of TEU; for fishing vessels, versus the fish-hold volume. These diagrams should be used only in the initial conceptual design stage and should be avoided in later design stages, except as a way of checking/validating the design data obtained (see Appendix A).

C) Use of Design Constants and Coefficients

A basic tool of traditional ship design is the use of various empirical and semiempirical design constants and coefficients that are properly defined constant values, which may vary with vessel size; they account for the impact of the variation of design parameters on certain design properties, such as weight components and engine power. Well-defined design constants and coefficients do characteristically not change significantly, when the underlying design parameters vary. Design constants and coefficients may be dimensional or dimensionless, and care should be taken to consider their exact definition and the method of nondimensionalization, when using them. Especially in case of *dimensional* coefficients, the dimensional units used need to be observed; design coefficients may be used in the initial design stage for early and quick estimations of design characteristics.

Examples

Admiralty constant:

$$C_N = \frac{\Delta^{2/3} V^3}{P} \quad (1.10)$$

where Δ is displacement weight (tons), V is speed (knots, rarely in m/s), and P is engine-horsepower (typically installed horsepower, given in HP or kW); it is a *dimensional* design coefficient allowing the quick estimation of the powering of a ship; that is, the required horsepower may be estimated on the basis of the initially estimated displacement and the specified speed.

Assuming that C_N is known from data of similar ships, it can be used for estimating the required horsepower (for given Δ and V) or the expected speed for the same ship, when changing her loading condition (change of displacement); for example, in the assessment of the speed at design draft, the measurements of speed and corresponding power in trial conditions (at reduced draught) can be used to calculate the constant C_N , and to approximately estimate next the anticipated speed at the design displacement Δ and draft for the available/installed power P .

The constant is due to the British Admiralty and has a long history as a very effective way to quickly estimate speed/powering values for given ship displacement; care should be taken when determining the value of the constant, besides taking care of proper units, to consider data for ships of similar *absolute length* because of the effect of underlying physics and *similitude law* of frictional resistance components (effect of Reynolds number).

Structural weight coefficient:

$$P_{ST} = \frac{W_{ST}}{L \cdot B \cdot D} \quad (1.11)$$

where W_{ST} is ship's structural weight (ton, kp or kN), L is length, B is beam, and D is side depth (all in metre). This is a dimensional coefficient (weight unit/volume unit) that also may be defined as well for other ship components, such as light ship weight and weight of outfitting.

D) Ship Design Equation

The so-called *ship design equation* is deduced from the Archimedean principle, namely, *the weight of the ship is equal to the weight of displaced water*. Methods related to the ship design equation for the initial estimation of ship's main dimensions are based on the analysis of both sides of the equation by expressing them through empirical coefficients and dimensional ratios; through this, an algebraic equation for a main dimension, such as the ship's beam or length is deduced. However, the modelling of the displacement equation for the general case of a ship's design is so complex that the methodology remains essentially impractical in practice, except in the initial design stage (feasibility study see, Sect. 2.13).

E) Computer-Aided Ship Design (CASD)

Beyond the parametric and mathematical ship design optimization, outlined in the preceding Sect. 1.3.6.3, Parametric Method, a number of ship design-specific software tools (or software platforms) are nowadays employed in the various stages of ship design. Typical examples of application of specialized computer software for the computing needs of ship design are listed below:

- Hydrostatic calculations (hydrostatic data sheets and diagrams, parametric stability/Bonjean data/curves, floodable length data/curves, stability booklets, probabilistic damage stability calculations; control of stability criteria in intact and damage conditions etc.)
- Resistance and propulsion calculations (for selection of main machinery and propulsion system)
- Calculations of load line convention (determination of freeboard height, allowable draft)
- Weight component calculation (structural weight, weight of machinery and outfitting)
- Structural strength calculation (analysis of static and dynamic ship strength, control of classification society rules, strength assessment by first principles methods—finite element methods)
- Assessment of seakeeping (calculation of motions and loads in waves)
- Assessment of manoeuvrability
- Assessment of vibrations of ship's structure, machinery and propeller

Other typical software applications in ship design, beyond the pure calculation tasks, include:

- Ship design optimization with respect to various criteria, for example, minimization of ship's resistance or of required freight rate (RFR), minimization of

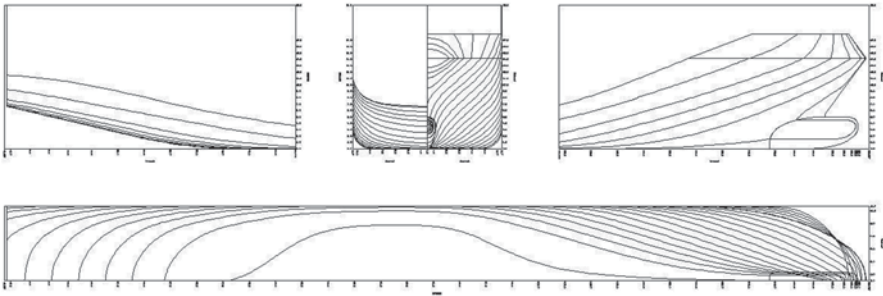

Fig. 1.52 Development of ship hull lines for a RO-RO passenger ship by use of software package NAPA (Ship Design Laboratory, NTUA)

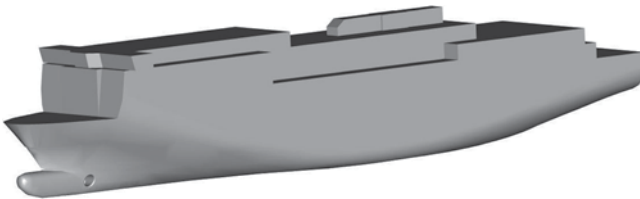

Fig. 1.53 Development of faired 3-D hull surface (skinning) for a RO-RO ship by use of software package NAPA (Ship Design Laboratory, NTUA)

structural weight, maximization of survivability in the case of hull damage as single- or multiple-criteria optimization

- Development of ship hull lines from existing hull form lines by distortion or from systematic model series
- Fairing of ship lines and development of hull surfaces (skinning)
- Development of general arrangement of hull spaces and outfitting (conventional 2-D and 3-D graphic presentation)
- Simulation of a ship's behaviour in waves and of dynamic intact and damage stability by use of software tools (e.g. CAPSIM of NTUA-SDL)
- Simulation of ship evacuation
 - EVI, www.safety-at-sea.co.uk/evi
 - EXODUS, www.fseg.gre.ac.uk/exodus
 - AENEAS, www.gl-group.com/maritime

Contemporary integrated naval architectural software packages (and platforms), which are able to support the designer partly or completely, in various stages of the design of a ship, are listed below (Figs. 1.52, 1.53, 1.54, 1.55 and 1.56):

- NAPA[®], <http://www.napa.fi>

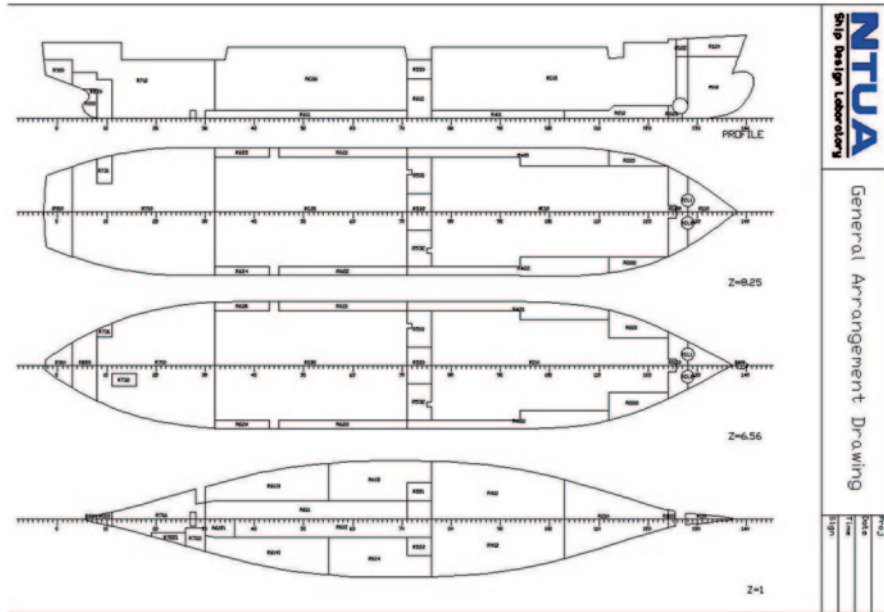

Fig. 1.54 Development of general arrangement of spaces and outfitting (conventional 2-D and 3-D graphic presentation)

- TRIBON/AVEVA®, <http://www.aveva.com>
- FORAN®, <http://www.foransystem.com>
- GHS®, <http://www.ghsport.com>
- AUTOSHIP®, <http://www.autoship.com>
- RHINOS 3D®, <http://www.rhino3D.com>
- MAXSURF®, <http://www.formsys.com/academic/maxsurf>
- DELFTship®, <http://www.delftship.net>
- FRIENDSHIP SYSTEM®, <http://www.friendship-systems.com>

1.3.7 Basic Design Procedures for Main Ship Categories

Following the preparatory steps outlined in the preceding Sect. 1.3.6.1, the designer may proceed to the gradual estimation of the ship’s main characteristics in a well-defined sequential order (according to relevant main ship category) as following:

1.3.7.1 Deadweight Carriers

1. Estimation of displacement Δ on the basis of specified (given) deadweight DWT (see Sect. 2.1 and Table 2.1; or use of regression data from Appendix A)

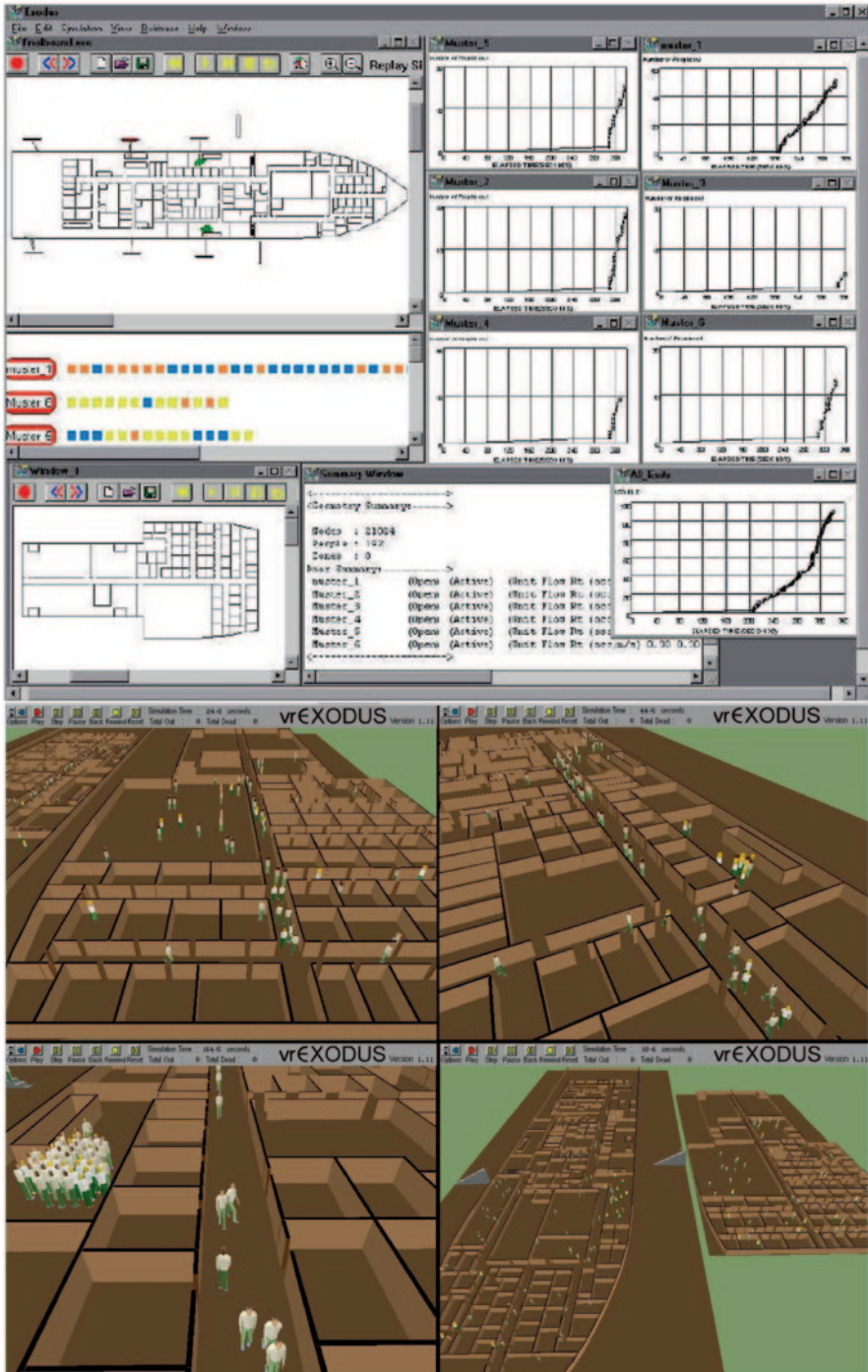

Fig. 1.55 Simulation of ship evacuation by software EVI & EXODUS

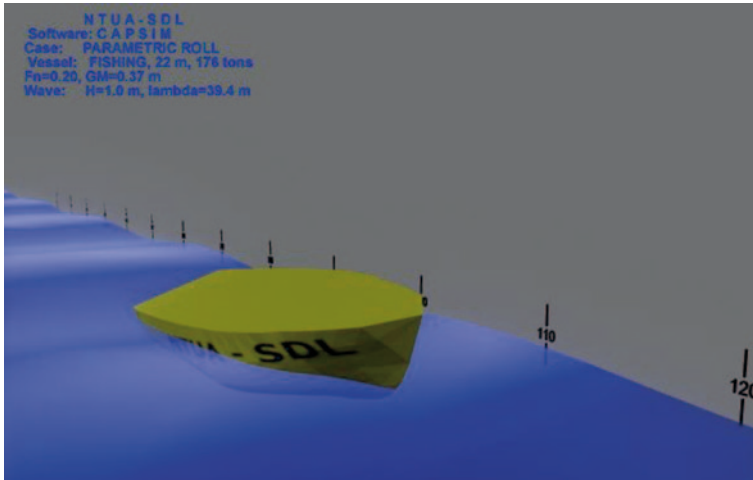

Fig. 1.56 Simulation of dynamic intact and damage stability of ships by use of software CAPSIM (Ship Design Laboratory, NTUA)

Table 1.7 Order of estimation of main dimensions and form coefficients for deadweight carriers

| Sizes and quantities | Basis for calculation |
|--|--|
| 1. Length L | Slenderness coefficient: $L/\nabla^{1/3}$, ∇ : displaced volume (see Sect. 2.3) |
| 2. Block coefficient C_B | Length L , nondimensional Froude number $F_n = V/\sqrt{gL}$ V : given speed, g : gravitational acceleration (see Sect. 2.10) |
| 3. Beam B | Ratios L/B , B/T (see Sects. 2.5 and 2.6) |
| 4. Draft T | Ratios B/T , L/T (see Sects. 2.5 and 2.8) |
| 5. Side depth D | Required hold volume, ratio L/D , (see Sects. 2.5 and 2.7) |
| 6. Other hull form coefficients, midship section coefficient C_M | C_B or through F_n |
| Prismatic coefficient C_p | C_B/C_M or through F_n |
| Waterplane area coefficient C_{WP} | C_B (see Sects. 2.9, 2.10, 2.11 and 2.12) |

2. Estimation of main dimensions and form coefficients in the order outlined in Table 1.7, Steps 1–6, and use of regression data from Appendix A
3. Preliminary estimation of powering (see Sect. 2.14)
4. Development of a *sketch* of ship’s lines and general arrangement (see Chap. 4), preliminary estimation of displaced volume
5. Control of balance between the sum of ship’s weight components and of the weight of displaced water on the basis of the sketched ship lines (balance between geometric displacement and displacement weight)
6. Estimation of cargo hold volume (see Sect. 2.17)
7. Preliminary estimation and control of minimum freeboard (see Sect. 2.19.2)
8. Control of stability and trim (see Sect. 2.18)
9. Preliminary estimation of construction cost (see Chap. 6)
10. Review and summary of results

After the completion of the last step in this procedure for the estimation of the main dimensions and form coefficients, a more detailed reassessment of the pre-estimated quantities is initiated; in particular, the more complex design studies related to Steps 3–8 are conducted in the frame of ship's preliminary design. In the second iteration, the confirmation of the initially estimated absolute values of main dimensions is necessary; they need to fulfil the technical criteria set up in the statement of work by the ship owner and correspond to the extent possible to economically optimal solutions.

In the following, the preliminary main naval architectural plans are developed, namely,

- The ship lines plan
- The general arrangement plan
- The sectional areas and lengthwise volume distribution plan

They enable, among others, the estimation of the available cargo hold volume, the verification of ship's displacement and its lengthwise distribution, ship's hydrostatic properties and arrangements of spaces and main outfitting.

The technical part of the preliminary ship design study is completed by the control of stability and trim of the *intact* ship in main loading conditions (departure, fully loaded at design draft, arrival at port, fuel tanks partly empty, ballast condition etc.), assuming the hull form description and the weight distribution known from previous design steps. This assessment is generally conducted using appropriate software for hydrostatic calculations; the results include, among others, complete details of the ship's geometry (ship lines offsets), the entire hydrostatic data/diagrams and parametric stability (*Bonjean*) curves of the ship, which allow the assessment of the ship's adequacy with respect to floatability, transverse stability and trim, for a given ship's geometry and weight distribution. In addition, ship's *damage* stability needs to be assessed, thus the adequacy of the ship's watertight subdivision with respect to possible flooding due to collision and grounding. This assessment is nowadays accomplished by specialized software tools and is based on the probabilistic damage stability framework of SOLAS 2009,¹⁸ introduced for all-new dry cargo and passenger ships built after January 1, 2009 (see Papanikolaou 2007).

It should be noted that, in older times and until the early 90s the control of a *cargo ship's damage* stability (thus of flooding of spaces due to loss of ship's watertight integrity) was not required for dry cargo ships (but only for passenger ships), except for the B-60 and B-100 type bulk carriers. The latter are allowed to have a reduced freeboard, compared to other cargo ships, assuming compliance with respect to requirements on buoyancy and stability after damage of 'one'- and 'two'-compartment standard ships respectively (according to the International Load Line Convention—ICLL). Non-dry cargo ships are excluded from applying the above requirements. Their stability and floatability are controlled by other regulations, such

¹⁸ The attained subdivision index A (which corresponds to the probability that the ship survives a likely side collision damage) must be greater than the required subdivision index R ($A > R$). R increases with ship's size and is a function of ship's length (dry cargo ships) and additionally of the number of people onboard (passenger ships). The value of R is determined by international safety regulations (SOLAS).

as MARPOL 73/78 for oil tankers and likewise for the liquefied and natural gas carriers (International Bulk Chemical Code and International Gas Carrier Code).

After the completion of the technical part of a ship’s design, a preliminary calculation of the ship’s construction cost is conducted, along with a critical review and concise presentation of the design outcome (Steps 9 and 10).

The preceding studies, if conducted manually without use of integrated design software tools, are traditionally repeated, in a trial-and-error iterative procedure until, after about the third iteration, the ship’s main dimensions converge to their final values; the final dimensions are characterized by their harmonic interrelationship while fulfilling ship’s technical and operational requirements cost efficiently.

In Papanikolaou (2009a, Vol. 2), the reader may find a description of the step by step design procedure for a series of cargo ship types in the frame of the above outlined general design procedure for deadweight carriers.

1.3.7.2 Volume Carriers

Compared to the deadweight carriers, the procedure for the volume carriers commences with an estimation of the *required cargo hold volume* below the main deck (instead of displacement) on the basis of the required overall hold capacity. The step by step procedure is as follows:

1. Estimation of the required cargo hold volume below the main deck on the basis of the overall hold capacity specified by the shipowner.
2. Estimation of the main dimensions and form coefficients in the sequence order outlined in Table 1.8. The subsequent procedure is the same as that for deadweight carriers, i.e. Steps 3—10 in Sect. 1.3.7.1.

Table 1.8 Order of estimation of main dimensions and form coefficients for volume carriers

| Sizes and quantities | Basis for calculation |
|--|---|
| 1. Length L | Hold capacity BALE V_{BALE} ^a (cargo ship) hold capacity NET V_{NET} ^b TEU number n_{TEU} ^c (container ships) |
| 2. Block coefficient C_B | L, F_n |
| 3. Beam B | Ratio L/B , or on the basis of the above data for estimation of L |
| 4. Side depth D | Ratio B/D , or on the basis of the above data for estimation of L , or coefficients (hold capacity/ $L \cdot B \cdot D$) |
| 5. Light ship weight W_L | Coefficient $W_L/L \cdot B \cdot D$; from tables or data of similar ships, as function of block coefficient C_B |
| 6. Deadweight DWT | Weight of cargo, fuel, supplies etc |
| 7. Displacement Δ | $W_L + DWT$ |
| 8. Draft T | Δ, L, B, C_B |
| 9. Other hull form coefficients namely: C_M, C_p, C_{WP} | C_B, F_n |

^a Hold capacity BALE=required volume for bale cargo

^b Hold capacity NET=required net volume for refrigerated cargo

^c Number of standard containers TEU (8 × 8 × 20 ft) below deck (considering, however, also the number of above-deck containers)

In the frame of the assessment of the damage stability of passenger ships and ROPAX ships, which are typical volume carriers, the determination of the position of the watertight bulkheads as well as of their freeboard, is accomplished through compliance with relevant in-force damage stability regulations, as applicable to passenger ships in the region of ship operation; these are first the SOLAS 90 (SOLAS, Ch. II-1, Reg. 8) deterministic requirements; for ships sailing in territorial waters of the EU the compliance with the requirements of the so-called Stockholm Agreement (on top of SOLAS 90, accounting for ‘water on car deck’ effects) is required in addition. Relevant assessments of compliance with the above requirements must be done at an *as-early-as-possible stage* (already in the feasibility study) to avoid likely insurmountable problems in the design in subsequent stages.¹⁹

Some special provisions need also be taken into account in the design of RO-RO passenger ships and RO-RO ships in general: The required volume for the accommodation of passengers, of crew and of public spaces, of machinery room, and cargo hold spaces (for RO-RO: space for carried vehicles), can be estimated by use of the required area

- Per passenger; in dependence on accommodation quality
- Per vehicle; commonly expressed in length in metre of vehicle lanes of private cars and/or trucks

The allocation of spaces below and above the main deck, particularly in terms of volume and extent of the superstructures of passenger ships, is determined by the fundamental requirements resulting from the criterion of sufficient stability, particularly satisfaction of *intact stability criteria*, according to Regulation A.167; they greatly depend on lateral/shaded profile of the ship, which in turn affects the magnitude of forces/moments due to side waves and winds. The ship’s intact stability is significantly influenced by the B/D ratio and height and extent of the superstructures; an early intact stability assessment can be made on the basis of information from similar vessels, as long as the extent of the superstructures is comparable (Fig. 1.57).

1.3.7.3 Linear-Dimension Ships

With at least one main dimension being fixed in terms of maximum permissible values, for example, the beam B from the passing limits of canals or by the dimensions of box-type cargo (containers), the preliminary design procedure for linear dimension ships does not differ from the ones outlined before for deadweight and volume carriers. However, attention should be paid when using comparative data for similar ships, because of the discontinuous change of main dimensions (e.g. by adding a

¹⁹ In addition to the requirements of SOLAS90/Stockholm Agreement, the assessment of the damage stability of all passenger and ROPAX ships (built after January 1, 2009) needs to be also conducted by use of the harmonized probabilistic procedure of SOLAS (2009) (like for the dry cargo ships, IMO 2013b).

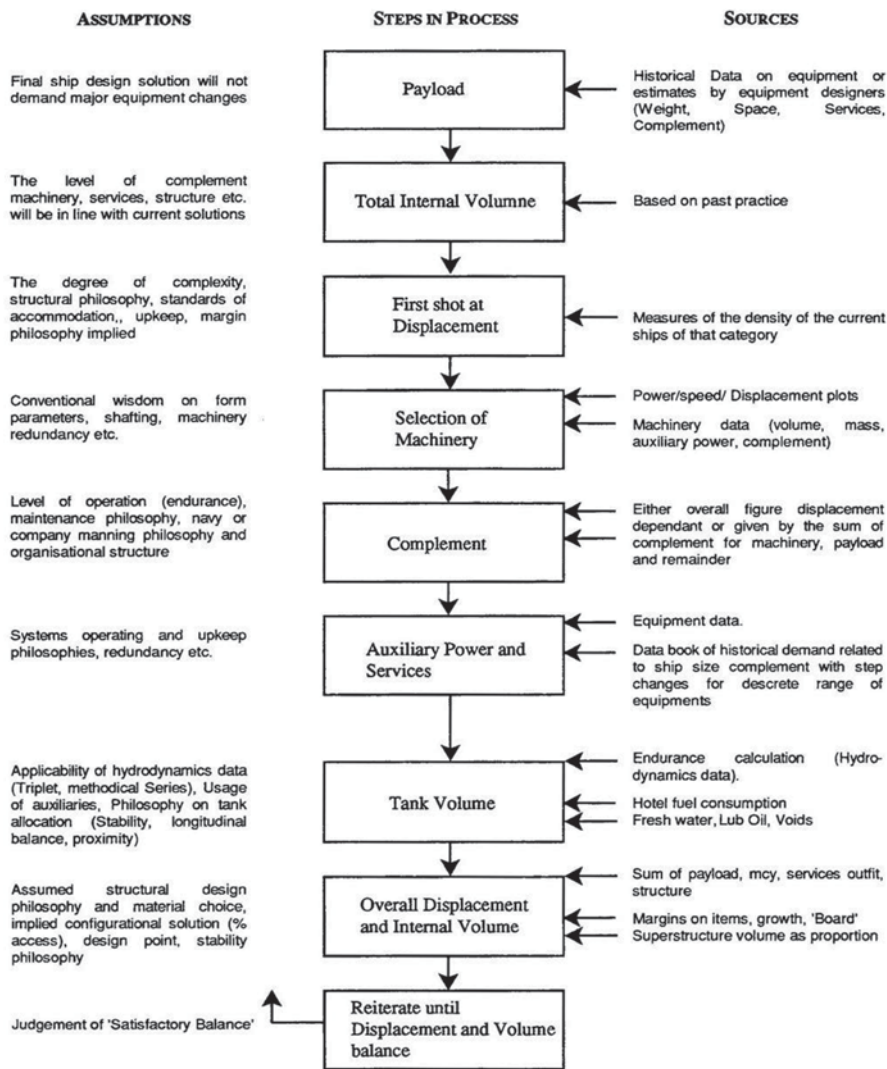

Fig. 1.57 Iterative preliminary design procedure for volume carriers (Sen and Birmingham 1997)

row of containers or an additional lane of vehicles across for containerships respectively Ro-Ro ships) and the impact of the constraint dimension on the other ship characteristics; typical examples herein are the third-generation PANAMAX containerships (about 3,700 TEU), with their beam limited (Fig. 1.58) to 32.20 m, whereas their length reaches values of 245 m (excessive/nonoptimal length to beam ratio $L/B=7.61$).



Fig. 1.58 Two third-generation PANAMAX containerships passing the canal

1.3.7.4 Special-Purpose Ships

The individual character of ships in this category does not permit generalized design methods. However, we should note that if an initial estimation of a ship's displacement (e.g. for tug boats, through towing power; for icebreakers, through installed horsepower) or the required hold volume (e.g. for fishing vessels, through the refrigerated fish hold volume) is possible, then the procedure will be similar to those given for deadweight and volume carriers.

It is noted that some examples of the preliminary design procedure of developing the basic types of merchant ships are described in Papanikolaou (2009a, Vol. 2), and comprehensive data for the design of ships of various types can be found in Lamb (2003).

References

- Akagi S (1991) Synthetic aspects of transport economy and transport vehicle performance with reference to high speed marine vehicles. Proceeding 1st International Conference on Fast Sea Transportation - FAST 91, Trondheim
- Akagi S, Morishita M (2001) Transport economy—based evaluation and assessment of the use of fast ships in passenger—car ferry and freighter systems. In: Proceeding 6th International Conference on Fast Sea Transportation - FAST 2001, London
- Andrews D (coordinator), Papanikolaou A, Erichsen S, Vasudevan S (2009) IMDC2009 State of the art report on design methodology. In: Proceedings 10th International Marine Design Con-

- ference, IMDC09, Department of Marine Technology, Norwegian University of Science and Technology, Trondheim, 26th–29th May 2009, ISBN 978-82-519-2438–2
- Boulougouris E (2003) Optimisation of design of ro-ro passenger and naval ships for enhanced safety after damage. PhD Dissertation, National Technical University of Athens
- Boulougouris E, Papanikolaou A (2009) Energy efficiency parametric design tool in the frame of holistic ship design optimization. In: Proceedings of 10th International Marine Design Conference, IMDC09, Trondheim, May 2009
- Brett PO, Boulougouris E, Horgen R, Konovessis D, Oestvik I, Mermiris G, Papanikolaou A, Vassalos D (2006) A methodology for logistics-based ship design. In: Parsons MG (eds) Proceedings of 9th International Marine Design Conference (IMDC), Michigan, USA: The Department of Naval Architecture and Marine Engineering, University of Michigan, May 2006, pp 123–146
- Buhaug Ø, Corbett JJ, Endresen Ø, Eyring V, Faber J, Hanayama S, Lee DS, Lee D, Lindstad H, Mjelde A, Palsson C, Wanqing W, Winebrake JJ, Yoshida K (2008) Updated study on greenhouse gas emissions from ships: phase I. International Maritime Organization (IMO) report, London, UK, 1st September 2008
- Eliopoulou E, Papanikolaou A (2007) Casualty analysis of large tankers. *J Mar Sci Technol* 12:240–250 (Springer)
- Gabrielli G, von Kármán Th (1950) What price speed? Specific power required for propulsion of vehicles. *Mech Eng* 72(10):775–781
- IHS Fairplay World Shipping Encyclopedia version 12.01 (2011) <http://www.ihs.com/products/maritime-information/ships/world-shipping-encyclopedia.aspx>
- International Maritime Organization, IMO (2013a), MARPOL 73/78, Consolidated Edition 2013
- International Maritime Organization, IMO (2013b) SOLAS, Consolidated Edition, 2013, Consolidated text of the International Convention for the Safety of Life at Sea, 1974, and its Protocol of 1988: articles, annexes and certificates
- Kariambas H (1996) Computer-aided merchant ship design methodology for the Greek shipyards. PhD Dissertation, National Technical University of Athens
- Kennell C (1998) Design trends in high-speed transport. *J Mar Technol* 35(3):127–134 (SNAME)
- Lamb T (2003) Ship design and construction. In: D'Arcangelo AM (ed) Revision of the book: (1969) Ship design and construction. SNAME, New York
- Levander K (2003) Innovative ship design—can innovative ships be designed in a methodological way. In Proceedings of 8th International Marine Design Conference—IMDC03, Athens, May 2003
- Nowacki H, Ferreiro LD (2003) Historical roots of the theory of hydrostatic stability of ships. In Proceedings of 8th International Conference on the Stability of Ships and Ocean Vehicles—STAB2003, Madrid
- Nowacki H (2010) Five decades of Computer-Aided Ship Design, *Journal Computer-Aided Design* 42 956–969
- Papanikolaou A (2002) Developments and potential of advanced marine vehicles concepts. *Bulletin of the KANSAI Society of Naval Architects*, No. 55, pp 50–54
- Papanikolaou A (2005) Review of advanced marine vehicles concepts. In Proceedings of 7th International High Speed Marine Vehicles Conference (HSMV05), Naples, September 2005
- Papanikolaou A (2007) Review of damage stability of ships—recent developments and trends. In Proceeding PRADS 2007, Houston, October 2007
- Papanikolaou A (2009a) Ship design—methodologies of preliminary ship design (in Greek: Μελέτη Πλοίου - Μεθοδολογίες Προμελέτης Πλοίου), SYMEON Publisher, Athens, Vol 1, ISBN 978-960-9600-09-01 & Vol. 2, ISBN 978-969-9400-11-4, October 2009
- Papanikolaou A (ed) (2009b) Risk-based ship design, methods, tools and applications, Springer publ., Berlin-Heidelberg, ISBN 978-3-540-89042–3
- Papanikolaou A (2010) Holistic ship design optimization. *Comput-Aided Des* 42(11):1028–1044
- Papanikolaou A, Zaraphonitis G (1988) Computer applications in ship design. Hellenic Technical Chamber Athens

- Papanikolaou et al (2009c) Assessment of safety of crude oil transport by tankers. In Proceedings Annual Meeting of the German Society of Naval Architects—STG, Berlin
- Papanikolaou A (coordinator), Andersen P, Kristensen H-O, Levander K, Riska K, Singer D, Vas-salos D (2009d) State of the art on design for X. In Proceedings 10th International Marine Design Conference, IMDC09, Department of Marine Technology, Norwegian University of Science and Technology, Trondheim, 26th–29th May 2009, ISBN 978-82-519-2438-2
- Schneekluth H (1985) Ship design (in German). Koehler, Herford
- Sen P, Birmingham R (eds) (1997) Proceedings of the 6th International Marine Design Conference IMDC 1997, University of Newcastle UK, 23–25 June 1997
- Sen P, Yang JB (1998) Multiple criteria decision support in engineering design. Springer, London
- SOLAS (2009) International Maritime Organization, IMO, SOLAS, Consolidated Edition, 2009, ISBN: 978-92-801-1505-5
- Solomon S, Qin D, Manning M, Chen Z, Marquis M, Averyt KB, Tignor M, Miller HL (eds) (2007) IPCC Summary for policymakers. In Climate change 2007: the physical science basis. Contribution of working group I to the fourth assessment report of the Intergovernmental Panel on Climate Change. Cambridge University Press, Cambridge
- Taggart R (ed) (1980) Ship design and construction. SNAME Publications, New York

Chapter 2

Selection of Main Dimensions and Calculation of Basic Ship Design Values

Abstract This chapter deals with the determination of the main ship dimensions (length, beam, draft, side depth), following the estimation of the ship's displacement and the selection of other basic ship design quantities and hull form characteristics (hull form coefficients, powering, weight components, stability and trim, free-board, load line), as required in the first phase of ship design, that is, the *Concept Design*. The various effects of specific selections of ship's main dimensions etc. on the ship's hydrodynamic performance, stability and trim, structural weight and construction cost, utilization of spaces, and transport economy are elaborated. The selection procedure is supported by statistical data and empirical design formulas, design tables and diagrams allowing direct applications to individual ship designs. Additional reference material is given in Appendix A.

2.1 Preliminary Estimation of Displacement

For deadweight carriers (Sect. 1.3.7.1), which are characterized by the carriage of relatively heavy cargos (low cargo Stowage Factor (SF) and low Ship Capacity Factor), but also for every category/type of ship with sufficient comparative data from similar ships on vessel's displacement, the preliminary design starts with the estimation of ship's displacement weight Δ .

For deadweight carriers, it is possible to estimate Δ for a given deadweight DWT, for instance, as the DWT is one of shipowner's main requirements.

Typical ways of estimating Δ are the following:

- a. Using DWT/ Δ ratios for various types of ships (see Table 2.1);
- b. Using semiempirical mathematical formulae from statistics, regression analyses of data of similar vessels (see, for example analysis of technical database for various types of ships, such as the database of IHS Fairplay (IHS WSE 2011, former Lloyds Register of Shipping), and data from regression analyses studies of

Table 2.1 Typical sizes and percentages of weight groups for main merchant ship types (compilation of data from Strobusch (1971), Schneekluth (1985), updated by Papanikolaou using IHS Fairplay World Shipping Encyclopedia, v. 12.01, 2011)

| Ship type | Limits | | 3 DWT/ Δ (%) | 4 W_{ST}/W_L (%) | 5 W_{OT}/W_L (%) | 6 W_M/W_L (%) |
|--|-----------------------|------------------------------|---------------------------|--------------------------|--------------------------|-----------------------|
| | 1 Lower | 2 Upper | | | | |
| General cargo ships (t DWT) | 5,000 | 15,000 | 65–80 | 55–64 | 19–33 | 11–22 |
| Coasters, cargo ships (GRT) | 499 | 999 | 70–75 | 57–62 | 30–33 | 9–12 |
| Bulk carriers ^a (t DWT) | 20,000 | 50,000 | 74–85 | 68–79 | 10–17 | 12–16 |
| | 50,000 | 200,000 | 80–87 | 78–85 | 6–13 | 8–14 |
| Tankers ^b (t DWT) | 25,000 | 120,000 | 78–86 | 73–83 | 5–12 | 11–16 |
| | 200,000 | 500,000 | 83–88 | 75–88 | 9–13 | 9–16 |
| Containerships (t DWT) | 10,000 | 15,000 | 65–74 | 58–71 | 15–20 | 9–22 |
| | 15,000 | 165,000 ^c | 65–76 | 62–72 | 14–20 | 15–18 |
| Ro-Ro (cargo) (t DWT) | $L \cong 80$ m | 16,000 t DWT | 50–60 | 68–78 | 12–19 | 10–20 |
| Reefers ^d (ft ³) of net ref. vol. | 300,000 | 500,000 | 45–55 | 51–62 | 21–28 | 15–26 |
| Passenger Ro-Ro/ferries/ RoPax | $L \cong 85$ m | $L \cong 120$ m | 16–33 | 56–66 | 23–28 | 11–18 |
| Large passenger ships (cruise ships) | $L \cong 200$ m | $L \cong 360$ ^e m | 23–34 | 52–56 | 30–34 | 15–20 |
| Small passenger ships | $L \cong 50$ m | $L \cong 120$ m | 15–25 | 50–52 | 28–31 | 20–29 |
| Stern Trawlers | $L \cong 44$ m | $L \cong 82$ m | 30–58 | 42–46 | 36–40 | 15–20 |
| Tugboats | $P_B \cong 500$ KW | 3,000 KW | 20–40 | 42–56 | 17–21 | 38–43 |
| River ships (towed) | $L \cong 32$ m | $L \cong 35$ m | 22–27 | 58–63 | 19–23 | 16–21 |
| River ships (self-propelled) | $L \cong 80$ m | $L \cong 110$ m | 78–79 | 69–75 | 11–13 | 13–19 |

W_L light ship weight, W_{ST} weight of steel structure, W_{OT} weight of outfitting, W_M weight of machinery installation

^a Bulk carriers without own cargo handling equipment

^b Crude oil tankers

^c Triple E class of containerships of Maersk, DWT=165,000 t, first launched 2013

^d Banana reefers

^e Oasis class cruise ship of Royal Caribbean Int., $L=360$ m, 225,282 GT, launched 2009

the Ship Design Laboratory of NTUA (<http://www.naval.ntua.gr/sdl>). Illustrative examples of regressive analysis of basic characteristics for various types of ships are shown in Appendix A;

- c. Using specific diagrams, for example (DWT/ Δ) versus (DWT) and/or (speed) for various types of ships (see Figs. 2.1, 2.2, 2.3, and Appendix A).

It should be noted that for the volume carriers (Sect. 1.3.7.2), which are distinguished by their small DWT/ Δ ratios, it is not appropriate to first estimate Δ with the above methods, nor at this initial stage, except for the cases for which there are robust comparative data from similar ships. In addition, further factors that also affect displacement, other than DWT, that is, type and required power of machinery system, the complexity of steel structure and the extent of outfitting, should be

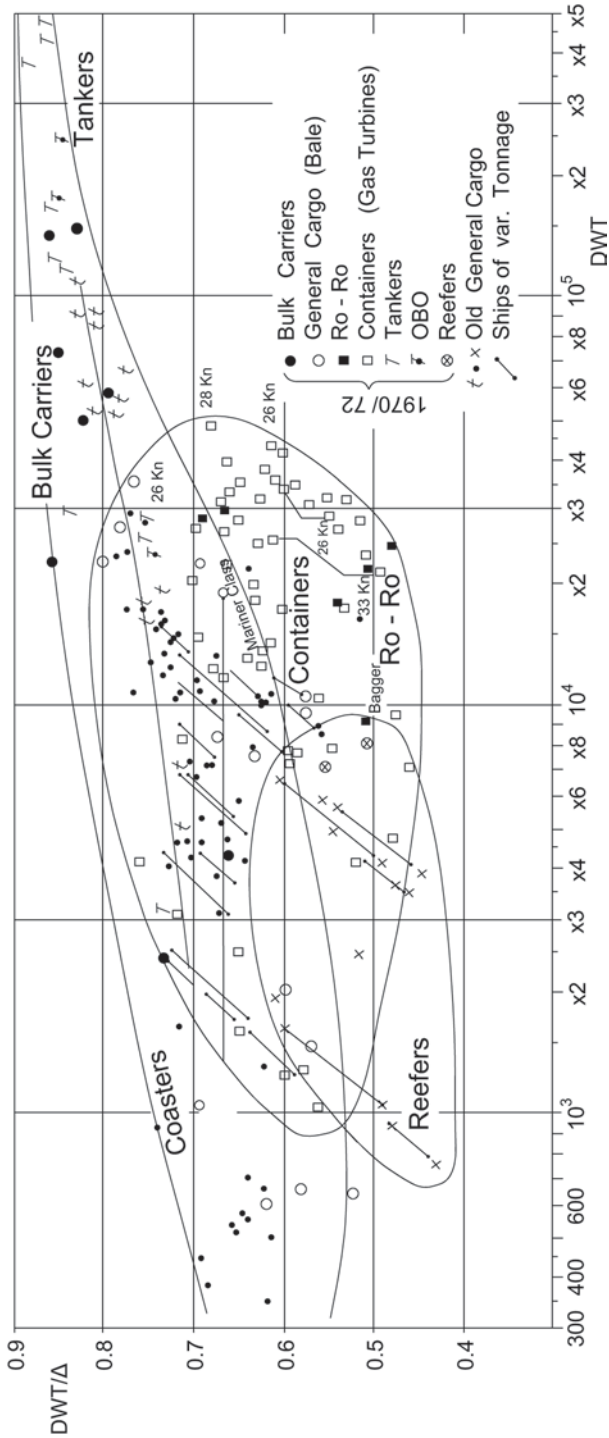

Fig. 2.1 (DWT/Δ) ratios versus DWT for cargo ships by Völker (1974)

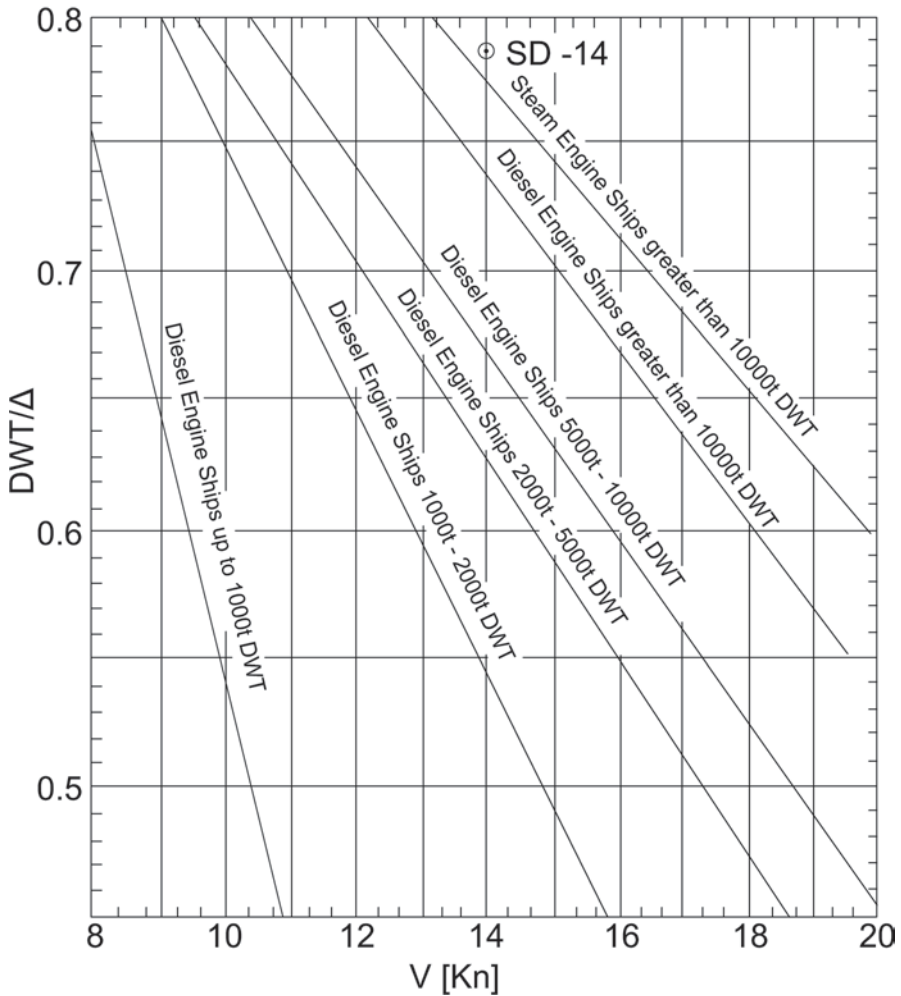

Fig. 2.2 Qualitative trend values of (DWT/Δ) ratios versus DWT and speed V for diesel engine ships by Schünemann (Henschke 1964)

checked with respect to possible deviation from typical/normal characteristics of comparative ships.

As described later on, it is possible to more accurately calculate the displacement by analysis of the various weight components that constitute the displacement weight Δ ; however, this requires additional information from similar ships. E. Danckwardt's approximate method, though relying on past years' design practice, proved useful in related estimations of general cargo ships (see Papanikolaou 2009a).

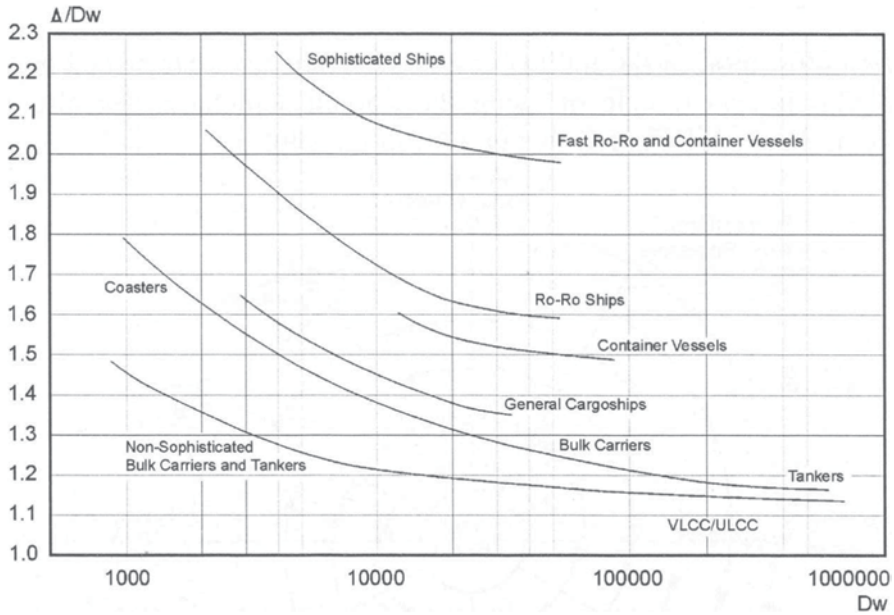

Fig. 2.3 (Δ/DWT) ratios versus DWT for various ship types, Harvald (1986) (see Friis et al. 2002)

2.2 Selection of the Main Dimensions and Form Coefficients

The procedure of determining the main dimensions, that is length L , beam B , draft T , side depth D , and hull form coefficients (initially the block coefficient C_B and then the other coefficients C_p , C_M and C_{wp}) should be conducted considering the following basic factors:

1. Ship's hydrodynamic performance (resistance and propulsion, seakeeping, maneuverability)
2. Satisfactory stability
3. Sufficient volume of cargo holds
4. Adequate structural strength
5. Construction cost

The common sequence of determining the main dimensions, form coefficients, and other basic sizes has been briefly described in Sect. 1.3.7. In this section we present first the general principles governing the selection of the main dimensions and secondly various useful semiempirical formulas, which are analyzed from both the phenomenological and scientific point of view; they express relationships of ship's main dimensions and ship's fundamental properties.

The main objective in the determination of the main dimensions is to fulfill the set shipowner's requirements, which mainly concern the following:

- a. Transport capacity (DWT, payload, and cargo hold volume)
- b. Service speed and endurance range
- c. IMO and national safety regulations (SOLAS-IMO 2013b, MARPOL-IMO 2013a, ICLL 1988, etc.) and construction standards of a recognized classification society.

The fulfillment of the aforementioned requirements should be associated with the best possible economic (optimal) solution, in terms of the minimum cost for ship's construction and operation, or even with respect to more complex economic criteria, like required freight rate (RFR), net present value (NPV), and return on investment (ROI).

The selection of the main dimensions, that is, of length L , beam B , draft T , side depth D , and essentially of the freeboard $F_b (=D-T)$, as well as of the block coefficient C_B , determines to which extent the under-design ship will satisfy the aforementioned owner's requirements. Typically, improper selections and combinations thereof for the basic dimensions are almost impossible to be corrected retrospectively; they generally lead to uneconomic and/or technically insufficient solutions.

The procedure of selecting the main dimensions and characteristic sizes is based on an iterative approach with appropriate sequence, for example, estimation of displacement, selection of length, determination of C_B , determination of the beam, draft and side depth. This order applies to deadweight carriers and should be adjusted accordingly for volume carriers (see Sects. 1.3.7.1 and 1.3.7.2).

The basic factors on determining the main sizes are summarized in the following:

1. **Length L :** This is a function of displacement and speed. It has a significant influence on the weight of steel structure and accommodation/outfitting, hence on the construction cost. Also, it strongly affects both the ship's calm water resistance and seakeeping performance (motions, accelerations, dynamic loads, added resistance, and speed loss in seaways).
2. **Block coefficient C_B :** This is a function of the Froude number and is influenced by the same factors as for the length L .
3. **Beam B , Draft T , side depth D :** The determination of these dimensions is actually coupled and is affected by the following basic factors:
 - hold volume (D)
 - stability (B)
 - required freeboard (D, T)
 - safety against flooding and capsize (B, D, T)
 - propulsive and manoeuvring devices (T)

The main dimensions L , B , and T are often affected as well by the topological *limits of the route*, that is, the dimensions of canals, ports, channels, and confined waters that the under-design ship needs to pass through. Mostly the restrictions are referring to allowable drafts.

Some typical dimensions of well-known canals and channels (maximum allowable ship dimensions) are:

| | |
|--|---|
| Panama Canal | $L < 289.56$ m (in general for merchant ships) $L < 299.13$ m (passenger ships and container ships up to 5,000 TEU) $B < 32.31$ m (exceptionally 32.61 m, if $T < 11.28$ m) $T < 12.04$ m (as the maximum allowable draft for tropical fresh water TFW, as applicable) |
| Suez Canal | L : no limit $B < 71.02$ m (233 ft) $T < 10.67$ m (concerning stern draft in ballast condition) $T < 12.80$ m (maximum allowable draft for $B < 47.55$ m, concerning fully loaded voyages southbound) $T < 16.15$ m (maximum allowable draft for $B < 42.67$ m, concerning fully loaded voyages northbound) |
| Canal St. Lorenz (North America—Canada Great Lakes) | $L < 222$ m $B < 23$ m $T < 7.6$ m |
| Northeast Sea Channel (Nord-Ostseekanal—Northern Europe) | $L < 315$ m $B < 40$ m $T < 9.5$ m |
| Malacca Straits (between Malaysia Peninsular and Sumatra island) | $T < 25$ m |

New Panamax maximum passing dimensions (expected, as of 2014): length: 366 m, width: 49 m, draft: 15.2 m, capacity of containers: 12,000 TEU

Finally, in rare cases, the ship length may be constrained by the length of slipways or docks of selected shipyards, with which the shipowner has long-term collaboration in new buildings and/or maintenance of his fleet.

For shaping the ship's hull form, both below the waterline and above, it is required to determine a series of other naval architectural characteristics that are either numerically identifiable sizes or typical qualitative features. It should be noted, however, that the shaping of the hull form cannot be reduced to the determination of certain individual characteristic numerals, but includes quantitative and qualitative interactions among them.

The main numerical values/quantities that describe the hull form of a ship (symbols and definitions according to ITTC (International Towing Tank Conference 2008) are:

- a.1 The block coefficient, C_B
- a.2 The midship section coefficient, C_M
- a.3 The prismatic coefficient, C_p
- a.4 The waterplane area coefficient, C_{WP}

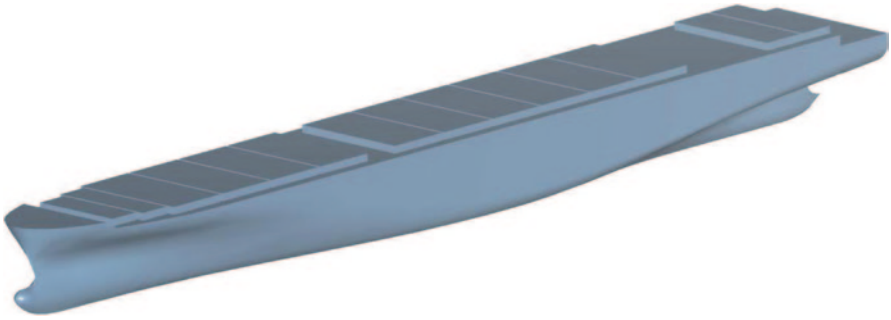

Fig. 2.4 Three-dimensional hull of a container ship designed with software TRIBON® at Ship Design Laboratory of NTUA

- a.5 The slenderness ratio ($L/\nabla^{1/3}$) or the volumetric coefficient (∇/L^3)
- a.6 The longitudinal center of buoyancy, \overline{AB}
- a.7 The vertical position of center of buoyancy above baseline, \overline{KB}
- a.8 The parallel body length, L_p
- a.9 The length of entrance/run of sectional areas, L_E/L_R

The above sizes will be discussed in subsequent paragraphs.

The qualitative characteristics, which supplement the determination of the hull form of a ship, are:

- b.1 Sections' character below waterline
- b.2 Sections' character above waterline
- b.3 Shaping of bow section (bow type, profiles of waterlines and sections in bow region, bulbous bow)
- b.4 Shaping of stern section (stern type, profile of waterlines and sections in stern region, stern bulb, flow to propeller and rudder)
- b.5 Freeboard and sheer deck

These features will also be discussed in subsequent paragraphs (Fig. 2.4).

2.3 Selection of Length

Satisfaction of the owner's main requirements (with respect to transportation capacity, service speed, endurance/range, and safety regulations) is possible with different choices of ship length. However, it is logical to look ultimately for the optimal length with respect to some economic criteria determined by the interests of the yard and/or the owner. In the first case, the employed economic criterion is the "minimum construction/building cost", whereas in the second case, ship's economy is generally evaluated by the "minimum required freight rate (RFR) per ton of cargo" criterion.

Two examples of optimization of the ship length with respect to the "minimum construction cost" and alternatively the "maximum return on investment" are given

in Papanikolaou (2009a, Vol. 2). From the available data, it is concluded that for fixed/given hold volume and displacement, increasing the length generally leads to an increase of the ship's structural weight and to a reduction of the ship's required propulsion power for achieving the specified speed.

As to the effect of a length increase on the other ship weight components (for fixed displacement), it also increases the accommodation/outfitting weight, what generally leads to a reduction of the ship's payload. The resulting reduction of propulsion power and the corresponding reduction of machinery and fuel weights, cannot balance the increases of the other weight components; thus, in order to maintain a certain payload level specified by the shipowner, it is required to increase the displacement, what induces some increase in propulsion power (proportional to $\Delta^{2/3}$), etc.

Regarding the building cost, the increase of length implies an increase of the steel cost, while a limited reduction of the cost of machinery propulsion system may be expected (see Chap. 6: estimation of shipbuilding cost). In simple approaches (apart from parametric mathematical optimizations), the identification of the optimum, most economical solution may be accomplished by systematic variation of the ship's length around an estimated initial length. The latter results from comparisons with similar ships, by use of empirical diagrams or semiempirical formulas (see Appendix A and examples in Papanikolaou (2009a, Vol. 2).

2.3.1 Effect of Length on Resistance

It is assumed that, the total resistance R_T of a ship, with a wetted area S , sailing at speed V in calm water of density ρ , can be decomposed according to the hypothesis of W. Froude¹ (1868) as follows:

$$R_T = R_F + R_R \quad (2.1)$$

where R_T is the **Total Resistance** or **Towing Resistance**, which has two components,

- the Frictional Resistance R_F and
- the Residuary Resistance R_R

that are elaborated in the following.

The qualitative characteristics of the per ton displacement total ship resistance and of its main components for various speed-length ratios V (kn) / \sqrt{L} (ft) are illustrated in the following graph (Fig. 2.5).

The frictional resistance is determined as

$$\text{Frictional resistance: } R_F = \frac{1}{2} C_F \rho S V^2 \quad (2.2)$$

¹ William Froude (1810–1878) Eminent English engineer, naval architect and hydrodynamicist; he was the first to formulate correctly the law for ship's water resistance and to set the foundations for modern ship model testing, by introducing a unique dimensionless similitude number (Froude number) by which the results of small-scale tests could be used to predict the behaviour of full-sized ships; of importance are also his contributions to ship's stability in waves.

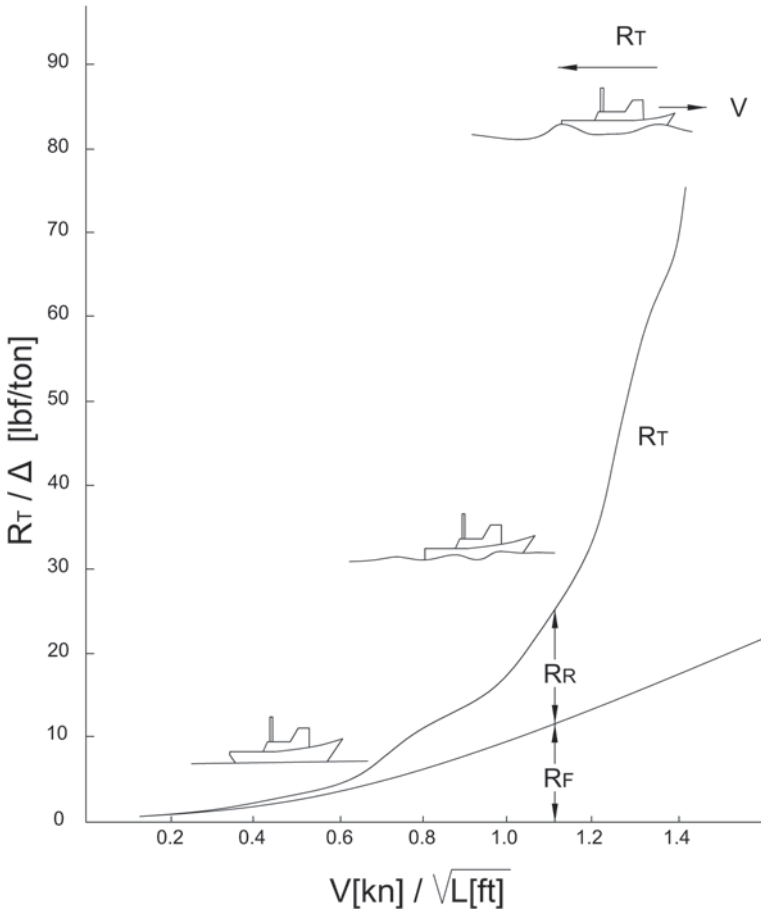

Fig. 2.5 Typical total resistance (per ton displacement) curve as a function of the speed-length ratio V/\sqrt{L} for displacement ships (without dynamic lift)

where

$C_F = f(R_n)$: nondimensional frictional resistance coefficient dependent on the nondimensional Reynolds number, that is, $R_n = V \cdot L / \nu$, ν : sea water’s kinematic viscosity ($= 1.19 \cdot 10^{-6} (\text{m}^2/\text{s})$ at 15°C), $L = L_{WL}$, V ship’s speed (m/s).

$C_F = 0.075 / (\log_{10} R_n - 2)^2$
according to ITTC 1957.

S : wetted hull surface, $\approx (3.4 \cdot \nabla^{1/3} + 0.5 L_{WL}) \cdot \nabla^{1/3}$ according to Lap (Figs. 2.6 and 2.7).

$$\text{Residuary resistance } R_R = \frac{1}{2} C_R \rho S V^2 \tag{2.3}$$

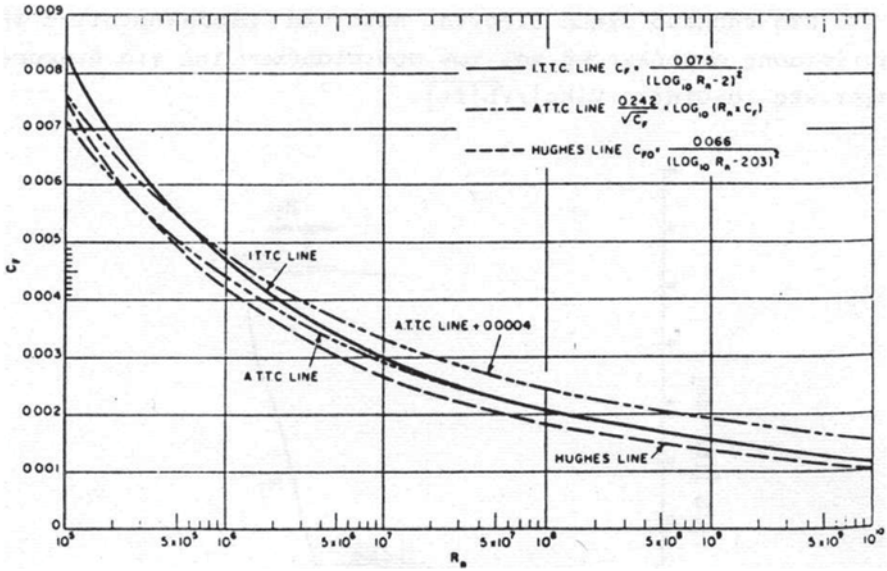

Fig. 2.6 Basic relationships for calculating the ship's frictional resistance coefficient, $C_f = f(R_n)$. (Lewis 1988)

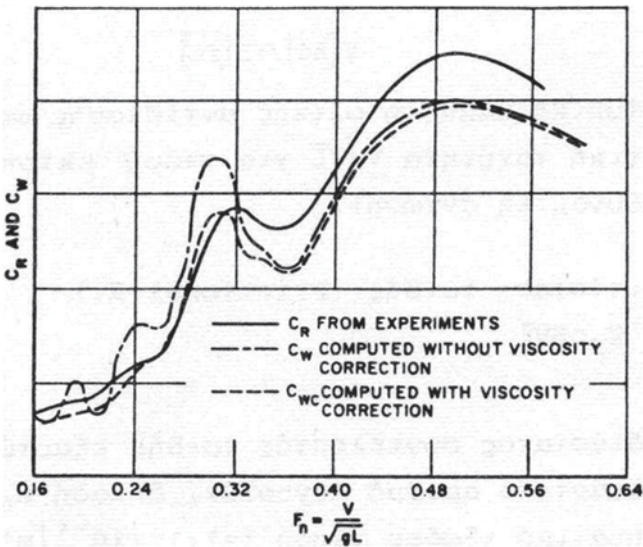

Fig. 2.7 Qualitative relationships of the residuary resistance coefficient C_R and wave resistance coefficient C_W with Froude number F_n —Comparison of results from model experiments and numerical estimations. (Lewis 1988)

where

$C_R = f(F_n, R_n)$: nondimensional residuary resistance coefficient, which is dependent on Froude number $F_n = V/\sqrt{g \cdot L}$ (where g is gravitational acceleration), on Reynolds number, and on the ship's hull form (*Form Resistance*)

The residuary resistance R_R can be further decomposed as follows:

$$R_R = R_W + R_{PV} \quad (2.4)$$

where R_W is the wave resistance,

$$R_W = \frac{1}{2} C_W \rho S V^2 \quad (2.5)$$

C_W is the nondimensional wave resistance coefficient,

$$= f(F_n, \text{hull form})$$

R_{PV} is the pressure viscous² resistance,

$$R_{PV} = \frac{1}{2} C_{PV} \rho S V^2 \quad (2.6)$$

C_{PV} is the nondimensional pressure viscous resistance coefficient,

$$= f(F_n, R_n, \text{hull form})$$

As mentioned earlier, the residuary resistance R_R and the corresponding coefficient C_R are functions of both the F_n and R_n numbers, and of the ship's hull form.

In Froude's original, simplified hypothesis, it was assumed that

$$C_R = f_1(F_n) + f_2(F_n, R_n) \cong f_3(F_n) \quad (2.7)$$

that is, the effect of R_n on the residuary resistance is neglected.

If we consider the wetted surface area S approximated according to the simplified Taylor's formula (Lewis 1988)

$$S = C_S \cdot \sqrt{V} \cdot L \quad (2.8)$$

where $C_S = f(B/T, C_M)$, and the frictional coefficient C_F is taken for turbulent flow according to Prandtl:

$$C_F = 0.072 \cdot R_n^{-0.2} \quad (2.9)$$

² Sometimes called "form" resistance, though correctly the *residuary* resistance is ship's "total form dependent resistance or pressure resistance."

then it is concluded that, for an increase of length with the ratio:

$$\lambda = L_1 / L_0 \quad (2.10)$$

where $(\dots)_0$ holds for the parent hull and $(\dots)_1$ for the present hull, the frictional resistance R_F increases with the ratio:

$$(R_F)_1 / (R_F)_0 = \lambda^{3/10} \quad (2.11)$$

Assuming the residuary resistance coefficient to be a function of F_n number:

$$C_R = f(C_n) \cong C \cdot F_n^\alpha, \quad (2.12)$$

where the exponent α is typically taken between 3 and 5, depending on F_n and hull form, the ratio for the residuary resistance is concluded:

$$(R_R)_1 / (R_R)_0 = \lambda^{-(\alpha-1)/2} \quad (2.13)$$

where $3 \leq \alpha \leq 5$

thus, a reduction of the residuary resistance by the ratio λ^{-1} to λ^{-2} .

For the total resistance it follows:

$$(R_T)_1 = (R_F)_0 \cdot \lambda^{3/10} + (R_R)_0 \cdot \lambda^{-(\alpha-1)/2} \quad (2.14)$$

Therefore, for typical ship lengths L and Froude numbers $F_n \geq 0.15$ the *reduction of the residuary resistance R_R with an increase of λ is more drastic than the increase of the wetted surface*, and of the frictional resistance R_F , resulting in the *decrease of the total resistance*.

The historical Fig. 2.8 from David W. Taylor (1943), which is based on the analysis of systematic towing experiments of ship models for full scale naval vessels of constant displacement 30,000 t and 29 kn speed, shows the minimum total resistance for a length of $L \sim 300$ m, as well as the drastic reduction of the residuary resistance with the increase of length.

Obviously, the trend of these curves may change for other ships, according to the percentage share of the R_R and R_F components in the total resistance R_T (Fig. 2.8).

Thus, for small Froude numbers (≤ 0.15), as is the case for example for tankers/bulk carriers, the frictional resistance constitutes the primary part of the total resistance ($\sim 80\%$ R_T), while for relatively fast ships ($F_n > 0.25$), the conditions are just reversed (see following figure and Table 2.3) (Fig. 2.9).

Apart from the indirect influence of length on the R_R and R_F resistance components, it is important to attempt to avoid unfavorable Froude numbers, around which the superposition of the primary bow and stern wave systems leads to tuning, resulting in an increased wave resistance R_W . This means, when the wave crest/trough of the generated/shipbound bow system coincides with the corresponding crest/trough of the stern system, this leads through superposition to a tuning, re-

Fig. 2.8 Effect of length on the resistance of a ship with constant displacement $\Delta=30,000$ t and speed $V=29$ kn according to DW Taylor (1943)

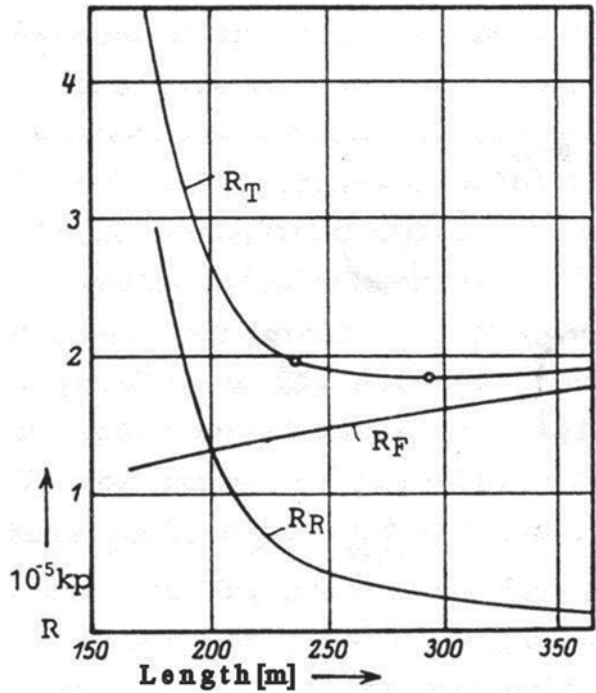

sulting in a wave system of increased wave amplitude; consequently, it causes an increase of wave resistance. The latter corresponds to the energy loss of the ship in view of the disturbance of the calm water surface and it is proportional to the square of the amplitude of the generated waves. These phenomena are now elaborated in more details.

- A: Slow cargo ship
- B: Transoceanic passenger ship
- C: Small passenger ship or cruiser
- D: Torpedo boat

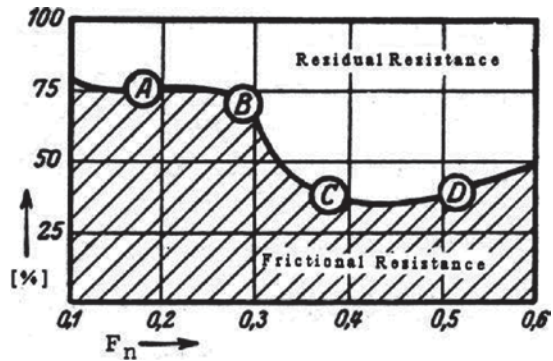

Fig. 2.9 Percentage shares of frictional resistance and residuary resistance for different ship types and characteristic Froude numbers by F. Horn (1930). A Slow cargo ship, B Transoceanic passenger ship, C Small passenger ship or cruiser, D Torpedo boat

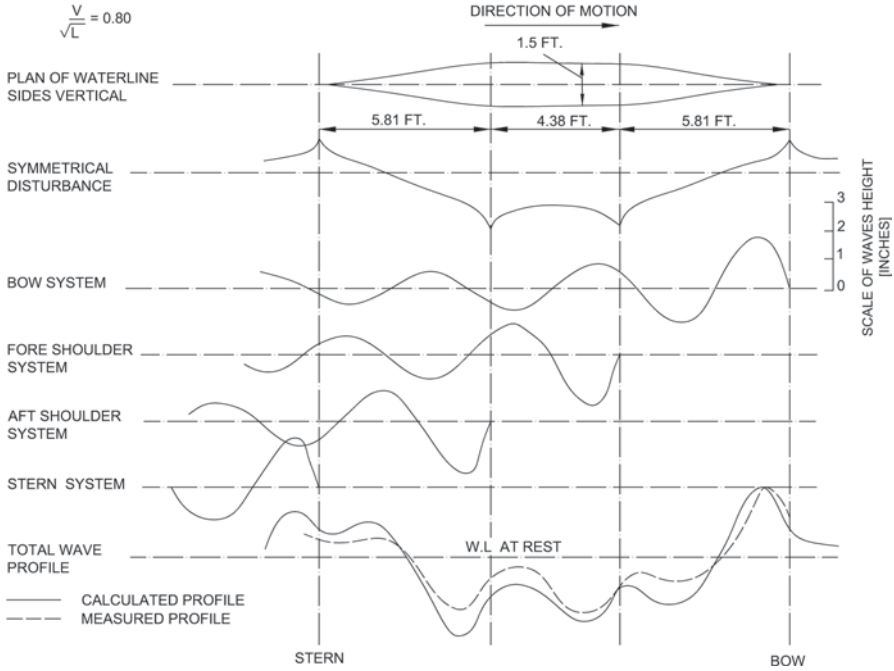

Fig. 2.10 Wave systems for a double-wedged model according to Wigley. (Lewis 1988)

It is well-known from analytical and experimental studies that the symmetrical pressure distribution arising around a double-wedged body, with parallel midbody (see Fig. 2.9 according to Wigley in Lewis 1988), which sails with constant forward speed on the calm water surface, is the cause for initially two wave crests at the bow and aft perpendiculars and an extended trough along the ship’s parallel midbody (Fig. 2.10a).

The system (a) as shown in Fig. 2.10, which is also known as “primary wave system,” travels at the same speed as the vessel, so that it stays at the same position with reference to the moving ship; due to the double symmetric pressure distribution around the ship, this wave system does not cause any resistance as long as the ship moves with constant forward speed (assuming inviscid, ideal flow). However, this primary wave system is the underlying cause for the following four “secondary” wave systems:

1. The bow wave system (b), starting with a crest
2. The fore shoulder system (c), starting with a trough
3. The aft shoulder system (d), starting with a trough
4. The stern wave system (e), starting with a crest

Considerably behind the ship, all four above secondary systems (b) to (e) acquire pure sinusoidal form of decaying amplitude and a length that corresponds to the

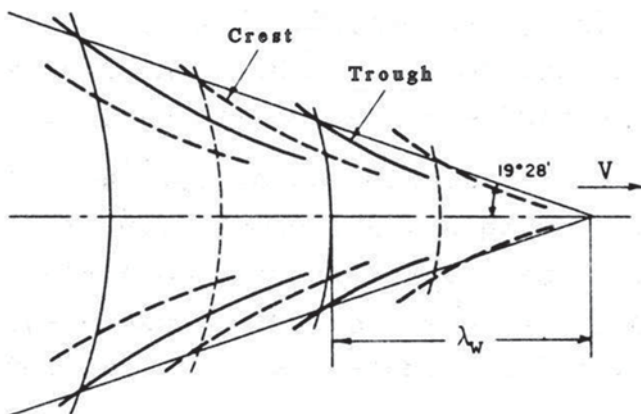

Fig. 2.11 Wave systems behind a pressure point moving at constant speed V , according to Lord Kelvin (1887). (see Lewis 1988)

length of a free surface wave travelling at the same speed V as the ship. For such waves on the free water surface the following relationship applies:

$$\lambda_w = (2\pi / g)V^2 \quad (2.15)$$

where λ_w = length of a free surface wave with velocity V in deep water.

According to the theory of Lord Kelvin (1887) a singular “pressure point” moving on a straight line with velocity V on the free water surface creates two wave systems behind itself (Fig. 2.11). As seen in the figure, the characteristic model of the Kelvin waves is composed of two subsystems:

- One *transverse* system that starts with a crest or trough at the pressure point (depending on the pressure value, positive or negative) and which has a wavelength, as given above; crests and troughs are indicated by dotted and full lines; and
- One *diagonally moving divergent* wave system bounded by two straight lines forming an angle of $19^\circ 28'$ (deep water hypothesis) with respect to the straight travelling line; crests and troughs are indicated as above.

Assuming the aforementioned “primary” pressure system (a) in Fig. 2.10 composed of an infinite number of Kelvin “pressure points”, then obviously the number of the generated secondary systems (b) to (e) increases accordingly. However, even the simplified modeling/superposition of only two basic waves, namely that of the bow wave (b) and that of the stern wave (e), leads to the essence of the reasoning regarding the causes of wave resistance (Figs. 2.12 and 2.13).

As shown in the detailed Fig. 2.10, the superimposition of the secondary wave systems leads to a non-symmetric profile of the wave surface (and of the pressure distribution) around the ship. Due to the corresponding non-symmetric pressure distribution, a net longitudinal force results, opposite to the direction of the ship’s motion. This force is known as “wave (making) resistance”.

If the ship speed changes, the length of the secondary wave systems will change accordingly, whereas the wave generation points remain unchanged; this leads to

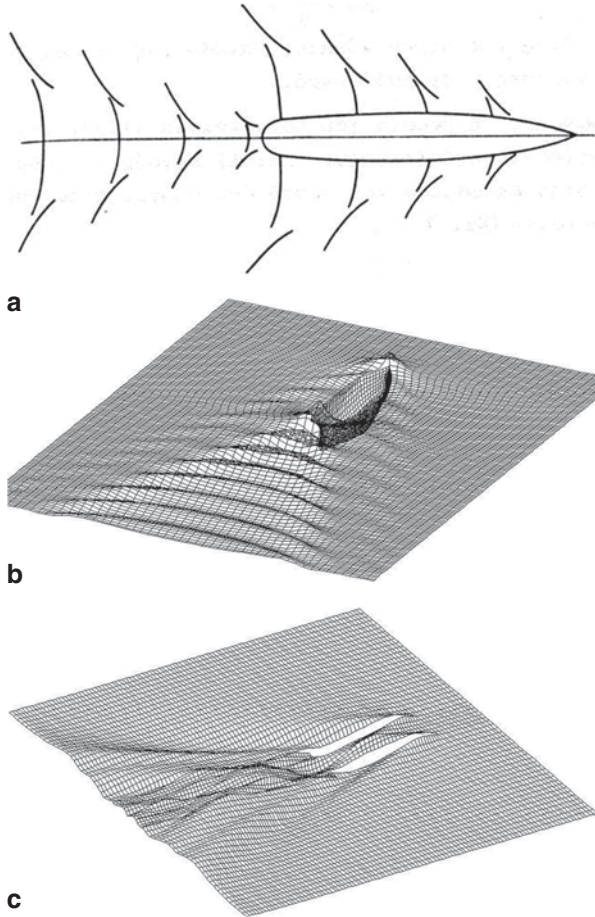

Fig. 2.12 a Schematic diagram of simplified superposition of the ship's bow and stern wave systems. b Wave systems of a container ship, generated numerically with 3D panel method (SHIPFLOW). c Wave systems of a catamaran, generated numerically with 3D panel method (SHIPFLOW®)

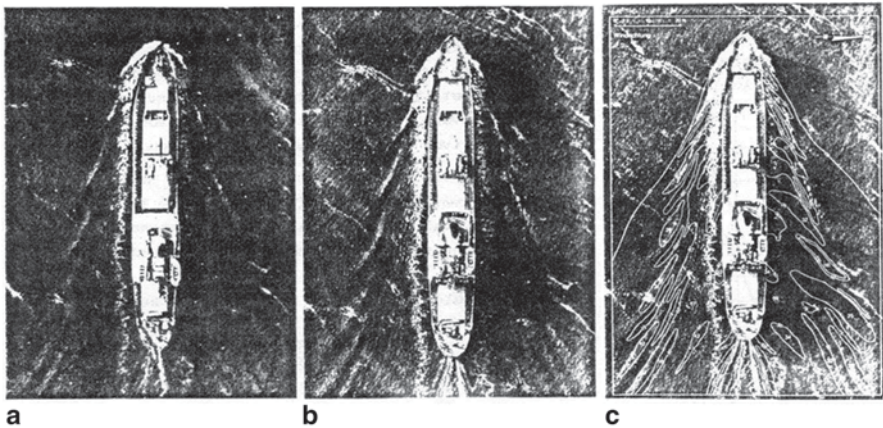

Fig. 2.13 a, b, c Photographic and stereographic imaging of generated wave systems of a ship

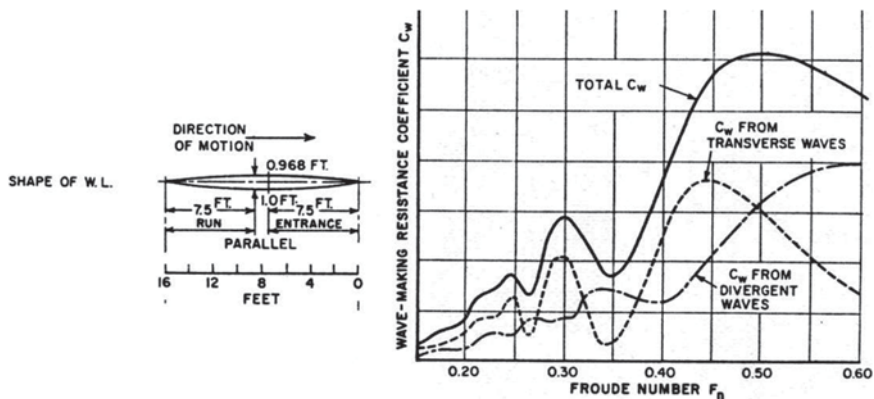

Fig. 2.14 Analysis of the components of wave resistance for a ship model with parabolic waterline. (Lewis 1988)

a modification of the resulting superposition of the wave systems and of the corresponding wave resistance.

The nondimensional wave resistance coefficient takes the form:

$$C_w = \frac{R_w}{\frac{1}{2} \cdot \rho V^2 \cdot S} \tag{2.16}$$

Apart from its dependence on the ship’s hull form, it shows strong fluctuations as a function of the ship’s speed and of Froude number, in accordance with the outcome of the superposition of the secondary wave systems (tuning or attenuation). A typical example for the behavior of $C_w = f(F_n)$ for a ship model with parabolic waterline is given in Fig. 2.14; it shows the contributions from the transverse and divergent wave systems to total wave resistance.

In order to obtain a *favorable* ship operational region with respect to Froude number, that is, to have a relatively reduced wave resistance, we need to ensure at least the tuning of the bow (b) and stern (e) wave systems so that they cancel each other, thus to achieve wave attenuation. Mathematically, the ratio of waterline length L_{WL} , which corresponds approximately to the distance of the wave generation points of the two systems, to the half wavelength λ_w must be an **odd** number, namely:

$$L_{WL} / (0.5\lambda_w) = (2n + 1), \quad n = 1, 2, 3 \dots \tag{2.17}$$

On the contrary, for *adverse* Froude number operational regions this ratio should be an **even** number.

We present in Table 2.2 the adverse and favorable regions of Froude numbers, as derived from model experiments; they are approximately confirmed by applying the above simplified relationships between L_{WL} and λ_w .

If during the selection of the ship’s length it is found that the ship’s operating region is located within the limits of unfavorable Froude numbers, it is possible to

Table 2.2 Adverse and favorable regions of Froude numbers in terms of wave resistance for normal ships

| | $F_n = V / \sqrt{g \cdot L_{pp}}$ |
|---------------------------------|-----------------------------------|
| Adverse regions (tuning) | 0.45–0.50, 0.29–0.31, 0.23 |
| Favorable regions (attenuation) | 0.33–0.36, 0.25, 0.21 |

avoid or mitigate the undesirable interference of the generated wave systems with the following measures:

1. Change of length³
2. Smoothing of hull shoulders
3. Change of speed

Table 2.3 presents typical operating points of common ship types. It can be observed that the operating points of certain vessels are in the undesirable Froude number regions. However, it is noted that in these cases either the percentage share of R_w in total resistance is small (low Froude number), or it concerns ships of medium to small absolute speeds combined with small lengths (fishing vessels). As regards naval ships, with $F_n > 0.5$, there it is attempted to mitigate the tuning phenomena of the bow and stern wave systems with appropriate smoothing of the hull.

Critical-boundary and economic speed We may select the appropriate length in conjunction with the hull form coefficients C_B or C_P and the corresponding speed, using the basic formula of Alexander (see Eq. 2.1):

$$V(\text{kn}) / \sqrt{L_{pp}(\text{ft})} = 2(K_1 - C_B) \tag{2.18}$$

Table 2.3 Percentage contribution of frictional resistance to the total resistance and typical operating points of modern ships in terms of Froude number. (Schneekluth 1985)

| F_n | (R_f/R_T) (%) | $C_w = f(F_n)$ | L^*/λ_w | $L^*/(0.5\lambda_w)$ | Ship type |
|-----------|-----------------|----------------|-----------------|----------------------|--------------------------|
| 0.15 | 80 | Crest | 5.0 | 10 | Large size tanker (VLCC) |
| 0.19 | 70 | Trough | 4.5 | 9 | Medium size tanker |
| 0.23 | 60 | Crest | 3 | 6 | Medium speed cargo ship |
| 0.25 | 60 | Trough | 2.5 | 5 | Fast cargo ship |
| 0.29–0.31 | 50 | Crest | 2 | 4 | Fishing ship |
| 0.33–0.36 | 40 | Trough | 1.5 | 3 | Fast cargo ship/Reefer |
| 0.40 | | Crest | 1 | 2 | |
| 0.50 | 30 ÷ 35 | Crest | 0.64 | 1.28 | Naval ship/cruiser |
| 0.563 | | Trough | 0.5 | 1 | |

L^* distance of the crest of bow wave to trough of stern wave system, $L^* \equiv L_{WL}$
 λ_w length of generated waves = $(2\pi/g)V^2$

³ However, an increase of length has typically significant negative side effects on some ship weight components (especially on structural weight and payload) and construction cost, as has been stated already.

where

$$K_1 = 1.08 \text{ for trial speed } V_T \text{ (trial)} \\ = 1.05 \text{ for service speed } V_S \text{ (service),}$$

or Troost's formula:

$$V_S \text{ (kn)} / \sqrt{L_{PP} \text{ (ft)}} = 1.85 - 1.6C_p \quad (2.19)$$

where

$$V_S: \text{ service speed,} \\ \cong 0.94 V_T \text{ (trial speed),}$$

In this respect, we define a speed limit (boundary or critical velocity) in relation to the ship's characteristics, expressed here by L and C_B , the exceedance of which leads to a rapid increase of the required propulsion power.

It can be shown that while the part of the required propulsion power, which corresponds to the frictional resistance, increases approximately with the exponent 2.8 with respect to speed, the corresponding residuary resistance has an exponent that may be even more than 5. Thus, it is concluded that for the propulsive power P :

$$P \propto V^n, \text{ where } n \geq 3$$

As a *boundary* or *critical* speed we define the speed the excess of which is related to an exponent greater than 3:

$$n(V \leq V_{CR}) \cong 3$$

A simple descriptive explanation for the *boundary speed* is the abrupt drop of the British Admiralty constant at that speed:

$$C_N = \frac{V^3 \Delta^{2/3}}{P} \quad (2.20)$$

see $C_N = f(V)$, Fig. 2.15 (F. Horn⁴ 1930). Likewise, we may see the same effect by observation of rapid increase of the *circular* total resistance coefficient ©, namely

$$\text{©} \equiv \frac{R_T}{\Delta} \cdot \frac{1000}{K^2} \quad K \equiv 0.5834 \frac{V}{\Delta^{1/6}}$$

©_{400FT}: refers to ships with a standard length of 400 ft.

R_T (tonf), Δ (tonf), V (kn)

Anglo-Saxon units: 1 tonf = 1 long ton = 1.016 metric tons.

⁴ Fritz Horn (1880–1972): Eminent German professor of ship theory at the Technical University of Berlin; before becoming professor in 1928, he worked for the German shipbuilding industry and the navy; his main contributions are in the theory of antirolling tanks, propeller theory, including the theory of ducted propellers, and wave induced vibrations.

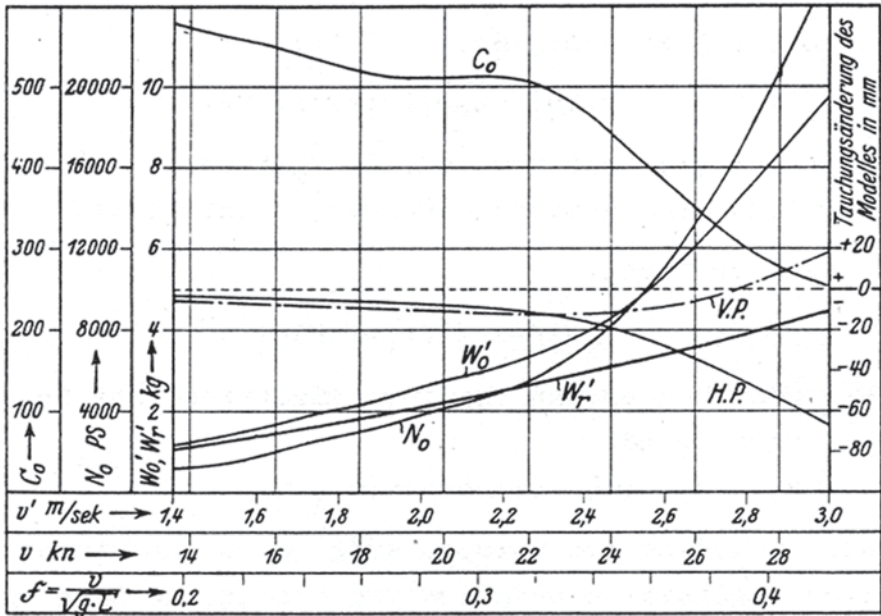

Fig. 2.15 Results of towing experiments of ship model according to Horn (1930). ($C_0 \equiv C_N$ (Admiralty constant), $N'_0 \equiv P_E$ (effective power), $W'_0 \equiv R_T$, $W''_0 \equiv R_P$, (') means: model values, V.P.: draft at forward perpendicular, H.P.: draft at aft perpendicular)

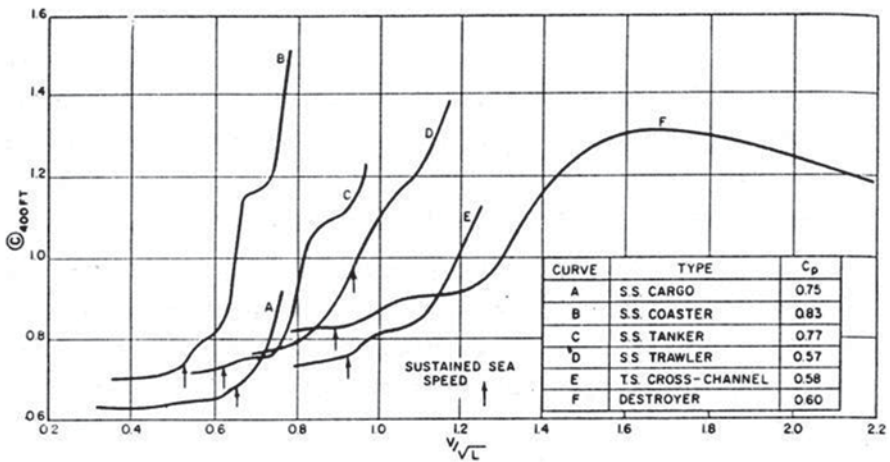

Fig. 2.16 Characteristic curves of the Anglo-Saxon circular total resistance coefficient © for various types of ships with indication of service speed. (Lewis 1988)

It is logical to note that the “service” speed is (almost) always chosen to be smaller than the “critical” speed by a certain percentage, depending on the form of the curve $P=f(V)$ or $C_w=f(F_n)$ (see Fig. 2.16). In this way the ship can be operated economically in speed regions with relatively reduced resistance, and it is possible to

recover potential delays during a voyage, that is, by slight increase of the speed without significant increase of the required propulsion power (and fuel consumption).

The trial speed of a ship, which is regarded approximately 6% higher than the service speed, is usually very close to the critical speed. Therefore, *assuming that the operational conditions are identical to those at the trials* (in particular: calm and deep water; clean hull; no wind, waves, or currents), it is concluded:

$$P(V_T) \cong 1.25P(V_S) \quad (2.21)$$

as long as the trial speed $V_T \cong 1.06 V_S$, and the corresponding horsepower increases with an exponent of at least 4 in terms of speed.

However, under service conditions there is normally a resistance increase caused by hull fouling, weather conditions, etc., which is in the range of 10–25%. Thus, it may be argued that, in practice *it requires approximately the same horsepower* as for the 6% higher trial speed to achieve the *service speed under service conditions*.

Conclusions

1. The selection of the ship's length, with the least resistance/powering criterion in mind, is based on the *value of the ship's relative speed*, that is, the *Froude number* that correlates the speed with the length, rather than on the *absolute* speed.
2. Relatively slow vessels, with a small operational Froude number (up to about 0.20), exhibit a high percentage of frictional resistance, in relation to their total resistance (see Table 2.3) and require, for the reduction of frictional resistance, minimum wetted surface for given displacement, which geometrically corresponds to short and full hull forms⁵, that is, very high C_B and C_p coefficients, but relatively small lengths L and low slenderness coefficients $L/\nabla^{1/3}$.
3. Relatively fast ships ($F_n \geq 0.25$), on the contrary, with a significant proportion of wave resistance, require relatively slender hulls, that is, low C_p and C_B coefficients, high slenderness coefficient $L/\nabla^{1/3}$, appropriate lengthwise distribution of displacement, with the center of buoyancy abaft of midship and relatively large lengths L .

2.3.2 Effect of Length on the Ship's Strength and Structural Weight

In order to explore the influence of length on the ship's longitudinal strength and structural weight, we consider the ship in a simplified manner, namely as a *slender*

⁵ Note that the hull form with smallest wetted surface for given displacement volume is the sphere (or floating half-sphere). This fact led recently designers to look into innovative hull forms of slow steaming cargo ships with ellipsoidal characteristics around amidships, which proves beneficial both with respect to low resistance and minimum ballast water requirements (see the E4 container ship concept by G. Koutroukis and A. Pavlou of NTUA-SDL, VISIONS European academic competition 2011).

Fig. 2.17 Consideration of the ship's hull as a bending beam

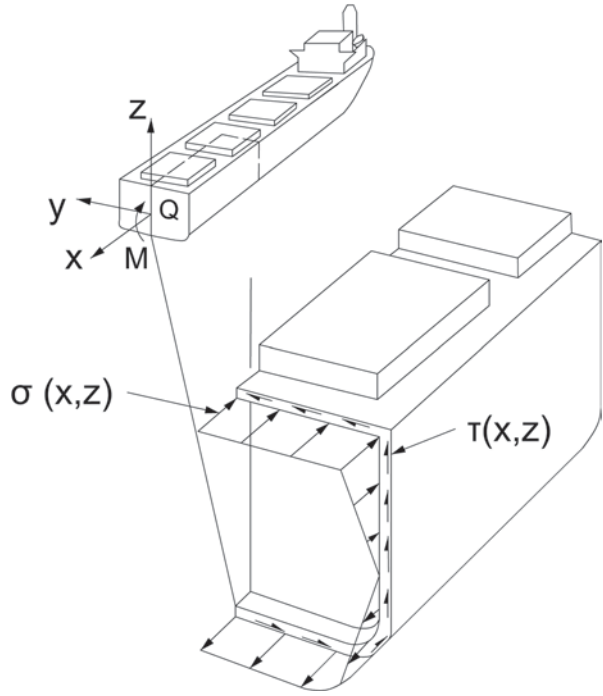

bending beam (see Fig. 2.17), for which the following relationship applies (Fig. 2.18):

$$\sigma(x,z) = M(x) \cdot z / I(x) \tag{2.22}$$

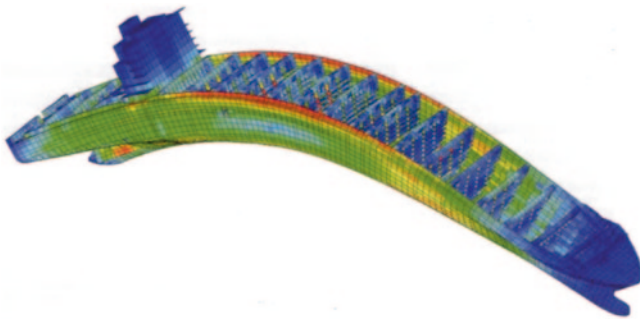

Fig. 2.18 Bending deflection (vertically magnified) of a containership in hogging state—calculated stress distribution (*colored levels*) by Finite Element Method (FEM). (Source: Germanischer Lloyd)

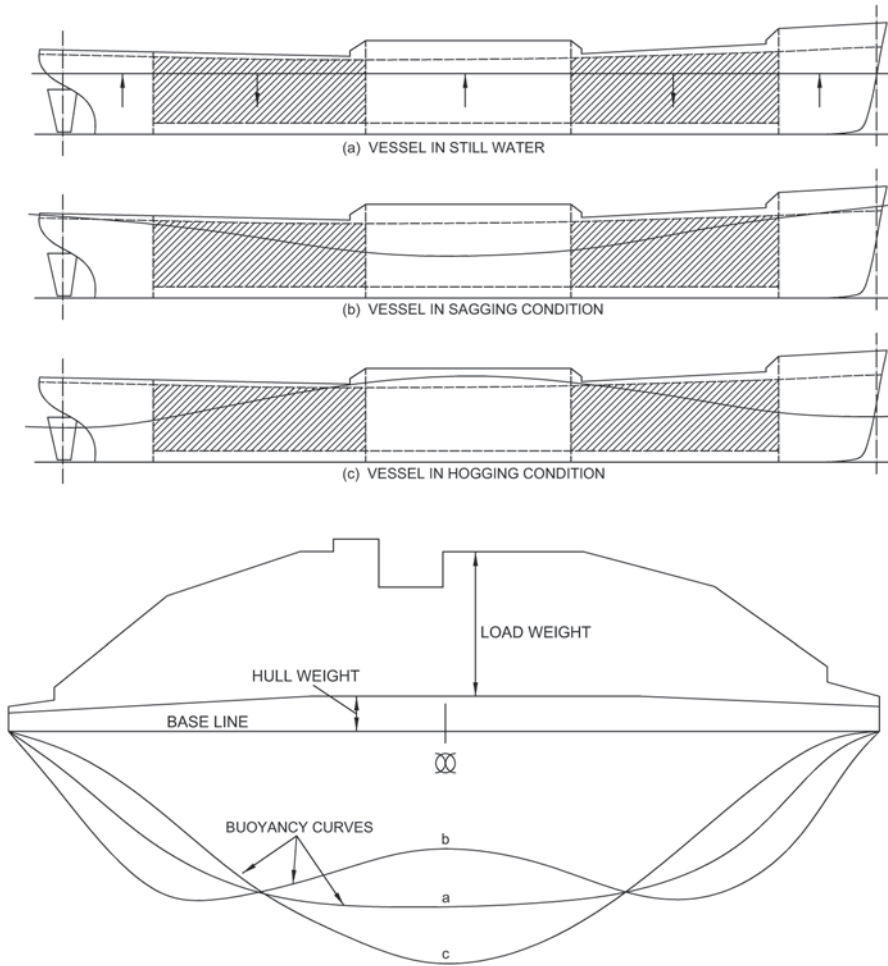

Fig. 2.19 Typical loading conditions and associated buoyancy and load distributions for the longitudinal strength of a ship (Lewis 1988)

where

σ : bending stress at point (x, z)

M : bending moment at point (section) x

I : moment of inertia of the beam's (ship's) cross-section at x

The slender bending beam assumption for the ship is acceptable particularly for ships with high L/B and L/D ratios. The high levels of bending stress arise at the midship region in case of both *still water bending* (Fig. 2.19a) and for typical *bending of the ship in waves*.

In particular, two extreme situations are usually examined, namely considering the ship (“frozen”) as travelling on the crest or the trough of a following/stern wave of approximately the same length and speed as the ship; in the first case a buoyancy

excess presents around the midship section, when the crest of the loading wave is close to the midship section (*hogging*); in the second case, the buoyancy excess is situated at both ends of the ship, which implies that the wave trough is at the centre of the ship (*sagging*) (Fig. 2.19b and c).

The maximum bending moment occurs at the midship section and it can be approximated by the following approximate formula (see Strohbusch⁶ 1971):

$$M_{\max} = M(x = L/2) = C \Delta L \quad (2.23)$$

where

- C: constant dependent on ship type, loading condition, wave length and height. Typical approximate values for the full load condition and main engine amidships or slightly abaft are listed below.

For fully loaded cargo ships in general we have (approximately):

- C = 0.012 (calm water)—generally for cargo ships
 = 0.025 (“hogging”, additional moment)
 = -0.013 (“sagging”, additional moment).

For fully loaded tankers we have:

- C = -0.006 to +0.003 (calm water)
 = 0.020 (“hogging”, additional moment)
 = -0.028 to -0.020 (“sagging”, additional moment).

In the process of the ship’s preliminary design, a more precise examination of the ship’s longitudinal strength is required, namely the evaluation of the sum of acting bending moments (and of vertical shear forces) under the various loading conditions and for navigating in both calm water and waves, according to the specifications of recognized classification societies.

Among these conditions, the maximum still water bending moment and vertical shear forces result from the differences between the longitudinal distributions of buoyancy and weight of the ship on the basis of refined hydrostatic calculations, which are routinely conducted by use of standard naval architectural software packages.

For the additional bending moments at midship from the loadings in waves the latest specifications of the International Association of Classification Societies IACS (IACS UR S-11) can be used, namely

$$M_{\text{ws}} \text{ (kNm)} = -110 C L^2 B (C_B + 0.7) 10^{-3} \text{ (sagging moment)} \quad (2.24)$$

$$M_{\text{wh}} \text{ (kNm)} = +190 C L^2 B C_B 10^{-3} \text{ (hogging moment)} \quad (2.25)$$

⁶ Erwin Strohbusch (1904–1980) Leading German professor of ship design at the Technical University of Berlin after WWII; before becoming academician, he worked as naval architect in leading positions at the German Navy and at the Henschel aircraft industry as aerodynamicist and aircraft designer.

and

$$\begin{aligned} C &= 10.75 - (3 - L/100)^{1.5} && \text{for } 90 \leq L \leq 300 \text{ m} \\ &= 10.75 && \text{for } 300 \leq L \leq 350 \text{ m} \\ &= 10.75 - [L/150 - 2.333]^{1.5} && \text{for } 350 \leq L \leq 500 \text{ m} \end{aligned}$$

Thus, from the sum of the bending moment in calm water and in waves (taking into account the sign, which assumes positive values in case of tensile stress on the deck)

$$M_{\text{tot}} = M_{\text{sw}} + M_{\text{w}} \quad (2.26)$$

it is concluded for the maximum bending stresses on the deck and bottom of the midship section:

$$\sigma_{1,2} = M_{\text{tot}} / W_{1,2} < 175 \text{ N/mm}^2 \quad (\text{for common shipbuilding steel}) \quad (2.27)$$

where

$W_{1,2}$: section modulus = $I_M / z_{1,2}$

$z_{1,2}$: distances of deck and bottom respectively from the neutral axis

I_M : moment of inertia of midship section.

For the moment of inertia of midship section the following minimum value results as requirement:

$$I_M > 3CL^3 B(C_B + 0.7) (\text{cm}^4) \quad (2.28)$$

Effects of changing length Examining each of the aforementioned boundary loading conditions, for the ship moving in calm water or waves, we assume that the displacement Δ is fixed, as are the distribution of weights and buoyancy and the resultant loading curve of the ship's hull as a bending beam. Therefore, any changes in the bending moment $M(x)$ are simple functions of the length.

Considering an increase of the length by the ratio $\lambda = L_1/L_0$ (subscript 1: examined length, 0: original length), an increase of the bending moment by the same ratio is concluded:

$$M_1 = \lambda \cdot M_0 \quad (2.29)$$

Case A Assuming that for the ship under design, the displacement Δ , beam B , draft T , and the midship section (area and boundary profile) are fixed. The effects of a length change by the ratio λ are explored. Because of the fixed displacement, beam, and draft, it is clear that:

$$C_{B1} = (1/\lambda)C_{B0} \quad (2.30)$$

Provided that the midship section is fixed in terms of area and shape (profile), then the sectional modulus will remain unchanged, but the bending stresses will change by the ratio λ :

$$\sigma_1 = M_1 / W_1 = \lambda M_0 / W_0 = \lambda \cdot \sigma_0 \quad (2.31)$$

If we request that the stress level remains unchanged (similar construction material), namely:

$$\sigma_1 = \sigma_0$$

the moment of inertia must satisfy the following relation:

$$I_1 = \lambda I_0.$$

Considering for the simplified calculation of the moment of inertia of the midship section of the ship a *tubular* type bending beam of sectional area A_f , perimeter p , and average thickness t :

$$I = \kappa \cdot A_f \cdot d^2 = k \cdot p \cdot t \cdot d^2 \quad (2.32)$$

where

d = distance of the extreme structural points (the ship's deck or bottom) from the neutral axis,

κ = form coefficient of midship section.

It shows for constant midship section, that is, constant κ , p , and d , and constant ratio (I/t):

$$t_1 = \lambda \cdot t_0.$$

In conclusion, for maintaining the same level of bending stress it is *required to increase the average thickness t* by the ratio of lengths.

If the structural ship weight is expressed in the following form:

$$W_H = K_H \cdot A_H \cdot t \quad (2.33)$$

where

A_H : area of hull surface,

t : average plate thickness

K_H : form coefficient specific to midship section and ship type

it may be concluded for the ship under study:

$$W_{H1} = K_H \cdot A_H \cdot t_1 = \lambda \cdot K_H \cdot A_H \cdot t_0 \quad (2.34)$$

The area A_H can be approximated by Taylor's formula, which originally applies only to the hull's wetted surface, but can be herein extended for an assumed water-line at the deck height level:

$$A_H = C_H \cdot \sqrt{\nabla} \cdot L \quad (2.35)$$

where

$$C_H = f(B/D, C_{MD}) \quad (2.36)$$

However, it has been assumed that the midship section remains constant and the same applies to its area and perimeter, that is, B/D , $C_{MD} = C_M(T=D)$ and C_H constant. Thus, it is concluded for the hull surface:

$$A_{H1} = C_H \cdot \sqrt{\nabla} \cdot L_1 = \sqrt{\lambda} A_{H0} \quad (2.37)$$

and for the weights:

$$W_{H1} = \lambda \cdot K_H \cdot \sqrt{\lambda} \cdot A_{H0} = \lambda^{3/2} W_{H0} \quad (2.38)$$

In conclusion, if the displacement, beam, draft and midship section remain unchanged, *an elongation of the ship by the ratio of lengths λ* means an *increase* of the the ship's structural weight of the main hull (without superstructures) *by $\lambda^{3/2}$* and a decrease of the block coefficient C_B by the ratio $(1/\lambda)$.

Case B: Assuming that the displacement Δ and the block coefficient C_B remain fixed, while the product $B \cdot T$ varies inversely proportional to the length, that is:

$$\begin{aligned} \Delta_1 &= \Delta_0 \\ C_{B1} &= C_{B0} \\ (BT)_1 &= (1/\lambda)(BT)_0. \end{aligned}$$

It is also assumed that for small changes of the dimensions the specific form coefficient K_H for the calculation of the steel structure weight stays unchanged.

If it is required to maintain the same bending stress level $\sigma_1 = \sigma_0$, then it is concluded:

$$M_1 \cdot (z_1 / I_1) = M_0 \cdot (z_0 / I_0) \quad (2.39)$$

where

$$\begin{aligned} I_1 &= k_1 \cdot p_1 \cdot t_1 \cdot d_1^2 \\ (p_1 / p_0) &\propto (B_1 / B_0) \propto (T_1 / T_0) \propto 1 / \sqrt{\lambda} \\ (d_1 / d_0) &\propto (T_1 / T_0) \propto 1 / \sqrt{\lambda} \\ k_1 &\cong k_0. \end{aligned}$$

Thus, we have for the moment of inertia:

$$I_1 = k_0 \cdot p_0 \cdot t_1 \cdot d_0^2 \cdot \lambda^{-3/2} \quad (2.40)$$

and due to

$$\begin{aligned}(z_1 / z_0) &\propto (T_1 / T_0) \propto \lambda^{-1/2} \\ (M_1 / M_0) &\propto \lambda\end{aligned}$$

we obtain for the average plate thicknesses:

$$t_1 = \lambda^2 \cdot t_0 \quad (2.41)$$

Finally, substituting the last relationship into the equation of the steel structure weight of the main ship hull:

$$W_{H1} = K_H \cdot A_{H1} \cdot t_1 \quad (2.42)$$

where

$$A_{H1} = \lambda^{1/2} \cdot A_{H0}$$

(for small changes of dimensions B , D and coefficient C_{MD} , see case A), it is concluded:

$$W_{H1} = \lambda^{5/2} \cdot W_{H0} \quad (2.43)$$

Thus, in the case that C_B is kept fixed during the length elongation with the ratio λ , the *increase of weight W_H is more drastic* ($\propto \lambda^{5/2}$) than in *case A* ($\propto \lambda^{3/2}$), where we had reduction of C_B by the ratio $(1/\lambda)$ for fixed beam, draft and midship section.

Conclusions

1. As will be shown in Chap. 6, the cost of the steel structure of a ship is closely related to its weight. Therefore, a relatively high structural weight, as the result of an elongation at the expense of other characteristics of the vessel (see above elaborations), generally involves higher construction cost. Consequently, it is appropriate to keep the length as small as possible⁷.
2. Besides the longitudinal strength, which was examined in this section and concerns the structural design of all ship types, the equally important *torsional stresses of open-deck ships*, such as containerhips, LASH, etc., are also directly dependent on the length of the vessel.
3. The possible shift of displacement from the longitudinal direction (decrease of length) to the transverse (increase of beam) or vertical directions (increase of T) is beneficial for the longitudinal strength, but implies a shift of longitudinal strength problems to corresponding ones in the transverse direction; this requires special attention to the ship's structural design, but can be today readily addressed by modern FEM and other methods (see, for example shallow water, beamy large tankers) (Fig. 2.20).

⁷ Experience says: *the smallest ship (least length) fulfilling shipowner's requirements is generally the best ("optimal")*.

Fig. 2.20 Combined torsional and bending stresses on a containership (Study by Finite Element methods; Source: Germanischer Lloyd)

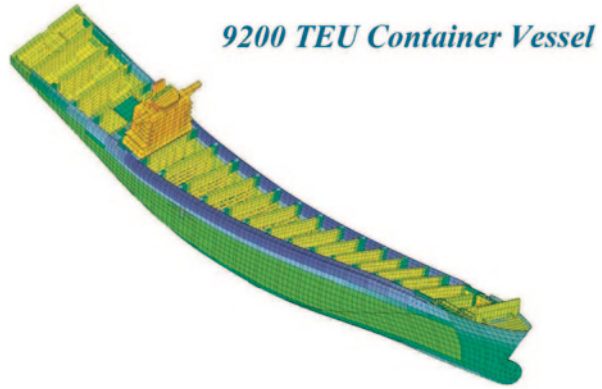

2.3.3 Effect of Length on the Outfitting Weight

As a general rule, increase of the length implies an increase of equipment and outfitting weight.

Examining the effects of an average increase of length on the various components of the equipment on board it is observed that it causes an

- Increase of the length of the piping systems (cargo, ballast, fire-fighting, etc.), cables, A/C airways, insulations, etc.
- Increase in the lateral profile area of the ship above waterline, resulting in an increase of the equipment number relevant to the ship's class, hence of the weight of anchors, chains, winches, etc.
- Increase of lateral profile area of the ship below waterline, resulting in increased demand for the ship's rudder area (the area ratio needs to remain constant, see Sect. 5.3).

It is assumed that the increase of the outfitting weight depends on the length ratio $\lambda = L_1/L_0$ with an exponent α_T :

$$W_{OT} \propto \lambda^{\alpha_T} \quad (2.44)$$

An increase of the weight W_{OT} generally implies an increase of the ship's construction cost (increased cost for materials and manhours for fitting).

2.3.4 Effect of Length on the Weight of Propulsion System and Fuel Consumption

As has been already detailed in Sect. 2.3.1, for ordinary ships with a Froude number $F_n \geq 0.15$, an increase of length generally leads to a reduction of the ship's total resistance for given speed and displacement. Due to the resulting reduction of the

required propulsion power, a decrease of the weight of propulsion installation and reduction of weight of carried fuel (for fixed service range) are concluded. This results in a reduced cost for purchasing the main engine, and a reduced operating cost in terms of the consumption of fuel, lubricant oil, etc.

2.3.5 *Effect of Length on the Exploitation of Spaces and General Arrangement*

The length of a cargo ship has a significant effect on the hold arrangements and the technique of the cargo-handling system. Thus, the number and length of the cargo holds, and the corresponding openings of the hatches, are directly related to the ship's length as well as to the size and location of the engine room.

Particular requirements concerning the configuration of hold spaces generally occur for heterogeneous cargoes, relating to the type, the form and size of break cargo, and to a lesser degree for homogeneous cargoes, namely for the mass bulk cargoes (dry or liquid) or for unitized cargoes.

The requirement for a specific number and size of holds or hatches, always relates to a minimum lower limit for the feasible length, while permitting the loading of various types of cargoes and ensuring full holds.

Especially for bulk cargo carriers and particularly ore carriers, the requirement for an *odd* number (3, 5, 7, 9) of holds (so that it is possible to arrange an "alternate hold loading" due to strength and stability considerations) is an important factor for the length determination (Fig. 2.21).

Also, for ships carrying standardized large cargo units (unitized cargo), such as standard containers (ISO-Containers), barges, trailers, vehicles, and trains, namely containerships, LASH, Ro/Ro, car carriers/ train carriers, the relationship of the length to a multiple of the individual standard cargo length requires the selection of the ship's length within a certain limits, with little freedom to balance any differences to the desired length at the ends of the ship and the engine room.

Finally, for LNG-tanker, in the case of using spherical-LNG tanks, the hold length results from the ship's beam, due to the common tank diameter in both transverse and longitudinal directions and the given number of tanks in longitudinal direction (Fig. 2.22).

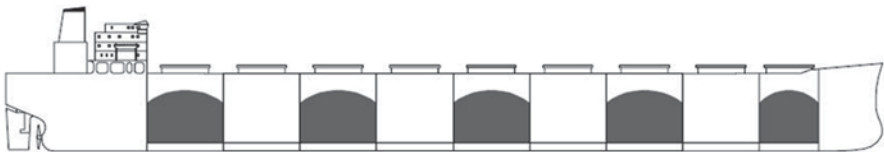

Fig. 2.21 Alternate hold loading for heavy ore cargo (fully loaded)

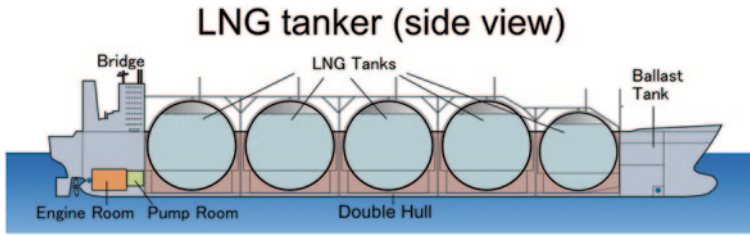

Fig. 2.22 LNG tanker (side view)

2.3.6 Other Factors Affecting the Selection of Length

1. Behavior in waves To avoid intense motions/accelerations in waves, which, beyond unfavorable structural loadings, lead to added resistance and additional powering in waves, thus also to *voluntary or involuntary* speed loss, regions of resonance of ship motions (of heave, pitch, and roll, which are characteristic by their natural periods/frequencies) should be avoided. In determining the ship's length, we are mainly interested in possible resonance in head seas, which primarily induce pitch and heave motions. Figure 2.23 (Lewis 1988) shows that, for a wavelength to ship length ratio $L_w/L = 1.0$ to 1.3 a resonance takes place and excessive values for both heave and pitch motions, which are mathematically coupled.

Of course, in practice it is difficult to avoid the resonance at certain wavelength, due to the existence of many wavelengths in the spectra of natural seas on earth, where seagoing merchant ships may operate. However, one may try to avoid resonance with the waves of higher energy density (at the *significant* wave period/length of known routes). These considerations are valuable for navigational areas for which sufficient statistical data of local wave spectra are available (especially for coastal ships) and they are anyway taken into account in naval ship design.

2. Freeboard The length significantly affects the freeboard of a ship, as it is the basis for calculating the *basic freeboard* in accordance with the Load Line Regulations (ICLL), see Sect. 2.19.

3. Passing limits of routes See dimensions of known canals/narrow straits, etc. (see Sect. 2.2).

2.3.7 Ship Length Estimation Using Empirical Formulas

Common empirical methods for estimating the length L are as follows:

- Using coefficients ($L/\nabla^{1/3}$) for various ship types
- Using semi-empirical mathematical formulas from statistical analyses that are based on purely economic criteria
- Using semiempirical mathematical formulas derived from statistics of existing ships (based on hydrodynamic and economic criteria)
- Using empirical diagrams for different types of ships

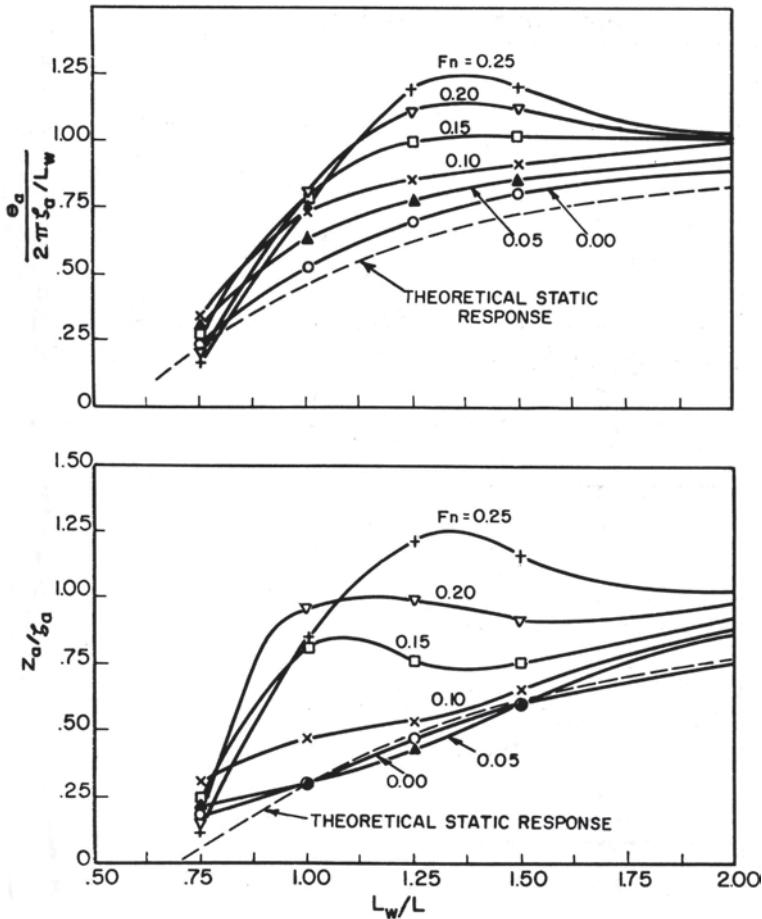

Fig. 2.23 Amplitude of pitch motion θ_a and heave motion z_a of a Series 60 ($C_B=0.60$) model in head waves with amplitude ζ_a and length L_w , at different Froude numbers. (Lewis 1988)

Applications

- a. After the prediction of the displacement and displaced volume ∇ , it is possible to estimate the length by using the slenderness coefficients $L/\nabla^{1/3}$ from Tables 2.4 and 2.5 or from similar ships (see values in Appendix A).
- b. Formula of “length of minimum building cost” according to Schneekluth (1985)

$$L = \Delta^{0.3} \cdot V^{0.3} \cdot C \tag{2.45a}$$

where

L : length between perpendiculars (m),

Δ : displacement (t),

V : service speed (kn) or

$$L = 1.22 \cdot \Delta^{0.3} \cdot V^{0.3} \cdot C \tag{2.45b}$$

for speed V in m/s

Table 2.4 Hull form coefficients and ratios of main dimensions for merchant ships (synthesis of original data by Strohbusch 1971, updated by Papanikolaou by use of IHS Fairplay World Shipping Encyclopedia, v. 12.01, 2011). Given upper and lower boundaries correspond to the standard deviation from the regression line of sample ships, as shown in Appendix A

| Ship type | Hull form coefficients | | | | Ratios of main dimensions | | |
|---------------------------------|--------------------------------------|-----------------|--------------------------------------|-----------|--|---------|--|
| | C_p | C_M | C_B | C_{WP} | L_{PP}/B | B/T | $L_{PP}/\nabla^{1/3}$ |
| Fast seagoing cargo ships | 0.57–0.65 | 0.97–0.98 | 0.56–0.64 | 0.68–0.74 | 5.7–7.8 | 2.2–2.6 | 5.6–5.9 |
| Slow seagoing cargo ships | 0.66–0.74 | 0.97–0.995 | 0.65–0.73 | 0.80–0.86 | 4.8–8.5 | 2.1–2.3 | 5.2–5.4 |
| Coastal cargo ships | 0.69–0.73 | –0.985 | 0.58–0.72 | 0.78–0.83 | 4.5–5.5 | 2.5–2.7 | 4.2–4.8 |
| Small short sea passenger ships | 0.61–0.63 | 0.82–0.85 | 0.51–0.53 | 0.65–0.70 | 5.8–6.5 | 3.3–3.9 | 6.3–6.6 |
| Ferries | 0.53–0.62 | 0.91–0.98 | 0.50–0.60 | 0.69–0.81 | 5.9–6.2 ^a 5.2–5.4 ^b | 3.7–4.0 | 6.2–6.9 ^a 5.7–5.9 ^b |
| Fishing vessels | 0.61–0.63 | 0.87–0.90 | 0.53–0.56 | 0.76–0.79 | 5.1–6.1 | 2.3–2.6 | 5.0–5.4 |
| Tugboats | 0.61–0.68 | 0.75–0.85 | 0.50–0.58 | 0.79–0.84 | 3.8–4.5 | 2.4–2.6 | 4.0–4.6 |
| Bulk carriers | 0.79–0.84 | 0.990– 0.997 | 0.72–0.86 | 0.88–0.92 | 5.0–7.1 ^a | 2.1–3.2 | 4.7–5.6 |
| Tanker $F_n = 0.15$ | 0.835– 0.855 | 0.992– 0.996 | 0.82–0.88 | 0.88–0.94 | 5.1–6.8 | 2.4–3.2 | 4.5–5.6 |
| Tankers $F_n = 0.16–0.18$ | 0.79–0.83 | 0.992– 0.996 | 0.78–0.86 | 0.88–0.92 | 5.0–6.5 | 2.2–2.9 | 4.5–5.2 |
| Fast seagoing reefers | (0.55) ^c 0.59– 0.62 | 0.96–0.985 | (0.53) ^c 0.57– 0.59 | 0.68–0.72 | 6.7–7.2 | 2.8–3.0 | 6.1–6.5 |

^a For $L > 100$ m

^b For $L = 80–95$ m

^c $C_p, C_B < 0.57$

Table 2.5 Hull form coefficients and ratios of main dimensions for merchant ships (synthesis of original data by Strohbusch, 1971, updated by use of IHS Fairplay World Shipping Encyclopedia, v. 12.01, 2011). Given upper and lower boundaries correspond to the standard deviation from the regression line of sample ships, as shown in Appendix A

| Ship type | Ratio of main dimensions | | |
|---------------------------------|--------------------------|-------------------------|----------------------|
| | L_{PP}/D | $F_{FP} \cdot \%L_{PP}$ | $L_p \cdot \%L_{PP}$ |
| Fast seagoing cargo ships | 9.9–13.5 | 5.1–6.3 | 20–25 |
| Slow seagoing cargo ships | | 5.8–7.0 | 30–35 |
| Coastal cargo ships | 10.0–12.0 | up to 7.0 | 40–50 |
| Small short sea passenger ships | 10.4–11.6 | 6.6–7.9 | 20–25 |
| Ferries | 8.6–10.3 | 7.0–10.0 | 25–35 |
| Fishing vessels | 8.2–9.0 | 8.0–8.5 | 15–25 |
| Tugboats | 7.7–10.0 | 8.2–10.2 | 20–30 |
| Bulk carriers | 10.5–12.8 | 4.4–4.9 | 50–60 |
| Tankers $F_n = 0.15$ | 12.0–14.0 | 3.6–4.5 | 50–60 |
| Tankers $F_n = 0.16–0.18$ | 10.5–12.8 | 4.4–4.9 | 50–60 |
| Fast seagoing reefers | –11.0 | 5.6–6.6 | 10–15 |

For both cases C takes the following value:

$$C = 3.2 \quad \text{for } C_B = 0.145 / F_n$$

$$= 3.2 \frac{C_B + 0.5}{(0.145 / F_n) + 0.5} \quad \text{for } C_B \neq 0.145 / F_n$$

The above constraints in the formula for the C_B are understood approximately.

The basic limitations for applying the above empirical formula are as following:

1. $\Delta \geq 1,000$ t.
2. V corresponding to $0.16 \leq F_n \leq 0.32$.
3. C_B within the boundaries $0.48 \leq C_B \leq 0.85$.
4. Proportional correction of the constant C (increase) for restrictions on B and T and high ratio of volume below D to displaced volume (∇_D / ∇).
5. Correction of constant C (decrease) for the existence of optimized bulbous bow.

The constant C can be alternatively calculated by using the following formula (Friis et al. 2002):

$$C = 3.4 - (\Delta - 10^3) / 10^6 \quad \text{for } 1,000 \text{ t} \leq \Delta \leq 201,000 \text{ t}$$

$$= 3.2 \quad \text{for } \Delta > 201,000 \text{ t}$$

The above formula by Schneekluth (1985) is the result of statistical analysis of data of optimized ships with respect to only construction cost. However, taking into account as well the operating cost, which is equally important for the owner's interests, an increase of about 10% of the length resulting from the above formula is recommended (which leads to lower resistance, reduced propulsive power and fuel cost).

c. Formulas from statistical analyses of data of existing ships⁸

1. Ayre's formula for length estimation:

$$L_{pp} / \nabla^{1/3} = 3.33 + 1.67 V / \sqrt{L_{pp}} \quad (2.46)$$

2. Posdunine/V. Lammeren's formula for length estimation

$$L_{WL} / \nabla^{1/3} = CV / (V + 2)^2 \quad (2.47)$$

where

- C = 7.62 (all types, Posdunine)
 = 7.16 (cargo ships, V. Lammeren)
 = 7.32 (fast twin-screw ships, V. Lammeren)
 = 7.92 (fast passenger ships, V. Lammeren)

3. Völker's formula for length estimation

$$L_{pp} / \nabla^{1/3} = C_1 + 4.5V / \sqrt{g \cdot \nabla^{1/3}} \quad (2.48)$$

⁸ All below formulas refer to the data of old ships; they deliver in general larger lengths than used today in practice; they are, however, a good yardstick for evaluating possible ship lengths at the conceptual design stage.

where

- C_1 = 3.5 for dry bulk cargo ships/containerships
 = 3.0 for reefer ships
 = 2.0 for fishing/short sea cargo ships.

Notes on units in formulas 1 to 3 (Eqs. 2.46, 2.47, 2.48):

1. L (m); V (kn)
 2. ∇ : displaced volume (m^3); V (kn)
 3. g (m/s^2): gravitational acceleration; V (m/s): design speed (service)
- d. Use of diagrams for various types of ships
1. Figure 2.24: Relation of L_{pp} and of $L \cdot B \cdot D$ to the required hold capacity for tankers (Lamb 2003).
 2. Figure 2.25: Relation of the ratios L_{pp}/B and L_{pp}/D to the required hold capacity for tankers (Lamb 2003).
 3. Figure 2.26: Relation of the L_{pp} (B and D) to the required hold capacity ∇_{REQ} for cargo ships according to Watson and Gilfillan (1976).

Instructions for use graph 2.26

- 3.1. Estimation of ∇_{REQ} based on the required capacity GRAIN (+1 to +2%) or BALE (+11 to +12%), for example 20,000 m^3 .
 - 3.2. Assumption of L/B and B/D based on similar ships, for example $L/B=6.5$ and $B/D=1.8$.
 - 3.3. Assume the engine room position to be abaft or 3/4 of length abaft; here, for example, 3/4 L abaft amidships.
 - 3.4. Find hull's total volume below the main deck (abscissa) ∇_H , for example 27,560 m^3 , and the corresponding engine room volume, $\nabla_M = \nabla_H - \nabla_R$, for example, 7,560 m^3 .
 - 3.5. Find the product of ($L \times B \times D$) (ordinate), for example 38,760 m^3 , based on the approximation of the block coefficient C_{BD} at the height of D , for example 0.70. The latter may be estimated based on C_B , for the draft T , see 2.9, and use of the side graph of Fig. 2.26 (bottom left of Fig. 2.26).
 - 3.6. Find the main dimensions of L_{pp} , B , and D from the side graph of Fig. 2.26 (top left), for example $L_{pp} = 139.8$ m, $B = 21.5$ m, $D = 12$ m, where the straight lines $L/B=6.5$ and $B/D=1.8$ can be replaced with other values, which correspond to respective similar ships.
4. Figure 2.27: Approximations of L_{pp} , coefficient $L \cdot B \cdot D$ and the ratio L_{pp}/B for ships carrying standardized containers as a function of the total number of transported TEU containers (Twenty Feet Equivalent Unit ISO standardized boxes of 20 ft length, 8 ft breadth and 8 (8.5) ft height).
 5. Figure 2.28: Relation of the displacement Δ to the length L_{pp} (a), the coefficient $L \cdot B \cdot D$ to the installed power (b), and the ratio L/D to the waterline length L_{WL} (c) for tugboats (Lamb 2003).
 6. Figure 2.29: Relation of the main dimensions and other characteristics for North Sea fishing vessels to the volume of fish hold (refrigerated hold) (Henschke 1964).

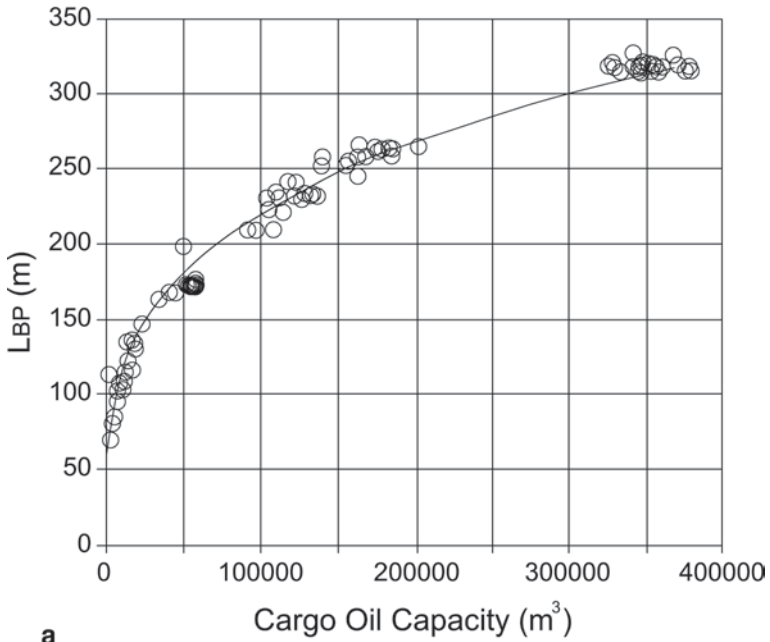

a

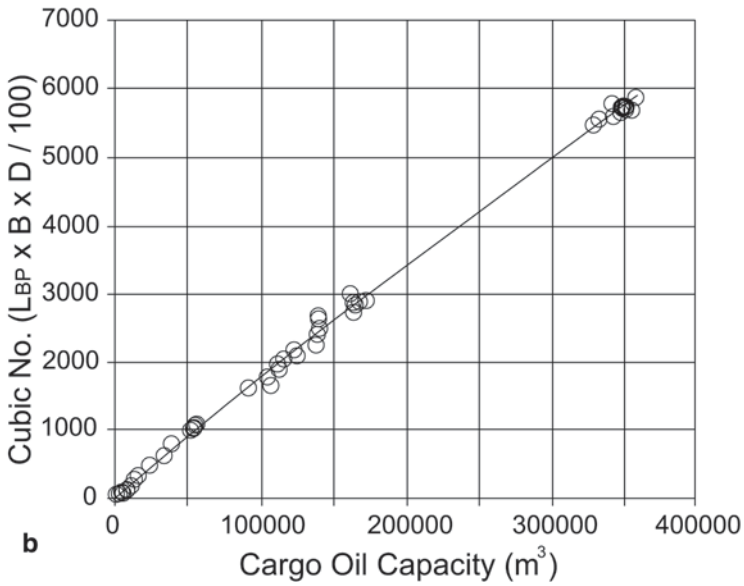

b

Fig. 2.24 Relations of L_{pp} and volumetric numeral $L \times B \times D$ to the hold capacity for tankers. (Lamb 2003)

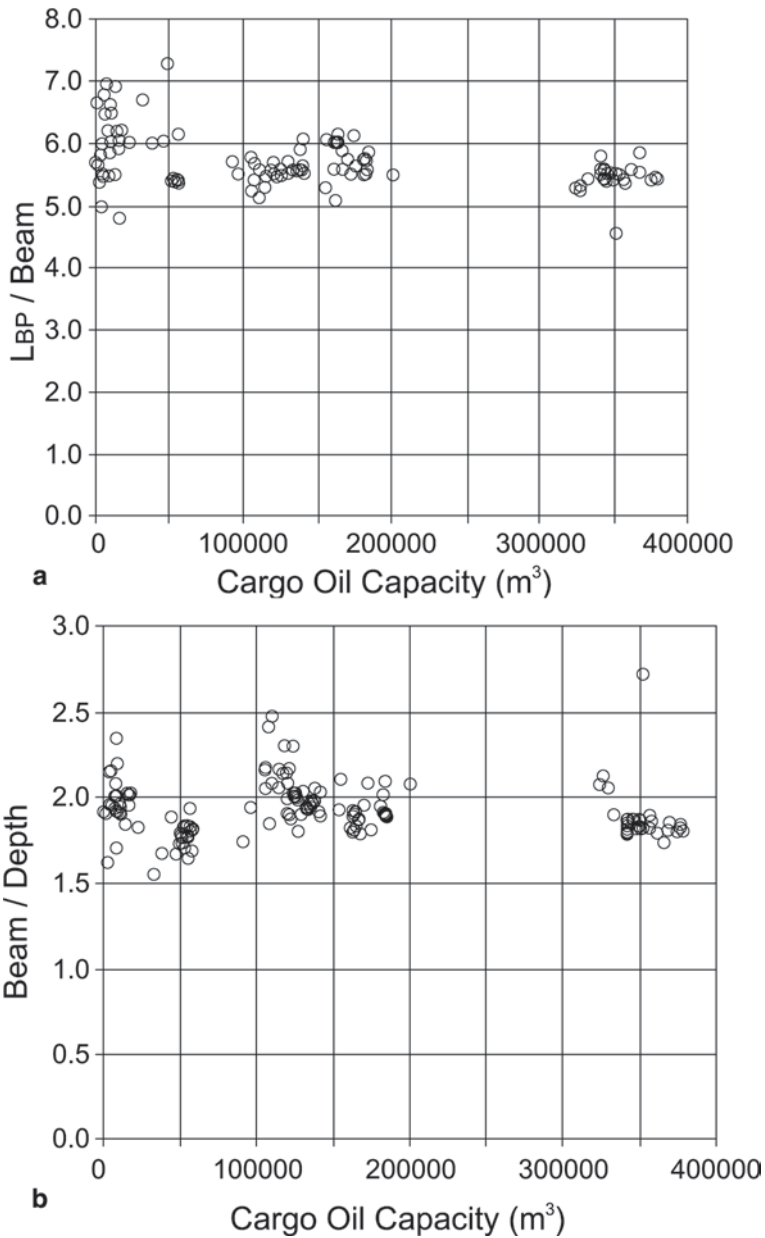

Fig. 2.25 Relation of the ratios L_{pp}/B . **a** and L_{pp}/D . **b** to the hold capacity for tankers. (Lamb 2003)

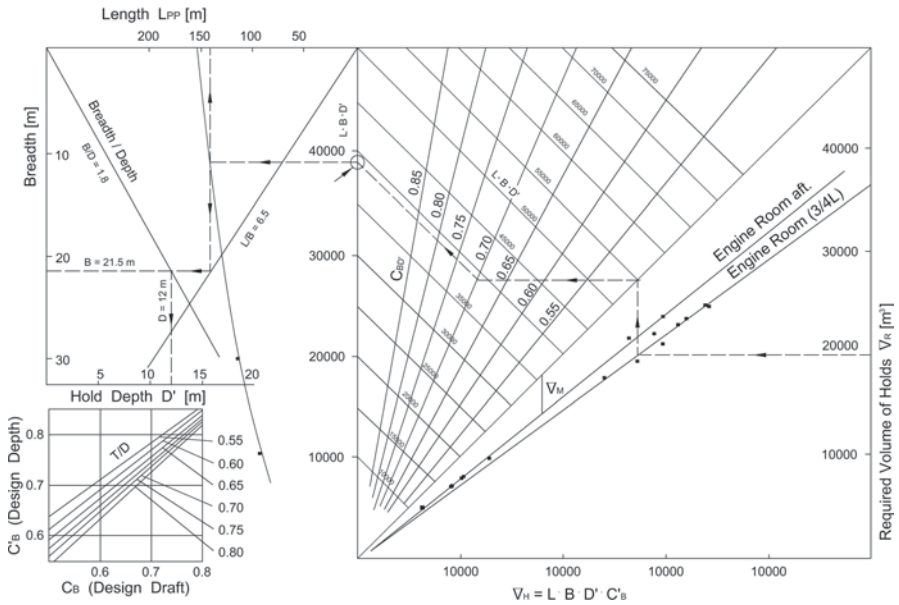
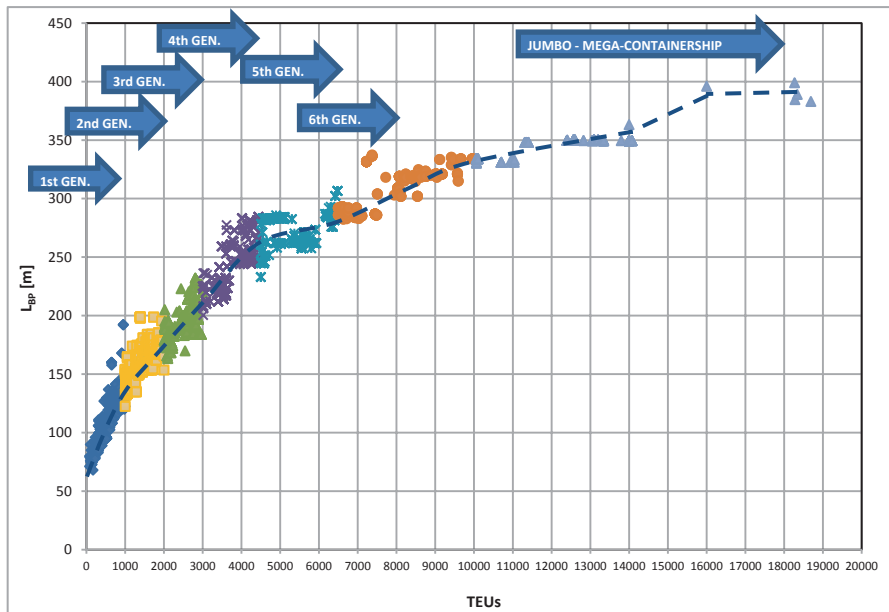
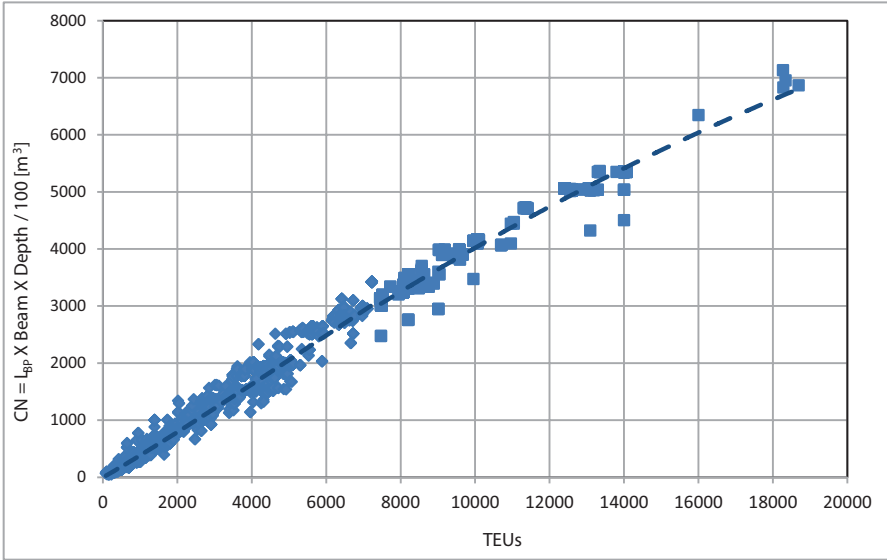

Fig. 2.26 Determination of main dimensions based on the required hold capacity under main deck ∇_R according to Watson and Gilfillan (1976), for $L/B=6.5$ and $B/D=1.8$



a

Fig. 2.27 Relations of (a) length L_{pp} (b) volumetric numeral $L \cdot B \cdot D$ and (c) the ratio L_{pp}/B to the total number of transported TEU containers for containerships. (Papanikolaou 2014)



b

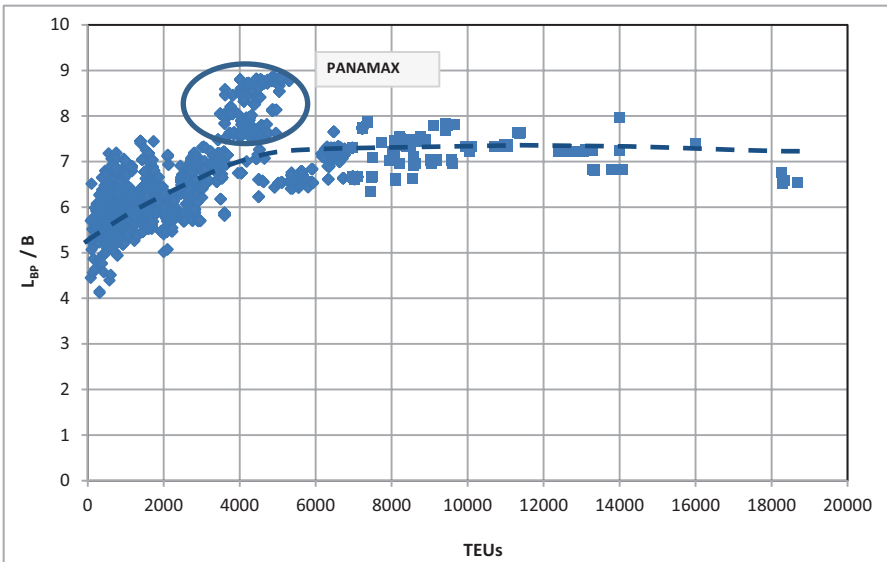

c

Fig. 2.27 (continued)

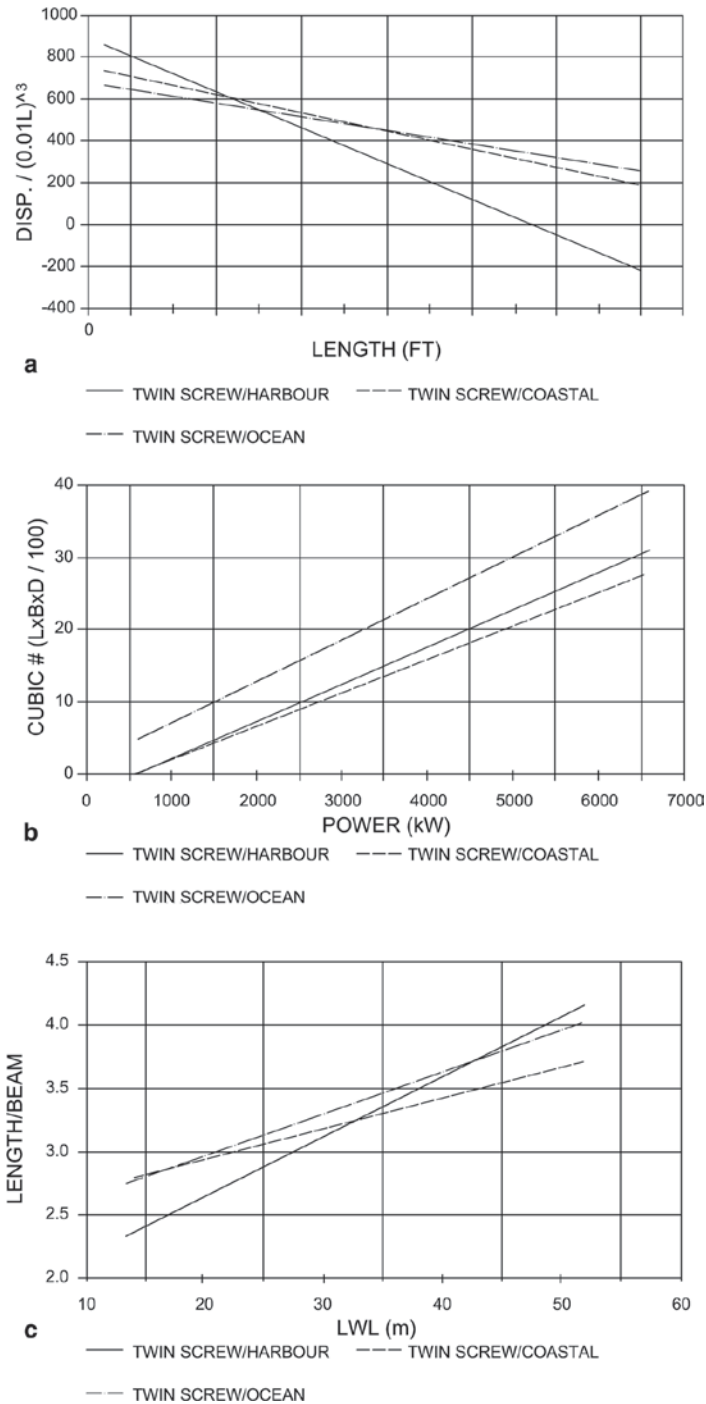

Fig. 2.28 (a) Relation of displacement with the length L_{pp} , (b) the volumetric numeral $L \cdot B \cdot D$ with the installed power and (c) the ratio L/B with the waterline length L_{WL} for tugboats. (Lamb 2003)

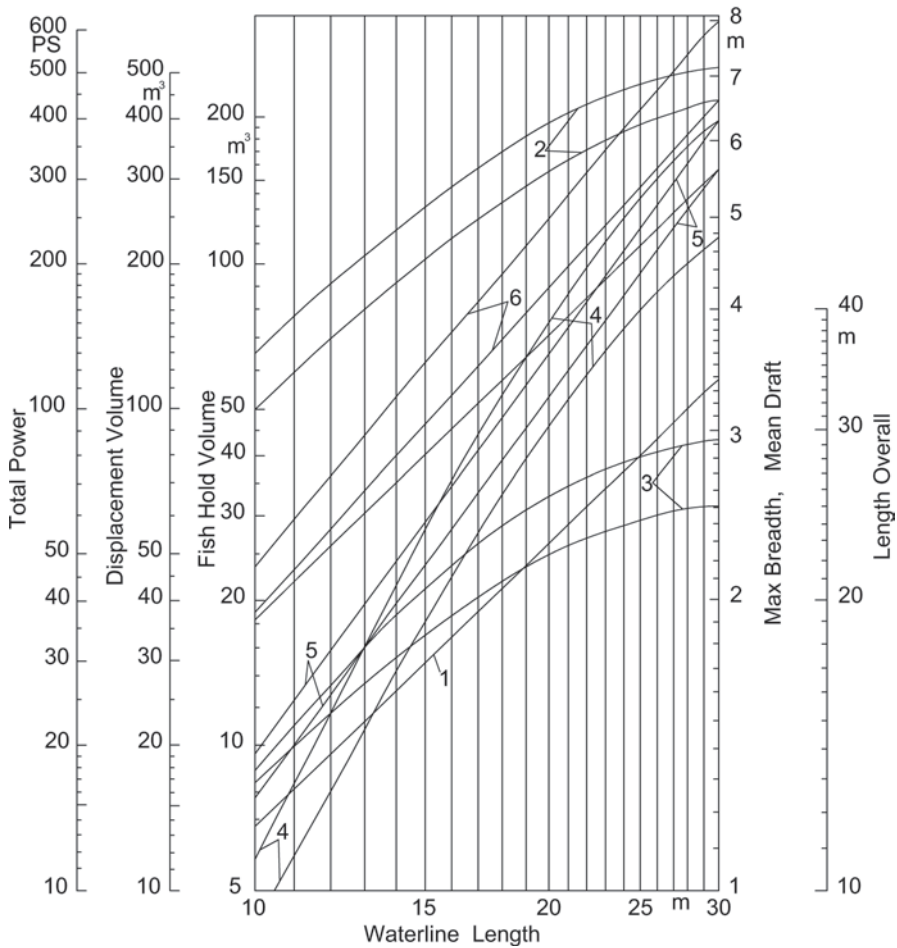

Fig. 2.29 Relationships of the length L_{WL} to other dimensions and basic characteristics for North Sea fishing vessels. (Henschke 1964). (1. Overall length, 2. Beam (maximum), 3. Average draft, 4. Fish hold volume, 5. Displaced volume, 6. Installed engine power)

7. Figure 2.30: Relation of L_{pp} , B , and D to the refrigerated hold capacity for fishing ships (Lamb 2003).
 8. Figure 2.31: Relation of L_{OA} , B , and T to deadweight for Chemical Tankers (Lamb 2003).
 9. Figure 2.32: Statistical averages of slenderness coefficients of oceangoing ships according to Völker (1974).
- e. Recommended procedure for the determination of length

e1. Approximation of L based on the slenderness coefficient (see procedures (a) and (c))

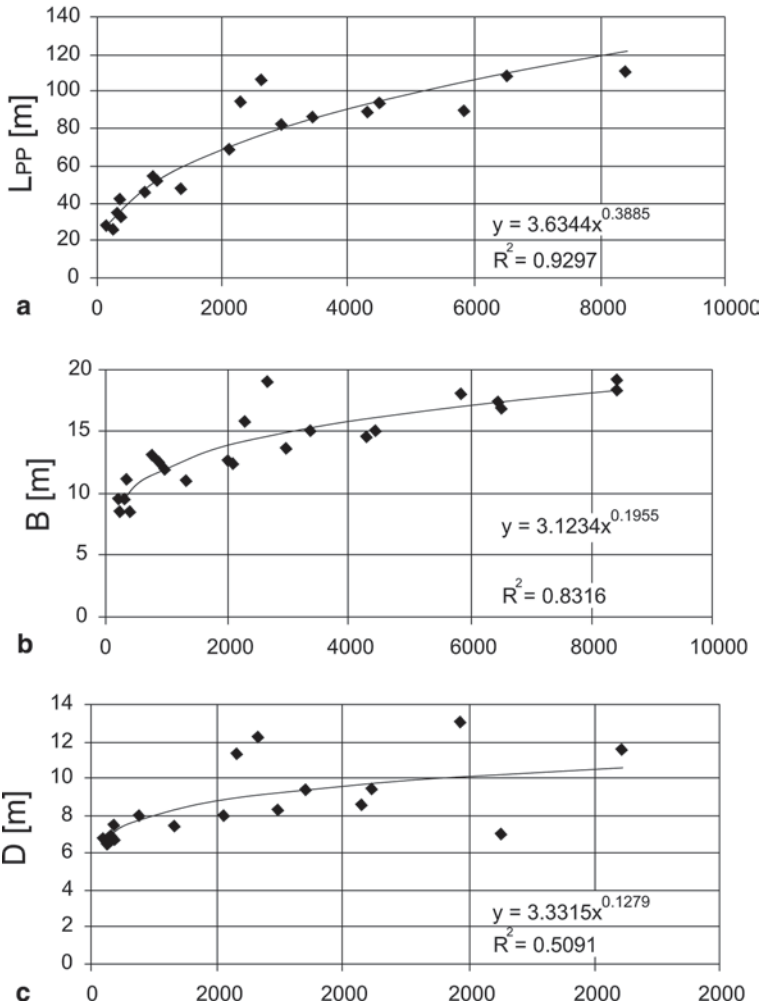

Fig. 2.30 Relationships of length L_{pp} , beam B , and side depth D to refrigerated hold capacity for fishing vessels. (Lamb 2003). (length (m) (a), beam (m) (b), side depth (m) (c))

- e2. Examination of the resultant L based on the “least cost” formula according to Schneekluth (b)
- e3. Examination of the resultant L based on the empirical diagrams (d)
- e4. Examination and adjustment of L with regard to the physical, passing constraints: physical limits of channels, canals, ports, slipways, or docks of the shipyards

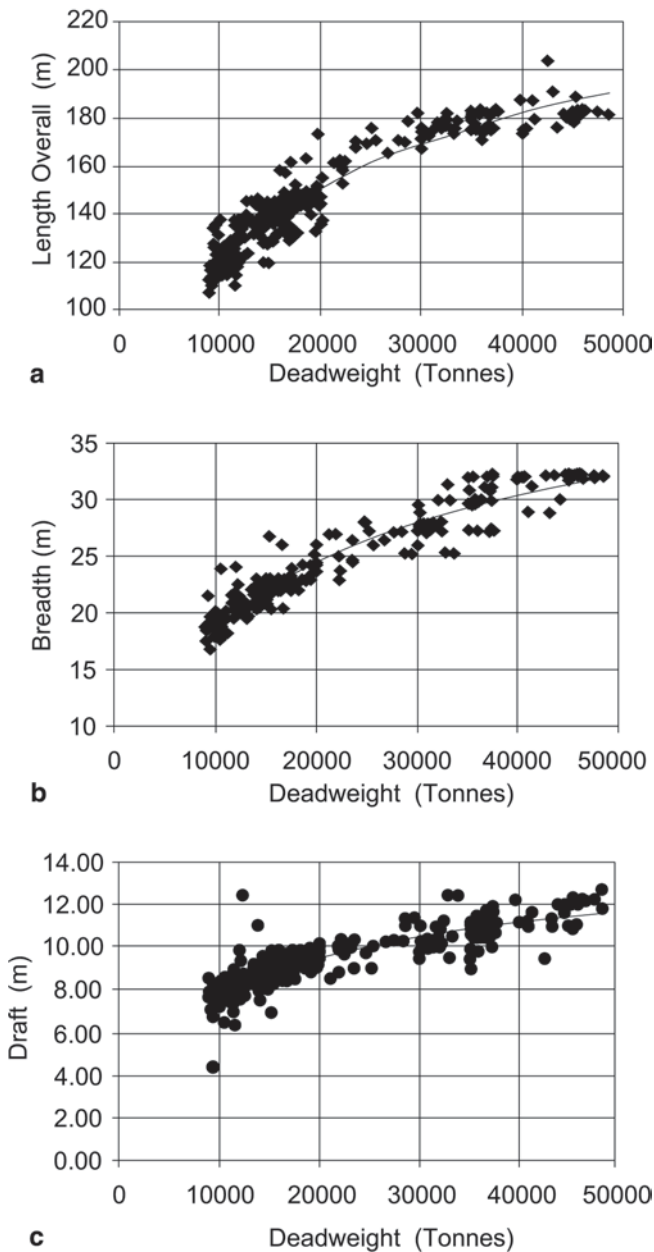

Fig. 2.31 Relationships of length L_{OA} (a), beam B (b), and draft T (c) to deadweight for chemical tankers. (Lamb 2003)

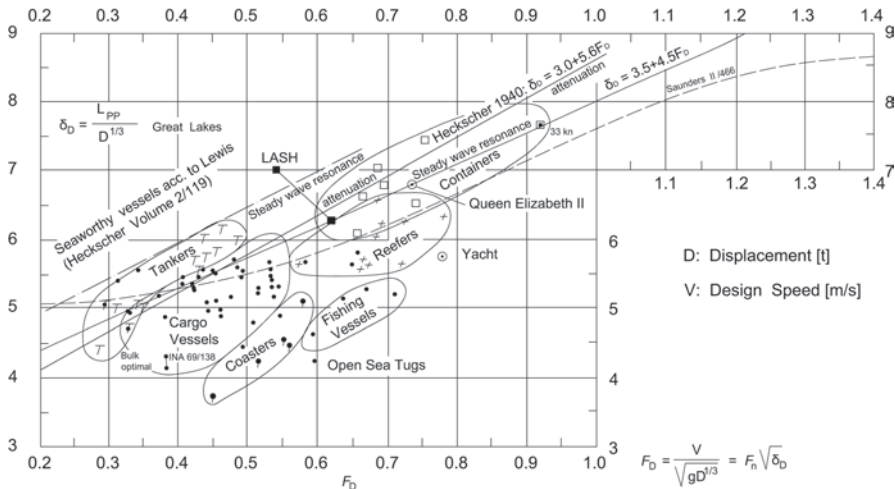

Fig. 2.32 Average slenderness coefficients of ocean-going ships according to Völker (1974)

- e5. Examination of L with respect to the required number of transverse bulkheads according to the specifications of a recognized classification society⁹; possible adjustment of the length in cases of marginal exceedance of the limit for certain required number of bulkheads (bulkhead/steel weight savings)
- e6. Examination of L , in conjunction with side depth D , regarding the ratio of (L/D) that needs to be below certain limit according to the rules of specific classification society
- e7. Examination of L with respect to the possible occurrence of resonance of ship motions in typical waves in the region of operation (to avoid $\lambda_w \sim L$); this only applies to vessels with special requirements in terms of seakeeping, such as passenger ships and naval ships in general
- e8. Examination of L with respect to the superposition of the generated bow wave, stern wave and shoulder waves for certain speeds of the ship due to possible excessive increase of wave resistance; indirectly, examination of the appropriateness of the operational Froude number

In the preliminary design stage, the above process is limited to the first six steps only (1–6).

⁹ Every ship must have at least one collision bulkhead, one after peak bulkhead, and one bulkhead at the fore and aft boundaries of the engine room. In case the engine room is placed astern, the after-peak bulkhead coincides with the aft bulkhead of the engine room. The total number of bulkheads as a function of ship's length L in accordance with the regulations of, for example, Lloyd's Register is as follows:

$L \leq 65$ m, $N=3$ (4); $65 \text{ m} < L \leq 85$ m, $N=4$ (4); $85 \text{ m} < L \leq 90$ m, $N=5$ (5); $90 \text{ m} < L \leq 105$ m, $N=5$ (5); $105 \text{ m} < L \leq 115$ m, $N=5$ (6); $115 \text{ m} < L \leq 125$ m, $N=6$ (6); $125 \text{ m} < L \leq 145$ m, $N=6$ (7); $145 \text{ m} < L \leq 165$ m, $N=7$ (8); $165 \text{ m} < L \leq 190$ m, $N=8$ (9); $L > 190$ m, N as appropriate.

The above applies to ships with engine rooms placed astern (in parenthesis the corresponding number of bulkheads for the engine room placed amidships).

2.4 Slenderness Coefficient $L/\nabla^{1/3}$

The Slenderness or sharpness coefficient $L/\nabla^{1/3}$ or the inverse of this value's third power ∇/L^3 which is often referred to as volumetric coefficient (and is preferred in Anglo-Saxon countries), expresses the hull slenderness, especially in combination with the prismatic coefficient C_p . Generally, high values of slenderness coefficient and low C_p values imply fine-lined hulls generally for fast ships (Fig. 2.33).

2.4.1 Influence on the Ship's Resistance

The influence of the slenderness coefficient on the ship's wave resistance is obvious, especially for fast ships. This can be easily concluded both from the phenomenological point of view (see Sect. 2.3.1), and practically from the application point of view, namely when using well known semiempirical formulas for calculating the residuary resistance, for example according to the method of Guldhammer (FORMDATA), where the slenderness ratio is a basic parameter.

For fast ships, a high slenderness coefficient leads to a reduction of the *intensity* of the generated, ship-bound waves, and consequently of the wave resistance; generally, it contributes to a reduction of the ship's *form* (or residuary) resistance, thus beyond the wave-making resistance also of the pressure viscous resistance.

For relatively slow ships, with low wave resistance percentage values, the requirement for a least wetted surface for given displacement (what minimizes the frictional resistance) leads to a length that is as small as possible and results in ships with small lengths, comparably large beams and drafts, as well as high fullness, that is, high block coefficients and relatively low slenderness coefficients.

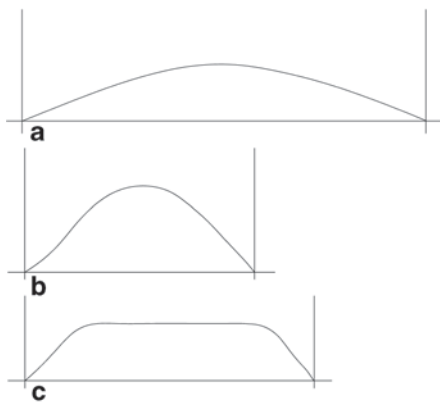

Fig. 2.33 Examples of effect of slenderness ratio and prismatic coefficient on hull form. (a) Fine-lined hull form, high $L_{pp}/\nabla^{1/3}$ and low C_p , typical for fast ocean liners, naval ships etc. (b) Short and sharp at the ends hull form, low $L_{pp}/\nabla^{1/3}$ and low C_p , typical for fishing and offshore support vessels, etc. (c) Full hull form, high $L_{pp}/\nabla^{1/3}$, and high C_p , typical for slow cargo ships, bulkcarriers, tankers etc.

2.4.2 *Effect on the Ship's Structure*

In consistency with the effort to minimize the frictional resistance for relatively slow ships with the distribution of displacement over a relatively short length, large beam, and draft (hence also of side depth), it is concluded that low slenderness coefficients combined with high block coefficients, lead to relatively simple and economical structures. The increased distribution of displacement in the transverse direction may be limited in extreme situations by transverse strength problems that require special transversal strengthening.

2.4.3 *Approximate Values*

Approximate values of the slenderness coefficient for common ship types are given in Tables 2.6 and 2.7 (and in Appendix A).

In the preliminary design phase and especially for deadweight carriers (see Sect. 1.4.2), it is appropriate to preliminarily estimate the length through the slenderness coefficient of similar ships. The resulting length can be examined by well-established empirical or semiempirical formulas (see Sect. 2.3).

2.5 Selection of Other Main Dimensions

After the preliminary estimation of the ship's length (see Sect. 2.3) and of the block coefficient C_B (see more details in Sect. 2.10), as well as of the displacement (see Sect. 2.1) (in the case of deadweight carriers), we commonly proceed with the selection of the beam B and draft T , which are directly related to each other, namely through

$$B \cdot T = \nabla / (L \cdot C_B). \quad (2.49)$$

The basic factor that influences the selection of B and T is at first possible topological limits of the route, that is restrictions on the beam in terms of the passage of canals and channels, for example for Panamax ships (passing through the Panama Canal, $B_{\max} = 32.31$ m/106 ft). Also, there may be limitations for the ship's operational draft due to the ship's approach to river estuaries, transiting through canals or channels, calling at certain ports of limited depth (for example for Panamax ships, $T_{\max} = 12.09$ m or 39 ft, 6 in).

The *minimum* values for the beam are determined by the requirements for adequate stability, while for the draft the main requirement arises from the need of fitting a propeller of as large as possible diameter (for achieving higher efficiency). This applies particularly to ships of increased towing power (like tugboats and fishing vessels).

Table 2.6 Hull form coefficients and ratios of main dimensions for merchant ships (synthesis of original data by Strohbusch, 1971, updated by Papanikolaou by use of IHS Fairplay World Shipping Encyclopedia, v. 12.01, 2011). Given upper and lower boundaries correspond to the standard deviation from the regression relationship of sample ships, as shown in Appendix A.

| Ship type | Hull form coefficients | | | | Ratios of main dimensions | | |
|---------------------------------|--------------------------------------|-----------------|--------------------------------------|-----------|--|---------|--|
| | C_p | C_M | C_B | C_{WP} | L/B | B/T | $L_{pp}/\nabla^{1/3}$ |
| Fast seagoing cargo ships | 0.57–0.65 | 0.97–0.98 | 0.56–0.64 | 0.68–0.74 | 5.7–7.8 | 2.2–2.6 | 5.6–5.9 |
| Slow seagoing cargo ships | 0.66–0.74 | 0.97–0.995 | 0.65–0.73 | 0.80–0.86 | 4.8–8.5 | 2.1–2.3 | 5.2–5.4 |
| Coastal cargo ships | 0.69–0.73 | -0.985 | 0.58–0.72 | 0.78–0.83 | 4.5–5.5 | 2.5–2.7 | 4.2–4.8 |
| Small short sea passenger ships | 0.61–0.63 | 0.82–0.85 | 0.51–0.53 | 0.65–0.70 | 5.8–6.5 | 3.3–3.9 | 6.3–6.6 |
| Ferries | 0.53–0.62 | 0.91–0.98 | 0.50–0.60 | 0.69–0.81 | 5.9–6.2 ^a 5.2–5.4 ^b | 3.7–4.0 | 6.2–6.9 ^a 5.7–5.9 ^b |
| Fishing vessels | 0.61–0.63 | 0.87–0.90 | 0.53–0.56 | 0.76–0.79 | 5.1–6.1 | 2.3–2.6 | 5.0–5.4 |
| Tugboats | 0.61–0.68 | 0.75–0.85 | 0.50–0.58 | 0.79–0.84 | 3.8–4.5 | 2.4–2.6 | 4.0–4.6 |
| Bulk carriers | 0.79–0.84 | 0.990– 0.997 | 0.72–0.86 | 0.88–0.92 | 5.0–7.1 ^a | 2.1–3.2 | 4.7–5.6 |
| Tankers $F_n=0.15$ | 0.835– 0.855 | 0.992– 0.996 | 0.82–0.88 | 0.88–0.94 | 5.1–6.8 | 2.4–3.2 | 4.5–5.6 |
| Tankers $F_n=0.16–0.18$ | 0.79–0.83 | 0.992– 0.996 | 0.78–0.86 | 0.88–0.92 | 5.0–6.5 | 2.2–2.9 | 4.5–5.2 |
| Fast seagoing reefers | (0.55) ^c 0.59– 0.62 | 0.96–0.985 | (0.53) ^c 0.57– 0.59 | 0.68–0.72 | 6.7–7.2 | 2.8–3.0 | 6.1–6.5 |

^a For $L > 100$ m

^b For $L = 80–95$ m

^c Rarely: $C_p, C_B < 0.57$

Regarding the influence of B/T ratio on resistance, the frictional resistance, which is directly related to the wetted surface of the hull, is minimized for a B/T value around 2.5 and approximately the same applies to the residuary resistance, if there are no other restrictions or requirements on the absolute B and T values.

Thus the B/T ratio is usually selected close to 2.5 and possible exceedances are usually due to restrictions relating to limitations of the draft (always occurring for large tankers and bulk carriers) or due to particular, enhanced requirements on stability (for example for ROPAX ships). Note that significantly smaller values than 2.5 are rare.

The beam can be determined based on the L/B ratio of similar ships (see Table 2.6) and following this the draft T can be approximated through the chosen

Table 2.7 Hull form coefficients and ratios of main dimensions for merchant ships (synthesis of original data by Strobusch, 1971, updated by use of IHS Fairplay World Shipping Encyclopedia, v. 12.01, 2011). Given upper and lower boundaries correspond to the standard deviation from the regression line of sample ships, as shown in Appendix A

| Ship type | Ratio of main dimensions | | |
|---------------------------------|--------------------------|------------------|---------------|
| | L_{pp}/D | $F_{FP}\%L_{pp}$ | $L_p\%L_{pp}$ |
| Fast seagoing cargo ships | 9.9–13.5 | 5.1–6.3 | 20–25 |
| Slow seagoing cargo ships | | 5.8–7.0 | 30–35 |
| Coastal cargo ships | 10.0–12.0 | up to 7.0 | 40–50 |
| Small short sea passenger ships | 10.4–11.6 | 6.6–7.9 | 20–25 |
| Ferries | 8.6–10.3 | 7.0–10.0 | 25–35 |
| Fishing vessels | 8.2–9.0 | 8.0–8.5 | 15–25 |
| Tugboats | 7.7–10.0 | 8.2–10.2 | 20–30 |
| Bulk carriers | 10.5–12.8 | 4.4–4.9 | 50–60 |
| Tankers $F_n=0.15$ | 12.0–14.0 | 3.6–4.5 | 50–60 |
| Tankers $F_n=0.16-0.18$ | 10.5–12.8 | 4.4–4.9 | 50–60 |
| Fast seagoing reefers | –11.0 | 5.6–6.6 | 10–15 |

B/T ratio. The influence of L/B on the ship's resistance is not straightforward, like that of the slenderness coefficient $L/\nabla^{1/3}$, though one would generally expect that a lower L/B ratio affects negatively ship's wave resistance. However, for a given draft T , length L and displacement, an *increase* of beam B , or *reduction* of the ratio L/B , means *reduction* of the block coefficient C_B and consequently *possible reduction* of the total resistance (see example, see Sect. 2.6.2).

The above considerations apply mainly to “normal” general dry cargo ships or liquid cargo ships without special requirements in terms of the transported cargo type or stability. However, for cargo ships transporting standardized/unitized cargos of fixed size (*linear dimension ships*), for example containerhips, Ro-Ro, etc., the beam generally changes stepwise, depending on the number of transversely stowed standardized (unitized) cargo, for example for *containerhips of about Panamax size*:

$$B \cong 3n + 2.2\text{m} \quad (2.50)$$

where n is the number of transversely stackable standardized containers under deck (TEU containers; standard cross-section in feet: $8' \times 8'$ and up to $8.0' \times 8.5'$).

The beam's influence on stability, especially on the initial stability (metacentric height GM) is drastic, given that a small increase of beam leads to significant increase of BM (see Sect. 2.6).

Regarding the selection of draft, the factors that have significant influence are briefly listed as follows:

- Large draft contributes to the selection of propellers of higher efficiency due to the possible fitting of a large diameter propeller (low thrust/load coefficient) and low number of propeller revolutions (rpm); it allows, also the fitting of larger rudders for improved maneuverability.

- Large draft requires strengthening of the ship's structural elements in the bottom area and lower hull shell.
- The resulting *freeboard* of the ship, defined as the difference between the selected draft and the upper side of the bulkhead deck (side depth D), must be in any case *greater* than the resultant *minimum* freeboard value derived from application of the International Load Line Convention regulations.

As to stability, the influence of an *increase* of draft is complicated and is certainly associated with possible changes of other dimensions, that is, of the ship's length and in particular the ship's beam:

- If other ship sizes (such as L , B , and water plane area) are assumed fixed, but the displacement increases (*due to the draft increase*), then the metacentric radius \overline{BM} will decrease. The same will happen even more drastically, if for a given displacement and length, the beam of the ship decreases in parallel to the increase of the draft (in order to keep the block coefficient unchanged).
- If the side depth remains fixed and the freeboard is at acceptable level, the maximum value and the range of the righting arm *will decrease* due to premature immersion of the deck edge into water. For certain hulls, where the immersion of the deck follows the emergence of the bottom, just the opposite may happen.
- An increase of the distance of the center of buoyancy from the base leads to increased \overline{KB} ; thus, a possible reduction of \overline{BM} may be partially balanced by the increase of \overline{KB} resulting in an increase or decrease of \overline{KM} depending on the hull form.

A large draft may be excluded due to topological limiting requirements of routes.

A useful formula for the selection of B and T through the ratio (L/B) is concluded from an algebraic processing of the definition of C_B :

$$\nabla = L \cdot B \cdot T \cdot C_B = L^3 \cdot C_B / [(L/B)^2 \cdot B/T] \Rightarrow B/T = \frac{L^3 C_B}{(L/B)^2 \nabla} \quad (2.51)$$

which in combination with the equation

$$B \cdot T = \frac{\nabla}{L \cdot C_B} \quad (2.52)$$

leads to the values for B and T (two equations for two unknowns).

The effect of changing B and T by δB and δT , respectively on the stability can simply be examined on the basis of the resulting changes of the metacentric radius \overline{BM} (see Sect. 2.6) :

$$\frac{\delta \overline{BM}}{\overline{BM}} = 3 \frac{\delta B}{B} - \frac{\delta T}{T} \quad (2.53)$$

For fixed ∇ and T , the approximation formula may be simplified:

$$\frac{\overline{\delta BM}}{\overline{BM}} = 3 \frac{\delta B}{B} \quad (2.54)$$

and assuming \overline{KG} unchanged ($\overline{\delta KG} = 0$) the following important formula is derived:

$$\overline{\delta(GM)} = \overline{\delta(BM)} = \overline{BM} \cdot 3 \frac{\delta B}{B} \quad (2.55)$$

Therefore, an *increase of beam* by 10% leads approximately to an *increase of \overline{GM}* by 30%.

Finally, for the selection of the side depth D the key point is to achieve the required hold volume of the ship and to satisfy the Load Line regulations, namely, to reach the required minimum freeboard. Other influential factors are as follows:

- An increase of the side depth D involves an increase of the ship's gravity center \overline{KG} and consequently a reduction of \overline{GM} (negative influence on the *initial stability*). However, as to the *large angle stability*, we have an increase of the *range of the righting lever* due to the delayed immersion of the side deck and of the superstructures in water.
- An increase of D involves an increase in the modulus of the midship section. Therefore, for fixed L , due to the reduction of the occurring bending stresses on the ship's extremes (deck and bottom), there is a possibility to reduce the thickness of the plating and hence of the weight of the steel structure (see Sect. 2.7).

The L/D ratio can be selected from similar ships or in accordance with typical values of Table 2.7.

2.6 Selection of Beam

As has been pointed out earlier, the proper procedure of selecting the ship's main dimensions and of other fundamental ship values is to proceed, after the determination of the length, with the selection of the block coefficient C_B and thereafter of the beam, together with the draft. The selection of the C_B coefficient will be elaborated later in Sect. 2.10.

Assuming that the length L and the block coefficient C_B are known (predetermined), as we may assume this also for the ship's displacement Δ in first approximation (and for the corresponding displaced volume ∇), then the following relationship holds for the product $B \cdot T$:

$$B \cdot T = \frac{\nabla}{L \cdot C_B}$$

that is the selection of beam B can be accomplished on the basis of the product $B \cdot T$. Thereby changes of the beam require inversely proportional changes in the draft and indirectly of the side depth D (due to the minimum freeboard requirements).

Alternatively, the beam selection can be done through the L/B ratio, either by using data of similar ships (see Table 2.7), as explained previously, or by using some relationships, which are presented below and are deduced from the analysis of data of ships built in the 1990s. These relationships provide the L/B ratio as a function of length L (m) (Friis et al. 2002).

For cargo ships with $50 \leq L \leq 200$ m:

$$L / B = 4 + 0.015 \cdot (L + 17) \quad (2.56)$$

For reefer ships with $60 \leq L \leq 180$ m:

$$L / B = 4 + 0.014 \cdot (L + 11) \quad (2.57)$$

For containerships with $100 \leq L \leq 200$ m:

$$L / B = 4 + 0.009 \cdot (L + 42) \quad (2.58)$$

For containerships with $L > 200$ m:

$$6.5 \leq L \leq 7.1$$

For bulk cargo carriers with $L \geq 120$ m:

$$L / B = 6$$

For tankers:

$$L / B = 5.5$$

For LPG and LNG ships with $L \geq 100$ m:

$$L / B = 5.7 + 0.002 \cdot (L - 100) \quad (2.59)$$

For Ro-Ro cargo ships with $L \geq 80$ m:

$$L / B = 5.5 + 0.0036 \cdot (L - 41) \quad (2.60)$$

For ROPAX ships with $L \geq 80$ m:

$$L / B = 5.5 + 0.0033 \cdot (L - 141) \quad (2.61)$$

Similar set of data and relationships for various types of ships are also listed in Appendix A.

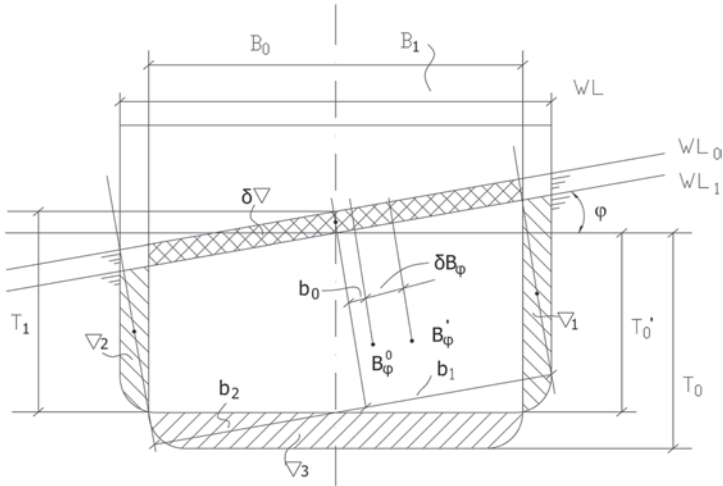

Fig. 2.34 Effect of change of beam on transverse stability

2.6.1 Effect of Beam on the Ship's Stability

To examine the influence of a change of the beam on stability, it is considered that the increase of beam is accompanied by a corresponding reduction of the draft, so that the displacement remains unchanged (see Fig. 2.34).

The ship is examined as inclined at an angle φ and with an initial waterline WL_0 and center of buoyancy B_0^o . At first, an increase of the beam implies an increase of the displaced volume by $(\nabla_1 + \nabla_2)$. However, it is considered that the ship's draft decreases accordingly, namely becoming T_0' , so that the corresponding lost displaced volume ∇_3 balances the above increase ($\nabla_3 = \nabla_1 + \nabla_2$).

The increase of the beam involves though an increase of the ship's steel weight by W_4 , if we request an unchanged level of the ship's strength with respect to a maximum level of stresses on the ship's structure (see Sect. 2.6.3). This results in a new, weight increasing change of the ship's draft to the level of T_1 and the difference between the new and initial displacement (before the beam increase) is:

$$\delta W = W_1 + W_2 - W_4 \tag{2.62}$$

where

$W_1 = w \cdot \nabla_1$, $W_2 = w \cdot \nabla_2$, w : specific water density
 W_4 : increase of steel weight due to increase of beam

Considering b_0 , b_1 , and b_2 , namely the distances of the exerting centers of buoyancy of volumes $\delta \nabla$, ∇_1 , and ∇_2 from the vertical line, which passes through the original center of buoyancy, we find for the shift of B_0^o :

$$\delta B_{\phi} = \frac{W_1 \cdot b_1 - W_2 \cdot b_2 + \delta W \cdot b_0}{W_0 + W_4} \quad (2.63)$$

where

$W_0 = w \nabla_0$: initial displacement,
 $W_0 + W_4$: new displacement.

If it is assumed that there is no change of displacement, that is there is no weight increase W_4 from the beam increase, because, for example, of a possible simultaneous reduction of the ship's side depth, it is concluded:

$$\delta W = W_1 + W_2$$

and

$$\delta B_{\phi} = \frac{W_1 \cdot b_1 - W_2 \cdot b_2 + \delta W \cdot b_0}{W_0}$$

The influence of an increase of the beam on the ship's initial stability, that is the \overline{GM} , can be analyzed as follows.

We consider that the ratio of change of beam $\beta = B_1/B_0$ is given; furthermore, the displacement and the other main dimensions L and T remain fixed. Then, the vertical prismatic coefficient C_{PV} remains unchanged:

$$(C_{PV})_1 = \frac{\nabla_1}{A_{WP1} \cdot T_1} = \frac{(C_B)_1}{(C_{WP})_1} = (C_{PV})_0 = \frac{(C_B)_0}{(C_{WP})_0}$$

Thus the block coefficient due to the beam increase is concluded:

$$(C_B)_1 = \frac{\nabla_1}{L_1 B_1 T_1} = \frac{\nabla_0}{\beta L_0 B_0 T_0} = \frac{(C_B)_0}{\beta} \quad (2.64)$$

and accordingly the water plane area coefficient:

$$(C_{WP})_1 = (C_{WP})_0 \cdot \beta^{-1}.$$

Recalling the well-known relation:

$$\overline{GM} = \overline{KB} + \overline{BM} - \overline{KG} \quad (2.65)$$

where according to Morrish

$$\overline{KB} \cong T(2.5 - C_{PV})/3 \quad (2.66)$$

or

$$\cong T - (1/3) \cdot \{(T/2) + (\nabla / A_{WP})\} \quad (2.67)$$

and

$$\overline{KG} = k_D \cdot D, \quad (2.68)$$

where k_D : coefficient obtained from similar ships (see Table 2.15, Sect. 2.10.6); it is noted that neither \overline{KB} nor \overline{KG} are directly dependent on the beam B . Thus, looking into the analysis of \overline{BM} :

$$\overline{BM} = I_T / \nabla \quad (2.69)$$

We assume for the moment of inertia of the water plane area about the longitudinal axis:

$$I_T \cong k_T \cdot L \cdot B^3 \quad (2.70)$$

where k_T : form coefficient of specific water plane $\cong 0.04 \div 0.06$ for ordinary water plane of shiplike forms.

For constant values of ∇ , it may be assumed that for small changes of B , the coefficient k_T remains unchanged, thus:

$$(I_T)_1 = k_T \cdot L \cdot B_1^3 = k_T \cdot L \cdot \beta^3 B^3 = (I_T)_0 \cdot \beta^3$$

If we set:

$$(\overline{BM})_1 = (\overline{BM})_0 + \delta(\overline{BM}) = (I_T)_1 / \nabla = \beta^3 (\overline{BM})_0$$

and

$$\begin{aligned} \beta &= (B_0 + \delta B) / B_0 = 1 + \delta B / B \\ \beta^3 &\cong 1 + 3\delta B / B + \dots \end{aligned}$$

it is concluded that:

$$\delta(\overline{BM}) / \overline{BM} = 3 \cdot \delta B / B$$

and if the vertical distribution of weights is assumed unchanged, that is $\delta(\overline{KG}) = 0$, we obtain consequently:

$$\delta(\overline{GM}) = \delta(\overline{BM}) = \overline{BM} \cdot 3\delta B / B$$

Fig. 2.35 Effect of increasing the beam on stability for constant midship section area—premature immersion of deck edge

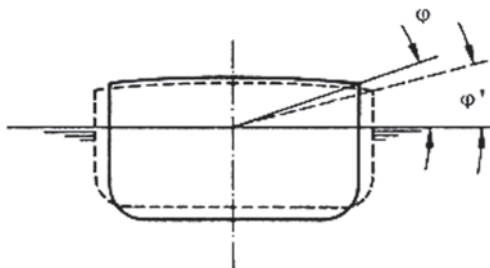

Therefore, it is concluded, from the above hypotheses that an increase of beam by 5% leads approximately to an increase of \overline{GM} by about 15%.

In the above reasoning the draft was considered fixed, but we had a change of C_B by the ratio $1/\beta$. If on the contrary the draft changes by the ratio $(1/\beta)$ and C_B remains fixed, like the displacement, then, with the increase of beam we have a small decrease of \overline{KB} (due to the reduction of T), a drastic increase of \overline{BM} , as above, and finally a relative reduction in \overline{KG} , all this leading again to a significant increase of \overline{GM} .

Regarding the stability at large angles, if in parallel to the beam increase the draft decreases accordingly, and consequently the side depth, so that the displacement remains constant, the edge of the side deck apparently will immerse in water at smaller angles. However, for fixed midship section area but increased B/D ratio, this results in general in an increase of the range of stability as well as in a larger peak value (GZ_{max}) of the righting lever, so as to compensate for the negative effect of the premature immersion of the side deck (Figs. 2.35 and 2.36).

2.6.2 Effect of Beam on the Ship's Resistance

Generally it may be expected that an increase of the ship's beam or the B/T ratio leads to higher resistance (primarily due to the increase of wave resistance) and

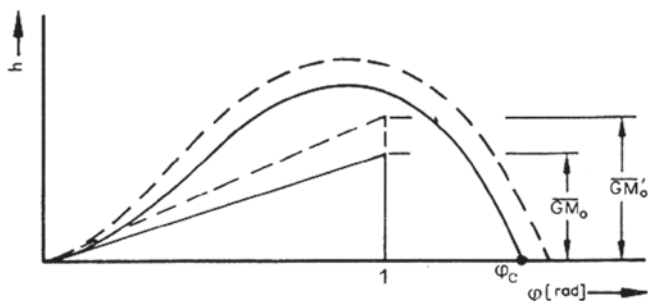

Fig. 2.36 Effect of increasing the beam on righting/restoring arm $h = GZ(\varphi)$: increase of value of initial stability (GM) and usually increase of GZ_{max} and of the range of the stability (increase of angle of vanishing stability φ_C)

hence of the required propulsion power. But such considerations are very general and prove often not true, if other ship dimensional parameters, in addition to B/T , are not taken into account in parallel.

For fast ships with a large proportion of residuary resistance, it has been shown that an increased beam generates more intense free surface disturbances and waves, thus higher wave resistance; this is due to larger inclinations of the waterlines with respect to the ship's symmetry plan and direction of advance. On the contrary, for slow ships (small Froude number) with relatively high frictional resistance percentage, it is recommended (for given displaced volume) to target an *as small as possible* wetted surface, which implies a ratio (B/T) corresponding to approximately 2.5 and a block coefficient of $C_B \cong 0.80$ (noting the block coefficient of a floating semisphere = $\pi/4$)¹⁰. However, it is considered that for fast ships (larger Froude number) the total resistance is also minimized for $B/T \cong 2.5$.

From the research of *Mumford and Moor* it was shown for the dependence of the ship's total resistance on changes of beam and draft (see Papanikolaou 2009a):

$$\frac{(R_T)_1}{(R_T)_0} = \left(\frac{B_1}{B_0}\right)^x \cdot \left(\frac{T_1}{T_0}\right)^y \quad (2.71)$$

where the semiempirical exponents x and y are given in the above table as a function of the Froude number and ship type (Table 2.8). The below semiempirical coefficients of Mumford were recently revised for Ro-Ro cargo and Ro-Ro passenger ships (Alissafaki 2013) (below Table 2.9).

Let us now have a look at the following seemingly hydrodynamic “paradox” that should defy the general impression of a negative effect of low L/B on the ship's resistance. If in parallel to the increase of the ship's beam the hull form changes in such a way that the design draft remains constant (and the same is assumed for the displacement and the length) then despite the reduction of the L/B ratio and the increase of B/T ratio a *decrease* of C_B (and C_p) and often a *reduction* of the residuary resistance is obtained. The following example of a reefer cargo ship, for which the

Table 2.8 Exponents by Mumford $x=f(F_n)$, $y=f(F_n)$ for cargo ships and fishing vessels

| F_n | | ≤ 0.24 | 0.25 | 0.26 | 0.27 | 0.28 | 0.29 |
|----------------|-----|-------------|-------|-------|------|-------|-------|
| Cargo ship | x | 0.85 | 0.85 | 0.85 | 0.85 | 0.85 | 0.85 |
| | y | 0.52 | 0.53 | 0.55 | 0.64 | 0.74 | 0.78 |
| Fishing vessel | x | 0.74 | 0.74 | 0.74 | 0.74 | 0.74 | 0.745 |
| | y | 0.60 | 0.60 | 0.60 | 0.60 | 0.60 | 0.60 |
| F_n | | 0.30 | 0.31 | 0.32 | 0.33 | 0.34 | 0.35 |
| Cargo ship | x | 0.855 | 0.880 | 0.945 | 1.00 | – | – |
| | y | 0.80 | 0.80 | 0.80 | 0.80 | – | – |
| Fishing vessel | x | 0.78 | 0.84 | 0.90 | 0.95 | 0.995 | 1.00 |
| | y | 0.60 | 0.60 | 0.60 | 0.60 | 0.60 | 0.61 |

¹⁰ It can be readily shown that the (semi)sphere is the solid with the minimum surface area for a given enclosed volume.

Table 2.9 Exponents by Mumford $x=f(F_n), y=f(F_n)$ for Ro-Ro cargo and Ro-Ro passenger ships

| F_n | | 0.18 | 0.19 | 0.20 | 0.21 | 0.22 | 0.23 |
|----------------------|-----|-------|-------|-------|-------|-------|-------|
| Ro-Ro ship | x | 0.743 | 0.743 | 0.747 | 0.755 | 0.770 | 0.794 |
| | y | 0.368 | 0.371 | 0.377 | 0.384 | 0.395 | 0.408 |
| Ro-Ro passenger ship | x | 0.807 | 0.801 | 0.796 | 0.794 | 0.797 | 0.802 |
| | y | 0.307 | 0.309 | 0.313 | 0.317 | 0.324 | 0.333 |
| F_n | | 0.24 | 0.25 | 0.26 | 0.27 | 0.28 | 0.29 |
| Ro-Ro ship | x | 0.818 | 0.835 | 0.854 | 0.893 | 0.963 | 1.053 |
| | y | 0.423 | 0.440 | 0.461 | 0.486 | 0.513 | 0.540 |
| Ro-Ro passenger ship | x | 0.807 | 0.815 | 0.835 | 0.874 | 0.925 | 0.975 |
| | y | 0.344 | 0.358 | 0.374 | 0.393 | 0.413 | 0.432 |
| F_n | | 0.30 | 0.31 | 0.32 | 0.33 | 0.34 | 0.35 |
| Ro-Ro ship | x | 1.140 | 1.202 | 1.233 | 1.238 | 1.229 | 1.217 |
| | y | 0.564 | 0.583 | 0.600 | 0.616 | 0.632 | 0.652 |
| Ro-Ro passenger ship | x | 1.012 | 1.032 | 1.039 | 1.039 | 1.040 | 1.046 |
| | y | 0.450 | 0.467 | 0.484 | 0.503 | 0.524 | 0.550 |

resistance has been calculated according to the well-known *Taylor–Gertler* semiempirical method, verifies the above consideration (Tables 2.10, 2.11, and 2.12).

Table 2.10 Variation of B and C_p times L : fixed

| | | | |
|---------------------------|------|------|------|
| L/B | 6.5 | 7.0 | 7.5 |
| B/T | 3.2 | 3.0 | 2.8 |
| C_p | 0.56 | 0.60 | 0.65 |
| $\frac{(R_T)_1}{(R_T)_0}$ | 0.80 | 1.00 | 1.32 |

Table 2.11 Variation of L and C_p times B : fixed

| | | | |
|---------------------------|------|------|------|
| L | 124 | 132 | 140 |
| L/B | 6.6 | 7.0 | 7.4 |
| $L/\sqrt[3]{V}$ | 5.9 | 6.3 | 6.7 |
| C_p | 0.64 | 0.60 | 0.57 |
| $\frac{(R_T)_1}{(R_T)_0}$ | 1.42 | 1.00 | 0.79 |

Table 2.12 Variation of L and B times C_p : fixed

| | | | |
|---------------------------|------|------|------|
| L | 124 | 132 | 140 |
| B | 20.1 | 18.9 | 17.8 |
| L/B | 6.2 | 7.0 | 7.85 |
| B/T | 3.2 | 3.0 | 2.8 |
| $\frac{(R_T)_1}{(R_T)_0}$ | 1.18 | 1.00 | 0.93 |

Given Initial Data

| | |
|----------------------------|------------------------------|
| $\Delta = 9,480 \text{ t}$ | $\nabla = 9,200 \text{ m}^3$ |
| $L_{pp} = 132 \text{ m}$ | $L/\nabla^{1/3} = 6.3$ |
| $B = 18.9 \text{ m}$ | $L/B = 7.0$ |
| $T = 6.3 \text{ m}$ | $B/T = 3.0$ |
| $C_p = 0.603$ | $C_B = 0.585$ |
| $C_M = 0.970$ | |
| $V = 22 \text{ kn}$ | $F_n = 0.315$ |

Parametric changes It is considered that the draft T and the coefficient C_M remain fixed, hence:

$$(\nabla / T \cdot C_M) = L \cdot B \cdot C_p : \text{fixed}$$

1. Variation of B and C_p times L : fixed (Table 2.10)
2. Variation of L and C_p times B : fixed (Table 2.11)
3. Variation of L and B times C_p : fixed

Conclusions (by inspection of results of Tables 2.10, 2.11, 2.12)

1. Increase of the length always positively affects the resistance (reduction).
2. Reduction of C_p implies also reduction of the resistance.
3. *For given length (and draft), increase of beam, but also reduction of C_p means reduction of the resistance* (see values in the above Table 2.10).
4. The influence of B/T on resistance (see above Tables 2.10 and 2.11) is herein almost negligible.
5. Note that the above conclusions cannot be generalized for other case scenarios, especially for ships designed for different Froude numbers, e.g. for tankers.

2.6.3 Effect of Beam on the Ship's Structural Weight

To investigate the beam's influence on the steel weight we assume at first that the moment of inertia of the midship section can be expressed approximately by the formula¹¹ (see Sect. 2.3.2):

$$I = k \cdot A_f \cdot d^2 = k \cdot p \cdot t \cdot d^2$$

where

d : distance of the midship section's extremes from the neutral axis

¹¹ Assuming ship's structure represented by a bending beam and her midship section approximated by the cross section of an equivalent tubular beam, of mean thickness t and perimeter p .

- A_f : cross area of the structure at the midship section
 p : cross-section's perimeter
 t : average thickness
 k : form coefficient accounting for the form of the midship section

Assuming that the bending moment and the level of stresses on the midship section remain unchanged, which results from the requirement of fixed length, and additionally that the distribution of the structural elements of the ship's structure and the form of the midship section do also not change significantly, which means that the distance d and the form coefficient k remain constant, the following is concluded:

$$p \cdot t: \text{remains unchanged.}$$

Thus if we can set approximately for the perimeter:

$$p \cong 2(B + D)$$

or for the under study ship:

$$p_1 = 2(B_1 + D_1)$$

and in particular if the side depth remains unchanged, that is it does not decrease inversely with beam's increase:

$$p_1 = 2(B_1 + D) = 2(B + \delta B + D) \quad (2.72)$$

it is concluded from the requirement:

$$(p \cdot t)_1 = (p \cdot t)_0$$

due to

$$\left(\frac{p_1}{p_0} \right) = 1 + \frac{\delta B}{(B + D)}$$

for the average thickness:

$$\left(\frac{t_1}{t_0} \right) = \left(1 + \frac{\delta B}{(B + D)} \right)^{-1} \cong 1 - \frac{\delta B}{(B + D)} + \dots$$

Thus, if the steel weight of the main hull is approximated with the formulas (see Sect. 2.3.2)

$$W_H = k_H \cdot A_H \cdot t,$$

where the area of the ship's hull is assumed according to Taylor as following:

$$A_H = C_H \cdot \sqrt{\nabla} \cdot L$$

with

$$C_H = f(B/D, C_{MD})$$

it is concluded for the weight:

$$(W_H)_1 = k_H \sqrt{\nabla} \cdot L \cdot (C_H)_1 \cdot t_1 \quad (2.73)$$

From the last relationship it is shown that:

- The hull surface area increases with the increase of the ratio B/D , as shown by the dependence of the C_H coefficient.
- With the increase of beam by δB the average thickness of the plates decreases, provided that the side depth D and the ratio L/D are constant.
- The above two changes act in a counterbalancing way with respect to the steel weight, resulting usually in a slight weight increase due to the more drastic increase of the hull surface area.
- Provided that the side depth does not remain constant, but decreases inversely proportional with the increase of the beam, an increase of the plate thickness results, due to the increase of the ratio L/D , and of course an increase of the steel weight follows.
- Finally, an increase of beam around the midship section generally results in significant changes in the distribution of loadings due to higher concentration of weight and hydrostatic forces at this ship position. Thus, an increase of the bending moment at the midship section is concluded, resulting in a requirement for additional increase of the average thickness of the plates so as to achieve the required modulus and keep the maximum level of stresses unchanged; in view of the above, an increase of the steel weight and hence of the cost of the ship is concluded.

2.6.4 Other Factors Affecting the Selection of the Beam

1. **Behavior in waves:** When determining the ship's beam based on initial stability criteria, that is aiming at a satisfactory GM , the behavior of the ship in waves and in particular the roll motions must be taken into account. For safety and operability reasons, such as avoidance of passengers' and crew's nausea, wave induced loadings on the ship's structure, equipment and cargo, speed loss due to excessive motions and added resistance in waves, problems of dynamic stability, and possible capsizing, we should be aiming at:

- Reduced roll motion amplitudes
- Reduced accelerations due to roll motion, especially in the transverse direction at larger distance from the vessel's rolling axis (e.g., deck area, where containers may be stowed)

The roll motion period of the ship depends at first on the period of the incident sea waves, exciting the ship's motions. However, if we restrict ourselves to the consideration of the most critical situation of resonance/tuning of the incident wave period with the natural rolling period of the ship, where the motions and accelerations are maximized, we may consider the natural rolling period of the ship

$$T_{\varphi} = \frac{2\pi i_{\varphi}}{\sqrt{gGM}} \quad (2.74)$$

where

T_{φ} (second): natural period of rolling,

i_{φ} (meter): radius of the mass moment of inertia of the ship including the hydrodynamic, added mass moment, about the rolling axis

$$i_{\varphi} = k_{\varphi} \cdot B$$

where

$k_{\varphi} = 0.32-0.45$ ¹², depending on the type and size of the ship,

$i_{\varphi} \cong 0.38B$ (average value)

g (m/s²): acceleration of gravity

\overline{GM} (m): metacentric height.

If we assume that: $\overline{GM} \propto B^3$ and $i_{\varphi} \propto B$, it is concluded that:

$$T_{\varphi} \propto \frac{B}{\sqrt{\overline{GM}}} \propto \frac{1}{\sqrt{B}}$$

that is, relatively large beam and high \overline{GM} lead to small natural period of roll, which may be tuned with low wave periods, corresponding to short-length waves (Lewis 1988).

Low rolling periods induce *high* transverse accelerations, especially at points far away from the rolling axis (higher up on the ship's deck/superstructure). The ship's rolling axis is not fixed, but changes continuously its position in between the ship's still water plane and the vertical position of the center of mass of the ship. Indicative

¹² Low values hold for ships with their mass (ship's light ship mass plus deadweight) being concentrated in the holds region, for example bulkcarriers, particularly ore carriers; high values that may exceed even 0.45 hold for ships with voluminous and very high up extended superstructures, for example large cruise ships and to a certain extent RoPax ships.

Table 2.13 Typical natural roll periods for various types of merchant ships

| | |
|-------------------------|---------|
| Cargo ships | 12–8 s |
| Coastal cargo ships | 7–10 s |
| Bulk carriers | 12–20 s |
| Tankers | ~20 s |
| Reefer ships | 16–18 s |
| Cruise ships | ~20 s |
| RoPax ferries | 10–14 s |
| Trawler/fishing vessels | 10–13 s |
| Open sea tugboats | 8–12 s |

values for the natural period of roll motions of common types of commercial ships are listed in Table 2.13.

Finally, *Kempf* recommended the use of the so-called “roll number” (German: “Rollzahl”), which is defined as:

$$R = \frac{2\pi \cdot i_{\phi}}{\sqrt{B \cdot GM}} \quad (2.75)$$

which is a nondimensional value and varies between 8 and 14 for ships with good performance in waves. It is observed that for modern RoPax ships the value of R is often smaller than 8 due to the stringent requirements of intact stability regulations (requiring high \overline{GM}).

The negative effect of large amplitude roll motions on the operability of ships, especially those transporting sensitive cargos, passengers, or of naval ships, can be mitigated significantly by installing antirolling devices, such as antirolling fins, antirolling tanks, or/and simply bilge keels.

2. Restrictions of beam for certain ship types:

- Ships transporting standardized and bulky cargos (break bulk and unitized cargo), such as Ro-Ro, Ro-Pax, containerships, LASH, rail ferries, etc., require beams corresponding to the specific number of units of stowed cargo in the transverse direction. For container ships there is some degree of flexibility because of the existence of the side tanks and the relatively small width of a standard container (8 ft).
- Restrictions may apply to ships that operate through specific canals or channels (e.g., PANAMAX and SUEZMAX ships) or are being serviced by specific slipways of yards.
- From the restriction of draft for certain ship types, such as large tankers, bulk carriers, reefer ships, river ships, an increase of beam, or of the B/T ratio may be concluded, which leads often to undesired high values.

3. Maneuverability performance:

- It is considered that in general the reduction of the L/B ratio (increased beam) leads to an improvement of maneuverability of the ship, particularly regard-

ing the turning ability within a small diameter circle, in contrast to the course stability, which becomes generally worse.

2.7 Selection of the Side Depth

The side depth D of the ship's main deck is crucial for two fundamental ship properties:

- The available holds' volume
- The achieved freeboard

It is obvious that the selection of the side depth is inherently linked to the permissible draft. Indirectly it is related to the ship's length, in consideration of the ship's longitudinal strength, and beam, in terms of the stability of the ship.

It is considered that the side depth is the “*cheapest*” and *less problematic* main dimension of a ship. In particular, increase of side depth by 10% causes an increase of the steel weight by 8% for $L/D=10$ or by 4% for $L/D=14$ (Schneekluth 1985), that is, the achievable volume increases more rapidly than the resultant increase of the ship's structural weight; consequently it is appropriate to prefer an increase of the ship's side depth rather than changes of other main dimensions, in case the ship's hold volume is inadequate.

2.7.1 Effect of Safety Regulations on Side Depth

The selection of side depth is significantly influenced by the following regulations regarding safety and operation:

1. The International Load Line Convention (ICLL 1988) that determines the freeboard deck and the permissible freeboard, namely the allowable difference between side depth and draft.
2. Regulations regarding the watertight subdivision of ships (International Convention for the Safety Of Life at Sea—SOLAS), which determine the subdivision (or bulkhead) deck of the ship. This regulation mainly affects the selection of the side depth of passenger ships, but also of some types of cargo ships, such as tankers longer than 150 m (ship of type A according to the Load Line Convention) and other dry cargo ships (type B ships) with reductions of the required freeboard (B-60 and B-100 bulk carriers). Certainly, when deciding on the watertight subdivision of a ship based on the floodable lengths curve, a relatively high position of the bulkhead deck and fewer bulkheads should be preferred, rather than vice versa.
3. Regulations of tonnage measurement (National and International Regulations—tonnage mark) affect the position of the main deck less than in former times, due to the more rational method of determining the ship's enclosed—exploitable spaces regardless of the existence of “tonnage openings” (see older types of cargo ships with a “shelter” deck, Antoniou and Perras 1984).

4. Regulations of classification societies specify an upper limit for the L/D ratio, which usually ranges between 14 and 16. If the upper limit of $L/D=14-16$ (depending on the classification society) is not observed, then a dedicated examination of longitudinal strength and approval by the classification society is required. Particularly for certain small coastal ships or barge and bulk carriers operating in sheltered areas (e.g., Great Lakes ships), L/D ratios up to 20 have been approved in the past by some classification societies (e.g., ABS).

2.7.2 Effect of Side Depth on Hold Volume and Arrangement

As stated before, an increase of the side depth involves an increase of the available hold volume or of the *capacity factor* (Räume), which expresses the ratio of the available grain hold volume to the ship's deadweight. Thereby, while an increase of the ship's length involves in general the synchronous increase of the ship's displacement, the increase of the ship's side depth results in an expansion of the available volume vertically and has no significant direct influence on the ship's displacement, besides causing a small increase of the ship's steel weight, if all the other dimensions remain constant. The height of the ship's main hull is very important for cargo ships, which, depending on the type of carried cargo, may be horizontally subdivided by intermediate decks at different levels.

Typically we refer to Ro/Ro cargo ships, ferries, reefer ships, as well as to conventional general cargo ships, which, for easy stowage and unloading reasons, dispose intermediate decks through which the ship is subdivided in the vertical direction. Obviously, the number and the exploitable height of the intermediate decks are determined by the cargo type and stowage method. Thus, while for general cargo ships there is some flexibility as to the available height of decks, this is not the case for Ro/Ro ships, car/train ferries, and reefer ships, where the height is determined by the cargo's standard dimensions and stowage/loading-unloading method.

Finally, for bulky cargo units, with standard dimensions, there are specific requirements as to the height of the side depth. Typically, the side depth of ships carrying standard containers is determined by the number of vertically stackable containers (height of 8' to 8.5' per unit). Here, the height of the coamings of the hatchways as well as the height of double bottom are taken into account. With the same criterion in mind, modern multipurpose/semi-container ships dispose similar side deck heights, so as to enable them to transport an integer number of containers in the area of the openings of their hatchways.

2.7.3 Effect of Side Depth on the Ship's Stability

The influence of the side depth on the ship's stability is complex and should be examined separately for the initial stability and stability at large angles.

With side depth's increase, the steel weight of the structure above main deck increases, resulting in raising the corresponding center of gravity. Also, the weight centers of superstructures and outfitting increase accordingly, leading to an increase of the ship's total \overline{KG} in both light ship and fully loaded conditions. Thus, for small inclination angles, an increase of the side depth generally reduces the values of restoring moment (reduction of \overline{GM}) until the angle corresponding to the immersion of the main deck's edge.

After this angle, however, a significant increase of the stability righting arm is achieved, as well as an expansion of the region of positive values of restoring moment (range of stability), compared to the original ship.

Special attention should be paid to the selection of the side depth of RoPax ships, given that this value determines the main car deck, up to which the ship is considered vertically watertight. After the tragic accident of the RoPax ship *Estonia* (1994) very strict regulations on damage stability were established, explicitly taking into account the effect of possible water flooding on car deck due to sea wave impact in case the outer shell of RoPax ships is damaged (the so-called Stockholm Agreement, Papanikolaou 2002). The amount of water assumed flooding the car deck is a function of both the significant wave height in the area of ship operation and her freeboard in damaged condition¹³. Therefore, the selection of the ship's side depth (and her freeboard along with the selection of draft) is the result of a combined study of Load Line Regulations and damage stability requirements.

In conclusion, an increase of the ship's side depth adversely affects the stability at small inclination angles, whereas for large angles it has a positive effect when accompanied by sufficient freeboard. Generally, the magnitude of the side depth is determined by the amount and stowage of the transported cargo; possible stability problems in the course of ship design must be treated with other, more drastic means, for example adjustment of the ship's beam.

The selection of the freeboard, and thus of the difference between side depth and loaded draft, is addressed later in more details in Sect. 2.19.

2.7.4 Effect of Side Depth on the Ship's Structural Weight

If we assume the ship to be a bending girder (beam) (see Sect. 2.3.2) and examine its longitudinal strength, it is clear that with the increase of the side depth D and reduction of the ratio L/D , a reduction of the bending stresses in general occurs due to an increase of the girder's modulus, while the bending moment remains constant for fixed length.

The sectional modulus of the girder increases due to the shifting of the masses of the deck and the ship's bottom away from the neutral axis. Thus, the thickness of

¹³ Maximum significant wave height, to be considered, is 4.0 m (for North Sea conditions); below 1.5 m sign. wave height, it is assumed that no water can flood the car deck of a RoPax ferry, if it complies with SOLAS 90 damage stability regulations.

the plates can be reduced, and the steel weight per cubic meter volume, decreases significantly as well as the corresponding construction cost.

As we have elaborated previously, if we set for the steel weight of the ship (see Sect. 2.3.2):

$$W_H = k_H \cdot A_H \cdot t$$

where

A_H : hull shell surface area

t : average thickness of plates

k_H : form coefficient of specific midship section

and the hull shell surface area is approximated by:

$$A_H \cong k_H \cdot p \cdot L \cong k_H \cdot 2(B + D) \cdot L$$

where p : perimeter of midship section, it is concluded for the weight:

$$W_H = \alpha_H \cdot t + b_H \cdot D \cdot t$$

that is, the weight increases with the thickness t and side depth D . However, given the moment of inertia of the midship section:

$$I \propto p \cdot t \cdot d^2 \propto p \cdot t \cdot D^2$$

and the modulus

$$W = I / d \propto p \cdot t \cdot d \propto p \cdot t \cdot D$$

it is concluded for the bending stresses at the midship section (see Sect. 1.1.2)

$$\sigma = \frac{M_{\max}}{W} = \frac{\Delta \cdot L}{C \cdot W}$$

As Δ , L , and C are fixed, it is clear that

$$\sigma \propto \frac{1}{p \cdot t \cdot D} \propto \frac{1}{a \cdot t \cdot D + b \cdot t \cdot D^2}$$

That is, if the level of the stresses is considered unchanged, the reduction of the thickness t is very significant and inversely proportional to side depth D leading to a reduction of ship hull's steel weight W_H . Nevertheless, this result is based on simplified assumptions and may slightly change in practice, but without changing the identified general trends.

2.8 Selection of the Draft

As mentioned earlier, during the selection of the beam, following the estimation of the displacement, length and block coefficient, the product $B \cdot T$ is considered known. Thus, the selection of the beam (see Sect. 2.6) involves indirectly the selection of draft, namely through the selection of typical values of the B/T ratio (see Table 2.6, Sect. 2.3), assuming that the product $B \cdot T$ is not known from other sources. Also, following the selection of side depth, the maximum permissible draft is determined by the required freeboard, which is calculated based on the length L , the side depth D , C_B and various other ship particulars. The main factors affecting the selection of draft are analyzed in the following.

2.8.1 Effect of Draft on Resistance and Propulsion

The draft of the ship appreciably affects the components of the total resistance, that is the frictional and wave resistance, of both slow and fast ships.

As indicated in Sect. 2.6.2 regarding the reduction of frictional resistance, which dominates the total resistance for relatively slow ships of small Froude number, it is required to achieve a minimum wetted surface area, which can be shown to be associated with values $B/T=2.0-2.5$, depending on the C_B and the form of sections at the ship's both ends.

In addition, in order to minimize the wave resistance, we aim at shifting displacement away from the water plane downwards, which results in slender hulls.

It has been verified by experiments that a ratio B/T around 2.5 serves best not only frictional resistance but also wave resistance aspects.

From the propulsion point of view, one as large as possible draft is always sought aiming at the fitting of a large diameter propeller, with good efficiency in view of the resulting moderate loading on the propeller blades and the low turning of the propeller (low RPM). This general rule applies to all types of ships and especially to towing ships (tug boats and fishing vessels). It should be, however, taken into account that for not fully loaded or bow trim conditions, a large diameter propeller tends to emerge more frequently than a smaller one. Finally, on certain types of ships it is not possible to install a large diameter propeller because of the required high RPM of propeller and engine (small boats), or in case of multipropeller ships. Generally, for twin-propeller ships the ratio B/T is higher than the corresponding one for single-propeller ships (>2.6 vs. $2.1-2.5$).

2.8.2 Effect of Draft on Stability

The influence of draft on the stability is not as obvious as that of the beam and side depth. From the relationship:

$$\overline{GM} = \overline{KB} + \overline{BM} - \overline{KG},$$

it can be at first concluded that an increase of the draft positively affects ship's initial stability, as it essentially implies an increase of \overline{KB} . If the increase of draft is coupled with a swift of displacement towards the design water plane (V-type sections), namely by increasing the fullness of the water plane and beam, the influence on the initial stability is drastic because of the synchronous increase of \overline{BM} , whereas the \overline{KG} does not increase significantly.

However, it should be noted that beyond the design process, where the displacement is presumed fixed, if we examine the stability for various loading conditions, the change of \overline{BM} should be considered through

$$\overline{BM} = \frac{I_T}{\nabla}$$

namely, for an *increased* draft the *increase* of I_T is usually less drastic than the increase of displacement ∇ , so as to conclude to a *decrease* of \overline{BM} , hence of \overline{GM} ¹⁴.

2.8.3 Influence of Draft on Seakeeping and Maneuverability

The influence of draft on the ship's seakeeping performance is particularly important for the light loaded condition, for example ballast condition.

In order to avoid intense slamming in the ballast condition, the minimum draft at the bow should be:

$$T_F \geq 0.02L \quad (2.76)$$

Furthermore, in order to avoid the emergence of the propeller (propeller racing), the minimum draft at the stern is recommended to be:

$$T_A \geq D_p + e + 0.4m \quad (2.77)$$

where

D_p : propeller diameter

e : distance of the lower tips of the propeller blades from the baseline, $\cong 0.1\text{--}0.2$ m (for ships without rudder-post).

Finally, in order to achieve sufficient maneuvering capability, the product of ($L \cdot T$), that is the longitudinal projection (lateral plan) of the wetted hull surface, should be proportional to the projected rudder area A_R :

$$\frac{L \cdot T}{A_R} = 30 \div 80 \quad (2.78)$$

¹⁴ Considering also the parallel change of \overline{KG} as a function of ship's draft, especially its significant increase when moving from the light to the full load condition, it is obvious that the stability of a ship in ballast condition is generally less problematic than in full load condition.

where the values on the right are determined by the ship type (lower limit values: best maneuvering ships, like tug boats; upper limit: fast passenger ships, tankers, etc.).

2.8.4 Influence of Draft on Strength

In view of the negative influence of large lengths on the longitudinal strength and on torsional stresses (see Sect. 2.3.), the trend in certain modern ship designs is evident to account for relatively large drafts (and beams). Of course, this leads to higher hydrostatic pressures at the bottom, the strengthening of which involves an increase of the ship's steel weight.

However, if the other dimensions remain unchanged (or may be even reduced), the latter effect is not significant, compared to similar increases of weight due to changes of other dimensions. It should be noted, however, that if the beam increases in parallel to draft, in view of the large projected areas at the ship's bottom, it is likely that problems of "transverse strength" arise, which may require additional strengthening and may result in increases of the steel weight. In this case, however, a parallel decrease of the ship's length may be expected, what counterbalances this likely steel structure weight increase.

2.8.5 Effect of Route Limits

The draft is the main dimension of every ship that is most affected by the restriction of depths of navigating routes. The permissible ship draft is determined by the governing depths in the calling ports, entrance ways to ports, channels, canals, estuaries, bays, and narrow sea straits, considering in addition the effect of natural-periodic (e.g., tidal effects) or irregular fluctuations of sea surface. Generally, an increase of draft is undesirable by ship operators because of introduced limitations of navigation.

Restrictions on draft automatically lead to increases of other dimensions, mainly of beam (see Table 2.7, Sect. 2.3, shallow draft tankers and bulk carriers).

Characteristic limits of well-known channels, canals, rivers (Figs. 2.37, 2.38, and 2.39):

- Panama Canal: $T < 13$ m (under dredging, up to 15.2 m until 2014)
- Suez Canal (Egypt): $T < 18$ m (1984)
- Northeast Sea Channel (North Europe): $T < 9.5$ m
- Canal St. Lorenz (USA–Canada): $T < 7.6$ m
- Estuary of La Plata River (South America): < 8.2 m



Fig. 2.37 The Panama Canal

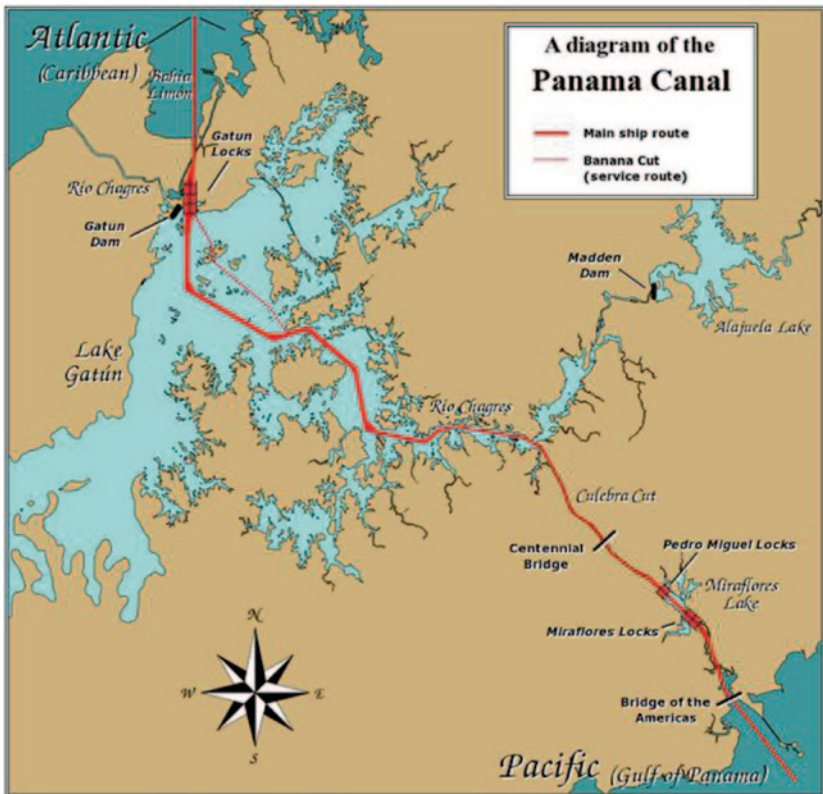

Fig. 2.38 Geography of the Panama Canal

Fig. 2.39 Satellite photograph of the Suez Canal



2.9 Selection of Hull Form Coefficients

With the determination of the ship's block coefficient C_B , which generally expresses the fullness of the wetted part of the ship's volume compared to the volume of a rectangular parallelepiped of the same main dimensions L , B and T , the other hull form coefficients, such as the midship section coefficient C_M , the prismatic coefficient C_p and finally the water plane coefficient C_{WP} have been essentially also determined.

The coefficients affecting the selection of C_B also influence the selection of C_p , since both coefficients do not differ significantly, for common values of the midship section coefficient C_M varying between 0.94 and 0.99 for cargo and passenger ships (see Table 2.6); we may recall the well-known relationship

$$C_p = C_B / C_M$$

However, in a sense, the selection of C_p ,

$$C_p = \nabla / (L \cdot A_M) \tag{2.79}$$

where A_M is the midship section area, should precede that of C_B , because C_p expresses more properly the fullness of the hull of the ship under study compared to that of a prismatic hull, of basis area A_M and height L . Particularly, small C_p means a concentration of displacement amidships and slender ends, whereas a large C_p corresponds to a relatively small midship section area, an even distribution of the displacement longitudinally and an extended parallel body amidships.

The midship section coefficient C_M

$$C_M = A_M / (B \cdot T) \tag{2.80}$$

expresses the fullness of the midship section area in relation to the area of the circumscribed rectangle of the same B and T . Besides certain relatively small vessels with special requirements on stability and propulsion, namely need for sufficient draft for the installation of a propeller of as large as possible diameter, all other ships have very high C_M values (see Table 2.6). Small vessels that are exceptions from the above rule are fishing boats, tugboats, pilot boats, etc., with relatively small C_M (up to 0.70). For those vessels the difference between C_B and C_p is significant and attention should be paid during the preliminary design stage, when interpreting corresponding values.

Following empirical data of vessels *without* bottom deadrise, as it is common for large cargo ships, the following formulas, which correlate C_M with C_B , are recommended for use (Table 2.14):

For ships with a small L/B and bottom deadrise (such as fishing boats, tugs) the use of data from similar ships is recommended.

Finally as to the selection of the waterplane area coefficient C_{WP} , which influences the stability and wave-making resistance of the ship, both the fullness of the hull, namely C_B (or C_p) coefficient, and the form/character of the sections, also the bow type, should be taken into account. Generally the C_{WP} coefficient varies according to the variation of C_B (C_p).

The following formulas are concluded from empirical data:

a. U-type sections

$$C_{WP} = 0.778C_B + 0.248 \tag{2.81}$$

$$C_{WP} = 0.95C_p + 0.17(1 - C_p)^{1/3} \text{ (Schneekluth)} \tag{2.82}$$

Table 2.14 Empirical data of vessels without bottom deadrise

| | |
|---------------------|------------------------------------|
| V. Lammeren | $C_M = 0.9 + 0.1 C_B$ |
| H. Kerlen | $C_M = 1.006 - 0.0056 C_B^{-3.56}$ |
| HSVA Tank (Hamburg) | $C_M = 1 / (1 + (1 - C_B)^{3.5})$ |

b. Normal sections

$$C_{WP} = (1 + 2C_B) / 3 \quad (2.83)$$

c. V-type sections

$$C_{WP} = 0.743C_B + 0.297 \quad (2.84)$$

$$C_{WP} = (1 + 2C_B / \sqrt{C_M}) / 3 \text{ (Schneekluth)} \quad (2.85)$$

The above formulas are valid for cruiser stern ships, or ships with transom stern of limited extent. Newer constructions, with intense transom lines at waterline, have usually higher C_{WP} values, as can be seen from comparisons with similar ships. Typical values of the C_{WP} coefficient are presented in Table 2.6, Sect. 2.3.

2.10 Selection of Block Coefficient C_B and Prismatic Coefficient C_p

The *block coefficient* C_B (see Papanikolaou 2009a, Vol. 2 for all definitions) represents the ratio of the ship's displaced volume to the volume of the circumscribed rectangular parallelepiped with dimensions L (usually L_{pp}), B , and T . It can easily be shown that the C_B is the product of the *prismatic coefficient* C_p and *midship section coefficient* C_M (Fig. 2.40), i.e.,

$$C_B = C_p \cdot C_M, \text{ where } C_B = \frac{\nabla}{LBT} \text{ and } C_p = \frac{\nabla}{A_M L}$$

Thus, if the midship section coefficient C_M does not change significantly, as typically happens to large and mainly bulky vessels, the C_p and C_B coefficients can be considered to be equivalent in terms of their meaning with respect to the slenderness of the hull form, exhibiting comparable values.

The prismatic coefficient C_p represents the ratio of the displaced volume to the volume of a prism with the basic area A_M (midship section area) and the height (=length) L (see also the following sketch; Fig. 2.41).

C_p describes the degree of concentration of the ship's displacement with respect to the midship section; however, the lengthwise distribution of the displacement cannot be concluded uniquely based on the value of C_p only. Nevertheless, small C_p generally indicates a ship with a relatively large area A_M and concentrated displacement around the midship section (thus slender ends), whereas large C_p means evenly distributed displacement along the ship length and long parallel body around the middle of the ship with short and bulky ends.

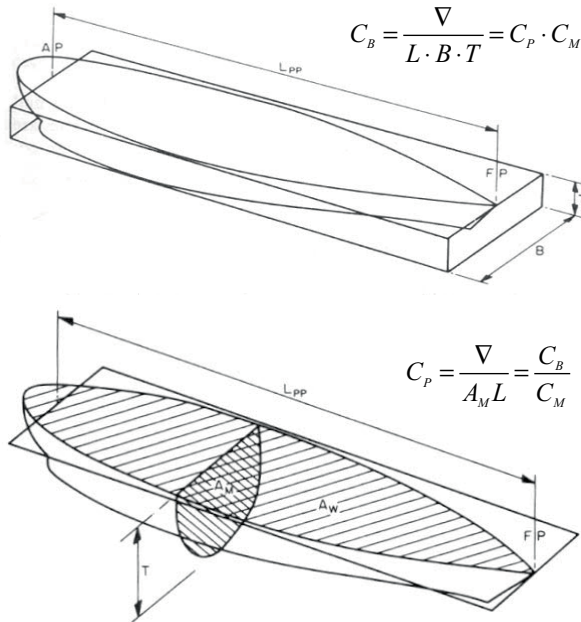

Fig. 2.40 Hull form coefficients C_B and C_P

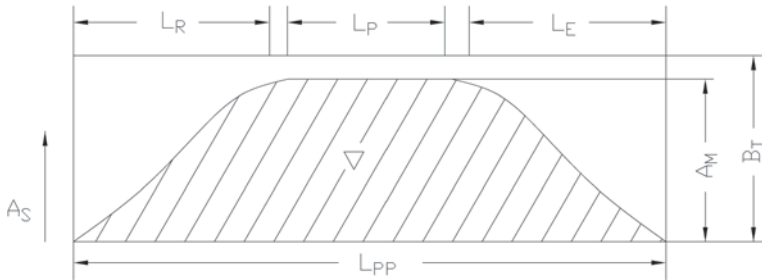

Fig. 2.41 Definition of sectional area curve

Particular attention is required when evaluating the true meaning of the information that the values of the coefficients C_B and C_P contain, especially when dealing with small vessels such as fishing boats, tugs, and speedboats. Here, the significant effect of the relatively small C_M must be assessed in parallel (see Fig. 2.42).

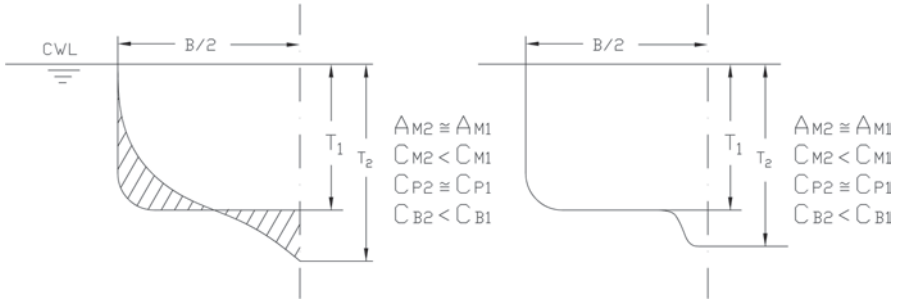

Fig. 2.42 Representativeness of block- and prismatic coefficients with respect to ship's hull form

Thus, in the above cases, while for the two hulls with $T_1 < T_2$ the prismatic coefficient remains, in both cases, almost unchanged (and the displacement also does not change), the block coefficients C_B differ significantly ($C_{B1} > C_{B2}$).

In conclusion, the prismatic coefficient describes more effectively the form of the hull and any review of the ship's hull geometry must take into account, in addition to C_B , also the values of the coefficients C_p and C_M .

The slenderness ratio $L/\nabla^{1/3}$ complements the quantitative description of the wetted hull of the ship. The following examples demonstrate the importance of the coefficient C_p and ratio $L/\nabla^{1/3}$ in the assessment of the hull geometry of various types of ships:

- a. Ocean liner—fast passenger ship: $L_{pp}/\nabla^{1/3} = 7.2$, $C_p = 0.57$
- b. Fishing vessel—tugboat: $L_{pp}/\nabla^{1/3} = 5.2$, $C_p = 0.62$
- c. River boat—cargo ship: $L_{pp}/\nabla^{1/3} = 6.8$, $C_p = 0.85$

From the above examples it is concluded that, only high values of slenderness ratios, accompanied by small C_p , lead to slender hulls.

2.10.1 Effect of C_p and C_B on the Ship's Resistance

The influence of C_p and C_B coefficients on the ship's resistance is significant. However, the factors affecting the selection of C_p (and C_B) differ depending on the corresponding operational Froude number.

For relatively slow ships (low Froude number), we try to minimize the wetted surface, as the objective is herein to keep the frictional resistance as low as possible, as in the total resistance breakdown this resistance component prevails significantly over the wave-making resistance. Thus, relatively high coefficients C_p (and C_B) and large midship sectional areas are concluded for tankers and bulkcarriers (C_p and C_B up to 0.88, C_M up to 0.99).

For relatively fast ships (high Froude number) it is necessary to reduce the more significant wave resistance as much as possible. The objective herein, is to control/tune the superposition of the various ship generated wave systems, especially those created at the ends (bow and stern) and the shoulders of the ship. The concentration of displacement in the middle of the ship generally leads to a smoothing of the

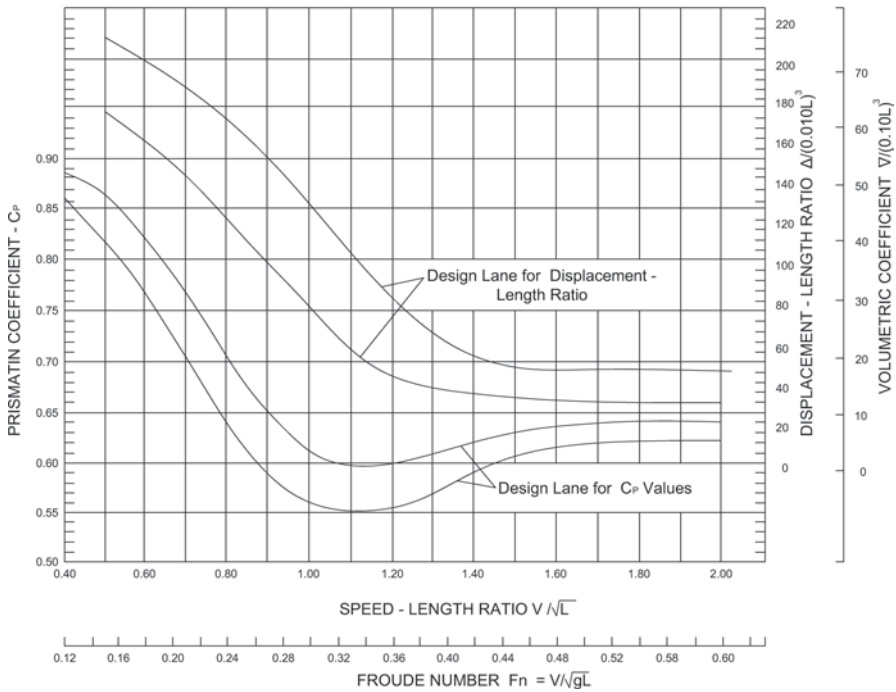

Fig. 2.43 Regions of variation of prismatic and volumetric coefficients for built ships by Saunders. (Lewis 1988)

shoulders and of the intensity of the corresponding secondary wave systems (see Sect. 2.3). For each length and displacement, thus for a given slenderness ratio, there is an optimal C_p as function of the Froude number, leading to a minimum wave resistance. Generally, for high Froude numbers, a low optimal C_p is concluded (see, for example, resistance curves of the systematic hull form series DTMB by Taylor-Gertler and FORMDATA by Guldhammer in Schneekluth 1985). However, if the Froude number exceeds a certain limit ($F_n \geq 0.33$), the total resistance only slightly varies with C_p , while for $F_n \geq 0.46$ it decreases slowly with increasing C_p . For ships with bulbous bow, the above limits may be shifted to higher values.

From the diagram below (Fig. 2.43), which shows the variation of C_p and of the volumetric coefficient versus the Froude number for built ships, the following is concluded:

1. **Slow ships ($F_n \leq 0.24$):** The prismatic coefficient is chosen to be relatively high, and in particular higher than the hydrodynamic optimum. Hence, the frictional resistance is minimized and the relatively low wave resistance does not increase significantly. Non-hydrodynamic aspects, such as construction cost and space exploitation, are positively affected by large C_p and dominate the selection of C_p .
2. **Fast ships ($0.24 \leq F_n \leq 0.36$):** In this region it is appropriate to choose C_p following hydrodynamic performance criteria, i.e., with a view of minimizing resistance. Thus, typical C_p values are actually close to the hydrodynamic optimal ones, given that the operational cost (greatly affected by powering and fuel consumption) can be shown equally important to the construction cost.

3. **High speed craft ($0.36 \leq F_n \leq 0.46$):** It can be seen that in this region the total resistance varies only slightly with C_p , thus the selection of C_p may be determined by other factors (including dynamic stability aspects).
4. **Speedboats and small crafts ($F_n > 0.46$):** For speedboats and small crafts the model experiments show that the total resistance decreases slightly with increasing C_p . Again other aspects determine the selection of C_p , with dynamic stability, lift and trim considerations now dominating.

2.10.2 Effect on the Seakeeping Performance

Besides low calm water resistance and propulsive power, the ultimate goal of a good ship hull designer is to achieve good performance in natural seaways, namely small ship motions (pitch, heave, roll, etc.) and accelerations (vertical and transversal), low added resistance and powering in waves, thus good seakeeping.

It is well known that large ship motions due to heavy seas, especially pitching and heaving, lead to added resistance and powering (added resistance can make up to 70% of the calm water resistance). Model experiments conducted by Todd (Schneekluth 1985) with a cruiser ship model of $C_B=0.5$ travelling in head seas with constant propulsion power have shown that for an incident wave length $\lambda \cong 1.05 L$, which corresponds approximately to the resonance region of heave/pitch motions, the *involuntary* loss of the ship's speed was 22% or $dV=0.22 V_0$; while for $C_B=0.7$ (cargo ship) and the same displacement and length, the measured speed loss was 55% or $dV=0.55 V_0$. In addition to the above *involuntary* speed loss at constant propulsive power, dynamic loading on the steel structure, bow slamming, propeller racing, nausea of passengers, excessive loadings on the cargo, etc., may lead the ship's master to a *voluntary* reduction of the speed (decrease of propulsive power supply) to mitigate these phenomena.

The pitch motions of a ship take place about a time varying transverse axis, which passes near the center of floatation of the still waterplane and are the result of the forces and moments exerting on the vessel due to the changes of the hydrodynamic pressure distribution along the ship at her actual position with respect to the incident wave¹⁵.

Generally, the influence of C_p on the amplitude of the resulting heave/pitch motions is not straightforward. The amplitude of the motions (and hence of accelerations) depends largely on the bow configuration/form (below and above waterplane), the length and the speed of the ship, as well as on the characteristics of the incident wave (height, heading and period/wavelength).

Apart from the unclear influence of a small C_p on heave and pitch motions, it has been shown that a small C_p tends to increase the probability of green-water. Thus, a relative increase of freeboard and of bow height is required, to counteract this

¹⁵ The heave/pitch motions of a ship are strongly coupled to each other and generally have comparable values of natural period, which makes the tuning/resonance of both motions with the encountered wave very undesirable. This can be overcome only by changing the course and/or the speed of the ship.

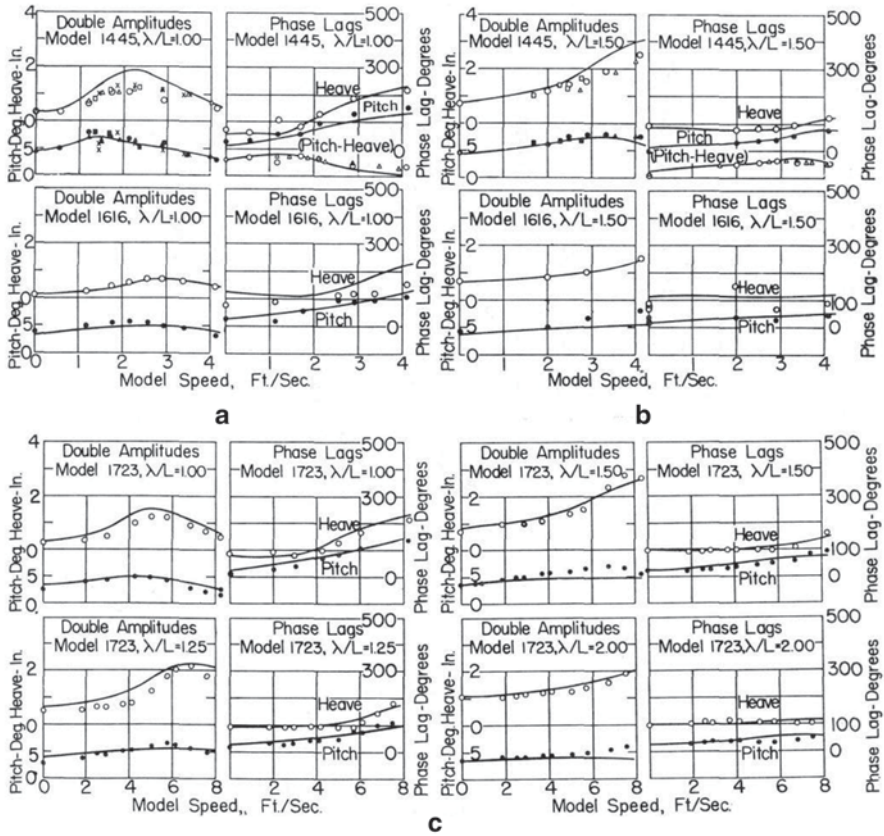

Fig. 2.44 Double amplitudes and phase lags of pitch and heave motions for two Series 60 models (a), (b) and one cruiser ship model (c) in head seas. (Lewis 1988). **Parameters:** Ratio of the incident wave length λ to the model length L and model speed; wave height for (a) and (b) is 1.25 in. and (c) 1.43 in. (model scale)

negative trend, as well as appropriate shaping (flare) of the bow sections above still water level. The study of the ship’s seakeeping, thus also parametric studies regarding the effect of the ship’s main design parameters on seakeeping, can nowadays be conducted by advanced numerical simulation methods and systematic model experiments (Fig. 2.44).

2.10.3 Effect on the Construction Cost

The construction effort to meet the requirements of a given hold volume (e.g., as determined by the transport capacity of the ship), increases for slender, sharply formed ships in terms of the weight of steel processed and the extent/weight of outfitting.

Generally, slender ships are characterized by larger steel areas per unit enclosed volume (especially for the outer hull shell), due to larger linear dimensions than bulky

and relatively short ships of the same displacement. Thus, regarding the construction effort and related costs, relatively high C_p and C_B coefficients should be favored.

2.10.4 Effect on the Exploitation of Spaces

The exploitation of hold's volume, especially with respect to the transport of standard/unitized and nonstandard break bulk cargoes (beyond the transport of containers that are transported in dedicated cellular type holds) significantly depends on the hull form of the ship and therefore on C_p and C_B .

The ideal hold space is bounded by large, unobstructed, and flat surfaces, both on the bottom and on the sides (vertical walls). Thus, small C_p and C_B coefficients, particularly in combination with V-type sections, seriously constraint the exploitation of spaces other than in the midship part.

Ships carrying standardized containers have the following peculiarity: whereas they carry a cargo that would best fit in boxlike holds and likewise hull form, their relatively high speed (and Froude number) calls for relatively small C_p and C_B coefficients; the practical solution to this problem is that at the ends of the ship the container cells are adjusted to the nonvertical side walls, so that losses of the exploitable volume are minimized to the extent possible (stepwise arrangement of containers, see below example of 3,400 TEU containership, Fig. 2.45).

Likewise, Ro-Ro ships and car ferries, with small C_p coefficients dispose reduced exploitation of the lower deck spaces in the bow region, because of their relatively high speed and sharp entrance of the waterlines in this region (see, Fig. 2.46).

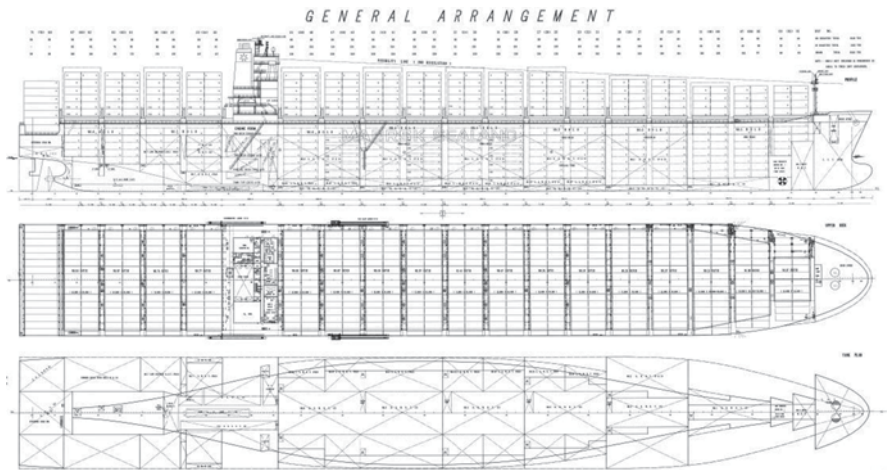

Fig. 2.45 General arrangement of 6300 TEU Containership (Shipyard Hyundai Heavy Industries Co. Ltd.)

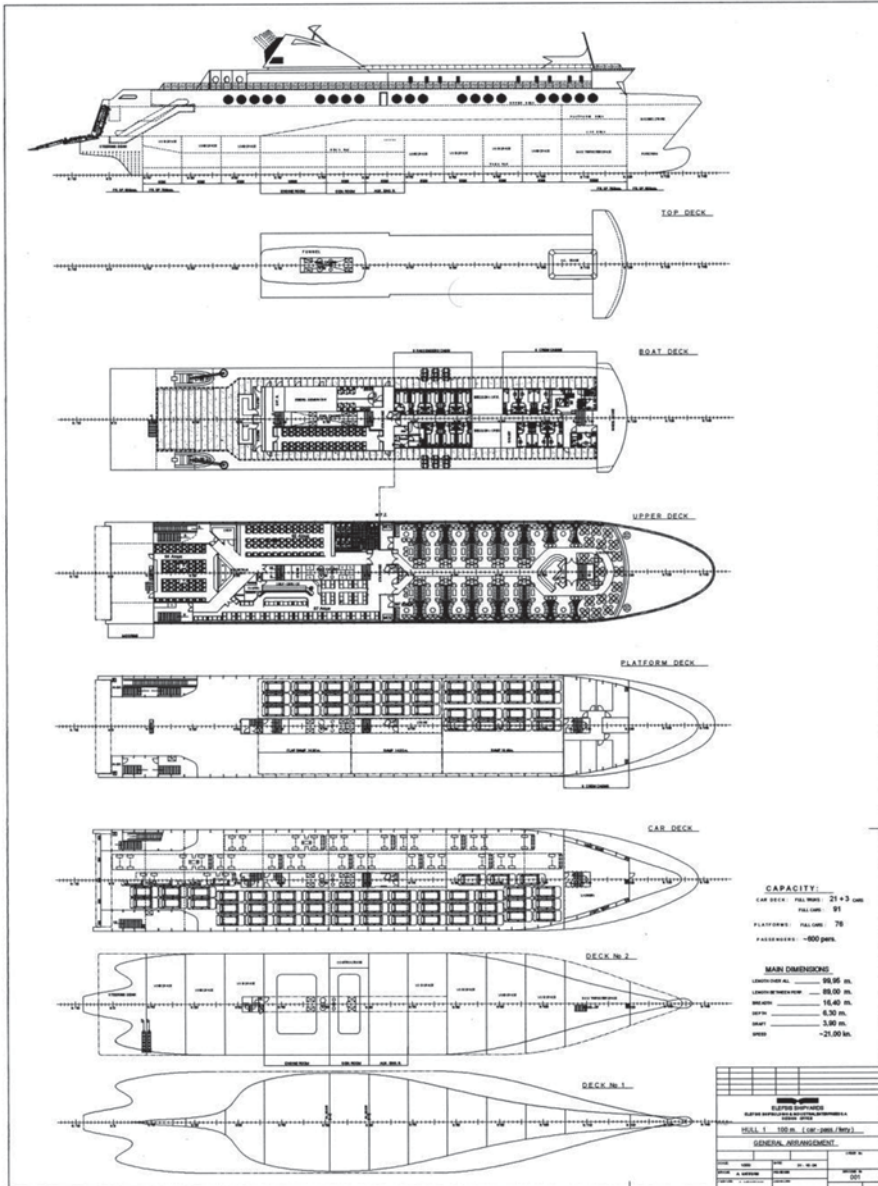

Fig. 2.46 General arrangement of a RoPax ship, Joint Industry-University RTD project EPAN-transport, NTUA-Elefsis Shipyard (2005–2007)

2.10.5 Effect on the Stability

The initial stability of the ship ($GM=KM-KG=KB+BM-KG$), the vertical position of the buoyancy center (KB), and the moment of inertia of the waterplane

about the centerline (I_T , thus also BM) can be positively influenced by small C_p coefficients, which are combined with relatively large draft and beam as well as V-type sections.

Summary—Conclusions

Likewise in the selection of length, the basic factor affecting the determination of the C_B (and C_p) coefficient is the low resistance (and powering) of the ship, for the required speed, and in combination with the pre-estimated length, for the given Froude number. Generally: *high Froude number requires a low C_B (and C_p) coefficient for a hydrodynamically optimal ship.*

Other factors affecting the selection of C_B are: the weight and the cost of steel structure, the exploitation of cargo spaces, and the seakeeping behavior of the ship in waves (the motions and accelerations at various points of the ship, as well as the added resistance due to her motions in waves). In practice, like with the selection of the ship's length, C_B is selected differently from the optimal one with respect to least resistance, namely, usually larger values than those corresponding to hydrodynamically optimal solutions are preferred.

2.10.6 Approximate/Semiempirical Formulas

Common ways of estimating the value of C_B are:

- A. Using semiempirical mathematical formulas from statistical data of built ships (considering both hydrodynamic and economic criteria).
- B. Using semiempirical mathematical formulas from statistical analysis of ships of “minimum building cost for given deadweight (DWT) and speed.”
- C. Using diagrams based on mathematical formulas according to A or from statistical data of similar ships.

Notes

- A. The employed semiempirical formulas have the following general form (in metric system):

$$C_B = K_1 - K_2 F_n - K_3 F_n^2 \quad (2.86)$$

where the coefficients K_1 , K_2 , K_3 are listed in Table 2.15 below (they may refer to the ship's *trial* speed V_T or *service* speed $V_S \approx 0.94 V_T$).

Table 2.16 summarizes similar, well known formulas given in the Anglo-Saxon/British Imperial system (V [kn] and L [ft]), which take the general form:

$$C_B = K_4 - K_5 V / \sqrt{L} \quad (2.87)$$

where V is mainly the trial speed, unless otherwise noted.

Table 2.15 Coefficients of semiempirical formulas for the calculation of C_B (metric system units)

| Formula | K_1 | K_2 | K_3 | Comments |
|-------------|-------|-------|-------|-----------------------------------|
| Horn | 1.06 | 1.68 | 0 | Single-screw ships, service speed |
| Ayre | 1.08 | 1.68 | 0 | Single-screw, trial speed |
| Ayre | 1.09 | 1.68 | 0 | Twin-screw, trial speed |
| Heckser | 1.00 | 1.44 | 0 | Single-screw, trial speed |
| V. Lammeren | 1.08 | 1.68 | 0.224 | Single-screw, trial speed |

Table 2.16 Coefficients of semiempirical formulas for the estimation of C_B (Anglo-Saxon system of units)

| Formula | K_4 | K_5 | Comments |
|-----------------------|-------|-------|---|
| Alexander and Watson | 1.06 | 0.500 | $0.65 \leq V / \sqrt{L} \leq 0.8$ (cargo ships) |
| | 1.03 | 0.500 | $V / \sqrt{L} > 0.89$ (fast cargo ships) |
| | 1.12 | 0.500 | $V / \sqrt{L} < 0.65$ (slow cargo ships) |
| Silverleaf and Dawson | 1.214 | 0.394 | bulky ships, $C_B \geq 0.75$, length L [m] |
| Chirila | 1.225 | 0.378 | bulky ships, $C_B \geq 0.75$, length L [m] |
| Troost | 1.156 | 0.625 | Service speed $V_S \cong 0.94 V_T$ |

B. The below given formulas are derived from optimization studies of ships with respect to minimum building cost for given deadweight and speed (Schneekluth 1985):

$$C_B = \frac{0.14}{F_n} \frac{L/B + 20}{26} \quad (2.88)$$

$$C_B = \frac{0.23}{F_n^{2/3}} \frac{L/B + 20}{26} \quad (2.89)$$

The formulas are valid for $0.14 \leq F_n \leq 0.32$ and are limited to ships with $0.48 \leq C_B \leq 0.85$.

C. Finally, the following diagrams or comparable graphs of $C_B = f(F_n)$ as a function of the ship type (see Figs. 2.47 and 2.48) can also be used.

2.11 Midship Section Coefficient C_M

The midship section coefficient C_M , which, as mentioned above, connects the most important hull form coefficients C_B and C_p , can be selected quite freely by the designer, taking into account some basic factors such as low resistance, ease for construction, space exploitation, and sufficient stability. For a given midship section area A_M , B , and T , thus also fixed C_M , the possibility of alternative configuration of the midship section is associated with the selection of the bilge radius and the deadrise of the bottom (see Fig. 2.49).

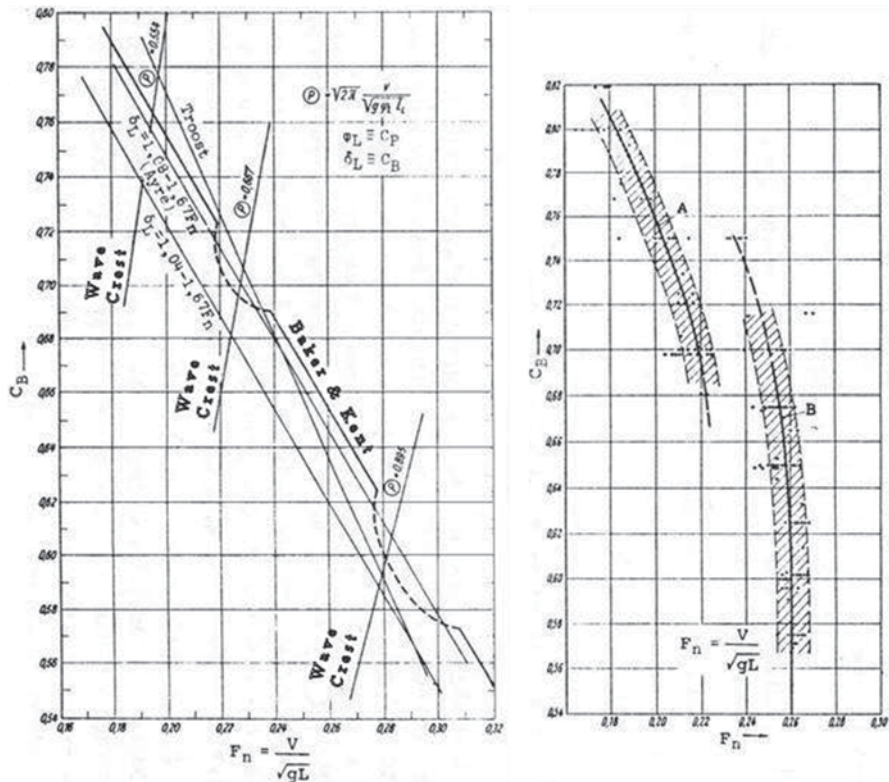

Fig. 2.47 Block coefficients C_B versus Froude number. (a) Regions for the favorable selection of C_B to avoid tuning of ship generated, bound waves according to Baker and Kent (b) Regions for the selection of C_B and statistical data according to Danckwardt for slow (A) and fast (B) ships

2.11.1 Effect on Resistance

The influence of C_M on the total resistance of a ship is considered to be small, but results indirectly through the C_p for given displacement and main dimensions. The individual effects of C_M are:

- a. For slow ships with substantial frictional resistance, a minimization of the wetted surface is targeted. Therefore, for unrestricted beam and draft, and assuming an optimal B/T around 2.25, it can be demonstrated that the optimum C_M is about 0.80¹⁶, as the wetted surface is getting minimal at this range. However, as the draft is often limited (for large ships and generally for Ro-Ro/RoPax ferry ships, due to the enhanced stability requirements and consequently the B/T ratio is larger than optimal), significantly larger C_M than 0.80 results in practice.

¹⁶ It is reminded that the midship sectional coefficient of a half sphere, which is the solid with minimum surface for given volume, is $\pi/4 \approx 0.7854$.

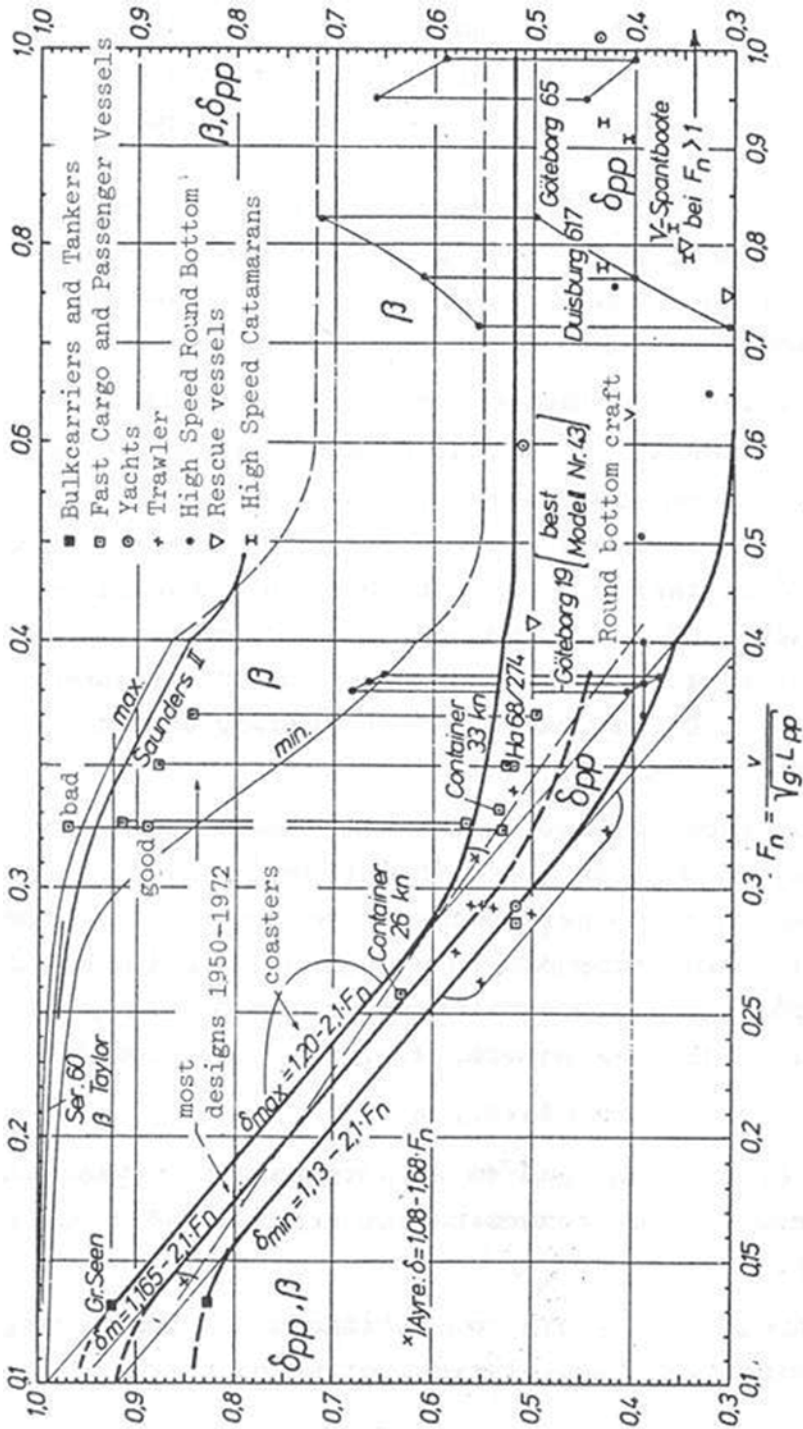

Fig. 2.48 Regions of favorable selection of block coefficient $\delta \equiv C_B$ and midship section $\beta \equiv C_M$

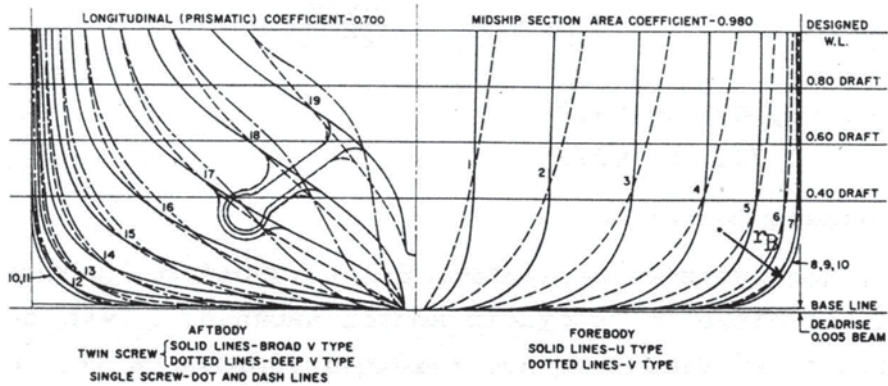

Fig. 2.49 Relationship of bilge radius and deadrise to ship's midship section coefficient

- b. Generally for given displacement and main dimensions, i.e., given C_B , an increase of C_M causes an increase of the wetted surface area, lengthening of the transverse flow streamlines, and stronger irregularities in the distribution of the velocity field around the hull, which all contribute to increased frictional and eddy (pressure–viscous) resistance components.
- c. On the other hand, for fast ships, where the objective is to minimize the wave-making resistance, it is sought to shift the displacement as downward as possible, even accepting an increase of the local sectional breadth over the draft, compared to that at the waterline, thus forming the hull so that eventually $C_M > 1.0$ (for 'bulbous' type sections). Also, due to the increase of the length of entrance of the sectional area curve, for increased C_M and midship sectional area, a wave-making resistance reduction may be expected (see Fig. 2.50).
- d. The water flow in the transverse direction especially in the bilge area, is significantly disturbed for large C_M and small bilge radius, resulting in flow separation, generation of eddies, and an increase of corresponding resistance components. Thus for given C_M , it is appropriate to seek a sufficient bilge radius and small deadrise of the bottom.

2.11.2 Effect on Construction Cost

The construction effort and particularly the required man-hours for the steel structure manufacturing are reduced in dependence on the extent of fitted flat panels, on the limited number of plates and reinforcements to be bended, and the extent of the ship's parallel body having a constant bilge radius for a certain length of the ship. Thus, a larger possible C_M , small bilge radius (circular instead of parabolic form), and a small or zero deadrise of the bottom, are targeted from the easiness and cost of construction point of view.

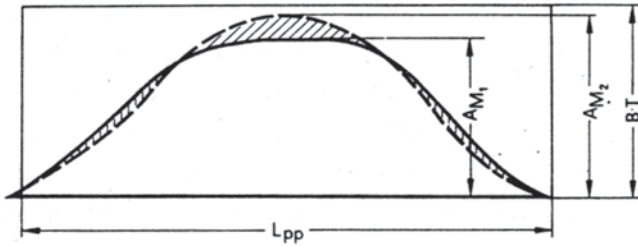

Fig. 2.50 Distribution of sectional area for the same displacement and main dimensions, but different C_M

2.11.3 Effect on Space Exploitation

Especially for ships transporting break or unitized cargo, the demand for larger hold volumes, and flat and rectangular hold surfaces, leads to large C_M coefficients, with a small bilge radius, vertical walls, and long parallel body around amidships.

For containerships, because of the transportation of standard containers in the cells and the unique size of container boxes, it is not recommended to select C_M with criterion the possible fitting in holds of a limited number of additional boxes, which would lead to large C_M values and a small bilge radius; it is rather better to look at the negative effect on the ship's resistance/powering, what is significant for fast¹⁷ cargo ships, like for containerships.

2.11.4 Effect on Stability

It is possible to increase the initial stability of the ship with an increase of the vertical position of the center of buoyancy and the increase of the breadth on the ship's loaded waterplane. This leads to V-type sections, large drafts, and small C_M coefficients.

If the midship section area A_M is presumed given, then for fixed draft T , an increase of the beam B leads to a reduction of C_M and a significant increase of the initial stability due to the increase of moment of inertia I_T (see Fig. 2.51a).

Also, again for given A_M and fixed beam, increase of the draft T leads to a reduction of C_M and small increase of the initial stability due to the rising of \overline{KB} (see Fig. 2.51b).

Both the aforementioned effects are important for vessels with special stability and propulsion requirements (enabling the fitting of as large as possible propeller

¹⁷ The introduction of "slow steaming" in container shipping in recent years partly affected these considerations; it is noted, however, that despite "slow steaming" in practical operation, containerships continue to be designed as "fast" cargo ships, but taking into account a "slow steaming" operation over certain period of their "life cycle."

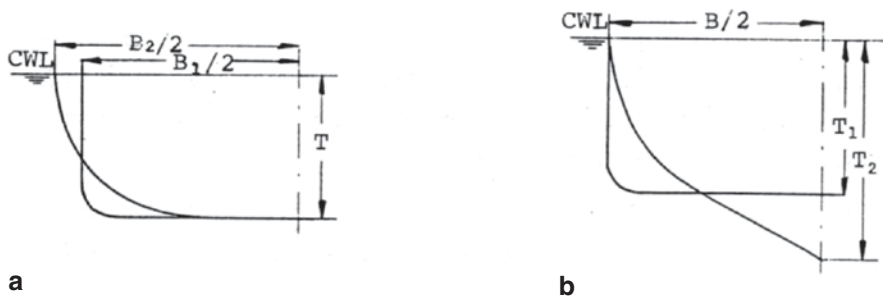

Fig. 2.51 Effect of variation of beam and draft on BM and KB . **a** $A_M = \text{const}$, $T = \text{const}$ ($B_1 < B_2$, $C_{M2} < C_{M1}$) ($BM_2 > BM_1$, $KB_2 > KB_1$). **b** $A_M = \text{const}$, $T = \text{const}$ ($T_1 < T_2$, $C_{M2} < C_{M1}$) ($BM_2 = BM_1$, $KB_2 > KB_1$)

diameter that requires large draft), such as tugboats and fishing ships, for which we observe small C_M coefficients in practice.

2.11.5 Effect on Seakeeping Performance

Generally, ships with small C_M coefficients are sensitive to roll motions due to the reduced damping for the rotational motions about the longitudinal axis. The damping is proportional to the resistance resulting from the transverse water flow and obviously it increases for large coefficients C_M ('squared' sections) and small bilge radius (triggering flow separation).

The normal way of increasing roll damping is to install bilge keels or vertical keels (to small boats), and to larger ships to fit stabilizing fins and antirolling tanks.

The bilge keels' width is usually about or larger than 2% of the beam of the ship, or 30% of the bilge radius of the midship section. Their length is about 25% of the ship's length. The design and proper fitting of the bilge keels are only possible through the conduct of model experiments (or numerical computations CFD) due to the required alignment with the streamlines around the hull so as to avoid the strong increase of pressure-viscous resistance of the vessel when sailing in calm water (Figs. 2.52 and 2.53).

The aforementioned factors, which are in a sense contradictory and mutually exclusive, have in practice led to the following options:

- Generally the C_M coefficient is chosen according to the C_B and decreases for small C_B and high Froude numbers (see Figs. 2.54 and 2.55).
- For small high speed craft with $Fn \geq 0.40$ the C_M may also be reduced for stability reasons.
- Below the limit of $C_M = 0.65$, as shown in Fig. 2.33, it may reach values of 0.50, so as to satisfy the requirements on stability and sufficiency of deck area. This applies, in moderate form, to fishing and tug boats.

Fig. 2.52 Bilge keel on a tug boat



Fig. 2.53 Fin stabilizer on a cruise ship

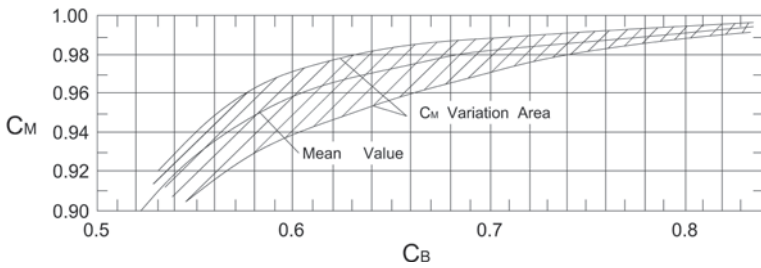

Fig. 2.54 Midship section coefficient versus block coefficient

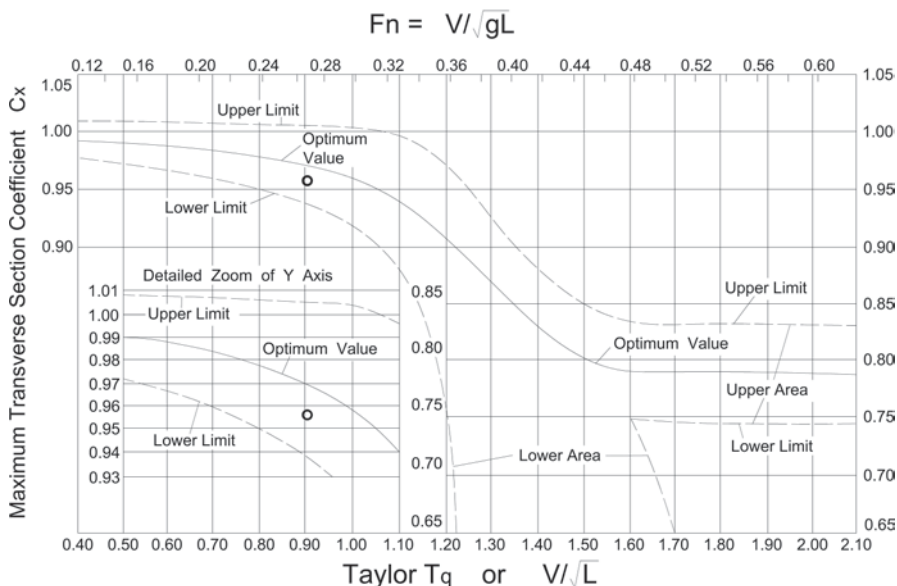

Fig. 2.55 Regions for the selection of the maximum transverse sectional (in general midship) area coefficient versus Froude number or Taylor speed-length ratio

2.11.6 Approximation Formulas

A. Coefficient C_M (large ships without deadrise) Van Lammeren

$$C_M = 0.9 + 0.1C_B \tag{2.90}$$

Kerlen (1979)

$$C_M = 1.006 - 0.0056C_B^{-3.56} \tag{2.91}$$

Laboratory HSVA (Hamburg)

$$C_M = 1/(1 + (1 - C_B)^{3.5}) \tag{2.92}$$

The above formulas can be applied to relatively large ships with a normal L/B ratio.

Tables (see Table 2.6)

Large ships

$$C_M = 0.93 \text{ to } 0.997$$

Small craft (tugs, fishing boats, small ferries)

$$C_M = 0.7 \text{ to } 0.9$$

Table 2.17 Typical sizes of bilge radius and bottom deadrise

| | r_B [m] | d_R [m] |
|---------------------------|-----------|-----------|
| Cargo | 2.0–2.7 | 0.0–0.2 |
| Tankers and bulk-carriers | 2.0–3.0 | 0.0 |
| Reefers | 2.0–2.7 | 0.0–0.5 |
| Passenger ships | 3.5–5.5 | 0.0–0.5 |
| Ferries | 3.5 | 0.0–0.6 |

B. Bilge radius (Schneekluth—without deadrise)

$$r_B = \frac{B \cdot C_K}{\left(\frac{L}{B} + 4\right) C_B^2}, \quad C_K = 0.5 \div 0.6.$$

If the above formula is applied to ships with deadrise of height d_R , then the coefficient C_B should be corrected as follows:

$$C_B = C_B \cdot T / (T - 0.5d_R) \tag{2.93}$$

The following relationship between C_M and r_B (empirical) is valid for ships *without deadrise* (Table 2.17; Fig. 2.56):

$$C_M = 1 - \frac{r_B^2}{2.33 \cdot B \cdot T} \tag{2.94}$$

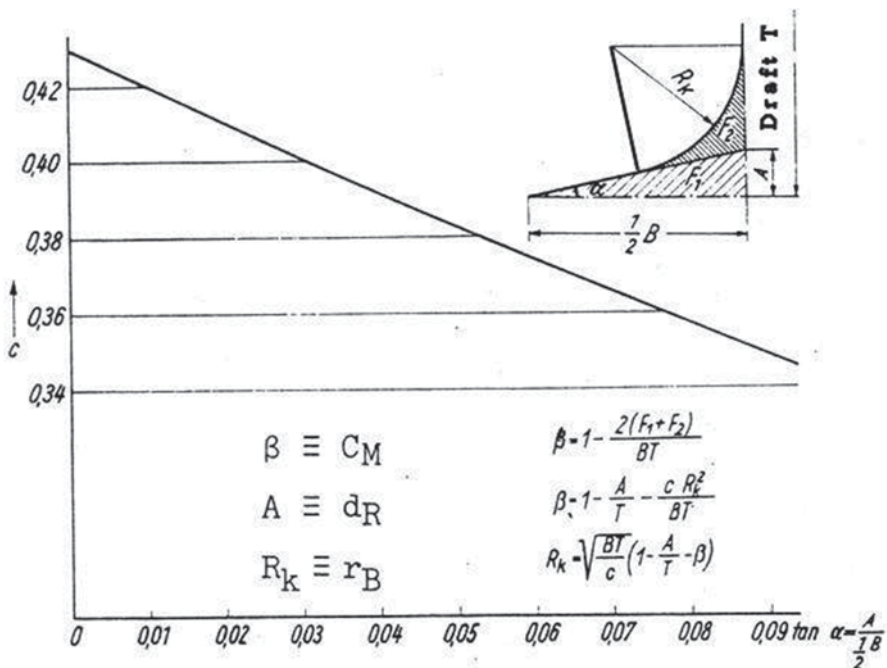

Fig. 2.56 Bilge radius and deadrise according to Henschke (1964)

C. Typical sizes of bilge radius and bottom deadrise

2.12 Waterplane Area Coefficient C_{WP}

The C_{WP} coefficient, which expresses the degree of fullness of the waterplane area in relation to the circumscribed rectangle of length L and width B , is significantly influenced by the form of the transverse sections and by the coefficients C_B and C_M (C_P).

Usually, the C_{WP} coefficient is selected in the preliminary design context so that the stability requirements are satisfied, i.e., namely relatively high C_{WP} values are selected, which affect negatively the ship's resistance (wave-making).

It is however more appropriate to consider in the preliminary selection of C_{WP} values around the lower typical limits and develop the shiplines almost independently from a pre-selected C_{WP} value. This leads to hydrodynamically favorable shiplines, without the C_{WP} value being a constraint for achieving adequate stability. Problems of insufficient stability should be rather treated with more drastic means, for example, change of the main dimensions (beam), of weight distribution, of sectional form character, etc.

2.12.1 Effect on Stability

The beam and the waterplane area coefficient influence decisively the calculation of the transverse moment of inertia of the ship's waterplane area, namely, for a given displacement, the magnitude of the vertical distance of the transverse metacenter from the buoyancy center \overline{BM} . Accordingly, the length and the C_{WP} coefficient affect the value of the longitudinal metacenter \overline{BM}_L .

It is obvious that the moment of inertia of the waterplane area increases as the coefficient C_{WP} increases, likewise the values of \overline{BM} and \overline{BM}_L . Meanwhile, assuming constant sectional areas, thus, for given displacement and distribution of it, an increase of C_{WP} leads to V sections with high center of buoyancy, namely to increase of \overline{KB} . Overall, an improvement of the *form stability* results, namely of \overline{KM} , which is mitigated somewhat by the less pronounced increase of \overline{KG} , due to the application V type sections.

The influence of C_{WP} on stability can be approximated as follows: The transverse moment of inertia I_T is considered at first to be known from the formula:

$$I_T = C_{IT} \cdot I_{T*}$$

where

I_{T*} : moment of inertia of the circumscribed rectangle of length L and width B , which is equal to $B^3 \cdot L / 12$

C_{IT} : coefficient of specificity of form of waterplane area, $C_{IT} \leq 1.0$.

If we set: $I_T = A_{WP} \cdot r_T^2$

where A_{WR} : waterplane area, r_T : radius of inertia of waterplane, and consider it according to Hovgaard:

$$r_T = B \cdot (0.0106 + 0.0727C_{WP})^{1/2},$$

then it is concluded for the coefficient of specificity of form:

$$C_{IT} = C_{WP} (0.1272 + 0.8724C_{WP}) \tag{2.95}$$

Accordingly it applies to the longitudinal moment of inertia:

$$I_L = C_{IL} \cdot I_{L^*} = A_{WP} \cdot r_L^2$$

where $I_{L^*} = B \cdot L^3 / 12$ and $r_L = L(0.091C_{WP} - 0.013)^{1/2}$.

Thus, the specificity of form coefficient for the longitudinal moment of inertia is given by:

$$C_{IL} = C_{WP} (1.092C_{WP} - 0.156) \tag{2.96}$$

The relationship of coefficient C_{WP} with the transverse waterplane specificity of form coefficient C_{IT} is given in the following figures for typical single-screw and multi-screw ships versus the prismatic coefficient C_p (Fig. 2.57).

In the preliminary design stage, the initial stability may be approximated by using the above figures as following.

From the well-known formula of Morrish it shows:

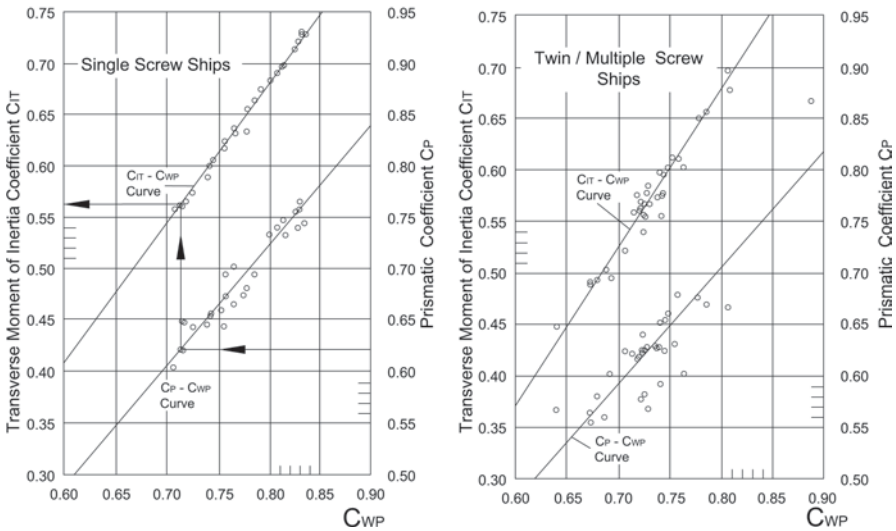

Fig. 2.57 Waterplane area specificity of form coefficient C_{IT} vs. C_{WP} and C_p for single- and twin-screw ships

$$\overline{KB} = T - \frac{1}{3} \left(\frac{T}{2} + \frac{\nabla}{A_{wp}} \right)$$

and based on the approximation of coefficient C_{IT} the moment of inertia I_T is concluded:

$$I_T = C_{IT} \cdot L \cdot B^3 / 12$$

The metacentric radius is determined by:

$$\overline{BM} = I_T / \nabla$$

and consequently the metacentric height:

$$\overline{KM} = \overline{KB} + \overline{BM}$$

Based on the estimation of \overline{KG} (see Sect. 2.15) the resulted \overline{GM} can be evaluated by:

$$\overline{GM} = \overline{KM} - \overline{KG}$$

which should not be smaller than about 0.06B in general, whereas other more specific stability criteria also apply regarding the min GM value (see Sect. 2.18).

2.12.2 Effect on Resistance, Propulsion, and Seakeeping Performance

The influences of C_{WP} on the various aspects of the ship's hydrodynamic performance (resistance, propulsion, behavior in waves) are diverse and complicated.

For relatively slow ships, high prismatic coefficient values and an almost evenly, lengthwise distributed displacement lead to a center of buoyancy (and center of flotation in general) forward of amidships; the waterplane lines are very full, especially forward of the midship section. The local waterplane area coefficient, forward of midship, can reach values of 0.90 to 0.95 (tankers and bulkcarriers). In this way the wetted surface of the ship's hull is minimized, for given displacement, and the frictional resistance is reduced.

On the other hand, abaft the midship section, the fullness of the waterplane lines and the local C_{WP} value declines (to about 0.80) so as to achieve a favorable flow to the propeller and to avoid strong flow separation (which increases the eddy/pressure viscous resistance).

For relatively fast ships, with a significant percentage of wave-making resistance, high C_{WP} values will lead to the generation of intense local waves at both the entrance and the run of the waterlines, as well as around the shoulders. An

extremely sharp waterline at the ends is favored to avoid intense waves in the bow and stern region; however, this may result particularly to more pronounced local waves around amidships. Generally, for a given speed (Froude number) and beam, the optimal C_{WP} values decrease with the increase of Froude number.

As to the influence of C_{WP} on the ship's performance in waves (motion amplitudes and phases, added resistance in waves), it has been observed in experiments and computations that high C_{WP} values, i.e., very full waterplane lines at the bow, have negative influence on seakeeping, especially on the sailing of the ship in head seas due to likely slamming problems etc.

2.12.3 Approximation Formulas

In general, the waterplane fullness coefficient C_{WP} is a function of block coefficient C_B and of the character of the ship's sections. Special types of ships with a large L/B ratio are likely to have both U and V sections, whereas a small L/B ratio is mainly associated with intense V sections. In addition, ships with relatively small B/T ratio are combined with high C_{WP} values to achieve sufficient stability and deck area.

The basic empirical formulas for the approximation of C_{WP} in the preliminary design phase are:

Intense U type sections

$$C_{WP} = 0.95C_p + 0.17(1 - C_p)^{1/3} \text{ (Schneekluth)} \quad (2.97)$$

or

$$C_{WP} = 0.778C_B + 0.248$$

Normal sections

$$C_{WP} = (1 + 2C_B)/3 \quad (2.98)$$

Intense V type sections

$$C_{WP} = (1 + 2C_B/C_M^{0.5})/3 \text{ (Schneekluth)} \quad (2.99)$$

or

$$C_{WP} = 0.793C_B + 0.297.$$

The formulas are applicable at first only to ships with cruiser stern. Ships with transom stern generally have higher C_{WP} values. For ships with significant overhang of the wetted part of the stern beyond the aft perpendicular, the correction of the C_{WP} with the following coefficient is applied:

$$K = 1 + C_p \cdot (0,975L_{WL} - L_{pp}) / L_{pp} \quad (2.100)$$

2.12.4 Conclusions

- To achieve satisfactory *form* stability, the increase of beam B should be preferred, which affects more drastically the moment of inertia of the ship's waterplane area, rather than the C_{WP} .
- In the preliminary design phase and when using approximate formulas the selection of high C_{WP} values must be avoided, as these values may be reduced in the course of the ship's design (development of ship lines), resulting in poor stability.
- In the transom stern case, which is always accompanied by high C_{WP} values, it needs to be considered that a possible stern emergence due to trim, motions in waves, etc., will cause a considerable loss of waterplane area and hence of stability (drastic \overline{GM} reduction). In specific seaway conditions (following and head seas), this may lead some ships to severe roll motions (*Mathieu instabilities and parametric roll phenomena*).

2.13 Determination of the Main Dimensions Through the Ship Design Equation

The “design equation” (in German *Entwurfsgleichung*, Schneekluth 1985) leads to the determination of the main dimensions of a study ship through the selected ratios of main dimensions and form coefficients of similar ships. In case of lack of data from similar ships, then empirical formulas and data from empirical diagrams, which are supposed to be applicable to the current ship type, can certainly be used.

The “design equation” is derived from the already known “displacement equation” (see Appendix C). As is well known, it holds for the displacement (weight):

$$\Delta = \rho_{sw} \cdot g \cdot \nabla^* \quad (2.101)$$

where

ρ_{sw} : density of sea water

Δ^* : volume of displaced water = $C_B \cdot L \cdot B \cdot T \cdot k_A$

k_A : coefficient of correction of the displaced volume (design—molded volume) for average shell thickness, appendages, etc. (see Sect. 2.15).

Introducing the ratios L/B and B/T , which, as known, significantly influence both the ship's resistance (L/B) and stability (B/T), the form of the displacement equation can be rearranged as follows:

$$\Delta = \rho_{sw} \cdot g \cdot (L/B) \cdot B^2 \cdot [B/(B/T)] \cdot C_B \cdot k_A$$

or

$$\Delta = \rho_{sw} \cdot g \cdot C_B \cdot [(L/B)/(B/T)] \cdot B^3 \cdot k_A$$

Thus, the following expression is concluded for the beam:

$$B = \left[\frac{\Delta \cdot (B/T)}{\rho_{sw} \cdot g \cdot C_B \cdot (L/B) \cdot k_A} \right]^{1/3} \quad (2.102)$$

thus, the beam is the only unknown in the above displacement equation, assuming the right hand side known.

Likewise, for known (L/B) and (L/T) ratios from similar ships, the following expression for the ship's length is concluded:

$$L = \left[\frac{\Delta \cdot (L/B) \cdot (L/T)}{\rho_{sw} \cdot g \cdot C_B \cdot k_A} \right]^{1/3}$$

As mentioned earlier (see Sect. 2.1), for *deadweight carriers* the estimation of displacement Δ through the transport capacity (DWT) is readily possible; also, the ratios (B/T) , (L/B) and (L/T) and C_B coefficient can be estimated from data of similar ships.

For *volume carriers* the above methodology may be modified by including (instead of the displacement) the *underdeck-volume*, ∇_D namely the ship's displaced volume up to a waterline at the height of the main deck:

$$\nabla_D = C_{BD} \cdot L \cdot B \cdot D$$

where C_{BD} : hull coefficient for a waterline at the height of D (main deck) (see Sect. 2.15.4 approximation formulas, function of C_B).

Thus, we have for the beam

$$B = \left[\frac{\nabla_D \cdot (B/D)}{C_{BD} \cdot (L/B)} \right]^{1/3} \quad (2.103)$$

Assuming that the required volume ∇_D can be estimated for the volume carriers (see Sect. 2.17.2), the further process resembles the previously described for deadweight carriers, provided that the ratios (B/D) , (L/B) and the C_{BD} are known from similar ships.

2.14 Preliminary Estimation of Propulsive Power

During the ship's conceptual/preliminary design, the *exact* knowledge of the required propulsive power for achieving the speed specified in owner's requirements *is not required*; this also applies to the other hydrodynamic ship characteristics, which relate to the selection of the propeller and the rudder.

In a ship's initial design phase, which eventually aims at a first approximation of the ship's total weight (including the weight of the machinery installation and the approximate required engine room volume) and of the corresponding displacement of the ship, a *preliminary estimation* of the ship's propulsive power is enough for the calculation of the weight (and engine room volume) of the propulsion plant and

fuel. This approximation can be based on empirical formulas, data of similar ships or diagrams deduced from statistical data for various types and sizes of ships.

Commonly used approximate methods¹⁸ for the estimation of the preliminary propulsive power P (installed power) of the ship are:

a. British Admiralty formula

$$C_N = \frac{\Delta^{2/3} V^3}{P} \quad (2.104)$$

where

Δ : displacement [t], V : speed[kn], P : installed power in [HP] or [kW].

The Admiralty constant C_N can be calculated from data of similar (parent) ships based on the *same reference units* for Δ , V and P , [tons], [kn], and [HP] or [kW]. In the use of this method it is tacitly assumed that the *parent (similar)* ships have similar hull form and not significant differences in the Reynolds and Froude numbers (i.e., *the length and speed must be about the same*). The formula can be used for the estimation of the brake horsepower P_B , or shaft power P_S or delivered or effective power, depending on the availability of data from the parent ship; also, the constant can be given in other units, for example, V [m/s], P [kW], assuming that C_N is appropriately defined and used.

Variation of the Admiralty formula by Völker (1974):

$$P_D = \frac{\Delta^{0.567} V^{3.6}}{1671 \cdot \eta_D} \cong \Delta^{0.567} V^{3.6} \cdot 10^{-3} \quad (2.105)$$

where Δ [t], V [kn], P [kW] (see also Fig. 2.58 by Völker (1974), P_D [HP]).

A similar to the British Admiralty constant was more recently introduced by Heickel (Papanikolaou 2002):

$$K = (\sqrt{V} / P_B)^{1/3} \cdot V_T, \quad (2.106)$$

where Δ is the displaced volume in m^3 , V_T the trial speed in [m/s] and P_B the brake horsepower in [kW] (Fig. 2.59).

¹⁸ The following semi-empirical methods proved in practice satisfactory for the for more precise calculation of the total resistance and powering of common types of ships in the preliminary design phase:

Holtrop, J., Mennen, G. G. J., "An Approximate Power Prediction Method," Journal International Shipbuilding Progress, 29(335), July 1982.

Holtrop, J., "A Statistical Re-analysis of Resistance and Propulsion Data", Journal International Shipbuilding Progress, 31(363), November 1984.

Hollenbach, U., "Estimating Resistance and Propulsion for Single-Screw and Twin-Screw Ships in Preliminary Design", Proc. of the 10th ICCAS Conference, Cambridge, MA, June 1999.

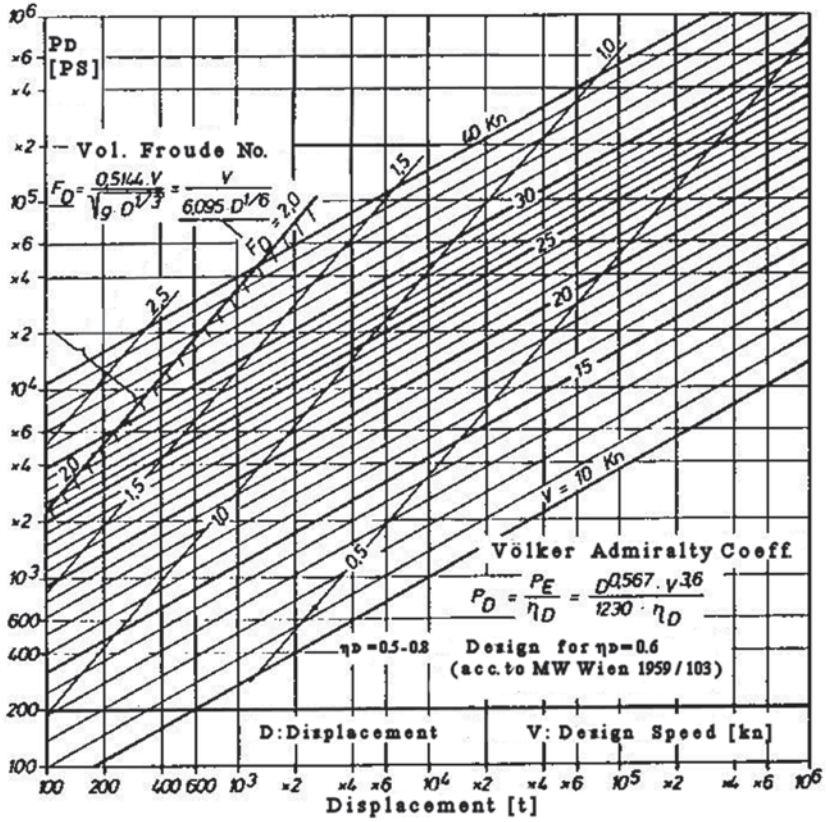

Fig. 2.58 Approximation of propulsion power versus displacement and volumetric Froude number by Völker (1974)

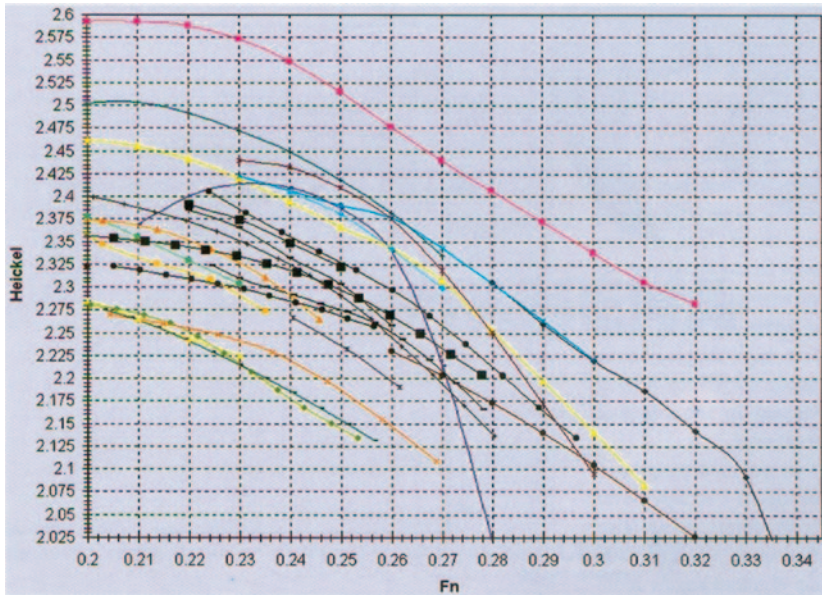

Fig. 2.59 Heickel Coefficients for modern Ro-Ro ships according to Deltamarin. (Papanikolaou 2004)

b. Use of diagrams and empirical formulas

The use of the following empirical diagrams by MAN B&W and Harvald is recommended for dry cargo and liquid cargo ships with common type of propulsion plants (Figs. 2.60, 2.61, and 2.62).

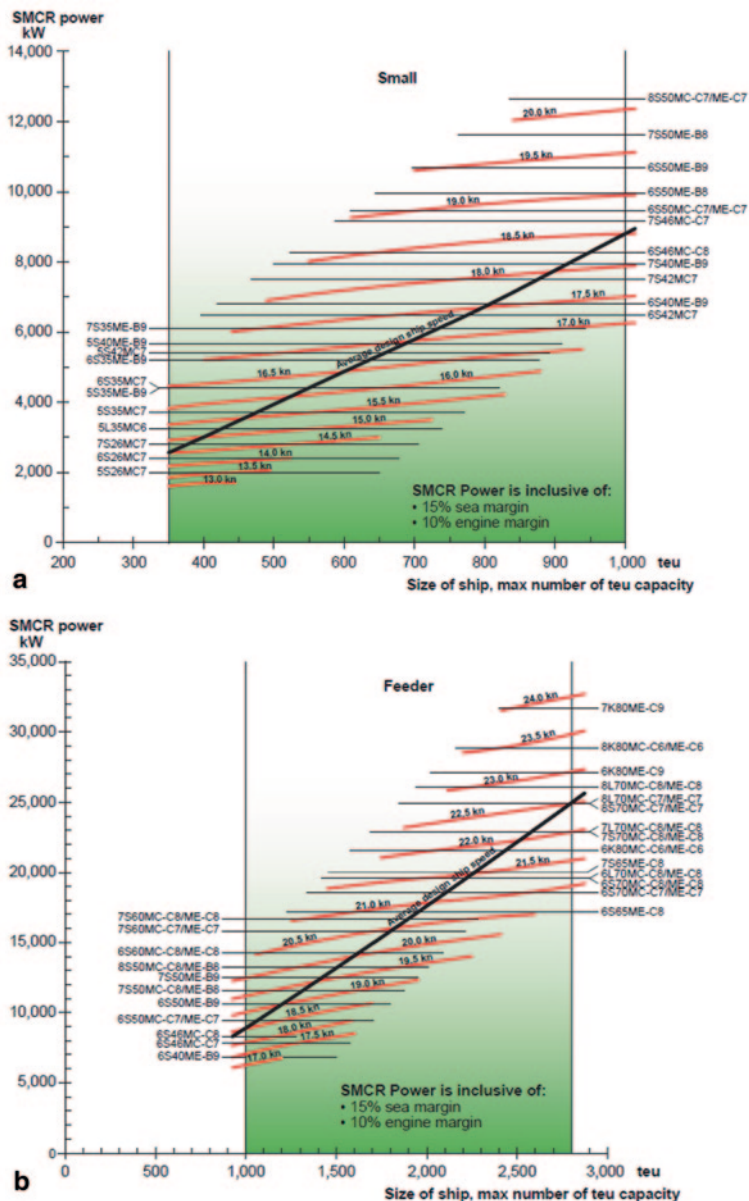

Fig. 2.60 Diagrams of installed propulsion power for containerhips versus DWT and speed V [knots]

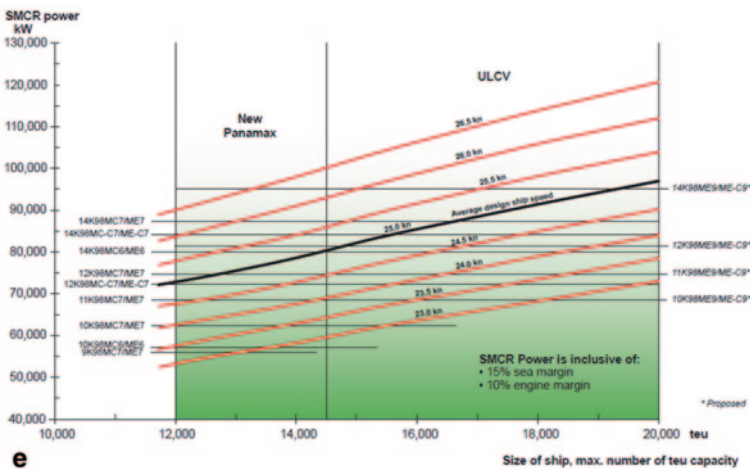
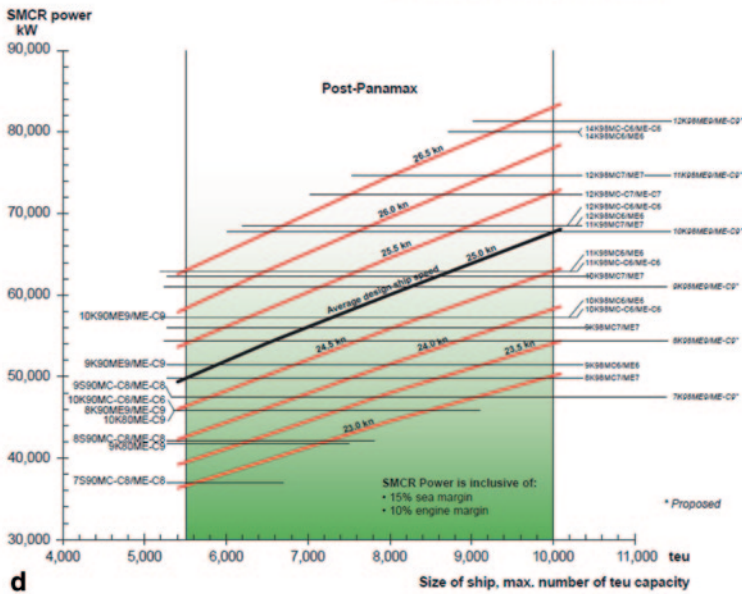
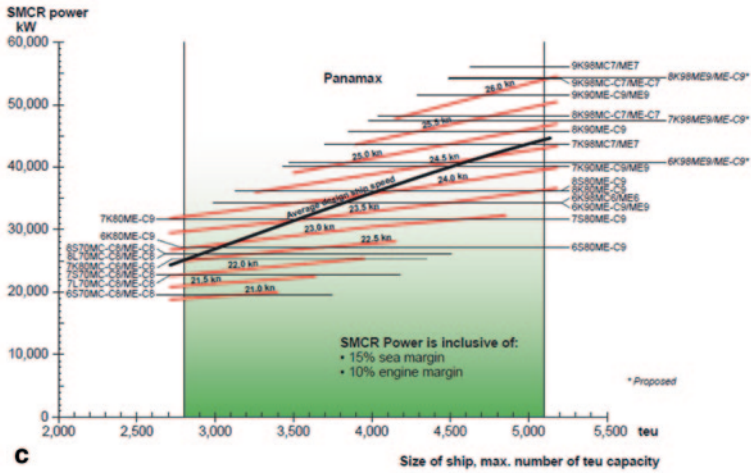

Fig. 2.60 (continued)

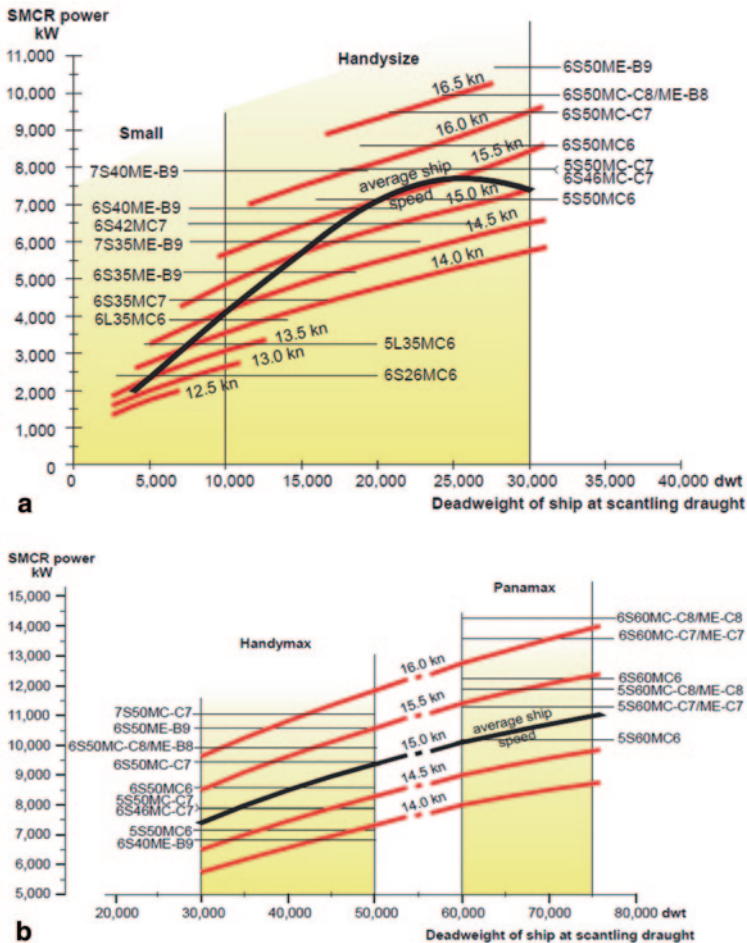

Fig. 2.61 Diagrams of installed propulsion power for tankers versus DWT and speed V [knots]

b1. Estimation of the installed horse power of modern ships by MAN B&W Diesel A/S (2005)

- Figs. 2.60 a, b, c, d, e $SMCR = f(TEU, V)$, Container ships
- Figs. 2.61 a, b, c, d $SMCR = f(DWT, V)$, Tankers
- Figs. 2.62 a, b, c $SMCR = f(DWT, V)$, Bulk carriers

where SMCR: specified maximum continuous rating

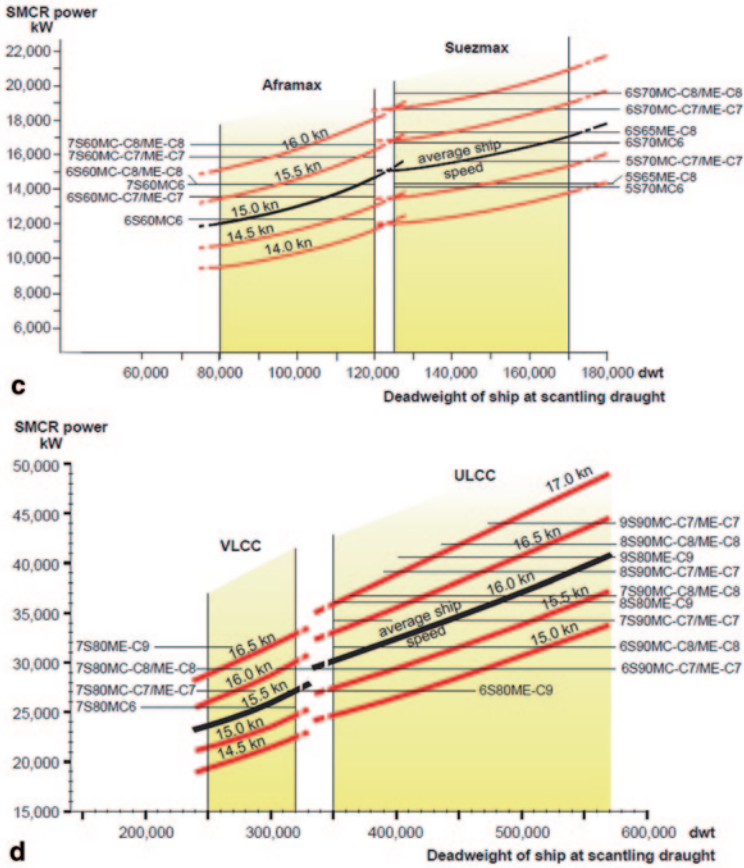

Fig. 2.61 (continued)

b2. Estimation of the installed horse power of ships according to Harvald

Fig. 2.63 $P_B = f(\Delta, V, L/\nabla^{1/3}), C_B = 0.60$

Fig. 2.64 $P_B = f(\Delta, V, L/\nabla^{1/3}), C_B = 0.70$

Fig. 2.65 $P_B = f(\Delta, V, L/\nabla^{1/3}), C_B = 0.80$

where P_B : break horse power

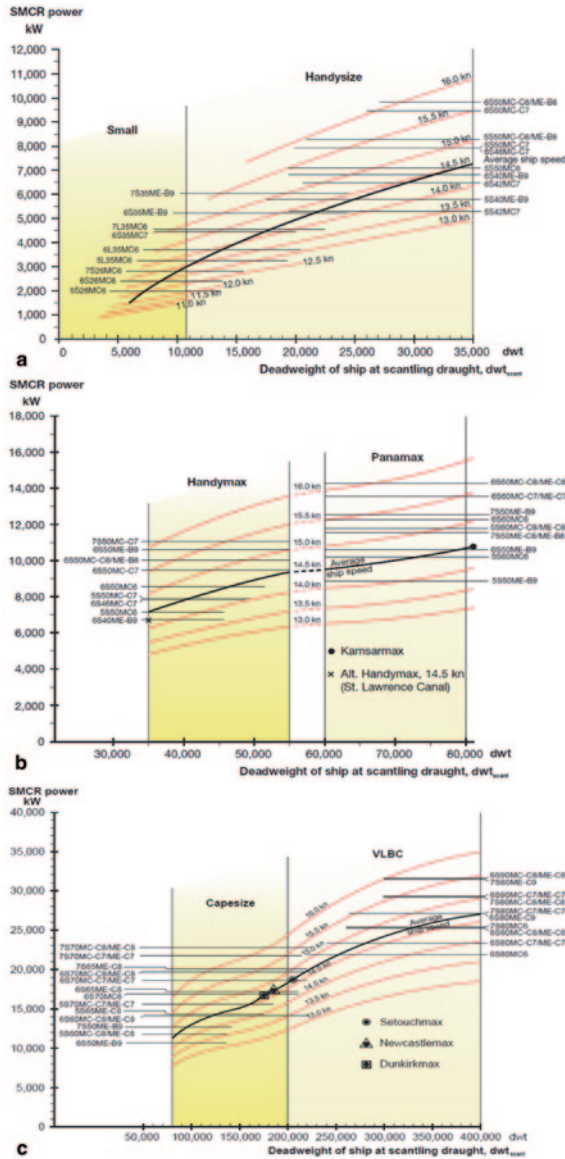

Fig. 2.62 Diagrams of installed propulsion power for Bulk Carrier versus DWT and speed V [knots]

Limits of parameters

- TEU = (400) to 18,000
- DWT = (2,000) to 580,000 t
- V = (11) to 26.5 knots
- Δ = (100) to $100 \cdot 10^4$ t (Figs. 2.63, 2.64, and 2.65)
- $L/\nabla^{1/3}$ = 4.0, 5.0, 6.0 (Figs. 2.63, 2.64, and 2.65)
- C_B ($\equiv \delta$) = 0.6, 0.7, 0.8 (Figs. 2.63, 2.64, and 2.65)

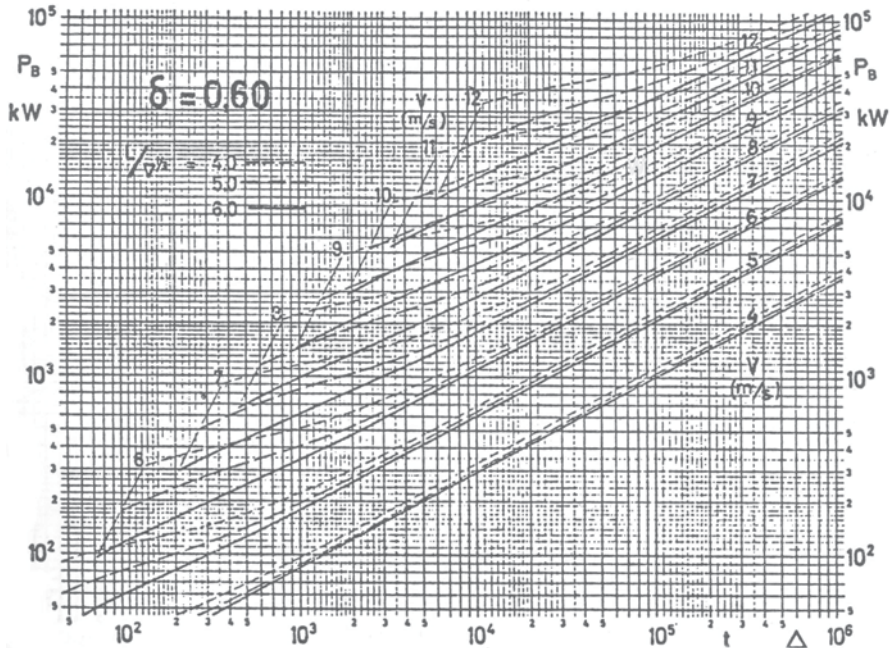

Fig. 2.63 Diagrams of installed propulsion power [kW] versus the displacement Δ [tons], velocity V [m/s] and slenderness ratio $L/\nabla^{1/3}$, $C_B = 0.60$ acc. to Harvald

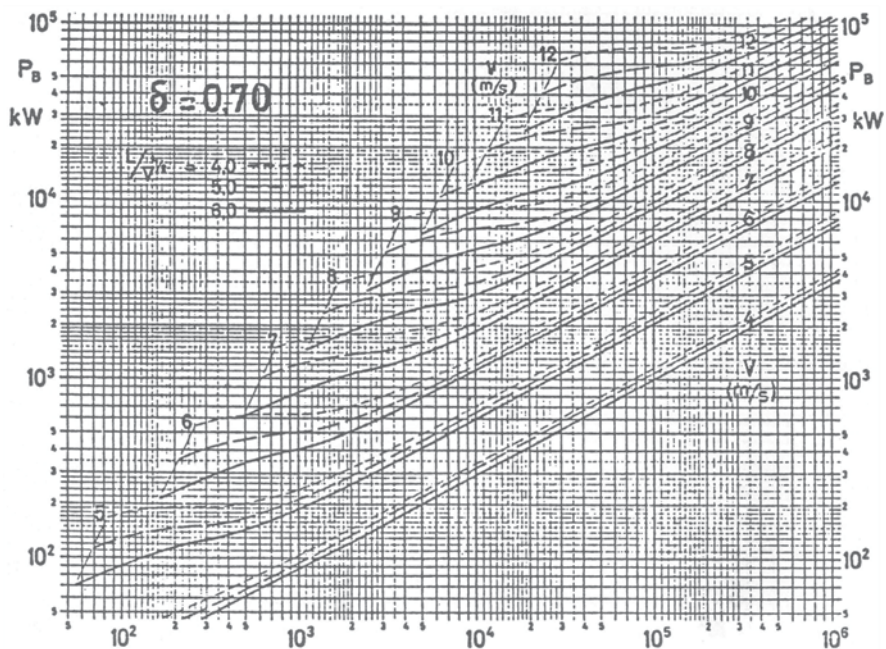

Fig. 2.64 Diagrams of installed propulsion power [kW] versus the displacement Δ [tons], velocity V [m/s] and slenderness ratio $L/V^{1/3}$, $C_B=0.70$ acc. to Harvald

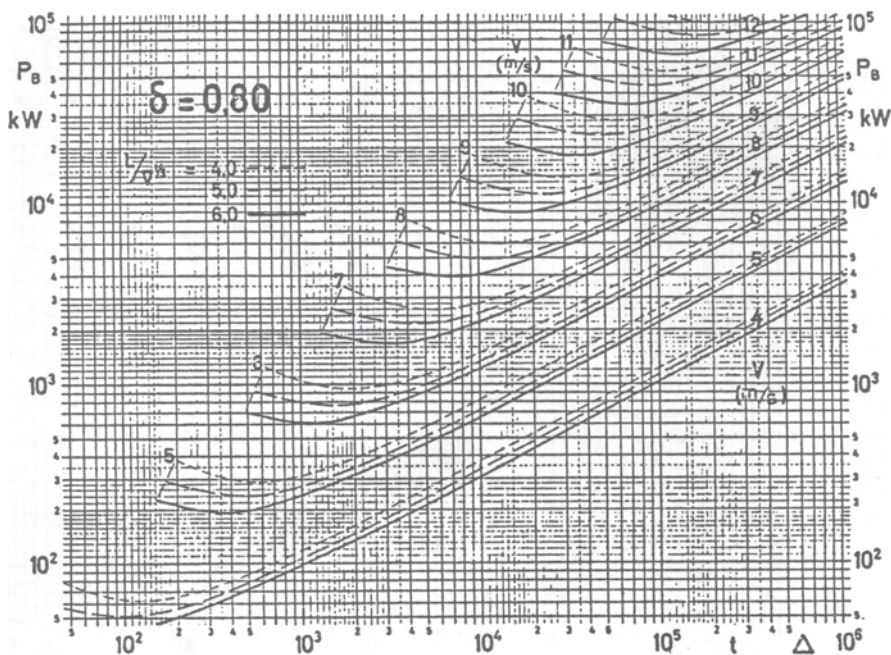

Fig. 2.65 Diagrams of installed propulsion power [kW] versus the displacement Δ [tons], velocity V [m/s] and slenderness ratio $L/V^{1/3}$, $C_B=0.80$ acc. to Harvald

2.15 Estimation of Ship Weights

The as accurate as possible approximation of the various weight groups of the ship, and the position of their centroid, is a very important step in both the preliminary and the final ship design stage. Likewise, any inaccuracy and mistakes have significant influence on the achieved transport capacity, as on the speed, stability, and safety of the ship¹⁹. Also, due to the indirect association of the ship's construction cost with the acc. to Harvald ship weight, particularly the structural steel weight, the as possible accurate assessment of the various weight groups is already of great importance in the preliminary design phase, because it concerns the terms of the initial tender of a shipyard to the interested shipowner.

2.15.1 Definitions of Ship Weight Components

The displacement equation may be analyzed as following:

$$\Delta = W = W_L + DWT \quad (2.107)$$

- Δ : displacement (weight of displaced water)
 W : total, sum of weights of the ship (weight)
 W_L : weight of light(empty) ship (sometimes LS)
 DWT : transport capacity, deadweight.

a. Analysis of light ship weight W_L

Definition of W_L It corresponds to the weight of the finished, fully equipped, and seaworthy ship *without* supplies and payload. In this weight the following machinery supplies are included: lubricants and cooling water of machines, feed water of boilers, weight of liquids in pipes. The weight W_L corresponds roughly to the ship's delivery state from the shipyard to the shipowner.

Analysis of W_L

$$W_L = W_H + W_M + R \quad (2.108)$$

where

- W_H weight of hull,
 W_M weight of machinery
 R reserve (margin/ tolerance of estimations)

¹⁹ Whereas small inaccuracies in the estimation of ship's weight may be balanced by slight changes of ship's draft, this is very different when dealing with the proper estimation of weights of submarines, as there the imbalance of the sum of weights and displaced volume trivially leads to submarine's inability to float in neutral equilibrium. Additionally, it must be ensured that in all cases the center of the overall mass must be below the center of displaced volume for the submarine to be stable (have positive stability).

Analysis of W_H The hull weight W_H can be further broken down into:

$$W_H = W_{ST} + W_{OT} \quad (2.109)$$

where:

W_{ST} : weight of steel structure

W_{OT} : weight of outfitting

Definition of W_{ST} It includes the weight of all elements of the steel structure of the ship and corresponds approximately to a shipyard's steel work. In addition to all the plates and stiffeners of the ship, the following components are included in this weight group as well: the mounting base of the engine, the superstructure and deckhouses, even if they are of different materials (e.g., aluminum), the masts, the rudder, the rudder shaft, the hatch coamings, the bulwark.

Definition of W_{OT} It includes the weight of all fittings to the "naked" ship and also all detachable outfittings of the ship *except for the machinery outfitting* (see Table 2.30) for description of elements of W_{OT}). Certain elements of the W_{ST} can be taken as well within W_{OT} , for example, the masts and the rudder, noting that it depends on the practice of the shipyard or designer.

Analysis of W_M :

$$W_M = W_{MM} + W_{MS} + W_{MR} \quad (2.110)$$

where

W_{MM} : main machinery weight

W_{MS} : shaft of propeller and propeller weight

W_{MR} : rest machinery weight

Definition of W_{MM} It includes the weight of the main engine and gearbox (if any), for turbine driven ships the weight of the turbine, the gearbox and boilers respectively.

Definition of W_{MR} It includes the weight of pumps of any kind, any piping inside the engine room, funnels, main electric generators (the emergency electric generator is very often included in W_{OT}), transformers and switchboards, any support mechanical components of the main engine, etc.

Definition of R The reserve (tolerance/margin of uncertainty) R is set in the preliminary design to cover possible inaccurate initial approximations of the various weight groups. Typical values of R , in the preliminary design stage in [%] W_L , are 1–2% for simple structures (tankers and bulkcarriers) and 2–3% (up 6% according to Schneekluth) for more complex ships. With the progress of the design the reserve R diminishes and converges to the *tolerance of construction*, which covers the

differences with respect to the estimated weight of the processed materials and outfitting coming from external suppliers or which are produced by the shipyard itself. During the final phase of the design, the value of R is 0.5–1% for simple ships and 1–2% of W_L for complex ones (e.g., passenger ships, reefers, containerships, etc.).

As to the impact of the center of gravity/mass of R on stability, it may be assumed that the vertical position of the weight center of R is *located 20% higher than the estimated \overline{KG} of the vessel*, but the longitudinal position is assumed the same as the estimated longitudinal gravity/mass center of the ship.

b. Analysis of deadweight DWT

$$\text{DWT} = W_{\text{LO}} + W_{\text{F}} + W_{\text{PR}} + W_{\text{P}} + W_{\text{CR}} + B \quad (2.111)$$

where,

- W_{LO} : weight of the payload (for cargo ships: cargo payload, for Ro-Ro ships: weight of carried vehicles)
- W_{F} : fuel weight, including fuel reserve and lubricants
- W_{PR} : weight of provisions and water supplies
- W_{P} : weight of passengers and luggage (persons & effects); cargo ships may carry up to 12 passengers; for passenger ships, this weight may be included in the payload
- W_{CR} : weight of crew (including their luggage)
- B : weight of *nonpermanent* ballast (water), whenever is required in the *full load* condition (design draft)

2.15.2 Initial Estimation of Weights and Their Centroids

During the initial estimation of displacement, especially when it comes to cargo ships (dry or liquid cargo), it is possible to approximate the weight of lightship W_L , or the ratio (DWT/ Δ), through coefficients, which are dependent on the ship type, Froude number, and the size of the ship (in terms of transport capacity). Such relationships are well known for long time (e.g., Völker (1974), or see Table 2.1), but they are not recommended for volume carrier ships, where the decisive elements of the ship size are the large deck areas, extended large superstructures, or high horsepower, as happens with passenger ships, ferries, tug boats, having all a small (DWT/ Δ) ratio.

Typical values of (DWT/ D) are given in Table 2.1 (Sect. 2.1) for various types ships according to Schneekluth (1985) and others, as well as given in other course supporting material of the author (Papanikolaou and Anastassopoulos 2002).

Regarding the initial estimation of the vertical position of the mass center of the fully loaded ship, the use of the following relationship between \overline{KG} and the side depth D is proposed:

$$\overline{KG} = C \cdot D_s \quad (2.112)$$

where the modified side depth D_s is defined as

$$D_s = D + \nabla_{SS} / (L_{pp} \cdot B) \quad (2.113)$$

and ∇_{SS} : volume of superstructures and deckhouses.

The C coefficients may be taken according to Dudszus and Danckwardt (1982) as the following typical values (Table 2.18):

As to the vertical position of center of gravity of the various groups of weights, the following data of Table 2.19 according to Schneekluth (1985) can be used.

Likewise, in the *support material* to the course *Ship Design and Outfitting I* (Papanikolaou and Anastassopoulos 2002) approximate values for the vertical and longitudinal position of the centers of various groups of weights and types of ships are given according to E. Strohbusch (1971).

2.15.3 Factors That Affect the Values of the Weight Coefficients

When using empirical coefficients for the approximation of the various weight categories, see Sect. 2.15.2, we must pay attention to the indicated upper and lower limits of the magnitudes in Tables 2.18 and 2.19, as well as to the specific features of the concerned ship in the context of the same ship category. For the proper selection of coefficients, it is not sufficient to use average values between the given limits; instead, the following criteria must be taken into consideration:

a. General effects regardless of ship type

a1. *Absolute size*: With the increase of the absolute size of a type of ship, generally the weight coefficients of the ship *decrease* due to the following reasons:

- All structural elements that support local loads remain the same and therefore smaller ships are charged proportionally with more steel weight,
- Generally areas/surfaces increase with $\Delta^{2/3}$
- The number of crew and the extent of their accommodation increase slightly or not at all, when increasing the ship's size (stepwise change)
- The propulsive power increases with $\Delta^{2/3}$

Table 2.18 Coefficients C for the estimation \overline{KG} for various ship types

| | |
|-------------------|-----------|
| Passenger ships | 0.67–0.72 |
| Large cargo ships | 0.58–0.64 |
| Small cargo ships | 0.60–0.80 |
| Bulk carriers | 0.55–0.58 |
| Tankers | 0.52–0.54 |
| Fishing vessels | 0.66–0.75 |
| Tug boats | 0.65–0.75 |

Table 2.19 Vertical position of center of gravity of weight groups W_{ST} , W_{OT} , W_M , W_L for the main types of commercial ships as a percentage [%] of the corrected side depth (strength deck) D_S —Synthesis of data by H. Schneekluth (1985)

| Ship type | Lower limit ^a | W_{ST} | W_{OT} | W_M | W_L |
|------------------------|--------------------------|----------|----------|-------|-------|
| Cargo ships | 5,000 t DWT | 60–68 | 110–120 | 45–60 | 70–80 |
| Coastal cargo ships | 499 GRT | 65–75 | 120–140 | 60–70 | 75–87 |
| Bulkcarriers | 20,000 t DWT | 50–55 | 94–105 | 50–60 | 55–68 |
| Tankers | 25,000 t DWT | 60–65 | 80–120 | 45–55 | 60–65 |
| Containerships | 10,000 t DWT | 55–63 | 86–105 | 29–53 | 60–70 |
| Ro-Ro | $L \approx 80$ m | 57–62 | 80–107 | 33–38 | 60–65 |
| Reefers | 300,000 ft ³ | 58–65 | 85–92 | 45–55 | 62–74 |
| RoPax ferries | | 65–75 | 80–100 | 45–50 | 68–72 |
| Trawlers | $L \approx 44$ m | 60–65 | 80–100 | 45–55 | 65–75 |
| Tug boats ^b | $P_B \approx 500$ kW | 100–140 | 70–80 | 60–70 | 70–90 |

^a Smaller ships within the same category (lower limit) generally have higher positions of centers of weights

^b For the tugboats the upper values correspond to vessels with extended forecastle

Thus, for example, a large tanker will be generally having values in the lower limits of the cited weight coefficients, while the opposite holds for a smaller one. Of course, this is not the general rule for all types of ships. For example, larger multi-purpose cargo ships may dispose *additional* cargo handling facilities and equipment (derricks/cranes of heavy lift capacity, reefer spaces, etc.), thus they may be proportionally heavier than smaller ones.

a2. Effects on steel weight:

- Through the exploitation of developments of technology and of computational/optimization methods regarding the ship's structural design, modern shipbuildings are generally lighter than the corresponding older ones with comparable capacity/specifications. It should be noted, however, that for some types of ships (such as tankers), the development of more stringent safety regulations over the years (in particular the marine environment protection regulations, MARPOL and OPA90 introducing *double-hull concept for tanker ships*) led to increased steel weight requirements, for tankers of the same transport capacity. It may be anticipated, however, that increased requirements and savings through optimization and new technologies acted counterbalancing in the historical development of the structural steel weight of tankers.
- The use of lightweight materials is notable, especially in the superstructure of passenger ships; also, the increased use of higher tensile steel (particularly in high stress areas of the structure of large tankers, bulkcarriers and containerships) led to a relative reduction of structural weights for many ship types.

Table 2.20 Effect of speed on the light ship weight. (Strohbusch 1971)

| | Cargo ship | | Tanker | | Bulk-carrier | |
|--------------------------------|------------|------|--------|------|--------------|------|
| F_n | 0.18 | 0.25 | 0.16 | 0.19 | 0.18 | 0.21 |
| W_L/Δ [%] | 28 | 38 | 16 | 24 | 24 | 27 |
| W_L/LBD [kp/m ³] | 150 | 190 | 110 | 140 | 130 | 155 |

The given data refer to relatively old shipbuildings from the 70s and are of interest only in view of the *qualitative* effect of changing the concerned parameters. Generally, the weight coefficients of the light ship have reduced significantly over the years due to optimization of the steel weight and the use of higher tensile steel, especially for tankers and bulkcarriers. Indicative values for modern tankers of double-hull concept are, see Lamb (2003): W_L/Δ [%], W_L/LBD [kp/m³], F_n [-]=23.3, 119, 0.18 (PANAMAX), 14.2, 79.9, 0.15 (SUEZMAX), 13.3, 74.4, 0.14 (VLCC)

- Additional weights may arise due to various strengthenings for specific operating conditions of the ship, such as:
 - Navigation in ice; for example, an ordinary cargo ship may need additional steel weight strengthenings of +40 to 50 t, as specified by the classification societies' rules
 - For lifting of heavy weights, local strengthening of up to +80 t
 - Owner's specific additional requirements up to 2~3% W_{ST} .

The number of decks and bulkheads, if deviating from 'normal' practice, affects also the steel weight.

Effect of speed: A high Froude number requires slender hull form (high slenderness ratio) and consequently causes an increased W_{ST}/Δ and also a change of $W_{ST}/(LBD)$. While the corresponding decrease of the block coefficient C_B causes an increase of the ratio W_{ST}/Δ , generally the ratio $W_{ST}/(LBD)$ may decrease, if the main dimensions remain constant, which means that the reference displacement is reduced, as well as the transport capacity of the ship (see Table 2.13). For keeping the same transport capacity, the dimensions would need to be changed, thus the weight will be finally increased. In addition, an increase of the Froude number implies an increased machinery weight and generally increased values of weight coefficients W_L/Δ and W_L/LBD (see Table 2.20).

Effect of the main dimensions: An increase of the absolute size of the ship, namely, as expressed by the increase of the product $L \cdot B \cdot D$ and a reduction of L/D or C_B , affect with decreasing trend the coefficients $W_{ST}/(LBD)$ (see Table 2.21).

a3. *Effects on the weight of accommodation and outfitting:*

Determinant factors regarding the values of the corresponding coefficients are the followings

- Number of passengers and crew
- Accommodation quality
- Type and number of loading/unloading equipment
- Extent of reefer cargo spaces, if any
- Extent of insulation works etc.

Table 2.21 Effect of main dimensions on the weight of steel structure and outfitting. (Strohbusch 1971)

| Bulk-carrier | | 110,000 | 200,000 | | |
|-----------------------------------|--------|---------|---------|---------|------|
| LBD [m ³] | | 110,000 | | 200,000 | |
| C_B | | 0.85 | 0.75 | 0.85 | 0.75 |
| W_{ST}/LBD [kp/m ³] | L/D=14 | 116 | 108 | 113 | 106 |
| | L/D=13 | 111 | 104 | 109 | 103 |
| W_{OT}/LBD [kp/m ³] | | 17 | | 13 | |

Comments made for tankers in footnote to Table 2.20 hold also herein. Characteristic values for modern large size bulkcarriers: $W_{ST}/LBD \approx 76.1$ [kp/m³] for $LBD \approx 282,000$ m³

In general, the coefficients decrease with the increase of the absolute size of the ship (see Table 2.21).

a4. *Effects on the machinery weight*

The basic influencing factors as to the coefficients for the machinery weight are:

- Required speed and installed engine power
- Type of main engine (diesel low turning speed—medium speed—high speed, turbine) and transmission mode (with or without gearbox)
- The position of the engine room significantly affects the coefficient for the weight of shaft (and propeller) W_{MS} ,
- The type of ship and the required electric power for servicing auxiliary facilities significantly affect the W_{MR} coefficient (rest machinery), for example, passenger and reefer ships.

Indicative values for the ratio of the installed power of the main engine to the ship’s displacement are shown in the following Table 2.22, with the following notes:

- MONOHULL-AQUASTRADA: Large ($L > 100$ m), high speed ($V > 40$ kn) mono-hull type RO-RO passenger ship built by the Italian shipyard RODRIQUEZ (1993)
- CATAMARAN: twin-hull type ship for medium (seldom slow) and high speeds (planning or semi-planning/semi-displacement mode) with hybrid development features
- SWATH (Small Waterplane Area Twin Hull): Hybrid type CATAMARAN with small waterplane area for (low), medium to relatively high speeds (up to 35 kn absolute speed, depending on ship size); characterized by excellent seakeeping performance, while sustaining high speed
- SES (Surface Effect Ship): Hybrid type CATAMARAN with air cushion support for high-speeds ($V > 40$ kn)
- WAVE PIERCER: Hybrid type CATAMARAN with very sharp entrance of the waterlines and wave-piercing protrusion at the bottom of the two hulls bridging deck in the bow region, for high speeds ($V > 35$ kn, depending on ship size; Table 2.23; Fig. 2.66)

Table 2.22 Ratios of installed propulsion power to displacement weight for various types of ships—synthesis by IHS Fairplay database (2011) and A. Papanikolaou (2002)

| Ship type | P/Δ [PS/t] |
|---|-------------------|
| Fast cargo ships (and containerships) | 0.7–1.6 |
| Slow cargo ships | 0.4–0.6 |
| Coaster cargo ships | 0.4–0.6 |
| Bulkcarriers | 0.1–0.5 |
| Tankers | 0.10–0.35 |
| Reefer ships | 0.7–1.6 |
| Fast passenger ships (non-high speed craft) | |
| Large | 1.4–3.3 |
| Small | 1.6–3.3 |
| Medium to slow passenger ships | |
| Large | 1.1–1.2 |
| Small | 1.0–2.8 |
| Tugboats (seagoing) | up to 6.0 |
| Advanced Marine Vehicles (very high speed crafts) | |
| MONOHULL-AQUASTRADA | $\cong 36.5$ |
| CATAMARAN | $\cong 25.0$ |
| SWATH | $\cong 20.0$ |
| SES | $\cong 35.0$ |
| WAVE PIERCER | $\cong 26.0$ |
| HYDROFOIL | $\cong 63.0$ |

Advanced Marine Vehicles (AMV): These are generally high speed ships and boats of unconventional design and high operational performance (see also the following graph by A. Papanikolaou for the route of developments)

Table 2.23 Comments on the development chart of Advanced Marine Vehicles (AMVs) (Papanikolaou 2002)

1. ACV: **Air Cushion Vehicle** - Hovercraft, excellent calm water and acceptable seakeeping (limiting wave height), limited payload capacity.
2. ALH: **Air Lubricated Hull**, various developed concepts and patents, see type STOLKRAFT.
3. Deep V: ships with *Deep V* sections of semi-displacement type acc. to E. Serter (USA) or of more planing type, excellent calm water and payload characteristics, acceptable to good seakeeping, various concepts AQUASTRADA (RODRIQUEZ, Italy), PEGASUS (FINCANTIERI, Italy), MESTRAL –ALHAMBRA (BAZAN, Spain), CORSAIR (LEROUX & LOTZ, France).
4. FOILCAT: Twin hull (**catamaran**) **hydrofoil** craft of KVAERNER (Norway), likewise MITSUBISHI (Japan), excellent seakeeping (but for limited wave height) and calm water characteristics, limited payload.
5. LWC: **Low Wash Catamaran**, twin hull superslender semi-displacement catamaran with low wave-wash signature of FBM Marine Ltd. (United Kingdom), employed for river and closed harbour traffic.
6. LSBK: **Längs Stufen- Bodenkanalboot- Konzept**, optimized air-lubricated twin hull with stepped planing demihulls, separated by tunnel, aerodynamically generated cushion, patented in Germany.
7. MIDFOIL: Submerged Foil-body and surface piercing twin struts of NAVATEK-LOCKHEED (USA).

Table 2.23 (continued)

-
8. **MONOSTAB**: Semi-planing monohull with fully submerged, stabilizing stern fins of RODRIQUEZ (Italy).
 9. **MWATH**: **M**edium **W**aterplane **A**rea **T**win **H**ull Ship, as type **SWATH**, however with larger waterplane area, increased payload capacity and reduced sensitivity to weight changes, worse seakeeping.
 10. **SES**: **S**urface **E**ffect Ship, Air Cushion Catamaran Ship, similar to **ACV** type concept, however w/o side skirts, improved seakeeping and payload characteristics.
 11. **SLICE**: Staggered quadruple demihulls with twin struts on each side, acc. to **NAVATEK-LOCKHEED** (USA).
 12. **SSTH**: **S**uperslender **T**win **H**ull, semi-displacement catamaran with very slender long demihulls of **IHI** shipyard (Japan), similar to type **WAVEPIERCER**.
 13. **STOLKRAFT**: Optimized air-lubricated V-section shape catamaran, with central body, reduced frictional resistance characteristics, limited payload, questionable seakeeping in open seas, patented by **STOLKRAFT** (Australia)
 14. **Superslender Monohull with Outriggers**: Long monohull with two small outriggers in the stern part, **EUROEXPRESS** concept of **KVAERNER-MASA** Yards (Finland), excellent calm water performance and payload characteristics, good seakeeping in head seas.
 15. **SWATH Hybrids**: **SWATH** type bow section part and planing catamaran astern section (**STENA**'s **HSS** of former **Finyards**, Finland, **AUSTAL** hybrids, Australia), derived from original type **SWATH** & **MWATH** concepts.
 16. **SWATH**: **S**mall **W**aterplane **A**rea **T**win **H**ull Ship, synonym to **SSC** (**S**emi-**S**ubmerged **C**atamaran of **MITSUI** Ltd.), ships with excellent seakeeping characteristics, especially in short period seas, reduced payload capacity, appreciable calm water performance.
 17. **TRICAT**: Twin hull semi-displacement catamaran with middle body above **SWL** of **FBM Marine Ltd.** (United Kingdom).
 18. **TRIMARAN**: Long monohull with a pair of small outriggers, introduced by Prof. D. Andrews—**UCL** London (United Kingdom), tested as large prototype by the **UK Royal Navy** (**TRITON**), similarities to the **Superslender Monohull** with outriggers concept of **KVAERNER-MASA**; excellent calm water performance; problematic seakeeping in oblique and beam seas; concept later developed and as pentamaran (with two pairs of outriggers).
 19. **TSL-F - SWASH**: **T**echno-**S**uperliner **F**oil version developed in Japan by shipyard consortium, submerged monohull with foils and surface piercing struts.
 20. **V-CAT**: Semi-displacement catamaran with V section shaped demihulls of **NKK** shipyard (Japan), as type **WAVEPIERCER**.
 21. **WAVEPIERCER**: Semi-displacement catamaran of **INCAT** Ltd. (Australia), good seakeeping characteristics in long period seas (swells), good calm water performance and payload characteristics.
 22. **WEINBLUME**: Displacement catamaran with staggered demihulls, introduced by Prof. H. Söding (**IfS-Hamburg-Germany**), very good wave resistance characteristics, acceptable seakeeping and payload, name to the honour of late Prof. G. Weinblum.
 23. **WFK**: **W**ave **F**orming **K**eel **H**igh **S**peed **C**atamaran **C**raft, employment of stepped planing demihulls, like type **LSBK**, but additionally introduction of air to the planing surfaces to form lubricating film of micro-bubbles or sea foam with the effect of reduction of frictional resistance, patented by A. Jones (USA)
 24. **WIG**: **W**ing **I**n **G**round **E**ffect **C**raft, various developed concepts and patents, passenger/cargo carrying and naval ship applications, excellent calm water performance, limited payload capacity, limited operational wave height, most prominent representatives the **ECRANOPLANS** of former **USSR**.
-

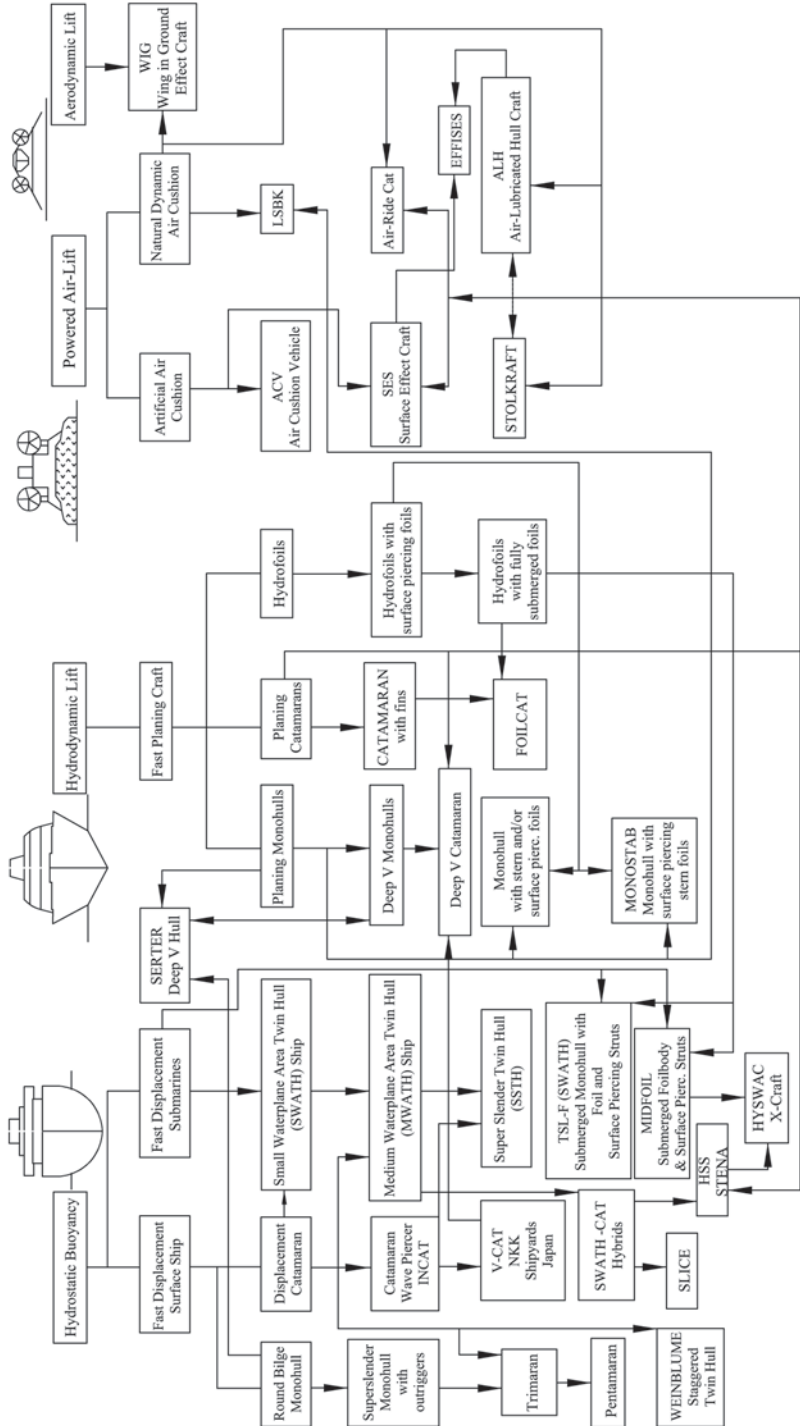

Fig. 2.66 Development of basic and hybrid types of advanced marine vehicles. (Papanikolaou 2002)

b. Specific effects on various types of ships

b1. *Cargo ships*: This paragraph applies only to cargo ships built under the provisions of the old tonnage/capacity regulations, distinguishing between “open” or “closed” type tonnage measurement (see Antoniou and Perras 1984). For the conversion of a cargo ship of open-type tonnage measurement to a corresponding ship of closed-type and for the same principal dimensions, the weight W_{ST} would increase by about 8%, the W_M by 10% and the displacement by 16%, as well as the draught. It is estimated that with this conversion the transportation capacity may increase by about 20%. In conclusion, a ship of “closed type” prevails in terms of weight distribution and exploitation (DWT) in comparison to an equivalent of “open type” measurement. However, in the new international tonnage regulations the distinction between “open” or “closed” type measurement has been removed and a consistent way of measurement of the ship’s enclosed volume and tonnage came into force. Essentially, ships measured with the new international tonnage regulations correspond to ships of former “closed” type in terms of weight distribution and exploitation of capacity.

b2. *Tankers, Bulk carriers*: Generally, the weight W_{ST} relatively decreases with the increase of absolute size. However, due to limitation of drafts (what means increased beam and may be increased length), this trend can reverse for very large ship sizes.

b3. *Reefer ships*: They are distinguished by their relatively high steel weight due to the slenderness of the hull form; they also have relatively high machinery weight due to the relatively high speed (large installed engine power); also relatively high outfitting weight, due to the weight of reefer facilities/outfitting (including increased electric energy consumption). In conclusion it shows a relatively large light ship weight and low ratio DWT/Δ (deadweight to ship displacement).

b4. *RoPax/Ro-Ro ferries*: Basically the same comments, as to the reefer ships, apply also to RoPax ships, though the reasons are partly different: their increased weights in the outfitting weight category are due to the large extent of accommodation spaces, the increased need for electrical energy (lighting, air-conditioning, etc.) and Ro-Ro loading outfitting (ramps etc., if not counted in the steel weight). Hence, they also dispose high lightship weight and small ratio DWT/Δ (classical *volume carrier*).

The above comments are expressed quantitatively with the shown typical values of weight coefficients in Table 2.1 (Sect. 2.1).

2.15.4 Structural Weight

As defined in Sect. 2.15.1, the weight of the ship’s structure W_{ST} includes the steel weight of the main hull, of the superstructures (even if party of wholly not made from steel, for example, light weight superstructures from aluminum alloys), as well as of some heavy steel fittings (like masts or derricks, etc.), which could be as well have been included in the W_{OT} .

A. Simplified methods for W_{ST} calculation (preliminary design phase)

A1. Method of Harvald and Jensen (1992) (see Friis et al. 2002)

The method is based on structural weight data of ships built in Danish shipyards; the data involve a large number of ships built in the decade of 80ties and until the early 90ties. The method uses as a basis the approximate enclosed volume of steel structure V_C , which includes the volume of the main hull, of the superstructures and deckhouses; furthermore, a coefficient for the steel structural density C_S is employed.

We assume

$$V_C \approx LBD + \text{Volume of superstructures and deckhouses}$$

and

$$W_D \equiv \text{DWT}, C_S = W_S / V_C, W_S \equiv W_{ST}$$

We may use the following diagrams, in which the steel structural coefficient C_S is given as a function of displacement Δ (Fig. 2.67), of W_D (\equiv DWT) (Fig. 2.68) and the enclosed volume of V_C (Fig. 2.69).

The curves in Fig. 2.67 can be mathematically expressed also by the relationship:

$$C_S(\Delta) = C_{S0} + 0.064 \exp(-0.5 \log_{10} \Delta + 1 - 0.1(\log_{10} \Delta - 2)^{2.45}) \quad (2.114)$$

The C_{S0} for various types of ships is given in the following table (Table 2.24; Figs. 2.68 and 2.69).

From the analysis of data (regression fitting), the following approximate relationships are obtained, expressing the DWT and the enclosed volume V_C as a function of displacement Δ .

Cargo ships and bulk carriers

$$W_D = 0.1951 \cdot \Delta^{1.13}$$

$$V_C = 12.127 \cdot \Delta^{0.883}$$

Tankers

$$W_D = 0.4464 \cdot \Delta^{1.05}$$

$$V_C = 4.674 \cdot \Delta^{0.915}$$

Rail ferries

$$W_D = 0.00363 \cdot \Delta^{1.5}$$

$$V_C = 1.951 \cdot \Delta^{1.12}$$

A2. Method of Cubic Number Coefficient CNC

Assumption The W_{ST} weight varies proportionally to the product of the main dimensions $L \cdot B \cdot D$, expressing approximately the enclosed volume of the ship's structures:

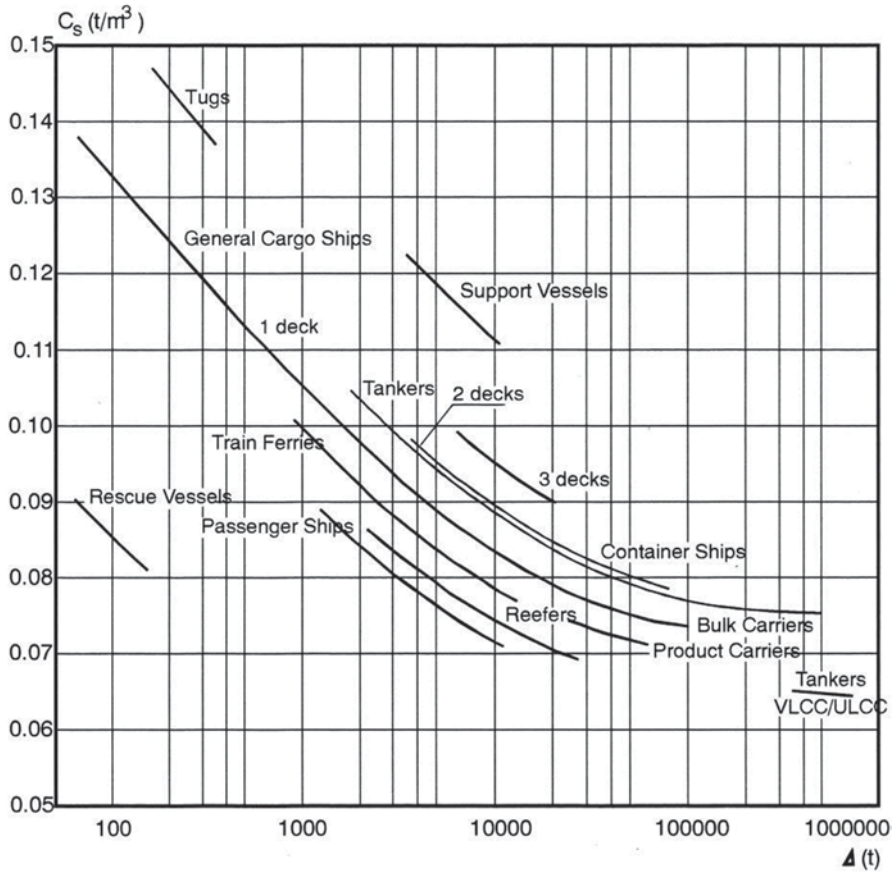

Fig. 2.67 Steel structural weight coefficient C_s versus displacement Δ by Harvald and Jensen. (Friis et al. 2002)

$$CNC = \frac{W_{ST}}{LBD}$$

Application Given the W_{ST} , L , B , D of a *parent*, geometrically similar, ship (index 0), it is assumed for the under design ship (index 1):

$$(W_{ST})_1 = (CNC)_0 \cdot L_1 \cdot B_1 \cdot D_1$$

Corrections For differences of the ship's main characteristics from those of the parent ship, the cubic coefficient of CNC can be corrected as following:

$$CNC = (CNC)_0 \cdot K_1 \cdot K_2 \dots K_n$$

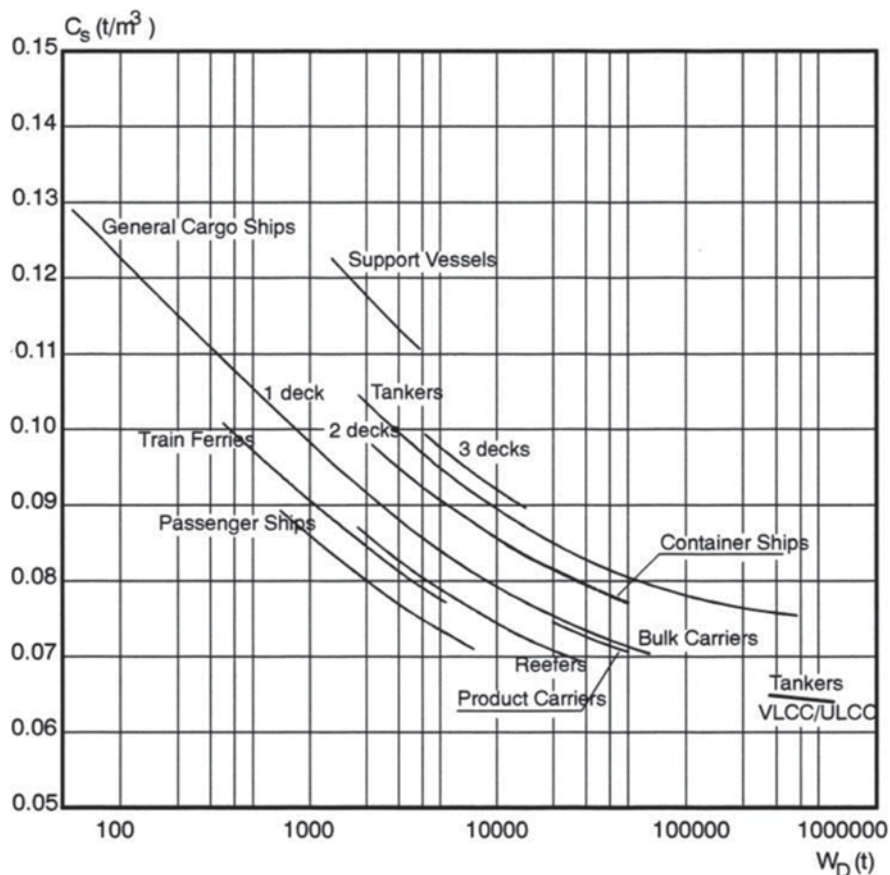

Fig. 2.68 Steel weight coefficient C_s versus the DWT by Harvald and Jensen. (Friis et al. 2002)

1. Correction for different C_B :

$$K_1 = (1 + 0.5C_B)_1 / (1 + 0.5C_B)_0$$

2. Correction for different L/D :

$$K_2 = (L/D)_1 / (L/D)_0.$$

Comments

1. The method is simple and satisfactory, if there are sufficient data from similar ships available.
2. The accuracy of the method is sufficient for the initial design stage.

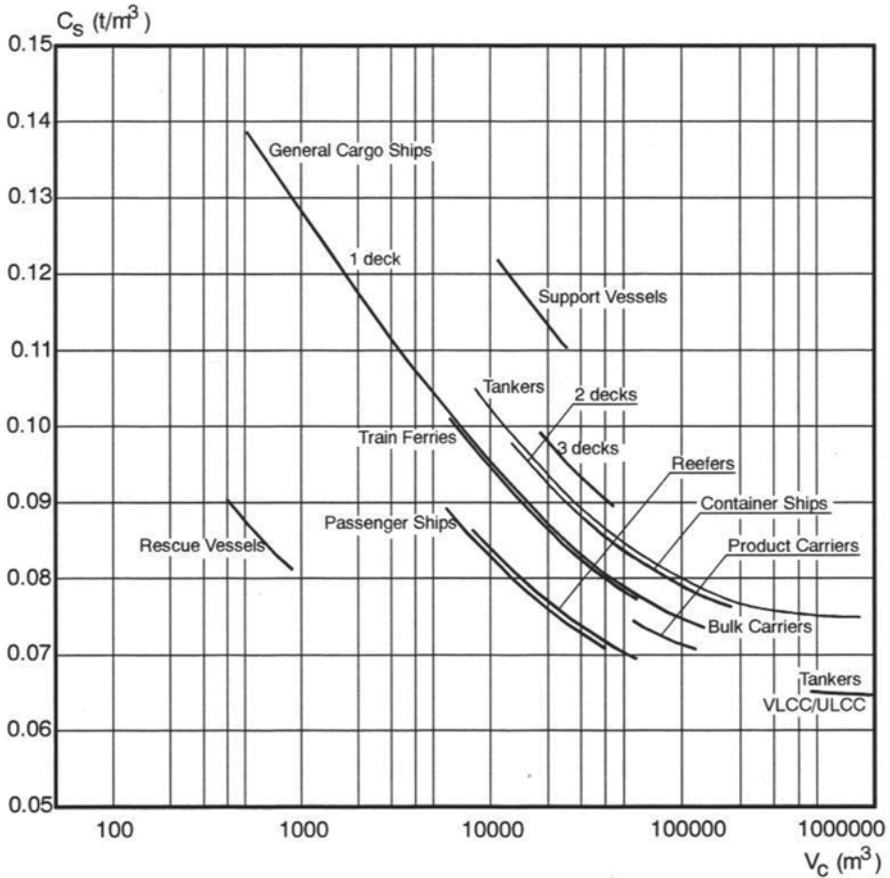

Fig. 2.69 Steel structural weight coefficient C_s versus the enclosed volume V_c by Harvald and Jensen. (Friis et al. 2002)

Table 2.24 C_{s0} for various types of ships

| Ship type | C_{s0} (t/m^3) |
|-----------------------|----------------------|
| Support vessels | 0.0974 |
| Tugs | 0.0892 |
| Cargo ships (3 decks) | 0.0820 |
| Cargo ships (2 decks) | 0.0760 |
| Cargo ships (1 deck) | 0.0700 |
| Tankers | 0.0752 |
| Bulk carries | 0.0700 |
| Product carriers | 0.0664 |
| Train ferries | 0.0650 |
| VLCC | 0.0645 |
| Reefers | 0.0609 |
| Passenger ship | 0.0580 |
| Rescue vessels | 0.0232 |

A3. Difference Method

Assumption The W_{ST} weight results from the corresponding weight of a *parent* ship; individual differences of the main dimensions, of hull coefficients and of local structural strengthenings are taken into account as following:

$$(W_{ST})_1 = (W_{ST})_0 \cdot (1 + C_1 + C_2 + \dots + C_6) \cdot (1 + C_7)$$

Corrections-Coefficients

| | |
|--|----------------------------|
| Correction for different length, $\delta L = L_1 - L_0$ | $C_1 = 1.0 \delta L / L_0$ |
| Correction for different breadth, $\delta B = B_1 - B_0$ | $C_2 = 0.7 \delta B / B_0$ |
| Correction for different side depth, $\delta D = D_1 - D_0$ | $C_3 = 0.4 \delta D / D_0$ |
| Correction for local strengthening components as to the length | $C_4 = 0.45 C_1$ |
| Correction for local strengthening components as to the breadth | $C_5 = 0.35 C_2$ |
| Correction for local strengthening components as to the side depth | $C_6 = 0.65 C_3$ |
| Correction for different C_B , $\delta C_B = C_{B1} - C_{B2}$ | $C_7 = 0.3 \delta C_B$ |

Comments

1. All correction coefficients C_i can be positive or negative according to the sign of the differences δL , δB , δD and δC_B (increase of decrease of relevant dimensions).
2. The method is easy to use and generally well applicable in the initial design phase, assuming the availability of satisfactory parent ship data.
3. The method proved very effective in computer-aided optimization procedures of the ship's initial design, in which the ship's main dimensions are varied parametrically.
4. The following effects are not included: effect of differences in the draft, in the extent of superstructures, and in the number of decks (as applicable).

A4. Watson's Method (Watson and Gilfillan 1976)

Assumption The W_{ST} weight can be calculated based on the equipment index/ numeral E_N (Equipment Numerical) of the ship as defined by Lloyd's Register (LR):

$$E_N = L(B + T) + 0.8L(D - T) + 0.85 \sum_{i=1}^{N1} h_{1i} l_{1i} + 0.75 \sum_{i=1}^{N2} h_{2i} l_{2i}$$

where

- N_1, h_{1i}, l_{1i} : number, height and length of deckhouses²⁰
 N_2, h_{2i}, l_{2i} : number, height and length of the superstructures²¹

²⁰ By definition, the breadth of deckhouses can be up to 0.92 B.

²¹ The breadth of superstructures is larger than 0.92 B according to the provisions of the International Tonnage Measurement regulation.

Application Through Fig. 2.70, where the W_{ST} is presented as a function of E_N , the corresponding weight for a standard block coefficient C_{B^*} , at the height 0.8D, equal to 0.70, can be calculated:

$$(W_{ST})^* = f(E_N), \text{ Fig. 2.70}$$

Correction For the ship's $C_{B^*}(0.8D) \neq 0.7$, the following correction applies:

$$(W_{ST}) = (W_{ST})^* \cdot (1 + 0.05(C_{B^*} - 0.7))$$

where the coefficient $C_{B_1^*}(0.8D)$ can be approximated through the value of $C_{B_1}(T=D)$

$$C_{B_1^*} = C_{B_1} + (1 - C_{B_1})(0.8D - T) / 3T$$

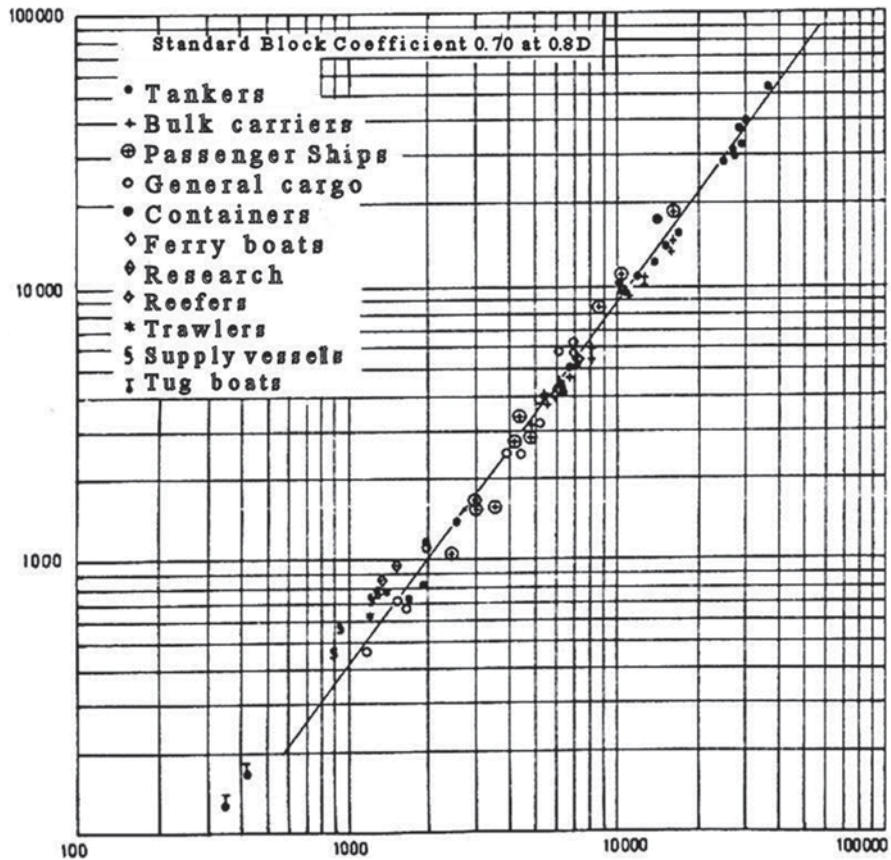

Fig. 2.70 Steel weight W_{ST} versus outfitting index E_N by Watson. (Watson and Gilfillan 1976)

Table 2.25 Steel weight coefficient by Watson (1998)

| Ship type | Average value K | Fluctuation K [\pm] | Lower limit E_N | Upper limit E_N |
|-------------------------|----------------------|------------------------------|-------------------|-------------------|
| Crude oil tankers | 0.032 | 0.003 | 1,500 | 40,000 |
| Chemical tankers | 0.036 | 0.001 | 1,900 | 2,500 |
| Bulkcarriers | 0.031 | 0.002 | 3,000 | 15,000 |
| Containerships | 0.036 | 0.003 | 6,000 | 13,000 |
| General cargo | 0.033 | 0.004 | 2,000 | 7,000 |
| Reefers | 0.034 | 0.002 | 4,000 | 6,000 |
| Coasters cargo | 0.030 | 0.002 | 1,000 | 2,000 |
| Offshore supply vessels | 0.045 | 0.005 | 800 | 1,300 |
| Tugs | 0.044 | 0.002 | 350 | 450 |
| Trawlers | 0.041 | 0.001 | 250 | 1,300 |
| Hydrographic vessels | 0.045 | 0.002 | 1,350 | 1,500 |
| RoPax | 0.031 | 0.006 | 2,000 | 5,000 |
| Passenger ships | 0.038 | 0.001 | 5,000 | 15,000 |
| Frigates/corvettes | 0.023 | | | |

The above coefficients refer to structures built from 100% mild shipbuilding steel. Given that a series of ship types today are built to some extent from higher tensile steel, the resulting weights by use of the above coefficients are expected to be slightly higher than today's standards (e.g., for tankers, bulkcarriers, containerships)

Comments

1. The method is simple and generally applicable in the initial design phase.
2. Due to its simplicity some basic ship features are neglected, which however may significantly influence the final estimation of the steel weight; for example, particularities of some ship types, number of decks and bulkheads etc.
3. The method has been improved by more recent studies of Watson (1998), namely:

$(W_{ST})^* = KE_N^{1.36}$, where K is listed in Table 2.25.

A5. Danckwardt's Method (Danckwardt 1961, Journal Schiffbautechnik)

Assumption The weight W_{ST} can be calculated as a function of the required volume of cargo spaces ∇_C , which includes the grain hold volume, the net volume of refrigerated cargo spaces (inside of insulation) multiplied by 1.3~1.5 (corresponding to the grain volume of refrigerated spaces) and finally, the volume of tanks *outside the engine room* and double bottom and between the forward and aft collision bulkheads.

The ratio W_{ST}/DWT is given as a function of DWT for various ∇_C/DWT values (see Fig. 2.71) for cargo ships up to DWT=18,000 t. The curves are valid for "ordinary/standard" cargo ships with two decks and for a number of watertight bulkheads in conformity with standard classification societies' rules; the ship is assumed to be a cargo ship without passengers, without any special strengthenings and fully welded. The installed power of the propulsion plant is assumed to correspond to about 0.7 [HP] per [ton] DWT.

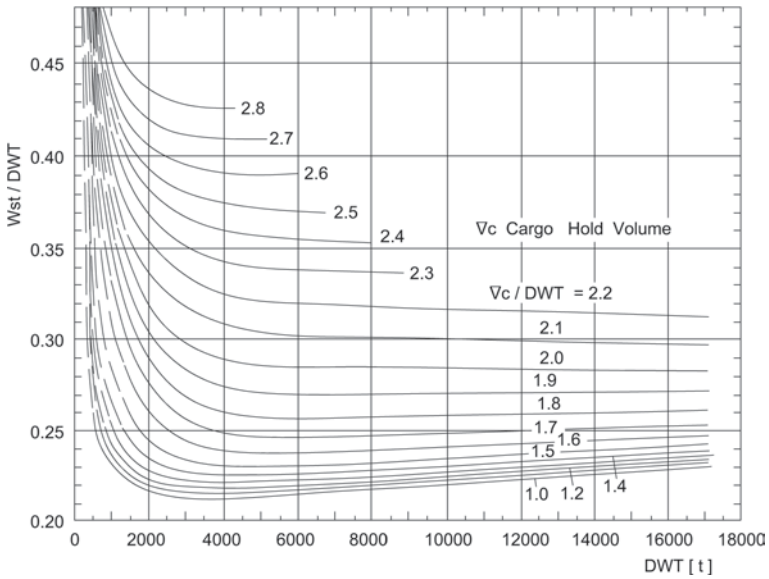

Fig. 2.71 Steel weight W_{ST} versus the DWT and volume ∇_c for dry cargo ships by Danckwardt. (Henschke 1964)

Corrections

1. Number of watertight bulkheads different from the regulations of classification societies, weight increase $\delta W_{ST}/DWT$:

- +One bulkhead: 0.25%DWT
- +Two bulkheads: 0.31%DWT
- +Three bulkheads: 0.50%DWT

2. Strengthening for navigation in ice:

+2 to +9%DWT

3. Strengthening for transportation of heavy bulk cargoes (ores)

up to +6%DWT

4. Strengthening for equipment of heavy lift derricks/cranes:

up to +4%DWT

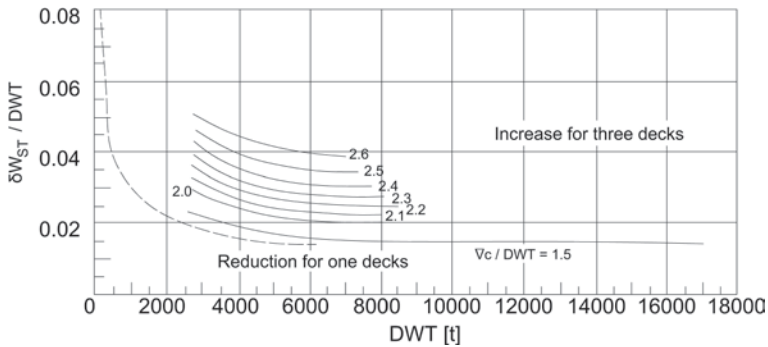

Fig. 2.72 Correction of steel weight by Danckwardt for number of decks different from the standard. (Henschke 1964)

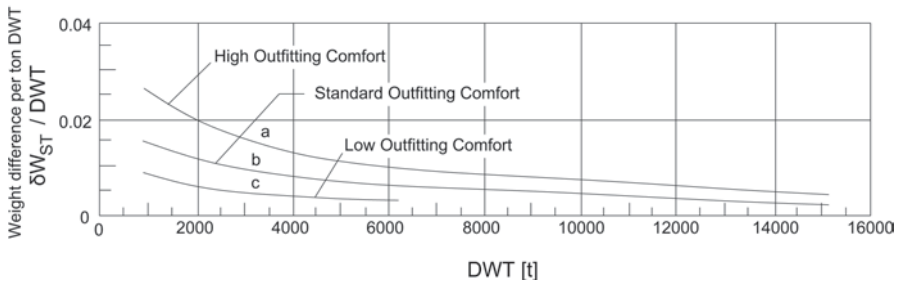

Fig. 2.73 Correction of steel weight by Danckwardt for quality of accommodation different from the standard (valid for up to 12 passengers). (Henschke 1964)

5. Number of decks different from the standard two (2): correction in accordance with Fig. 2.72.
6. Number of passengers up to 12: correction in accordance with Fig. 2.73.
7. Correction for the size of engine room different from the standard, which corresponds to $P/DWT=0.7$ HP/ton, according to Fig. 2.74.

Note:

- (1) This method is mainly applied to general cargo ships, with good results, though basic data of method are outdated.
- (2) The reported corrections can be used in combination with other simplified methods, if the corresponding under assessment structural component of the parent ship is common.

A6. *General comments on the simplified methods for W_{ST} calculation (preliminary design phase)*

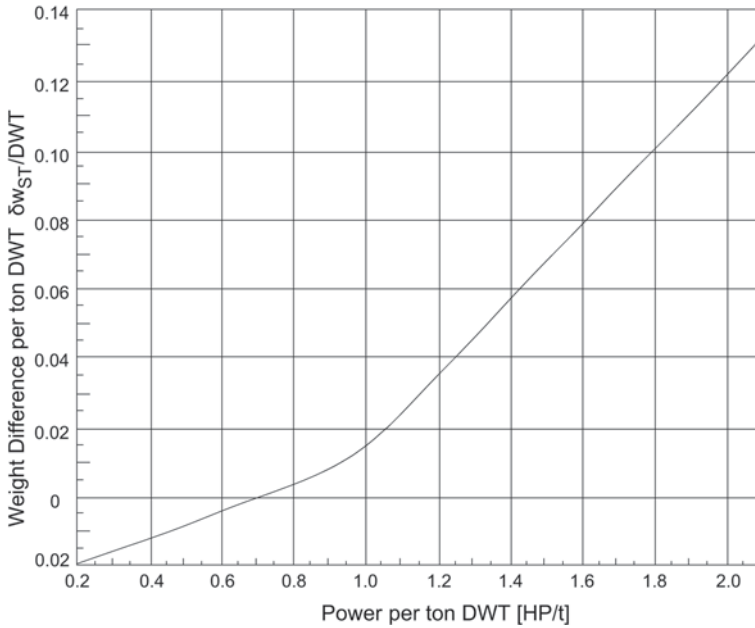

Fig. 2.74 Correction of steel weight by Danckwardt for main engine power different from the standard. (Henschke 1964)

It is considered that the accuracy of the approximation of W_{ST} through the above simplified methods is in the range of $\pm 5\%$, but in practice for ships with special features the difference may be up to $8 \pm 10\%$. Such special conditions are for example:

- Differences in the requirements of various regulations (classification societies, national and international organizations).
- *Effect of new regulations*, for instance, the requirements of MARPOL for tankers concerning the use of segregated ballast tanks directly led to an increase of the number of tanks and consequently of the steel weight. Furthermore we have seen in recent years an increase of the steel weight of tankers with the implementation of OPA 90 and the revised MARPOL regulation (introduction of double-hull/skin tankers).
- *Effect of technological developments*: the steel weights generally decreased in recent years (though one needs to consider the counteracting weight increase due to the continuous introduction of new, more stringent safety regulations), for all types of ships, in view of improved methods for calculating the ship's strength (e.g., finite element methods) and optimizing the ship's structure for least weight; also, in view of the use of alternative materials other than the common mild shipbuilding steel, at least in some parts of the structure (higher-tensile steel for the strength deck and double bottom of tankers, bulkcarriers,

containerships, etc; aluminum alloys in the superstructures of passenger ships). Thus, comparing the steel weights of ships built during the 60s and 70s (for the same transportation capacity) with the contemporary ones, the values are actually today reduced, despite the weight increase due to the introduction of double skin hulls for tankers, or due to the more recent introduction of the Common Structural Rules of IACS class societies for tankers and bulkcarriers.

B. More advanced methods of W_{ST} calculation (preliminary design stage)

B1. *Strohbusch's Method* (Tech. University Berlin, 1928)

Feature Generalized method of relatively high accuracy, assuming that the structural plans of characteristic sections of a parent hull (or of the actual ship) are available.

Application

1. Calculation of the steel structural weight per meter of ship length for a limited number of characteristic sections of the ship.
2. Graphical representation of the curve $dW_{ST}/dx = w_{ST}(x)$ over the ship's length (see Fig. 2.75).
3. Calculation of the area under the curve, which corresponds to W_{ST} .
4. Addition of individual weights that are not taken into account in the weight per meter of length calculation of w_{ST} [ton/m].

$$W_{ST} = \int_{(L)} \frac{dW_{ST}}{dx} dx = \int_{(L)} w_{ST}(x) dx \cong \sum_{(N)} w_{ST}(x_i) \delta x_i$$

B2. *Vollbrecht-Többecke's Method* (1937–1948)

Feature Generalized method of satisfactory accuracy, if there are data from similar ships available.

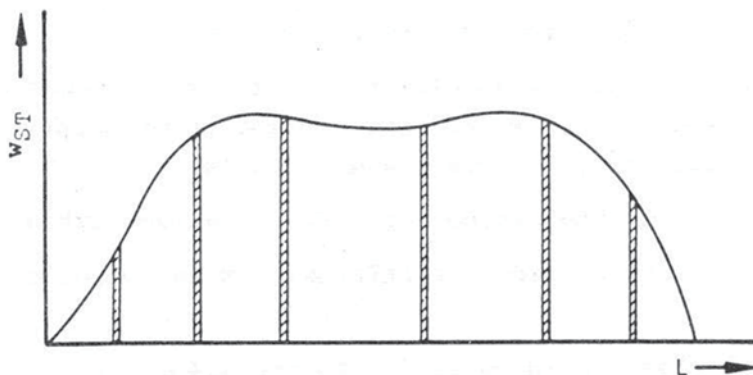

Fig. 2.75 Steel weight calculation by the method of Strohbusch

Application

1. Calculation of the steel weight for 1 m length of the *midship* section (similar to the method Strohbusch): $(w_{ST}) \text{ [ton/m]}$
2. Calculation of W_{ST} for the ship based on the relationship:

$$W_{ST} = (w_{ST}) \cdot L \cdot C$$

where the constant C depends on the ship type, the ship's block coefficient and any special/unique features of the ship under design. This method can easily be adapted to various types of ships, if there are available data of parent ships for the approximation of C .

B3. *Schneekluth's Method* (Tech. Hochschule Aachen, 1967) (Schneekluth 1985)

Feature Synthetic method of good accuracy especially for dry-cargo ships (originally the method was developed for such ships); however, it is possible to apply it also to other ship types (e.g., tankers). It *does not include* the weight of *superstructures*, which can be calculated by the method of Müller-Köster (see Sect. 2.15.4, B4).

Assumptions (Original Method)

1. Dry cargo ships with continuous deck and bulkheads extending to the same deck
2. Constructional elements, for example, plate thickness, number of bulkheads, height of double bottom, in according to the Germanischer Lloyd Classification Society, Regulations of 1967, Class 100 A4
3. Hull form of the ship without a bulbous bow or rudder heel
4. Single-screw ships driven by diesel engines and with the engine room abaft
5. Breadth of hatchways approximately $0.4B + 1.6$ m and overall length of hatchways approximately $0.5 L$
6. Included components of the steel structure:
 - High tanks in the engine room
 - Strengthening/coamings of hatchways
 - Engine casing construction
 - Bulwark of a length of $0.9 L$
 - Chain locker, chain pipe, strengthening of anchor winch
 - Rudder bearings and shaft tube
7. The weight coefficients C_{ST} , given below, were increased by 10% to account for the following elements that are not calculated individually:
 - Increased plate thickness (margin against corrosion)
 - Local reinforcements
 - Heavier construction beyond regulations
 - Main engine foundation/bearings, masts, derricks, rudder body
8. The following weights are not included:
 - Hatch covers
 - Specific reinforcements for high speed and high propulsive power

- Special constructions (e.g., high tanks beyond the standard in the engine room)
- Superstructures and deckhouses (see later on Müller-Köster's method, Sect. 2.15.4, B4)

Required data for the application

- L [m]: length between perpendiculars ($\equiv L_{pp}$)
 B [m]: breadth
 T [m]: design draft
 D [m]: side depth of the uppermost continuous deck
 C_B [-]: block coefficient at design waterline (draft T)
 C_{BD} [-]: block coefficient at height D
 C_M [-]: midship section coefficient
 S_F [m]: sheer height at FP
 S_A [m]: sheer height at AP
 b [m]: camber height at the midship section
 n [-]: number of decks
 ∇_U [m³]: volume below the uppermost continuous deck

If not known at the early design stage, the volume ∇_U can be approximated with the following formula:

$$\nabla_U = \nabla_D + \nabla_s + \nabla_b + \nabla_H \quad (2.115)$$

where

$$\nabla_D = L \cdot B \cdot D \cdot C_{BD} \text{ (volume up to } D\text{)}$$

with

$$C_{BD} = C_B(T) + C_1(D - T) / T(1 - C_B)$$

and

$$\begin{aligned}
 C_1 &\cong 0.25 \text{ for ships with sections of small flare above waterline} \\
 &\cong 0.40 - 0.7 \text{ for ships with significant sectional flare}
 \end{aligned}$$

Furthermore,

$$\nabla_s = L_s \cdot B \cdot (S_F + S_A) \cdot C_2 \text{ (increase of volume due to sheer)} \quad (2.116)$$

with L_s : length of sheer extent ($\leq L_{pp}$) $C_2 = C_{BD}^{2/3} / 6 \cong 1/7$

$$\nabla_b = L \cdot B \cdot b \cdot C_3 \quad (2.117)$$

(increase of volume due to deck camber) with

$$C_3 \cong 0.7 \cdot C_{BD}$$

and

$$\nabla_H = \sum_i^N l_{Hi} \cdot b_{Hi} \cdot h_{Li} \quad (2.118)$$

(increase of volume due to hatch coamings) with

l_{Hi} : length of hatch i

b_{Hi} : breadth of hatch i

h_{Li} : height of hatch/coaming i

N : number of hatches

Application The W'_{ST} without the weight of superstructures is given as a function of the estimated total volume ∇_U [m^3], of a coefficient of specific unit weight C'_{ST} [ton/m^3] and of various corrections:

$$\begin{aligned} W'_{ST} = & \nabla_U C'_{ST} \cdot [1 + 0.033(L/D - 12)] [1 + 0.06(n - D/D_0)] \cdot \\ & [1 + 0.05(1.85 - B/D)] \cdot [1 + 0.2(T/D - 0.85)] \cdot \\ & [0.92 + (1 - C_{BD})^2] \cdot [1 + 0.75C_{BD}(C_M - 0.98)] \end{aligned}$$

where $D_0 = 4$ m and $L/D \geq 9$.

The values of the coefficient C'_{ST} [ton/m^3] as a function of the ship type are:

| Ship type | Length range |
|---|--------------|
| Normal cargo ship | 60–180 m |
| $C'_{ST} = 0.103[1 + 17(L - 110m)^2] \cdot 10^{-6}$ | |
| Reefer ships | 100–150 m |
| $C'_{ST} = 0.106$ to 0.116 | |
| Passenger ships | 80–150 m |
| $C'_{ST} = 0.113$ to 0.121 | |
| Bulkcarriers | 150–300 m |
| $C'_{ST} = 0.108$ to 0.117 | |
| Tankers | 150–350 m |
| $C'_{ST} = 0.112 + L$ [m] $\cdot 10^{-4} \cdot (0.95 + 1.05)$ | |

While the original formula of Schneekluth was applied only to general dry cargo ships it was later on extended to other types of ships with relatively good success.

In general, the following applies:

1. For RoPax and ferry ships the use of the above relationship for passenger ships may be problematic, due to the significant reinforcement of decks for transporting heavy vehicles and the diversification of their structure.
2. For containerships a special relationship is given later on.

Corrections The weight of the ship's steel structure W_{ST} , calculated by the above formula, should be corrected as follows:

1. For transverse construction/strengthening system: +2.5% W_{ST}
2. For the existence of bulbous bow: +0.4–0.7% W_{ST} or consider the additional weight as a function of the bulb's volume: +0.4 t/m³

Comments

1. The method was essentially developed following the approach of Strohbusch (see B1). The results from systematic calculations for different ships were synthesized in the above formula.
2. The advantages of this method are:
 - Relatively simple calculations with good results,
 - Can be easily coded in design computer programs,
 - Possible application to cargo ships with uncommon main dimensions and block coefficient
3. For the weight of superstructures, which is not included in the basic method, the method of Müller-Köster (see Sect. 2.15.4, B4) can be used
4. For calculating the steel structural weight of ships transporting standardized container (containerships), the above general formula shall be amended as follows:

$$W'_{ST} = \nabla_U \cdot C'_{ST} \cdot [1 + 0.002(L - 120)^2] \cdot [1 + 0.057(L/D - 12)] \cdot [30 / (D + 14)]^{1/2} \cdot [1 + 0.1(B/D - 2.1)^2] \cdot [1 + 0.2(T/D - 0.85)] \cdot [0.92 + (1 - C_{BD})^2]$$

where

$$C'_{ST} = 0.090 \div 0.100, \text{ average : } 0.093.$$

Constraints of Application (containerships)

- L = 100–250 m
 B = up to 32.25 m (Panamax)
 L/B = 4.7–7.63 (small feeder ships: up to 4.0)
 L/D = (8.12)–15.48 (lower limit of ship type: 10.0)
 B/D = 1.47–2.38
 B/T = 2.4–3.9 (for $T=0.61D$)
 = 1.84–2.98 (for $T=0.80D$)
 C_B = 0.52–0.716

(Extrapolation for small violations of the above limits is possible)

Table 2.26 Weights of container cell guides

| Container | | Weights of cell guides [t/TEU] | |
|--------------|--------|--------------------------------|------------|
| Type | Length | Fixed | Detachable |
| Ordinary | 20' | 0.70 | 1.0 |
| Ordinary | 40' | 0.45 | 0.7 |
| Refrigerated | 20' | 0.75 | – |
| Refrigerated | 40' | 0.48 | – |

Corrections (containerships):

1. For the exclusive use of a normal, mild shipbuilding steel (the formula applies to $L = 100\text{--}180$ m)

$$\delta W'_{ST}[\%] = 3.5(L^{1/2} - 10) \cdot [1 + 0.1(L/D - 12)]$$

2. For trapezoidal midship section (containerships): generally reduction of W'_{ST} : $\delta W'_{ST}[\%] \cong -5$
3. For raised double bottom beyond the regulations of Germanischer Lloyd classification society: for an increase of double bottom height by δh_{DB} and increase of double bottom volume by $\delta \nabla_{DB}$ it shows:

$$(\delta W'_{ST} / \delta \nabla_{DB})(40 + 0.5 \delta h_{DB}) 10^{-3} [\text{t} / \text{m}^3]$$

4. The weights of container cell guides *are commonly included* in W'_{ST} . Typical numbers of these weights are (Table 2.26):
5. The weights of the ducts of the cooling system (for reefer containers) and of the lashing equipment on deck are usually included in W_{OT} (see Sect. 2.15.5).

Center of weight W'_{ST}

In Schneekluth's method the approximation of the vertical position of mass center of W'_{ST} (without superstructures) is also included:

$$\overline{KG}'[\%D] = \left[44 + 0.155(0.85 - C_{BD}) \left(\frac{L}{D} \right)^2 \right] \frac{D_s}{D}$$

where

$$(D_s / D) = 1 + C_{BD}^{2/3} (S_F + S_A) / 6D$$

(applies to ships with sheer extending up to at least amidships).

Corrections

1. For transverse framing-system of construction/strengthening: -1% D
2. For bulbous bow: -0.4% D
3. For $L/B \neq 6.5$: $\pm 0.8\%$ D per $\delta(L/B) = \pm 1.0$

4. For $L \neq 120$ m: $+1\%$ D for $L = 60$ m and -1% D for $L = 180$ m

B4. *Weight of superstructures and deckhouses by Müller-Köster* (Müller-Köster 1973, Journal Hansa; Schneekluth 1985)

To calculate the total structural weight of the ship it is necessary to add the weight of superstructures and deckhouses to the main hull weight W'_{ST} , as calculated by Schneekluth.

Following Müller-Köster, this weight can be calculated as a function of the enclosed volume of the superstructures and in dependence on the location of the structural elements of superstructures and deckhouses.

Superstructures

According to the International Load Line Convention (ICLL), structures on the main deck (freeboard deck) with a distance of their side walls from the ship's side less than/equal to 4% B are assumed to be *superstructures* in the sense of ICLL. Such superstructures are:

a. Forecastle:

The volumetric weight (weight per volume unit) of a forecastle is:

$$C_{\text{FORECASTLE}} \cong 100 \text{kp/m}^3 \text{ for ship length } L \geq 140 \text{ m} \\ 130 \text{ kp/m}^3 \text{ for ship length } L \cong 120 \text{ m.}$$

Assumptions

$$\text{Height of forecastle: } h_{\text{FORECASTLE}} = 2.5 \text{ to } 3.25 \text{ m}$$

$$\text{Length of forecastle: } l_{\text{FORECASTLE}} = \text{up to } 0.2 L_{\text{PP}}$$

Corrections

$$\delta C_{\text{FORECASTLE}} [\%] \text{ up to } -10\%, \text{ for } l_{\text{BACK}} \cong 0.33 L_{\text{PP}} \\ \delta C_{\text{FORECASTLE}} [\%] \cong -5\% \text{ to } -10\%, \text{ for } h_{\text{BACK}} > 3.25 \text{ m.}$$

b. Poop²²:

$$C_{\text{POOP}} 75 \text{kp} / \text{m}^3$$

²² The poop deck is technically a raised *stern deck* that is rarely found on modern ships. In older sailing ships it could be seen as the elevated roof of the stern or "after" living quarters, also known as the "poop cabin". Also, with the helmsman at the stern, an elevated position was ideal for both navigation and observation of the crew and the sails. In modern history of shipbuilding, it could be seen until the 1960s on the "three island" type cargo ships, with the bridge and engine amidships (raised *quarterdeck*), and *forecastle* and *poop* decks at ship's ends. This concept was gradually displaced (and practically today disappeared) by the classical modern cargo ship arrangement, with the engine and bridge/superstructure placed astern, and having a 'flush' deck (extending unbroken from stem to stern, with no raised forecastle or quarterdeck) or keeping the forecastle at ship's bow region.

Assumption The poop extends up the forward bulkhead of the engine room, for engine room located abaft.

Corrections If the poop extends above a hold:

$$\delta C_{POOP}[\%] \cong + 20\%$$

Deckhouses

a. **Houses with living quarters:** Deckhouses extending over more than one deck are not considered as one single structure, but as consisting of several individual quarters, which are classified according to their vertical position above the main (uppermost continuous) deck. The weight of each quarter depends on its enclosed volume, but also on its structural density, which is clearly a function of the vertical position of the quarter and considers the loading of quarters located above the quarter in question. Quarters of superstructures, which are located directly on the main deck, are characterized as belonging to layer I (vertically extending up to Deck I), the ones above it to layer II, etc. (see sketch) (Fig. 2.76).

It is understood that if a deckhouse is located on the poop (or forecastle accordingly) then it begins with layer II.

The weight of the deckhouses depends on the following factors:

- Way of construction
- Length of ship
- Number of higher decks
- Height of decks
- Length of internal separating walls, if they are from steel/metal.
- Ratio of the upper deck (ceiling) area A_O , including the area of uncovered external *walkways*, to the actually covered (bottom) area of each deck A_U .

The following Table 2.27 gives the deckhouse weight per volume unit (structural density) as a function of the ratio A_O/A_U and layer position.

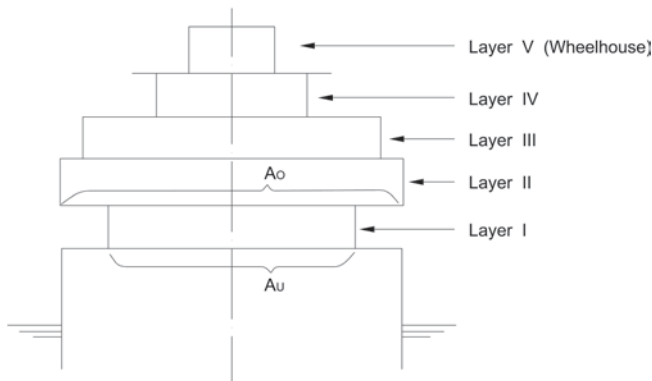

Fig. 2.76 Definition of individual layers for the calculation of the deckhouse weight by Müller-Köster

Table 2.27 Volumetric weight coefficients of deckhouses C_{DH} [kp/m³] as a function of the position and A_O/A_U ratio according to Müller-Köster

| Layer | I | II | III | IV | Wheelhouse |
|-----------|-----|----|-----|----|------------|
| A_O/A_U | | | | | |
| 1.0 | 57 | 55 | 52 | 53 | 40 |
| 1.25 | 64 | 63 | 59 | 60 | 45 |
| 1.5 | 71 | 70 | 65 | 66 | 50 |
| 1.75 | 78 | 77 | 72 | 73 | 55 |
| 2.0 | 86 | 84 | 78 | 80 | 60 |
| 2.25 | 93 | 91 | 85 | 86 | 65 |
| 2.5 | 100 | 98 | 91 | 93 | 70 |

The weight of a deckhouse section at the height/layer I to IV or at wheelhouse level is given by:

$$W_{DH} = C_{DH} \cdot A_m \cdot h \cdot k_1 \cdot k_2 \cdot k_3$$

where

C_{DH} [kp/m³]: volumetric weight coefficient, given in Table 2.15; interpolation is possible for intermediate A_O/A_U values

A_m : mean area value: $0.5 (A_O + A_U)$

h : height of deckhouse

k_1, k_2, k_3 : corrections

k_1 : correction for deckhouse height different from 2.6 m, namely $k_1 = 1 + 0.02 (h - 2.6 \text{ m})$

k_2 : correction for nonstandard length of internal walls (4.5 time of deckhouse section length) = $1 + 0.05(4.5 - l_1/l_{DH})$, where l_1 : total length of internal walls, l_{DH} : total length of deckhouse section

k_3 : correction for ship length significantly different from $L_{pp} = 150 \text{ m}$, i.e., for $\delta L_{pp} > \pm 30 \text{ m}$
 $= 0.95$ for $L_{pp} = 100 \text{ m} = 1.10$ for $L_{pp} = 230 \text{ m}$
(interpolation for intermediate values possible).

The above relationships apply to *superstructures and deckhouses* with accommodation facilities regardless of their definition according to the ICLL regulations (for forecastle-poop, see previous references).

b. Winch houses: The volumetric weight coefficient of winch houses can be calculated by the following empirical formula:

$$C_{WH} \left[\text{kp} / \text{m}^3 \right] = 48 + 4A_O / A_U (A_O / A_U + 8) + 18(150\text{m}^3 - \nabla_{WH}) / \nabla_{WH}$$

where

$$\nabla_{WH} \text{m}^3 = A_U \cdot h_{WH} (\text{max} : 150\text{m}^3)$$

Table 2.28 Correction factor for winch houses of derricks

| | | | | | | |
|---------------------------------|-----|------|------|------|------|------|
| Lifting capacity of derrick [t] | 10 | 20 | 80 | 100 | 130 | 150 |
| k_1 | 1.0 | 1.02 | 1.10 | 1.15 | 1.30 | 1.50 |

the volume of the winch house.

The winch house weight is given by:

$$W_{WH} = C_{WH} \cdot \nabla_{WH} \cdot k_1$$

where

k_1 : correction factor for winch houses of derricks with lifting capacity over 10 t, according to Table 2.28.

In case of very heavy lift derricks, which require special reinforcement of the foundations of the winch house, as well as of the winch basement, the above weights must be increased up to 70% W_{WH}

The above formulas apply to the following values of A_O/A_U , h_{WH} , ∇_{WH} :

$$\begin{aligned} A_O / A_U &= 1.0 \div 3.0 \\ h_{WH} &= 2.6 \div 3.2 \text{ m} \\ \nabla_{WH} &= 50 \text{ to } 200\text{m}^3 \end{aligned}$$

When calculating the C_{WH} , the ∇_{WH} must not exceed 150 m³, i.e., the value of the term in the last parenthesis of the formula should not be negative.

Weight centers of superstructures and deckhouses

For the vertical position of the weight centers, which are estimated as percentages of the height h of each deckhouse, and are calculated for deckhouses extending over more than one deck, for each section separately, it is assumed:

- 0.76–0.82 h , for deckhouses with internal walls
- 0.70 h , for deckhouses without walls

B5. Other advanced methods

a. **Steel structural weight by Puchstein (1961)** (Henschke 1964, Vol. 2, p. 457)

Application

“Standard” general cargo ships

Advantages

- High accuracy, but not for modern shipbuildings without the revision of individual coefficients and methods.
- Detailed breakdown of the weight of the steel structure into the weight of building blocks, which are approached separately (double bottom, shell plating, bulkheads, decks, strengthenings, superstructures and accommodation).

- The analysis of the steel structure into blocks facilitates the estimation of the centers of weight components.

Disadvantages

- Relatively tedious work
- It does not consider the longitudinal framing construction system.
- The individual elements of the method are to a great extent outdated; they can be updated/revised if there are available comparable data from similar ships.

Accuracy According to Puchstein: $\pm 1\%$

(only if data for modern ships are available).

Conclusions The obtained distribution of the steel weight of the individual components of the steel structure for the main ship hull (dry cargo ship) is very valuable:

| | |
|---|-----------------|
| Double bottom (includes the corresponding external shell) | 25–35% W_{ST} |
| External shell (includes sections/frames, without double bottom) | 22–35% W_{ST} |
| Bulkheads | 4–8% W_{ST} |
| Decks (includes deck strengthenings) | 20–36% W_{ST} |
| Other reinforcements (includes internal structures) | 3–18% W_{ST} |

b. **Steel Structural Weight by Sturtzel (1952)** (Handbuch der Werften; 1959, Schiffahrts-Verlag Hansa, Hamburg)

Disadvantages Outdated data based on *riveted* shipbuildings; apply only indirectly to welded constructions.

c. **Steel Structural Weight by Röster-Krause (1929–1952)** (Henschke 1964, Vol. 1, p. 549)

Disadvantages Older data of Röster (1929) were revisited by Krause (1952); however, they do not correspond to modern constructions.

C. Analytical methods of calculating W_{ST}

C1. *Method of Blohm & Voss Shipyard by Carstens* (1967, Journal Hansa, Schiffahrtsverlag HANSA, Hamburg)

Features Generalized method of wide applicability, where W_{ST} is given as a function of the hull area and of the structural components.

Advantages

- High accuracy, wide applicability to different types of ships
- Detailed data on the effect of specific features of the construction, which can be used in combination with other methods:

Disadvantages

- Laborious work proportional to the targeted accuracy of the calculations

D. Weight of other components of the steel structure (Dudszus and Danckwardt 1982, Journal Schiffstechnik p. 243; Journal Hansa, 1975, Schifffahrtsverlag HANSA, Hamburg, p. 417):

Additional components of the steel structure, which must be taken into account in the calculations, except for a few methods that inherently include them (e.g., C1), are elaborated in the following.

1. **High fuel tanks:** Their weight is calculated based on the weight of their side-walls (panel area), +30% for strengthening.
2. **Additional bulkheads:** Their weight is obtained from the weight of the required plating, +40–60% for the strengthening. For less bulkheads (with classification society's approval), we can reduce correspondingly the W_{STP} , which was estimated in advance.
3. **Strengthenings for heavy loads:** For heavy cargo loads in view of heavy bale cargo or ores special strengthening is required, especially of double bottom, according to the regulations of classification societies.
4. **Absence of planking of cargo hold floor:** Strengthening of cargo ships' holds' floor by 2 mm (according to GL), if planking overlay is missing; increase of strengthening by 5 mm or even more, if crab cranes or bulldozers are used for unloading.
5. **Height of double bottom:** If the double bottom height exceeds the standard size, for example, in Schneckluth's method the corresponding one specified by GL rules, an additional weight per unit volume difference of 100 kp/m³ must be taken into account. Assumption: longitudinal frame strengthening except of at the ends of the ship, where transverse section framing prevails.

For the transverse framing construction system of double bottom, the volumetric unit weight is approximately:

$$C_{DB}[\text{kp/m}^3] \cong 100 + 0.5 \cdot h_{DB} / (h_{DB})_{\text{NORM}} \text{ according to GL}$$

Assumption Floor plating on each section and lateral side girders every 4 m approximately. If the lateral side girders are fitted more densely, the coefficient C_{DB} must be increased by +30%.

The volume of the double bottom can be approximated by²³:

$$\nabla_{DB}[\text{m}^3] = L \cdot B \cdot h_{DB} \cdot [C_B - 0.4(T - h_{DB})^2] / [T^2 \cdot (1 - C_B)^{0.5}]$$

where h_{DB} [m] the maximum height of double bottom.

²³ The *minimum double bottom height* for dry cargo and passenger ships, as specified in SOLAS, is B/20 or 2 m, whichever is less (*but not less than 760 mm*). For RoPax ships with large lower holds, this changes to B/10 and 3 m, whichever is less (SOLAS 2009). The minimum requirements for tankers are led down in MARPOL.

Table 2.29 Ice strengthening according to classification societies

| Ice classes | | | | | | |
|-----------------------|-----|----|----|----|----------|---|
| Germanischer Lloyd | E | E1 | E2 | E3 | E4 | Icebreakers for navigation in North. and South Pole |
| Finish Lloyd | | IC | IB | IA | IA Super | |
| δW_{ST}^* [%] | 1–2 | 4 | 8 | 13 | 16 | up to 180 |

6. **Engines' foundation:** For particularly powerful engines, especially heavy slow-speed diesel engines without gearbox, an enhanced strengthening of their foundation by approximately 3.6 kp/kW is required, or to be taken according to the formula:

$$\delta W_{ST} [t / kW] = 27 / [(n + 250) \cdot (15 + P_B \cdot 10^{-3})]$$

where n [RRM]: number of engine revolutions per minute, P_B [kW]: engine break horsepower.

7. **Hatch coamings:** Continuous hatch coamings: $\sim 0.090 \text{ t/m}^3$. Noncontinuous coamings: $\sim 0.060 \text{ t/m}^3$. The values refer to the volume enclosed by the coamings of the hatchways above the deck.
8. **Reinforcements for corrosion:** If anticorrosion measures were considered appropriately, for example, the use of special coatings, the reinforcements of the plate thicknesses due to corrosion can be neglected, which leads to a reduction of W_{ST} . For a large tanker this can be: -3 to -5% of the W_{ST} (main hull).
9. **Strengthening for navigation in ice** (Table 2.29)

E. Reduction of structural weight—Use of higher-tensile steel and aluminum alloys

In addition to the significant effect of the main dimensions, particularly of L and D , and form coefficients, particularly of C_B , on the steel/ship structural weight, the limited use of alternative materials or higher tensile steels in certain cases, next to the common shipbuilding steel (mild steel), can reduce the ship's total structural weight and has a positive effect on the position of the center of gravity of the hull structure.

E1. Use of higher-tensile steel

Higher tensile steels (HTS), with a yield strength (YS) of 315 to 355 MN/m² or [MPa] and ultimate tensile strength (UTS) of up to 620 [MPa], compared to the common (mild steel) shipbuilding steel (YS 235 to UTS 490), are used *locally* in merchant shipbuilding with special requirements on strength, for example, in the bottom/deck areas of large tankers VLCC and ULCC, bulkcarriers and container-ships, as well as in structural blocks of large offshore structures. According to available data of actual constructions (Lamb eds. 2003), the proportion of higher tensile steel in large tankers is between 10% and 38% in extreme cases. It is estimated that using higher tensile steel locally on a tanker or a bulk-carrier (deck and bottom areas), the steel weight can be reduced by about 5~7%. Certainly, higher tensile

steels, along with titanium alloys, constitute the main construction material for naval submarines and other warships.

The negative aspects and some attention points of using higher tensile steel are summarized in the following:

- As the modulus of elasticity of higher tensile steel does not change significantly in comparison to the corresponding one of mild steel, it is not possible to reduce the plate thicknesses directly proportional to the higher tensile strength, because loadings on compression stresses (buckling problems) remain roughly the same, thus it would lead to serious strength problems, if plating is strongly reduced. The buckling issues require additional thicknesses/reinforcements, resulting in a mitigation of the weight savings from using higher tensile steel.
- The *fatigue* strength of higher tensile steel is not significantly higher than that of the common mild steel.
- The corrosion of the plating over the years does not change significantly, thus practically the effect is more drastic since it leads to further reduction of an already reduced thickness of plating.
- There are surcharges on the construction cost, not only because of the increased material cost, but also due to the required extra effort in working hours for the welding.
- Finally, there were, in recent time, reports about problems regarding the quality of some newbuildings and conversions of large tankers and bulkcarriers that were attributed to the quality of fitted HTS. Because a HTS construction is comparably more dependent on the quality of the fitted material, this is a very serious point of concern that needs to be carefully considered in the selection and quality control of the used steel material.

Some of above mentioned problems regarding the use of higher tensile steel, and generally regarding the sufficiency of strength of recent shipbuildings, led the classification societies of IACS (<http://www.iacs.org.uk>) to revise their regulations by introducing in year 2006 the Common Structural Rules (CSR) for the construction of tankers and bulkcarriers. These rules are in the direction of more rigorous construction and increased plating thicknesses. This was also in line with a proposal of the Greek delegation to IMO (together with Bahamas Islands) to consider the adoption of improved construction standards for new buildings (Goal Based Standards-GBS; Fig. 2.77).

E2. Use of light metals

Light weight materials, like aluminum, or better aluminum–magnesium alloys, are used for the construction of deckhouses and other individual structural components (e.g., funnels) of the ship's structure. Furthermore, they are the main construction material²⁴ for small vessels (up to $L \approx 40$ m) and high speed crafts in general.

²⁴ It should be noted that the largest ship ever built *entirely* from aluminum alloy was the high-speed hybrid SWATH catamaran "HSS1500" of STENA LINES, with LOA 126 m, beam 40 m and service speed 40 knots (Fig. 2.78).

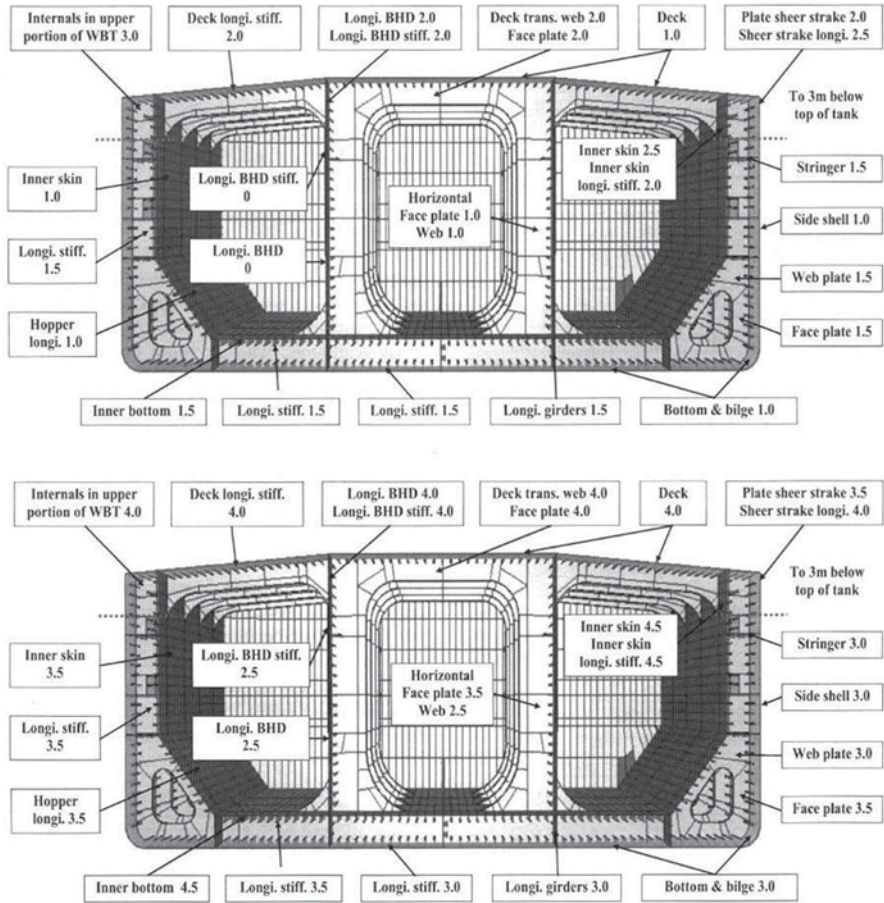

Fig. 2.77 Corrosion margins for tanker SUEZMAX (DWT: 158,000 t) according to old class society regulations (*upper figure*) and the new regulations (*bottom figure*) of IACS (Common Structural Rules). (Paik et al. 2009)

Compared to steel, important physical properties of aluminum are the reduced modulus of elasticity, namely it is only about 30% compared to that of steel, the reduced specific weight (also about 30%), the reduced tensile strength (depending on the alloy), and the low melting point.

As to the other features, it is worthy to note the higher acquisition cost of the material and the difficulties with its processing (increased cost in man-hours due to special welding and further processing).

In addition, because of the low melting point, fire safety regulations prescribe a special thermal insulation for aluminum-alloy structures, which requires an overlay of aluminum walls, forming the borders of fire zones on board; this overlay is usually made of sheets of steel preventing the spread of fire to other zones.



Fig. 2.78 All aluminum alloy high-speed hybrid SWATH HSS1500 of STENA Lines

The connectivity/foundation of the aluminum-structure on the remaining steel structure (if any) requires special care, because of problems with welding (use of riveted joints with plastic insulation or use of contemporary cladding technologies).

Finally, it can be considered that with the use of aluminum alloys, for example, for deckhouses, the corresponding weight will be reduced by approximately 45–50%, while the resulting cost *per unit weight* can be 5–7 times higher than that of the corresponding steel construction (up to 10 times for shipyards with less expertise in aluminum processing) (Fig. 2.78).

F. Approximation formulas

1. Dry Cargo Ships

Wehkamp–Kerlen (Tech. Hochschule Aachen, 1985, for the weight of main hull, without superstructures)

$$W'_{ST} = 0.0832 \cdot A \cdot e^{-5.73 \cdot A \cdot 10^{-7}}$$

$$A = L_{pp}^2 \cdot B \cdot C_B^{1/3} / 12$$

Carreyette (Watson and Gilfillan 1976, RINA)

$$W_{ST} = C_B^{2/3} (LB/6) D^{0.72} 0.002(L/D)^2 + 1$$

2. Tankers

Det Norske Veritas (1972)

$$W'_{ST} = \Delta[\alpha_L + \alpha_T(1.009 - 0.004 L/B) \cdot 0.06 \cdot (28.7 - L/D)]$$

where

$$\alpha_L = \frac{(0.054 + 0.004 \cdot L/B) \cdot 0.97}{0.189 \cdot (100L/D)^{0.78}}$$

$$\alpha_T = 0.0290 + 0.00235 \cdot \Delta \cdot 10^{-5}, \quad \text{for } \Delta < 6 \cdot 10^5 \text{ t}$$

$$\alpha_T = 0.0252 \cdot (\Delta \cdot 10^{-5})^{0.3}, \quad \text{for } \Delta > 6 \cdot 10^5 \text{ t}$$

Limitations:

$$L/D = 10 \div 14$$

$$L/B = 5 \div 7$$

$$L = 150 \div 480 \text{ m}$$

Assumptions:

- Use of mild steel
- Without superstructures/deckhouses
- Concerns old designs, without taking into account the influences of MARPOL, OPA90 and more recent CSR regulations.

Sato

$$W_{ST} = \left[\frac{C_B}{0.8} \right]^{1/3} \cdot \left[5.11L^{3.3} \frac{B}{D} + 2.56L^2(B+D)^2 \right] 10^{-5}$$

3. Bulk-Carriers

Det Norske Veritas (1972)

$$W_{ST} = 4.274 \cdot Z^{0.62} \cdot L \cdot (1.215 - 0.035 \cdot L/B) \cdot (0.73 + 0.0025L/B) \cdot (1.0 + (L - 200)/1800) \cdot (2.42 - 0.07L/D) \cdot (1.146 - 0.0163L/D)$$

where $Z[\text{m}^3]$: modulus of midship section

Limitations:

$$L/D = 10 \div 14$$

$$L/B = 5 \div 7$$

$$L = 150 \div 380 \text{ m}$$

Murray (Trans. IESS, 1965)

$$W_{ST} = 0.0328 \cdot L^{1.65} (B + D + T/2) \cdot (0.5 \cdot C_B + 0.4).$$

where L : length in foot (1 ft \approx 0.3048 m)

4. Containerships

Chapman (Univ. of Newcastle upon Tyne, 1969)

$$W_{ST} = 0.0209 \cdot L_{pp}^{1.759} \cdot B^{0.712} \cdot D^{0.374}$$

Miller (Univ. of Michigan, 1968)

$$W_{ST} = 0.000435(L \cdot B \cdot D)^{0.9} \cdot (0.675 + 0.5C_B) \cdot [0.00585(L/D - 8.3)^{1.8} + 0.939]$$

5. Various types of ships by Watson and Gilfillan

The following relationships were derived from the analysis of data of 70 (seventy) vessels of 14 (fourteen) different types.

$$W_s = W_{s1}(1 + 0.5(C_{B0.8D} - 0.70))$$

where

$$C_{B0.8D} = C_B + (1 - C_B) \cdot \frac{0.80D - T}{3T}$$

$$W_{s1} = kE^{1.36}$$

$$E = L(B + T) + 0.85L(D - T) + 0.85\Sigma(l_1h_1) + 0.75\Sigma(l_2h_2)$$

l_1, h_1 : length and height of superstructures

l_2, h_2 : length and height of deckhouses

Remarks

1. The basic form of all these formulas is:

$$W_{ST} = L^a \cdot B^b \cdot D^c \cdot C_B^d \cdot e.$$

In some formulas, where C_B^d is missing, it is understood that the result is valid for characteristic block coefficients of relevant ship type.

2. All formulas are based on the metric unit system, unless otherwise indicated.
3. The accuracy of the formulas can be satisfactory (about $\pm 10\%$), in all cases for which the ships under design do not differ significantly from the "standard" designs of the individual types. However, given that most of the above formulas were developed based on data of the 70s, the resulting weights can be relatively high for today's standards, in view of the general weight reduction due to the optimization of the structural weight with modern calculation methods and the extensive use of higher tensile steel (tankers, bulk-carriers).
4. All formulas can be easily programmed in computer codes for the optimization of the main dimensions in the preliminary design stage of a ship.

5. In all formulas with W_{ST} denotes the weight of the steel structure of the main ship hull *without* the superstructures and deckhouses.

2.15.5 Weight of Equipment and Outfit

The weight of equipment and outfitting W_{OT} (Outfit Weight) of accommodation and overall ship arrangements, as defined in Sect. 2.15.1, generally includes the weight of all outfitting/equipment fitted to the “naked” ship hull, except for the machinery equipment.

In recent years we observe generally an increase of this weight category, mainly due to the improved quality of accommodation, for example, extension and enhancement of outfitting of crew’s accommodation spaces, of sanitary facilities, of air-conditioning, and insulation against temperature changes and noise. The absolute increase of the weight of accommodation is not compensated by the incurred reduction of the crew number (for cargo ships).

As to the other equipment and outfitting beyond accommodation, a similar increasing trend is observed, particularly in comparison to data of the preceding 20 years, due to the increased weight of the cargo hold hatch covers (as applicable), the improved capabilities of cargo-handling means (higher lifting capacity of derricks and cranes), and the improved safety of firefighting facilities (CO₂-installations and insulations).

Certain structural components, such as stairways, derrick posts, rudder, steel hatch covers of holds, can be included either in W_{OT} or in W_{ST} following the practice of the yard or designer.

The incorporation of the various outfitting components to W_{OT} can be done in accordance to two general rules:

1. As to the *subject of work* of the various *production units* of the yard, for example machinery workshop, carpenter shop, etc. (see Table 2.30, for example).
2. As to the *functionality* of each element or group of elements (Table 2.31 of Schneekluth (1985), for instance).

The latter classification method facilitates the overall processing/production procedure in the shipyard, when ordering and installing the equipment: external suppliers/outsourcing, preparation of work/specification of equipment, construction/fabrication/acquisition/implementation-fitting/costing.

It is known that because of the nonuniformity/disparity of the W_{OT} elements it is not possible to develop unique methods for calculating the W_{OT} , as for the steel structural weight. In case of lack of comparative data from similar ships, one may resort to empirical formulas or coefficients for various types of vessels (see Tables 2.1 and 2.19), or diagrams from statistical data for specific types of ships.

Finally, the accurate calculation of the weights comprising the W_{OT} is only possible with the breakdown of the major outfitting weight groups, into individual weight components. The latter are estimated based on corresponding specifications of the shipyard

Table 2.30 Grouping of outfit weight components as products of corresponding shipyard's workshops or of external suppliers

| | |
|-------------------|---|
| I | <i>Heavy carpentry/wood work</i> : wooden decks, planking of holds, of refrigerated spaces and double bottom, wooden hatch covers, wooden bulkheads, wooden deckhouses, and nonwooden plating of holds (by aluminum or composite materials sheets)—contemporary specific weight values at the lower limit of Table 2.32 |
| II ₁ | <i>Insulation work</i> : Insulation weight as a function of type of insulation material and less of insulation thickness. Typical values: $V_{\text{Net Net}}/LBD=0.82-0.35$ or insulation weight/ $V_{\text{Net Net}}=30-80$ kp/m ³ |
| II ₂ | <i>Coating and anticorrosion work</i> : coatings, paintings, asphaltting, paving of floors, and walls |
| III | <i>Minor wood work</i> : internal accommodation walls, doors, furniture of accommodation spaces, carpeting of interior floors, curtains, upholstery, glass work. Typical specific weight/accommodation spaces' area: 60–70 kp/m ² |
| IV | <i>Piping works of ship</i> : piping for ballast, stripping, firefighting, freshwater-seawater, heating, scoopers, venting pipes, etc.; all valves, bolts, etc.; sanitary utensils, heating radiators; high values in the table for tankers and passenger ships due to extensive piping work |
| V | <i>Machining work</i> : steel doors, covers of hatches and bulkhead openings, etc.; stairs; machining work of interior accommodation arrangements, utensils for kitchen use and hotel functions (cookers, washing machines, etc.). Ducts for natural ventilation and air conditioning. Current values are at the upper limit of the table because of use steel hatch-covers; limited use of wood |
| VI | <i>Cargo handling equipment</i> : without masts (see steel structure), winches and derricks/cranes (see VIII ²), all the cargo handling components, namely derrick brackets, ropes, pulleys, hooks, chains, etc.; accurate estimation by specification of derrick/crane numbers, lifting capacity and external suppliers information |
| VII | <i>Towing and docking/mooring equipment</i> : except for the winches (see VIII ²), all towing and docking/mooring equipment. The given values in the table decrease with the absolute size of the ship |
| VIII ₁ | <i>Refrigeration equipment</i> : for reefer cargo spaces |
| VIII ₂ | <i>Other auxiliary machinery</i> : rudder gear, winches for all uses (anchors, loaders, life-boats), air conditioning, firefighting. Electrical installations. Communication facilities. High values in the table for cargo ships with heavy lifting equipment, refrigerated spaces; also, high values for passenger ships due to the extensive installations of electrical, air conditioning, firefighting, and communication equipment <i>Only for electrical installations</i> : cargo ships: 0.8–1.4 kp/m ³ , tankers: 0.7–1.0 kp/m ³ , reefer ships: 1.0–1.5 kp/m ³ , passenger ships: 3–4 kp/m ³ ; out of these weight values, 50–80% concern the weight of cables <i>Weight of refrigeration units</i> for cargo spaces depends on the net volume to be cooled: $\text{Weight}/V_{\text{Net Net}}=20-30$ kp/m ³ |
| IX | <i>Other equipment</i> : anchors, chains, ropes, canvas, life-boats, navigation marking equipment, tools, supplies, kitchenware, mobile equipment for accommodation spaces—high values for passenger ships |

or relevant information of external suppliers (detailed design phase). Certainly, this work is very laborious and usually the final outcome does not reach the accuracy of the steel or machinery weight estimations. However, the implementation of modern computerized systems in the production process of shipyards enables the recording, classification, and post-processing of individual outfitting items relatively easily (Table 2.29).

Table 2.31 Grouping of tasks and components of the ship's construction and outfitting in accordance with the function/operation of each component by Schneekloth (1985 in German)

| 0 | 1 | 2 | 3 | 4 | 5 | 6 |
|--------------------------|----------------------------------|--|--|---|---|---|
| OBJEKTKOSTEN ALLGEMEIN | SCHIFFSKÖRPER | AUSRÜSTUNG ZUR FAHRREREISCHAFT | AUSRÜSTUNG Z. NUTZUNG | EINRICHTUNG | VORTRIEB | VERSORGUNG MASSER+LUFT |
| 01 Konstruktive Arbeiten | 11 Einzelteile nach Bauelementen | 21 Säuern 211 Ruder 212 Rudermaschine 218 Rohrleitungen + Kleinteile | 31 Trockenladung 311 Wegerung für Container 314 für Deckladung 318 Rohrl.+Kleint. | 41 Komplette Räume 411 für Betrieb 412 Wohnen Besatz. 413 Wohnen Passag. 416 Sanitär 417 Wirtschaftsr. 419 Treppenhäuser 42 Trennwände | 51 Dieselanlage 511 Hauptmotor 512 Luft+Abgas 513 Kraft+Schmierst. 515 Kühlung 516 Fahrstand 518 Rohrl.+Kleint. | 61 Seewasser 611 Pumpen 612 Drucktanks 613 Filter 614 Peilen 618 Rohrl.+Kleint. |
| 02 Fertig.-Vorbereitung | 12 Zubehörtteile | 22 Festmachern 221 Ankeranrichtung 224 Verholeinrichtung 228 Rohrleitungen + Kleinteile | 32 Kühlung 321 Kühlanlage 322 Isolierung 323 Raumausstattung 328 Rohrl.+Kleint. | 42 Isolierungen 428 Kleinteile | 52 Dampfanlage | 62 Frischwasser 621 Pumpen 622 Drucktanks 623 Filter 624 Peilen 628 Rohrl.+Kleint. |
| 03 Bauplatz-Kosten | 23 Rettung | 23 Festmachern 231 Boote 232 Aussetzen 238 Rohrleitungen + Kleinteile | 33 Ladegeschirf 331 Masten + Bäume 333 Takelung 334 Winden 335 Kräne 338 Rohrl.+Kleint. | 43 Möbel 431 Schränke 433 Tische 434 Sitzmöbel 437 Kojen 438 Kleinteile | 53 Dampfmaschine 531 Pumpen 532 Siebe, Filter 534 Peilen 538 Rohrl.+Kleint. | 63 Abflüsse 631 Pumpen 632 Siebe, Filter 634 Peilen 638 Rohrl.+Kleint. |
| 04 Hilfsarbeiten | 24 Luken | 241 Lukendeckel 244 Mannlochdeckel 246 Klappen 247 Oberlichter 248 Kleinteile | 34 Oelladung 341 Oelpumpen 342 Wasserpumpen 343 Dampf 344 Lüftung 347 Tankreinigung 348 Rohrl.+Kleint. | 44 Sanitärer. 441 WC/Urinal 443 Badewannen 444 Duschen 446 Waschbecken 448 Kleinteile | 54 Sanitärer. 541 WC/Urinal 543 Badewannen 544 Duschen 546 Waschbecken 548 Kleinteile | 64 natürl. Lüftung |
| 05 Stapellauf | 25 Verkehr | 251 Leitern+Treppen 252 Geländer 255 Grätige 256 Sonnensegel 258 Kleinteile | 35 Sonderladung 351 Gas 352 Zement 353 Chemikalien 358 Rohrl.+Kleint. | 45 Verpflegung 451 Kochen, Braten 454 Kühlschränke 456 Proviant-Kühlr. 457 Provianträume 458 Rohrl.+Kleint. | 55 Verpflegung 551 Kochen, Braten 554 Kühlschränke 556 Proviant-Kühlr. 557 Provianträume 558 Rohrl.+Kleint. | 65 künstl. Lüftung 651 Lederäume 652 Sonstige Schiffsbe- reiche |
| 06 Kontrolle | 26 Fenster + Türen | 261 Fenster 264 Bullaugen 264 Türen 267 Schotttüren 268 Kleinteile 27 Feuerlösch | 36 Sonderaufgaben 361 Bergen 362 Schleppten 368 Rohrl.+Kleint. | 46 Hilfsgeräte 461 Geschirrspülen 464 Wäscherei 467 Gepäck 468 Rohrl.+Kleint. 47 Betreuung | 56 Leistungsbetrieb 561 Welle 562 Getriebe 564 Kupplung 565 Kühlung 568 Rohrl.+Kleint. 57 Vortrieb | 66 Klimaanlage 668 Rohrleitungen + Kleinteile 67 Heizung |
| 07 Abfertigung | 27 Wasser | 271 Wasser 272 Dampf 273 CO ₂ 274 Schaum 278 Rohrleitungen + Kleinteile | 36 Sonderaufgaben 361 Bergen 362 Schleppten 368 Rohrl.+Kleint. | 47 Betreuung 471 Messen 472 Speisestelle 473 Schwimmb./Spot 475 Läden 476 Medizin. Versorg. 478 Rohrl.+Kleint. | 57 Vortrieb 571 Festpropeller 572 Verstellprop. 573 Sonderprop. 578 Rohrl.+Kleint. 579 Verschiedenes | 67 Heizung 678 Rohrleitungen + Kleinteile |
| 08 Verwaltung | 28 Materialschutz | 282 Konservierung 283 Verzinken 284 Farbanstrich 288 für Rohrleitungen 289 Deckbelag außen | 38 Kleinteile | 48 Isolierungen 481 Feuer,Wärme 482 Schall 483 Masch.-Raum 484 Decksbeläge innen 488 Kleinteile | 58 Kleinteile | 68 Kleinteile |

Table 2.31 (continued)

| 7 ENERGIE-ERZEUGUNG | 8 SCHIFFSFÜHRUNG | 9 INVENTAR |
|------------------------------------|--|-------------------------|
| 71 Elektrisch | 81 Lichter, Signalanlagen | 91 Zimmermann |
| 711 Generatoren | 811 Lichter | 911 Leinen |
| 713 Gleichrichter | 814 Signale | 912 Allg. Inventar |
| 715 Stromspeicher | 819 Kleinteile | 913 Verbrauchsstoffe |
| 718 Kleinteile | | 916 Materialmitgaben |
| | | 917 Werkzeuge |
| | | 919 Unterbringung |
| 72 Hydraul.+Pneum. | 82 Navigation | 92 Rettung |
| 721 Hydraulik | 821 Kompass | 921 Rettungsinventar |
| 723 Pneumatik | 822 Selbststeuer-Anlagen | 922 Feuerlöschinventar |
| 728 Rohrleitungen | 823 Funknavigation | 926 Werkzeug |
| | 828 Rohrleitungen + Kleinteile | 929 Unterbringung |
| 73 Dieselantrieb | 83 Kommando-Anlagen | 93 Sonderinventar |
| 731 Motoren | 831 Sprechanlage | |
| 732 Luft + Abgas | 833 Alarmanlage | |
| 733 Kraftstoff | 838 Kleinteile | |
| 735 Kühlung | | |
| 738 Rohrl.+Kleint. | | |
| 74 Dampftrieb | 84 Funkanlage | 94 Wirtschafts-Inventar |
| | 841 Funkanlage | 941 Deck |
| | 842 Fernsehen | 942 Messen |
| | 843 Telefon | 943 Kammern |
| | | 944 Reinigung |
| | | 947 Werkzeuge |
| | | 949 Unterbringung |
| 75 Schaltanlage | 85 Rufanlage | 95 Maschine |
| 751 Schalttafeln | 851 Kammer-Rufanlage | 951 Instrumente |
| 752 Verteiler | | 953 Verbrauchsstoffe |
| 753 Schaltgeräte | | 954 Werkzeug + Gerät |
| 754 Meßgeräte | | 955 Ersatzteile |
| 758 Kleinteile | | 959 Unterbringung |
| 76 Kabelnetz | 86 Überwachung | |
| 761 Stromerzeugung | 861 Masch.-Überwachung | |
| 762 Stromverteilung n. Abschnitten | 862 Fernmeß-Anlagen für Tanks + Bunker | |
| 768 Kleinteile | 863 Sonstige Überwachung | |
| | 868 Rohrl.+Kleinteile | |
| 77 Beleuchtung | 87 Automation | 97 Elektriker |
| 771 Hauptbeleuchtung | 871 Überwachung | 971 Instrumente |
| 772 Notbeleuchtung | 872 Fernbedienung | 976 Werkzeuge |
| 778 Kleinteile | 878 Rohrleitungen + Kleinteile | 979 Unterbringung |
| 78 Abgas-u.Hilfskess. | | 98 Nautik |
| | | 981 Nautisches Inventar |
| | | 982 Laternen |
| | | 983 FT-Inventar |
| | | 989 Unterbringung |

Explanations: 0 general cost items (studies, preparation of production process, launching, ship delivery, and administration), 1 outline of ship hull components, 2 outline of outfitting for ship operation, 3 outline of outfitting for servicing the payload, 4 accomodation, 5 propulsion, 6 supply of water and air, 7 power generation, 8 steering and navigation, 9 spare parts, tools, utensils for accomodation, etc.

Table 2.32 Specific weight coefficients w for outfitting components $w = \text{weight}/L \cdot B \cdot D$ [kp/m³], D : side depth of strength deck (see Table 2.30) for ordinary merchant ships by E. Strohbusch (1971)

| Ship type Group | Cargo | Tanker | Reefer | Passenger |
|-------------------|---------|---------|---------|-----------|
| I | 1.5–6 | 0.5–1 | 1.5–5 | 8–14 |
| II ₁ | – | – | 10–26 | – |
| II ₂ | 4–7 | 1–2 | 4–7 | 4–10 |
| III | 5–6 | 1–2 | 6–8 | 8–12 |
| IV | 1.2–1.5 | 2.5–5 | 1.2–1.5 | 5–6 |
| V | 2–4 | 1.5–2 | 2–4 | 10 |
| VI | 2.5–4 | 0–0.1 | 1 | 0.5 |
| VII | 1–1.5 | 0.3–0.5 | 1–1.5 | 1 |
| VIII ₁ | – | – | 6.5–10 | – |
| VIII ₂ | 4–7 | 1.5–2 | 4–7 | 12–20 |
| IX | 2–3 | 1–1.5 | 2–3 | 3–4 |

A. Use of coefficients

In case of lack of other data from similar ships, the designer may use empirical coefficients, as in the listed tables (Tables 2.1, 2.32, and Papanikolaou and Anastopoulos 2002), or the references mentioned below.

These coefficients depend mainly on the ship type, on ship size and the outfitting quality. Of course, the employed coefficients should be appropriately adapted to the characteristics of the ship in such a way that they remain nearly constant for ordinary sizes of each ship type.

Provided that there are approximate data from similar ships available, their adaptation to the subject ship can be done by use of relational coefficients, as outlined in Appendix C (relational method of Normand).

Though outdated, the main references in the open literature regarding the appropriate use of coefficients for the calculation of W_{OT} are the following:

- Henschke*, Vol. 2, p. 465: Adapted coefficients to be multiplied by $(L \cdot B \cdot D)$.
- Weberling*, Handbuch der Werften (HdW), Vol. VII, p. 50–52 and HdW, Vol. V III, p. 144 (tankers and reefers)
- Watson-Gilfillan*, RINA 1976: Adapted coefficients to be multiplied by $L \cdot B$ instead of $L \cdot B \cdot D$
- Krause*, in *Henschke*, Vol. 2, p. 94: Adapted coefficients referring to the holds volume V_c ; reference to the analysis of the main groups of W_{OT}
- Danckwardt*: Adapted coefficients referring to the holds volume V_c , the deadweight DWT and the number of crew (see Figs. 2.79, 2.80, and 2.81).
- Henschke*: Adapted coefficients to be multiplied by $(L \cdot B \cdot D_{SS})^{2/3}$

where D_{SS} means the corrected side depth D , which accounts for the average height of the superstructure. The latter corresponds to the superstructure volume divided by the deck area.

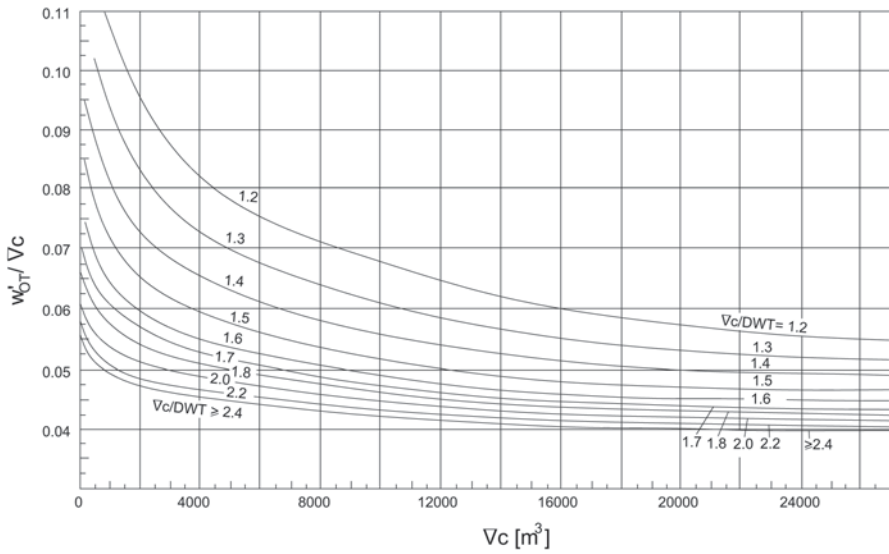

Fig. 2.79 Weight of outfitting versus the hold volume c and the ratio c/DWT for dry cargo ships according to Henschke (1964)

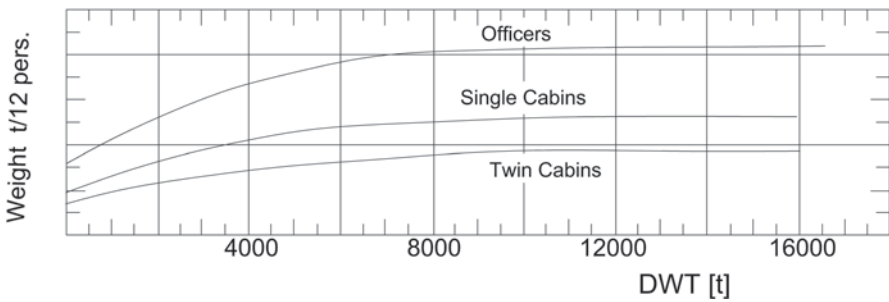

Fig. 2.80 Weight of accommodation outfit dependent on crew seniority vs. DWT for cargo ships by Henschke (1964)

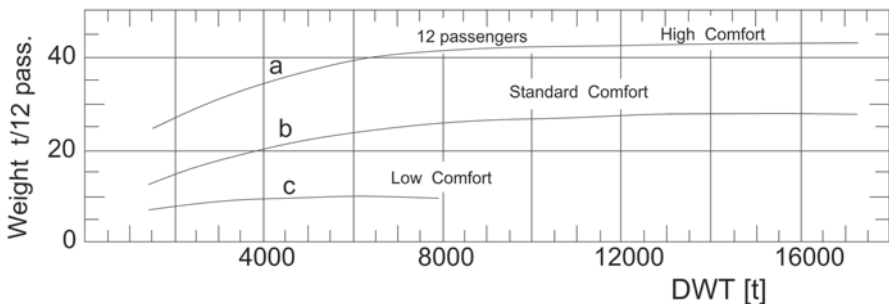

Fig. 2.81 Additional weight of accommodation outfit for 12 passengers vs. the DWT by Henschke (1964)

B. Approximate formulas (preliminary design stage)**Cargo Ships**

$$W_{OT} = K_{OT} \cdot L \cdot B$$

where

$$\begin{aligned} K_{OT} &= 0.40 - 0.45t/m^2 \text{ (general cargo ships)} \\ &= 0.34 - 0.38t/m^2 \text{ (container ships)} \\ &= 0.22 - 0.25t/m^2 \text{ (bulk-carrier, } L \cong 140\text{m)} \\ &= 0.17 - 0.18t/m^2 \text{ (bulk-carrier, } L \cong 250\text{m)} \\ &= 0.28t/m^2 \text{ (tanker, } L \cong 150\text{m)} \\ &= 0.17t/m^2 \text{ (tanker, } L \cong 300\text{m)} \end{aligned}$$

Dry cargo ships according to Henschke-Schneekluth (see Fig. 2.50, without accommodation)

$$W_{OT} = \frac{0.07(2.4 - \nabla_c / DWT)^3 + 0.15}{1 - \log_{10} \nabla_c} \cdot \nabla_c$$

where

∇ [m³]: hold volume (Grain)

∇/DWT [m³/t]: capacity factor.

This formula is valid for capacity factors in the range of:

$$1.2 \leq \nabla/DWT [m^3/t] \leq 2.4.$$

Reefer cargo ships according to Carreyette (Transaction of Royal Institute of Naval Architects 1976, p. 134)

$$W_{OT} = A \cdot (L/100)^2 + B(\nabla_i/1000)^{2/3}$$

where

L : length between perpendiculars

∇_i : total gross volume of reefer spaces/holds

$A = 550$

$B = 163$

Assumptions (Reefers)

- $L = 90 \div 165$ m
- Ships built in the 60s

Passenger ships (without vehicles, passengers in cabins)

$$W_{OT} = K_{OT} \cdot \sum_i \bar{V}_i$$

where

$$K_{OT} = 0.036 \div 0.039 \text{t/m}^2$$

$$\sum_i \bar{V}_i = \text{total gross registered volume (GRT) in [m}^3\text{].}$$

RoPax-Passenger Ships

The above coefficient K_{OT} is modified for passenger/RoPax ships and passenger ships of restricted voyages (without cabins) as follows:

$$K_{OT} = 0.04 \div 0.05 \text{t / m}^3$$

C. Use of approximate diagrams

The outfit weight W_{OT} of cargo ships can be also approximated by analyzing it into one part which is dependent on the size of the ship, for instance, the hold volume or the DWT, and another one that refers to the number of crew or the specific requirements of the owner.

For dry cargo ships, the first weight part of W_{OT} can be obtained from Fig. 2.79 as a function of the hold volume \bar{V}_C and the ratio \bar{V}_C / DWT (see Henschke 1964).

Herein, we assume an ordinary ship with two decks, steel hatch covers on the uppermost deck and wooden cover for the intermediate deck. Correction for a third deck will be: +5–10%. Likewise, corrective increases are required for ships with extra wide hatch covers, which also require larger, non-wooden covers for the intermediate deck openings.

The second part of W_{OT} that depends on the number of persons on board (crew and possible passengers) can be obtained from Figs. 2.80 and 2.81 that account for the quality of accommodation for the persons on board.

The below Fig. 2.82 provides the ratio of W_{OT} to $L_{BP} \cdot B$ as a function of length L_{BP} for various types of ships, while from Fig. 2.83 the W_{OT} can be obtained as a function of the product $L \cdot B$ for passenger ships.

Similar diagrams also exist for other types of ships, such as tankers and bulk-carriers (see e.g., Lewis 1988; Henschke 1964), however, the more outdated data in Henschke (1964) are inferior to those resulting from application of the foregoing methods (A and B) in terms of accuracy.

D. Detailed calculation of groups of outfit weights

The following W_{OT} estimation method was proposed by Schneekluth (1985); it forms an intermediate approach in between the detailed calculation of the individual outfit weights and the approximate methods (A to C). The accuracy of the method

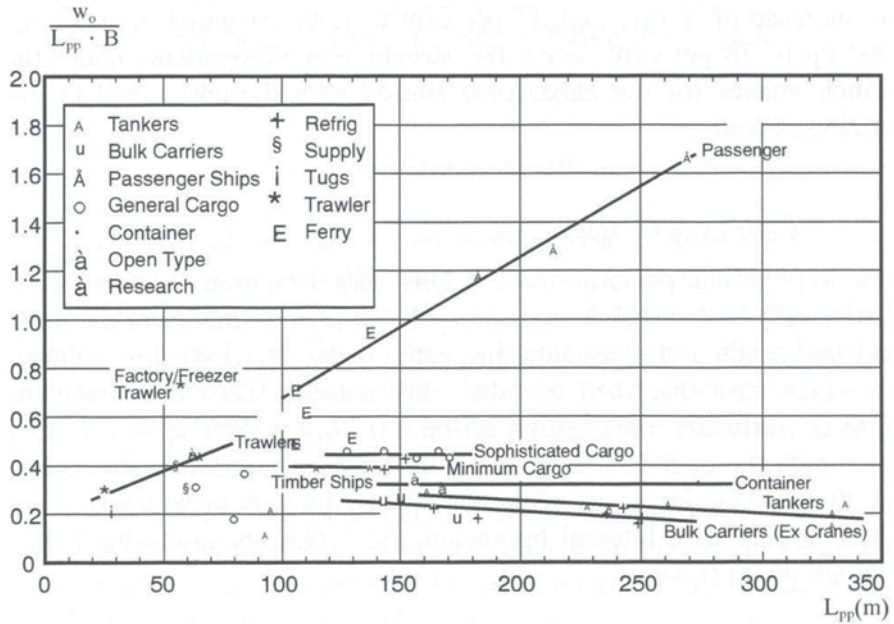

Fig. 2.82 Ratio of outfit weight to $L \cdot B$ as a function of length L by Watson (1998). (in Friis et al. 2002)

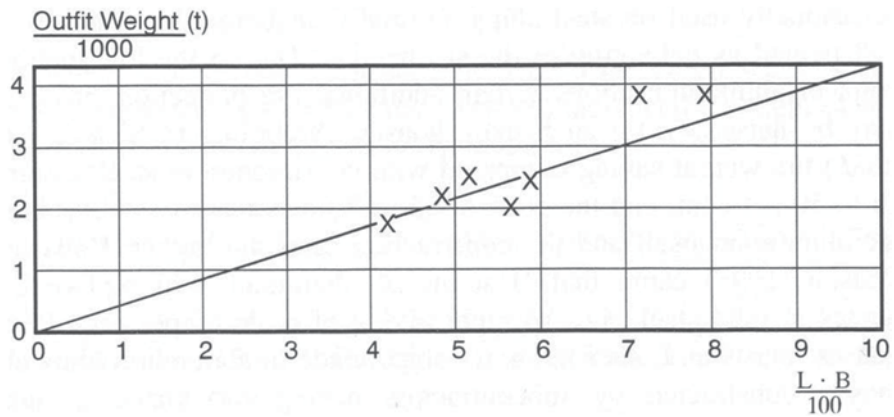

Fig. 2.83 Outfit weight as a function of $L \cdot B$ for passenger ships by Watson (1998). (in Friis et al. 2002)

is satisfactory for all design stages, beyond the preliminary phase. Besides the calculation of weights, this method also facilitates the estimation of the weight centers.

The main principles of the method are:

1. Certain groups of weights of W_{OT} , distinguished by their relatively large absolute weight (e.g., hatch covers, loaders, etc.), can be calculated accurately from the very beginning, avoiding approximation errors by use of empirical coefficients.
2. Coefficients are used only for those groups of weights of W_{OT} , for which the conceptual reduction to certain characteristic sizes of the ship, for example, the accommodation area, is possible and known, without large uncertainty. In addition they can be used for onboard equipment that is independent of ship type.
3. If several weight subgroups are calculated approximately, there is a high probability that the errors in the individual estimations are heterogeneous as to their sign. Thus, compared to an approach referring the total W_{OT} through coefficients, one may expect a balancing of differences resulting from the individual estimations (errors of opposing signs partially cancelling each other). The method applies primarily only to general cargo ships and containerships; however, the extension to other types of ships with corresponding adaptation of required changes appears possible.

D1. *Weight groups of W_{OT} by Schneekluth*

- I. Hatch covers
- II. Cargo-handling equipment
- III. Accommodation
- IV. Other weights.

D2. *Approximations of weight groups*

I. Hatch Covers: This group includes *all* weights of the hatch covers, and their built-in driving system (Table 2.33; Figs. 2.84 and 2.85).

Malzahn’s Formula for the Single–Pull system with a load of 1.75 t/m³

Table 2.33 Weight of weathertight Single-Pull hatch covers versus hatchway size and vertical loading due to deck-containers.

| Hatchway breadth [m] | Weight [kp] per meter of hatchway length | | | | |
|--|--|-------|-------|-------|-------|
| | 6 | 8 | 10 | 12 | 14 |
| Normal load 1.75 t/m ³ | 826 | 1,230 | 1,720 | 2,360 | 3,150 |
| Load by one layer of containers ^a | 826 | 1,230 | 1,720 | 2,360 | 3,150 |
| Load by two layers of containers | 945 | 1,440 | 2,010 | 2,700 | 3,550 |

^a 20 ft (TEU) containers are assumed having a weight of 20 t.
^b For the “Piggy Back” system reduction of weights by about 4 %

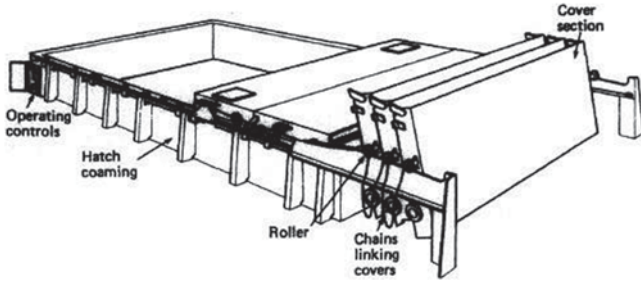
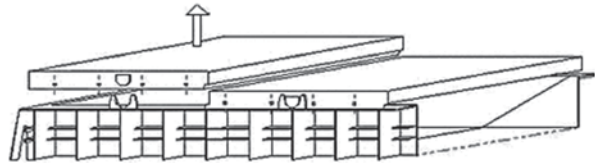

Fig. 2.84 Single-pull weather-deck hatch cover

Fig.2.85 Piggy-back hatch cover



$$W_H / l_H = 0.0533 \cdot b_H^{1.53} + \delta b_H \cdot 0.065$$

where

- W_H : weight of cover [t]
- l_H : length of cover [m]
- b_H : breadth of cover [m]
- δb_H : difference in breadth beyond 12 m.

For pontoon type covers, the weight estimated by the formula of Malzahn can be reduced by up to approximately 15% (Table 2.34; Fig. 2.86).

Table 2.34 Weight of nonweathertight hatch cover of foding type

| | Weight [kp] per meter of hatch breadth | | | | |
|-----------------------------------|--|-------|-------|-------|-------|
| Breadth of hatch [m] | 6 | 8 | 10 | 12 | 14 |
| Normal load ^a | 845 | 1,290 | 1,800 | 2,440 | 3,200 |
| Use of forklift ^b | 900 | 1,350 | 1,870 | 2,540 | 3,360 |
| Two layers container ^c | 930 | 1,390 | 1,940 | 2,600 | 3,460 |

^a Normal load for a deck height up to 3.5 m (GL).

^b Forklift trucks of a total weight of 5t, with rubber wheels.

^c 20 ft container (TEU) and 20 t/TEU.

^d The total weight of the hatchway covers on general and multi-purpose cargo ships or semi-containerships can reach values of up to 50% of W_{OT} .

Fig. 2.86 Folding type tween deck hatch covers



Tween decks (Nonweathertight covers—folding type design)

II. Cargo-handling equipment: This group includes: Derricks, winches, deck cranes, planking of hold, lashing units of containers; however, *without* the derrick’s mast that is typically included in W_{ST} . For Ro-Ro ships, all the ramps, external or internal, are included in this subgroup of weights.

Lightweight of derricks and cranes²⁵ (Fabarius, Handbuch der Werften, Vol. VII, p. 168 Henschke, Vol. 2, p. 97)

Weights are functions of lifting capacity and boom length. For rotating cranes, the following applies (Table 2.35; Figs. 2.87 and 2.88):

Table 2.35 Weight of rotating cranes by Fabarius. (Schneekluth 1985)

| Maximum lift weight [t] | Maximum span [m] | Structure’s height [m] | Crane Weight [t] |
|-------------------------|------------------|------------------------|------------------|
| 1 | 10 | 3.7 | 10 |
| 2 | 10 | 3.7–4.3 | 7–11 |
| – | 14 | 4.3–5.0 | 8–13 |
| 3 | 10 | 3.7–4.5 | 8–11 |
| – | 16 | 4.3–5.0 | 10–15 |
| 5 | 10 | 3.7–5.1 | 10–15 |
| – | 16 | 4.7–6.3 | 13–16 |
| 7.5 | 14.5 | 5.9 | 20 |
| – | 16 | 6.5 | 21 |

²⁵ A *derrick* is a lifting machine for hoisting and moving heavy objects, consisting of one or more movable booms equipped with cables and pulleys and connected to the base of an upright stationary mast. The movements of the boom (up-down-sideways-lift of weight) are supported by winches. A *crane* is a contemporary development of the derrick; in difference to the derrick, the movement of the boom is enabled by its turning base and the hoisting and moving of objects by means of cables attached to the boom.



Fig. 2.87 Outdated and contemporary general cargo ships equipped with conventional derricks (*left*) and turning cranes (*right*) respectively

Fig. 2.88 Heavy lift Stülcken derrick®



Heavy lift derricks

The weights of derricks and cranes are generally functions of their lifting capacity, lifting speed and type of winches. Approximate values: 0.16–1 t per t of lifting capacity. More detailed descriptions and data may be found in Papanikolaou and Anastassopoulos (2002).

Planking of holds

Modern cargo ships are constructed without interior planking of the holds unless required by the owner. However, for the planking of the sides of hold spaces, with wooden planks, the required wood volume can be approximated by the projected area of the hold multiplied by a mean thickness of 50 mm. The same can be applied to the planking of the bulkheads. In the calculated weight a margin of 10% is added for the fittings.

For the planking of hold's floor, usually pinewood is used, namely longitudinal planks of thickness 80 mm can be fitted, which are supported at each frame by transverse battens, of 40 mm × 80 mm cross section.

Lashing units of containers

For containers on deck the weight of lashing equipment needs to be added, that is (Figs. 2.89, 2.90, and 2.91),

0.024 t/TEU (container 20')

0.031 t/FEU (container 40')

0.043 t/TEU (mixed loading with TEU and FEU)

Ramps of Ro-Ro ships

Exterior ramps

Fig. 2.89 Container lashing



Fig. 2.90 Ro-Ro loading ramp



Fig. 2.91 Ro-Ro interior ramp



length 5 m: $\sim 0.3 \div 0.4 \text{ t/m}^2$

20 m: $\sim 0.4 \div 0.6 \text{ t/m}^2$

50 m: $\sim 0.55 \div 0.75 \text{ t/m}^2$

Interior ramps

length 15 m: $\sim 0.15 \div 0.25 \text{ t/m}^2$

50 m: $\sim 0.30 \div 0.40 \text{ t/m}^2$

III. Accommodation: This group of weights referring to the accommodation quarters of crew and passengers, includes:

- Separation walls of superstructures, if not included in W_{ST}

- Panelling/insulation of interior rooms
- Sanitary installations and related pipes
- Doors, windows, other coverings of openings
- Heating, ventilation, air conditioning
- Kitchenware and other household utensils
- Furniture and arrangements of spaces
- Lighting and cables

All the weights included in this group can be calculated through the corresponding volume of the fitting or through the respective accommodation area. Characteristic values are:

Small to medium size cargo ships

$$\begin{array}{l} 160 \text{ to } 170 \text{ kp/m}^3 \\ \text{or} \quad 60 \text{ to } 70 \text{ kp/m}^2 \end{array}$$

Large cargo ships, tankers

$$\begin{array}{l} 180 \text{ to } 170 \text{ kp/m}^3 \\ \text{or} \quad 60 \text{ to } 70 \text{ kp/m}^2 \end{array}$$

Notes

1. The above specific weights generally increase for improved accommodation quality.
2. The values also increase for ships of absolutely large size and for corresponding very large accommodation areas (e.g., mega cruise ships).
3. For passenger ships, the values depend directly on the quality of the passengers' accommodation; the use of data from similar ships is essential.

IV. Other weights

The following items belong to this group:

- Anchors, chains, hawsers
- Anchor-handling and mooring winches, bollards
- Steering mechanism (excluding rudder)
- Refrigeration equipment
- Insulating works beyond interior accommodation
- Rescue equipment and launching systems
- Bulwarks, stairs, doors and covers beyond indoor accommodation area
- Fire-fighting systems
- Pipes, bolts, valves, gauges (outside the engine room and accommodation area)
- Hold ventilation
- Navigation facilities and signalling equipment

- Tools of deck crew

As in the previous category, the weight of this group is mainly a function of the ship size; it is independent of ship type.

Approximation formulae

$$W_{IV} = (L \cdot B \cdot D)^{2/3} \cdot C_1, \text{ where } C_1 = 0.18 \div 0.26 \text{ or}$$

$$W_{IV} = W_{ST}^{2/3} \cdot C_2, \quad C_2 = 1.0 \div 1.2$$

where, W_{ST} και W_{IV} are given in [t] and L, B, D in [m]

General comments

The present method of splitting the W_{OT} into four subgroups can be modified for other ships than general cargo types of ships, such as reefers and tankers, by creating additional subgroups for the reefer cargo holds and the piping system of tankers, respectively.

E. **Centre of weights of W_{OT}** (Weberling, Handbuch der Werften, Vol. VII, p. 56 & Vol. VIII, p. 138)

General principles

1. If the weight components of outfitting were calculated individually, for example, by method type D or even in a more elaborate way, then the mass centre of the group W_{OT} can be estimated through the balance of the sum of the individual moments.
2. If the weight W_{OT} has been approximated globally, then it can be further analysed by breaking it down into subgroups and by taking the corresponding moments following method A.
3. If there are data from similar ships for the W_{OT} group, they can be used as first approximations.
4. Typical values for the vertical mass centre of the W_{OT} group

Dry cargo ships:

$$KG_{OT} = (1.00 \div 1.05) \cdot D_{SS}$$

Tankers:

$$KG_{OT} = (1.02 \div 1.08) \cdot D_{SS}$$

where the corrected side depth D_{SS} was already defined before.

5. For the initial estimations, relevant tables of reference Papanikolaou and Anastasopoulos 2002 (see also Table 2.19) are very useful.

2.15.6 Weight of Machinery Installation

The weight of the machinery installation, which can be decomposed (see definition, Sect. 2.15.1) into:

Table 2.36 Weight W_{MM} for various types of main engines of merchant ships. The power given in the table is the maximum continuous rating (MCR)

| Type of engine | Power (kW) | Weight (t/kW) | RPM |
|------------------------------|--------------------------------------|---------------|---------|
| Slow-speed diesel | 2,000–5,000 | 0.015–0.022 | 250–175 |
| | 5,000–10,000 | 0.022–0.029 | 175–100 |
| | 10,000–70,000 (84,420 ^a) | 0.029–0.039 | 100–80 |
| Medium-speed diesel | 600–17,000 (20,000) | 0.009–0.018 | 900–400 |
| High-speed diesel (MTU type) | 240–9,100 | 0.003–0.004 | > 1,000 |
| Gas turbines (LM type) | 4,412–42,160 | 0.001 | > 3,600 |

^a The world's largest diesel engine in the year 2010 was the Wärtsilae-Sulzer RTA96-C marine diesel engine of about 84,420 kW (113,210 HP) @ 102 RPM delivered horsepower

$$W_M = W_{MM} + W_{MS} + W_{MR}$$

where

- W_{MM} : weight of main engine
 W_{MS} : weight of shaft and propeller
 W_{MR} : weight of rest mechanical components,

includes the following weights:

- Main engine installation, consisting of the main engine(s) with reduction gear units (*only for non-low-speed diesel engines*), or of turbines with boilers (W_{MM})
- The exhaust system (W_{MR})
- The propellers and the transmission system, that is, propeller shaft(s) and shaft bearings, including stern–tube bearing (W_{MS})
- The electric generators, the cables to the switchboards/transformers (W_{MR})
- Pumps, compressors, separators (W_{MR})
- Pipes in the engine room (with fillings), also (often) piping of double bottom for pumping fuel or ballast (W_{MR})
- Desalination/drinking water production equipment (W_{MR})
- Sewage disposal system (W_{MR})
- Other equipment of the engine room: ladders, floor gratings, heat and noise insulations (W_{MR})
- In addition, usually: central refrigeration facilities (for reefer ships); outfitting of cargo pump room (tankers; W_{MR} , if not included in the W_{OT})

Factors affecting the weight of machinery installation

1. *Type of main engine*: Diesel of slow-speed, medium-speed, high-speed (small vessels), diesel-electric propulsion, steam turbine, gas turbine (mainly for naval ships); affects W_{MM} ; (Table 2.36)
2. *Ship type and type of carried cargo*, for example, passenger ships and reefer cargo ships have a high demand on electrical energy (high W_{MR}). Also, diesel engine-powered tankers need a special boiler to produce steam for the cargo discharging pumps, the heating of cargo and cleaning of tanks (affects W_{MR}).
3. *Number of propellers* (affects W_{MS})

4. *Position of engine room* (affects W_{MS} , because of the length of the propeller shaft)
5. *Owner's special requirements* concerning the disposition of backup machines/components, electric generator sets, etc

Methods of calculating weight W_M

- A. Approximation of the total weight of W_M or the subgroups W_{MM} , W_{MS} , W_{MR} based on empirical coefficients (initial study)
- B. Calculation based on known individual weights that constitute the W_M (final design phase)
- C. Calculation based on comparable data of similar engine installations (initial study)
- D. Approximation leading to a relationship to the weight of the main engine (initial study)
- E. Calculation based on a breakdown of W_M into subgroups (advanced stage of design study)

A. Approximation method based on empirical coefficients (initial study)

During the preliminary design stage, W_M can be approximated through empirical coefficients referring to the W_{MM} , W_{MS} , and W_{MR} subcomponents that make up the W_M (see Table 2.37). These coefficients, which refer to the various types of ships, are normalized partly by use of the installed propulsion power (W_{MM} and W_{MS}) or by the volumetric product $L \cdot B \cdot D$ —alternatively the propulsion power—for the W_{MR} weight.

B. Calculation Based on Known Individual Weights

In the final design stage, rarely for merchant ships, but extensively in the study of naval ships and submarines, the weight of the engine installation is calculated by summing up all individual weights that make up the W_M . During this laborious work the following points must be taken into account:

1. In the weight of pipes, boilers, and settling tanks located in the engine room, which comprise (W_{MR}), the weight of contained liquids (water, oil, and lubricants) must be added.
2. Particularly, as to the weight of the rest machinery installation (W_{MR}), all individual weight components of the engine room equipment must be added.

C. Calculation Based on Comparable Data of Similar Machinery Installations

Provided that comparable data of similar engine plants are available, we must pay attention to the following points:

- Type of main engine (diesel, turbine, etc.)
- Subtype of main engine (diesel engine cylinders “in serial arrangement” or V-type, steam pressure turbine)
- Number of revolutions of engine and propeller

Table 2.37 Coefficients of weight groups of machinery installation for merchant ships according to E. Strobusch (1971)

| Ship type | Cargo ship | Tanker | Reefer ship | Fast passenger ocean liner | Fast small passenger ship |
|----------------------------|----------------------------------|------------------------|----------------------------------|----------------------------|--|
| Coefficient | | | | | |
| w_1 (kp/m ³) | 10–15 | 3–5 | 20–25 | 15–25 | 25–45 |
| w_2 (kp/HP) | 35–50 | 25–35 | 50–70 | 20–30 | 30–55 |
| w_3 (kp/HP) | 5–10 | 4 | 8–10 | 8 | 5–10 |
| w_4 (kp/HP) | Low-speed diesel engine 30–40 | Steam turbine 20–25 | Low-speed diesel engine 30–40 | Steam turbine 20–25 | Medium-speed engine with gearbox: 22–30 New technology: 12–17 |
| w_5 (kp/HP) | 85–90 | 55–60 | 90–110 | 50–60 | 70–80 |

1. Analysis of machinery weight:

$$W_M = W_{MM} + W_{MS} + W_{MR}$$

W_{MM} : weight of main engine(s) and gearbox(s) (for turbo machinery: turbines, gearbox, boilers)

W_{MS} : weight of propeller shaft and propeller(s) (includes: all shaft bearings, including crankshaft and stern-tube bearings)

W_{MR} : weight of rest machinery installation components (support equipment for the operation of main engine: fuel pumps, pumps for lubrication oil, cooling water, evaporators, etc. Piping of engine room for fuels, lubricants, cooling, steam, etc. Exhaust ducts, funnel. Boilers. Ventilation ducts of engine room. Mobile tanks of engine room, pumps for ballast, stripping, firefighting, engine room fresh water. Main electrical installation, electric generators, transformers, switchboards. Engine room tools.

2. Definitions: $w_1 = W_{MR}/LBD$, $w_2 = W_{MR}/SHP$ (SHP: shaft horse power), $w_3 = W_{MS}/SHP$, $w_4 = W_{MM}/SHP$, $w_5 = W_M/SHP$

- Size of ship and engine room
- Magnitude of propulsion power
- Magnitude of electrical power generation (Henschke 1964, p. 467; Watson and Gilfillan 1976, p. 292; Buxton, Transactions RINA 1976, p. 316)

Approximation Formulae

Diesel Engines for Cargo Ships:

Watson–Gilfillan

$$W_M[t] = C_{MD} P_B^{0.89}$$

where

P_B (kilowatt): break power of main engine

$C_{MD} = 0.21$ (medium-speed diesel)

$= 0.30 \div 0.50$ (low-speed diesel)

Steam Turbines for Cargo Ships according to Buxton

$$W_M [t] = C_{MT} P_D^{0.5}$$

where

P_D (kilowatt): delivered power at the propeller
 $C_{MT} = 10.2$ single-screw
 $= 14.1$ twin-screw
 $= 5.8$ small ships

The above-introduced coefficients C_{MD} and C_{MT} can be actually adjusted to the particularities of the subject ship, based on the data of similar machinery installations.

Typical values for the machinery weight of slow-speed and medium-speed diesel engines are:

$$100 - 140 \text{ kp/kW, for powers of } 3,000 - 20,000 \text{ kW,}$$

while the average value for turbocharged diesel installations of power 3,000–12,000 kW is: 130 kp/kW.

D. Approximation based on the weight of main engine

The basic reasoning of this method is similar to that of the previous section. On condition that there are comparative data from other ships with similar machinery installations, the calculation of the W_M weight is reduced to the weight of the main engine (plus gear unit, if any), which can be calculated accurately from the manufacturers' lists, especially for diesel-engine ships.

According to Watson and Gilfillan, the total weight of diesel-engine installations can be approximated as follows:

$$W_M = W_{MM} + W_{MREST}, \text{ where}$$

$$W_{MM} = 12 (MCR_1 / RPM_1 + MCR_2 / RPM_2 + \dots + MCR_N / RPM_N), \text{ where}$$

MCR_i : MCR of engine (i), RPM_i : revolutions per minute of engine (i), N : number of engines

$$W_{MREST} = C_m (MCR)^{0.70}, \text{ where}$$

$$\begin{aligned} C_m &= 0.69 \text{ (bulkcarriers, cargo, and containerships)} \\ &= 0.72 \text{ (tankers)} \\ &= 0.83 \text{ (passenger ships and ferries)} \\ &= 0.19 \text{ (frigates and corvettes, for MCR in kilowatt)} \end{aligned}$$

Typical values of specific weights (kp/kW) of marine diesel engines are given in the following; note, however, that they do not include the weight of lubricants and cooling water:

| | |
|--|-------------|
| Slow-speed diesel (110–140 RPM) | 35–46 kp/kW |
| Medium-speed diesel (400–500 RPM in series) | 15–20 kp/kW |
| Medium-speed diesel (400–500 RPM V type) | 11–15 kp/kW |
| High-speed diesel (1,000–2,600 RPM)—large ones | ≥4 kp/kW |

For directly driven diesel-engine installations (low-speed diesel), W_M weight can also be calculated as follows (Schneekluth 1985):

$$W_M = C_{M1} W_{MM}$$

where

W_{MM} : main engine weight (tonnes)

$$C_{M1} = 2.2 \div 3.6, \text{ average value} = 2.6.$$

The coefficient C_{M1} can be adjusted to the under design ship based on comparable data of a parent ship.

For indirect diesel engine installations (medium-speed diesel with gear units) it applies correspondingly:

$$W_M = C_{M2} (W_{MM} + W_{MG})$$

where W_{MG} : weight of gearbox, including clutch (tonnes)

$$C_{M2} = 3.5 (\text{upper limit of } C_{M1}).$$

The weight of the gearbox (and clutch) can be calculated based on the manufacturers' catalogues and is a function of the main engine's power, the developed thrust of the ship, input/output revolutions per minute, and the construction method (layout of gears, way of housing—cast or welded).

For gearboxes with welded housing and 100 RPM exit speed (to the propeller), the specific weight is 3–5 kp/kW, while for a casted housing the weight is up to three times higher (see Henschke 1964, pp. 87–93).

For propeller speeds n_p larger than 100 RPM, but within the typical limits of merchant ships, the specific weight of the gearbox in (kp/kW) is about:

$$(3.4 \text{ to } 4.0) \cdot 100 / n_p (\text{RPM})$$

Nevertheless, calculating the weight of the gearbox and that of the required clutch separately, if the latter is not integrated in the gear unit, the specific weight increases by the factor two (see Ehmsen, HdW XII, p. 250 (Handbuch der Werften, Schifffahrtsverlag-Verlag HANSA, Hamburg) and Volume 2 in Papanikolaou 2009a).

For turbine ships, indicative values for the specific weight of the total engine plant range between 15~19 kp/kW. This weight includes: steam turbines, gearboxes, boilers with water, and condensers. Its analysis shows that about 50% of this weight refers to the weight of the boilers filled with water.

E. Calculation based on the breakdown of the W_M into subgroups

This method combines the use of accurate individual weights, if they can be calculated, and the use of empirical coefficients for the more complex subgroups.

H. Schneekluth (1985) proposed to analyze the machinery weight by dividing it into four subgroups:

- I. Engine installation.
- II. Electrical generator units.
- III. Other weights except I & II
- IV. Specific weights for ships of *special* mission

I. Engine installation

- I1. Main engine: from manufacturers' catalogue
- I2. Gearbox-clutch: from manufacturers' catalogue
- I3. Shaft (without bearings)

a. *Diameter propeller shaft end*: According to the regulations of recognized classification societies, for instance, according to GL, for materials (like propeller shaft's higher tensile steel) with a tensile strength 700 N/mm² the following is concluded:

$$d_s(\text{m}) = 11.5(P_D/n_p)^{1/3}$$

where

P_D (kilowatt): delivered power at the propeller
 n_p (RPM): propeller revolutions per minute

b. *Weight/length of shaft*:

$$W_{SH} / l_{SH} \approx 0.081(P_D / n_p)^{2/3}$$

where

l_{SH} : length of shaft

- I4. Propeller (s)

The weight of ordinary manganese bronze propellers may be estimated by:

$$W_{PR} = K_p D_p^3 (t)$$

where

D_p (meter): diameter of propeller

$$K_p \cong \frac{d_s}{D_p} \left(1.85 \frac{A_E}{A_O} - \frac{z-2}{10} \right)$$

This holds for fixed-pitch propellers with z blades and areas (A_E/A_O) (according to Schneekluth 1985) and

$$K_p = 0.12 - 0.14, \text{controllable-pitch CP propellers (merchant ships)}$$

$$0.21 - 0.25, \text{controllable-pitch CP propellers (naval ships).}$$

Alternatively, according to E. Strohbush (1971), for fixed-pitch propellers:

$$W_{PR} = D_p^2 \cdot d_s (A_E/A_O + 0.2) \cdot K_p'(t)$$

where $K_p' = 1.2 - 1.3$ for manganese bronze propellers

II. Electric generator units (Schreiber, Journal Hansa 1977, p. 2117)

The approximation of the weight of the electric generator units (*gen-sets*) can only be done if we know the required electrical energy and the units' total power.

The electrical energy balance of a ship, which leads to the estimation of the required powering supply for electricity, must be done for the following operating conditions of the ship:

1. Sailing at design speed, en route
2. Course on alert/maneuvering, limited waters
3. Loading and unloading with own means
4. Immobilization (docking)

Usually for a commercial cargo ship the condition (2) is the most crucial in terms of requirements for electricity power.

Based on the required electrical power/energy, where all losses as well as the extent of simultaneous use of the various energy consumers should be included, the required power of the electric generators can be estimated.

The weight of the electric generators installation is a function of the way electricity is being generated:

- (1) Connection of the electrical generator(s) through a gearbox to the propulsion machinery (*shaft generator*). This may cover parts of the electrical energy needs.
- (2) Diesel-engine powered generator set by use of medium-speed/high-speed diesel engines.

In the second case, the weight of the diesel engine/generator unit (gen-set) may be approximated by:

$$W_{EP}/P = 15 + P / 70 (\text{kp/kW})$$

where P (kilowatt): power of the individual generator set.

In case of (1) significantly smaller weights are concluded, because of the higher efficiency of the main diesel engines. However, this option requires the existence of controllable-pitch propellers so that the speed/revolutions of the propulsion engine driving the electrical generator can be kept constant, when slowing down the ship; on the other hand, for the standby/maneuvering/anchoring mode, when approaching to the port or in case of emergency, it must be switched to an independent electric generator unit (2), but to a limited extent.

III. Other weights

This category includes all the weights of the machinery installation that were not mentioned in I and II, that is, pumps, pipes, boilers, exhaust absorbers, cables, splitters, spare parts, ladders, gratings, day tanks, gas containers, condensers, separators, oil coolers, water cooling system, engine room control system, noise, and thermal insulation of the engine room.

$$\text{Typical values: } W_{III} / P_B = 40 - 70 (\text{kp/kW})$$

where the lower limit applies to large installations of over 10,000 kW, as a function of the engine room volume.

IV. Specific weights (only for certain ship types)

- a. *Tankers*
 - Cargo pumps and pipes
 - Steam generating boilers (heating of cargo, tank cleaning) 120–180 kp/kW
- b. *Reefers*
 - Cooling system (without air ducts): weight per net refrigerated volume (Net–Net) 14 kp/m³
- c. *Refrigerated cargo containerships*
 - Refrigeration facilities: indirect cooling 1 t/FEU container; direct cooling 0.7 t/FEU container

- Ducts of chilled air: indirect cooling 0.8 t/FEU container; direct cooling 1.3 t/FEU container

Additionally the weight of the thermal insulation of reefer cargo is mentioned, though it belongs to the W_{OT} group.

- 50–60 kp/m³ volume net–net (refrigerated cargo)
- 1.9 t/FEU container (bananas; containership)
- 1.8 t/FEU container (meat; containership)

2.15.7 Analysis of Deadweight DWT

In the case of cargo ships, the owner usually predefines/specifies the total deadweight DWT, rarely the payload weight W_{LO} . However, independently of the knowledge of the total value of DWT in the initial design phase, this DWT value must be broken down into its components and be carefully analyzed. This enables a better estimation of the mass centers of the various DWT components and of the influence of individual weight elements, which constitute the DWT, on the arrangement of spaces of the vessel (e.g., tank spaces for fuel, ballast, etc.) and on the overall ship design and performance.

It is estimated that the deadweight of a ship *decreases* with the increase of the ship's age, namely by approximately 5‰ in the first year and by 0.5‰ over the next years, *due to the increase* of the light-ship weight W_L . Typical reasons for the increase of W_L are: paintworks, corrosion of plates, added spare and reserve equipment, and waste and residues of liquids, especially in the bilges and other waste tanks.

DWT has already been defined in Sect. 2.4.1 as follows:

$$DWT = W_{LO} + W_F + W_{PR} + W_P + W_{CR} + B$$

Payload

The payload may be defined as the difference:

$$W_{LO} = DWT - (W_F + W_{PR} + W_P + W_{CR} + B)$$

where the individual weights W_F , W_{PR} , W_P , W_{CR} , and B are calculated in the following:

Weight of fuels W_F (includes also the weight of lubricants)

The required fuel is calculated for a round trip from/to the departure/replenishment port (without refueling), unless the owner specifies this differently. The required fuel can be approximated by the following formula:

$$W_{F1} = (P_{B,1} \cdot b_1 \cdot t_1 + P_{B,2} \cdot b_2 \cdot t_2 / \eta_E) \cdot C \cdot 10^{-6}$$

where

- W_{F1} : weight of fuel (tonnes)
 $P_{B,1}$: required power of main engine (depending on speed and operating conditions) (kilowatt)
 $P_{B,2}$: average required power of electrical generators (kilowatt)
 t_1 : time of a roundtrip voyage (hours) based on the service speed and operating range = range(sm)/service speed(knots)
 t_2 : operating time of electric generators (hours) = t_1 + time at port
 b_1 : specific consumption of the main engine (gram per kilowatt-hour)
 b_2 : specific consumption of auxiliary engines for electric generators (gram per kilowatt-hour)
 η_E : average efficiency of electric generator units
 Margin reserve: $C \equiv 1.2-1.4$

The constant C refers to the reserve for overconsumption due to change of course, unpredictable waiting, assistance to other ships in case of emergency, and residues in the tanks (2–4%).

It is assumed that the influence of the sea state, winds, and hull fouling on fuel consumption has been already accounted for during the estimation of the *service speed* and the corresponding required propulsion power.

The specific weight of fuel and lubricant oils varies significantly, depending on their quality and use.

On average we have:

| | |
|---|----------------------------|
| Marine diesel oil (<i>MDO</i> fuel) | 0.85 t/m ³ |
| Heavy fuel oil for slow-speed diesel engines and boilers (<i>HFO</i> fuel) | 0.92–1.02 t/m ³ |
| Lubricant oil | 0.928 t/m ³ |

For cargo ships it may be considered, as to the consumption of auxiliary engines, that this corresponds to 5–7% of the required fuel for the propulsion engine.

In addition to the above consumptions, the corresponding values for heating must be added, if it was not included in the consumption of the auxiliary machines (central heating) or the heating is provided by exploitation of the engine's exhaust gas' high temperature. Likewise, for tankers the production of steam for cleaning/heating of the cargo tanks should be added.

The specific consumptions for different types of main engine installations are shown in Fig. 2.92, as a function of the type of main engine's type (diesel of slow- and medium-speed, steam turbine, and gas turbine) and its loading rate. It is

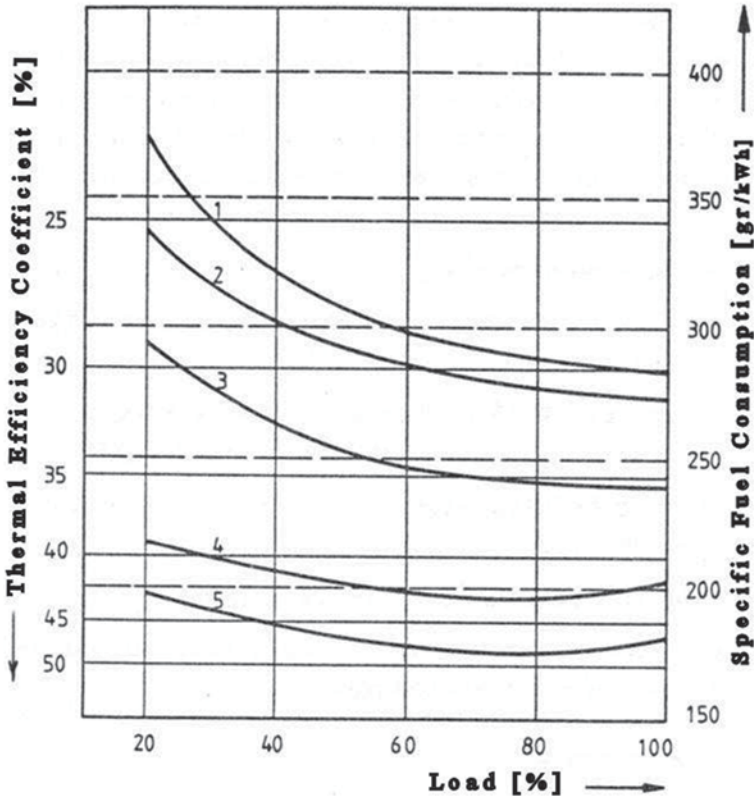

Fig. 2.92 Specific fuel consumption and thermal efficiency coefficient of marine engines. 1 gas turbine, 2 steam turbine 12 MW, 3 steam turbine 30 MW, 4 medium-speed diesel engine, 5 slow-speed diesel engine

evident that for diesel engines the minimum specific consumption corresponds to approximately 85% of the MCR of the installed power, while for turbo engines the minimum consumption corresponds to 100% loading. Nevertheless, regardless of manufacturer, the specific consumption is absolutely minimal for low-speed diesels (~170 g/kWh; today down to about 155 g/kWh), followed by medium-speed diesels (~190 g/kWh; today down to 175 g/kWh), the steam turbines (290~330 g/kWh, today down to 250 g/kWh, depending on the power magnitude, the loading, the type and manufacturer) and finally, the gas turbines (300~350 g/kWh, today down to 270 g/kWh). It should be noted that beyond the specific fuel oil consumption (SFOC), of interest for the *cost of fuel*²⁶ is the *type* of fuel consumed, with heavy fuel oil (HFO for low-speed diesel engines and steam turbine boilers) being the least expensive per ton fuel, followed by marine diesel oil (MDO, for medium- and

²⁶ Indicative Fuel Oil Prices (June 2014): Heave Fuel Oil (IFO380) Singapore: 617.50 USD/ton, Rotterdam: 602.50 USD/ton, Houston: 612 USD/ton, Marine Diesel Oil (MDO): 915.50 USD/ton.

high-speed turning diesel engines). Modern marine gas turbines can run a wide variety of fuels.

Weight of lubricants W_{F2}

This concerns the weight of lubrication oil. The consumption is:

Diesel engines: 0.15 gr/kWh circulation lubricant
0.6–1.4 gr/kWh cylinder lubricant

(note that medium-speed diesel engines without crosshead require cylinder lubricants *also* for the circulatory system).

Turbines and gearboxes:
0.1–0.2 g/kWh

The weight of the lubricants corresponds approximately to 3–5% of the fuel weight (diesel engines) and is usually in the order of 20 t for medium-speed and 15 t for low-speed diesel engines. When carrying out an accurate calculation for the size of the related tanks for lubricants, based on the kilowatt-hour, it is recommended to take into account the consumption for about 50 journeys.

Water supplies

We distinguish the following types and qualities of onboard water:

- fresh water, drinking, and cleaning water,
- feeder water for boilers and cooling network,
- seawater for sanitary tanks, if fresh water is not used,
- ballast water

Typical values

Freshwater:

Drinking: 10–20 kg/person/day

Cleaning: 120 kg/person/day, if the accommodation has showers, 200 kg/person/day, for accommodation with bath tubs.

Feeder for the boilers: 0.1 kg/kWh plus the liquid for filling the network.

The water supplies of a ship are usually not sufficient for the entire duration of a voyage. The needs are partly covered through the refilling at intermediate ports or through the production of fresh water with onboard seawater desalination plants.

Contemporary desalination equipment aboard ships allows freshwater production from seawater using either a *thermal* or a *membrane type (reverse osmosis)* desalination process. In the thermal distillation process the seawater evaporates and the vapor condenses thereafter producing clean freshwater. More efficiently, evaporation is conducted at low pressure so that the heat of the engine's cooling water can be used for the heating process. Particularly, evaporation of seawater at 40°C occurs at 93% vacuum. Thus, the cooling water of the main engine (with exit

temperature of about 32 °C) requires a little reheating by about 8 °C to be used for the desalination process. It is estimated that with 1 kg oil for the additional heating, it is possible to produce this way 100 kg of freshwater (Schneekluth 1985). Nowadays, multistage evaporators are commonly used aboard passenger ships, with increased needs for fresh water, whereas *tube bundle evaporators* are prevailing aboard cargo ships. (see Meier-Peter and Bernhardt 2009).

As for the drinking water, the requirements in terms of quality are nowadays enhanced so that the refilling from ports with adequate sanitary conditions is preferred.

Note that for a standard *cargo ship* the amount of carried fresh water is in the range of 80–100 t; however, the needs of *passenger ships*, particularly of cruise ships, are much higher. Depending on the size and type of ship, desalination plants of production capacity between 5 and up to 100 t water per day are installed onboard modern ships, with the large passenger ships standing on the top of consumers.

Weight of supplies—food

The weight of supplies/food is estimated by roughly: 7–16 kg/man/day. This weight concerns not only daily consumption, but also the reserve for delays of voyage, deterioration of food, and delays of supply.

Weight of passengers and luggage

Passengers: 75 kg/passenger

Luggage: 20 kg/passenger, for short trips 60 kg/passenger, for long voyages; holds also for crew members.

Weight of ballast water

It should be considered that for a well-designed cargo ship, in the design load condition²⁷, ballast water should not be necessary. The carriage of ballast water negatively affects the ship's economy both with respect to the additional carried weight (at the expense of not carried payload), the associated fuel cost and the cost of ballast water treatment (see, IMO Res. MEPC. 173(58), 2008b).

Typical reasons that lead a designer to the planning of ballast are:

- insufficient stability, especially after the consumption of fuel/supplies (end of voyage)
- balancing of trim, especially for ships with the engine room abaft
- to increase the draft at bow/stern and avoid slamming and propeller racing phenomena

²⁷ Exceptions to the rule are the containerhips, especially when in the full load/design condition they are expected to carry many containers on deck (causing a high center of ship's mass). This leads to a significant amount of ballast in the full load/design condition, to ensure adequate GM; consequently, for a given DWT, the overall payload capacity decreases. Recent containerhip design developments and ship design optimizations/innovations, however, look for minimum ballast (*zero ballast ships*).

- to smoothen the longitudinal stresses due to uneven cargo hold loading (e.g. ore carriers, containerships)
- to avoid kipping and dumping during ship launching

In addition, the international regulations of MARPOL specify for tankers over 20,000 t DWT that the trim is limited, namely $\delta T < 0.015 L_{pp}$ for the ballast condition.

The distribution of adequate ballast tank space along the ship and the provision of sufficient amount of ballast water results from the requirements of the extreme ballast condition.

If we assume that in ballast condition it is required that we have:

- abaft: full immersion of propeller
- forward: $T \geq 0.02 L_{pp}$

then it is concluded for the ballast water weight:

$$W_B = \Delta_B - (DWT_R + W_L)$$

where

- W_B : ballast water weight
- Δ_B : displacement in ballast condition
- DWT_R : sum of rest fuel, rest payload, remaining supplies and weight of crew with luggage
- W_L : light ship weight

The desired average draft in ballast condition is:

$$T_B = (D_p + e + 0.02L) / 2$$

where

- D_p : propeller diameter
- e : distance of lower extremity of the propeller blades from the base.

The displacement in ballast condition is:

$$\Delta_B = w_{sw} \cdot L \cdot B \cdot T_B \cdot C_{BB}$$

where

- w_{sw} : specific weight of seawater
- C_{BB} : block coefficient in ballast condition = $C_B - C \left[\frac{(T - T_b)}{T} \right] \cdot (1 - C_B)$

where

- C_B : block coefficient for design draft

T : design draft
 C : constant ~ 0.4 .

Thus, the minimum amount of carried ballast in the ballast load condition is this way estimated and helps the designer to plan for sufficient tank space and arrangements of ballast tanks.

Permanent ballast

Permanent ballast is required for certain types of ships, for example, sailing boats, and often for *converted ships*²⁸, with stability problems. This ballast weight is generally not included in the DWT, but in the weight of the steel structure (eventually the ship's light-ship weight). Marine concrete is often used as permanent ballast material because of its low cost. It is mainly placed on the ceiling of the double bottom; a specific marine concrete ballast weight of about 4 t/m^3 can be achieved, whereas with the use of heavy BaSO_4 (barium sulfate oxide) the specific weight can reach values of 4.6 t/m^3 . In some converted RoPax ships, permanent ballast can also be carried in the form of sea water, which is placed in *permanent ballast tanks*; the latter are "sealed" by the authorities to avoid stability problems by improper use during operation.

2.16 Verification of Displacement

Based on the approximations of the individual weight components of the ship (Sect. 2.15) and given her deadweight DWT (for ordinary cargo ships), the total weight of the ship under consideration is expressed as:

$$\Delta = W_L + DWT$$

where

W_L : light-ship weight

$$W_L = W_{ST} + W_{OT} + W_M + R$$

W_{ST} : weight of steel structure

W_{OT} : weight of outfitting

²⁸ In the past and in many countries around the world, it was popular to convert cargo ships (mainly general cargo type of ships) into passenger ships (mainly RoPax ships) by keeping the main hull unchanged. Trivially, with the added high superstructures typical to passenger ships, the stability of these ships could only be kept within regulatory margins by adding permanent ballast. In many cases this was accompanied by more severe design measures, like the fitting of streamlined "sponsons" on the ship's hull, increasing the ship's breadth and form stability. The latter design measure was also applied independently of the carried permanent ballast.

W_M : weight of machinery and propulsion plant
 R : margin—tolerance

and

$$DWT: DWT = W_{LO} + W_F + W_{PR} + W_P + W_{CR} + B$$

W_{LO} : payload weight

W_F : fuel/lubricant weight

W_{PR} : weight of provisions and water

W_P : weight of passengers and their baggage

W_{CR} : weight of crew and their baggage

B : weight of *nonpermanent ballast* (water), for a specified draught and satisfactory stability and trim.

The comparison of the sum of the weight components, namely Δ , with the weight of water displaced by the vessel's hull shows to what extent the approximations of the weight components are in line with the designed hull.

$$\Delta = w_{SW} \cdot \nabla'$$

where

w_{SW} : specific weight of sea water
 $\cong 1.025 \text{ t/m}^3$ (mean value)

Δ' : corrected moulded hull volume
 $= C_B \cdot L_{PP} \cdot B \cdot T \cdot K$

K : *moulded hull correction coefficient*, accounting for an average thickness of the ship's outer shell plating
 $= 1.0035$ for tankers
 $= 1.005$ for cargo ships
 $= 1.006$ for shortsea cargo ships
 $= 1.007$ for containerships

If the difference between Δ (the ship's weight) and $W_{SW} \cdot \nabla'$ (weight of displaced water) is within the margin R of W_L , the design can proceed to the next phase. Otherwise, if the Δ weight exceeds the displacement more than the R , the hull must be modified accordingly to balance the difference. The margin of tolerance of R varies (see Sect. 2.15.1) between 1~3% W_L , in the preliminary design phase, while according to other sources (Schneekluth) it could reach 6% W_L (for more complicated ships).

2.17 Verification of Holds' Capacity

2.17.1 Definitions

a. *Gross volume* (German: Bruttoladeraum) V_G : Corresponds to the holds' volume bounded by the *outer edge* of the holds' frames, of the deck beams or the *inside*

Fig. 2.93 Holds' volume for bulk (grain) and bale cargo
 $\nabla_{GR} \approx (0.990 \div 0.995) \nabla_G$
 $\nabla_B \approx (0.90 \div 0.93) \nabla_{GR}$

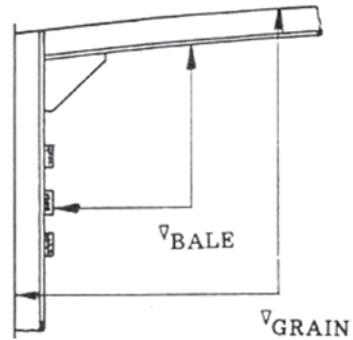

edge of the shell plating, of double bottom, of bulkheads and of the ceiling deck; it includes the volume occupied by the frames and strengthenings or other structural fittings that is not deducted²⁹

Dimension units: (m³) or (ft³), 1 m³ = 35.32 ft³

Symbol/relationships: $\nabla_G \approx \nabla_S$ (∇_S : molded hold volume as calculated by integration of sectional areas)

- b. *Grain volume* (German: Kornladerraum) ∇_{GR} : Corresponds to the volume that grain (or liquid) cargo occupies when filling the hold, that is, it is equal to the gross volume defined in (a) subtracting the volume of strengthenings and other fittings (e.g. holds' planking)(see Fig.2.93).
- c. *Bale volume* (German: Stückgutvolumen) ∇_B : Corresponds to the holds' volume that is bounded by the *inside edge* of the plating of the double bottom or its planking, the inside edge of the deck beams, the inside edge of the side strengthenings of the hold or section and finally the inside edge of the side planking or the bulkheads' strengthenings.

Units: (cubic meter) or (cubic feet)

Symbol/relationships: $\nabla_B \approx (0.90 \div 0.93) \nabla_{GR}$ (lower limit: for sharp/slender ships)

- d. *Net hold volume (reefer ships)* (German Netto-Volumen) ∇_N : It refers to the holds' volume for *refrigerated* cargo and is bounded by the inside edge of the insulation planking of the hold space.

Units: (cubic feet) or (cubic meter)

Symbol: ∇_N

²⁹ This volume corresponds to the holds' volume resulting from the ship capacity curves, thus by integration of the areas of the sections belonging to and bounding the respective hold (see Sect. 2.17.2).

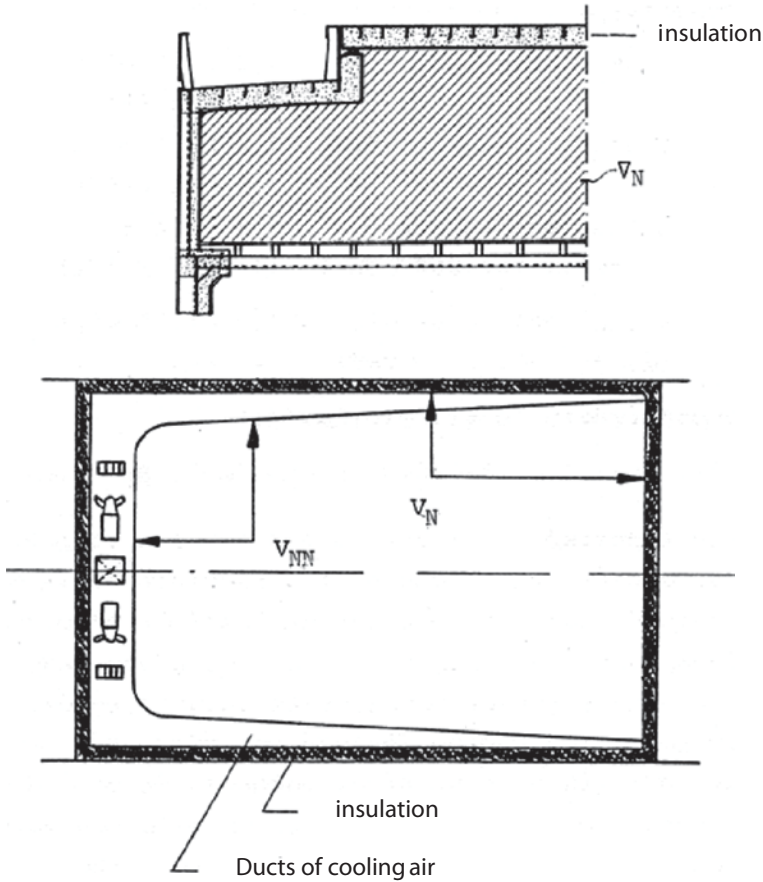

Fig. 2.94 Holds' net volumes for refrigerated cargo

- e. *Net-net volume (reefer ships)* (German: Netto-Netto-Volumen) ∇_{NN} : It corresponds to the net volume defined in (d) subtracting the volume occupied by the refrigeration facilities (e.g., ducts of cooling air, coolers, etc.) (see Fig. 2.94).

Units: (cubic feet) or (cubic meter)

Symbol/relationships: $\nabla_{NN} \cong (0.60-0.63) \nabla_S$ (horizontal ventilation)
 $\cong (0.65-0.69) \nabla_S$ (vertical ventilation)

- f. *Capacity coefficient* (German: Räume) and *stowage factor*: The capacity coefficient is defined as the ratio of the holds' volume (usually bulk-grain volume) to the deadweight of the ship

$$R = \nabla_{GR} / DWT.$$

The *capacity coefficient* is an *attribute of the ship*. Instead, the **stowage factor** (*SF*), which corresponds to the required hold volume per ton of cargo, is an *attribute of the cargo*.

Units: (cubic meter per ton) or (cubic feet per ton)

Examples (Capacity factor)

| | |
|--|--|
| General cargo ship | 1.6–2.0 m ³ /t (55–72 ft ³ /t) |
| Small–medium tanker (< 100,000 t DWT) | 1.3–1.4 m ³ /t (45–49 ft ³ /t) |
| Large tanker (> 100,000 t DWT) | 1.2–1.25 m ³ /t (43–44 ft ³ /t) |

Examples (SF)

Light cargoes SF ≥ 2.0 m³/t

| | |
|-------------------------|-----------------------------|
| Citrus and other fruits | 2.0–2.5 m ³ /t |
| Cotton goods | 2.2–2.8 m ³ /t |
| Coking coal | 1.95–2.78 m ³ /t |
| Tobacco | 3.00–5.00 m ³ /t |
| Bananas (in boxes) | 3.25 m ³ /t |

Semiheavy cargoes 1.25 ≤ SF ≤ 2.0 m³/t

| | |
|------------------|-----------------------------|
| Grains | 1.2–1.8 m ³ /t |
| Sugar (in sacks) | 1.29–1.34 m ³ /t |
| Coal | 1.18–1.33 m ³ /t |
| Coffee | 1.61–1.75 m ³ /t |
| Wines | 1.39–1.53 m ³ /t |

Heavy cargoes SF ≤ 1.25 m³/t

| | |
|-------------------|-----------------------------|
| Cements | 0.64–0.78 m ³ /t |
| Ores | 0.34–0.50 m ³ /t |
| Crude oil | 0.91–1.00 m ³ /t |
| Steel panels | 0.60 m ³ /t |
| Electrical cables | 0.85–1.12 m ³ /t |

g. *Gross tonnage* (German: Bruttoreaum): It is the result of application of relevant national and international *tonnage measurement regulations* and forms an important information element regarding the *size (total enclosed volume)* of the measured ship. This value corresponds to the enclosed volume of all closed spaces of the ship (that is, not only of the holds), without this correspondence to be mathematically conclusive, due to the *exclusions* of certain spaces (e.g., fore/aft peak tanks, ballast tanks, wheelhouse, galleys, and public areas). The gross

tonnage forms in general a reference baseline for determining the number and composition of the crew, the implementation of safety regulations, for determining the ship's classing fees, as well as other costs (taxes, insurance, transit fees of canals, etc.).

Units: GRT (gross register tons) or GT (gross tonnage), 1RT = 100 ft³ = 2.832 m³

h. *Net tonnage* (German: *Nettoraum*): Like the gross tonnage defined in (g), the *net tonnage* is the result of application of relevant *tonnage measurement regulations* and is a representative quantity for the “*economic value*” (commercial exploitability) of the ship. The net tonnage is calculated from the gross tonnage, which is reduced by some “*deductible*” spaces that are not exploitable for cargo transport (e.g., the machinery space, spaces of pump rooms/auxiliary machinery, and crew accommodation). *The net capacity cannot be smaller than 30% of the gross tonnage.* The magnitude of the net tonnage/capacity is used, like that of the gross tonnage, to calculate various fees, for instance, port charges, etc.

Units: NRT (net register tons) or net tonnage (NT)

The international regulations of tonnage measurement of ships (International Tonnage Measurements of Ships) may be found on IMO's website (<http://www.imo.org/Conventions>); they apply to all ships longer than 24 m and built after 18 July 1982. In accordance with these regulations, the following relationships between the ship's tonnage and the ship's main characteristics apply:

Gross Tonnage (GT)

$$GT = (0.2 + 0.02 \log_{10} V)V$$

where V is the volume of all the enclosed spaces of the ship.

Net Tonnage (NT)

$$NT = K_2 V_c \left(\frac{4d}{3D} \right)^2 + K_3 \left(N_1 + \frac{N_2}{10} \right)$$

where

(a) The coefficient $\left(\frac{4d}{3D} \right)^2$ should not be larger than 1.0.

(b) The coefficient $K_2 V_c \left(\frac{4d}{3D} \right)^2$ must not be smaller than 0.25 GT.

(c) The net tonnage NT must be greater than 0.30 GT.

V_c = total volume of holds' space (cubic meter)

K_2 = $0.2 + 0.02 \log_{10} V_c$

$$K_3 = 1.25 \frac{GT + 1000}{1000}$$

d = draught³⁰ at amidships

D = side depth to the uppermost deck at amidships

N_1 = number of passengers in cabins with more than eight passengers

N_2 = number of the remaining passengers

$N_1 + N_2$ = total number of passengers that the ship can carry in accordance with her safety certificate. For passenger numbers $N_1 + N_2$ less than 13, thus in case of cargo ships, then the N_1 and N_2 are set to zero.

It is obvious, that the “physical capacities of the holds” defined by the volumes (a) ∇_G , (b) ∇_{GR} and (c) ∇_B have nothing to do with the *tonnage capacities* determined in accordance with the tonnage regulations defined in (g) and (h).

Beware of *nonscientific* literatures/references:

Ship *capacity* or *tonnage* of 1 t usually means:

- tankers, bulkcarriers: t DWT
- ROPAX/cruise ships: GRT
- general cargo ships: t DWT, rarely GRT
- warships: tons Δ (displacement).

2.17.2 Calculation of Hold Volume

A. Volumetric/capacity curves

Provided that there is at least a preliminary shiplines plan (or sketch) of the subject ship, then the calculation of the hold volume and the volumetric distribution of spaces can be derived through the “volumetric/capacity curves.”

The *volumetric/capacity curves plan* (German: Raumkurvenblatt), are drawn with the same ordinates as the corresponding curves of sectional area lengthwise for the various draughts concerned, but herein at the level of double bottom, of intermediate deck positions and of the uppermost deck (see Fig. 2.95).

In the *volumetric/capacity curves plan*, which resembles the sectional area curves plan, the boundaries of the various hold spaces are also sketched, for example, the deck and bulkhead boundaries; furthermore, there is information about the usability of the spaces and the corresponding exploitable volume (see example).

The areas below the volumetric/capacity curves correspond to the volume of the indicated spaces; volume numbers can be easily obtained by integration of the areas using Simpson's rule or a mechanical *planimeter* (in old times). The concept of capacity curves can be successfully used both in the initial design, and in advanced stages, if the shiplines are available. The volumetric/capacity curves plan is also useful for a rapid assessment of the longitudinal position of the center of DWT

³⁰ Summer draught or subdivision draught (RoPax ships) amidships.

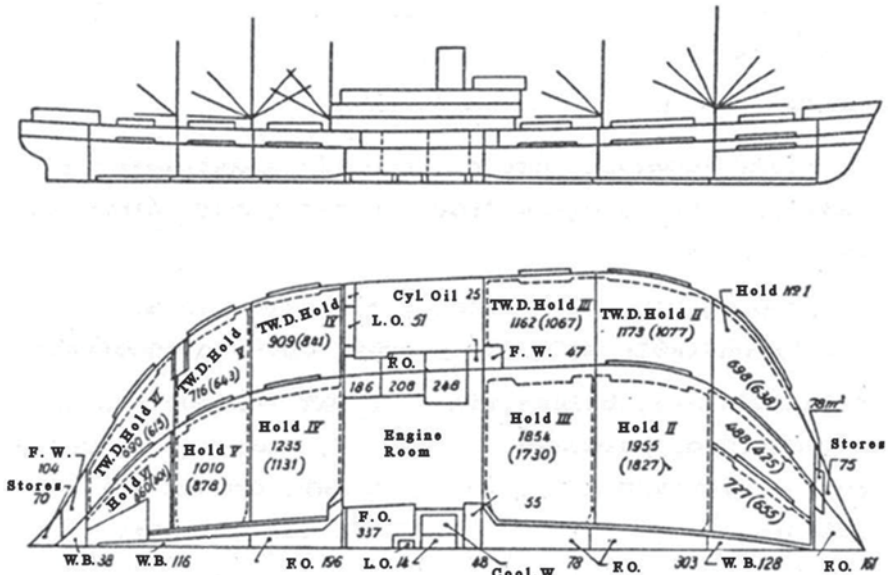

Fig. 2.95 Volumetric/capacity curves plan of a cargo ship. The dashed lines in the plan indicate the available space for bale cargo (V_{BALE}). The numbers (in cubic meter) show the available volume for bulk cargo (V_{GRAIN}), and in parentheses the volume of bale cargo (V_{BALE})

through a moment balance of the longitudinal moments of the various DWT weight components.

B. Below main deck volume (initial design phase)

The volume below the main deck forms the basis for the approximation of not only the hold volume, but also of the engine room spaces, of double bottom and of other tanks. Furthermore, it is a necessary element for calculating the ship's steel weight (see Sect. 2.15.4, B3).

If during the early design phase (feasibility), the preliminary shiplines (or hydrostatic diagrams) are not available, the following simplified procedures are proposed to approximate the volumes.

B.1. Cubic coefficient method

Provided that there are sufficient comparative data from one or more similar ships it is possible to define the cubic coefficient:

$$C_{Vc} = \frac{(V_c)_0}{L_0 \cdot B_0 \cdot D_0}$$

where

∇_C : comparable hold volume (grain or bale),
 L, B, D length, beam, and side depth,
 $()_0$: parent ship.

Thus, it is concluded for the subject ship's (index 1) hold volume:

$$(\nabla_C)_1 = C_{\nabla_C} \cdot L_1 \cdot B_1 \cdot D_1$$

If additionally a side view of the parent ship is available, from which it is possible to identify the *total length of the cargo hold spaces* L_{C0} , then the above coefficient is better defined with respect to this length, that is:

$$C'_{\nabla_C} = \frac{(\nabla_C)_0}{L_{C0} \cdot B_0 \cdot D_0}$$

and

$$(\nabla_C)_1 = C'_{\nabla_C} \cdot L_{C1} \cdot B_1 \cdot D_1$$

where

L_{C1} : total length of hold spaces of the subject, under design ship.

B.2. Method of circumscribed parallelepiped (mainly applies to cargo ships with engine abaft)

Gross hold volume

$$\nabla_G \cong L_C \cdot B (D_S - h_{db}) \cdot C_{BLC} + \nabla_H$$

where

∇_G : Gross hold volume defined in Sect. 2.17.1.a.,
 L_C : overall length of cargo hold spaces,
 B : beam of ship,
 D_S : raised/corrected side depth for sheer/camber of deck,

$$D_S \cong D + 0.08(S_F + S_A)$$

h_{db} : average height of double bottom (including possible planking)
 C_{BLC} : Local fullness coefficient of hold volume,

$$\begin{aligned} &\cong (C_B + 2) / 3 \text{ or} \\ &\cong (C_{BD} + 1.05) / 2 \end{aligned}$$

∇_H : volume of hatchways.

B.3. Approximation method of Schneekluth

The method refers to the total volume *below the main deck* and has been earlier applied in calculating the steel weight (see Sect. 2.15.4, B.3).

The basic formula for the total volume *below the main deck*, ∇_{UD} , is expressed as:

$$\nabla_{UD} = \nabla_D + \nabla_S + \nabla_B + \nabla_H$$

where

$$\nabla_D = L \cdot B \cdot D \cdot C_{BD} \text{ (volume up to the height of } D\text{)}$$

where

$$C_{BD} = C_B + C_4 \left[\frac{(D-T)}{T} \right] (1 - C_B)$$

and

$$\begin{aligned} C_4 &\cong 0.25 \text{ for hulls with small flare above waterline} \\ &\cong 0.40 \text{ for hulls with large flare above waterline} \end{aligned}$$

$\nabla_S = L \cdot B \cdot (S_F + S_A) / 6$ (volume between D and a deck line accounting for longitudinal sheer of the deck, as applicable);

alternatively,

$$\nabla_S = L_S \cdot B \cdot (S_F + S_A) \cdot C_2$$

where

$$C_2 \cong C_{BD}^{2/3} / 6 \cong 1/7$$

L_S : length of sheer

$\nabla_B = L \cdot B \cdot b \cdot C_3$ (volume due to a *beamwise* deck camber)

where

b : height of camber ($\cong 0.02 \cdot B$)

$$C_3 \cong 0.5 \div 0.6$$

∇_H : hatchways' volume $\cong L_H \cdot B_H \cdot h_H$

L_H : overall length of hatchways

B_H : overall width of hatchways

h_H : average height of hatchways' coamings.

Based on the volume below the main deck ∇_{UD} , the hold volume can be calculated as percentage of ∇_{UD} , namely:

$$\nabla_G \cong k \cdot \nabla_{UD}$$

where

$$k = 0.6 \div 0.77$$

The coefficient k must be verified based on data of similar ships.

B.4. Approximation method based on displacement

Again the total volume under the main deck ∇_{UD} is sought.

The requested volume ∇_{UD} is supposed to consist of two parts

$$\nabla_{UD} = \nabla + \nabla_{AW}$$

where

∇ : displaced volume at design waterline

∇_{AW} : hull volume *between design waterline and main deck*

The latter term is calculated as:

$$\nabla_{AW} = L \cdot B \cdot (D - T) \cdot (C_{WP} + C_{WPD}) / 2 + \nabla_S + \nabla_B$$

where

C_{WP} : waterplane area coefficient $\cong (1 + 2C_B)/3$ (for nonpronounced sections, see Sect. 2.9)

C_{WPD} : deck waterplane area coefficient ($\cong 1.0$)

∇_S : additional volume due to sheer profile (see B.3)

∇_B : additional volume due to hatchways (see B.3)

B.5. Method of Carstens (cargo ships, aft engine room, see Carstens 1964, Journal Schiff and Hafen, p. 619).

2.18 Verification of Stability and Trim

One of the most important steps in the preliminary ship design stage is the verification/control of the ship's stability (to a lesser degree of the ship's trim, except for special cases) for the ship under consideration.

In the initial design stage it is sufficient to examine the *intact*³¹ stability for small inclination angles (*initial stability*), what is essentially the control of the adequacy

³¹ *Intact* stability: the stability of the ship assuming her buoyant hull intact.

of the metacentric height \overline{GM} . The stability control is complemented in the next steps of the design by examining the ship's stability curves (*stability for large inclination angles*); the latter requires an accurate knowledge of the ship's hull geometry that is usually not available in the first stage of design. In later stages of ship design, the ship's *damage*³² stability also needs to be verified/examined against set damage stability criteria. Detailed reviews on the ship's stability, on calculation methods of the ship's stability and the in force stability criteria are given in the listed references Lewis (Vol. I, 1988), Papanikolaou (1982), Rawson and Tupper (1994). In section 2.18.8 of this book, the intact stability criteria of IMO are elaborated, whereas, in Appendix E a review of developments of the ship's damage stability criteria is presented.

At the stage of initial design, it is recommended to apply simplified formulas or diagrams/charts for the assessment of the ship's initial stability. As we know the metacentric height is derived as the difference between the ship's *form* and *weight* stability:

$$\overline{GM} = \overline{KM} - \overline{KG}$$

where the vertical position of the mass center of the vessel \overline{KG} may be considered as approximately known (see Sect. 2.15.2), while the vertical position of the (transverse) metacenter:

$$\overline{KM} = \overline{KB} + \overline{BM}$$

is calculated through the estimation of vertical position of the center of buoyancy \overline{KB} and vertical distance of metacenter from the initial center of buoyancy \overline{BM} (*transverse metacentric radius*). Both values, unless more accurate data of the hull are available, are usually approximated through semiempirical/mathematical formulas as a function of the already known main particulars and hull form coefficients of the ship, what is elaborated in the following.

2.18.1 Vertical Position of Buoyancy Center

Normand I:

$$\overline{KB} = T(0.9 - 0.36C_M)$$

Schneekluth:

$$\overline{KB} = T(0.9 - 0.3C_M - 0.1C_B)$$

³² *Damage stability*: the stability of the ship in case of loss of her watertight integrity (LOWI).

Normand II:

$$\overline{KB} = T(5/6 - C_B / 3C_{WP})$$

The accuracy of the above formulas for ordinary ship hulls is in the range of 1% of T (according to Schneekluth). The third expression (Normand II) requires the knowledge of the waterplane area coefficient C_{WP} , which is often not known in the initial phase, namely prior to fixing the character of the sections (U or V), thus may change easily.

2.18.2 Metacentric Radius

All known approximation formulas for the metacentric radius $\overline{BM} = I_T / \nabla$, are based on the appropriate approximation of the transverse moment of inertia I_T of the waterplane. The transverse moment of inertia can be easily deduced from the moment of inertia of the waterplane of the circumventing parallelogram, having the same length and beam like the ship's waterplane; thus, considering that transverse moment of inertia of the circumventing parallelogram is $L \cdot B^3 / 12$, we may correct it to account for the actual form of the waterplane, as expressed by the correction coefficient $C_1 = f(C_{WP})$. Thereby the following expression is concluded:

$$\overline{BM} = \frac{I_T}{\nabla} = C_1 \frac{L \cdot B^3 / 12}{L \cdot B \cdot T \cdot C_B} = C_1 \frac{B^2}{12 \cdot T \cdot C_B}$$

where the correction coefficient $C_1 = f(C_{WP})$ is calculated as follows:

Normand

$$C_1 = 0.096 + 0.89 \cdot C_{WP}^2$$

Schneekluth

$$C_1 = C_{WP}^{1.8}$$

Bauer

$$C_1 = 0.0372(2C_{WP} + 1)^3$$

Dudszus—Danckwardt

$$C_1 = 0.13C_{WP} + 0.87C_{WP}^2 \pm 0.005$$

Murray, for trapezoidal waterlines

$$C_1 = 0.5(3C_{WP} - 1).$$

All the above formulas were successfully implemented in practice; however, they do not directly apply to modern ship hull forms with wetted transom stern, thus some caution is necessary when using them..

2.18.3 Vertical Position of Metacenter

In the early design stages, because the waterplane area coefficient is not known, it is possible to approximate \overline{KM} using other known features of the ship. From the combination of relationships for \overline{KB} and \overline{BM} the following expression is derived:

$$\overline{KM} = B \cdot \left[C_1 \cdot C_2 \cdot \frac{B}{T} \cdot C_M^{-\frac{2}{3}} + \frac{0.9 - 0.3C_M - 0.1C_B}{B/T} \right]$$

where

C_1 : describes the waterplane area's lengthwise distribution and its sharpness near the shoulders of the ship
 $= 0.078$ for waterlines without parallel body
 $= 0.083$ for rectangular waterlines (barges)
 $= 0.078 + L_p/L_{pp} \cdot 0.005$ generally,

where

L_p : length of parallel body of the waterline, with
 $L_p/L_{pp} \cong 0.6 \div 0.7$ for $C_p = 0.8$
 $\cong 0.4 \div 0.5$ for $C_p = 0.7$
 $\cong 0.2 \div 0.3$ for $C_p = 0.6$
 $\cong 0 \div 0.1$ for $C_p = 0.5$

(approximation of L_p when other data are missing)

$$C_2 = (C_{WP} / (C_{WP})_{NORM})^a$$

where:

$$(C_{WP})_{NORM} = C_P^{2/3}$$

C_{WP} : given or equal to $(C_{WP})_{NORM}$
 $a = 1.5$ for $C_{WP} > (C_{WP})_{NORM}$
 $= 1.0$ for $C_{WP} \leq (C_{WP})_{NORM}$

The above standard (norm) waterplane area coefficient $(C_{WP})_{NORM}$ corresponds to nonintense sections of U and V types. However, since there are very pronounced V sections with large flare near the waterline for some ships (e.g., tugboats or modern containerships), it may be assumed that:

$$C_{WP} \cong (C_{WP})_{NORM} + 0.05.$$

In addition, for the application of the above formula for \overline{KM} , normal hull form and/or stern *without* intense, extended or wetted transom, is assumed.

Finally, it is assumed that the extent of the stern abaft of the aft perpendicular does not exceed 2.5% of the waterline length (maximum difference between L_{WL} and L_{PP}). If this limit is not observed, the used hull coefficients C_B and C_{WP} should be corrected as follows:

$$\begin{aligned} C'_B &= C_B \cdot L_{PP} / 0.975L_{WL} \\ C'_{WP} &= C_{WP} L_{PP} / 0.975L_{WL} \end{aligned}$$

2.18.4 Approximation of Stability at Large Inclination Angles

If during the initial design stage proves necessary to estimate the stability beyond the region of small inclination angles, the restoring arm may be approximated by:

$$\begin{aligned} h = GZ &= (0.5\overline{BM} \cdot \tan^2 \varphi + \overline{GM}) \cdot \sin \varphi \\ &\approx 0.5\overline{BM} \cdot \varphi^3 + \overline{GM} \varphi \quad (\text{for small angles } \varphi). \end{aligned}$$

The application of the above formula assumes for the hull of the ship:

- vertical sections (wall-sided) around the waterline
- nonimmersion of deck's edge and non-emergence of bottom's bilge extremes.

The formula is valid for angles of $\varphi \leq 10^\circ$ with good accuracy, even for nonvertical sections around the waterline. For larger angles various approximation methods can be used, but their accuracy is not proportional to the required effort for their implementation.

Nevertheless, two useful methods are listed below for further study. They are based on a systematic examination of the influence of the ship's hull form on the ship's stability:

- **Weberling**, Dr.-Ing. thesis, TH Aachen 1974, New Ships 1975.
- **H. E. Guldhammer** (1979).

The latter method is based on the well-known, systematic hull form series of FORMDATA, which is widely applied to the hull form design of various types of ships in the last decades.

Table 2.38 Conversion factors of hydrostatic data for geometrically similar ships

| Conversion factor $C(\alpha, \beta, \gamma)$ | |
|---|-----------------------------------|
| Waterplane area, A_{WL} | $\alpha \cdot \beta$ |
| Longitudinal position CF of waterline, LCF | A |
| Longitudinal moment of inertia, I_L | $\alpha^3 \cdot \beta$ |
| Transversal moment of inertia, I_T | $\alpha \cdot \beta^3$ |
| Sectional area, A_S | $\beta \cdot \gamma$ |
| Sectional area moment, M_S | $\beta \cdot \gamma^2$ |
| Displacement, ∇ | $\alpha \cdot \beta \cdot \gamma$ |
| Longitudinal position CB of buoyancy, \overline{LCB} | α |
| Vertical position CB of buoyancy, \overline{KB} | γ |
| Transversal metacentric radius, \overline{BM} | β^2 / γ |
| Longitudinal metacentric radius, \overline{BM}_L | α^2 / γ |
| Moment to change trim, MCT | $\alpha^2 \cdot \beta$ |
| Force to change displacement | |
| TPI (tons per inch change of draught) or TPC (tons per centimeter change of draught) | $\alpha \cdot \beta$ |
| Hull form coefficients, C_B, C_P, C_M, C_{WP} | 1 |

2.18.5 Using the Hydrostatic Data of Similar Ships

Provided that the hydrostatic data of a parent ship are known, for example, the *hydrostatic diagrams* of a ship similar to the one under design, namely, with the same hull form coefficients, similar sectional character, but different main dimensions (*homologous distortion*, see Chap. 4), then the following coefficients can be used to convert the hydrostatic data from the parent ship, subscript 0, to the under design ship, index 1. The method is valid approximately for ships without absolute correspondence in the sectional form, as long as the general character is maintained (Table 2.38).

$$\begin{aligned}
 \text{Longitudinal scale:} & \quad \alpha = L_1 / L_0 \\
 \text{Transversal scale:} & \quad \beta = B_1 / B_0 \\
 \text{Vertical scale:} & \quad \gamma = T_1 / T_0 \\
 \text{General conversion formula:} & \quad ()_1 = ()_0 \cdot C(\alpha, \beta, \gamma).
 \end{aligned}$$

2.18.6 Effect of Changing the Main Dimensions

During the initial phase of design, the qualitative knowledge of the effect of possible changes of the main particulars on the initial stability, namely, on \overline{GM} , is particularly useful.

Assuming that the displacement and the coefficients C_B and C_{WP} do not change, so are the ratios:

$$\frac{\overline{KB} / T, \overline{KG} / D_{\kappa\alpha} \overline{BM} / (\overline{BM})_{\text{NORM}}}{\overline{KB} / T, \overline{KG} / D \text{ and } \overline{BM} / (\overline{BM})_{\text{NORM}}}$$

where $(\overline{BM})_{\text{NORM}} = B^2/12 \cdot T C_B'$, then the following useful expressions according to Munro-Smith (Henschke 1964) are concluded:

$$\frac{\delta(\overline{GM})}{\overline{GM}} = \frac{\overline{KB}}{\overline{GM}} \cdot \frac{\delta T}{T} + 2 \left(1 + \frac{\overline{BM}}{\overline{GM}} \right) \cdot \frac{\delta B}{B} - \frac{\overline{BM}}{\overline{GM}} \cdot \frac{\delta T}{T} - \frac{\overline{KG}}{\overline{GM}} \cdot \frac{\delta T}{T}$$

Thus, if we set additionally the draft fixed ($\delta T=0$), as well as the side depth D ($\delta D=0$), we obtain:

$$100 \frac{\delta B}{B} = 100 \frac{\delta \overline{GM}}{\overline{GM}} \cdot \frac{1}{2(1 + \overline{BG} / \overline{GM})} [\%]$$

whereas for constant beam ($\delta B=0$) and $\delta T/T = \delta D/D$ we have:

$$-100 \frac{\delta T}{T} = 100 \frac{\delta \overline{GM}}{\overline{GM}} \cdot \frac{1}{1 + 2\overline{BG} / \overline{GM}} (\%)$$

For the above relationships it has been assumed that the C_B coefficient remains constant. Therefore, as the T or B change, it is assumed that the length changes inversely proportional so as the displacement and C_B to remain fixed.

Now, in case we assume:

$$\nabla, L, C_B, \text{ and } C_{WP} \text{ fixed,}$$

and

$$\delta B / B = -\delta T / T = -\delta D / D$$

the following is concluded

$$100 \frac{\delta B}{B} = -100 \frac{\delta T}{T} = 100 \frac{\delta \overline{GM}}{\overline{GM}} \cdot \frac{1}{3 + 4\overline{BG} / \overline{GM}} (\%)$$

In case of

$$\nabla, L, C_B, C_{WP}, \text{ and } D \text{ fixed,}$$

but

$$\delta B / B = -\delta T / T$$

it shows:

$$100 \frac{\delta B}{B} = -100 \frac{\delta T}{T} = 100 \frac{\delta \overline{GM}}{\overline{GM}} \cdot \frac{1}{3 + 4\overline{BG} / \overline{GM} - \overline{KG} / \overline{GM}} (\%)$$

Finally, for

$$\nabla, L, T, D, \text{ and } C_{wp} \text{ fixed}$$

as well as

$$\delta B / B = -\delta C_B / C_B$$

the following is concluded:

$$100 \frac{\delta B}{B} = 100 \cdot \delta \overline{KM} / \left(\frac{\nabla}{3A_{WL}} + 3\overline{BM} \right) (\%)$$

2.18.7 Typical Values of Metacentric Height

In the context of verification/examination of the *initial stability* during the conceptual/preliminary design stage of a ship, it is usually sufficient to compare the resultant GM value with some typical values of similar types of ships, as shown in Table 2.39.

High \overline{GM} values ensure satisfactory stability and safety for the ship against capsize only if they are accompanied by a sufficient range of positive restoring arm curve for large inclination angles; it should be noted, however, that large \overline{GM}

Table 2.39 Typical \overline{GM} values for modern ships in the departure, full load condition

| | |
|----------------------------------|------------|
| General cargo ships | >0.4–0.9 m |
| Containerships | >0.3–0.6 m |
| Short-sea cargo ships | >0.4–1.0 m |
| Tankers | 1.0–6.0 m |
| Bulk carriers | 0.6–2.0 m |
| Reefer ships | 0.7–1.1 m |
| Tug boats | 0.8–1.3 m |
| Fishing vessels | 0.7–1.2 m |
| Passenger ships (oceangoing) | 1.0–2.5 m |
| Passenger ships (limited waters) | 0.5–1.5 m |
| Passenger CATAMARAN ships | >10 m |
| SWATH type Passenger ships | 1.5–2.5 m |



Fig. 2.96 Shift of deck containers due to excessive transverse accelerations

values trigger intense *roll motions* and *transverse accelerations* on the ship’s deck (and higher positions), in view of the relationship:

$$T_{\text{Roll}} \propto B / \sqrt{GM}$$

where T_{Roll} : natural roll period of the ship.

For large values of \overline{GM} , that is, small roll period T_{ϕ} , the resultant transverse acceleration³³ on the ship’s deck (and higher positions) in *resonance* situation (i.e., for wave excitation period close to the ship’s natural roll period), becomes particularly pronounced resulting in nausea or injuries of passengers and crew, the shift or damage of higher up stacked cargo (e.g., deck containers, Fig. 2.96, shift of vehicles onboard Ro-Ro ships, etc).

In conclusion, it is recommended that the \overline{GM} values should not be unreasonably high, but certainly, in any case, regardless of the type and size of the ship, not to be less than about 0.30–0.35 m in departure and design loading condition.

³³ The transverse acceleration at certain position of a rolling ship is proportional to the distance of the reference point from the ship’s rolling axis (which is assumed passing near the ship’s mass center), and is inversely proportional to the *square* of T_{ϕ} (or directly proportional to square of the circular roll frequency $\omega_{\phi} = 2\pi/T_{\phi}$). Obviously, the transverse acceleration increases with larger distances from ship’s roll axis and lower values of T_{ϕ} .

2.18.8 *Verification of Stability*

The verification of a satisfactory status ship's stability refers to the sufficiency of the ship's stability (and floatability) in intact and damage condition with respect to the requirements of specified stability criteria, as laid down in regulations developed and approved by the International Maritime Organisation (IMO). We will be limiting in the following our deliberations to the intact stability criteria, as necessary in the frame of the ship's preliminary design, and refer to Appendix E with respect to the evolution of the criteria for the ship in damage condition.

IMO's Maritime Safety Committee adopted in its 85th session the presently valid International Code on Intact Stability, 2008 (2008 Intact Stability Code, IMO 2008c), taking into account technical developments to update the 1993 Intact Stability Code (resolution A.749(18)) and later amendments thereto (resolution MSC.75(69)). The 2008 IS Code provides, in a single document, both mandatory requirements and recommended operational provisions relating to intact stability, like general precautions against capsizing (criteria regarding metacentric height (GM) and righting lever (GZ)); weather criterion (severe wind and rolling criterion); effect of free surfaces and icing; and watertight integrity.

The IS2008 Code contains intact stability criteria for the following types of ships and other marine vehicles of 24 m in length and above, unless otherwise stated:

1. cargo ships;
2. cargo ships carrying timber deck cargoes;
3. passenger ships;
4. fishing vessels;
5. special purpose ships;
6. offshore supply vessels;
7. mobile offshore drilling units;
8. pontoons; and
9. cargo ships carrying containers on deck and containerships.

The below *general criteria* regarding the properties of the righting arm curve in intact condition apply to all ships, except for stated otherwise:

- a. The area under the righting lever curve (GZ curve) shall not be less than 0.055 m-radians up to $\varphi = 30^\circ$ angle of heel and not less than 0.09 m-radians up to $\varphi = 40^\circ$ or the angle of down-flooding φ_f^{34} , if this angle is less than 40° .
- b. Additionally, the area under the righting lever curve (GZ curve) between the angles of heel of 30° and 40° or between 30° and φ_p , if this angle is less than 40° , shall not be less than 0.03 m-rad.
- c. The righting lever GZ shall be at least 0.2 m at an angle of heel equal to or greater than 30° .

³⁴ φ_f is an angle of heel at which openings in the hull, superstructures or deckhouses which cannot be closed weathertight immerse. In applying this criterion, small openings through which progressive flooding cannot take place need not be considered as open.

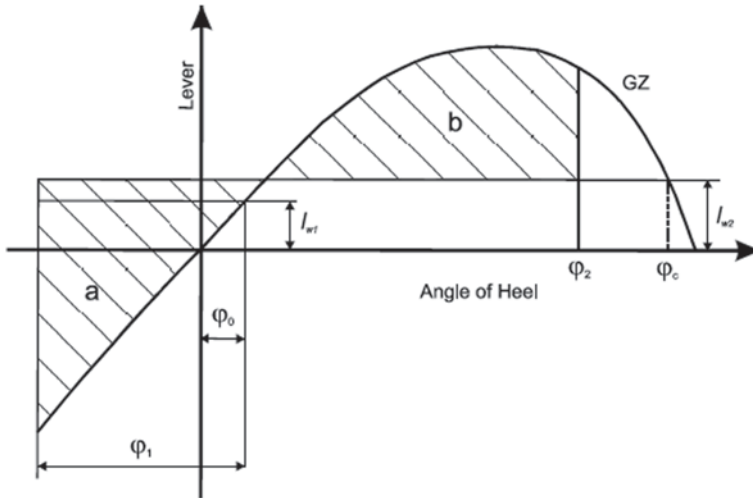

Fig. 2.97 Severe wind and rolling (weather criterion)

- d. The maximum righting lever shall occur at an angle of heel not less than 25°. If this is not practicable, alternative criteria, based on an equivalent level of safety³⁵, may be applied subject to the approval of the administration.
- e. The initial metacentric height GM_0 shall not be less than 0.15 m.

The below *weather criterion* considers the case of severe wind and excessive rolling motions due to the excitation of incoming waves (refer Fig. 2.97) and applies to *special ship types and to floating vehicles*:

- 10. The ship is subjected to a steady wind pressure acting perpendicular to the ship's centerline which results in a steady wind heeling lever (l_{w1});
- 11. from the resultant angle of equilibrium (ϕ_0), the ship is assumed to roll due to wave action to an angle of roll (ϕ_1) to windward. The angle of heel under action of steady wind (ϕ_0) should not exceed 16° or 80% of the angle of deck edge immersion, whichever is less;
- 12. the ship is then subjected to a gust wind pressure which results in a gust wind heeling lever (l_{w2}); and
- 13. under these circumstances, area b shall be equal to or greater than area a , as indicated in Fig. 2.97 below:

where the angles in Fig. 2.97 are defined as follows:

- ϕ_0 = angle of heel under action of steady wind
- ϕ_1 = angle of roll to windward due to wave action
- ϕ_2 = angle of down-flooding (ϕ_f) or 50° or ϕ_c , whichever is less,

³⁵ Refer to the Explanatory Notes to the International Code on Intact Stability, IMO 2008a (MSC.1/Circ.1281)

where:

φ_f = angle of heel at which openings in the hull, superstructures or deckhouses which cannot be closed weathertight immerse. In applying this criterion, small openings through which progressive flooding cannot take place need not be considered as open

φ_c = angle of second intercept between wind heeling lever l_{w2} and GZ curves.

The wind heeling levers l_{w1} and l_{w2} referred to in points 1 and 3 above are constant values at all angles of inclination and shall be calculated as follows:

$$l_{w1} = \frac{P * A * Z}{1,000 * g * \Delta} \text{ (m)}$$

$$l_{w2} = 1.5 * l_{w1} \text{ (m)}$$

where:

P = wind pressure of 504 Pa. The value of P used for ships in restricted service may be reduced subject to the approval of the administration

A = projected lateral area of the portion of the ship and deck cargo above the waterline (square meter)

Z = vertical distance from the center of A to the center of the underwater lateral area or approximately to a point at one half the mean draught (meter)

Δ = displacement (tons)

g = gravitational acceleration of 9.81 m/s².

Alternative means for determining the wind heeling lever (l_{w1}) may be accepted, to the satisfaction of the administration.

The angle of roll (φ_1) referred to in point 2 above shall be calculated as follows:

$$\varphi_1 = 109 * k * X_1 * X_2 * \sqrt{r * s} \text{ (degrees)}$$

where:

X_1 = factor as shown in Table 2.40

X_2 = factor as shown in Table 2.40

k = factor as follows:

k = 1.0 for round-bilged ship having no bilge or bar keels

k = 0.7 for a ship having sharp bilges

k = as in Table 2.40 for a ship having bilge keels, a bar keel or both

$$r = 0.73 + 0.6(OG / d)$$

Table 2.40 Values of factor X_1 , X_2 , k , and s

| B/d | X_1 | C_B | X_2 | $\frac{A_k * 100}{L_{WL} * B}$ | k | T | s |
|-------|-------|-------|-------|--------------------------------|------|-----|-------|
| ≤2.4 | 1.0 | ≤0.45 | 0.75 | 0 | 1.0 | ≤6 | 0.100 |
| 2.5 | 0.98 | 0.50 | 0.82 | 1.0 | 0.98 | 7 | 0.098 |
| 2.6 | 0.96 | 0.55 | 0.89 | 1.5 | 0.95 | 8 | 0.093 |
| 2.7 | 0.95 | 0.60 | 0.95 | 2.0 | 0.88 | 12 | 0.065 |
| 2.8 | 0.93 | 0.65 | 0.97 | 2.5 | 0.79 | 14 | 0.053 |
| 2.9 | 0.91 | ≥0.70 | 1.00 | 3.0 | 0.74 | 16 | 0.044 |
| 3.0 | 0.90 | | | 3.5 | 0.72 | 18 | 0.038 |
| 3.1 | 0.88 | | | ≥4.0 | 0.70 | ≥20 | 0.035 |
| 3.2 | 0.86 | | | | | | |
| 3.4 | 0.82 | | | | | | |
| ≥3.5 | 0.80 | | | | | | |

Intermediate values in these tables shall be obtained by linear interpolation

with:

$$OG = KG - d,$$

d = mean moulded draught of the ship (meter)

S = factor as shown in Table 2.40, where T is the ship roll natural period.

In absence of sufficient information, the following approximate formula can be used:

Rolling period

$$T = \frac{2 * C * B}{\sqrt{GM}} \cdot (\text{second})$$

where:

$$C = 0.373 + 0.023(B / d) - 0.043(L_{wl} / 100).$$

The symbols in Table 2.40 and the formula for the rolling period are defined as follows:

L_{wl} = length of the ship at waterline (meter)

B = moulded breadth of the ship (meter)

d = mean moulded draught of the ship (meter)

C_B = block coefficient (-)

A_k = total overall area of bilge keels, or area of the lateral projection of the bar keel, or sum of these areas (square meter)

GM = metacentric height corrected for free surface effect (meter).

Special Criteria for Certain Types of Ships

Passenger Ships

Passenger ships shall comply with the *general criteria and the weather criterion requirements*. In addition, the angle of heel accounting for the crowding of passengers to one side as defined below, shall not exceed 10°.

A minimum weight of 75 kg shall be assumed for each passenger except that this value may be increased subject to the approval of the administration. In addition, the mass and distribution of the luggage shall be approved by the administration. The height of the center of gravity for passengers shall be assumed equal to:

- 1 m above deck level for passengers standing upright; account may be taken, if necessary, of camber and sheer of deck
- 0.3 m above the seat in respect of seated passengers.

In addition, the angle of heel account for turning maneuver shall not exceed 10° when calculated using the following formula:

$$M_R = 0.200 * \frac{v_0^2}{L_{WL}} * \Delta * \left(KG - \frac{d}{2} \right)$$

where:

M_R = heeling moment (kilonewton-meter)

V_0 = service speed (meter per second)

L_{WL} = length of ship at waterline (meter)

Δ = displacement (tons)

D = mean draught (meter)

KG = height of center of gravity above baseline (meter).

Oil tankers of 5,000 t DWT and above

Oil tankers³⁶ shall comply with the provisions of regulation 27 of Annex I to MARPOL 73/78 (which lead to the same *general intact stability requirements* on GZ, as outlined above).

Cargo ships carrying timber deck cargoes

Cargo ships carrying timber deck cargoes shall comply with the *general criteria and the weather criterion requirements* unless the administration is satisfied with the application of alternative provision, laid down in the IS2008 code.

Cargo ships carrying grain in bulk

The intact stability of ships engaged in the carriage of grain shall comply with the requirements of the International Code for the Safe Carriage of Grain in Bulk adopted by resolution MSC.23(59).

³⁶ Oil tanker means a ship constructed or adapted primarily to carry oil in bulk in its cargo spaces and includes combination carriers and any chemical tanker as defined in Annex II of the MARPOL Convention when it is carrying a cargo or part cargo of oil in bulk.

High-speed craft

High-speed craft³⁷ constructed on or after 1 January 1996 but before 1 July 2002, to which chapter X of the 1974 SOLAS Convention applies, shall comply with stability requirements of the 1994 HSC Code (resolution MSC.36(63)). Any high-speed craft to which chapter X of the 1974 SOLAS Convention applies, irrespective of its date of construction, which has undergone repairs, alterations or modifications of a major character; and a high-speed craft constructed on or after 1 July 2002, shall comply with stability requirements of the 2000 HSC Code (resolution MSC.97(73)).

Containerships greater than 100 m

Requirements for containerships³⁸ over 100 m in length regarding the GZ curve properties are as following:

- The area under the GZ curve should not be less than $0.009/C$ m rad up to $\varphi=30^\circ$ angle of heel, and not less than $0.016/C$ m rad up to $\varphi=40^\circ$ or the earlier defined angle of flooding φ_f if this angle is less than 40° .
- Additionally, the area under the GZ curve between the angles of heel of 30° and 40° or between 30° and φ_f if this angle is less than 40° , should not be less than $0.006/C$ m rad.
- The righting lever GZ should be at least $0.033/C$ m at an angle of heel equal or greater than 30° .
- The maximum righting lever GZ should be at least $0.042/C$ m.
- The total area under the righting lever curve (GZ curve) up to the angle of flooding φ_f should not be less than $0.029/C$ m rad.

Since the criteria in this section were empirically developed with the data of containerships less than 200 m in length, they should be applied to *ships beyond such limits with special care*. In the above criteria the form factor C should be calculated using the below formula and the definitions of Fig. 2.98:

$$C = \frac{dD'}{B_m^2} \sqrt{\frac{d}{KG}} \left(\frac{C_B}{C_w} \right)^2 \sqrt{\frac{100}{L}}$$

where:

d = mean draught (meter)

D' = moulded depth of the ship, corrected for defined parts of volumes within the hatch coamings according to the formula:

$$D' = D + h \left(\frac{2b - B_D}{B_D} \right) \left(\frac{2\Sigma I_H}{L} \right)$$

³⁷ *High-speed craft* (HSC) is a craft capable of a maximum speed, in meter per second (m/s), equal to or exceeding: $3.7 * \nabla^{0.1667}$, where: ∇ = displacement volume corresponding to the design waterline (cubic meter).

³⁸ They may also be applied to other cargo ships in this length range with considerable flare or large water plane areas.

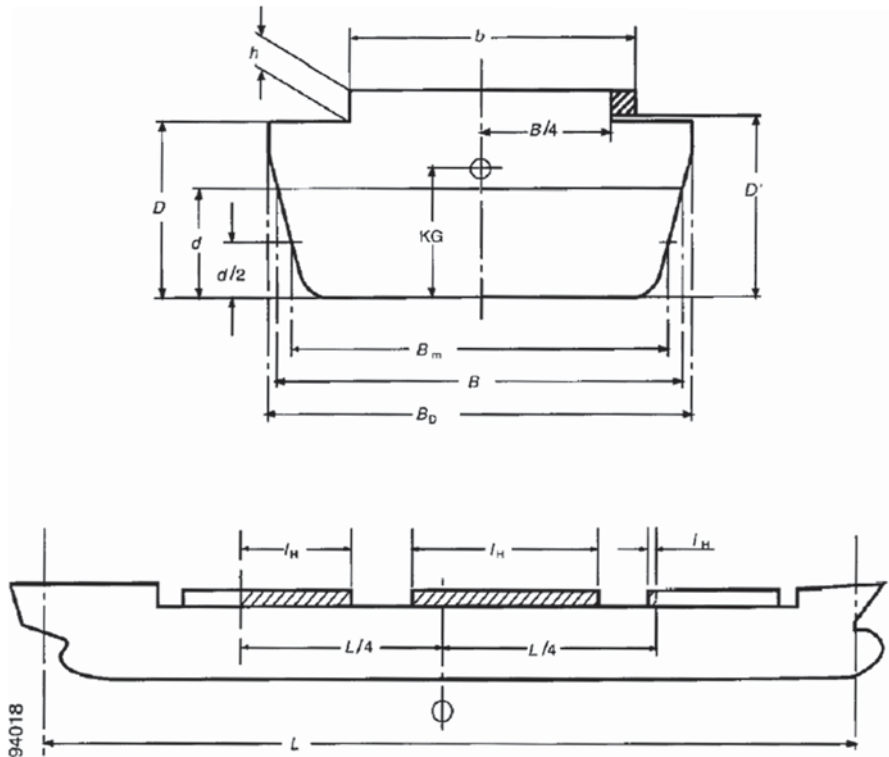

Fig. 2.98 Definition of parameters for the intact stability form factor C of containerships. (The shaded areas in Fig. 2.98 represent partial volumes within the hatch coamings considered contributing to resistance against capsizing at large heeling angles when the ship is on a wave crest. The use of electronic loading and stability instrument is encouraged in determining the ship's trim and stability during different operational conditions)

- D = moulded depth of the ship (meter);
- B_D = moulded breadth of the ship (meter);
- KG = height of the center of mass above base, corrected for free surface effect, not be taken as less than d (meter);
- C_B = block coefficient;
- C_W = water plane coefficient;
- l_H = length of each hatch coaming within $L/4$ forward and aft from amidships (meter);
- b = mean width of hatch coamings within $L/4$ forward and aft from amidships (meter);
- h = mean height of hatch coamings within $L/4$ forward and aft from amidships (meter);
- L = length of the ship (meter);
- B = breadth of the ship on the waterline (meter);
- B_m = breadth of the ship on the waterline at half mean draught (meter).

2.18.9 Verification of Trim and Bow Height

We assume that in the design loading condition the ship will not present any undesirable trim³⁹, may be by taking a limited amount of ballast water⁴⁰.

From the well-known relationship for the trim at small angles:

$$t = L \cdot \frac{M_t}{\Delta \cdot \overline{GM}_L}$$

where M_t : trim moment, \overline{GM}_L : longitudinal metacentric height, it is concluded with

$$\overline{GM}_L \cong \overline{BM}_L + T / 2$$

and

$$\overline{BM}_L \cong 0.07 \cdot L^2 / T \text{ (Schneekluth)}$$

where

$$L \cong L_{WL}$$

the resulting trim t for nonbalanced trim moments M_t .

Regardless of the existence of trim, the minimum height of the bow of the ship, as the one defined at the ship's forward perpendicular (see Fig.2.99), is specified in the International Load Line Convention:

Minimum bow height

Ships with $L < 250$ m:

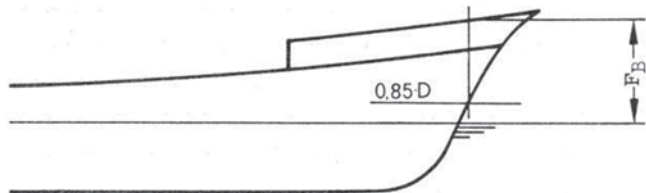

Fig. 2.99 Bow height F_B at the *forward perpendicular*

³⁹ A small stern (rarely bow down) trim is often desirable and generally acceptable.

⁴⁰ A significant amount of ballast water in the design loading condition may be necessary for some types of ships, like containerhips, carrying a significant number of containers on deck. Modern ship design concepts aim at significantly reducing the amount of ballast water both in the design load and the ballast condition, thus reducing both fuel cost and incurring additional cost for ballast water treatment in view of IMO's guidelines on ballast water management (latest, IMO-MEPC.173(58), IMO 2008b).

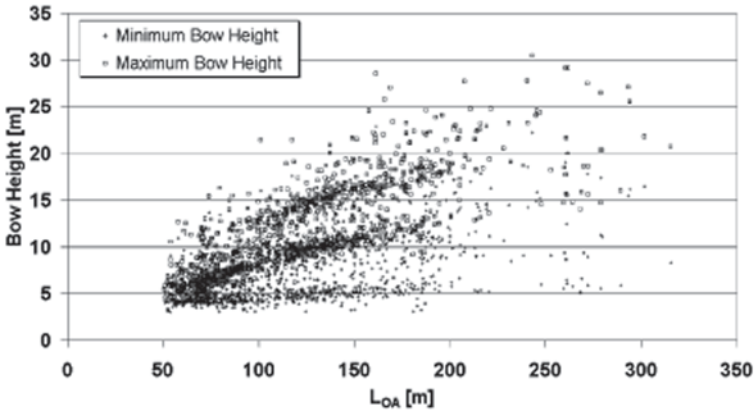

Fig. 2.100 Statistics of bow heights of passenger/ferries with forecastle. (Tagg et al. 2001)

$$F_B \geq 56 \cdot L \left(1 - \frac{L}{500} \right) \cdot \frac{1.36}{C_B + 0.68}$$

where F_B (millimeter), L (meter).

Ships with $L \geq 250$ m:

$$F_B \geq 7000 \cdot \frac{1.36}{C_B + 0.68}$$

In both formulas, the minimum C_B is considered as equal to 0.68.

The aforementioned formulae apply to existing ships in accordance with the old Load Line regulations (see Sect. 2.19 for the most recent changes). In the above Fig. 2.100, we can observe statistical values of bow heights of passenger/ferry ships according to Tagg et al. (2001):

Concluding remarks on the verification of stability and trim

It is clear from the above deliberations in this section that the verification/examination of the ship's stability and trim during the preliminary design stage is limited to the control of the ship's behavior in intact condition and for small inclination angles (*initial stability and trim*). The examined values are determined by the wetted (buoyant) part of the ship's hull (in calm water). In order to examine the stability of the ship at large inclination angles, the knowledge of the ship's hull above the design waterline⁴¹, including her freeboard, are necessary. Finally, for examining the ship's damage stability, the internal subdivision of the ship, including the position of watertight transverse and longitudinal bulkheads, of decks, openings and down-flooding points, is required.

⁴¹ Including the location of nonwatertight openings of the ship's outer shell.

2.19 Freeboard and Sheer

2.19.1 Factors Affecting the Freeboard

- Large freeboard ensures large reserve buoyancy and increased the ship survivability in case of hull damage. It also improves the ship stability at large inclination angles.
- Sufficient freeboard improves the ship's behavior in seaways. Particularly, it provides improved safety against wetting of the deck, damage of deck cargo (deck containers) and likely water ingress into the ship's holds from incoming, high waves.
- Because of the pitch-axis location in general abaft of the midship section and consequently the more intense bow motions, a higher freeboard at forward perpendicular is required.
- This increased freeboard is also necessary in the "critical region" around the ship's forward perpendicular, namely, for approximately 15% of the ship's length, which is so specified in the Load Line Convention⁴².

The bow height, measured at forward perpendicular between design waterline (summer load line) and the ship's weathertight deck (e.g., forecastle), rarely exceed 8–9% of the length L_{pp} . Generally, this percentage reduces with the increase of the absolute ship size. Fast ships need to have relatively higher bows, compared to the slow ones, because of higher "swell-up" of the generated bow wave and likely more intense bow motions.

The following figure presents the statistics of freeboard heights for various shiptypes on the basis of data of of IHS Fairplay World Shipping Encyclopedia, v. 12.01, 2011 (Fig. 2.101).

The latest Load Line Regulations (ICLL 1988, Regulation 39) specify *as minimum freeboard* at the forward perpendicular, for normal trim, the following:

$$F_b = \left(6075 \left(\frac{L}{100} \right) - 1875 \left(\frac{L}{100} \right)^2 + 200 \left(\frac{L}{100} \right)^3 \right) \times \left(2.08 + 0.609C_b - 1.603C_{wf} - 0.0129 \left(\frac{L}{d_1} \right) \right)$$

⁴² The International Load Line Convention has a long history, starting in 1890, when the first rules for a minimum freeboard for all ships departing from *British ports* (thanks to the British politician *Samuel Plimsoll*) were established. The first form of relevant *international regulations* was agreed in 1930 by 54 countries. In the framework of the International Maritime Organization (IMO), the first International Convention on Load Lines (ICLL) was first approved on 5 April 1966 and entered into force on 21 July 1968. Some changes followed in 1971, 1975, 1979, 1983, and 1995, which never entered into force because of lack of enough flag state acceptances; the 1966 ICLL provisions were amended by the adopted Protocol of 1988, which entered into force on 3 February 2000. The intention of the Protocol of 1988 was to harmonize the requirements of the Convention on the survey and certification with the corresponding requirements of SOLAS & MARPOL 73/78. The Protocol of 1988 was once more amended by the 2003 Amendments, which were adopted with the Resolution MSC.143 on 5 June 2003 and entered into force on 1 January 2005, as well as with further Amendments adopted with the Resolution MSC.172 on 9 December 2004 and which entered into force on 1 July 2006.

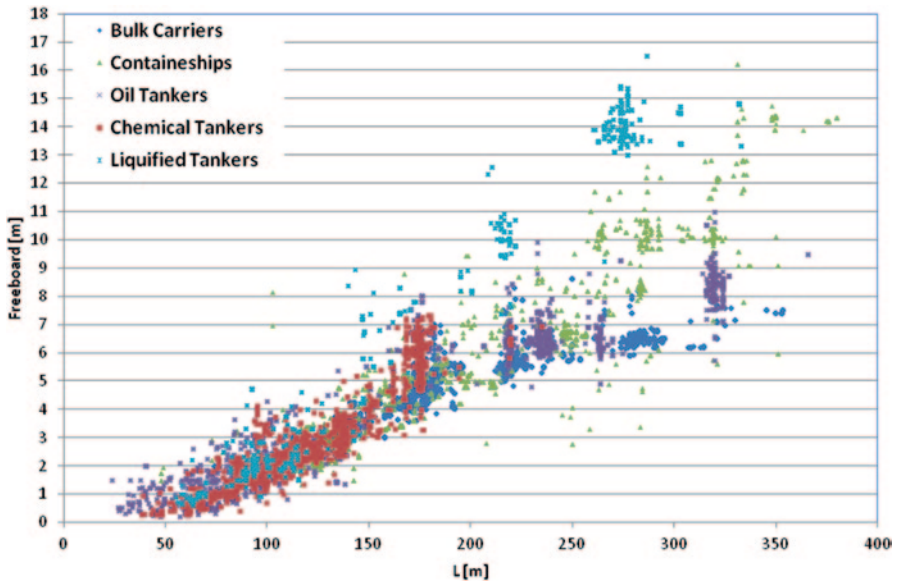

Fig. 2.101 Statistics of freeboard height of dry cargo and liquid cargo ships (analysis of data of IHS Fairplay 2011)

where

- F_b (millimeter): minimum bow height
- L (meter): length for freeboard calculation
- B (meter): breadth for freeboard calculation
- d_1 (meter): draft at 85% of the side depth D
- C_b : block coefficient according to Regulation 3
- C_{wf} : waterplane area coefficient of the fore body (from midship to forward).

$$C_{wf} = \frac{A_{wf}}{\frac{L}{2} \cdot B}$$

A_{wf} (square meter): waterplane area of the fore body at draft d_1 .

The ICLL regulations state that if the minimum value of the bow height at FP is achieved by consideration of a sheer, then the same height must extend over at least 15% L from the forward perpendicular. In addition, if the height is measured with respect to an existing forecastle, then it is appropriate for such a forecastle to extend over at least 7% L aft of FP.

Similar specifications for a minimum height of the ship's stern do not exist. However, it is assumed that the resulting height will be at least equal to the freeboard at the ship's midship section. Furthermore, if the above bow height is achieved as freeboard at the ship's midship section, it is obvious that generally the provision of an additional sheer at the freeboard deck for the satisfaction of Load Line Regulations is not required.

Table 2.41 Typical values of bow height and of height of the strength deck for various types of merchant ships; synthesis of data by E. Strohbush (1971) and partly revised according to IHS Fairplay World Shipping Encyclopedia, v. 12.01, 2011)

| Ship type | L_{pp}/D | F_{FP} (m) | $F_{FP}-\%L_{pp}$ |
|---------------------------------|------------|--------------|-------------------|
| Fast seagoing cargo ships | 9.9–13.5 | 13.0–18.5 | 4.9–7.5 |
| Slow seagoing cargo ships | | 12.0–13.0 | 6.3–7.9 |
| Coastal cargo ships | 10.0–12.0 | 3.5–4.5 | Up to 7.0 |
| Small short sea passenger ships | 10.4–11.6 | 6.0–7.0 | 6.6–7.9 |
| Ferries | 8.6–10.3 | 7.0–10.0 | 7.0–10.0 |
| Fishing vessels | 8.2–9.0 | 5.0–6.5 | 8.0–8.5 |
| Tugboats | 7.7–10.0 | 4.6–7.4 | 8.2–12.0 |
| Bulk carriers | 10.5–12.8 | 4.4–4.9 | 8.8–10.5 |
| Tankers | 12.0–14.0 | 3.6–4.5 | 9.4–11.7 |
| Fast seagoing reefers | ~11.0 | 5.6–6.6 | 7.2–8.8 |

Typical values for the bow height and the height of the strength deck (which is not necessarily the freeboard deck) for common types of merchant ships are listed in Table 2.41.

2.19.2 Verification of Freeboard

The calculation and verification of the allowable freeboard, namely of the permitted vertical distance of the upper edge of the freeboard deck (typically: uppermost continuous and watertight deck) from the upper edge of the corresponding load line (generally: at the design draft of the ship), are governed by the regulations of the International Convention on Load Lines and *determine the maximum allowable loading draft of the ship. Naval ships, fishing vessels and boats of length smaller than 24 m are generally exempted* from the implementation of these regulations. A numerical example of the application of the ICLL regulations to cargo ships is given in reference Papanikolaou (2009a, Vol. 2).

In the initial design stage, the examination of the freeboard aims at verifying the compatibility of the initially estimated principal dimensions and of other fundamental ship values, such as of the ship's length L , side depth D , draft T , block coefficient CB , and of the extent/type of the ship's superstructures. In particular, the validity of the selection of the ship's side depth D is confirmed by the simultaneous control of the following ship characteristics:

- hold volume (see Sect. 2.17)
- freeboard (see current paragraph, Sect. 2.19.2)
- ICLL regulations
- stability (see Sect. 2.18).

The ultimate objective is to achieve a minimum, but sufficient freeboard and to ensure satisfactory reserve buoyancy in case of hull damage and internal flooding. The corresponding freeboard deck, from which the freeboard is measured, is in general identical to upper watertight boundary of ship's watertight bulkheads (*bulkhead*

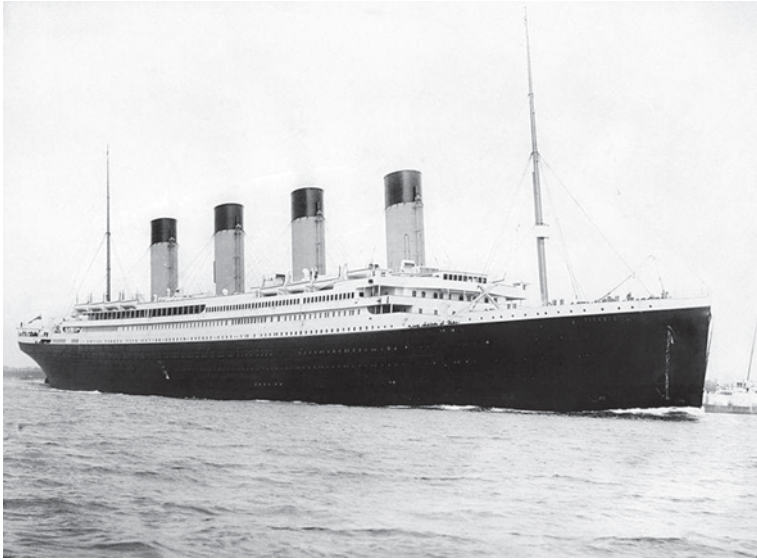

Fig. 2.102 RMS *Titanic* departing Southampton on 10 April 1912 (last voyage)

deck)⁴³. For tankers (category “A” ships according to ICLL, namely, ships carrying exclusively liquid cargo), *reduced freeboards* are specified according to the regulations, because of the small permeability of the fully loaded ships (in case of hull breach) and of their watertight subdivision. Reduced freeboards are also specified exceptionally for bulk carriers, if proven to be safe (do not sink or capsizes) in the case of flooding of *one (B-60 ships)* or *two neighboring (B-100 ships)* compartments, except for the engine room.

It is noted that for Ro-Ro passenger ships the freeboard deck is identical to the ship’s main car deck (which is also the ship’s bulkhead deck) (Fig. 2.102)⁴⁴.

Satisfactory freeboard allows:

- Prevention of deck wetness and entrance of water into the ship through unprotected or nonwatertight openings

⁴³ The ICLL regulations define the *freeboard deck* as the *uppermost continuous deck of the ship*, which is exposed to the weather and the sea. Thus, the freeboard deck is at *least weathertight*, but generally also *watertight*. Exceptionally, the authorities may permit the freeboard deck to be a lower deck (and not the uppermost, continuous deck), which must be continuous between the peak ballast tanks of the ship (fore and aft-peak bulkheads). In this case the space above this lower placed freeboard deck and up to the deck above it is treated as *superstructure*.

⁴⁴ [synthesis from Wikipedia] RMS *Titanic* was a British passenger liner that sank in the North Atlantic Ocean on 15 April 1912 after colliding with an iceberg during her maiden voyage from Southampton, UK to New York City, USA. The sinking of *Titanic* caused the deaths of 1,502 people in one of the deadliest peacetime maritime disasters in modern history. On her maiden voyage, she carried 2,224 passengers and crew. The RMS *Titanic* was the largest ship afloat at the time of her maiden voyage and was thought to be unsinkable due to her very dense subdivision. *She was lacking, however, a watertight bulkhead-deck and this was the main reason for her sinking*. One of their most important legacies was the establishment in 1914 of the International Convention for the Safety of Life at Sea (SOLAS), which still governs maritime safety today.

- Protection of crew working on deck
- Safety of cargo stowed on deck (e.g., deck containers)
- Increase of the range of stability for large inclination angles
- Satisfactory stability in damage condition.

If during the control of the ship's freeboard a significant failure is identified, which cannot be compensated with small design corrections, such as changing of deck sheer, small changes in the extent of superstructures, it is always recommended to increase the side depth D . However, as the steel weight will simultaneously slightly increase, this will result to a larger draft, compared to the original one, so that the change of D cannot be fully transferred to a "gain" in terms of freeboard. On the other side, if during the examination of the hold volume the space proves sufficient, then the proposed increase of D can be accompanied by a corresponding reduction of length L ; the latter will eventually result in a reduction of the required freeboard (see Table 2.42 of basic freeboards), while the structural weight of the ship may

Table 2.42 Freeboard table according to ICLL

| Length of ship (m) | Freeboard for type "A" ships (mm) | Freeboard for type "B" ships (mm) |
|--------------------|-----------------------------------|-----------------------------------|
| 24 | 200 | 200 |
| 30 | 250 | 250 |
| 40 | 334 | 334 |
| 50 | 443 | 443 |
| 60 | 573 | 573 |
| 70 | 706 | 721 |
| 80 | 841 | 887 |
| 90 | 984 | 1,075 |
| 100 | 1,135 | 1,271 |
| 110 | 1,293 | 1,479 |
| 120 | 1,459 | 1,690 |
| 130 | 1,632 | 1,901 |
| 140 | 1,803 | 2,109 |
| 150 | 1,968 | 2,315 |
| 160 | 2,126 | 2,520 |
| 170 | 2,268 | 2,716 |
| 180 | 2,393 | 2,915 |
| 190 | 2,508 | 3,098 |
| 200 | 2,612 | 3,264 |
| 210 | 2,705 | 3,430 |
| 220 | 2,792 | 3,586 |
| 230 | 2,875 | 3,735 |
| 240 | 2,946 | 3,880 |
| 250 | 3,012 | 4,018 |
| 260 | 3,072 | 4,152 |
| 270 | 3,128 | 4,276 |
| 280 | 3,176 | 4,397 |
| 290 | 3,220 | 4,513 |
| 300 | 3,262 | 4,630 |
| 310 | 3,298 | 4,736 |
| 320 | 3,331 | 4,844 |
| 330 | 3,358 | 4,955 |
| 340 | 3,382 | 5,055 |
| 350 | 3,406 | 5,160 |
| 360 | 3,425 | 5,260 |
| 365 | 3,433 | 5,303 |

Freeboards at intermediate lengths of ship shall be obtained by linear interpolation

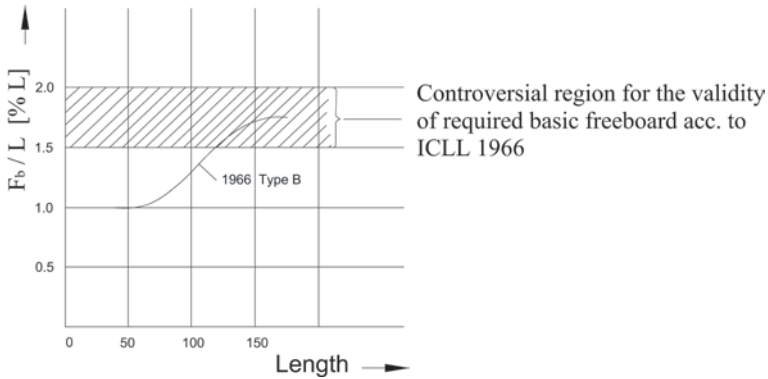

Fig. 2.103 Basic freeboard for ships of category B.

remain fixed or be even reduced. It is assumed that the increase of D and the consequent increase of the center of mass of the ship \overline{KG} , do not create significant initial stability problems (\overline{GM} requirement) for the study ship (see Sect. 2.18).

In general it can be concluded that “*volume carriers*” (see Sect. 1.3.7.2) due to the nature of the transferred cargo (low specific weight, high stowage factor) rarely exhibit problems on satisfying the requirements of the Load Line Regulations, namely, they do not fully exploit the allowable margin of draft, in terms of the Load Line requirements (or their actual freeboard is larger than the minimum one). On the contrary, “*deadweight carriers*,” which carry relatively heavy cargoes and for which the adequacy of hold volume is not an issue (e.g., tankers and bulkcarriers), reach the limit of *minimum allowable freeboard* of the Load Line Convention in terms of their design draft. The same is often valid for Ro-Ro passenger ships carrying heavy trucks, especially for those which are conversions of originally other types of ships.

Existing regulations appear to penalize the relatively large ships (or favor smaller ships) since the specified values for the *basic freeboard* for small ships ($L \leq 65$ m) is less than/equal to $1\% L$, while the corresponding required height for ships with approximate $L \geq 120$ m is more than $1.5\% L$ (see Fig. 2.103 and critical review, Sect. 2.19.4).

Simplified calculation of freeboard

In the context of conceptual/preliminary ship design, the accurate calculation of the required freeboard in accordance with the ICLL regulations presents difficulties due to the unavailability of certain necessary data.

If comparable data from similar ships are used to determine the ship’s principal dimensions, it is rational to assume that the estimated ratio (D/T) will be a guide for the determination of the anticipated freeboard, without of course excluding differentiations with respect to the implementation of precise regulations to that ship.

Table 2.43 Corrections a_1 , for the simplified calculation of the freeboard of general cargo ships without superstructure amidships by Danckwardt

| L_{pp} (m) | a_1 | |
|--------------|-----------------|--------------|
| | $C_B \leq 0.68$ | $C_B = 0.80$ |
| 150 | 1.335 | 1.36 |
| 140 | 1.335 | 1.34 |
| 130 | 1.298 | 1.32 |
| 120 | 1.280 | 1.30 |
| 110 | 1.261 | 1.28 |
| 100 | 1.243 | 1.26 |
| 90 | 1.225 | 1.24 |
| 80 | 1.206 | 1.22 |
| 70 | 1.188 | 1.20 |
| 60 | 1.170 | 1.18 |

For the initial approximation of the freeboard of general cargo ships, the following simplified method by Danckwardt (Henschke 1964) can be applied⁴⁵. In this method the ratio (D/T) is calculated as follows:

1. Ships with forecastle but *without* superstructure amidships:

$$D/T = a_1 - 0.10(l_s / L_{pp})$$

where

$a_1 = f(L_{pp}, C_B)$, see Table 2.43

$l_s =$ overall length superstructures between the perpendiculars

Remarks:

- i. For C_B values between 0.68 and 0.80 it is proposed to interpolate the values in the table.
- ii. For lengths L_{pp} and coefficients C_B significantly beyond the given limits ($L_{pp} = 150$ m and $C_B = 0.80$) *extrapolation* is *not* recommended.

2. Ships with forecastle *and* superstructure amidships:

where

$a_2 = f(L_p L/D, C_B)$, see Table 2.44,

$b_2 = f(L/D, C_B)$, see Table 2.44.

The above method can be best used for general cargo ships and relatively small tankers/bulkcarriers with good results (according to Danckwardt $\pm 2\%$).

⁴⁵ The method refers actually to the “three island” ship concept, characteristic to ships with forecastle, bridge/superstructure amidships and stern poop.

Table 2.44 Corrections a_2 and coefficients b_2 for the simplified calculation of the freeboard of general cargo ships with forecastle and superstructure amidships by Danckwardt

| L_{pp} [m] | C_B 0.68 | | | $C_B=0.80$ | | |
|--------------|------------|-------|----|------------|-------|-------|
| | L/D | | | L/D | | |
| | 10 | 12.5 | 15 | 10 | 12.5 | 15 |
| 150 | 1.370 | 1.350 | | 1.396 | 1.408 | 1.428 |
| 140 | 1.357 | 1.337 | | 1.381 | 1.389 | 1.402 |
| 130 | 1.342 | 1.322 | | 1.364 | 1.369 | 1.376 |
| 120 | 1.324 | 1.310 | | 1.343 | 1.350 | 1.350 |
| 110 | 1.298 | 1.293 | | 1.320 | 1.327 | 1.325 |
| 100 | 1.271 | 1.269 | | 1.294 | 1.302 | 1.300 |
| 90 | 1.245 | 1.242 | | 1.262 | 1.272 | 1.276 |

Corrections b_2

| L/D | C_B 0.68 | $C_B=0.80$ |
|------|------------|------------|
| 10 | 0.152 | 0.150 |
| 12.5 | 0.170 | 0.200 |
| 15 | 0.202 | 0.224 |

Alternatively, it is suggested to use the following simplified diagrams that take into account only the main corrections on the basic freeboard resulting from the Regulations (see Figs. 2.104, 2.105, 2.106, 2.107, 2.108, 2.109, 2.110, and 2.111 according to Danckwardt). The freeboard of dry cargo and liquid cargo ships (tankers) is given as a function of length L_{pp} , the L/D ratio and a presumed normal extent of the superstructure (l_s/L_{pp}). Because the diagrams are for standard block coefficient $C_{B(0.85D)}=0.68$, the values need to be increased according to the corrections of Figs. 2.110 and 2.111.

2.19.3 Sheer

- *Application criteria:* The existence of a sheer on the upper decks of the ship, that is, an upward slope of the centerline of the ship's deck from amidships towards the ends, significantly improves the seakeeping characteristics of the ship and increases the reserve buoyancy at the ends. In view of this, earlier built ships were all designed with sheer. Newer buildings, particularly tankers, bulkcarriers, container ships, Ro-Ro, etc., do not dispose a sheer, thus simplifying the construction (reducing building cost) or for operational reasons (e.g., car ferries: problems with the lashing/fastening of vehicles). However, it is possible to have straight line sheer (instead of the parabolic type) at the ends of the ship, for example, in the forecastle region, what still improves the ship's seakeeping behavior in waves, whereas the ship's construction remains in this respect simple. Particularly for small ships with special requirements on seaworthiness, such as fishing

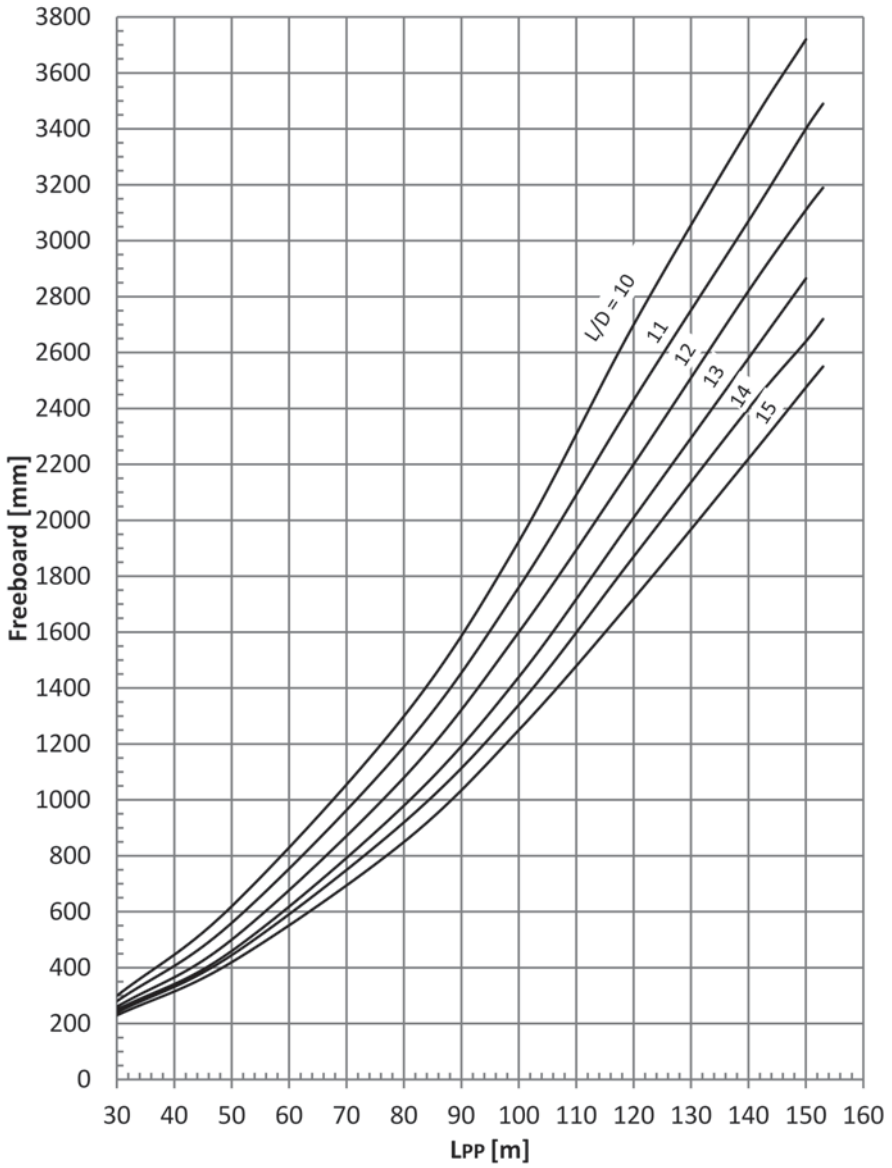

Fig. 2.104 Freeboard of dry cargo ships for $l_s = 0.1 L_{pp}$

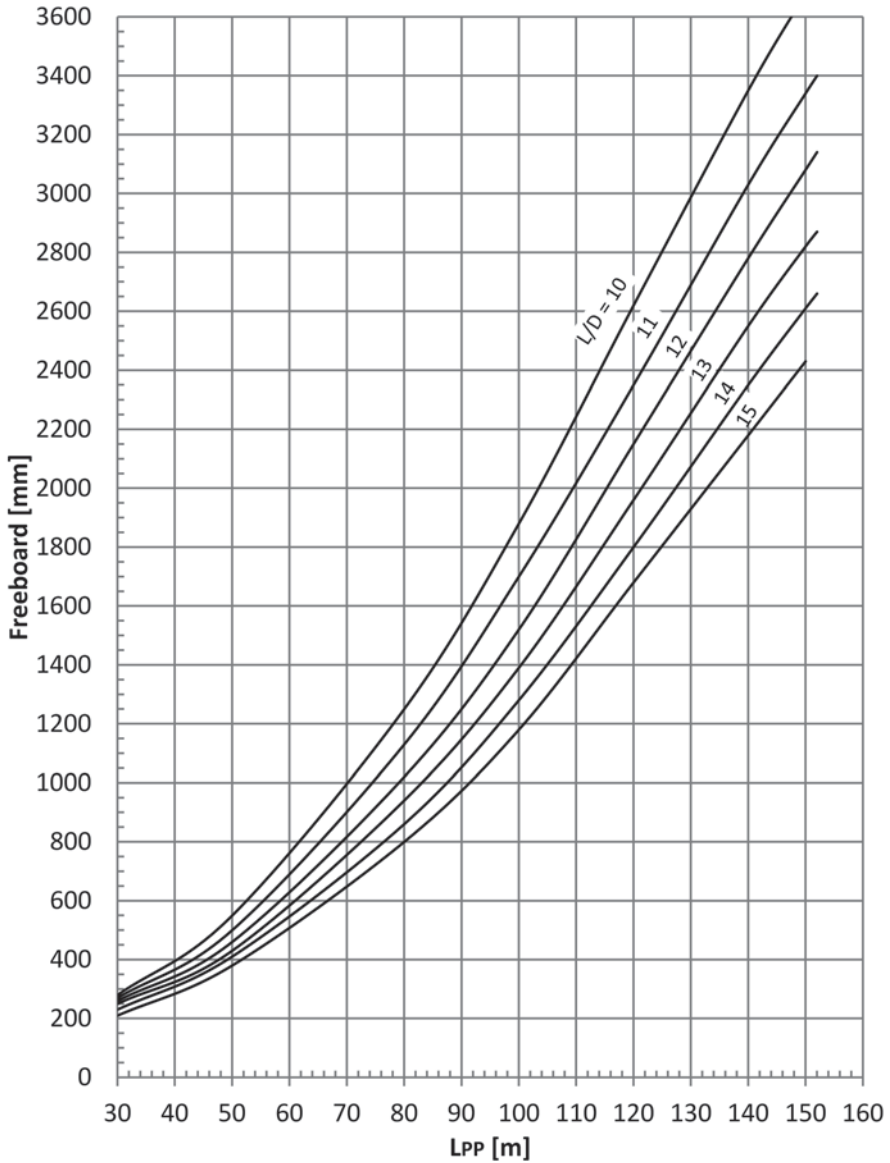

Fig. 2.105 Freeboard of dry cargo ships for $l_s = 0.2 L_{pp}$

vessels, tugs, offshore supply vessels, etc., the existence of a sheer is absolutely necessary. The sheer also affects the ship’s stability at large inclination angles and slightly the position of the floodable lengths’ curve, as well as the resulting position of the watertight bulkheads, as they are required.

- *Load Line Regulations*: The ICLL Load Line Regulations (Reg. 38) specify for ships *without* or *reduced* sheer, in comparison to those with *normal* sheer, in-

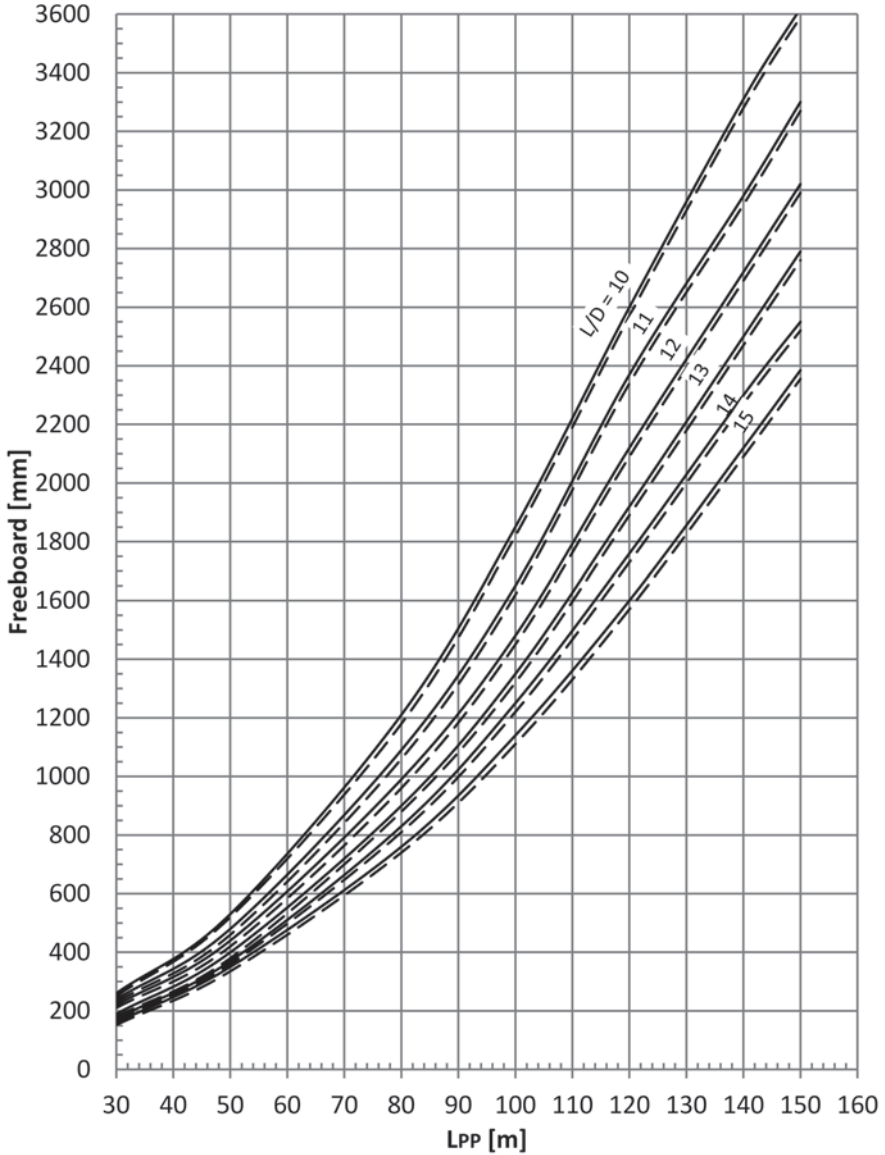

Fig. 2.106 Freeboard for dry cargo ships for $l_s = 0.3 L_{pp}$ (——— ships with forecastle/poop, - - - - - ships with forecastle, poop, and superstructure amidships ($l_{\text{Smidship}} > 0.2 L_{pp}$))

creases in the required freeboard. In contrast, for *increased* sheer beyond the standard values, *reductions* of the freeboard are allowed. The standard/normal sheer is given by two parabolic parts, which extend to the forward and aft part of the ship. The focal point of the above parabola (zero sheer) is at amidships. The

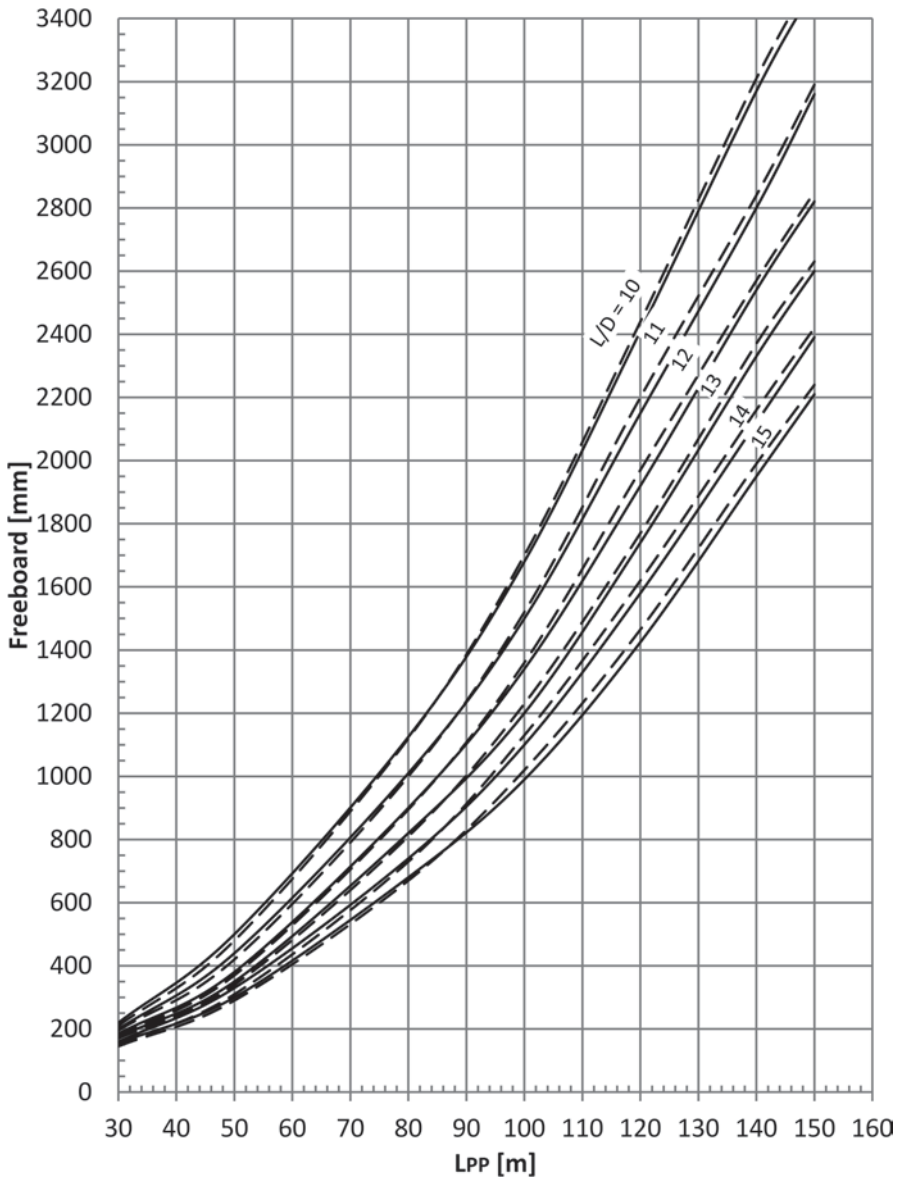

Fig. 2.107 Freeboard for dry cargo ships for $l_s = 0.4 L_{pp}$ (———— ships with forecastle/poop, - - - - - ships with forecastle, poop, and superstructure amidships ($l_{Smidship} > 0.2 L_{pp}$))

normal aft sheer at AP is 50% of the fore sheer at FP. The height of the standard fore sheer is:

$$S_A \text{ (millimeter)} = 50 \left(\frac{L}{3} + 10 \right)$$

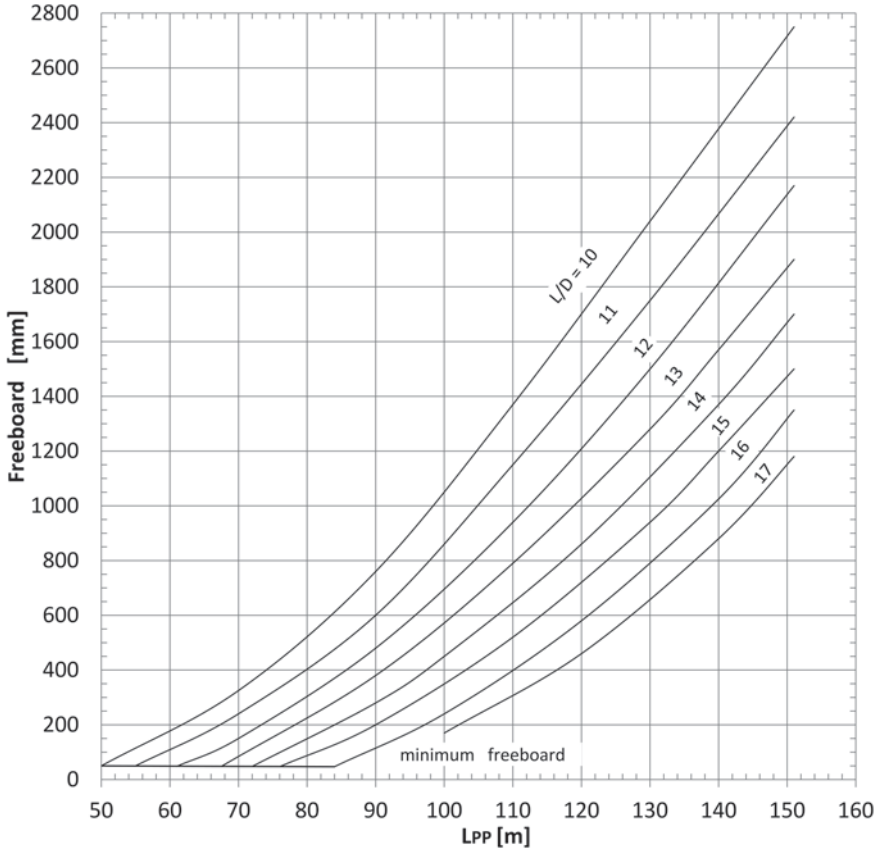

Fig. 2.108 Freeboard of dry cargo ship of type shelterdecker (ships with a protective deck) for $l_s=0.99 L_{pp}$

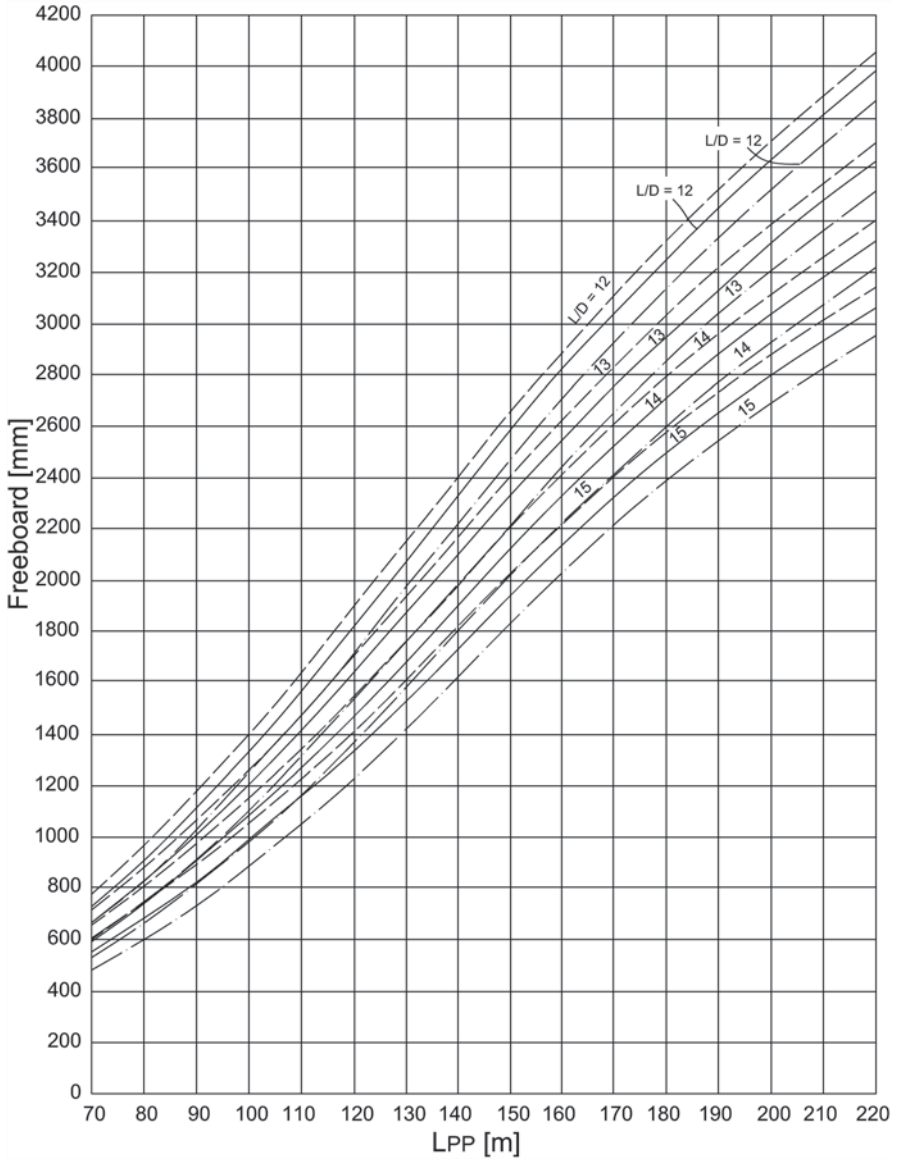

Fig. 2.109 Freeboard of tankers. (— $l_S = 0.2 L_{pp}$, $l_S = 0.3 L_{pp}$, - - - - $l_S = 0.4 L_{pp}$)

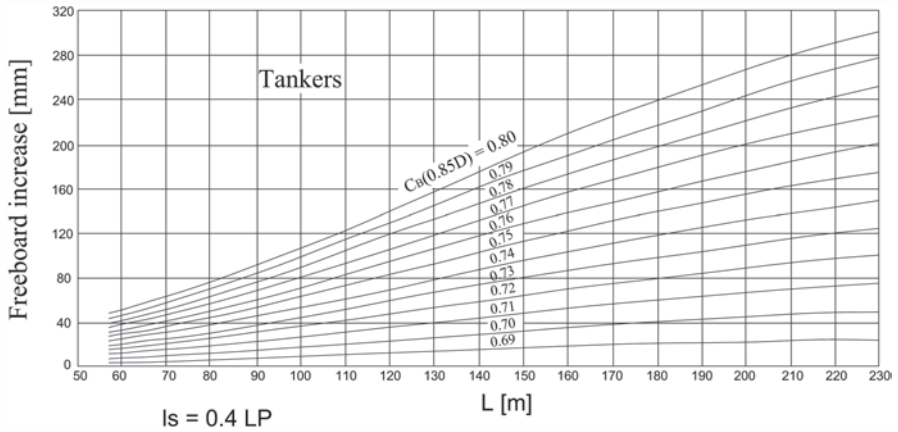

Fig. 2.110 Correction for $C_B(0.85 D) \neq 0.68$. ($l_s = 0.4 L_p$) (for $C_B(0.85 D) \leq 0.68$ no correction. $C_B(0.85 D) = \nabla 0.85 D/L \cdot B \cdot 0.85 D$, D =height of freeboard deck)

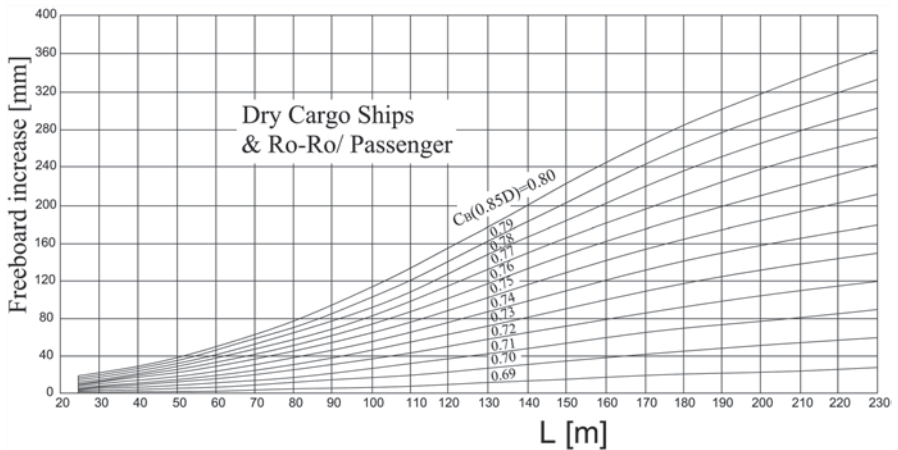

Fig. 2.111 Correction for $C_B(0.85 D)$, no correction for $C_B(0.85 D) \leq 0.68$

where L (meter) is the length of freeboard calculation.

The following Fig. 2.112 presents typical sheer curves, regardless of the normal ones according to the Load Line Regulation, for various ship types. It is noted that for fast ships, the region of minimum sheer is abaft of the midship ($\sim 15\text{--}25\%$ L); the same applies to tug boats. Also, the relationships for the fore and aft sheer height, as percentage of length and among themselves, vary according to the ship's speed and the requirements for adequate seakeeping behavior.

- *Deck sheer*: The sheer is measured at the side edge of each deck with respect to the waterline taken as basis for the calculation of freeboard. It should be noted,

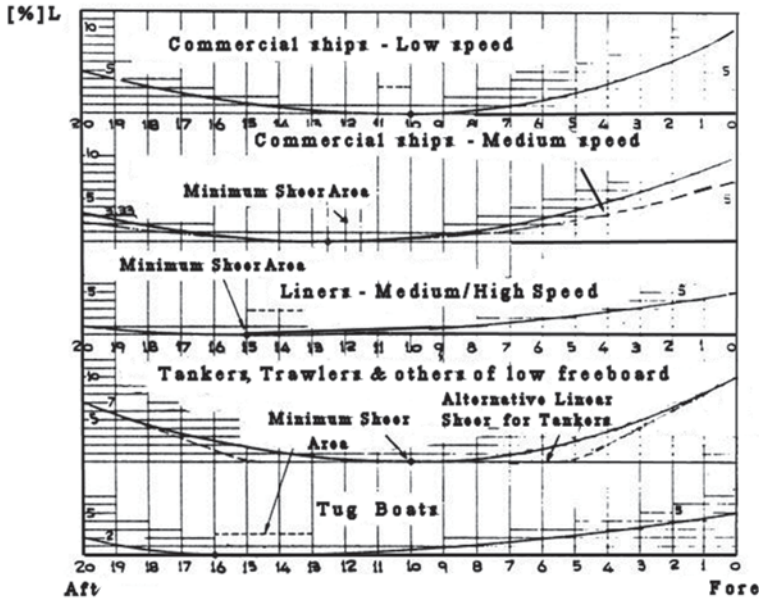

Fig. 2.112 Dimensionless shear curves for various ship types

due to the existence of a camber typically across the ship's weather deck, that the resulting line of the deck at centerplane should be faired (see Fig. 2.113).

Uppermost decks exposed to weather (*weather-decks*) without sheer, but *with transverse camber*, have an even deck at the centerplane, while the deck line at the sides results from the height of the camber at the centerplane (usually $b \cong B/50$, where $B(x)$: breadth of reference deck).

The sheer of other decks except for the weather or freeboard deck, is obtained as follows:

- Decks *above* the weatherdeck, for example, superstructure decks, are usually constructed with the same sheer like the weatherdeck. However, on ships with intense sheer, for example, tugboats, fishing vessels, etc., these decks are constructed without sheer (at least the deck which accommodates the wheelhouse).
- Decks *below* the weatherdeck are generally constructed *without* sheer. This enables the exploitation of the additional stowage volume at the ends, and this is exempted from the tonnage of the ship. An exception here are passenger ships,

Fig. 2.113 Fairing of lines of deck with sheer and camber

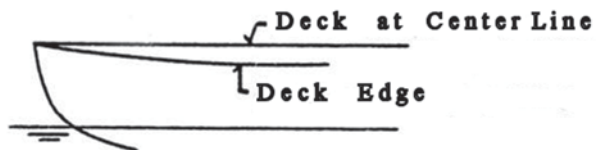

when the second deck is their bulkhead deck, namely, the basis for calculating the floodable length. As is well known, the floodable lengths increase, if there is sheer, so it is not advisable to ignore the sheer in this case. Certainly, when it comes to car ferries, with zero sheer on the bulkhead deck (corresponds to the car deck), the distances between the watertight bulkheads are in anyway greatly reduced.

2.19.4 Critical Review of the Load Line Regulations (*Abicht et al. 1974*)

An analysis of the ICLL Regulations may be skipped in the context of the current textbook (see Antoniou and Perras 1984). However, regarding the effect of these regulations on the design of a ship, the following is noted:

1. The relationship of the required freeboard to the ship's length specifies for small ships not only absolutely, but also as a percentage of length, small freeboards (see Fig. 2.103, percentage basic freeboard for ships of type B). This appears to be contrary to the principle of ensuring sufficient buoyancy and seaworthiness for all ships independently of their size, while allowing smaller boats to operate in relatively heavier seas (on the master's responsibility). It should be noted, however, that this is directly related to the level of operational risk of the ship sailing in normal and severe environmental conditions; from the point of view of regulations, it is generally accepted that a larger ship should be safer than a smaller one. Consequently, the risk levels should be reduced when increasing the size of the ship, such as when increasing the number of people on board (see new probabilistic regulations on damage stability, SOLAS 2009).
2. The specified relationship of freeboard with a series of technical characteristics of the ship, for instance, the ship's type (A or B), size, superstructures' extent and sheer, does not always reflect the ship's actual safety requirements, which would result from a first principles study (seakeeping calculations) and correlation of the above parameters in a rational/scientific way.
3. The required survivability level, in case of damage, for large tankers (type A ships, $L \geq 150$ m), although logical, does not fit to the general context of the ICLL regulatory framework, nor explains the exclusion, from similar requirements regarding the watertight subdivision, of other risky ships, for example, small short-sea cargo ships.
4. Generally, the international regulations on load lines (ICLL) and stability after damage (SOLAS) should be harmonized into a unified regulatory framework. Relevant consultations among the working group committees of the International Maritime Organization IMO have not yet led to practical results.

Despite these critical points, taking into account the recent amendments of the currently in force ICLL Regulations, it is considered that the safety of in-service ships is satisfactorily covered by existing regulations. However, the appropriate imple-

Fig. 2.114 Load Line Mark (Plimsoll Line)

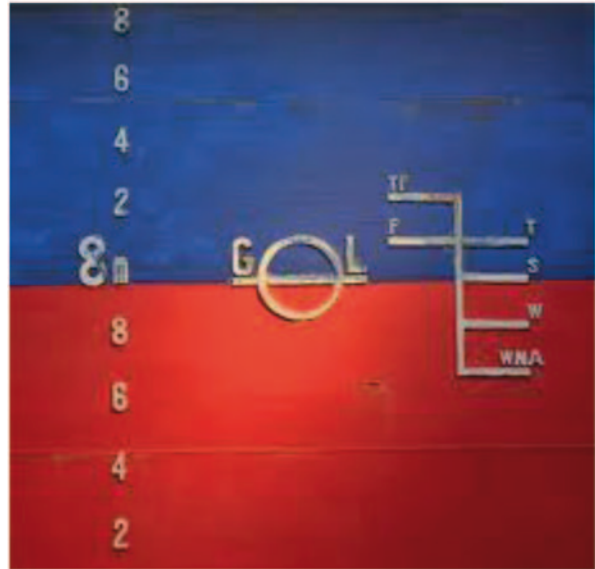
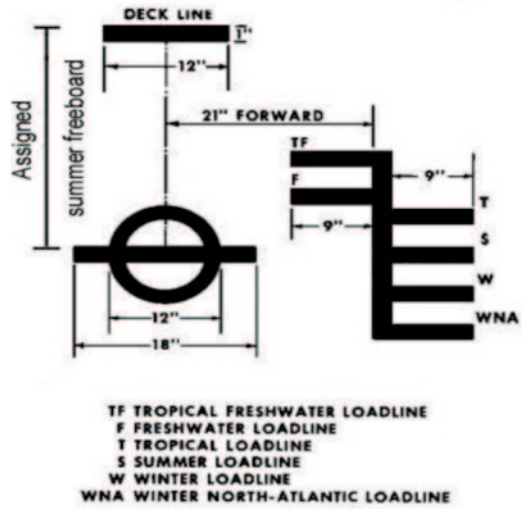

mentation of the load line regulations in practice (control of the “actual” freeboard, *Plimsoll’s* mark, Fig. 2.114) relies on the reliability of the various inspection bodies (local port/coast guard authorities); bad ship operation and improper inspections may lead occasionally to disastrous consequences (accidents from overloads of ships).

References

- Abicht W et al (1974) *Annalen der 75 Jahre Schiffbautechnische Gesellschaft (STG)*, p 187 ff.
- Alissafaki A (2013) Research on alternative methodologies in estimating the Energy Efficiency Design Index (EEDI) for Ro-Ro cargo ships & Ro-Ro/Passenger ships. MSc thesis, Ship Design Laboratory, National Technical University of Athens
- Antoniou A, Perras P (1984) Ship design—special chapters, (in Greek: Μελέτη του Πλοίου—Ειδικά Κεφάλαια). Rev. 2. Foivos, Athens
- Buxton IL (1976) Engineering economy and ship design. The British Ship Research Association (BSRA), 2nd edition
- Dudszus A, Danckwardt E (1982) *Schiffstechnik—Einführung und Grundbegriffe* (in German). VEB Technik, Berlin
- Friis AM, Andersen P, Jensen JJ (2002) Ship design (Part I & II). Section of Maritime Engineering, Dept. of Mechanical Engineering, Technical University of Denmark, ISBN 87-89502-56-6
- Froude W (1868) Experiments on the surface-friction experienced by a plane moving through water. In: British Association for the Advancement of Science Report, 42nd Meeting. (“Law of Comparison” in Memorandum to Mr. E. J. Reed, Chief Constructor of the Royal Navy, dated Dec. 1868, “The Papers of William Froude”, 1810-1879, RINA, 1955.)
- Germanischer Lloyd Ed. Board (2009) Rules and guidelines: I—ship technology, part 0—classifications and surveys, part 1—seagoing vessels, IACS Common Structural Rules and Complementary Rules, information on recent IMO legislation, publ. GL Hamburg (<http://www.gl-group.com>)
- Guldhammer HE (1979) CRS-diagrams for design calculations of the stability of ships. *Ocean Eng* 6(6):581–592
- Harvald SA (1984) Resistance and propulsion of ships. Wiley Interscience, Hoboken
- Henschke W (1964) *Schiffbautechnisches Handbuch* (in German) vol II. VEB Technik, Berlin
- Hollenbach U (June 1999) Estimating resistance and propulsion for single-screw and twin-screw ships in preliminary design. Proc. of the 10th ICCAS Conference, Cambridge
- Holtrop J (Nov 1984) A statistical reanalysis of resistance and propulsion data. *J Int Shipbuild Prog* 31(363):272–276
- Horn F (1930) Ship towing tests (in German: Schiffsschleppversuche), Sonderdruck aus *Handbuch der Experimentalphysik*, vol 4, part 3, Akademische Verlagsgesellschaft, Leipzig
- Kelvin L (1887) Ship waves, *Transactions Inst. Mech. Engineers*, London
- Koutroukis G, Pavlou A (2011) Innovative container ship design concept E-4, VISIONS European Academic Competition 3rd place, NTUA-SDL
- Holtrop J, Mennen GGJ (July 1982) An approximate power prediction method. *J Int Shipbuild Progr* 29(335):166–170
- IHS (2011) Fairplay World Shipping Encyclopedia version 12.01. <http://www.ihs.com/products/maritime-information/ships/world-shipping-encyclopedia.aspx>
- International Convention on Load Lines ICLL (1988) IMO Protocol relating to the International Convention on Load Lines 1966
- International Maritime Organization, IMO (2008a) MSC.1/Circ.1281 Explanatory notes to the international code on intact stability
- International Maritime Organization, IMO (2008b) Res. MEPC.173(58) Guidelines for ballast water sampling (G2)
- International Maritime Organization, IMO (2008c) Res. MSC.267(85) Adoption of the International Code on Intact Stability (2008 IS CODE)
- International Maritime Organization, IMO (2013a), MARPOL 73/78, Consolidated Edition 2013
- International Maritime Organization, IMO (2013b) SOLAS, Consolidated Edition, 2013, Consolidated text of the International Convention for the Safety of Life at Sea, 1974, and its Protocol of 1988: articles, annexes and certificates
- International Towing Tank Conference (2008) ITTC symbols and terminology list, version 2008. <http://itcc.sname.org>
- Kelvin Lord (1887) Ship Waves, *Transactions Inst. Mech. Engineers*, London

- Lamb T (ed) (2003) Ship design and construction. In: SNAME, revision of the book: D'Arcangelo AM (ed) (1969) Ship design and construction. SNAME, New York
- Lewis EV (ed) (1988) Principles of naval architecture, Vol I—III. In: SNAME, revision of the book: Comstock DP (ed) (1967) Principles of naval architecture. SNAME, New York
- Loukakis T, Perras P (1982) Ship hydrostatics and stability (in Greek: Υδροστατική & Ευστάθεια Πλοίου). Sellountos, Athens
- Meier-Peter H, Bernhardt F (eds) (2009) Compendium marine engineering: operation-monitoring-maintenance. Seehafen, Hamburg (5.1.2, ISBN 978-3-87743-822-0)
- Paik JK, Kim DK, Kim MS (2009) Ultimate strength performance of Suezmax tanker structures: pre-CSR versus CSR designs. *Int J Marit Eng* 151, Part A2, 2000
- Papanikolaou A (1982) Buoyancy and stability—floating and underwater vehicles (in English) University Lecture Notes, Look Lab. Rep. No. 52, University of Hawaii
- Papanikolaou A (2002) Developments and potential of advanced marine vehicles concepts. *Bulletin of the KANSAI Society of Naval Architects*, no. 55, pp 50–54
- Papanikolaou A (2004) Entwurf und Sicherheit von Ro-Ro Fähren, *Handbuch der Werften, Band XXVI* (in German)—Design and Safety of Ro-Ro Passenger Ships. Lecture notes (in English), postgraduate school, Kasetsart University-Bangkok, EU Programme ASIA link ASI/B7-301/98/679-044
- Papanikolaou A (2009a) Ship design—methodologies of preliminary ship design (in Greek: Μελέτη Πλοίου—Μεθοδολογίες Προμελέτης Πλοίου). SYMEON, Athens, Vol 1, ISBN 978-960-9600-09-01 & Vol. 2, ISBN 978-969-9400-11-4
- Papanikolaou A, Anastassopoulos K (2002) Ship design and outfitting I (support course material), rev. 2 (in Greek: Μελέτη και Εξοπλισμός Πλοίου I, Μεθοδολογία Προμελέτης, Συλλογή Βοηθημάτων) National Technical University of Athens, Athens
- Rawson KJ, Tupper EC (1994) Basic ship theory, vols I & II, 4th edn. Longman, Scientific & Technical (in Greek. edited by Papanikolaou, NTUA 2002)
- Schneekluth H (1985) Ship design (in German). Koehler, Herford
- SOLAS (2009) International Maritime Organization, IMO, SOLAS, Consolidated Edition, 2009, ISBN: 978-92-801-1505-5
- Strohbusch E (1971) Entwerfen von Schiffen I—IV. University Lecture Notes (in German), Technical University Berlin
- Tagg R, Bartzis P, Papanikolaou A, Spyrou K, Luetzen M (July 2001) “Updated Vertical Extent of Collision Damage”, *Proc. 2nd Int. Conf. On Collision and Grounding of Ships*, Copenhagen
- Taylor DW (1943) Speed and power of ships. Wiley, New York
- Völker H (1974) Entwerfen von Schiffen (in German) *Handbuch der Werften*, vol XII, HANSA. Hamburg
- Watson D (1998) Practical ship design, Elsevier Ocean Engineering Book Series, ISBN 0080429998
- Watson DGM, Gilfillan AW (1976) Some ship design methods. *Trans. RINA*, London, pp 279–324

Chapter 3

Ship's Hull Form

Abstract A fundamental task of the ship designer is to develop the best possible hull form on the basis of certain known (preliminarily determined) dimensions and integrated hull form characteristics, such as ship's length L , beam B , draft T and hull form coefficients, slenderness ratio, etc., considering the following fundamental factors/criteria:

a. **Resistance and Propulsion in Calm Water**

Particular attention should be paid to:

- Superposition/tuning of the generated transverse, ship-bound wave systems, namely of the bow, the stern, and the shoulder wave systems (see Sect. 2.3.1).
- Favorable/smooth flow around stern shoulders and avoidance of flow separation (causing increased eddy resistance).
- Favorable/smooth incident flow to the propeller and rudder.

Comment: Besides ship's hull form, the resistance of a ship is significantly influenced, by ship's main dimensions L , B , and T , her displacement and its distribution, as well as the mutual relationships thereof (ratios of main dimensions, slenderness ratio). Therefore, possible mistakes in choosing the proper values for the above dimensions cannot be corrected even with very careful shaping of the vessel's hull.

b. **Stability/Floatability in Intact and Damage Condition:** Is strongly influenced by the form of the waterplane area (C_{WP}), the form of sections below and above still water level (SWL), the type of the stern, etc.

c. **Seakeeping Performance/Behavior in Waves:**

Particularly with regard to:

- Ship motions and loads in waves
- Slamming phenomena and emergence of propeller (propeller racing)
- Added resistance in waves
- Roll motions and dynamic stability, likely capsize/foundering in waves
- Bow diving and deck wetness phenomena (*green water*) by high waves

The above listed phenomena are affected in addition to the main dimensions, particularly by:

- Displacement (total ship's weight and its distribution)

- Coefficients C_B and C_P
- Longitudinal center of floatation (LCF)
- Sections' form character above design waterline (particularly at the bow) and freeboard/bow height
- Bow/stern form

d. Maneuvering Capabilities:

Concerning in particular the following ship properties:

- Course keeping
- Maneuverability

Influenced by:

- Lateral plane projected area of ship's hull below waterline (value of $a \cdot L \cdot T$ and centroid of this area).

e. Volume of Holds/Cargo:

It is referring to:

- Dimensions of holds' spaces
- Position of holds' openings/hatches
- Available volume of holds

It is affected particularly by:

- Coefficients C_B , C_{BD} (C_B at the level of D), and C_M
- Length of parallel body
- Sections' form/character

f. Construction Aspects and Cost:

Is relating to:

- Simplicity and ease of construction
- Construction cost

and is influenced basically by the same factors as stated above for the volume of holds (see (e)).

In the framework of development of a ship's hull form the determination of the following *quantities* is additionally required:

- Longitudinal position of the buoyancy center and the center of floatation
- Vertical position of buoyancy center
- Length of vessel's parallel body
- Length of entrance/run and angle of entrance/run (slope) of sectional area curve.

In the same context the following *qualitative* characteristics of the vessel's hull are determined:

- Distribution of displacement, form of sectional area curve, and shape/profile of shoulders
- Character and form of sections of wetted and above waterline hull form

- Character and form of the design waterline (DWL) and waterlines around DWL
- Shape of the bow part of the vessel
- Shape of the stern part of the vessel
- Configuration of deck's sheer and determination of freeboard height

3.1 Distribution of Displacement

The distribution of displacement in the longitudinal direction is an important factor affecting the resistance of a ship.

From the preliminary stages of design, it is considered that the main dimensions L , B , T , and the displacement ∇ are known. The distribution of the displacement is expressed by the longitudinal sectional area curve, given that the area under this curve is equal to the displaced volume and its longitudinal extent equal to the length of the vessel (L , length between perpendiculars L_{pp}).

3.1.1 Shape of Sectional Area Curve

The sectional area curve (SAC) of the vessel's hull is directly related to the determination of the following values (see Fig. 3.1):

- Longitudinal position of center of buoyancy (LCB), which corresponds to the longitudinal centroid of the area under the curve SAC
- Parallel body length L_p , corresponding to the part of ship's length for which we have constant sectional area
- Length of entrance L_E and length of run L_R , which are defined as the corresponding lengths of the fore and abaft parts of the vessel's sectional area curve, with gradually decreasing sectional areas, moving from amidships toward the ends.

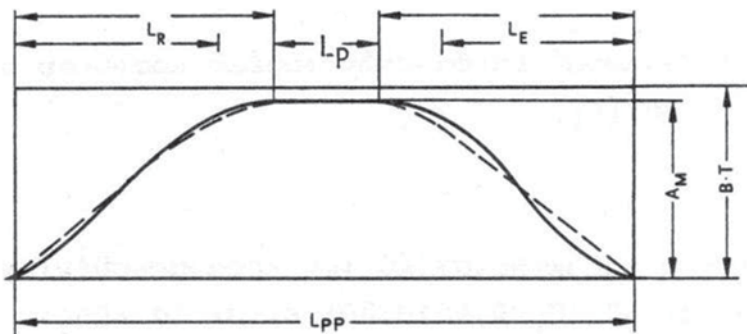

Fig. 3.1 Distribution of sectional area (SAC) and definitions

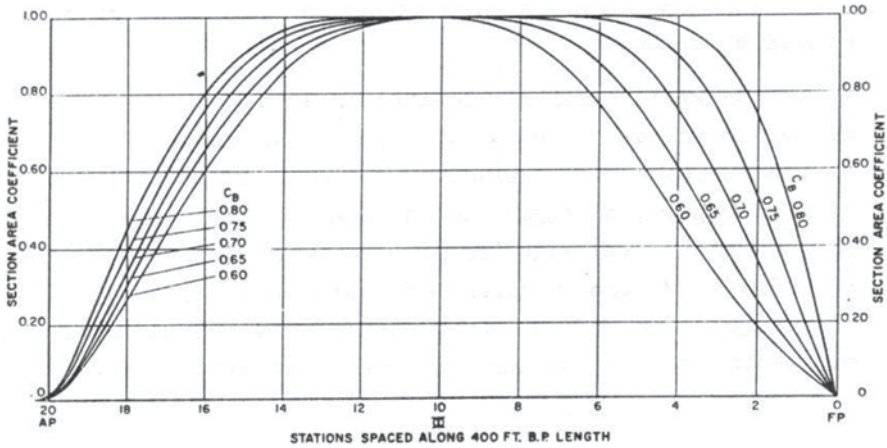

Fig. 3.2 Distribution of sectional areas of DTMB model Series 60 (Lewis 1988)

The beginning of the length of entrance is approximately at the fore end of the parallel body (forward shoulder), whereas the corresponding length of run is measured from the aft end of the parallel body (astern shoulder). Obviously,

$$L_P + L_E + L_R = L_{PP}$$

- Angle of entrance of the sectional area curve at the forward perpendicular i_E (see Fig. 3.2; Table 3.1) or the ratio t according to Taylor (see Fig. 3.8)
- Angle of run of the curve at the aft perpendicular

A characteristic example of sectional area curves (displacement distribution) of the well-known Series 60 ship models (David Taylor Model Basin DTMB—USA) is given in Fig. 3.2.

The corresponding basic geometric features of the above Series 60 hull forms ($C_B=0.60-0.80$) are as follows:

Observing the characteristics of the above figure of the sectional area curve of Series 60 models and the data listed in Table 3.1 we note the following:

- a. High block coefficients, for example, $C_B=0.80$, are accompanied by low slenderness coefficients $L/\nabla^{1/3}$ and longitudinal center of buoyancy LCB forward of the midship section (optimum position 2.7% L_{PP} forward of midship section), while the corresponding Froude number of similar hull forms (slow cargo ships) is relatively low.
- b. Low block coefficients, for example, $C_B=0.60$ (fast cargo ships, passenger ships) are accompanied by high slenderness coefficients and LCB aft of the midship section (optimal position 1.69% L_{PP} behind the midship section). The corresponding Froude number is here relatively high.

Table 3.1 Particulars of Series 60 models

| | | | | | |
|---|---|---|---|---|--|
| C_B | 0.60 | 0.65 | 0.70 | 0.75 | 0.80 |
| C_M | 0.978 | 0.982 | 0.986 | 0.990 | 0.994 |
| C_P | 0.614 | 0.661 | 0.710 | 0.758 | 0.805 |
| L/B | 6.50-8.50 | 6.25-8.25 | 6.00-8.00 | 5.75-7.75 | 5.50-7.50 |
| B/T | 2.5-3.5 | 2.5-3.5 | 2.5-3.5 | 2.5-3.5 | 2.5-3.5 |
| $L/\nabla^{1/3}$ | 5.60-7.50 | 5.32-7.16 | 5.05-6.84 | 4.79-6.55 | 4.55-6.27 |
| $\Delta/(L/100)^3$ | 67.8-162.4 | 78.0-190.3 | 89.3-222.4 | 102.0-259.3 | 116.2-302.4 |
| ⊙ | 6.20-7.20 | 6.03-7.04 | 5.90-6.98 | 5.78-6.88 | 5.71-6.84 |
| L_p , pct L_{PP} | 0 | 3.5 | 11.9 | 21.0 | 30.0 |
| LCB, as pct of L_{PP} from $\overline{\overline{AB}}$ | 2.48A to 0.52F (optimum 1.69A) | 2.46A to 1.37F (optimum 1.01A) | 2.05A to 2.55F (optimum 0.25A) | 0.48F to 3.46F (optimum 2.60F) | 0.76FA to 3.51F (optimum 2.70F) |
| i_E° | 6.2-8.7 | 7.3-9.6 | 9.7-12.9 | 19.8-25.9 | 38.9-47.8 |

Δ displacement in long tons

⊙ = $S/\nabla^{2/3}$ wetted surface coefficient

L_p parallel body length of the vessel

LCB longitudinal position of center of buoyancy ($\equiv \overline{\overline{AB}}$)

i_E° angle of entrance of sectional area curve at the fore perpendicular

3.1.2 Longitudinal Centre of Buoyancy (LCB)

a.1. Effect on Resistance and Propulsion The longitudinal position of the buoyancy center expresses the degree of concentration of the lengthwise distribution of ship's displacement. This, in combination with the prismatic coefficient and the slenderness coefficient of the vessel, affects directly the generation and intensity of the ship-bound wave systems at the fore and aft shoulders.

It is evident that a position of center of buoyancy too much in front of the amidships triggers the generation of intensive waves around the bow shoulders, whereas, on the contrary for an extreme position aft of amidships the risk for flow separation and creation of vortices in front of the propeller is increased, which has negative effects on the propulsive efficiency (see Sect. 2.3.1).

Consequently, by determining the longitudinal center of buoyancy, it is attempted to control the superposition of the locally generated, secondary ship-bound wave systems and particularly of the systems of the bow (with that of the fitted bulbous bow, if any) and those of the shoulders. This applies mainly to fast vessels associated with comparatively high values of wave resistance.

The recommended optimal values for the longitudinal center of buoyancy, which have been derived from systematic experiments or numerical investigations, generally tend toward the stern, as the Froude number increases or the hull coefficient decreases (see Fig. 3.3 by Danckwardt (qualitative optimal $LCB = f(C_B)$), Figs. 3.4 and 3.5).

Overall, for Froude numbers $F_n = 0.22-0.25$, the optimum position is around amidships and more forward, whereas for $F_n = 0.30$ and higher, the optimal location

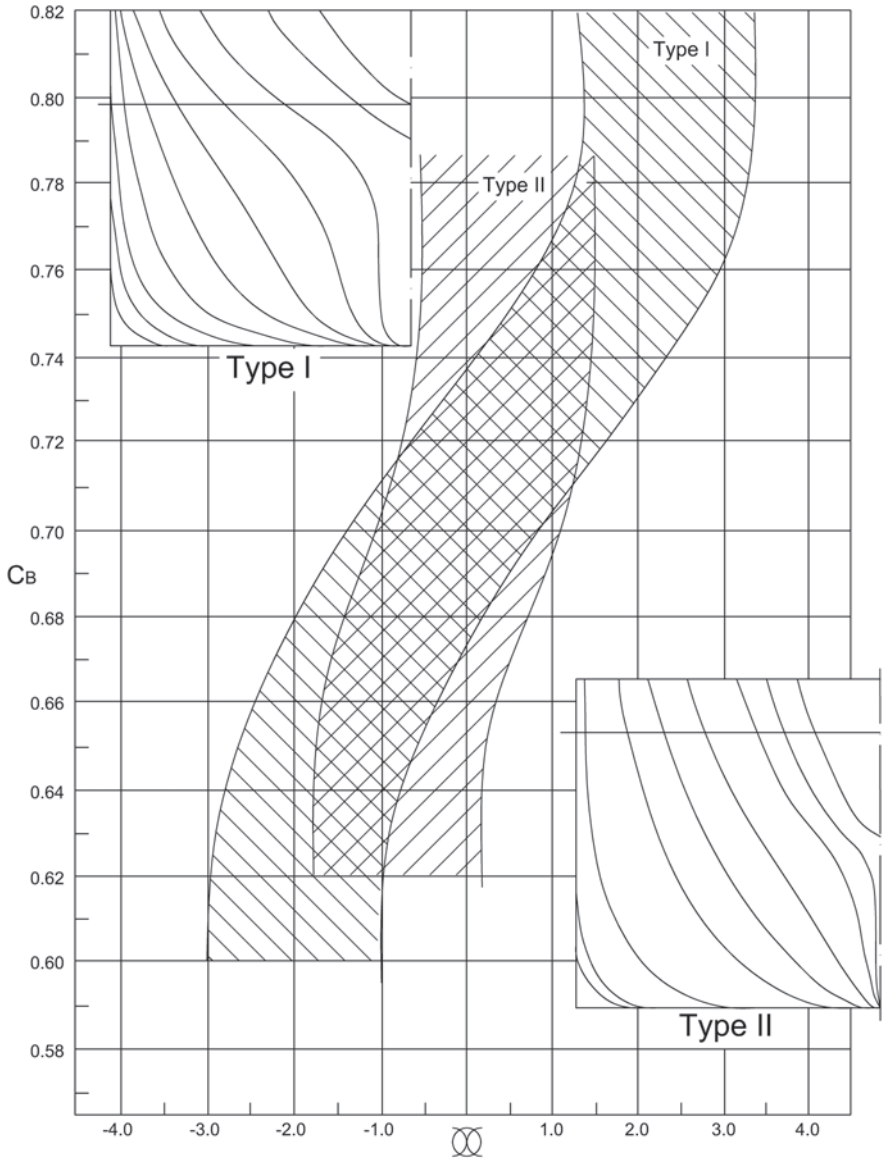

Fig. 3.3 Optimal position of the longitudinal center of buoyancy by Dankwardt (Dudszus and Dankwardt 1982) versus C_B and sectional form type

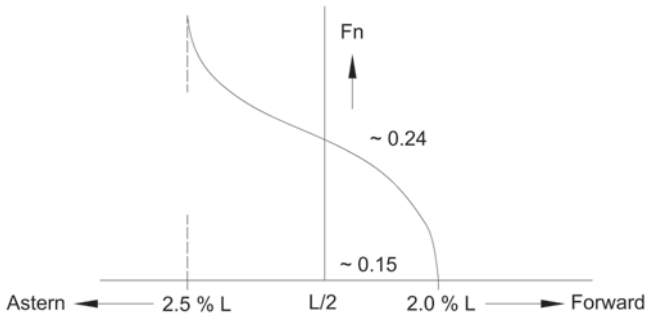

Fig. 3.4 Sketch of approximate optimal position of longitudinal center of buoyancy versus Froude number (qualitative relationship)

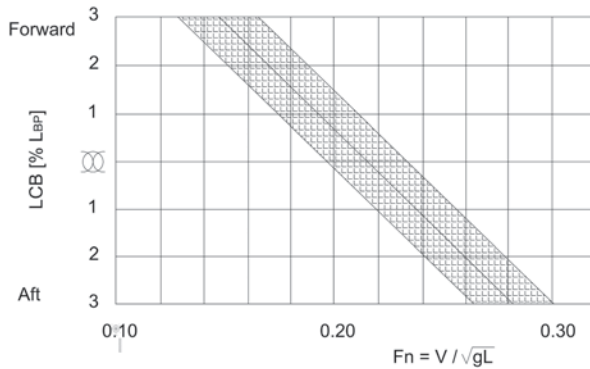

Fig. 3.5 Approximate optimal longitudinal position of center of buoyancy vs. Froude number according to Gulddammer-Harvard (1974)—Hull form series FORMDATA (Friis et al. 2002)

moves to the aft. Thus, depending on the prismatic coefficient, LCB reaches values of -2.5% to -3.0% L_{pp} aft of amidships, whereas for $F_n \cong 0.15$, the optimal position is approximately $+2.0\%$ L_{pp} forward of amidships. Analogous values result from observations of comparable data of the systematic series of Series 60 models (see Table 3.1), the hull form series of Wageningen-Lap and FORMDATA.

a.2. Effect on the Exploitation of Holds The exploitability of hold spaces, particularly regarding the stowage of *break* cargo, is influenced negatively by an extremely aft position of the buoyancy center, when accompanied by low block coefficients. In addition the stowage is affected adversely by sharply formed cross sections (e.g. V type sectional forms) associated with insufficient floor area at the bottom.

a.3. Effect on the Trim For ships with the engine room abaft, a buoyancy center position intensely forward can lead to severe difficulties to control the trim for certain loading conditions, e.g. for the ballast condition (with resulting strong stern trim) or for loading conditions at the end of the voyage (fuel tanks empty), or for

uneven distribution of ship's weight, of cargo and fuel. The problem can be generally addressed with appropriate ballasting, assuming sufficient ballast tanks along ship's length.

a.4. Conclusions The process of assessing and determining ship's LCB should be as following:

1. Estimation of the desired LCB based on the least resistance criterion.
2. Configuring the general arrangement of the ship so that the longitudinal gravity/mass center LCG of the ship is close to the desired LCB, i.e., $LCG \cong LCB$.
3. If step 2 requires significant changes in the general arrangement, the mutual approach of LCG and LCB is recommended with the simultaneous change of the distribution of weights and distribution of displacement (i.e., of LCB).
4. In practice, due to the different loading situations, continuous changes of LCG and LCB and the establishment of trim during ship's operation are inevitable. Aft/stern trim is acceptable if it does not exceed certain limits (see, e.g., MARPOL regulations for tankers $t_A \leq 0.015 L$ in the extreme ballast condition, which ensures sufficient immersion of the propeller). It is true that with the introduction of a bulbous bow, as a way of reducing ship's wave resistance (see Sect. 3.4), the volume of forepeak tank is increased, thus large ballast water space and sufficient trim moment are disposed for the balance of stern trims. This is particularly evident for ships with the engine room astern and LCB forward of amidships (e.g., tankers and bulkcarriers).
5. General approach to the positioning of LCG by redistribution of cargo and avoidance of severe LCG changes:
 - a. Consider the carriage of relatively heavy cargo in the middle part of the vessel. This is achieved by:
 - Forming the bow without sheer, having short forecastle and no cargo hold in the bow region
 - Placement of the bow collision bulkhead as abaft as possible (at the limit of the Classification Societies' requirements)
 - Considering higher double bottom at the forward cargo holds
 - Selecting compact propulsion plant with small required area/volume of machinery and installation of the fore engine bulkhead to the aft as possible
 - b. Disposal of ample spaces for supplies and fuel, beyond the minimum values, for the flexibility to carry fuel and supplies at various longitudinal positions as to easier balance undesirable trims in the operation of the ship due to fuel consumption etc.
 - c. For particularly heavy cargos, such as ores or crude oil, since some holds may be left empty (ore carriers), the position of the LCG can be effectively controlled with a corresponding redistribution of the cargo load. However, this is almost impossible in practice for break bulk, general cargo ships and box type cargo carriers, as their cargo in principle is transported as homogeneous cargo without differentiation of weights, except for heavy cargo units.

6. It is an established opinion of experts that the empirically recommended optimal LCB values for ships *without* a bulbous bow can be also applied to ships *with* a bulb. For ships with very protruding bulbs in front of the forward perpendicular, Schneekluth (1985) proposed the shift of the optimum LCB obtained for ships without a bulb ahead of the original optimal position by 50% of the protruding length of the bulb.

3.1.3 Parallel Body Length (L_p)

The parallel body length (L_p) of the ship is defined as that part of the ship length for which the sectional area curve is constant, i.e., horizontal, around the middle of the ship.

b.1. Effect on Resistance As a general rule, an increase of the parallel body extent causes a relatively sharp expansion of the sectional area curve when moving from the ends toward the midship; this is also visible in the corresponding shiplines of the hull (sharp shoulders). For a given displacement, an increase of L_p implies an increase of the prismatic coefficient C_p and hence of the resistance, especially of the wave resistance component. However, for low speeds/Froude numbers, due to the significant frictional part of the total resistance, which is not much affected, the effect of L_p on the required propulsion power is relatively small.

b.2. Effect on the Construction and Exploitation of Hold Spaces It is obvious that the construction of the parallel body of a ship is simple and hence economical, due to the possibility to use identical structural elements (plates, stiffeners, 3D building blocks) for a significant part of the ship's volume and this facilitates automatized production procedures.

The exploitation of hold spaces in ship's parallel body proves optimal, because of the almost rectangular cross-section of the parallel body, with small curvature radii at the bilge region and hardly any elevation at the bottom.

b.3. Conclusions—Recommendations

1. Generally the consideration of a parallel body for a ship under design is only recommended for low Froude numbers ($F_n \leq 0.24$).
2. The recommended/proposed L_p length increases as the Froude number reduces. Simultaneously, the recommended longitudinal buoyancy center LCB moves forward and the parallel body length L_p extends more to forward than to aft Fig. 3.6.
3. Approximate empirical L_p values

AYRE

$$\begin{aligned} F_n = 0.245 &\Rightarrow L_p = 0 \\ &= 0.15 \Rightarrow L_p \cong 0.47L \end{aligned}$$

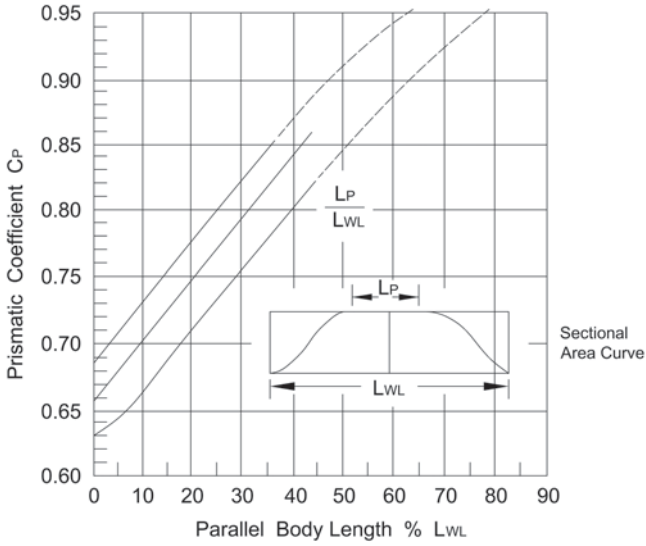

Fig. 3.6 Parallel body length versus prismatic coefficient C_p

German Schiffbaukalender (1942)

$$F_n = 0.255 \Rightarrow L_p = 0$$

For low $F_n \Rightarrow L_p$ up to $0.32L$

Series 60

$$C_B = 0.60, L_p = 0$$

$$C_B = 0.65, L_p = 0.035L$$

$$C_B = 0.70, L_p = 0.110L$$

$$C_B = 0.75, L_p = 0.210L$$

$$C_B = 0.80, L_p = 0.300L$$

Statistical Data

Slow cargo ships

$$L_p = 0-0.10 L$$

Tankers and bulk carriers

$$= 0.30-0.40 L$$

Coasters

$$= 0.10-0.15 L$$

Other ships

without a parallel body

4. A designer must pay attention to the difference between ship's *parallel body* and the *parallel section of the design waterline* (see Chap. 4).

3.1.4 Length of Entrance (L_E) and Length of Run (L_R) of the Sectional Area Curve

The length of entrance (L_E) and length of run (L_R) of the sectional area curve determine approximately the position of the forward and astern shoulders of the ship and the following is obvious:

$$L_E + L_P + L_R = L_{pp}$$

The following figure shows the recommended values of L_E , L_P , and L_R by Lindblad, as well as their relative position with respect to amidships versus the prismatic coefficient C_p (for $L/B=7$) (Fig. 3.7).

As long as the L/B ratio is less than 7, the decrease of L_P is recommended, i.e., for $L/B=6.7$ a reduction by about 3% is recommended. The same applies to higher Froude numbers. However, the figure is not suitable for general use because of the many involved parameters.

c.1. Influence on Resistance The basic principle for selecting the length of entrance L_E is the minimization of the generated transverse *bow Kelvin type wave system* (starts with a crest at the bow) through the superposition with the corresponding system of the bow shoulder (starts with trough).

The ultimate objective is certainly to reduce the wave resistance. Thus, we obtain due to the relationship (see Sect. 2.3)

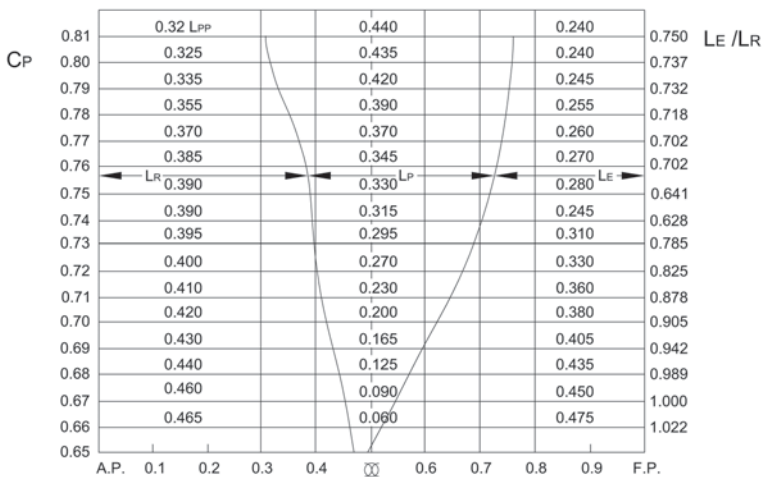
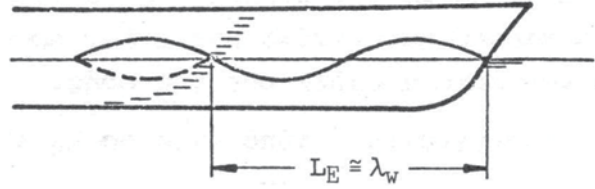

Fig. 3.7 Lengths of entrance, run and parallel body of sectional area curve versus prismatic coefficient C_p by Lindblad (for $L/B=7$)

Fig. 3.8 Superposition of bow and fore shoulder wave systems for $L_E \cong \lambda_w$



$$L_E/L = \lambda_w/L = 2\pi F_n^2$$

where λ_w : length of generated waves $= (2\pi/g)V^2$, V : ship speed

or

$$\text{for } L_E/L = 0.16, 0.25, 0.42,$$

$$F_n = 0.16, 0.20, 0.26.$$

With the same reasoning the superposition of the forward shoulder wave system with that of the stern shoulder could be attempted, i.e., the following should apply

$$(L_E + L_P)/L = \lambda_w/L = 2\pi F_n^2$$

However, the effect of this superposition will be not particularly drastic, because of the highly faired/streamlined stern shoulder to avoid the flow separation in the stern region.

It is recalled that, in the above elaborations the corresponding lengths apply only to a *single design speed*, due to the direct relationship between length of the generated waves and ship's speed.

In the course of the selection of the length of run L_R , we should attempt to avoid pronounced hull form changes at the stern and aim at a relatively smooth stern shoulder, thus as large L_R as possible should be aimed, to avoid high eddy resistance due to flow separation. Known approximation semi-empirical formulas for L_R are:

$$L_R = 4.08\sqrt{A_M} \text{ (by Baker)}$$

$$L_R = 3.2 \cdot \sqrt{B \times T} / C_B \text{ (by Alsen)}$$

c.2. Conclusions

1. Shaping of forward shoulder: It is recommended to avoid pronounced hull extrusions for deliberately triggering an intense forward shoulder wave system that could be superposed to the generated bow wave for wave attenuation at a single speed, as this might lead to a severe tuning of the wave systems at other speeds.
2. Shaping of stern shoulder (hip): A smooth hull shape at the stern shoulder is recommended for all types of ships, in particular for bulky ships (tankers), to avoid the separation of streamlines in view of the resulting intense flow acceleration in transverse direction (leads to abrupt increase of pressure, flow separation and generation of eddies).

3.1.5 Angle of Entrance/Run of Sectional Area Curve

The definition of the angle of entrance of the sectional area curve is shown by the following figures for ships with and without the bulb. The angle of entrance is namely defined via the tangent to the sectional area curve at the fore perpendicular. The well-known ratio of entrance, introduced by D. Taylor is namely:

$$t = A_{FP} / A_M \text{ (ships without bulb)}$$

$$t = \frac{A_{FP} - A_B}{A_M - A_B} \text{ (ships with bulb)}$$

where

A_M : Area of midship section

A_{FP} : Height amidships of the tangent to the sectional area curve at the fore perpendicular amidships (see Fig. 3.9)

A_B : Area (a fictitious area, see Fig. 3.9b) of bulb cross section at the fore perpendicular.

From classical theoretical considerations of the eminent German hydrodynamicist George Weinblum¹ and experimental results of D. Taylor, the qualitative diagram Fig. 3.10 was developed,² which relates the ratio t with the prismatic coefficient C_p .

Observing the Fig. 3.10, it is noted that in addition to the recommended high values (t) for large coefficients (C_p), an increase of t for small C_p coefficients (≤ 0.63) is also recommended (with $t \geq 0$, for $C_p \cong 0.63$), which may be interpreted as an indirect recommendation for fitting bulbous bows to fast vessels (reduction of wave resistance). The above are confirmed by the i_E^0 values for Series 60 models listed in Table 3.1.

Recommendations for the Entrance of the Sectional Area Curve (see Figs. 3.11 and 3.2)

1. For small F_n numbers (high C_p), a straight to convex entrance shape of the sectional area curve (vessels without bulbous bow) is recommended.
2. For high F_n numbers (low C_p), a concave form is proposed at the entrance, with a progressive shift of the curvature's inflection point aft wards, as the F_n number increases.

Recommendations for the Run of the Sectional Area Curve (see Fig. 3.2)

1. To avoid flow separation at the stern and an increase of the eddy resistance, a smooth as possible run of the sectional area curve is recommended.

¹ Georg Weinblum (1897-1974): Renowned German hydrodynamicist and former professor of ship theory at the University of Hamburg; before becoming professor in Hamburg after WWII he worked as researcher at the DTMB in Washington D.C; his main contributions are in the theory of ship's wave resistance and its relationship to ship's hull form, what has been considered as a first approach to modern numerical hull form optimization methods.

² The diagram is of historical value and is believed to have been developed after WWII. Source of information are the lectures of Prof. E. Strohbush on ship design (1971).

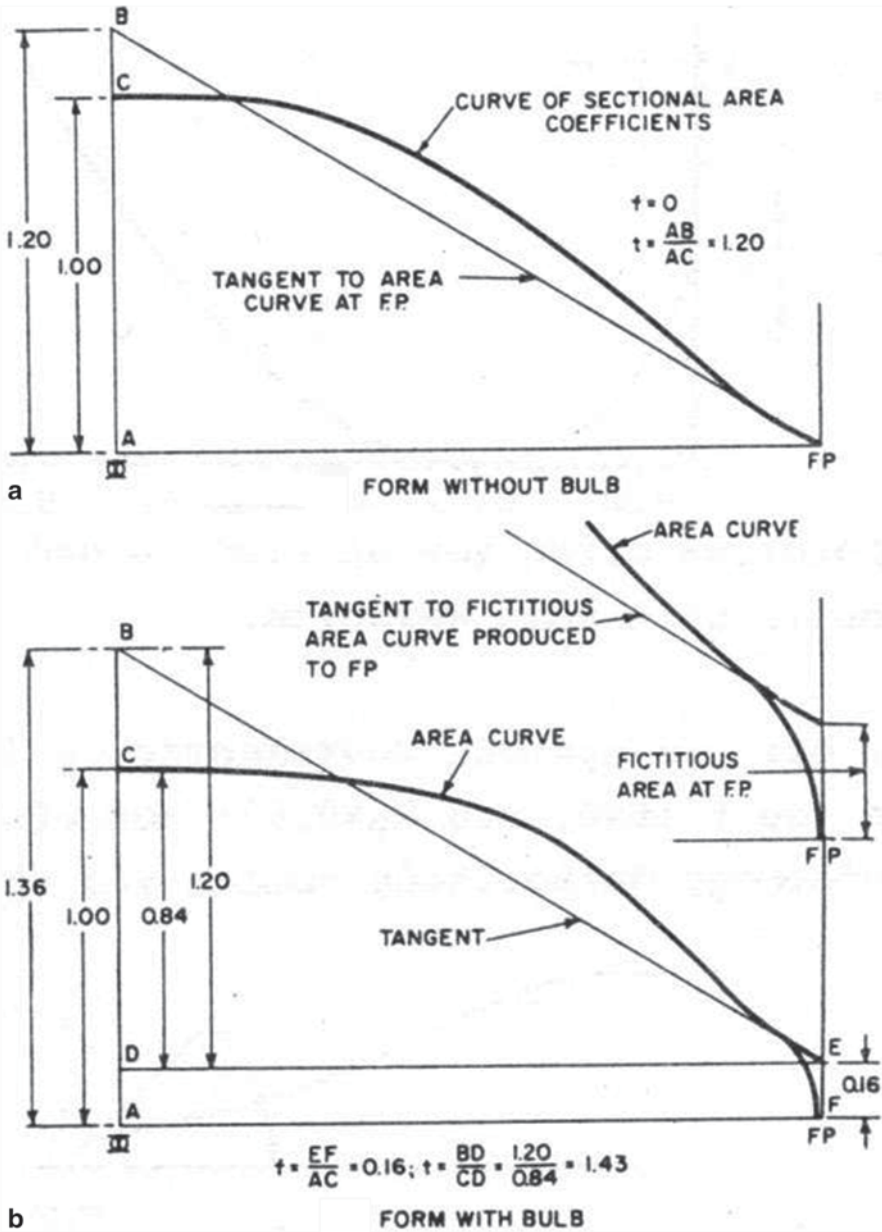

Fig. 3.9 Definitions of angle of entrance of sectional area curve for ships *without* (a) and *with* (b) bulb. (Lewis 1988)

Fig. 3.10 Qualitative relationship of optimal angle of entrance with the prismatic coefficient acc. to G. Weinblum

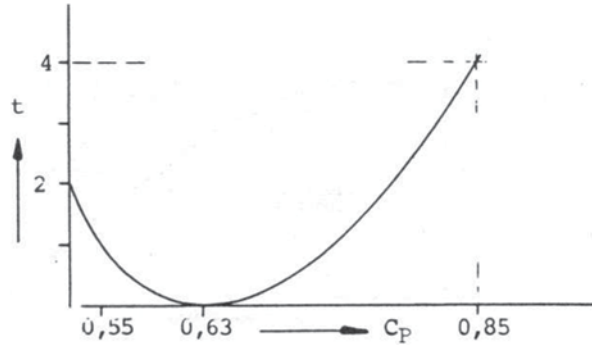
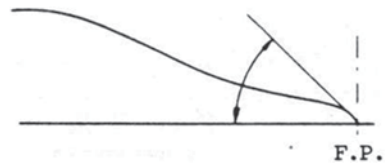

Fig. 3.11 Entrance of the sectional area curve



2. For low and moderate Froude numbers, a straight to slightly concave curve shape is suggested, while for high Froude numbers a more intense concave form resembling S is proposed.

3.2 Form of Waterlines

The relationship of the form of the design waterline (CWL or DWL: Construction and Design WaterLine) and indirectly of the neighboring waterlines (i.e., those parallel to the design waterline, but close to above/below it) to the other hull form curves of the ship, such as sectional area curve, the profile of bow and stern and the character of the sections (U or V) is obvious, even for fixed lengthwise distribution of displacement (given sectional area curve).

Criteria of Shaping of Waterlines

A. Hydrodynamic Aspects

a.1. Entrance of Design Waterline

- Low F_n numbers: convex form
- Medium and high F_n numbers: concave form
- Very high F_n : straight (large L/B for fast ships) to concave form (small L/B) (Fig. 3.12).

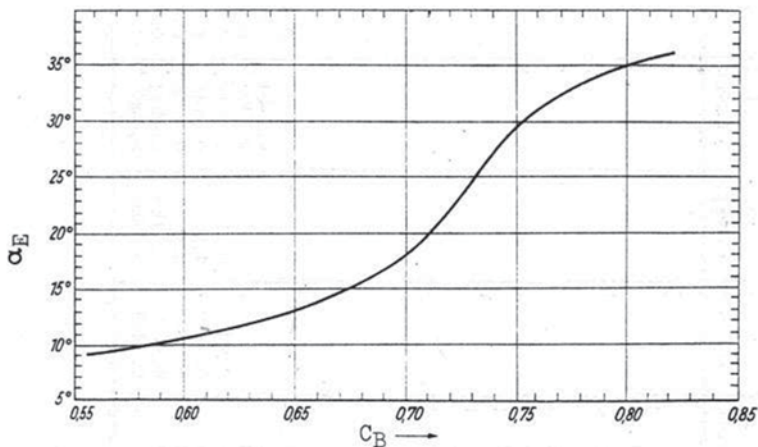

Fig. 3.12 Angle of entrance of design waterline $\alpha_E=f(C_B)$, Series 60

The angle of entrance of DWL should be approximately as follows (Heckser 1939):

| | | | | |
|--------------------|------|------|---------|------|
| C _p | 0.55 | 0.65 | 0.75 | 0.85 |
| α _E [°] | 8 | 10 | 21 ÷ 24 | 37 |

The above values apply to hull forms with L/B=7. For L/B ≠ 7, the angles can be corrected as following:

$$\tan(\alpha_E) = \tan(\alpha_E^*) \frac{7}{L/B}$$

where α_E^* : angle of entrance of waterline for L/B=7. It should be noted that modern ship hull forms with intense V sections at the bow have slightly higher α_E values than the proposed ones by Heckser. In addition, in recent years the new type of parabolic bow for low-speed bulky ships (tankers, bulk-carriers) has been developed, with nearly vertical entrance of the corresponding waterline ($\alpha_E \cong 90^\circ$, see Sect. 3.4).

a.2. Entrance of Neighboring Waterlines: With the exception of ships with bulbous bow, the angle of entrance of waterlines below the DWL must decrease, compared to that of the corresponding DWL, whereas, for the above DWL waterlines the angle gradually increases.

Nevertheless it should be noted that for certain types of ships, e.g., liner ships, which are seldom fully loaded, hence they do not sail at the design waterline, or for tankers in ballast condition, the shape of the waterlines near the DWL is as important as that of the design waterline.

Ships with bulbous bow are distinguished for their very small angles of entrance at the design waterline and the progressive increase of this angle above and below the DWL, particularly in the bulb region, where it reaches 90°.

a.3. Curvature Radius of DWL Entrance: While the design radius of curvature of the DWL entrance at the bow can be theoretically assumed very small to zero, in the actual construction/manufacturing a feasible, minimum radius of curvature will

Fig. 3.13 Bow panels closure at design waterline using stem-beams of circular cross section

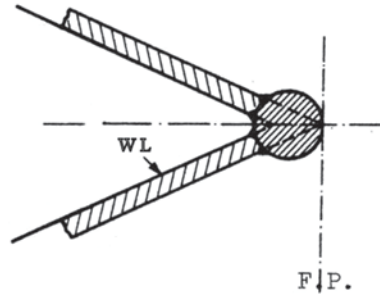

be practically achieved. This is in practice implemented by use of beams of circular cross section for the closure of the bow panels around the DWL (*stem* of the ship). The diameter of the cross section of these circular stem-beams can be 3–4 times the thickness of the plate panel ends (see Fig. 3.13).

The gradually increasing radius of curvature of the part of the bow above the design waterline can reach 4% B (for $C_B \cong 0.72$) at deck level, while significant excesses beyond this limit are not recommended due to possible slamming problems at the bow (in view of the resulting large sectional flare of the bow above the design waterline) and the associated increased hydroelastic structural loads/vibrations and the added resistance, when sailing in waves.

a.4. Run of Waterlines: To avoid flow separation and the generation of vortices in the aft ship section it is suggested by Baker that the angle of run of waterlines shall not exceed approximately 20° at any point of the waterline. Of course, this is practically not always possible, particularly for bulky ships; thus, a shift of the region with pronounced changes of the waterline’s slope to the aft as possible is recommended, in order to limit the extent of flow separation at the stern. This is expected particularly in case of ships with transom stern. As to the flow separation at ship’s stern it should be noted that the stern of single-propeller vessels is more favorable compared to that of twin-propeller ships. In addition, because the streamlines around ship’s hull follow primarily ship’s diagonals, and to a lesser degree the waterlines, it would be more appropriate to apply the aforementioned thoughts equally to the shaping of the diagonals.

a.5. Length of Parallel Body of Waterline:

| Typical values | $L_p(\text{CWL})/L_{pp}(\%)$ |
|------------------------|------------------------------|
| Fast cargo ships | 20–25 |
| Slow cargo ship | 30–35 |
| Coasters | 40–50 |
| Tankers, bulk-carriers | 50–60 |
| Reefers | 10–15 |
| Fast passenger ships | ~ 15 |
| Slow passenger ships | 20–25 |
| Ro-Ro passenger ships | 25–35 |
| Small ferry ships | 20–25 |
| Trawlers | 15–25 |
| Seagoing tug boats | $20 \div 30$ |

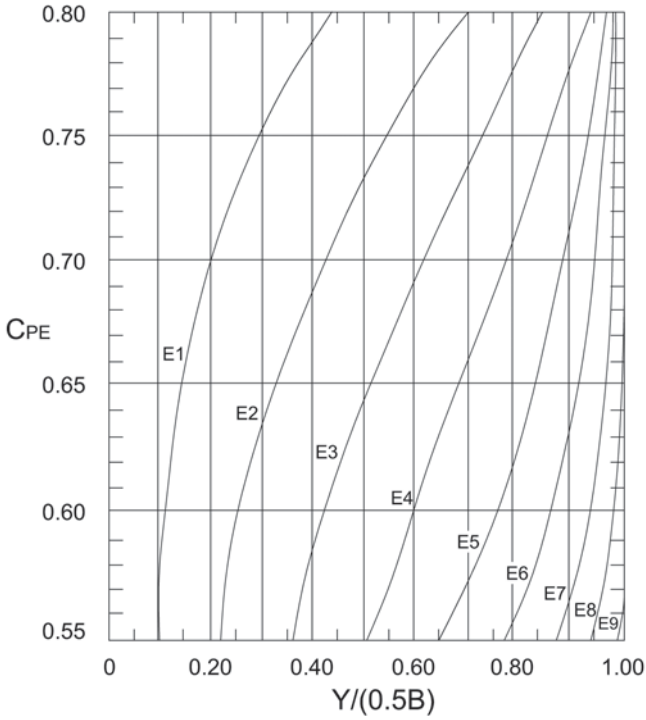

Fig. 3.14 Half-breadths of DWL vs. prismatic entrance coefficient C_{PE} , Series 60

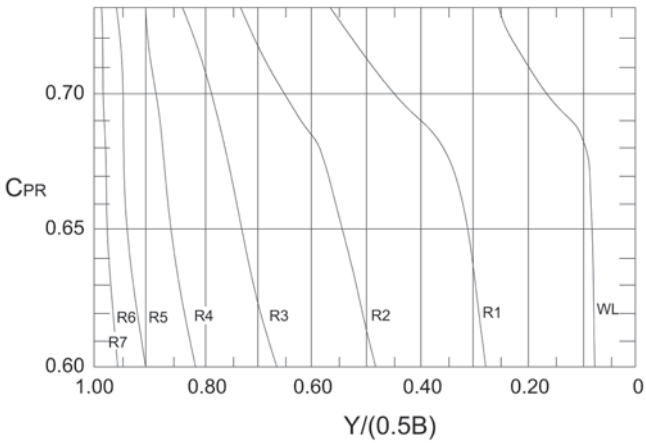
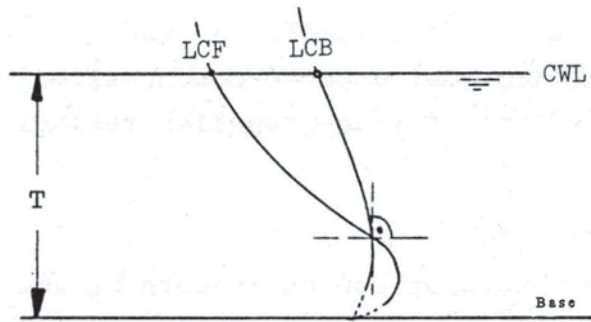

Fig. 3.15 Half-breadths of DWL vs. prismatic run coefficient C_{PR} , Series 60

Fig. 3.16 Qualitative variation of LCF and LCB with respect to ship's draft



a.6. Half-Breadths of Design Waterline, Series 60: In Figs. 3.14 and 3.15 the half-breadths of the waterlines for hulls of Series 60 are given as a function of the prismatic coefficients of entrance C_{PE} and run C_{PR} (Figs. 3.14 and 3.15).

a.7. Centroid of Waterplane Area—Center of Flotation (CF): The longitudinal position of the centroid of the design waterplane CF (center of flotation) is usually located astern of the center of buoyancy. In addition, depending on ship's draft, the longitudinal position of CF, compared to that of the center of buoyancy LCB, is generally more aft for the large drafts, while in relatively low drafts and waterlines this relationship is reversed (see Fig. 3.16).

The above elaborations are of special importance for the balance of the longitudinal moments that may arise for various loading conditions, bearing in mind that the axis of (hydrostatic) trim passes through the CF.

a.8. Waterplane Area Coefficient C_{WP} : It has already been discussed in Sect. 2.11.4.

B. Effect of CWL on Stability The effect of the waterplane area coefficient C_{WP} and of the form of CWL on the stability is well known from prior comments on the coefficient C_{WP} . In general, with an increase of C_{WP} (full type waterlines) improvements of the *form stability* are achieved due to the increase of the transverse moment of inertia (and of \overline{BM}), while for constant sectional areas and intense V-type sections we have simultaneously an increase of the vertical position of the center of buoyancy (\overline{KB}).

C. Influence of CWL on Trim and Seakeeping For small angles of trim and as long as the hydrostatic phenomena are concerned, the transverse axis of ship's trim passes through the center of flotation (CF). Hydrodynamic phenomena, as presenting with dynamic pitch motions when the ship is sailing in waves, depend also on the form of CWL. The axis of dynamic pitch is not easy to be determined (it is time-varying), although located near the axis of hydrostatic trim (CF) and in between to ship's mass center. The axis of pitch is of particular interest for the determination of the motions of bow (slamming phenomena) and stern (propeller racing phenomena).

Fig. 3.17 Basic types of ship sections

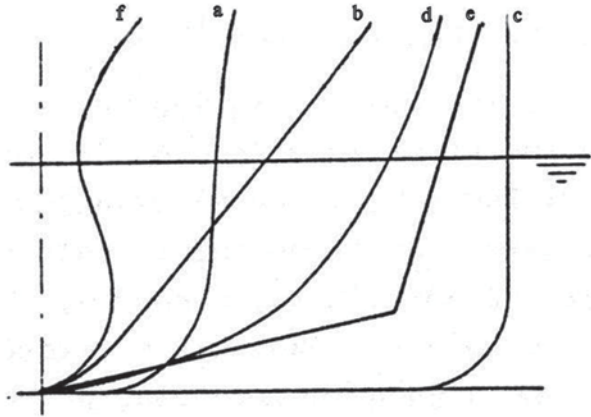

3.3 Form of Sections

Besides the prismatic coefficient C_p and the slenderness coefficient $L/\nabla^{1/3}$ the type of sections, i.e., the transverse sections of ship's hull, provides the essential character of the vessel's hull form.

3.3.1 Types of Sections

Typical examples of sections of modern ship types are sketched in the following Fig. 3.17.

The common classification of the various types of ship sectional forms is given in the following:

- a. U type
- b. V type
- c. Rectangular (midship sections)
- d. Circular type (nearly constant radius of curvature, for sailing yachts)
- e. Hard-chine (with one or two chines, application especially to high speed boats)
- f. Bulbous type (applications: to bow and stern region, but in older times also applicable to the midship section of passenger ships and warships).

3.3.2 Midship Section Form

- **General Comments:** Regarding the selection of the midship sectional area coefficient C_M , as well as of the bilge radius r_B and the deadrise d_R , relevant comments were made earlier in Sect. 2.11.

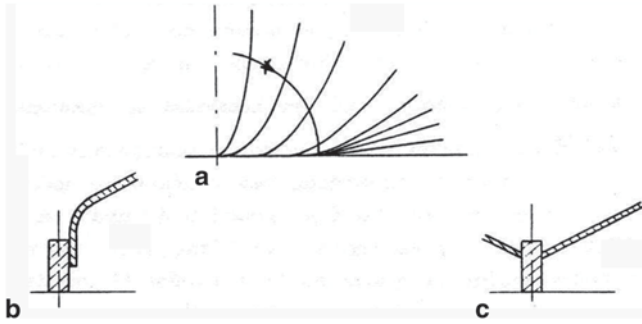

Fig. 3.18 Entrance ways of sections. a Flat keel. b Demanding vertical keel. c Simple vertical keel

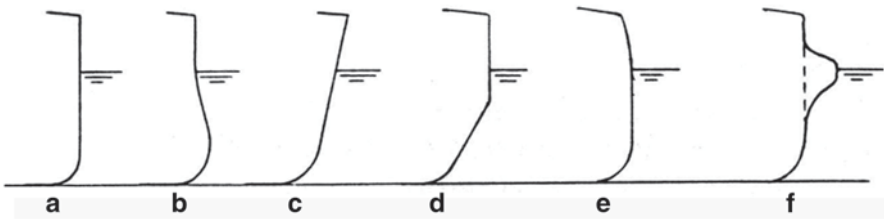

Fig. 3.19 Basic midship section forms

- **Entrance Ways of the Bottom of Midship Section:** For ships with a flat keel, (i.e., for all large ships) and elevated bottom (with deadrise) it is recommended that the deadrise starts from the edge of the keel (see Fig. 3.18a). In contrast, for small vessels, with vertical keel, it is appropriate to avoid demanding curvatures to the keel, because it will not improve significantly the flow around the keel, whereas it will cause difficulties in the construction/fitting of the keel (see Fig. 3.18b, c).
- **Sides of Midship Section (Fig. 3.19):**
 - a. Common midship section with vertical sides
 - b. Bulbous underwater section to improve the stability at small drafts according to the German Naval Architect Foerster (applied to old transatlantic passenger ships). Also, it offers the possibility of fitting additional underwater armor to the hull (old warships).
 - c. Flared V section (ferries, icebreakers, flare especially above the waterline)
 - d. V sections below the waterline and vertical sides at and above the waterline (applied to some containerships, see lines drawing of contemporary German containership, Sec. 3.4). They ensure reduced GM for small drafts, when this is desirable (for avoiding excessive transverse accelerations in seaway).
 - e. Retreating sections of tumble-home type above waterline; applied to old ocean liners and large passenger/ferry/cruise ships in general for weight savings

on superstructures, thus reducing/controlling the height of the weight center of the ship.

- f. Fitted sponsons around ship's waterline to improve ship's stability in cases of insufficiency after a ship's conversion (e.g. in cases of conversion of cargo ships to passenger ferry ships; also, old warships: armored shield against torpedoes).

3.3.3 Form of Bow and Stern Sections

General Comments

- **Relationship with the Midship Section/Body:** If the middle body section is full, the character of the sections at bow and stern may be U or V type according to the specific implemented criteria. On the contrary, a relatively sharp middle section of V type allows the connection to only V sections both at the bow and at the stern.
- **Relationship with the Shape of Bow and Stern:** The character of the bow and stern, e.g., the existence of a bulb at the bow/stern, or transom stern, affects only those directly neighboring sections, but without this influence to reach the middle body area.
- **Relationship with the Type of Ship:** For specific ship types characteristic section types have emerged, namely:
 - Ferries: Due to the requirement of large deck area pronounced V-type sections arise, both at the ends (stern and bow) of the vessel, as well as in less extreme form at the middle body region.
 - Tankers/bulkcarriers: In contrast to the ferries, the requirements for the deck area are not a decisive criterion for the design of the lines of tankers. Thus U sections with as possible vertical walls on the side are applied, allowing best use of enclosed spaces.

The relation of the hull form to the ship type is elaborated in the following:

- **Shaping of the sections' entrance ways at the bottom area:** The criteria for the shaping of the sections' entrance ways at ship's bottom are (sometimes contradictory effects):
 - Avoidance of generation of intense vortices
 - Positive influence on the damping of pitch and roll motions
 - Minimum wetted surface to minimize frictional resistance

The recommended design measures for the layout of sections' bottom entrances are:

- The way of arrangement of the sections in the bottom region
- The radii of curvature of the entrances of the sections
- The height of deadrise

In Fig. 3.20, illustrative examples of correct and wrong shaping of the sections' entrances are described in the spirit of above criteria.

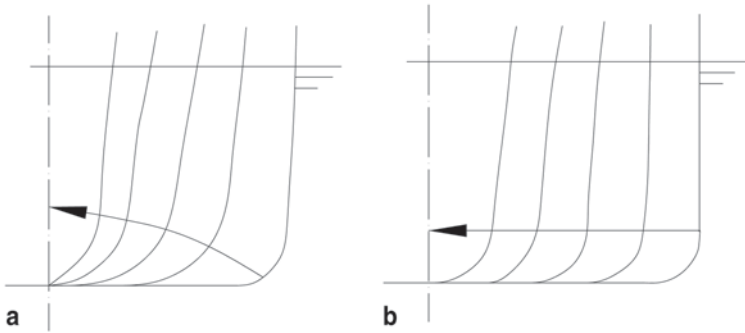
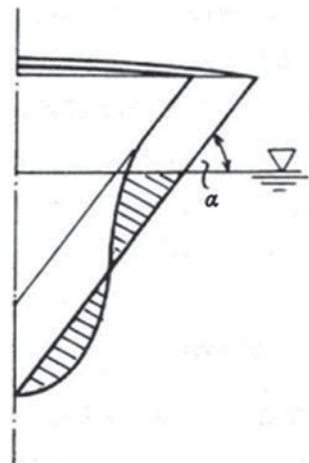

Fig. 3.20 Fictitious/virtual line of maximum curvature. Body plan: **a** Correct layout. **b** Wrong

Impact on Stability: Generally for fixed displacement, U-type sections lead to a smaller design waterplane area \overline{AW} , compared to the V-type sections. Thus they lead to smaller metacentric radii \overline{BM} . In addition, the vertical position of the center of buoyancy \overline{KB} is reduced, compared to the corresponding of V-type sections. In conclusion, for the same initial stability, i.e., the same \overline{GM} , ships with pronounced U sections require a higher B/T ratio (lower L/B), than those with V sections. It should be noted that for the same displacement, or the same displacement per meter section, the weight (mass) center \overline{KG} of a V section is higher than that of a U section, due to the positioning of significant steel mass higher up above the design waterplane. However, this negative effect regarding the stability properties of V type sections is overcompensated by the analog increase of the “form stability,” i.e., of \overline{KM} .

Impact on the Construction, the Exploitation of Space and Other Criteria: Comparing the two basic types of sections with character of U and V, of the same displacement per meter, the same draft and side depth (hence the same height of freeboard) and the same flare angle α (see Fig. 3.21), we observe the following:

Fig. 3.21 Comparison of bow sections of type U and V for the same underwater area and flare angle



Compared to an U-type section, the V-type section offers:

- Larger exploitable volume above the design waterline and larger deck area
- Relatively smaller side area of the shell (reduction of steel structure weight)
- Limited curved area of the plates (easier and more economical to construct)
- Larger reserve buoyancy
- Larger width at waterline (thus increase of \overline{BM} , see previous paragraph: “Effect on stability”)

The V-type section is inferior to U-type on the following criteria:

- Limited exploitable space below the waterline
- Creation of intense waves (intense free surface disturbance at waterplane) and generally increased wave resistance
- An increased height of center of gravity due to the transfer of significant steel mass above the waterplane. This is usually accompanied by increased weight centroids of superstructures and of equipment on deck
- Problems of slamming and seakeeping for pronounced sections V at the bow, when sailing in head waves
- Significant loss of waterplane area during the emergence of part of the vessel due to ship motions in waves (heave-pitch) or in the case of trim and/or in ballast condition.

3.3.4 *Bow Sections Below Waterline*

Effect on Resistance and Seakeeping For relatively slow vessels, due to high block coefficients, the need of applying relatively full sections with strong U character is apparent, especially in the bow section of the vessel. For relatively fast ships, the main requirement being to minimize the wave resistance, which is a significant part of the overall resistance, leads to shifting the displacement downward (well below the free surface), which means that again sections of U-type come to application. Even more, bulb-type sections are applied at the bow itself (see Sect. 3.4.2).

Vessels with relatively sharp midship section of type V (e.g., ferries, fishing boats) are distinguished for the V-type sections also at the bow part of the ship, despite the negative effect on wave resistance. Certainly, because of the relatively reduced wetted surface, the increases in wave resistance are partly balanced by the reduction of the frictional resistance.

The effect of the bow sections on ship's seakeeping performance (magnitude of wave induced ship motions, speed loss due to added resistance in waves, structural loads and loads on cargo, etc.) is significant. Because of the large local motions of the bow in waves about the mean waterplane, a proper configuration of the bow sections considering only the wetted part is not sufficient; rather the form of the whole section up to the deck must also be taken into account. For relatively small drafts of the bow, as they present in ballast operational conditions, it has been shown that full U-type sections with large projected bottom area may lead to severe slamming phenomena. For larger drafts it shows that the decay of ship's roll motion is more

drastic with V sections, than with U sections. However, strong above waterline section flares cause slamming at the bow sides of the ship and severe structural loads/vibration phenomena. Thus the combination of less pronounced sections of U and V type are regarded as the appropriate solution to serve the above, partly contradicting hydrodynamic criteria.

Other Criteria:

- Exploitation of spaces
- Stability
- Simplicity of construction

The abovementioned criteria have been elaborated in the previous paragraph “Influence on the construction, the exploitation of space and other criteria” during the comparison of typical characteristics of U and V type sections (see Sect. 3.3.3).

3.3.5 Stern Sections Below Waterline

Effect on resistance: Generally V type sections at the stern region are more favorable for the demands of resistance due to the smooth transition and adaptation of the aft shoulders of the vessel to the water flow, which takes place mainly in the way of ship’s hull diagonals. Thus, an early separation of the flow and vortex generation is avoided.

Effect on the Flow to the Propeller and on Propulsion: Due to the nonuniform distribution of the wake of the ship (nominal wake), every blade of the propeller, when turning, experiences an alternating (in magnitude and direction) stream/onset flow velocity (see Fig. 3.22).

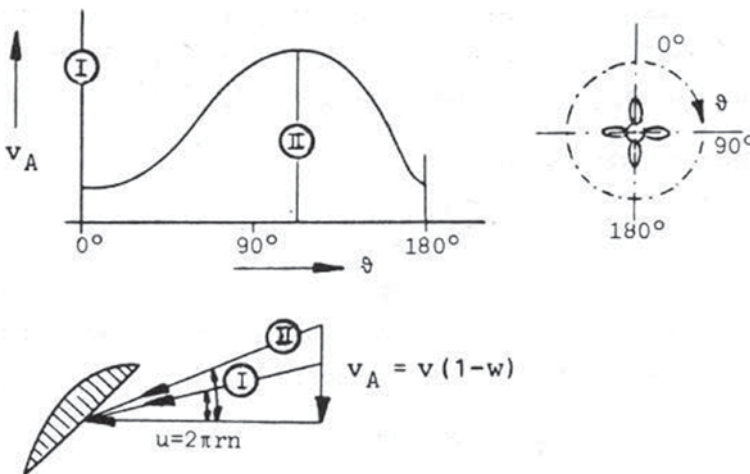

Fig. 3.22 Effect of wake nonuniformity (change of speed of flow incidence) on the propeller blades

This leads to time-varying hydrodynamic pressures on the propeller blades, varying moments on the propeller shaft as well as time dependent irregularities of the thrust force to the ship.

The nonuniformity/heterogeneity of the flow to the propeller is expressed mainly by the “relative rotative efficiency”:

$$\eta_R = \eta_B/\eta_0 \text{ (relative rotative efficiency)}$$

where:

η_0 : Propeller's efficiency in open water

η_B : Propeller's efficiency behind hull (in vessel's wake flow)

The effect of the hull form below waterline at the stern is expressed by the “hull efficiency factor”:

$$\eta_H = \frac{1-t}{1-w} \text{ (hull efficiency)}$$

where

t: thrust deduction factor

w: effective wake factor

As shown by model experiments and theoretical considerations, the flow to the propeller is influenced positively by the application of U-type sections in the final part of ship's hull in front of the propeller, as this ensures more homogeneous distribution of the wake compared to V type sections.

- **Configuration of Single-Propeller Ships:** Efforts are spent on reconciling the aforementioned contradictory requirements, i.e., reducing the eddy resistance and assuring uniform/smooth flow to the propeller. This results in V-type sections around the hips (aft shoulders) of the hull, which change to U-type sections in the end part of the vessel in front of the propeller (low eddy resistance and good propulsive efficiency).

Contemporary Developments

- Application of *bulbous stern/stern bulb* according to patents of A.G. Weser and Schneekluth (see Fig. 3.23a, b). This results in an acceleration of the flow to the propeller and in uniformity of the wake (reduction of vibrations, increase of the efficiency of propulsion system).
- Application of *asymmetric stern* according to a patent of the German naval architect Nönnecke (see Fig. 3.24). The objective is herein to impart a swirl to the flow in front of the propeller to counter the flow induced by the propeller

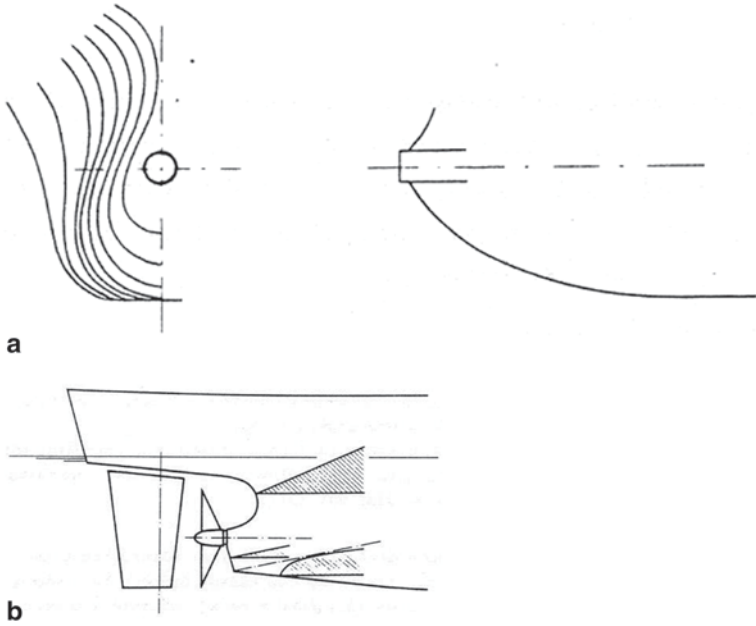

Fig. 3.23 a Stern bulb according to A.G.Weser yard (Germany). b Simplified stern bulb

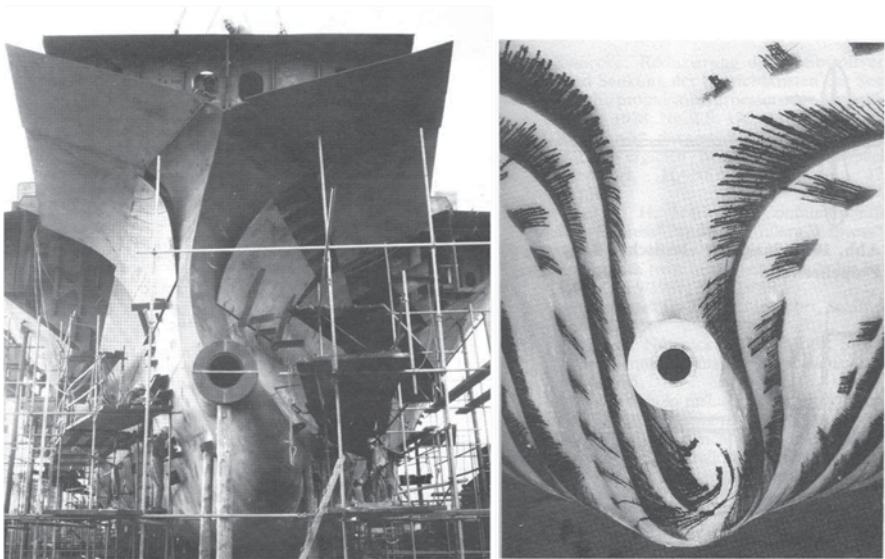

Fig. 3.24 Asymmetric stern according to Nönnecke (Journal Schiff and Hafen Sept 1987)

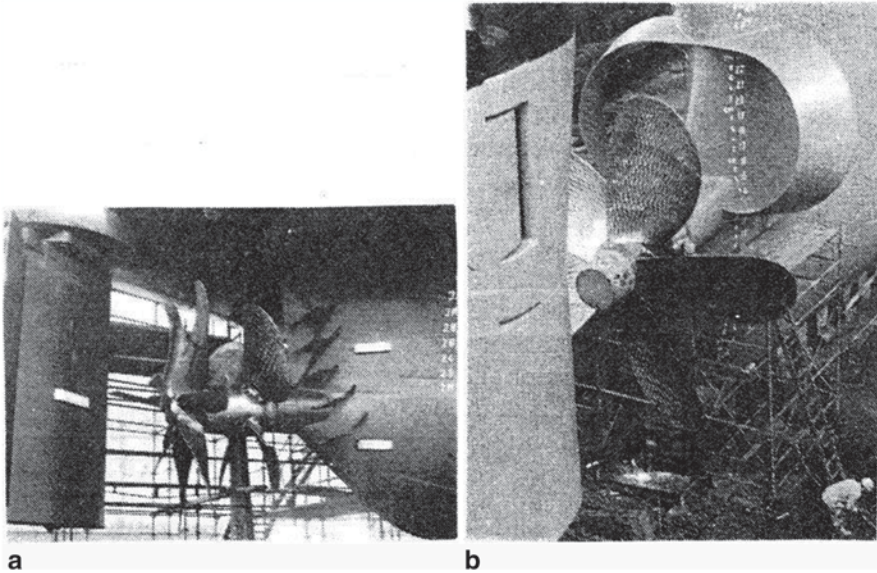

Fig. 3.25 Smoothing of flow to the propeller. **a** Propeller/stern fins and Grim's "vane wheel" behind the propeller. **b** Semi-duct according to Schneekluth (likewise the Becker-Mewis duct with integrated fin system within the duct)

itself. An improvement of the propulsive efficiency in the range of 5–7% may be obtained by the fitting of an asymmetric stern, at the expense of higher construction cost.

- Stern fins and ducts. The objective is herein the smoothing and acceleration of the onset flow to the propeller (see Fig. 3.25a, b).
- **Configuration of Twin-Propeller Ships:** The propellers of twin-propeller ships work to a great extent outside of ship's wake field, i.e., outside the domain where the undisturbed stream velocity reduces due to (mainly)³ the effect of water's viscosity, namely friction between ship's hull and water. Thus the stern sections of twin-screw ships are configured on the basis of the minimum resistance criterion (here minimizing the eddy resistance) and are mostly sections of V-type. Special attention should be paid to the configuration and placement of the brackets of the propeller shafts on the hull surface of the vessel, because of the resulting flow separation at protruding points of the hull.

Modern twin-propeller ships (mostly passenger ships) are fitted nowadays with *tunneled* sections at the stern, which enable both a more uniform wake field and the installation of large-diameter propellers (high propulsive efficiency, see Fig. 3.26).

³ Of course, there are further effects on actual flow velocity to the propellers (and ship's wake), like free-surface effects due to the action of the ship-bound and the incoming sea waves and local hull form effects.

Fig. 3.26 Body plan of a modern Ro-Ro passenger ship with *tunneled* stern sections (Ship Design Laboratory-NTUA)

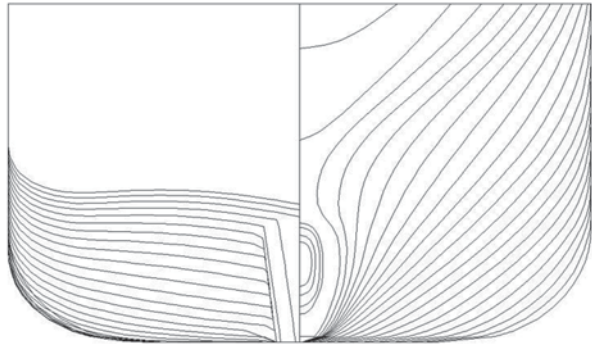

3.3.6 Form of Sections Above Waterline

Basic Criteria

- Exploitation of the deck area
- The seakeeping behavior of the vessel, e.g., amplitude of heave/pitch motion, vertical local movement of bow, added resistance, wetness of deck (green water or periodical immersion/flooding of deck)

It is noted that, the form of the sections above waterline affects the aforementioned hydrodynamic phenomena/criteria to a lesser degree than the more important effects of the freeboard height at the bow, ship's mass moment of inertia, the added/hydrodynamic mass/moment of the vessel, the natural frequency of heave/pitch motions, and possible resonance/tuning with the frequency of the incident wave.

Configuration of the Bow Sections Above Waterline

1. The application of V type sections provides more reserve buoyancy and restoring ability to ship motions, than U type sections, because of the strongly increasing buoyancy force above waterline. Nevertheless, it is common to use for cargo ships U type sections, with some moderate flare above DWL, as a U form fits better to the section form of the bow below waterline.
2. Strong above waterline flares may prevent easy deck wetness (green sea), but may cause severe vibrations on the bow's hull due to slamming during pitch.
3. The application of sections with chine above the waterline reduces the intense flare on deck; however, it increases the probability of "spraying" of the deck due to separation of the flow at the chines. Instead, the use of earlier patented sections by Deutsche Werft ("tulip" sections, see Fig. 3.27b) is suggested.
4. Generally, regarding the seakeeping performance and ship's bow hydrodynamics, an insufficient freeboard height at the bow cannot be counterbalanced by any optimization of the section form above waterline.

Fig. 3.27 Configuration of above waterline bow sections. **a** Above waterline section with hard chine. **b** Patented Deutsche Werft (“tulip” type) section

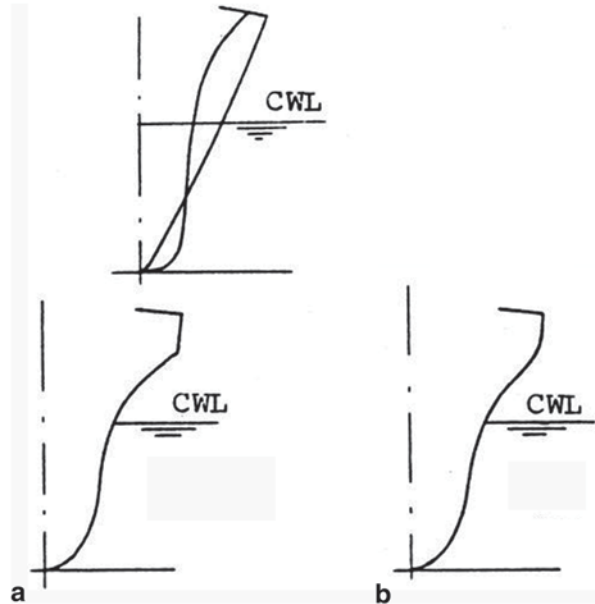

Configuration of Stern Sections Above Waterline The aspect of *green water* on/wetness of deck applies as well to the configuration of the stern part of the ship (for the stern incident waves—following seas).

Significant dynamic stability problems occur especially with small boats (fishing vessels)⁴ and are typically induced in following seas (though also in head waves) due to the partial emergence of ship's hull and the loss of waterplane area (and of effective metacentric height), which is particularly pronounced on ships with V type sections. The reported dynamic phenomena are particularly dominant in resonance/tuning conditions, which occur when ship's natural roll period (or fractions thereof) becomes equal to the encounter wave period, causing *pure loss of stability* and *parametric roll phenomena*;⁵ the latter can be explained mathematically by consideration of the “Mathieu instabilities” problem (Spanos-Papanikolaou 2006). The result of such events can be catastrophic for the ship and may lead to ship's capsize or cargo movement or the loss/damage of cargo on deck (deck containers, see Figs. 3.28 and 3.29).

⁴ Nevertheless, dynamic stability problems have surfaced in recent time also with the operation of larger ships, e.g., containerships.

⁵ The most prominent, recent large ship accident related to parametric roll happened in October 2008 with the 4,832 TEU containership *APL China* on the way from Taiwan to Seattle; during her trip the ship experienced parametric roll resonance and barely survived foundering; when she arrived in Seattle it was realized that more than sixty percent of her cargo was lost at sea or damaged. The following multi-million USD liability case was settled out of court for an undisclosed amount. Thanks to the conduct forensic studies that attributed the disaster to parametric roll, the liability of the operator APL (American President Lines) was limited to reasonable levels.

Fig. 3.28 Containership



Fig. 3.29 Shift of containers due to parametric roll



3.4 Form of Bow

3.4.1 *Types of Bow*

a. Profile of Bow—Historical Evolution of Bow Types

Old times: termination of the bow in a vertical or slightly protruding straight line profile (flared bow profile) above the waterline (see examples Figs. 3.30 and 3.31).

Sometimes on older warships, the profile above the waterline was backwards (*tumble home*) bow profile and below the waterline they disposed a protruding bow with a bulbous profile *without or with slight protrusion in the transverse direction* (“*piston*” type bow of antique Greek triremes) (Fig. 3.32).



Fig. 3.30 British passenger ocean liner “Mauretania” (1907), $L=232$ m, Displacement=38,600 t, Tonnage: 32,000 GRT, Shaft Horsepower=68,000 HP, $V=27.2$ kn (average speed, “blue ribbon” winner for crossing the Atlantic in year 1909)

Fig. 3.31 German passenger ocean liner “Bremen” (1929), $L=270.7$ m, Displacement=51,860 t, Tonnage: 51,656 GRT, Shaft Horsepower=96,000 HP, $V=28.5$ kn (average speed, “blue ribbon” winner for crossing the Atlantic in year 1929)

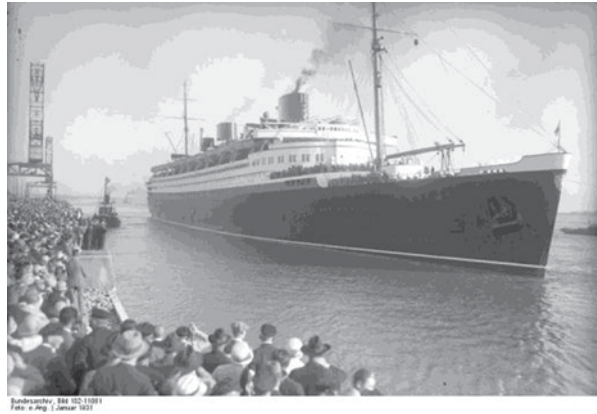

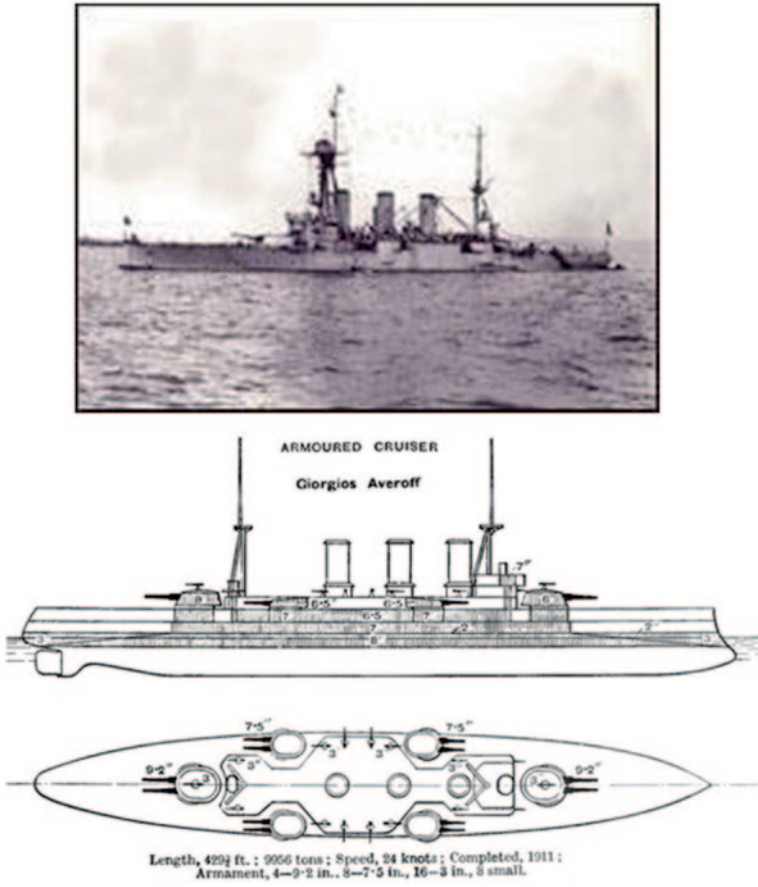

Fig. 3.32 WWI Greek battleship “Georgios Averof” (1910), $L_{BP}=140.5$ m, $B=21$ m, $T=7.5$ m, $\Delta=10,118$ t, $P_S=19,000$ HP, $V=23.0$ kn



Fig. 3.33 Contemporary cruiser design of US Navy DDG 1000

Fig. 3.34 Contemporary super luxury mega-yacht SIGMA A, shipyard Blohm and Voss (Germany 2008)—LOA 119 m, B 18.87 m, Tmax: 5.15 m, NPASS: 14, NCR: 37



The above waterline backward slope and below waterline protruding bow re-surfaced recently as a *wave-piercing* bow on modern warships and mega-yachts (Figs. 3.33 and 3.34).

Latest Developments—Commercial Vessels (last 20–30 years): Above the waterline we observe a protruding straight line (Fig. 3.35), slightly curved bow (Figs. 3.36 and 3.37) or more strongly curved bow (“Falcon type”).

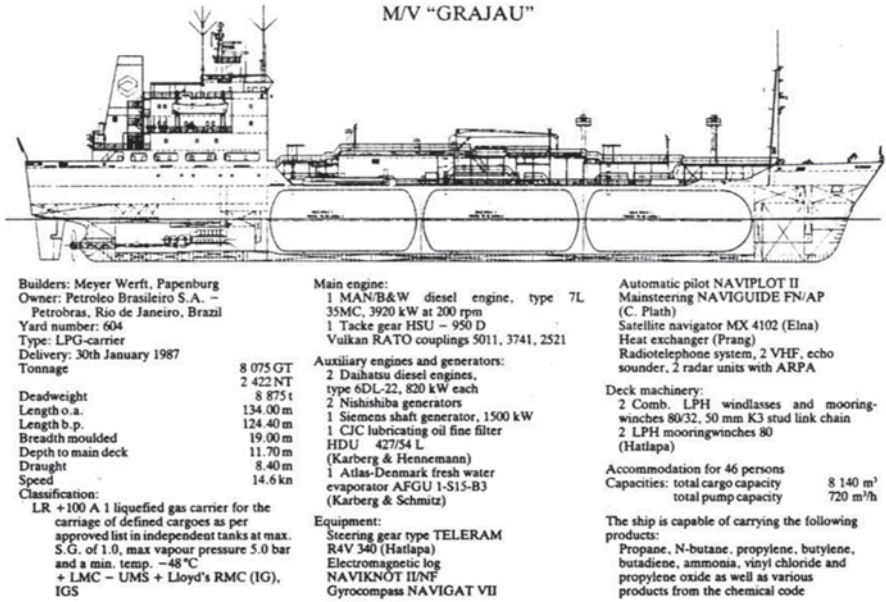

Fig. 3.35 LPG tanker, Meyer Werft (Germany)

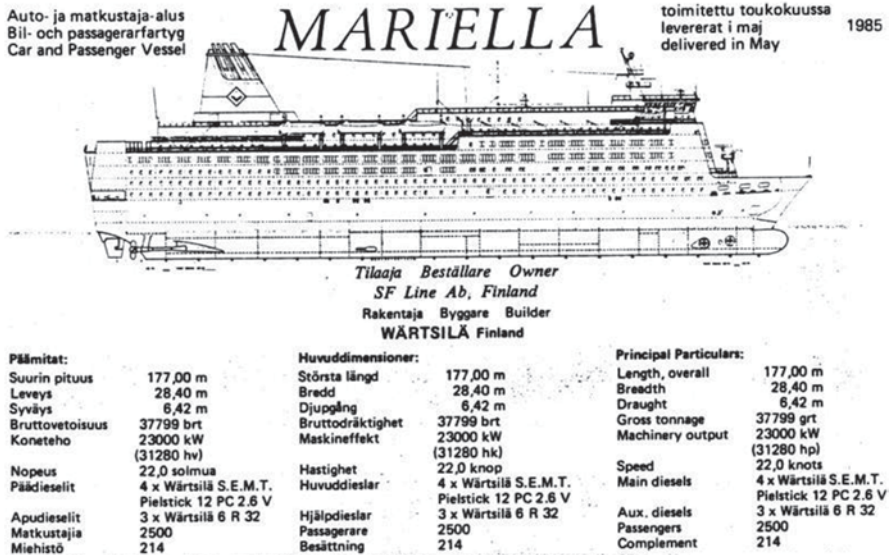
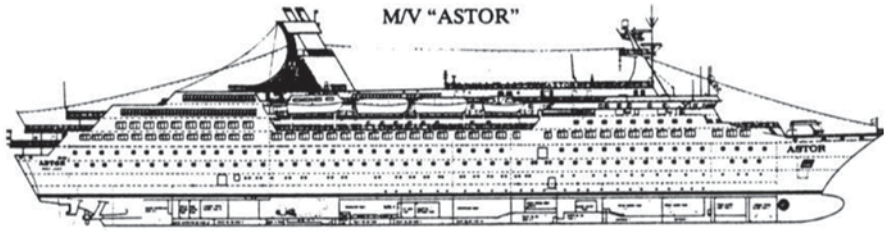

Fig. 3.36 North Sea RoPax ferry of former shipyard Wärtsilä (Finland)



| | | | | | |
|--|--|---|--|--|--|
| Builders: Howaldtswerke-Deutsche Werft AG, Kiel Owner: Marian Corporation Ltd. Managing owner: Margan Leisure Ltd., Colchester Yard number: 218 Type: Cruise vessel Delivery: 21st January 1987 | | Classification: GL + 100A4 E1 with freeboard 2.02 m passenger ship + MC E1 AUT Main engine: 2 Sulzer/Wärtsilä diesel engines, type 8 ZAL 40, 4400 kW at 580 rpm each 2 Sulzer/Wärtsilä diesel engines, type 6 ZAL 40, 3300 kW at 580 rpm 2 Reduction gears NAVILUS GVE 1500 S 2 Clutches PNEUMAFLEX KAP 340 2 Clutches PNEUMAFLEX KAP 320 2 Clutches PNEUMASTAR KUG 260 (Lohmann & Stolterfoht) 2 KaMeWa variable pitch propellers, 5-bladed, dia. 3.50 m Auxiliary engines and generators: 2 Daihatsu diesel generating sets, type 2 DLB-28, 1540 kW at 720 rpm each 1 Deutz emergency diesel generating set, type BA 6 816 U, 240 kW at 1800 rpm 2 A. v. Kaick shaft generators, 2960 kW at 1800 rpm each 2 Couplings SPIROFLEX KJO 180 (Lohmann & Stolterfoht) Equipment: 2 Ross steering gears, Simplex-Compact | | Bowthruster, type 120 F, 880 kW (Jastram) Ross Stabilizer, Simplex-Compact SK 40, Air conditioning plant according to the DUOVENT and Central system heating capacity = 3433 kW cooling capacity = 3582 kW (Noske-Kaeser GmbH/AB Fläktfabriken) Sat.-Com. ARIES 3 S, Telex FFS 1004, weather chart ALDEN TR 1 (Hagenuk) Radar Atlas 8600 ARPA, S/7600 AC/RM, X, Atlas Echograph 481, Atlas Dolog 11D (Krupp Atlas) Debeg 3008 Telegrafic station, Debeg 6330 VHF Magnetic Compass system NAVIPOL 1 (C. Flath) Iron-pump, type BDV 75 (Karberg & Schmitz) Deck machinery: 2 Electric anchor- and warping capstans 160, 58 mm K3 stud link chain 1 Electric double drum warping winch 100 2 Electric warping winches 100 (Hattlapp) Capacities: passengers 656 crew 246 | |
|--|--|---|--|--|--|

Fig. 3.37 Cruise ship of shipyard HDW (Germany)

TILAAJA BESTÄLLARE ORDERED BY
 MERENKULKUHALITUS SJÖFARTSSTYRELSEN FINNISH BOARD OF NAVIGATION
 RAKENTAJA BYGGARE BUILDER
WÄRTSILÄ FINLAND

| | | |
|--|--|---|
| PÄÄMITÄT: SUURIIN PITUUS 96,0 M SUURIIN LEVEYS 24,2 M SUURIIN SYVÄYS 8,0 M KONEISTO: DIESEL-SÄHKÖINEN (AC-AC) DIESELITEHO 21,8 MW (29700 HV) AKSELETEHO 15,0 MW (20400 AHV) + NOPEUS AVOVEDESSÄ 18,5 SOLMUA POTKUPRETTÄ 2 | HUVUOIMENSIOINER: STÖRSTA LÄNGD 96,0 M STÖRSTA BREDD 24,2 M STÖRSTA DJUPGÅNG 8,0 M MASKINER: DIESEL-ELEKTRISKT (AC-AC) DIESELEFFEKT 21,8 MW (29700 HP) AXELEFFEKT 15,0 MW (20400 AHK) FART I ÖPPRET VATTEN 18,5 KNOP ANTAL PROPELLRAR 2 | PRINCIPAL PARTICULARS: LENGTH MAX. 96,0 M BREADTH MAX. 24,2 M DRAUGHT MAX. 8,0 M MACHINERY: DIESEL-ELECTRIC (AC-AC) DIESEL OUTPUT 21,8 MW (29700 HP) SHAFT OUTPUT 15,0 MW (20400 SHIP) SPEED IN OPEN WATER 18,5 KNOTS NUMBER OF PROPELLERS 2 |
|--|--|---|

Fig. 3.38 Large icebreaker of former shipyard Wärtsilä (Finland)

Also, bulbous bows fitted with various types of bulbs are common (see Sect. 3.4.2 for details).

Special forms:

- Icebreaker bow (Fig. 3.38)
- Sailing boat bow (Fig. 3.39)

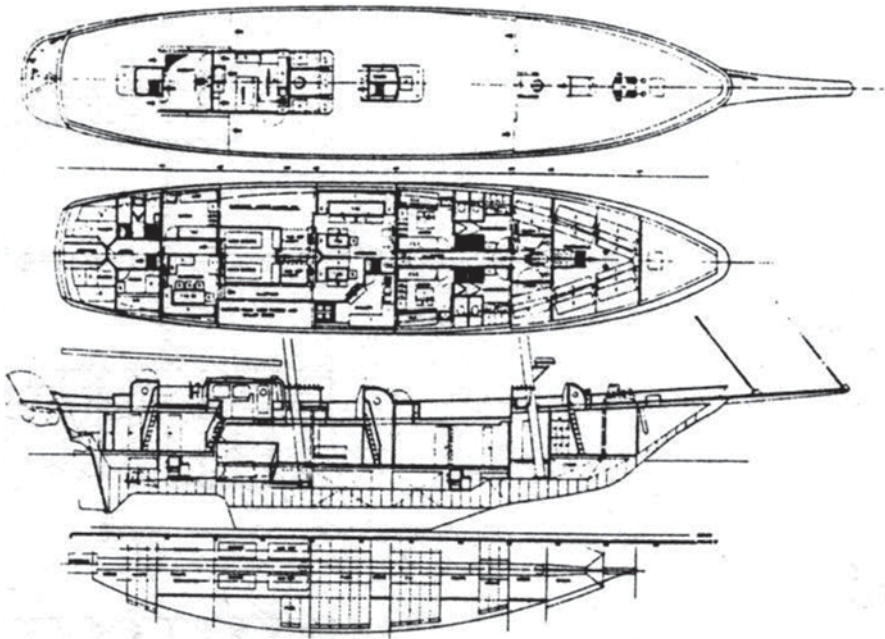

Fig. 3.39 General arrangement plans of “Young Endeavour,” designed by Colin Mudie, with a cutaway external ballast keel

b. Factors Affecting the Configuration of Bow Form

- Smooth adaptation of the bow to the forward sections
- Favorable seakeeping performance in waves
- Exploitation of deck at forecastle
- Safety of underwater bow part against collision (see Sect. 3.4.2 for bulbous bows)
- Easy construction

c. Horizontal Cross Section of Bow Relationship with the Way of Construction:

In older times the bow ended in strengthening beams of rectangular or trapezoidal cross section (see Fig. 3.40a). In this way the desired thin line tip of the bow could be achieved both at the design/construction WL and the neighboring waterlines around the DWL. In contemporary types the ending is more curved and the sharpness of the ending on the DWL depends on the radius of curvature of the fitted bow panels (see Fig. 3.40b).

More ideal, but expensive, is the type of casted stem (foremost part of the bow), at which the bow plate panels are welded at appropriately prepared notches, so as to produce a fine ending of the waterlines (see Fig. 3.40c, common in naval vessels).

Finally, the type of ending at a stiffener of circular cross section (see Fig. 3.40d) is an economic and satisfactory engineering solution, which is often implemented today at the bow part around the DWL.

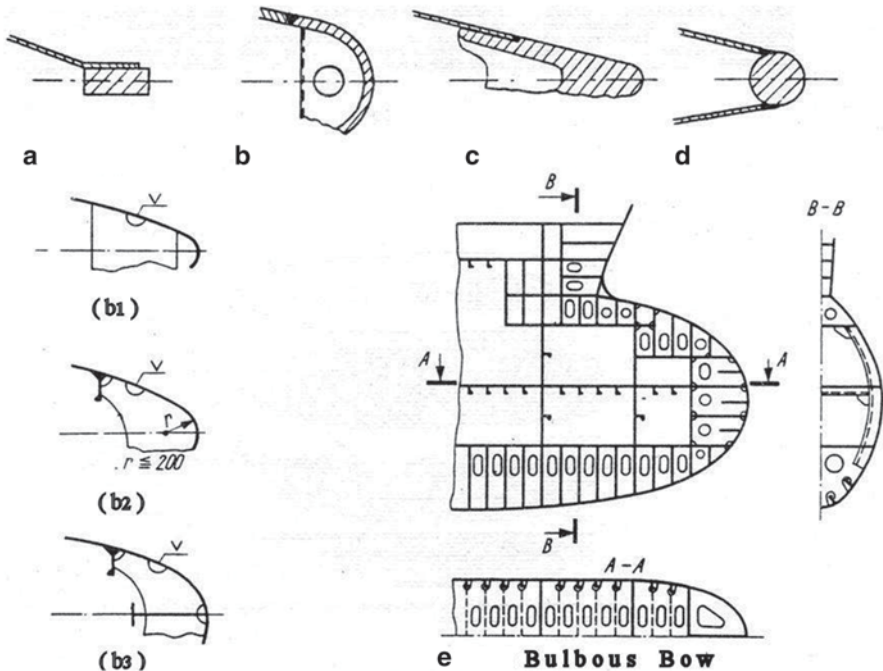

Fig. 3.40 Possible construction solutions of cross section of bow

Impact of cross section of neighboring waterlines: The influence of the form of the bow cross section at neighboring waterlines (around the design waterline) on the resistance is relatively small, particularly as the distance from DWL increases. However, regarding the wave breaking phenomenon at the bow and the corresponding wave breaking resistance, a fine cross section has to be preferred both on the design waterline and adjacent waterlines, especially for fast ships and for small freeboard heights.

Cross section above the waterline: Around the region of ship's forecastle (back), an as large as possible deck area is targeted for fitting the vessel's anchoring and mooring equipment (winches, hawse pipes, capstans, bitts). This is achieved by a relatively large radius of curvature, but not to the extent that it hinders the transition to smaller radii of curvature at the design waterline, as the fairing process of ship lines (see Fig. 3.40a diagram (b1) to (b3)).

Below waterline cross section: The expansion of the bow below the waterline is not considered unfavorable; on the contrary we may assume that under certain conditions it leads to a reduction of wave resistance (see bulbous bow). However, regardless of the existence of a bulbous bow, a voluminous bow form below the waterline facilitates the fairing of the ship lines around the keel (flat plate keel) and offers more flexibility in construction and maintenance; it allows, also, the fitting of horizontal stringers for strengthening of the bow.

Fairing of bow curvature: The radii of curvature of the waterline entrance at the bow, which vary with height, should be controlled with the introduction of virtual control lines connecting points of maximum curvature and helping to achieve smoothness of the resulting bow.

3.4.2 *Bulbous Bow*

a. Historical Evolution The bulbous bow is nowadays a common feature of contemporary merchant ships. The main reason for applying bulbous bows is to reduce the wave resistance, when sailing in calm water, which is an important component of ship's total resistance for relatively fast ships. For certain speeds, the resulting significant reductions of the required propulsion power are confirmed with model tests; it can be also explained with theoretical considerations and numerical simulations, at least qualitatively and to a lesser degree quantitatively (it depends on the reliability of the employed numerical prediction method) (Kerlen 1971, p. 1031; Eckert and Sharma 1970, p. 129; Kracht 1978).

The positive effect of the bulb, i.e., of a transverse and longitudinal expansion at vessel's bow below the waterline, was discovered accidentally in the early twentieth century during naval ships' model testing in the USA.⁶ They were implemented initially by D. Taylor (1912) in U.S.N. naval ships. Analogous developments with German naval ships were first noted in 1914. The first non-military vessels equipped with a bulb were built in Germany, namely the fast passenger ocean liners "Bremen" and "Europa" (1929); they were followed by the French "Normandie" and Italian "Rex". The first applications to cargo ships were presented in the 1950s, initially to fast reefer ships and after about 1955 to tankers and bulk carriers. The first tanker fitted with a bulb is considered to be the Norwegian "Grena" (1957), built at the German shipyard Bremer Vulkan (Schneekluth 1985). The application of bulbous bows has now prevailed in all types of ships and is implemented even to relatively small vessels, such as oceangoing fishing ships, trawlers (oceanic fisheries), etc.

b. Form and Size of the Bulb

Typical geometry features of the bulbs are the following:

1. Transition way to the remaining part of the vessel (fairing)
2. Form of sections
3. Longitudinal profile
4. Protrusion in front of forward perpendicular
5. Position of centroid and axis
6. Area rating compared to A_M (ratio of sectional area at the fore perpendicular to midship section area)

⁶ Of course, bulb/piston type bows (without transverse expansion) were found in the antique Greek "triremes" and were used for ramming enemy ships; they were applied to naval ships until the beginning of the twentieth century.

Some of the above mentioned characteristics are expressed numerically and others are purely qualitative characteristics.

c. Fairing of Bulb

c.1. Faired-In Bulb Features: faired waterlines at all drafts; bow profile was previously an almost vertical line (ocean liner “United States”, Fig. 3.41), or slightly protruding (Fig. 3.42), or more strongly protruding in newer forms (Fig. 3.43).

c.2. Attached Bulb Features: cylindrical body attached to a “normal” bow; waterlines and sections in the region of the connection with the rest ship body without fairing (knuckled lines) (Fig. 3.44).

d. Form of Bulbous Bow Sections—Vertical Position of Centroid

d.1. Standard Type

Features: faired bulb; droplike shape (known as *Taylor* bulb or in German *Tropfenwulst*); centroid low, high bottom entrance ways of sections (see Fig. 3.45a).

d.2. Blohm and Voss Shipyard Type

Features: elliptical cross section, centroid at a medium height, bulb attached (see Fig. 3.45b).

d.3. VWS-Berlin Towing Tank Type: circular cross section, centroid low, bulb attached (see Fig. 3.45c).

d.4. SV Type by Maier-Form Patent: Wedge/V type cross section, high centroid, maximum width near the waterline, thin design waterline entrance, lateral profile resembling S-shape (see Fig. 3.45d). A variant of SV type is the “goose—neck, water-piercing” bulb that pierces the waterline; the latter is nowadays often applied to modern fast Ro/Ro passenger ships (see Fig. 3.45e).

The standard ending of bulb types (a) to (c) is to circular or elliptical lateral profiles, depending on the easiness of construction.

Certain bulb types, such as the wedge-type forms (e), are connected to V-type sections in the bow region, while the circular or drop (Taylor) types of bulbs fit better to U-type sections (Fig. 3.46).

e. Sectional Area of Bulb The ratio of the sectional area of the bulb at fore perpendicular A_{BT} to the midship section area A_M usually ranges between 5 and 15%, depending on the bulb type and the design speed.

The influence of the sectional area of bulb on resistance is shown in the following indicative figure, which applies to Taylor-type bulbs and cannot be generalized. The optimum and minimum values of the ratio (A_{BT}/A_M) to achieve a minimum wave resistance generally increase with speed.

Regarding the indicated upper limits and the ratio (A_{BT}/A_M), the following should be noted:

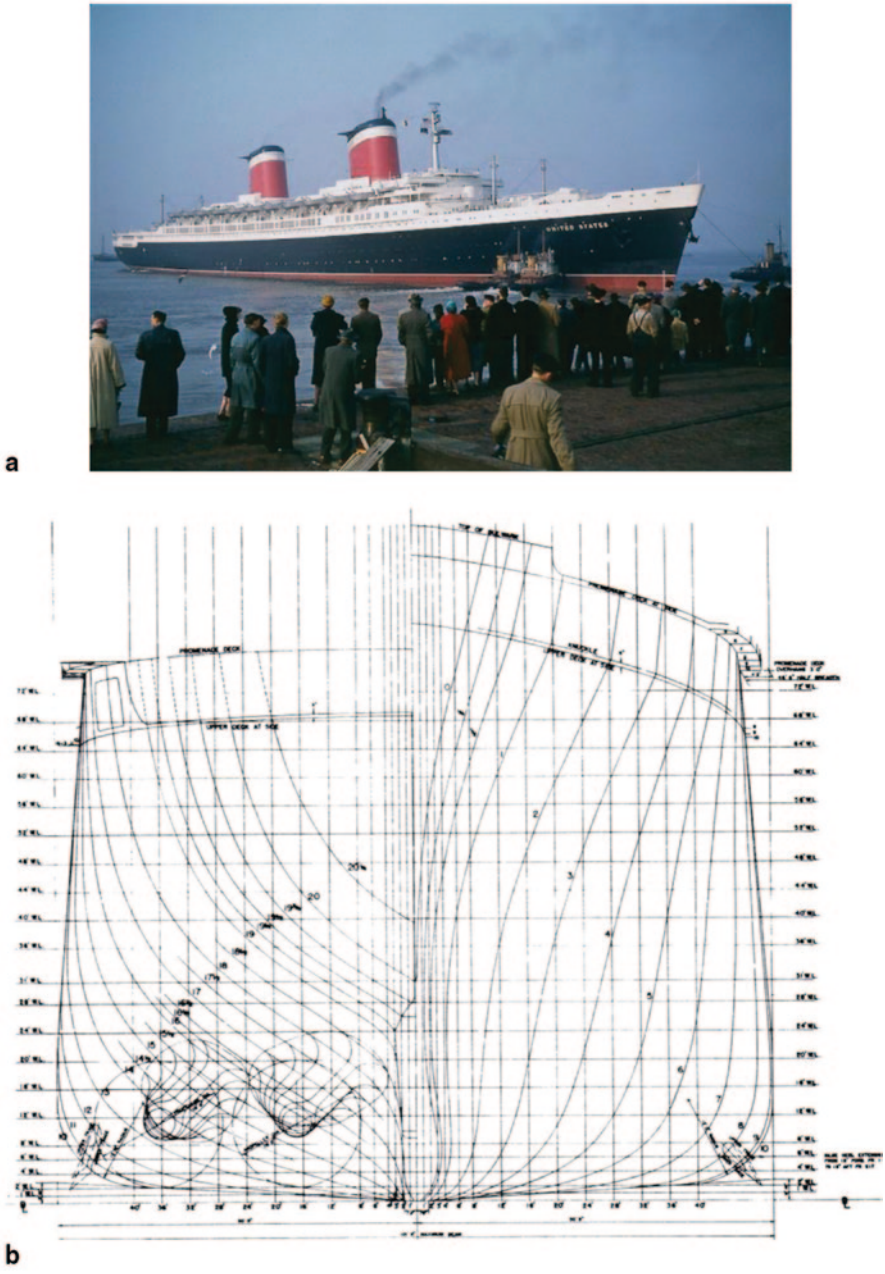
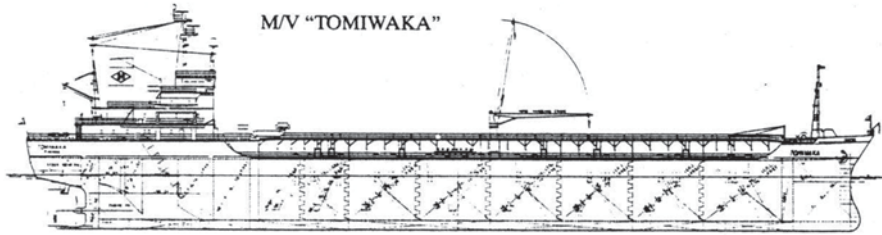

Fig. 3.41 Lines plan of historic large passenger ship “United States”



Builders: Shikoku Dockyard Co. Ltd.,
 Kagawa, Japan
Owner: T & M Navigation S.A.
Yard number: S 837
Type: Chemical tanker
Delivery: 25th September 1986
Tonnage
 9 792 GT
 5 729 NT
Deadweight
 16 933 t
Length o.a.
 143.04 m
Length b.p.
 133.00 m
Breadth moulded
 22.40 m
Depth to main deck
 11.80 m
Draught
 9.015 m
Speed (full load)
 abt. 13.5 kn
Speed (trial)
 14.3 kn
Classification:
 NKNS* (Tm or ob & C II & III) MNS*

Main engine:
 1 Mitsui/B&W diesel engine, type 5L50MCE,
 4600 kW at 133 rpm
Auxiliary engines and generators:
 1 Yanmar diesel engine, type S185AL-UT,
 441 kW at 1200 rpm
 1 Generator, 500 kVA, 450 V, 60 HZ
 1 Yanmar emergency diesel engine, type
 4T112L-H, 53 kW at 1800 rpm
 1 Generator, 55 kVA, 450 V, 60 HZ
 2 Yanmar diesel engines, type M200AL-ET,
 662 kW at 900 rpm each
Boiler:
 1 Gadelius oil fired boiler, package type,
 12.0 t/h
 1 Exhaust gas eco. forced circ. multi tube
 type, 0.6 t/h

Cargo handling:
 2 Twin screw type cargo pumps, driven by
 diesel engine 750/400 m³/h
 5 Twin screw type cargo pumps, driven by
 diesel engine, 400/200 m³/h
 1 Twin screw type slop pump, driven by elec.
 motor, 120/60 m³/h
 1 Strip pump, 1-tank cleaning pump, 1-bal-
 last pump
 1 Tank cleaning heater
Equipment:
 Gyrocompass and autopilot, doppler log, echo
 sounder, N.N.S.S., Lorán C
Accommodation for 29 persons
Tanks: 23 (7-CR.C.T., 14-WG.C.T., 2-Slop T)
Loading gear: 1 Hose handling crane 5 v 10 m
Total cargo capacity: 19 854 m³

Fig. 3.42 Chemical Tanker, Shikoku Shipyard (Japan)

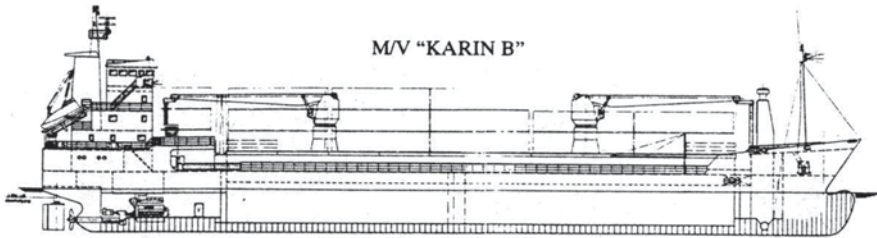

Builders: Paul Lindenau GmbH & Co. KG
 Schiffwerft und Maschinenfabrik,
 Kiel-Friedrichsort
Owner: Emetha-Reederei GmbH & Co. KG,
 MS „Karin B“, Emden
Yard number: S 224
Type: Multipurpose vessel
Delivery: 6th January 1987
Tonnage
 3 420 GT
Deadweight
 4 250 t
Length o.a.
 100.00 m
Length b.p.
 94.20 m
Breadth moulded
 14.00 m
Depth to main deck
 7.45 m
Depth to tween deck
 5.45 m
Draught
 5.44 m
Speed (at draught 5.21 m)
 12.5 kn
Classification:
 GL +100 A4 E1, containerfitted, strengthened
 for heavy cargo, dangerous goods
 IMO-class 3-8
 + MC E1 AUT
Main engine:
 1 MWM diesel engine, type TBD 510 L6,
 1660 kW at 600 rpm

1 Reintjes reduction gear
 1 Vulkan RATO coupling 2811 for main drive
 and one 1241 for PTO drive
 1 Schaffran c.p. propeller plant type
 VKG 75/4, dia 2800 mm, 4 blades,
 material G-NIA1Bz
Auxiliary engines and generators:
 2 MWM diesel engines, type TBD 234 V8,
 212 kW at 1500 rpm each
 2 Van Kaick generators, 245 kVA each
 1 MWM Emergency diesel engine,
 type D 266-6, 45 kW
 1 Van Kaick generator, 50 kVA
 1 Van Kaick shaft generator, 245 kVA
 1 CJC Filter separator WFU 27/54
 (Karberg & Hennemann)
 Atlas-Denmark freshwater evaporator
 AFGU 1-E7-80 (Karberg & Schmitz)
Equipment:
 Bowthruster type 20 F, 154 kW (Jastram)
 Flaprudder
 Elec/hydr. steering gear
 Gyrocompass and autopilot (Anschütz)
 2 Radars Kelvin Hughes KH 1610
 Echo-sounder Furuno FE 606 N
 (Elna)

Sat.-Nav. Navstar 602 S
Accommodation for 12 persons
 1 Hold
Hatch:
 62.30 x 11.10 m
Hatch covers:
 Weatherdeck Multi Piggy-Back type
 Tweendeck Pontoon type (Lift-on/Lift-off)
 (Kvaerner Brug)
Loading gear:
 2 Elec/hydr. deck cranes, 25 v 16.5 m or
 18 v 19.0 m
 (Neuenfelder Maschinenfabrik)
Total cargo capacity:
 grain 5 773 m³
 bale 5 631 m³
Container:
 on deck 123 TEU
 in hold 117 TEU
 total 240 TEU
**Conver-OSR container lashing and securing
 equipment**
Reefer plugs: 9

Fig. 3.43 Multipurpose Cargo Ship, Lindenau Shipyard (Germany)

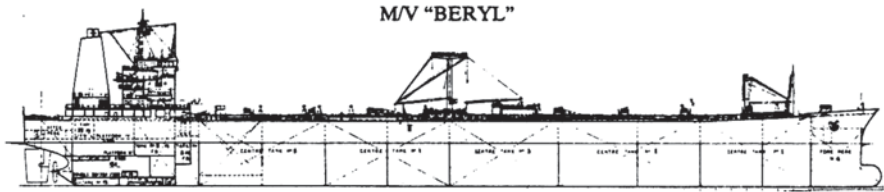

Builders: Gdynia Shipyard, Gdynia, Poland
Owner: First Aframax Tanker Corp.,
 Monrovia, Liberia
Managing owner: Maritime Overseas Corp.,
 New York, U.S.A.
Yard number: B557/3
Type: Oil tanker
Delivery: 19th May 1986
Tonnage
 52 518 GT
 24 588 NT
Deadweight
 84 406 t
Length o.a.
 247.20 m
Length b.p.
 236.00 m
Breadth moulded
 41.60 m
Depth moulded
 18.75 m
Design draught
 12.20 m
Scantling draught
 12.45 m
Speed
 14.0 kn
Classification:
 LR + 100 A 1 Oil Tanker + LMC, UMS, IGS,
 SBT-PL, PT-HT

Main engine:
 1 Cegeleski/Sulzer diesel engine,
 type 6RND90M, 14 042 kW at 112 rpm
 1 Zamech 5-bladed propeller of special
 nicel-aluminium bronze, dia. 6400 mm
Generators:
 2 Cegeleski/Siemens diesel engine generating
 sets, type 6AL25/30, 1 FCS-566-3TA-Z,
 900 kVA, 450 V, 60 Hz, 720 rpm each
 1 Turbogenerator type 18, "multi-stage",
 900 kVA, 450 V, 60 Hz
 make: Brotherhood Ltd.
 1 Emergency generating set, diesel engine
 MAN type D2542, alternator type GA 7446,
 356 kVA, 450 V, 60 Hz, 1800 rpm
 make: DEMP
Boiler:
 2 Water-tube, double drum oil fired boilers,
 types KW 17330A-50/KW 17330B-50, evap-
 oration 33 000 kg/h, make: Gdansk-Shipyard
 1 Exhaust gas boiler, type Disecon,
 superheat steam 5560 kg/h, Satured 1025 kg/h,
 make: E. Green & Son Ltd.

Equipment:
 1 Kawasaki elec. hydr. steering gear,
 type F-21-250 IMO 50
 Twimor windlasses and winches
 Transmitters and receivers, Japan Radio
 VHF-Radiotelephone, W. G. Schulz
 Magnetic compass, autopilot, gyrocompass,
 2 radars, Sat.-Nav., Doppler log, Sperry
 Radio direction finder NAVIGON III
 SFP 7000 (C. Ptath)
 Echosounder, Simrad
 Weather facsimile receiver, Raytheon
 Lorán C receiver, Skipper
 Decca Navigator type Mark 21
Cargo handling:
 3 Cargo pumps, steam turbine driven,
 vertical centrifugal type C42B16-20,
 cap. 3000/2500 m³/h, make: Thune Eureka
 1 Stripping pompe type KPH-275,
 cap. 300 m³/h, make: Shinkokinzoku
Tanks: 5 center tanks
 5 PS and 5 SB tanks
 2 slop tanks
Total cargo capacity: 103 510 m³

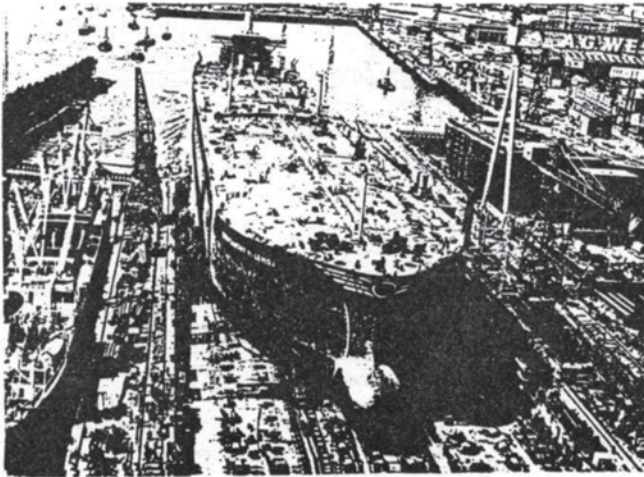

Fig. 3.44 Crude oil tanker, Gdynia shipyard (Poland)

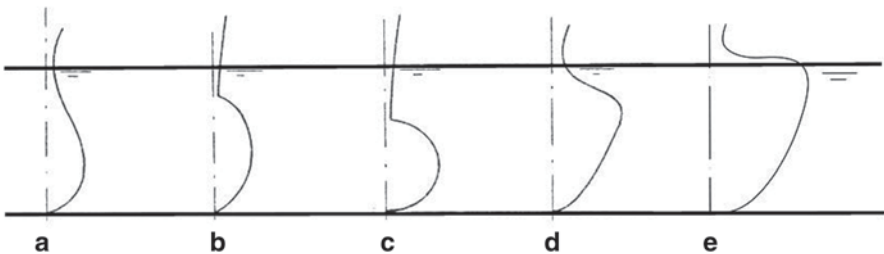

Fig. 3.45 Alternative cross sections of bulbous bows

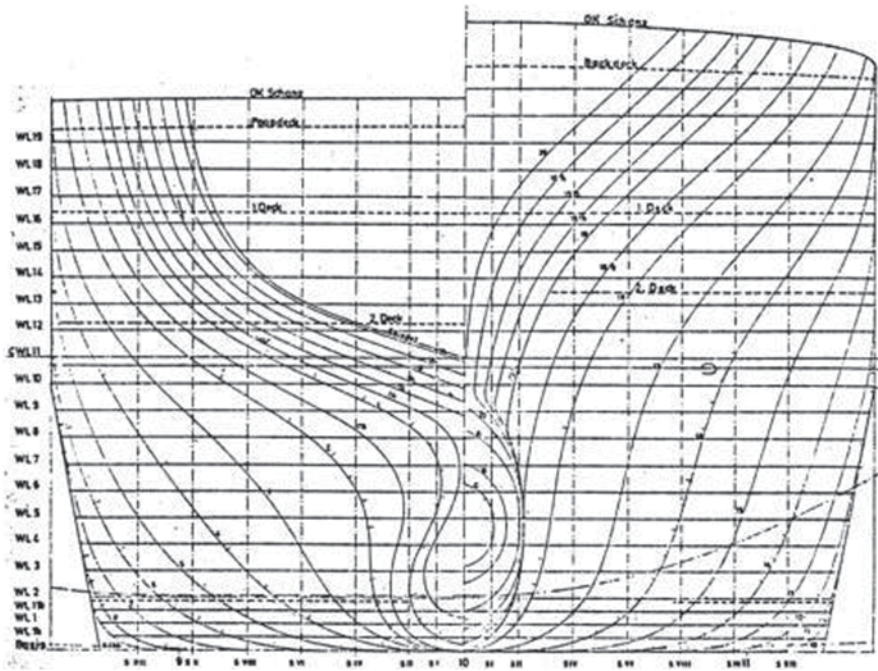

Fig. 3.46 Containership body plan with elliptical bulbous bow and drop type stern bulb (Blohm and Voss Shipyard)

- In ballast condition, the possible emergence of a large bulb can reverse but even further enhance the positive effects on (the reduction of wave) resistance. The same applies to every draft (and trim) different from the design draft.
- In heavy seas, extensive bulbs are sensitive to slamming phenomena.
- During anchoring and docking, it may induce contact damage problems with the anchor falling on bulky bulbs, if a satisfactory position of the anchor hawses at the bow is not ensured, and contact/collision damages with the pier.

The optimum ratio (A_{BT}/A_M) and generally the efficiency of a bulb can eventually be verified only by model tests, despite recent developments in computational fluid dynamics CFD for the calculation of a ship's resistance; the latter however helps to identify the optimal design of a bulb and to reduce considerably the model experimental effort (Fig. 3.47).

f. Protrusion of the Bulb in Front of Fore Perpendicular The extent of protrusion of the bulb in front of FP depends on the type of bulb and ship's speed (Froude number). For safety reasons the lateral projection of the below waterline bulb must not exceed the foremost edge of the forecastle deck. As an illustrative measure, the size of the projection may be taken about 20% B. It should also be noted that the length of the ship to be used in the calculation of ship's required freeboard (according to the International Load Line regulation), for ships with low freeboard deck,

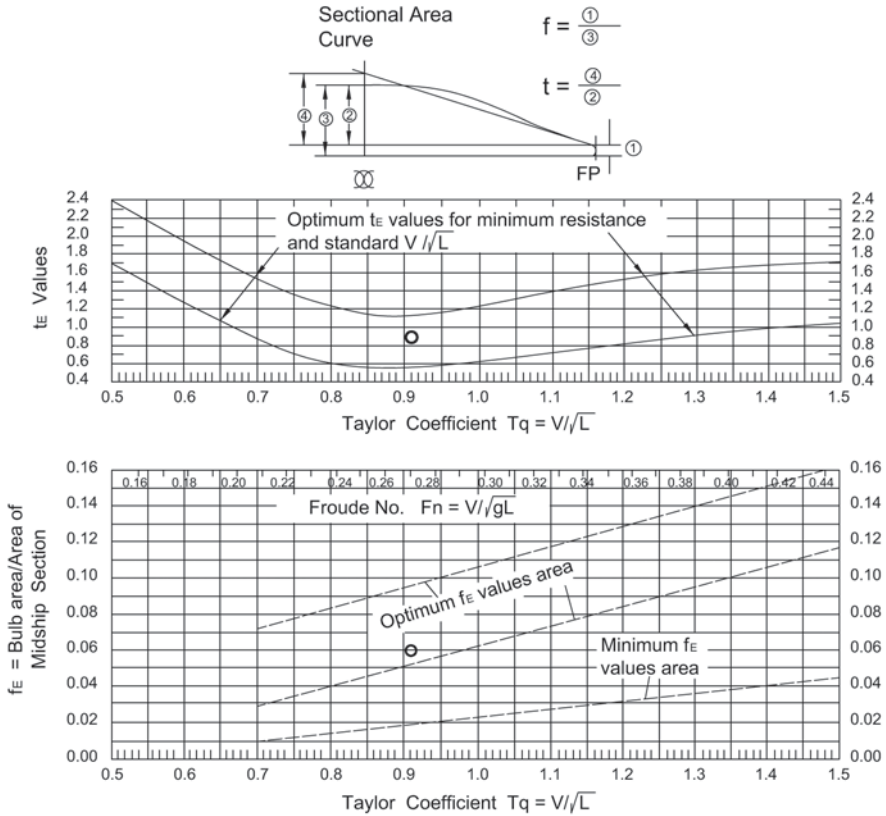

Fig. 3.47 Optimal and minimum values of the area ratio $(A_{BT}/A_M)=f_E$ for Taylor drip bulbs

may be significantly influenced (*increased*) by the extent of the lateral projection of the bulb (see Figs. 3.48, 3.49, 3.50, SV and “goose—neck” bulb).

g. Position of Centroid and Axis The centroid height of the bulb’s cross section at forward perpendicular and the associated maximum width of the bulb depend on the type of bulb. Thus, for cylindrical or drop like bulbs, with relatively small effects on the disturbance of free surface and moderate reductions of wave resistance, the centroid is low; on the contrary, for wedge-type bulbs (SV type, and goose—neck) the main volume of bulb is close to the waterline.

According to the US hydrodynamicist Wigley, for drop or cylindrical bulbs, the waterline corresponding to the highest point of the bulb should be located around one bulb width below of the DWL.

Regarding the axis of the bulb, this is an imaginary line passing through the maximum transverse-ordinates of the bulb; this line can be straight (e.g., cylindrical bulbs) or continuously retreating to the aft. As a criterion for the bulbs shaping the

Fig. 3.48 Effect of bulbous bow protrusion on freeboard length (ICLL)

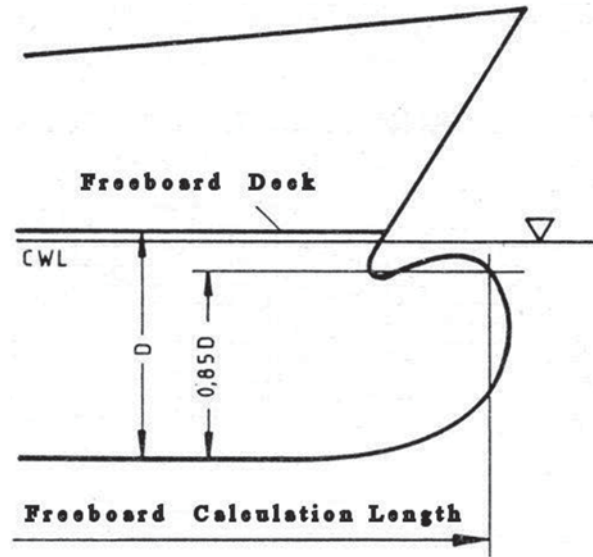
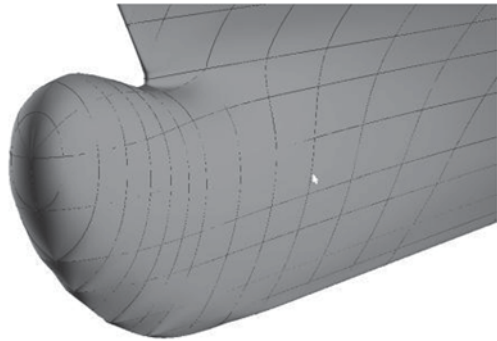

Fig. 3.49 Bulb goose-neck (Deltamanin, Finland)



direction of the stream lines of water around the bulb may be taken, which is mainly going from above the bulb toward the bottom, as can be observed in experiments.

h. Influence on Resistance and Propulsion The effects of a bulb on ship's resistance and propulsion, compared to the same ship without a bulb, are significant and complicated, thus a simple explanation is not enough to cover all effects. Especially it should be noted that the various effects of the bulbous bow on the flow around the ship vary according to the type of ship (and of different hull forms) in relation to the type of fitted bulb, in dependence on the cruising speed and ship's loading condition (actual drafts and trim).

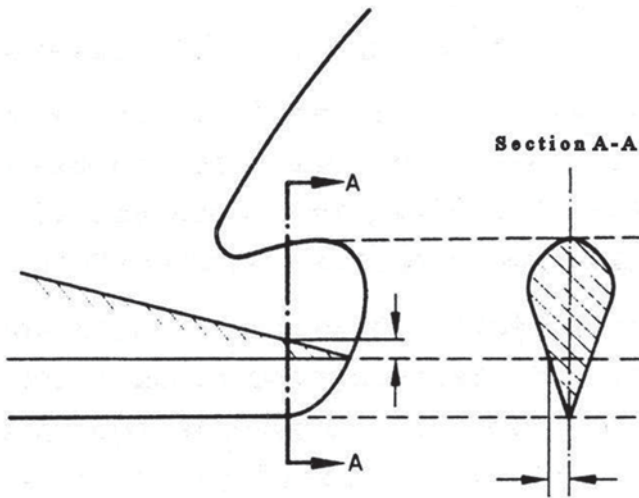

Fig. 3.50 Configuration of SV bulb

The basic qualitative hypotheses regarding the effects of a bulb on the resistance and propulsion of a ship are as following:

h.1. The bulb displaces an amount of water in front of ship's bow, thus it changes the pressure field around the hull, particularly at the bow region. Theoretically, the "hydrodynamic length" of the vessel increases and the "effective" Froude number decreases, moving the "effective" speed of the ship to regions of reduced resistance.

h.2. As mentioned above, the pressure distribution in the bow region changes and the *bow wave system* is shifted forward. The interference of the resulting bow wave system (starting with a wave crest) with the corresponding one of the forward shoulder (starting with a wave trough) and to a lesser degree with that of the stern shoulder and the hips, may attenuate the induced wave profile around the ship, so as to reduce the wave resistance at a specific design speed of a bulb (to a lesser degree for speeds different from design speed).

h.3. An independent wave system is generated by the fitting of the bulb, which can be simply considered as an independent pressure point according to Kelvin, which corresponds to a local negative pressure (due to the accelerated flow around the bulb according to Bernoulli); its superposition with the bow wave system leads to a decrease of the height of the induced wave at the bow and hence of the corresponding wave resistance. The bulb must of course be configured so that an optimum superposition of the two wave systems is achieved (see Fig. 3.51).

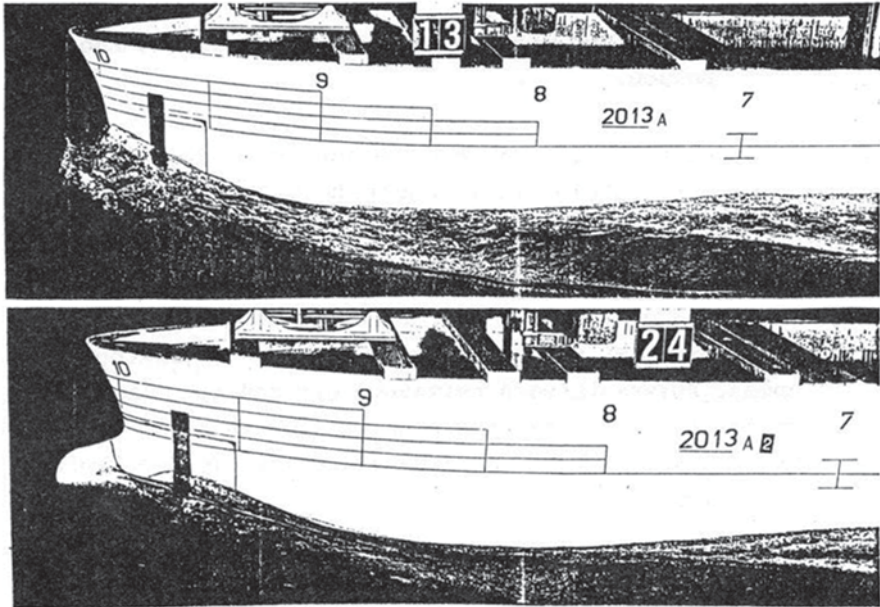

Fig. 3.51 Comparison of bow wave systems of a ship model without (*top*) and with (*bottom*) bulb at the same Froude number, $F_n = 0.218$ (experiments VWS—Berlin)

Fig. 3.52 Refinement of shoulders of sectional area curve of bulky ships with the application of a bulb



h.4. Bulky and slow ships ($F_n \cong 0.15$), like tankers and bulkcarriers, may present (without bulb) significant wave resistance, up to 40% of the total, due to the steep slopes of the hull around the shoulders. With the implementation of the bulb, a part of the displacement corresponding to the bow region is transferred from the shoulders to the bulb, resulting in a refinement of the waterlines and a reduction of the wave resistance, as well as of the eddy making resistance (smoothing of the flow at forward shoulders) (see Fig. 3.52).

h.5. The bulb affects in addition the so-called *wave breaking resistance* related to the flow around the bow. Appropriately configured bulbs, with sharply formed waterline entrances and section profiles, reduce the breaking of the generated bow waves and the corresponding resistance.

h.6. In particular, wedge-type bulbs with much of the volume near the DWL, exhibit ‘steering’ properties due to induced “lift/steering” forces at the bow. Specifically, the

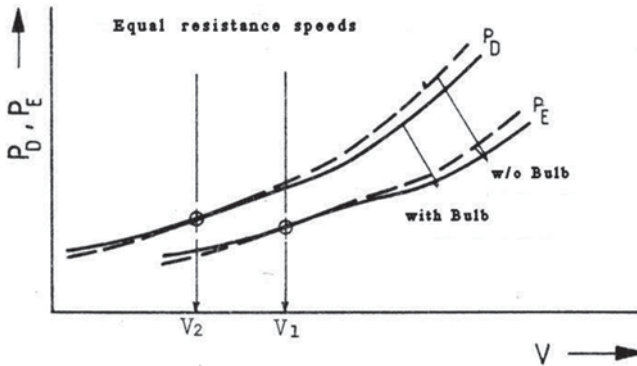

Fig. 3.53 Comparison of the required *effective power* P_E and *delivered power* P_D for a ship with and without bulb

accelerated flow around the bulb, with flow velocity components directed backward and downward, induces lift forces on the bulb and reduces the height of the bow wave.

h.7. With the existence of a bulb and the transfer of displacement below the waterline in the bow region, intense hull form changes around the waterline, which create significant transverse flow accelerations and consequently separations of the flow and generation of vortices, are reduced. The changes arising in the magnitude of the energy loss due to eddy making and the manner of recovering of the energy loss at the stern, i.e., in the region of the wake of the ship and the flow to the propeller, may explain qualitatively the positive effect of a bulb on the *propulsion* (in addition to resistance) of a ship.

h.8. The positive effects of a bulb on the efficiency of the propeller, as shown repeatedly in experiments, may be explained with the following assumptions:

The reduction of total resistance leads obviously to a reduction of the required thrust and the degree of loading of the propeller.

It has been observed in experiments that for ship speeds, which correspond to the same resistance for ship with and without the bulb (see speed V_1 in the Fig. 3.53), the propeller efficiency of the vessel with bulb is higher. This is explained by a better distribution of the wake in the propeller region (as shown by model experiments of Kracht 1978).

h.9. With the implementation of a bulb, the wetted surface of the vessel increases slightly and consequently the frictional resistance; however, this is considered insignificant in comparison to the aforementioned positive effects on other components of total resistance.

i. Magnitude of Reduction in Propulsion Power The exact rate of reduction of the required propulsion power for achieving a certain speed, by comparing a ship with and without the bulb, is practically impossible to be accurately predicted without ship model tests. In such comparisons the following should be observed:

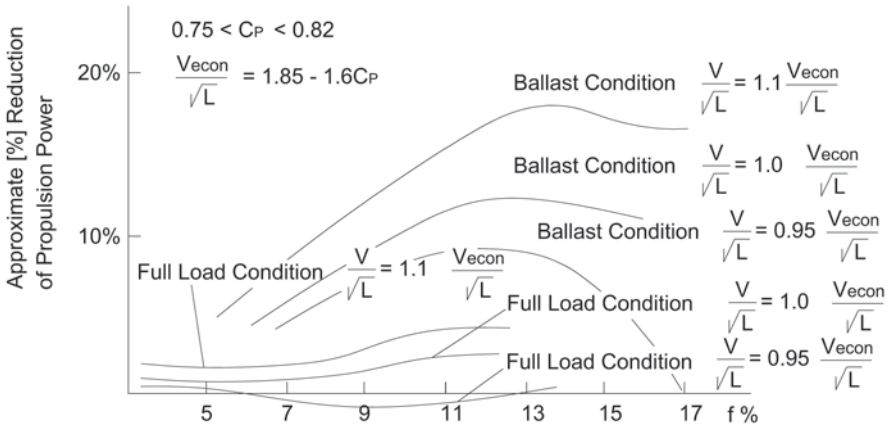

Fig. 3.54 Reduction of the required propulsion power as a function of sectional area of bulbous bow for tankers (illustrative)

- To compare ship's performance with bulb with the corresponding *optimized hull without bulb*
- The geometric features of the bulb and the design speed of the bulb
- The loading condition of the vessel and likely trim

Generally, the achieved reductions in required power are for vessels with high Froude numbers (≥ 0.27), where there is a significant wave resistance, more drastic (6–15%) than for small Froude numbers ($F_n \approx 0.15$), where the rates range between 2% and 5% at full load, but 8–15% in ballast condition. An illustrative example is shown in the following figure; it relates the rate of powering reduction to the sectional area of the bulb section expressed by $f = (A_{BT}/A_M)$, the speed and loading condition of tankers; the example holds for deeply submerged bulbs (see Fig. 3.54).

Some approximate methods for calculating ship's resistance, e.g., the FORMDATA (Guldhammer) or Dankwardt method (see Papanikolaou 2009a, Vol. 2), provide corrections of the resultant resistance in case of fitting of a bulb.

j. Optimal Position of Buoyancy Center The effect of the longitudinal position of the buoyancy center LCB for ships with bulb has not been systematically examined yet. It is considered that if the LCB position for a vessel without a bulb is optimal with respect to resistance, then the shifting of its position forward due to the fitting of a bulb (by about 0.5–0.8% L_{PP} for a bulb with $(A_{BT}/A_M) = 0.10$) does not adversely affect the resistance. Instead, it is particularly favorable for bulky vessels (tankers) because of the offered flexibility in the balancing of trims by ballasting the enhanced forepeak tank.

k. Further Hydrodynamic Criteria

k.1. The course-keeping ability of the ship is hampered to certain extent with the existence of a bulbous bow. The turning capabilities and maneuvering properties of

the vessel are improved due to the shift of the centroid of the lateral underwater profile to the bow. In addition, the possibility for installing a bow-thruster to improve the maneuverability is enhanced.

k.2. Performance in Waves: The effect of the bulb on ship motions in waves is complicated. Basically three phenomena are of interest:

- a. Mitigation of pitch motions
- b. Added resistance in waves
- c. Maintaining the speed and course in waves

The decay of pitch motions increases undoubtedly with the existence of bulb due to the triggered separation of the flow around the vertically moving bulb and the disturbance of the free surface during the emergence-diving of extensive bulbs (increased wave damping). Thus, particularly in resonance/tuning regions of pitch motions (length of the incident wave length approximately equal to the ship length), a reduction of bow motion amplitude is observed. The added resistance of the ship in waves is related to the amplitude of motions, theoretically to the square of the amplitude of motions in heave and pitch, but also to the loss of energy due to motions (equivalence of damping). Thus, the effects of a bulb on added resistance are a function of the incident wave length, with respect to the length of the vessel, of the natural frequency of the vessel in all relevant degrees of freedom (especially pitch and heave), of the wave encounter frequency (which depends on the incident wave frequency, wave heading and ship's speed), the form of the hull and the bulb, and finally the displacement weight and weight distribution of the ship (longitudinal mass moment of inertia).

The maintenance of ship's speed in waves is, besides related to the added resistance, a function of the sensitivity of bow with respect to slamming in head seas. It has been shown in experiments that wedge-type bulbs with sharp bottoms shift slamming phenomena to more intense waves, compared to bulbs that are distinguished by extended, nearly flat bottoms. The latter can trigger strong slamming phenomena, vibrations, and dynamic loads on the structure.

Generally, it is believed that, vessels with bulb are not superior to those without bulb with respect to their performance in waves; however, with proper theoretical/numerical and experimental studies, they can be designed to exhibit comparable or even better seakeeping performance.

k.3. Trim: It has been observed that ships with bulb are characterized by the absence of the undesirable stern trim at high speeds. This is explained by the functionality of the bulb as a "submerged" bow-rudder due to the flow around the bulb and the induced hydrodynamic pressure/lift force.

l. Other Parameters

l.1. Bending moments: increase slightly with the lengthening of the vessel due to the bulb. Particularly important are the dynamic loads on extended/flat bottom bulbs.

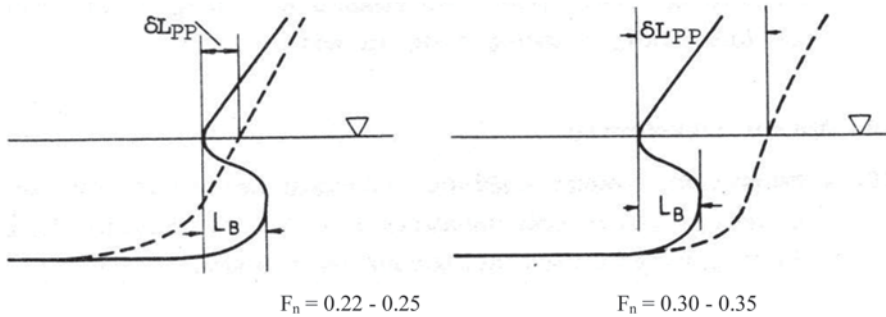

Fig. 3.55 Bow forms of the same hydrodynamic efficiency

1.2. Restrictions on Lengths: are determined by the dimensions of docks, canals, etc.

1.3. Risks of Collision:

- Correct layout of the anchor chain hawseholes to avoid collision with anchors when released on the sides
- Risk of bulb's contact with the end of slipways during launching
- Risk of underwater collision with fixed boundaries (docking walls, piers, rocks, contact with other vessels).

1.4. Navigation in Ice: Generally the possibility of navigating in ice improves with the existence of bulb, especially when it comes to wedge shaped bulbs, which act like an icebreaker.

m. Conclusions

When considering the application of a bulb to a ship under design in view of economic criteria, in addition to the hydrodynamic factors, the designer must be account for the additional construction cost in relation to the anticipated reduced operating costs.

Schneekluth (1985) proposes the comparison of a lengthened ship by δL_{pp} , without bulb, with a ship with bulb at length L_{pp} for the same hydrodynamic "efficiency" (i.e., the same required propulsion power for certain speed) (see Fig. 3.55).

Considering comparative data regarding the propulsive power for relatively slow ships ($F_n \leq 0.24$), a lengthening by δL_{pp} , compared to a comparable bulb protrusion by L_B , was sufficient for achieving the same reduction in propulsion power, while for fast ships ($F_n \geq 0.25$) this is different (see Fig. 3.56 by Schneekluth).

Regarding the associated construction cost, what should be compared is the additional cost of the steel structure due to the elongation by δL_{pp} in relation to the cost for fitting the bulb of the presumed size of protrusion L_B (Fig. 3.57).

The designer's decision regarding the possible application of a bulb to a ship, if not specified by the owner or determined by other factors, must take into account the following:

Fig. 3.56 Required lengthening of normal bow by δL_{PP} as a function of Froude number for achieving the same hydrodynamic performance with a ship with bulb of protrusion by L_B . (Schneekluth 1985)

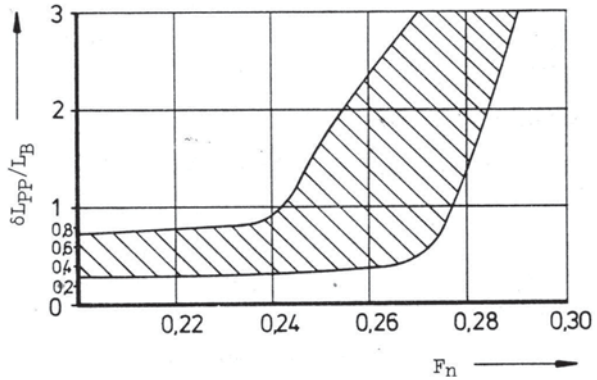
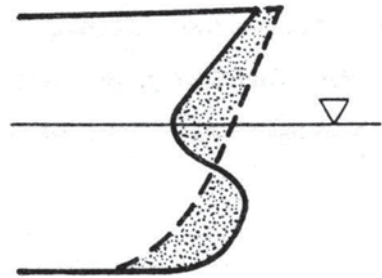

Fig. 3.57 Possible bow forms of the same steel weight



1. When it concerns deadweight carriers (like tankers and bulkcarriers) without margin with respect to the freeboard height (loading to the maximum allowable draft), the lengthening, instead of the application of a bulb, is difficult to implement due to the caused increase of the basic freeboard height according to the International Load Lines regulation.
2. For volume carriers or generally for ships without problems with respect to sufficient freeboard, it is recommended to consider the feasibility of the vessel with bulb and alternatively a lengthening without bulb based on the equivalence of required propulsion power and the additional construction cost (which is function of the built steel weight and the construction effort).

3.4.3 Parabolic Bow

For considerably full type ship hulls with $C_B \geq 0.80$, and low speeds $F_n \leq 0.18$, *parabolic* bow forms have been developed with applications to not only to tankers and bulk carriers, but also to ships with less full hulls, but with high B/T or low L/B ratios. The parabolic bow is distinguished for the parabolic or elliptical form of the design waterline, where the minor axis of the imaginary ellipse corresponds to the width of the ship. With the parabolic bow a significant part of ship's displacement

Fig. 3.58 Comparison of the sectional area curve of a tanker with normal and parabolic bow (*dashed line*)

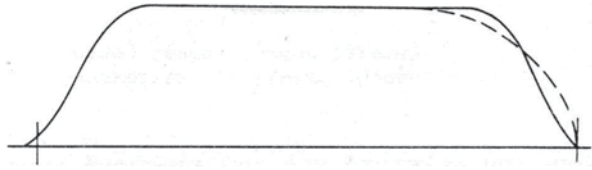

Fig. 3.59 Combination of parabolic bow and cylindrical bulb

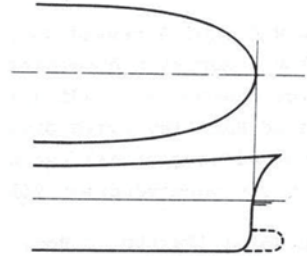

Fig. 3.60 Example of parabolic bow on tanker

is transferred to the bow region, resulting in refinement of the forward shoulder and smoothness of the flow in this area (see Fig. 3.58).

The parabolic bow can be combined with a cylindrical, well submerged bulb (tankers and bulkcarriers, see Figs. 3.59 and 3.60).

It has been demonstrated in experiments of tanker and bulkcarrier models with parabolic bows, with $C_B > 0.8$ and small L/B ratios, that the resulting reductions of the required propulsion power, for $F_n = 0.11-0.18$ are significant. The easiness of construction and reduced building cost should be also noted.

3.5 Form of Stern

3.5.1 Forms of Stern

a. Factors Affecting the Stern Form:

- Calm water performance: low resistance, and minimization of flow separation at the stern
- Good efficiency of propulsion system (propeller/vessel interaction)
 - Streamlined flow to the propeller
 - Good relationship of wake to the thrust reduction factor, expressed by the hull efficiency coefficient:

$$h_H = \frac{1-t}{1-w}$$

- Avoidance of hull and propeller vibrations, sufficient margins/clearances between propeller, rudder and the hull of vessel
- Loss of stability in waves
- Exploitation of stern's deck area
- Construction simplicity

b. Basic Types: The various types of stern are characterized not only with respect to their above waterline form (main characteristic), but also by the wetted part of the hull.

The widely-applied basic stern types, as they have been historically developed/introduced for commercial ships, are as follows (see below Fig. 3.61):

1. The elliptical or elevated stern (Fig. 3.61a)
2. The cruiser stern (Fig. 3.61b)
3. The transom stern (Fig. 3.61c)

Of course there are many variations of these types.

c. Correlation of Stern with the Form of Sections-Waterlines: As mentioned in other sections in more details (see Sect. 4 and 3.2), there is no direct relationship of the form/type of sections and of waterlines with the type of fitted stern in the wider region of the stern of the ship. However, approaching closer the region of the stern end, which influences directly the flow to the propeller, and looking into a ship's body plan, it is observed that the way of closure of the end sections (change of curvature) is for the elliptical stern mainly in the direction of the waterlines; for the cruiser stern type this happens in the direction of the diagonals, while for the transom stern in the direction of the buttocks.

d. Applications: The *elliptical* (elevated) type of stern has almost disappeared in modern ships. It is found sometimes in the traditional Greek wooden boats of type

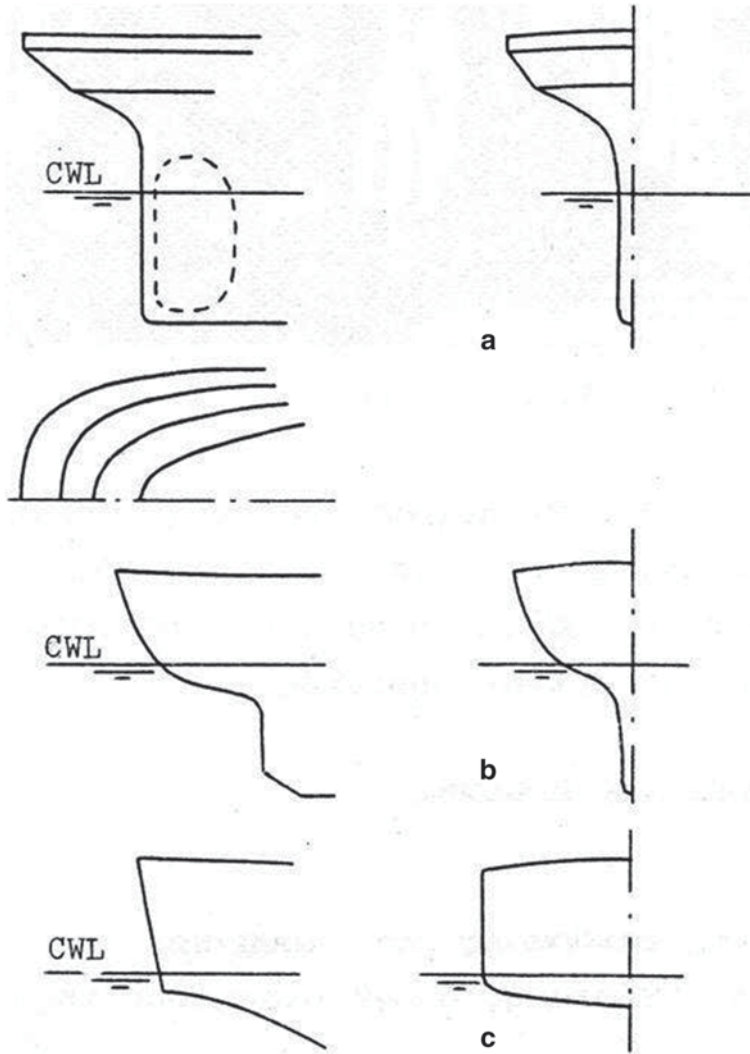

Fig. 3.61 Basic stern types

“καραβόσκαρο” (Fig. 3.62). The *cruiser* type of stern was practically widespread and applied to all types of commercial ships (cargo and passenger) for prolonged time after WWII; however, in the last decades, it has been displaced by the *transom* stern type. The latter type was initially preferred only for high speed small craft, but is nowadays applied to practically all types of ships, large cargo ships, ferries, naval ships, fishing boats, and even to small traditional Greek vessels of “Liberty” type.



Fig. 3.62 Traditional Greek wooden boat of type “καραβόσκαρο” (karavoskaro) with elliptical/elevated stern

3.5.2 *Elliptic or Elevated Stern*

a. Description Its main characteristic feature is the vertical rudder/stern-post which ends above the waterline at the bottom of the stern. The inclination of the stern, which is significant, starts above the waterline and presents a sharp change of curvature with a chine at the height of the upper deck. The termination of the waterlines, at all the levels along the sternpost is sharp (at acute angle) while it takes the form of an ellipse at the height of the upper deck.

b. Evolution of Type It was applied to all commercial ships since the mid-nineteenth century until the first decades of the twentieth century. During the period between the two world wars it was gradually replaced by the cruiser type stern. A peculiar type of elliptical stern can be found today on tugs; it allows the fitting of rudders of large area/height, which enhances ship’s maneuverability (see Fig. 3.63).

3.5.3 *Cruiser Stern*

a. Historical Evolution The development of this type as a further development of the elliptical stern began in the mid-nineteenth century and was originally applied only to naval ships (hence the name). The main reason for this development was the fitting of rudder’s driving mechanism/steering gear, which was at that time at the

Fig. 3.63 Elliptical stern of tug boat

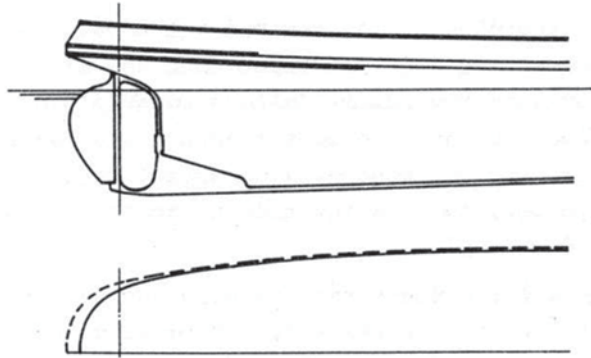

level of the DWL, below the armored deck. Thus the sloping part of the elliptical stern and its displacement was transferred to below the waterline. The first merchant ships fitted with cruiser stern were built in the beginning of the twentieth century. This type prevailed completely after the Second World War, but was recently displaced by the transom stern.

b. Advantages over the Elliptical Stern

- For a given length between perpendiculars the “hydrodynamic length” increases; as a result, the Froude number F_n reduces and this leads generally also to a reduction of resistance.
- The waterlines are smoother near the propeller.
- The moment of inertia of the waterplane area increases significantly, especially in case of stern trim, as the value of initial stability (GM).
- The exploitation of the stern spaces is improved.

c. Recommendation for the Shaping

- The extent at the level of the CWL should not exceed certain limits: it is usually selected as 2~3% L_{pp} , while 4% L_{pp} is considered as upper limit (e.g., guidelines of German Classification Society GL) (Fig. 3.64).
- The stern inclination above waterline should not be pronounced. An appropriate termination of the deck and of close waterlines may be at an almost straight profile line with a slight slope/flare to the vertical (in the lateral plan).
- Regarding the clearances between the propeller and surrounding hull structure, for ships with sternpost, the following values are recommended, according to German (GL) and Norwegian Classification Society (DNV) (Table 3.2):

For twin-propeller ships the following modifications are applied:

$$c > (0.30 - 0.01z) \cdot D \text{ (DNV)}$$

$$a > 2 \cdot D \left(\frac{A_E}{A_0} \right) / z \text{ (German navy specifications)}$$

Fig. 3.64 Shape of cruiser stern

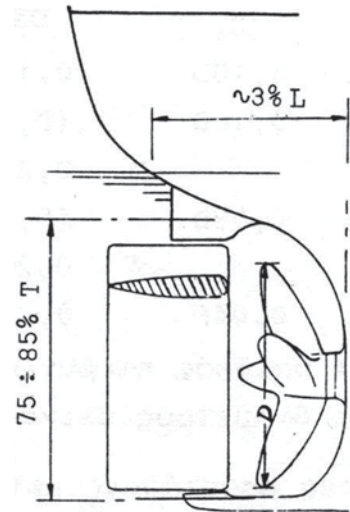

Table 3.2 Minimum distances between propeller and stern hull according to GL and DNV for single propeller ships with sternpost

| | GL | | DNV |
|---|-------|----|---------------------|
| a | 0.10D | | 0.10D |
| b | 0.18D | | (0.35 - 0.02 · z) D |
| | | or | 0.27D for z=4 |
| c | 0.09D | | (0.24 - 0.01 · z) D |
| | | or | 0.20D for z=4 |
| e | 0.04D | | 0.035D |

z number of blades
 D propeller diameter

where (A_E/A_0) is the ratio of propeller areas (expanded to disk area).

The above values are the minimum clearances of the propeller from the stern hull to avoid vibrations, impact of noise, etc. The increase of clearances, beyond the minimum requirements, has the following consequences on the efficiency of the propeller and propulsion system:

- Increase of the vertical clearances c and e implies a reduction of feasible diameter of the propeller and consequently a reduction of the propeller efficiency. However, it has been observed that the dynamic loads on the hull due to the oscillatory hydrodynamic pressure caused by the rotation of the propeller is proportional to the distance c^n , where $n \cong -1.5$ (Schneekluth 1985).
- Increase of the horizontal clearances, a, b, and f, for a given length L_{pp} implies a more voluminous termination of the waterlines and increased resistance. However, due to the simultaneous movement of the propeller away of the sternpost the rate of thrust reduction t is reduced more strongly than the wake coefficient w, so that generally the hull efficiency coefficient $\eta_H = (1-t)/(1-w)$ increases.

Table 3.3 Effects of horizontal distances of propeller-rudder (a) and of propeller-sternpost (f) on the propulsive efficiency η_D by Schneekluth (Fig. 3.65)

| a (%D) | $\delta\eta_D$ (%) | f (%D) | $\delta\eta_D$ (%) |
|--------|--------------------|--------|--------------------|
| 3 | +5.2 | 6 | -0.5 |
| 4 | +2.7 | 7 | -0.2 |
| 4 | +0.7 | 8 | Basis |
| 6 | Basis | 10 | +0.5 |
| 10 | -2.3 | 15 | +1.6 |
| 15 | -5.2 | 20 | +2.8 |

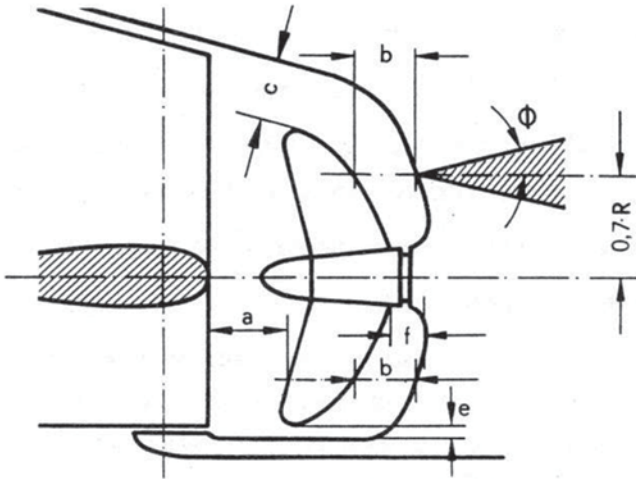

Fig. 3.65 Clearances between propeller and stern hull for ships with sternpost

- Increase of the horizontal clearance from the rudder a (%D) can lead to an increase or decrease of the propulsive efficiency η_D . Depending on the form of the rudder and stern, the following phenomena arise and needs to be assessed:
- Influence of induced forces on the rudder
- Regaining of energy of angular momentum in the wake of the propeller
- Regaining of energy of vortices generated behind the propeller

These effects can be clearly observed in model experiments of self-propelled models with and without a rudder.

In the following table the effects of clearances on the propulsive efficiency factor η_D are given by Schneekluth (1985; Tables 3.3 and 3.4):

- For ships without sternpost (suspended rudder), the values given in Table 3.4 for the tolerances are proposed, which apply equally to transom sterns (see Fig. 3.66).

The advantages of a stern without stern/rudderpost are:

1. Reduction of resistance due to the absence of rudderpost and the possibility of lengthening of the waterline
2. Reduction of surfaces that are receptors of dynamic, thrust excitations

Table 3.4 Clearances between propeller and stern hull for suspended/hanging rudder by Abrahamsen (Fig. 3.66)

| |
|--|
| $a=0.09D$ |
| $b=0.15D$ or $D(1+C_s)$ |
| $c=0.08-0.15D$ |
| Where |
| $C_s=T/(\rho n_p^2 D^4)$ nondimensional thrust coefficient |
| T: Propeller thrust force |
| n_p : Propeller revolutions |

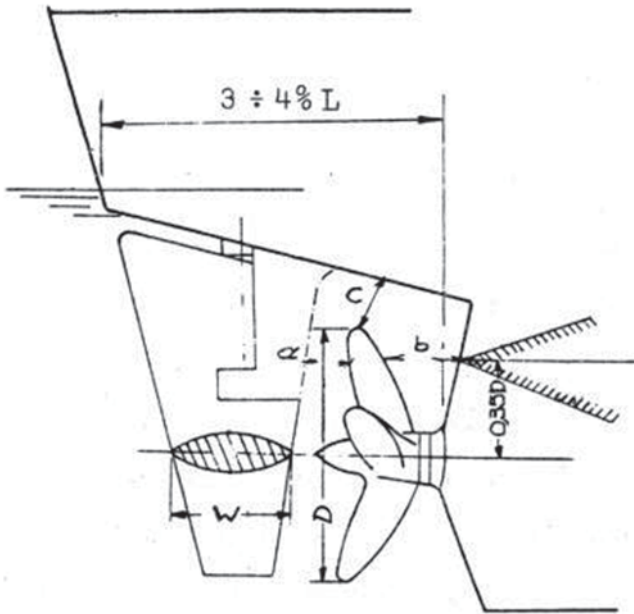

Fig. 3.66 Clearances between propeller and stern hull for suspended rudder (without sternpost)

3. Fitting/use of larger diameter propeller

The disadvantages include:

1. More difficult mounting/bearing of the rudder axis
2. Particular rudder vibrations due to way of rudder mounting

d. Special Forms of Cruiser Stern

- “Canoe” type stern on sailing boats.
- Ellipsoidal on tugboats, pilot boats, and small boats.

3.5.4 Transom Stern

Evolution of Type The transom stern (German: Spiegelheck) may be regarded as a further development of the cruiser stern; it is also an independent development of

Fig. 3.67 Transom stern with wedge

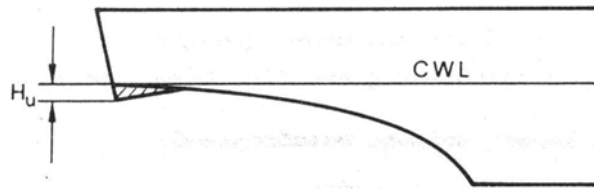

a stern type required for the operation for high speed crafts. As an evolution of the cruiser stern it was created by cutting off the curved termination of the stern and replacing it with a flat surface, which simplified the fitting of ship's end of stern panel plates. Initially, it has been applied to several fast cargo ships, like fast reefer ships (in the 1960s), but nowadays is applied to all known types of commercial and navy ships.

As stern type for high speed craft, e.g., small attack and naval ships operating at high Froude numbers, it is designed to reduce resistance via two main effects:

- For fully submerged transom stern and high speeds the separation/detachment of the flow should takes place deliberately at the edges of the transom without generation of strong vortices (in contrast to the situation at low speeds).
- Especially, when adding a stern wedge at the bottom of the transom (see Fig. 3.67), a reduction of the height of the generated wave behind the stern is achieved, while in addition a stern-up moment is created (due to the induced lift forces on the wedge), so as to balance the developed running (dynamic) stern trim of the vessel.

Various types of transom stern are shown in the Fig. 3.68 below:

- a. (a): high-speed boat
- b. (b): naval ships
- c. (c): cargo ships
- d. (d1) to (d5): various forms

b. Advantages Against Cruiser Stern

1. Better exploitation of deck area
2. Simplification of construction
3. Additional buoyancy/lift at the stern with the possibility of balancing stern trims
4. Increase of waterplane moment of inertia and of initial stability (\overline{BM})
5. For high speeds, reduction of resistance due to control of flow separation point and the creation of vortices
6. For high speed boats ($V/\sqrt{L} > 1.5$) the following also holds:
 - a. Decreased ventilating of propeller and rudder
 - b. Ensuring at least atmospheric pressure at the height of sternpost
 - c. Smooth flow to the propeller
 - d. Shifting the cavitation point of the propeller to higher speeds

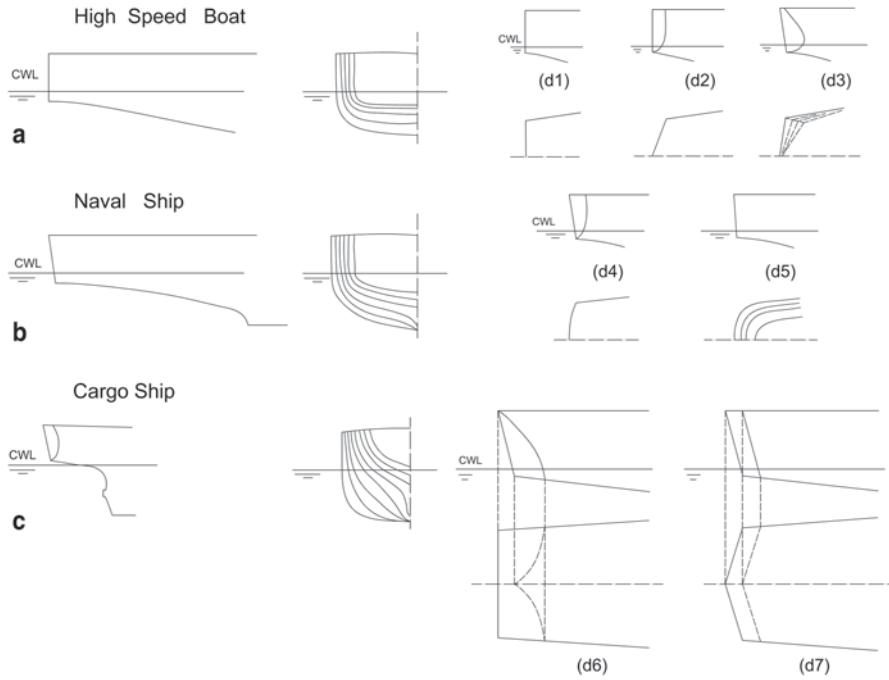

Fig. 3.68 Various types of transom sterns

c. Disadvantages Compared to Cruiser Stern

1. Increase of resistance at low speeds (not always)
2. Decrease of propulsive efficiency η_D and hull efficiency factor η_H due to the anticipated reduction of the wake coefficient w compared to cruiser stern hulls.
3. Increase of hull vibrations due to larger projected area to the propeller, resulting in requirements to increase the clearances between propeller and stern hull or to reduce the diameter of the propeller. Thus, for fast ships ($F_n > 0.3$), with transom stern form, the following is applied to the clearances according to Germanischer Lloyd (see Fig. 3.66):

$$a \geq 2(A_E/A_D) \cdot D/z$$

and

$$c \geq 0.25D$$

4. Worse performance in waves due to:
 - a. The shift of the pitching axis to the stern (increased movements of bow)
 - b. Drastic reduction of dynamic stability in waves by the possible emergence of the stern (loss of waterplane area)

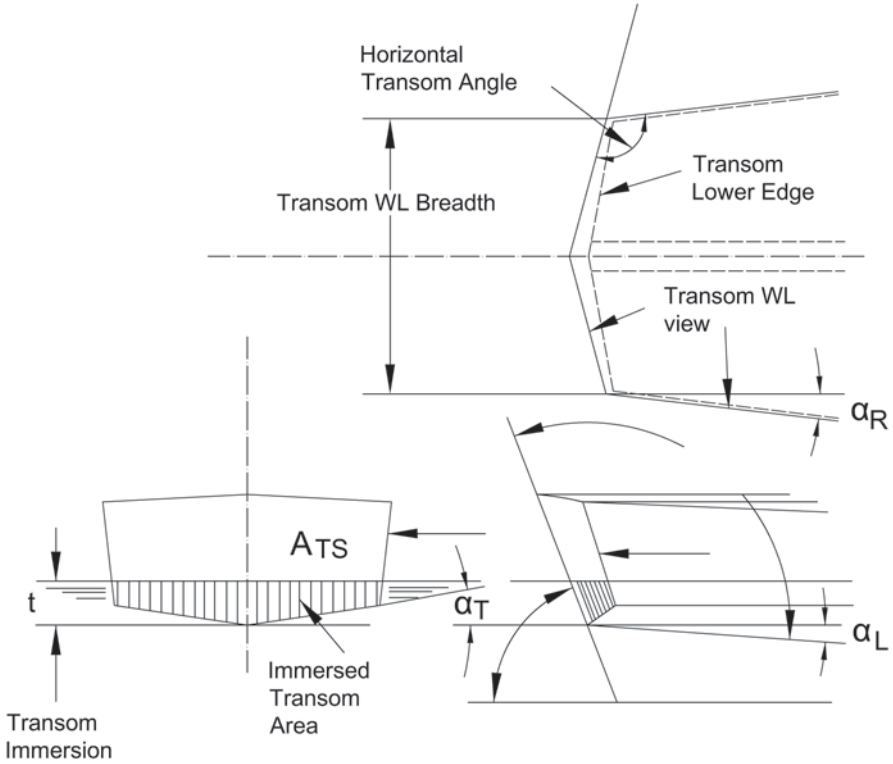

Fig. 3.69 Schematic representation of transom arrangement

c. Slamming at the stern (pounding) in the case of excitation by following seas and severe deck wetting

d. Guidelines for Transom Stern Design

d.1 Submergence Extent: Targeting a possible resistance reduction by control of the flow separation at the edge of the transom, the submergence of the lower edge of the transom is recommended to be taken according to the following guidance values:

- $F_n < 0.3$: The lower edge of the transom should be located slightly above the CWL, so as to submerge slightly in the generated stern wave
- $F_n \cong 0.3$: Also relatively small transom, lower edge slightly submerged
- $F_n \cong 0.4$: Transom is recommended with a wedge-shaped ending, submergence of lower edge $t \cong (0.1 - 0.15) \cdot T$ or $A_{TS}/A_M \cong 0.09$, where: A_{TS} : projected area of submerged transom (see Fig. 3.69)
- $F_n \geq 0.5$: Transom is recommended with a wedge of width about the beam of the vessel and submergence of lower edge $t \cong (0.15 - 0.20) \cdot T$ or $A_{TS}/A_M \cong 0.10$
- $F_n = 0.6$: Further increase of the immersion of lower edge $A_{TS}/A_M \cong 0.13$

Remarks:

1. The above values are certainly indicative.
2. The possible reduction of resistance can be expected only for high Froude numbers ($F_n \geq 0.30$) and well submerged lower edge of the transom (mainly for high-speed craft, torpedo boats, less for cargo ships or ferries).

d.2 Breadth at Waterline: The breadth of the transom at the design waterline is a function of the slope of the waterlines (against ship's symmetry plan) around the CWL. This inclination should be as small as possible to avoid early flow separation at the hips of the vessel. Typical maximum values of the inclination angle of the waterlines at the transom are: $\alpha_R \equiv 12-13^\circ$. The same also applies to the angles of the diagonals with respect to the plane of symmetry. Thus the width of the transom in the waterline can be up to 80–90% of the maximum vessel's beam.

d.3 Inclination of Transom Bottom: The inclination of the bottom of the transom α_T , measured in the transverse plane between transom's bottom and waterline (see Fig. 3.69), should be between 15° and 20° to avoid intense pounding. Also, the corresponding inclination of bottom α_L in a horizontal reference plane parallel to the longitudinal sections (buttocks), should be kept relatively constant, especially near the transom (max = 15°). Finally, a slight inclination in the lateral profile of transom (corresponding to a protrusion of the deck) against the vertical is recommended for improving ship's protection against deck wetness by incoming following seas.

References

- Dudszus A, Danckwardt E (1982) Schifftechnik—Einführung and Grundbegriffe (in German). VEB Verlag Technik, Berlin
- Eckert E, Sharma S (1970) Bulbous Bows for slow, full type ships (in German), Trans. Schiffbautechnische Gesellschaft (STG)
- Friis AM, Andersen P, Jensen JJ (2002) Ship design (Part I & II). Section of Maritime Engineering, Dept. of Mechanical Engineering, Technical University of Denmark. ISBN 87-89502-56-6
- Guldhammer HE, Harvald SA (1974) Ship resistance: Effect of form and principal dimensions. Akademisk Forlag, Copenhagen
- Kerlen H (1971) Design of Bulbous Bows for full Ships from the practical point of view, Journal HANSA, p. 1031
- Kracht A (1978) Design of Bulbous Bows. SNAME Trans 86:197–217
- Lewis EV (ed) (1988) Principles of naval architecture, vol. I–III. SNAME Publication, New York (revision of the book: Comstock DP (ed) (1967) Principles of naval architecture. SNAME Publ., New York)
- Papanikolaou A (2009) Ship design—methodologies of preliminary ship design, Vol. 1 (in Greek: *Μελέτη Πλοίου—Μεθοδολογίες Προμελέτης Πλοίου*). SYMEON, Athens. ISBN 978-960-9600-09-01 & Vol. 2, ISBN 978-969-9400-11-4, October 2009
- Spanos D, Papanikolaou A (2006) Numerical simulation of parametric roll in head seas. Proc. 9th International Conference on Stability of Ships and Ocean Vehicles, Rio de Janeiro, Brazil, September 2006
- Schneekluth H (1985) Ship design (in German). Koehler, Herford
- Strohbusch E (1971) Entwerfen von Schiffen I–IV. Lecture notes (in German). Technical University, Berlin

Chapter 4

Naval Architectural Drawings and Plans

Abstract This chapter deals with the basic naval architectural drawings and plans (ship lines, general arrangement and capacity plan), which are required in the course of a ship's design and construction process. Modern shipyards and design offices use more and more computerized representations of the ship, from the first layout, to ship design and the production process, thus hardcopies of the plans are used less and less. However, the basic naval architectural plans are essential from a conceptual point of view and serve the needs of information exchange during the design and construction procedure, namely

- Approval of ship's design and construction by the classification society and flag registry authorities
- Information medium for ship's operation
- Information medium for the overall manufacturing process

The present chapter defines a ship's basic drawings and plans, elaborates on the design of the ship's hull form and ship lines by use of traditional methods and data of systematic hull form series, when no relevant information is available from similar ships and by use of interpolation and distortion methods, when the lines of parent ships are available. It proceeds with the elaboration of the procedure for setting up ship's general arrangement plan and closes with the preparation of ship's capacity plan. The various design steps are supported by illustrative examples of application.

4.1 General

The naval architectural drawings and plans required in the course of a ship's design and construction process may be classified into the following general categories:

- *Ship lines*: graphical representation of the ship's hull form.
- *Diagrams of results of calculations*: set of diagrams with the ship's hydrostatics, stability and Bonjean curves, diagrams of distributions of shear stresses and bending moments, etc.
- *General overview plans*: general arrangement of spaces and outfitting, capacity plan, loading plan, plans of piping/cablings systems, general construction

drawings of steel structure showing the longitudinal structural profile and mid-ship section, of decks, bulkheads, etc.

- *Detailed construction drawings*: detailed construction plans with manufacturing instructions for the production units of the shipyard, the paneling, mechanical, piping, carpentry workshops, etc.).

The above mentioned graphical representations¹ constitute the basis for serving the following objectives:

- Information exchange during the design and construction procedure
- Approval of the ship's design and construction by the classification society and flag registry authorities
- Information medium for the ship's operation
- Information medium for the overall manufacturing process

The following Table 4.1 (Taggart 1980) lists the main drawings and plans that must be developed in the final stage of ship's *contract* design (Technical specifications of the contract between shipyard and shipowner).

4.2 Ship Lines Plan

The Ship lines plan (German: Schiffslinien Plan) is the basis for the processing the following steps of ship design:

- *Hydrostatic calculations*: development of a set of hydrostatic diagrams and ship stability curves
- *Construction of scaled ship models* for experiments of calm water resistance-propulsion and seakeeping in seaways in a towing tank or ship model basin
- Development of plans that depend on the ship's hull geometry (volumetric curves, general arrangement drawings, etc.).
- Development of the ship's outer *shell expansion*, development of cutting patterns for plates, mold frames (*lofting*²), etc.; inspection tool for controlling the geometry of elements relating to ship's outer shell, etc.

¹ Modern shipyards use more and more computerized representations of the ship, from the first layout, to ship design and the production process. Having digitized the whole or part of the production process, many shipbuilding projects can be planned by the yard in parallel and the production/assembly can be tested in advance. In this *virtual* production world, construction drawings and plans are hardly used. This saves time, money, and leads to higher efficiency. One of the world leaders in the use of modern computer technology in all phases of shipbuilding is the European yard *Meyer Werft* (www.meyerwerft.de). The yard, which is located in the small town of Papenburg in northwestern Germany, was founded in 1795 and is in sixth generation in the hands of the Meyer family. It is a world leader of large passenger and cruise ship design and construction.

² Lofting is the process of generating a large (sometimes full) scale lines plan or "lay-down" to mold ship's frames and actual ship components.

Table 4.1 Typical plans required in the contract design of a merchant ship (Taggart 1980)

| |
|---|
| Outboard profile, general arrangement |
| Inboard profile, general arrangement |
| General arrangement of all decks and holds |
| Arrangement of crew quarters |
| Arrangement of commissary spaces |
| Line |
| Midship section |
| Steel scantling plan |
| Arrangement of machinery—plan views |
| Arrangement of machinery—elevations |
| Arrangement of machinery—sections |
| Arrangement of main shafting |
| Power and lighting system—one line diagram |
| Fire control diagram by decks and profile |
| Ventilation and air conditioning diagram |
| Diagrammatic arrangements of all piping systems |
| Heat balance and steam flow diagram—normal |
| Power at normal operating conditions |
| Electric load analysis |
| Capacity plan |
| Curves of form |
| Floodable length curves |
| Preliminary trim and stability booklet |
| Preliminary damage stability calculations |

The representation of the 3-D, nonplanar surface of the outer shell of a ship can be accomplished in the following ways:

- a. Graphical representation of the 3-D ship hull on the basis of a set of graphs/curves of 2-D cuts/sections of the hull with a series of parallel to each other planes with respect to the transverse (*sections plan*), horizontal (*waterlines plan*) and longitudinal direction (*sheer plan*); see typical lines plans in Figs. 4.1, 4.2, 4.3, 4.4, 4.5, 4.6, 4.7, and 4.8
- b. Numerical representation based on properly formatted coordinates of points of the hull (offsets)
- c. Analytical representation based on mathematical functions and associated parameters (polynomials, cubic splines, bisplines, Coon surfaces, Bezier curves, etc)
- d. Stereophotographic representation of the ship's hull or 3-D scanning with 3-D Laser
- e. Three-dimensional analogue model.

All the above ways of representing the ship's hull serve specific requirements of the design and construction process and often are used simultaneously in the development of optimal hull forms and for the optimal design and construction process of the ship.

Particularly, the graphical representation (a), namely the set of 2-D ship lines, is characterized by its great expressiveness (for knowledgeable naval architects) and

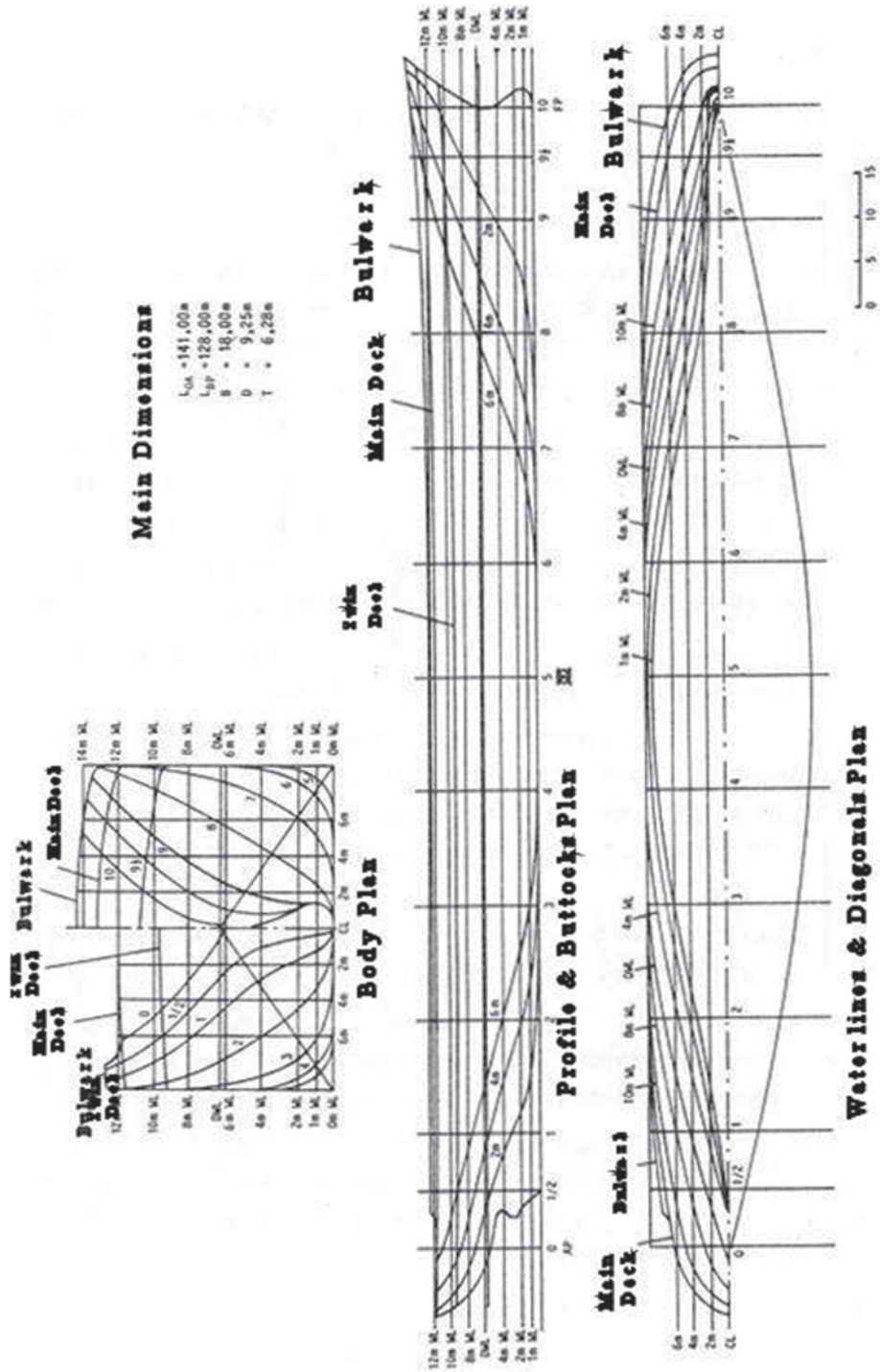

Fig. 4.1 Typical drawing of lines plan (Antoniou and Perras 1984)

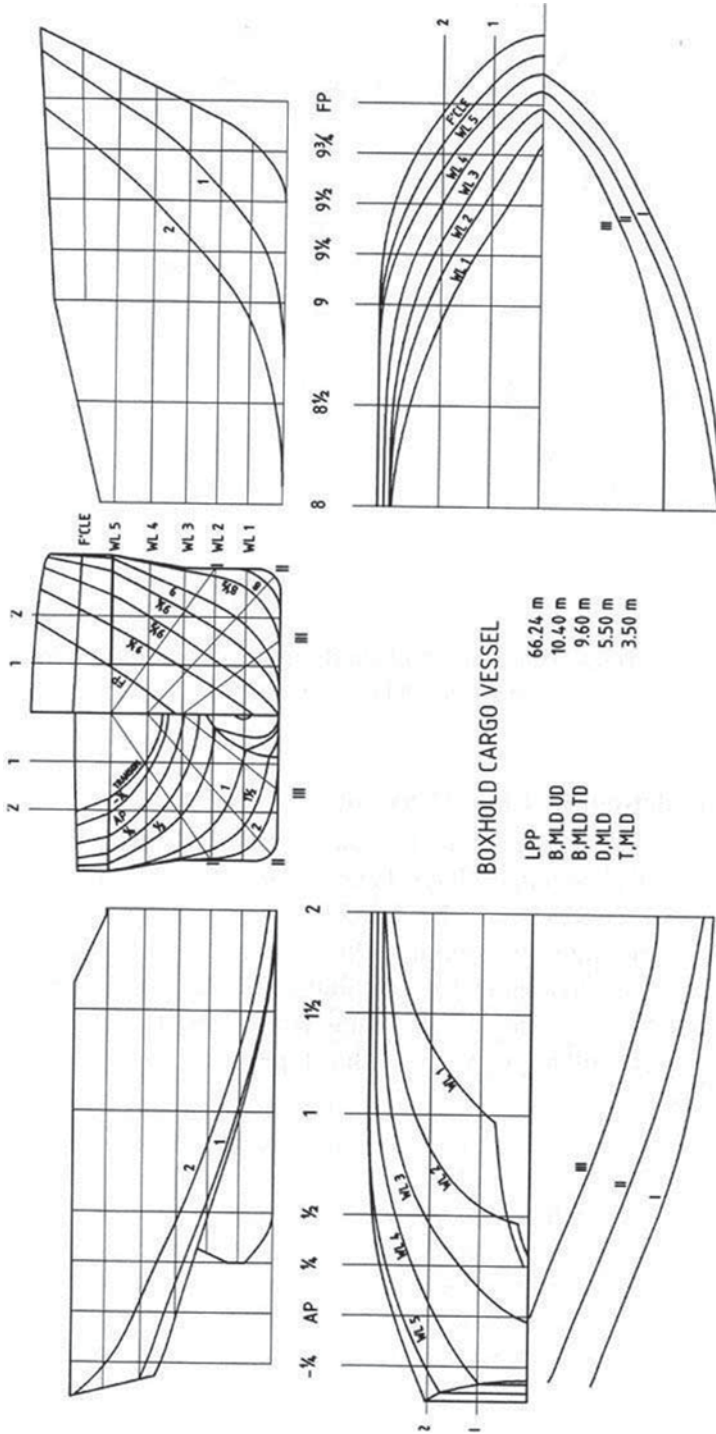

Fig. 4.2 Ship lines plan of a cargo ship (Frits et al. 2002)

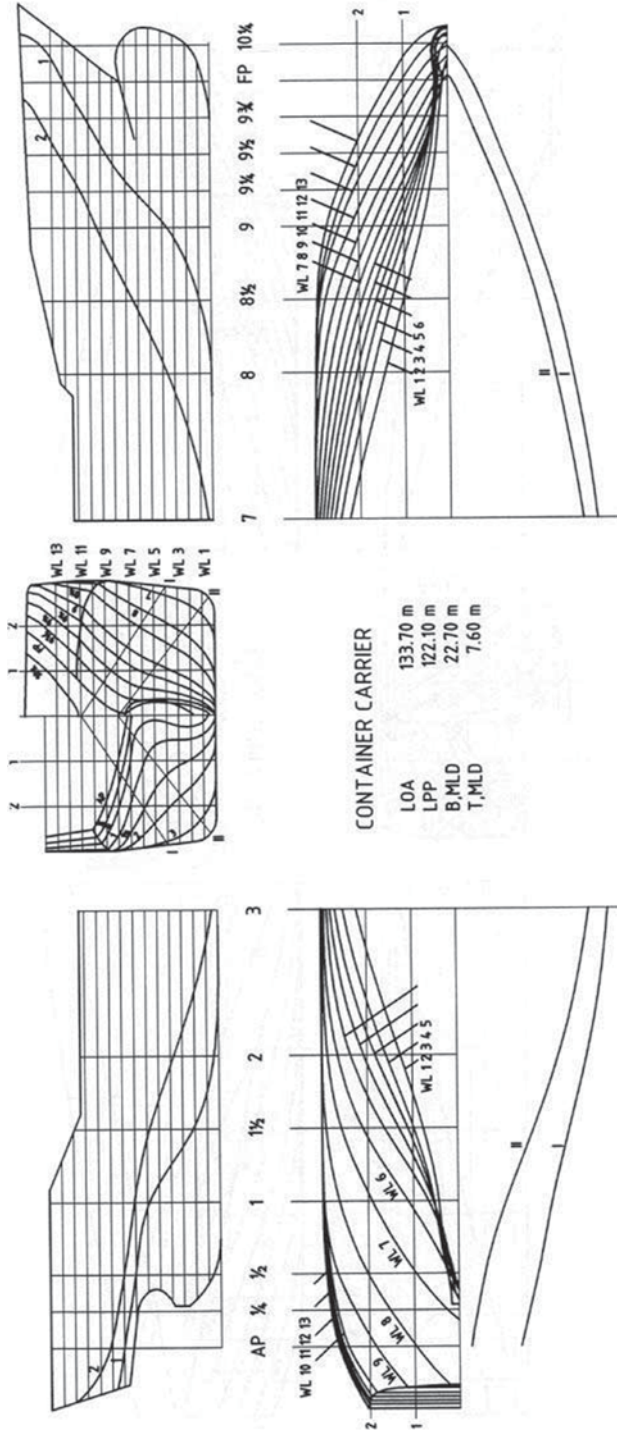

Fig. 4.3 Ship lines plan of a feeder container ship (Fris et al. 2002)

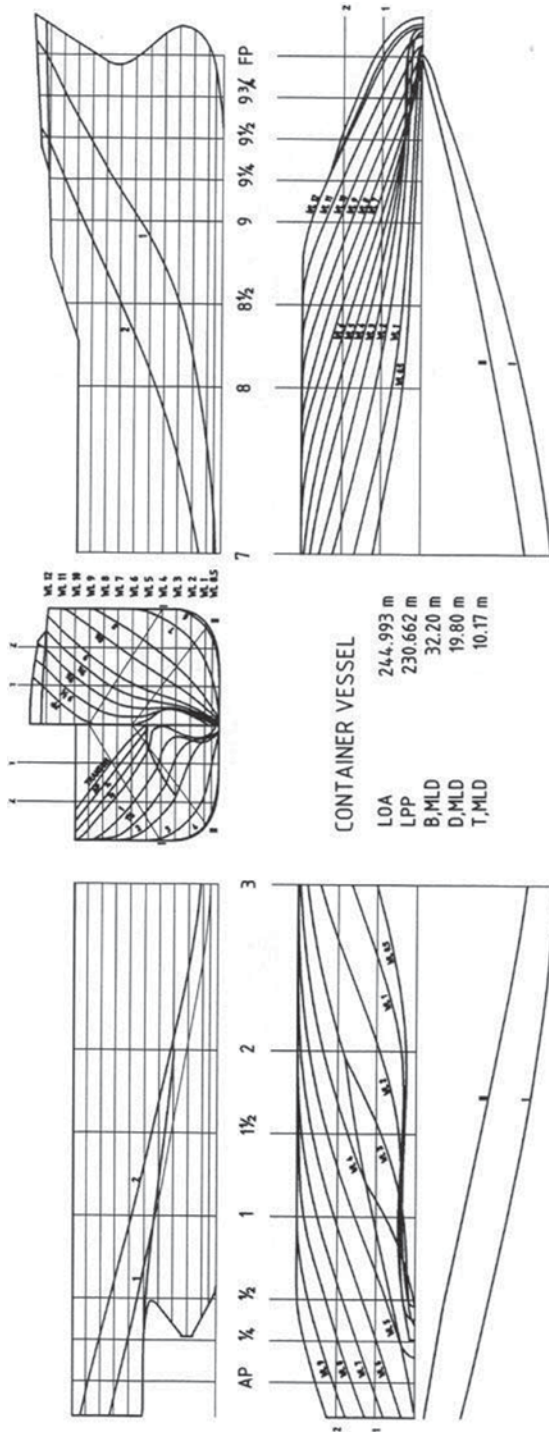

Fig. 4.4 Ship lines plan of a PANAMAX container ship (Friis et al. 2002)

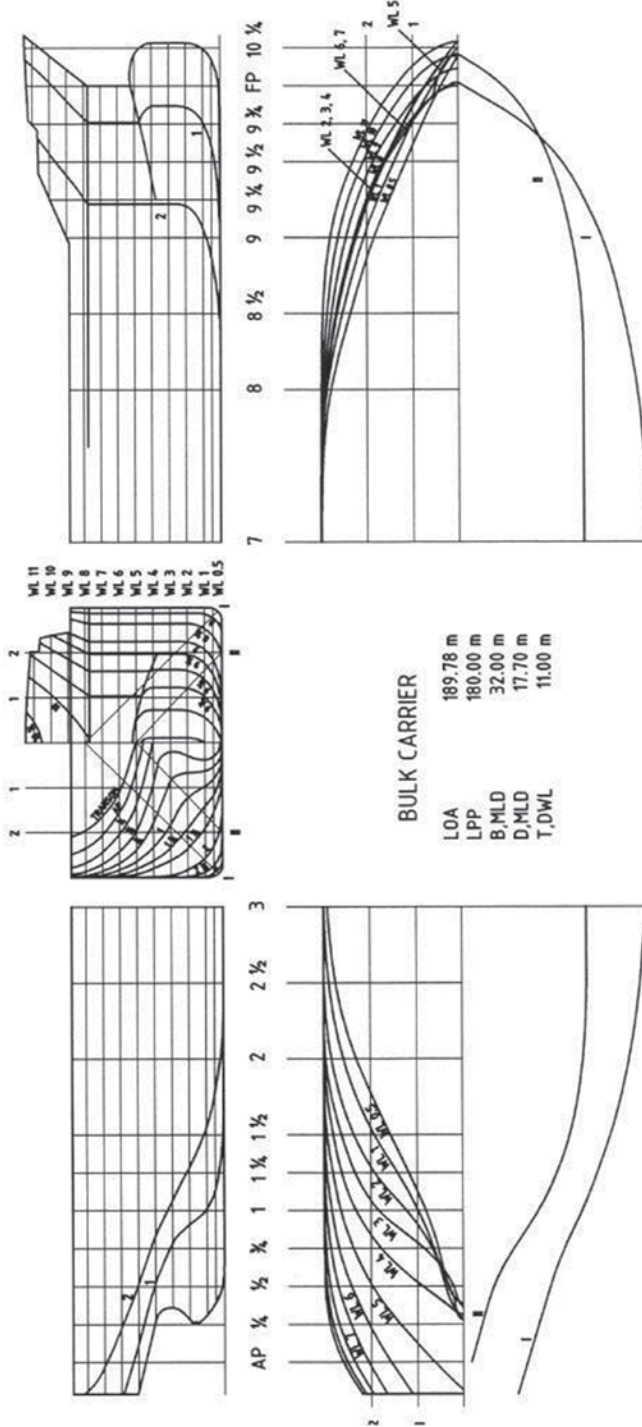

Fig. 4.5 Ship lines plan of a PANAMAX bulk carrier ship (Frisi et al. 2002)

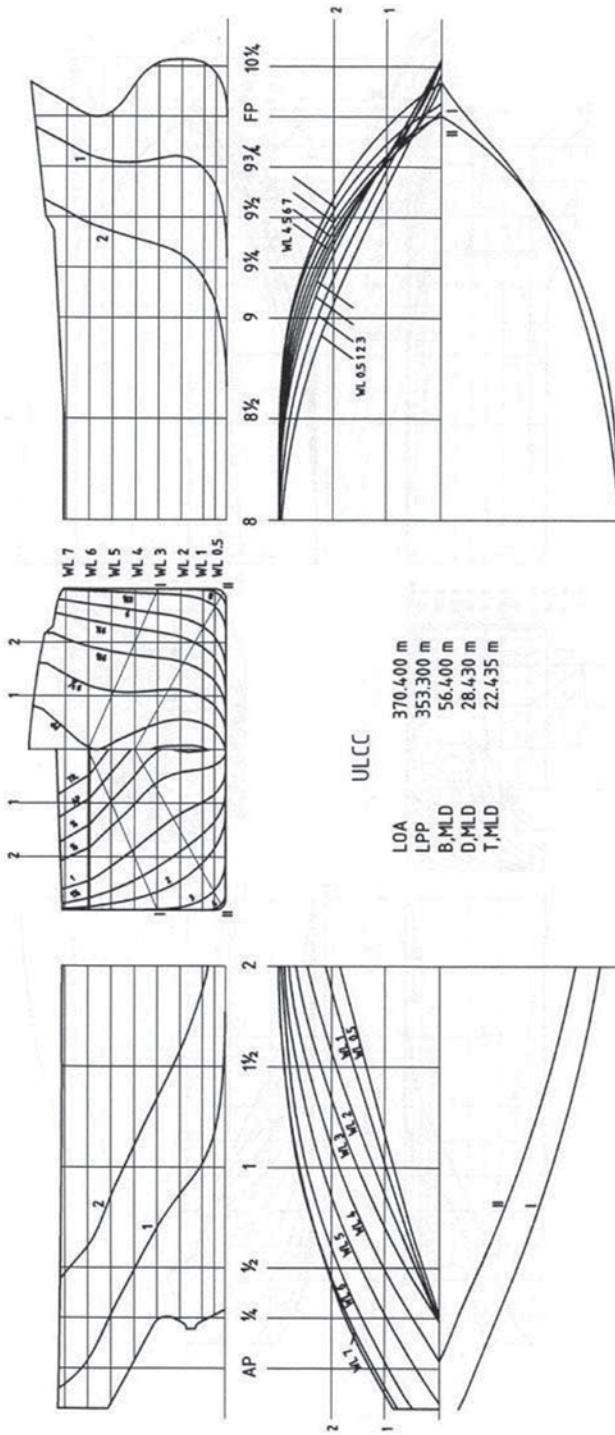

Fig. 4.6 Ship lines plan of an ultra large crude carrier (ULCC) tanker ship (Fruis et al. 2002)

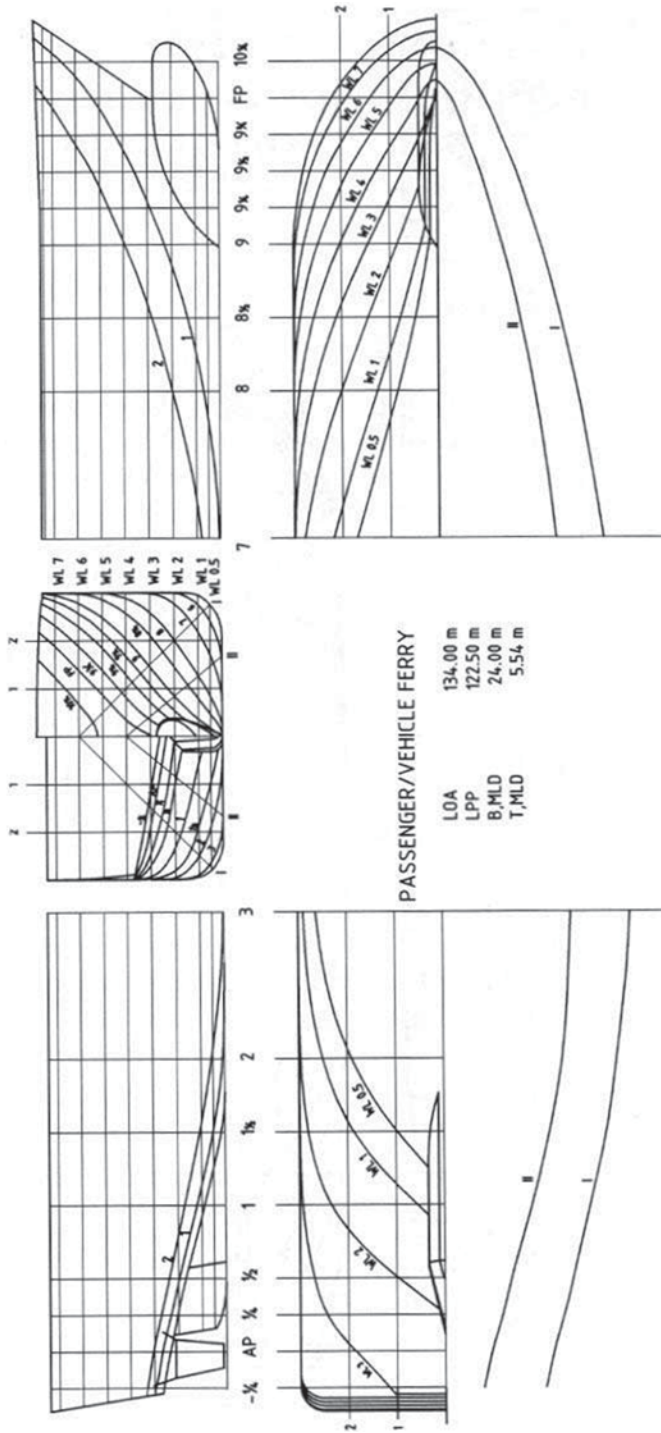

Fig. 4.7 Ship lines plan of a RoPax ship (Friis et al. 2002)

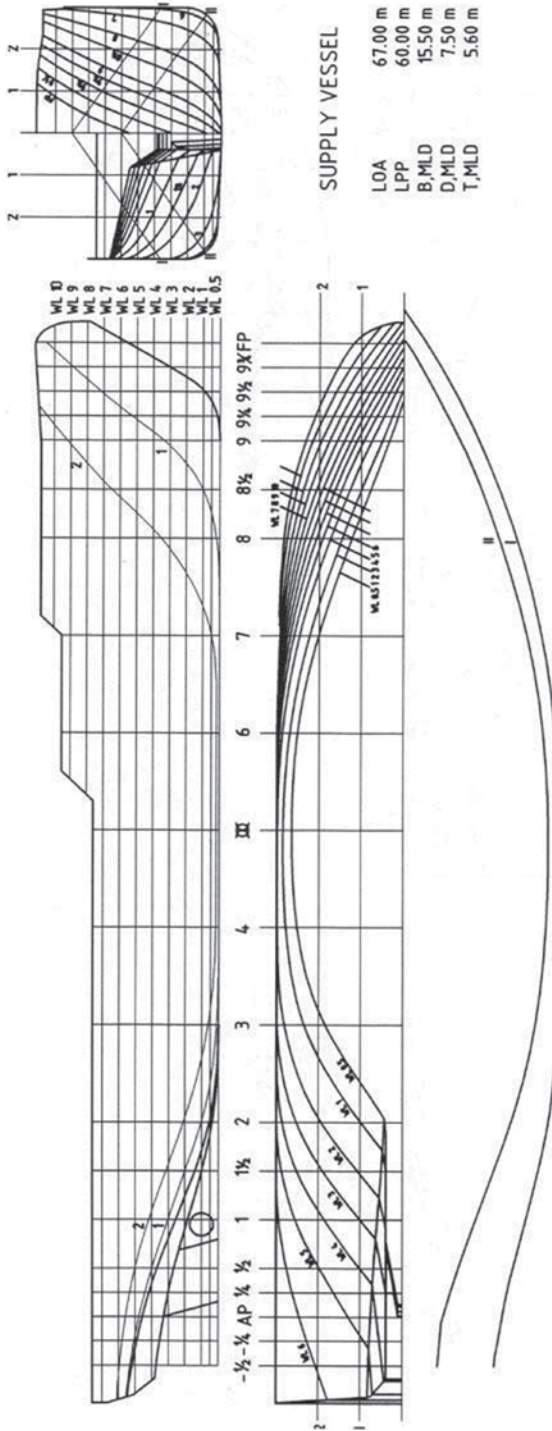

Fig. 4.8 Ship lines plan of a supply vessel (Friis et al. 2002)

allows easy modification or adjustment of the lines to the specific requirements of the ship. Furthermore, the coordinates of the lines can be easily discretized (by digitizing them) and along with the numerical representation (b) the access to computer hard and software tools is enabled in the context of computer aided ship design—CASD (Papanikolaou and Zaraphonitis 1988).

The analytical representation (c) can save computer hardware “memory” in storing a sufficient amount of coordinates for the accurate description of the ship’s hull form in accordance with the requirements of the various phases of the design process. Also, the use of contemporary mathematical tools and functions, e.g. bispines, Bezier curves, Coon’s surfaces, etc., facilitates the process of optimization and of hull lines fairing during both the initial and final stages of ship design (Papanikolaou and Zaraphonitis 1988).

The stereometric, 3-D representations (d) can be used for a better representation of the curved surfaces at the bow and stern of the ship, as well as for the approximation of the flow streamlines at both ends of the ship.

4.3 Introduction to the Development of Ship Lines Plan

A. Formulation of the Problem For the development of a ship’s lines plan during the initial design stage, the following data may be considered known:

- the principal ship dimensions of length, breadth, draft
- the hull form coefficients, especially C_B
- the approximate longitudinal position of the longitudinal center of buoyancy (LCB)

The most important factors affecting the form of ship’s lines are:

- resistance and propulsion in calm water
- added resistance and powering in waves
- maneuvering properties
- course-keeping ability
- seakeeping behavior in seaways; roll damping
- cargo hold volume

As the main ship characteristics of L , B , T , and C_B are considered given, the flexibility on configuring a ship’s lines is to a certain degree limited. The remaining basic steps are:

- determination of the longitudinal distribution of ship’s displacement, i.e., the determination of the sectional area curve and LCB
- selection of midship section coefficient C_M , if it has been not yet concluded
- configuration of bow and stern

B. Conventional Design Procedure It is considered that the lengthwise distribution of ship’s displacement is known from comparable data of known systematic ship model series, e.g. Series 60 or Series Wageningen (Lap, see Appendix B).

These systematic hull form series provide diagrams, in which the areas of sections 0–20 is given as a function of the ship's prismatic coefficient C_p and in percentages of the midship section area A_M . Also, the prismatic coefficients of bow and stern, C_{PF} and C_{PA} , are introduced.

After the preparation of a necessary grid of basic lines (*canvas*), which correspond to the projected basic sectional planes in the transverse, vertical and longitudinal direction, the design procedure is as follows:

1. *design of the midship section*
2. *preliminary design of the bow and stern profiles*
3. *sketch of some sections at the bow (sections No. 14–17) and stern (No. 3–5) and approximation of their areas with the help of a mechanical planimeter (or another tool)*
4. *correction of the resulting sectional areas and of the corresponding lines to match the initially given sectional area curve*
5. *design of the design waterline based on the previous data*
6. *tuning of the waterline and cross sections—control of initial stability (anticipated value of metacentric height) through the moment of inertia of the design load waterplane*
7. *design and fairing of the waterline at the height of half-draft*
8. *sketch of remaining sections up to the design waterline height*
9. *design and fairing of the above waterlines, correction of bow–stern*
10. *completion of sections up to the uppermost deck*
11. *fairing of waterlines above the design load waterline*
12. *fairing of sections*
13. *design of the diagonals*
14. *design of the buttock lines*
15. *completion of intermediate sections at the ends (bow and stern)*
16. *completion of intermediate waterlines for small draughts*
17. *final check of displacement, LCB and metacentric height above the baseline (\overline{KM})*

The above procedure may be modified, particularly with respect to steps 7–11, with the simultaneous design of the diagonals and longitudinal cuts/buttock lines (13–14), so as to facilitate the fairing of the sections and the waterlines.

The fundamental principle in the fairing of ship lines is that a smooth flow and associated streamlines lines should not be sacrificed for accurately satisfying the specifications of the initially assumed sectional area curve that has been derived/concluded from systematic model series. However, any deviation of the LCB from the desired (optimal) position should be treated with great care.

The allowable tolerances with respect to the resulting displacement and center of buoyancy are a function of ship type and of other design tolerances. Typical values for the displacement are in the range of $\pm 0.4\%$, if the sum of weights tolerance is 1–2% and for the center of buoyancy (longitudinal position) $\pm 0.2\% L_{pp}$.

C. Ship Lines Design by Use of Existing Lines

Bibliography

- Lackenby, M., Transactions RINA 1950, p. 289
 Schneckluth, H., Journal Schiffstechnik, 1959, p. 130
 Söding, H., Journal Schiff und Hafen, 1971, p. 991
 Nowacki, H., Lectures Notes CASD, Univ. of Michigan, Summer School, 1970
 Nowacki H., Five decades of Computer-Aided Ship Design, Journal Computer-Aided Design 42 (2010) 956-969
 Lechter, J., The Geometry of Ships, The Principles of Naval Architecture Series, ed. J. R. Paulling, SNAME Pub., 2009

Basic Procedure Based on the available lines/data offsets of similar ships the wetted part of the hull is first developed; in the following the remaining (above water-plane) part of the hull is developed following the conventional way of hull form design.

Advantages Compared to the conventional way of designing ship's hull form (see **B**), the present method is superior in terms of the following points:

1. reduced effort due to the decoupling of the tuning of the sectional area curve and the lines development
2. because of the availability of the hull form characteristics of the parent ship, it is possible to estimate at an early stage many of the hydrostatic values of the study ship, even before the completion of her hull form design (see e.g., paragraphs 2.18.5 and 2.18.6).

Distortion Methods (in German: Verzerrungsmethoden) The distortion of an existing lines plan of a parent ship to other dimensions and characteristics can be achieved in different ways, namely by methods falling into two main categories:

C1. Distortion of existing lines, which may be given through drawing plans or tables of coordinates (offset tables), by multiplying the hull form coordinates with constant coefficients and/or by shifting of the hull form cutting planes, leading to modified waterlines, sections, and diagonals

C2. Distortion of lines given by analytical/mathematical formulas

The following subgroup of methods belong to the C1 category of methods, which are all characterized by the existence of hull offset points:

C1.1. The *simple affine (homologous) distortion*, in which the offsets in the longitudinal, transverse and vertical direction change by a constant scale ratio, which may be different for each direction. If the three ratios are the same, this obviously leads to a proportional *enlargement or reduction* of the hull (*geometric similarity*)

C1.2. The *modified affine (homologous) distortion*

C1.3. The *non-affine (heterologous) distortion*, in which one or more ratios change continuously in one or more directions

The C2 type of methods that are based on the mathematical representation of the hull surface, are practically applicable, when dealing with the hull form of normal

ships, only section-wise, i.e. the mathematical representation of individual sections of the hull is enabled through different mathematical functions. Thus, for a point on the boundary of two or more sections, represented by two or more mathematical functions, the satisfaction of two or more equations associated with the relevant sections, is required. For avoiding discontinuities and potential knuckles on the hull surface, thus for achieving faired ship lines and surfaces, it is required to obtain at least equality of the resulting offset ordinates and of the first derivatives of the equations in both horizontal and vertical directions, at best also of the second derivatives for good fairing, depending on the methods used (see Papanikolaou and Zaraphonitis 1988). Note that modern computer-aided design (CAD) software platforms dispose today powerful “graphical editors” enabling the distortion of existing lines to the desired form in efficient ways.

Simple Affine Distortion (C1.1) by H. Schneekluth

a. Linear Distortion

Procedure

a1. Multiplication of the offsets/coordinates of an existing hull in one or more directions with one or more (constant) scaling factors, e.g. a , b , and c , for the longitudinal, transverse, and vertical directions, so as to conclude to the required main dimensions.

a2. The distorted principal dimensions $a \cdot L$, $b \cdot B$, and $c \cdot T$ lead to the new ratios of length/beam, $(a/b) \cdot L/B$, beam/draft $(b/c) \cdot B/T$ and volumetric coefficient $(b \cdot c/a^2) \cdot \nabla/L^3$. It is noted that because the linear character of the distortion, the hull form coefficients (block coefficient, etc.), the centers of buoyancy (KB and LCB), of waterlines (LCF) and of sections (KB), as well as the character of the latter, remain unchanged.

a3. It is possible to combine the bow and stern part of different ships/hulls, so as to generate a new hybrid hull form with modified hull form coefficients and centroids, compared to the parent ships. For the practical application of this method, the preliminary estimation of the resulting block coefficient and the position of the center of buoyancy through simplified empirical formulas are very helpful.

Assuming for the block coefficient C_B :

$$C_B = 1/2(C_{BF} + C_{BA}) \quad (4.1)$$

where

$$C_{BF} \quad \text{the partial, forebody block coefficient,} \quad = \nabla_F / (0.5 \cdot L \cdot B \cdot T) \quad (4.2)$$

$$C_{BA} \quad \text{the partial, aftbody block coefficient,} \quad = \nabla_A / (0.5 \cdot L \cdot B \cdot T) \quad (4.3)$$

the following relationships were derived empirically from statistical data by Schneekluth (1985):

Longitudinal position of center of buoyancy (measured from the aft perpendicular, AP):

$$\overline{AB} [\%L_{pp}] = 50 + (C_{BF} - 0.973 \cdot C_B - 0.0211) \cdot 44, \quad \text{for } C_M > 0.94 \quad (4.4)$$

$$\overline{AB} [\%L_{pp}] = 50 + (C_{BF} - 0.973 \cdot C_B) \cdot (43/C_M) - 0.89 \quad (\text{independently of } C_M) \quad (4.5)$$

Block coefficients:

$$C_{BF} = C_B + \left(0.0211 + \frac{\overline{AB} \cdot [\%L_{pp}] - 50}{44} - 0.027 \cdot C_B \right) \quad (4.6)$$

$$C_{BA} = C_B - \left(0.0211 - \frac{\overline{AB} \cdot [\%L_{pp}] - 50}{44} - 0.027 \cdot C_B \right) \quad \text{for } C_M > 0.94 \quad (4.7)$$

and

$$C_{BF, BA} = C_B \pm \left[(\overline{AB} [\%L_{pp}] - 50 + 0.89) \cdot \frac{C_M}{43} - 0.027 \cdot C_B \right] \quad (4.8)$$

for arbitrary C_M values.

The above formulas actually apply only to ships without bulbous bow; the calculation error is estimated to be about $\delta(\overline{AB}) = 0.1\% L_{pp}$. When dealing with ships with bulbous bows, the resulting values for the center of buoyancy can be easily corrected, by taking into account the effect of the corresponding moment, due to the volume of a given bulb, on \overline{AB} .

b. Interpolation Methods (Modified Affine Distortion)

Procedure

b1. Interpolation between the coordinates of two linearly distorted ship lines (derived from two parental ships), which have been adjusted by constant scaling factors to the requested main dimensions

b2. Interpolation between the existing parental lines is achieved by keeping a constant percentage distance from the distorted curves of the parent ships (see Fig. 4.9)

b3. The interpolation can be done either graphically or numerically.

c. Shifting of Waterplane Procedure

c1. Shifting of the design waterplane of the parental ship to larger or smaller drafts and corresponding change of C_B

c2. Linear distortion of the resultant new hull

d. Variation of Parallel Middle Body (Schneekluth 1985) This method is extensively applied when changing the length of ship's parallel body³ with a correspond-

³ Though the length of the parallel body increases, the overall ship length remains constant; thus, this should not be confused with the lengthening of a ship by adding a parallel body, which is a very popular ship conversion (see Papanikolaou 2009).

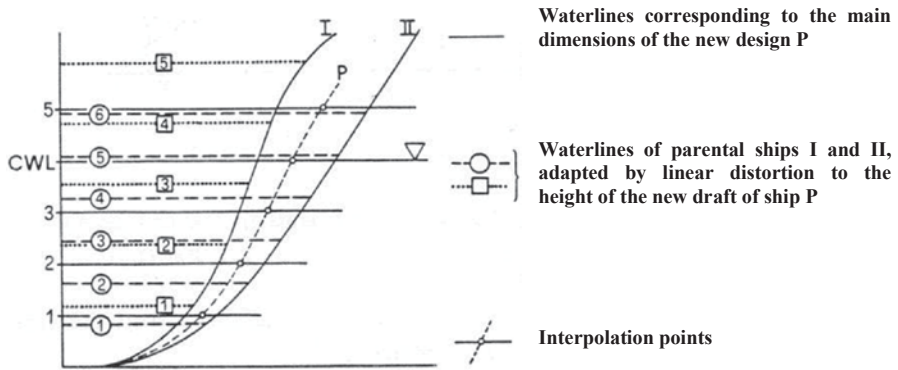

Fig. 4.9 Development of ship lines by interpolation method according to Schneekluth (1985)

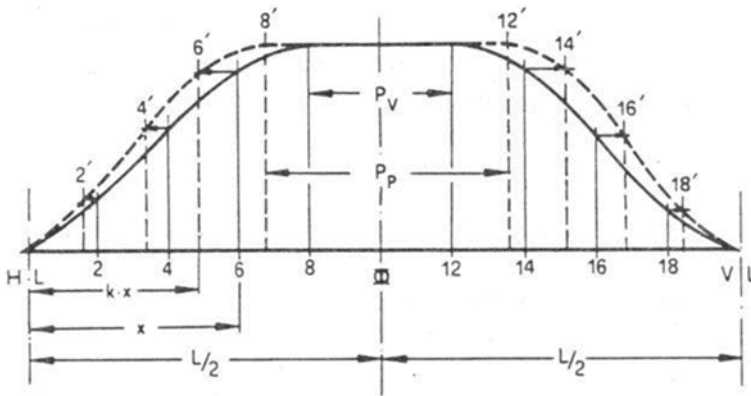

Fig. 4.10 Variation of section spacing with the change of the length of parallel body δL_p , where $P_V \cong (L_p)_0$, $P_P = (L_p)_1$, $k \cong K$, $L = L_{pp}$

ing effect on the block coefficient C_B , which increases. Likewise, the fullness of the hull can be decreased, by shortening of the parallel body.

Procedure d1. We first consider the sectional area curve of a parent ship. Assuming the forward and aft perpendiculars at first fixed, the sectional spacing between AP and forward perpendicular (FP) is varied by altering the distances of the sectional area curve ordinates (which here correspond to sectional areas) proportional to a constant factor K (see Fig. 4.10).

d2. The resulting new displacement can be determined as follows:

Difference in lengths of parallel body

$$\delta L_p = (L_p)_1 - (L_p)_0 \tag{4.9}$$

where

- L_p length of parallel body
- $(L_p)_0$ of parent ship, index $()_0$
- $(L_p)_1$ of new design ship, index $()_1$

New Displacement Assuming the length, breadth and draft of the ship to change due to linear distortion, the following results for the new displacement:

$$(\nabla)_1 = \nabla_0 \cdot \frac{(L_1 - \delta L_P) \cdot B_1 \cdot T_1}{L_0 \cdot B_0 \cdot T_0} + \delta L_P \cdot B_1 \cdot T_1 \cdot C_M \quad (4.10)$$

where

$$L_1 = aL_0$$

$$B_1 = bB_0$$

$$T_1 = cT_0$$

If the ship has been already linearly distorted, thus L , B , and T are fixed, the formula simplifies to:

$$(\nabla)_1 = \nabla_0 \cdot \frac{L_{PP} - \delta L_P}{L_{PP}} + \delta L_P \cdot B \cdot T \cdot C_M \quad (4.11)$$

d3. The length of the new parallel body and the factor for the proportional change of the section spacing from the fore and APs are derived as follows:

Length of new parallel body

$$(L_P)_1 = K \cdot (L_P)_0 + \delta L_P \quad (4.12)$$

Factor of section spacing

$$K = \frac{(L_{PP} - \delta L_P)}{L_{PP}} \quad (4.13)$$

and

$$\delta L_P = (1 - K) \cdot L_{PP} \quad (4.14)$$

New block coefficient

$$(C_B)_1 = \frac{(C_B)_0 \cdot (L_{PP} - \delta L_P) \cdot B \cdot T + \delta L_P \cdot B \cdot T \cdot C_M}{L_{PP} \cdot B \cdot T} \quad (4.15)$$

and by substituting δL_P , the K factor is obtained as:

$$K = \frac{[C_M - (C_B)_1]}{[C_M - (C_B)_0]} \quad (4.16)$$

Thus, based on the existing block coefficient $(C_B)_0$ and the targeted $(C_B)_1$, the factor K for the proportional shift of sections can be calculated.

Initial Stability Check Assuming the linear, affine distortion, as described in the preceding paragraphs, the waterplane area coefficient C_{WP} remains unchanged, even

if the length, breadth and draft of the ship are being changed proportionally. Thus, the control of the initial ship stability, based on the data of a parent ship that has been linearly distorted (method A), can be achieved with respect to the metacentric height by use of the formula:

$$(\overline{KM})_1 = (\overline{BM})_0 \frac{(B_1/B_0)^2}{(T_1/T_0)} + (\overline{KB})_0 \frac{T_1}{T_0} \quad (4.17)$$

If the interpolation method (method B) is being used, then based on the above formula the data for the linearly distorted lines of the two parent hulls can be calculated and subsequently by linear interpolation the data for the desired ship are obtained.

In the distortion method C (shifting of waterplane), the moment of inertia of the new waterplane can be calculated based on that of the parental ship:

$$(I_T)_1 = (I_T)_0 \cdot (B_1/B_0)^3 \cdot L_1/L_0 \quad (4.18)$$

and this can be used for the calculation of \overline{BM} , in the known manner.

Finally, when using the distortion method D (variation of parallel body), due to the change of the waterplane area, the new waterplane area coefficient and transverse moment of inertia need to be derived:

$$(C_{WP})_1 = \frac{(C_{WP})_0 \pm \frac{\delta L_P}{L_{PP}}}{\left(1 \pm \frac{\delta L_P}{L_{PP}}\right)} \quad (4.19)$$

$$(I_T)_1 = (I_T)_0 \cdot (B_1/B_0)^3 \frac{L_1 - \delta L_P}{L_0} + \delta L_P \cdot B_1^3/12 \quad (4.20)$$

Note that all the above formulas are clearly the result of geometric relationships, thus they do not involve any empirical relationships that would diminish the accuracy of the calculations/estimations.

4.4 Design Based on Data of Systematic Ship Hull Form Series

Such important ship hull form series are typically the following ones:

1. Series of the Wageningen Laboratory (Netherlands) according to Lap-Auf'm Keller

Bibliography

Lap, A., J., W., Journ. Int. Shipbuilding Progress, 1954

Auf'm Keller, Journ. Int. Shipbuilding Progress, 1974

2. Series 60 according to Todd et al. (USA)

Todd, Pien, Transactions of SNAME, 1956

3. FORMDATA Series, Lyngby Laboratory (Denmark) according to H. E. Guldhammer

Guldhammer, H., E., FORMDATA I-IV, Danish Techn. Press, Copenhagen, 1969

Outline of Systematic Hull Form Series The first two of the above mentioned series, i.e. Series Wageningen (Lap) and Series 60 (Todd), dispose the lengthwise distribution of the preliminarily estimated displacement for single- and twin-screw ships without bulbous bow, that is, the sectional areas are given as percentages of the given midship section area and as a function of the pre-estimated prismatic coefficient. Application examples are given in course material of NTUA-SDL, Papanikolaou and Anastassopoulos (2002).

The subsequent design procedure for the development of the ship lines plan is similar to that described under **B** in the present chapter. A serious drawback of the above two systematic series is that they are outdated with respect to the associated hull forms; the main advantage, when using systematic hull form series, is, however, the availability of semiempirical calm water resistance data (resulting from systematic model experiments) enabling the reliable estimation of powering for the resulting hull forms.

The FORMDATA systematic series, which is still today the most complete and advanced hull form series available in the public domain, is considered satisfactorily representing modern hull forms of merchant ships, even though processed data stem from the 70s; they refer to three basic hull forms, i.e., sections of U, N, and V character, which are combined with two basic series of stern and bow forms, namely A and F. Unlike the previously mentioned series (Wageningen-Lap and Series 60), FORMDATA considers bulbous bow and transom stern options. Typically in the FORMDATA series the offsets of the model sections are given in dimensionless form, i.e., as percentages of the reference breadth and draft (which are assumed predetermined values). In this way the procedure of developing the ship lines is significantly facilitated, as the work of the designer reduces to the fairing of the resulting ship lines.

The FORMDATA series is described in more details in Appendix B, where also the aforementioned series by Lap and Series 60 are outlined. A full set of the FORMDATA diagrams and instructions how to use them is included in Perras (1979).

Ship Lines Plan for Design Stages The initial design stage involves the draft design of the ship lines plan in a relatively large scale (about 1:200 up to 1:250 for normal ships) without accurate fairing of lines. This draft design is mainly used for the preliminary examination of various ship form data, such as displacement, stability and trim, volume of holds, etc.

In the second stage of design, during the preliminary design, a smaller scale (typically 1:100 to 1:50 for typical ship sizes) and a drawing accuracy in the order 0.1 mm (corresponds to an error margin of 2.5 cm for a 250 m ship in full scale, if drawn in a scale of 1:100) are required.

Finally, in the last design stage, because the developed ship lines constitute the basis for the development of the construction drawings of the various elements of

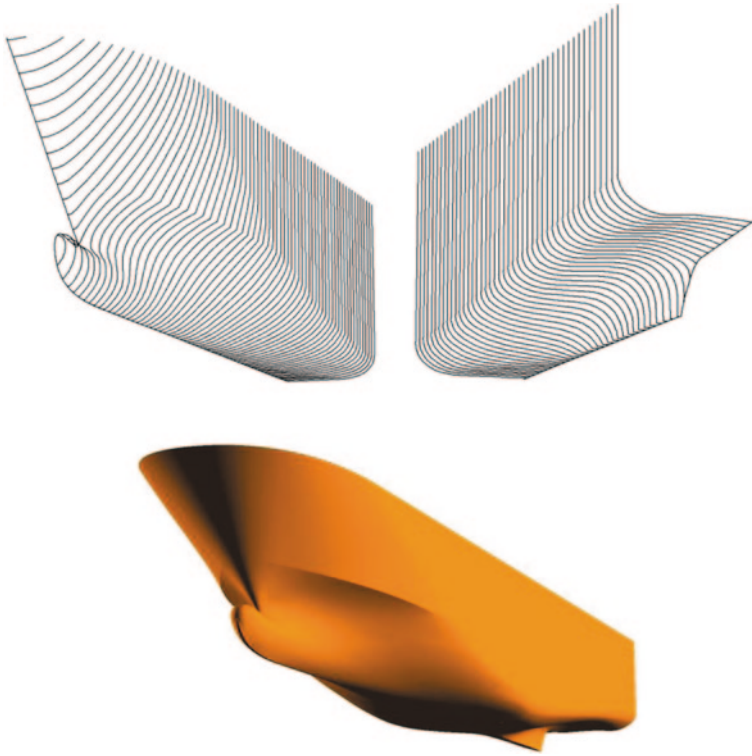

Fig. 4.11 The 2-D wire-frame and 3-D lines plan of a modern RoPax ship developed by NAPA®. (Ship Design Laboratory-NTUA, Research project “EPAN–Transport,” 2007)

ship’s structure (plates, stiffeners, etc.), a smaller scale, in the order of 1:10, is used to develop the *plan of building frames* of the ship, which corresponds to the actual *transverse stiffeners* of the ship (drawing of building frames); the building frames are certainly much more in number (about 1–2 building frames/m) than the *mold* sections of the lines plan (usually 21 mold sections for the overall length of the ship, including AP and FP sections, but with intermediate sections at ship’s ends; Figs. 4.1 to 4.8 and Fig. 4.11).

4.5 General Arrangement Plan

The general arrangement (GA) plan (German: Generalplan) of a ship involves the *arrangement of spaces and the arrangement of the ship’s main equipment and outfitting*.

General Arrangement of Spaces The general arrangement of a ship’s spaces is the outcome of a study involving the determination and examination of the space

requirements for every basic function⁴ of the ship and the establishment of the physical interfaces between design spaces as necessary for the orderly operation of the ship.

The space planning and the design of the physical interfaces of spaces involves:

- the demarcation of spaces for the basic ship functions
- the rational planning of the flow of functional operations
- the identification of associations/relationships of onboard operations
- the determination of the various onboard supply/distribution systems (energy, water, sewage, etc.)
- the determination of the access to the functional spaces and their mutual interfaces

The outcome of the procedure for the general arrangement of ship spaces is the subdivision of the ship's enclosed volume in the vertical direction through horizontal decks, transversely and longitudinally through bulkheads and walls into compartments, which serve certain functions, and the determination of communication routes on and between the decks and between the compartments.

Arrangement of Equipment/Outfitting This is the process of controlling the space requirements for the installation/fitting of a ship's equipment related to a functional ship subsystem inside the allocated ship spaces and their access/communication for proper function (e.g., layout of engine room, interior layout of accommodation rooms/cabins, detailed layout of fully equipped spaces, etc.).

The GA plan includes a side view/elevation plan of the ship (above the main deck as side view, below the main deck as lateral plane, cut at the centerplane of the ship), as well as top down views of the ship's decks, as cuts of horizontal planes slightly above the decks of the ship, from the ship's bridge and down to the double bottom (see example, reefer ship "Polar Ecuador," Figs. 4.12 and 4.13).

The GA plan enables to check the interior arrangement of the ship and of her superstructures. Also, it includes information about the arrangement of the main equipment/outfitting of the ship.

During the initial design stage, a sketch drawing of ship's side view is recommended, which should include the basic internal arrangement of ship's main spaces, according to their functions. This sketch does not require any drawing precision and is usually drawn at a scale of 1:750 to 1:1,000. At the preliminary design stage, the scale is reduced and commonly taken from 1:200 to 1:100, depending on the absolute size of the design ship (1:50 for small boats with a length of up to about 50 m, 1:100 for ship lengths up to about 200 m, 1:200 for ship lengths between 200 m and 300 m, and 1:400 for ship lengths over 300 m).

⁴ Basic functions of merchant ships:

- Transport and handling of cargo
- Provision of accommodation for crew and passengers
- Provision of energy generation-machinery/propulsion/navigation
- Provision of fuel and provisions for specified range.

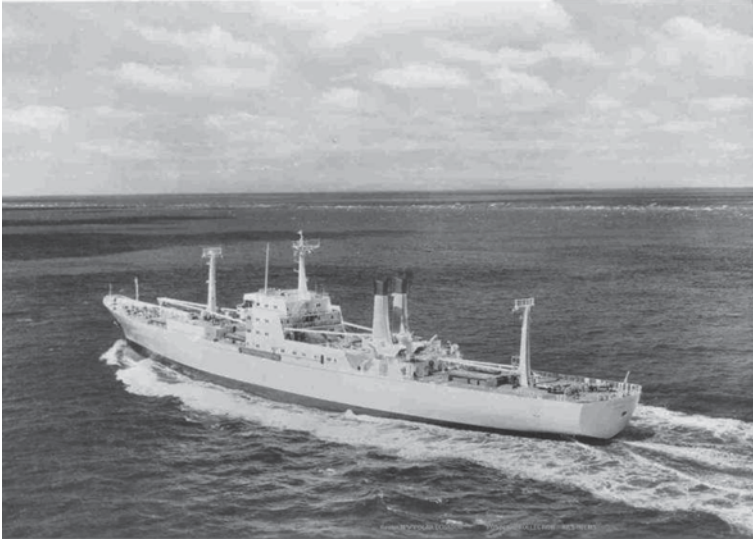

Fig. 4.12 Reefer ship “Polar Ecuador,” built in 1967 by the German yard Blohm & Voss for Hamburg Südamerikanische Dampfschiffahrts-Gesellschaft; operated later for a Greek owner as “Chios Spirit”; is representative of a successful series of fast reefer ships (service speed at banana draft: 23.5 knots) built by Blohm & Voss in the 60s, transporting bananas from South America to Europe (in German: Banana-Dampfer)

Preparation of General Arrangement Drawings⁵ The process of preparing the initial drawing of the general arrangement of a ship includes the following basic steps and drawing plans (Fig. 4.14):

- a. Separation/identification of ship’s functional spaces (hold spaces, engine room, superstructures, cargo-handling equipment, and tanks)
 - b. Determination of the ship’s watertight bulkheads in accordance with the requirements of recognized classification societies and international regulations on watertight subdivision of SOLAS
 - c. Determination of ballast and fuel tanks
 - d. Determination of the number and location of decks, depending on the requirements of the freight/cargo to be transported
 - e. Study of the impact of specific requirements for certain types of cargo (refrigerated cargo, containers, etc.)
- 1. Side Elevation Plan** The development of the side elevation plan (profile) starts with first drawing the baseline, the line of the fully loaded waterline (design waterline) and the forward and after perpendiculars of the ship, which

⁵ The development of the general arrangement of a ship is one the main subjects of the course “Ship Design and Outfitting II” of the curriculum of the School of Naval Architecture and Marine Engineering, NTUA (Papanikolaou 2003).

| | | | | | |
|---|-----------------|----------|---|---------------------------|-------------------------|
| Length o.a. | 456 ft 11 in | 142.20 m | Hold capacity without bins banana capacity | 423,354 ft ³ | 11,957.9 m ³ |
| Length b.p. | 436 ft 2 1/2 in | 133.00 m | Gross tonnage, open | 3,815 | |
| Breadth, moulded | 64 ft 3 1/2 in | 19.60 m | Gross tonnage, closed | 5,617 | |
| Depth, to third deck | 23 ft 2 1/2 in | 7.07 m | Block coefficient | 0.52 | |
| Depth, to second deck | 31 ft 4 in | 9.56 m | Machinery output, max. | 14,830 bhp at 500 rev/min | |
| Camber, first deck and forecastle | 9 1/2 in | 0.25 m | Speed on banana draught at 96 per cent output | 23.5 knots | |
| Draught, summer freeboard open shelterdeck to IMCO recommend. | 21 ft 6 1/2 in | 6.575 m | Heavy fuel, approx. | 1,120 tons (m) | |
| Draught, summer freeboard closed shelterdeck | 26 ft 1 1/2 in | 8.222 m | Ballast water, approx. | 290 tons (m) | |
| Deadweight, open | 4,900 tons (m) | | Fresh water, approx. | 180 tons (m) | |
| Deadweight, closed | 7,950 tons (m) | | | | |

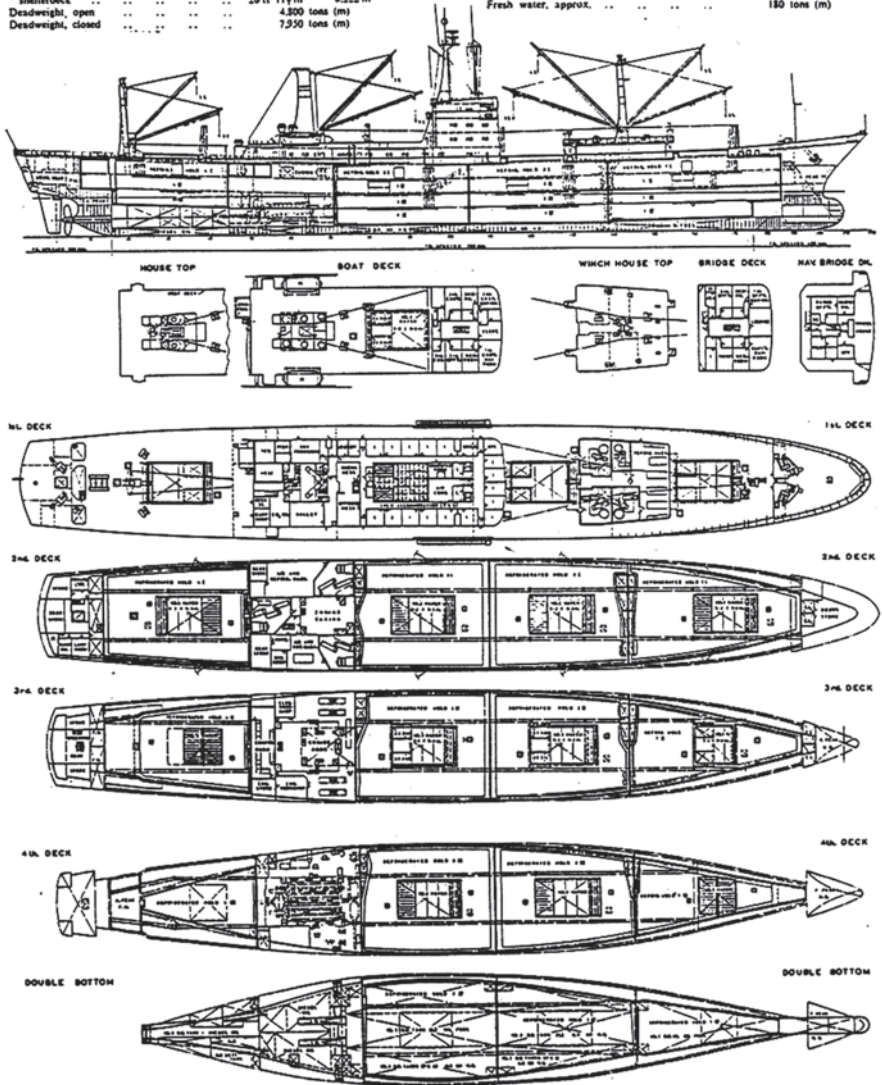

Fig. 4.13 General arrangement of reefer ship "Polar Ecuador," DWT=4800/7950 t

are defined by the preestimated length between perpendiculars (L_{PP} or L_{BP} , length between perpendiculars). The position of the AP coincides with station/section/frame 0 and by definition passes through the rudder axis/shaft (centerline of rudderstock), while the FP by definition passes through the intersection

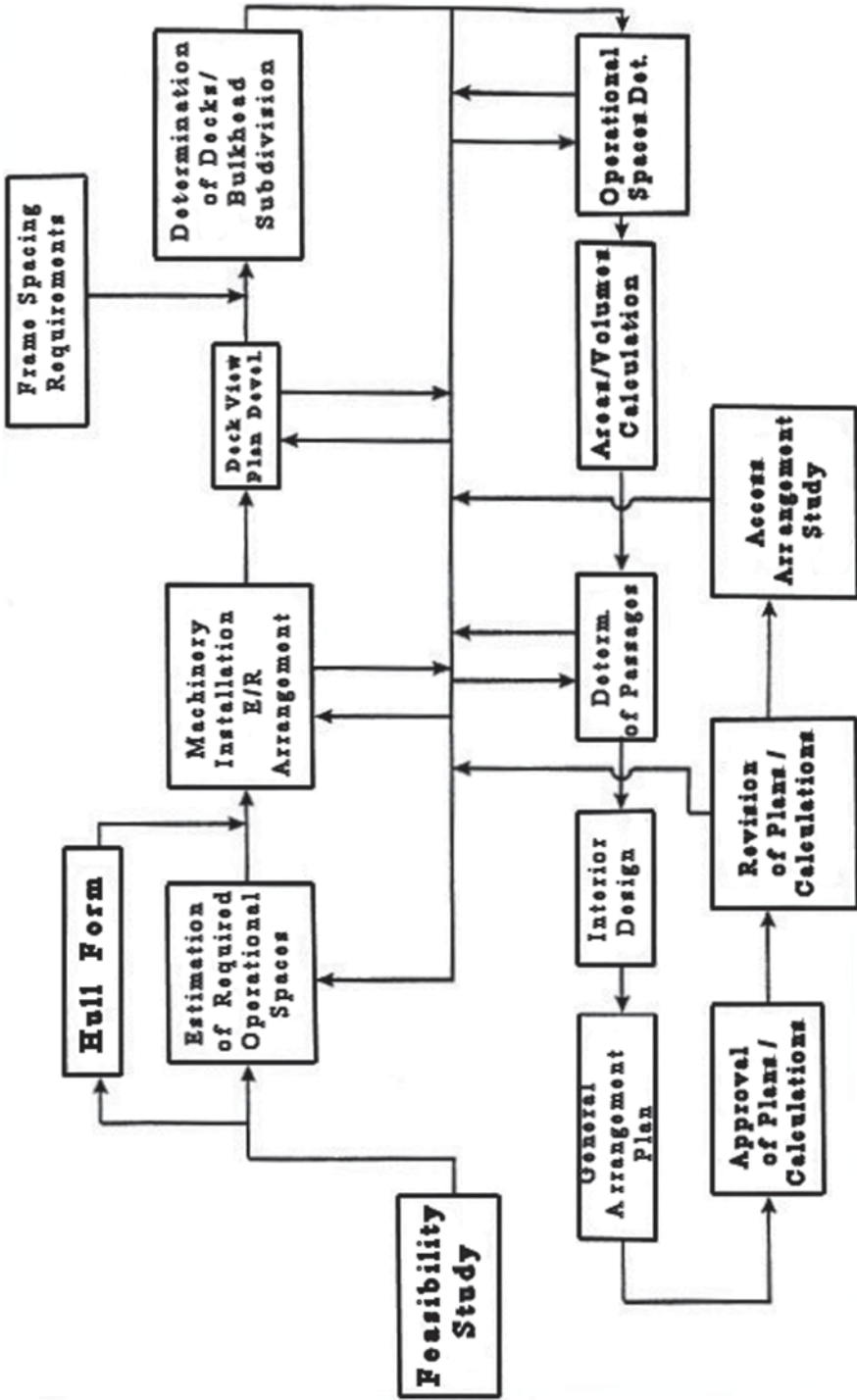

Fig. 4.14 Flowchart of development of a ship's general arrangement

of the design waterline and bow–stern profile. The *building frames/stations* of the ship, whose distance is determined by the specifications of classification societies (see later), are also marked on the baseline.

The elevation of the general arrangement of the ship is drawn as a side profile view above ship's main (strength) deck, and as longitudinal cut view to the ship's centerplane below it. In the elevation plan, the decks and the double bottom upper boundaries are shown as horizontal lines (vertically subdividing the ship), and the transverse bulkheads as vertical lines (lengthwise subdividing the ship).

- The *minimum* height of the double bottom is determined by relevant regulations of recognized classification societies as a function of ship's beam B and draft T ; regulations differs (slightly) among different class societies.
 - Det Norske Veritas, DNV [mm]: $250 + 20 B[m] + 50 T[m]$, with minimum height 650 mm
 - Lloyd's Register, LR [mm]: $28 B[m] + 205 T^{1/2}[m]$, also with minimum height 650 mm
 - American Bureau of Shipping, ABS [mm]: $32 B[m] + 190 T^{1/2}[m]$, for ships with $L \leq 427$ m

The height of the double bottom is increased in the engine room compartments and at the bow for operational and constructional reasons (size of double bottom tanks, accessibility, and strength).

- The *number and the position of the transverse watertight bulkheads* are determined by many factors and depends on:
 - The desired number of cargo holds, engine rooms etc., which, if not specified by the owner, must be determined at the conceptual design stage.
 - The type and size of the ship and the different regulations of watertight subdivisions that govern it. From January 1, 2009, the harmonized probabilistic rules of SOLAS 2009 for the assessment of stability and buoyancy after damage (IMO 2013b, SOLAS, Part B, Chapter II for the passenger ships and Part B-1, Reg. 25 for the dry cargo ships, IMO 2013b) apply to all passenger and dry cargo ships (length over 80 m) built after that date. Within this regulatory framework, the attained subdivision index A^6 must be *greater* than the required R (required subdivision index). The level of the index R is defined by the SOLAS rules and is dependent on the ship type (passenger or cargo ship), the ship size (expressed by the length), and the number of persons on board (for passenger ships). Obviously, for the same ship size (length), passenger ships have increased requirements of watertight subdivision (and index R).

⁶ The attained subdivision index A expresses the survival probability of the ship in case of flooding due to side collision (with the ship assumed being struck by another ship of *similar size*). Consequently, $A=0.60$ means that the ship is predicted to survive (does not capsize and/or sink) in 60% of possible side collisions cases, which lead to the ship's flooding after loss of the ship's watertight integrity (*LOWI*) (breach of hull shell). Note that the probability that a ship is engaged in a collision accident is in the range of 10^{-2} to 10^{-3} /shipyear, see, e.g., containership casualty statistics, period 1990–2012, collision frequency 7.04×10^{-3} /shipyear according to published research of Eliopoulou et al. (2013).

- For certain ship types the position of bulkheads is determined by the dimensions of the carried cargo (e.g. containerships), but also by other requirements regarding minimum distances between bulkheads.
- Regarding the minimum number of transverse bulkheads the following needs to be taken into account:
 - The classification societies' rules specify the minimum number of bulkheads from the point of view of ship's structural strength; it depends on the type and length of the ship; bulkheads need to be uniformly distributed for structural adequacy. Furthermore, it is also specified that every ship needs to dispose a forward and aft collision bulkhead, as well as two watertight bulkheads on each side of the engine room; the bulkhead on the stern side of the engine room may coincide with the aft collision bulkhead in case the engine room is located astern. The distance of the forward collision bulkhead from the FP must be within the limits set by SOLAS regulation (between 5% and 8% of the ship's length from FP).
- Typical numbers of cargo holds
 - General cargo ships, small containerships, and bulkcarriers
 - (1) 4, $100\text{ m} \leq L \leq 110\text{ m}$
 - (2) 5, $110\text{ m} \leq L \leq 140\text{ m}$
 - (3) 6, $140\text{ m} \leq L \leq 170\text{ m}$
 - *Large containerships*: The length of the holds considers generally the stowage of 40-ft containers (FEU) or 2×20 -ft containers (TEU), thus 12.192 m plus margins for cell guides.
 - *Large bulkcarriers*: 7 up to 10
 - *Tankers*: The number is determined in line with the requirements of MARPOL (IMDC 2013a). According to the latest provisions, which follow the specifications of the Oil Pollution Act (OPA 90) of the USA after the catastrophic accident of Exxon Valdez (1989), all tankers must be nowadays of double hull/skin type (see Figs. 4.15 and 4.16). Large tankers (very large crude carrier, VLCC, and ultra large crude carrier, ULCC) have commonly three tanks across (two longitudinal bulkheads) and five tanks lengthwise (3×5), whereas the smaller ones in the category of large tankers (DWT greater than about 50,000 t, PANAMAX, AFRAMAX, and SUEZMAX) have typically two holds across and five to six (seven) lengthwise. MARPOL specifies the maximum size (volume) of each tank and requires that the resulting probabilistic oil outflow index (OOI) is less than a required index, which depends on ship's deadweight.
- *Passenger and Ro-Ro-Passenger (RoPax) ships*: There are no typical values for the number of watertight compartments of passenger ships, which are located below their bulkhead deck, noting that the bulkhead deck is trivially the main car deck for the RoPax ships (Fig. 4.17). The watertight subdivision of passenger ships can be accomplished by fitting of both transverse and longitudinal bulkheads and combinations of both. The density of the watertight

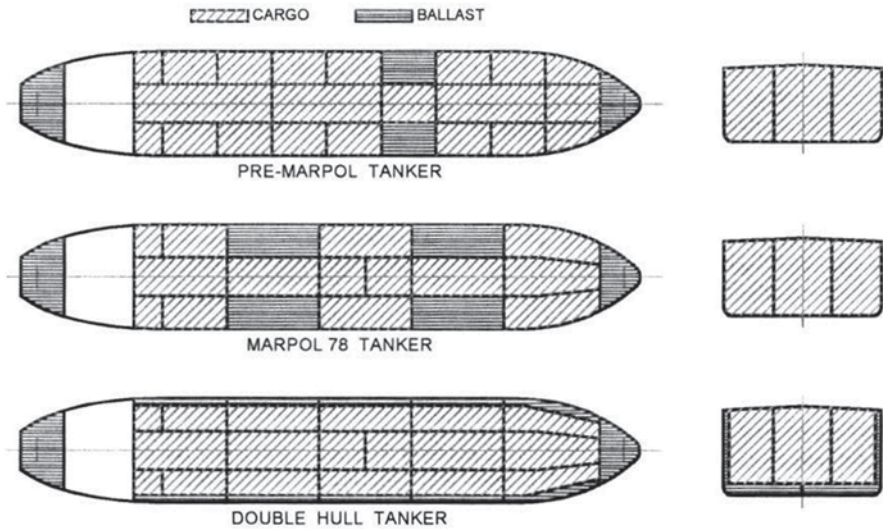

Fig. 4.15 Typical arrangements of tankers (Lamb 2003)

subdivision is determined by the damage stability regulations of SOLAS. These regulations were until recently deterministic (SOLAS 90) and led to the requirement of nonsinking/capsizing in case of flooding of one, two, or three or more watertight compartments of the ship, depending on her size (length) and the number of persons on board.⁷ This led commonly to 8–9 transverse bulkheads for one compartment small ships, 11–15 for the two compartments, medium size ships, and 14–16 for the three compartment large ships. The most recent SOLAS regulations, which came into force on January 1, 2009 (SOLAS 2009), are based on the *probabilistic assessment model of damage stability* and lead to the assessment of damage stability in case of flooding of even more than three compartments, according to the probability of occurrence of the likely damage scenarios; consequently, they can lead to different designs of the watertight subdivision. However, it is assumed that the watertight subdivision requirements of the deterministic regulations of SOLAS 90 are practically (on average) *equivalent* to the requirements of the probabilistic SOLAS 2009, except for extreme situations (very small and very large passenger ships; see Papanikolaou 2007).

⁷ For Ro-Ro passenger ships, we must additionally take into account that an amount of water may enter the ship's car deck in seaways (water on deck—WOD problem); this greatly affects the ship's stability and buoyancy and may lead to catastrophic accidents (see RoPax *Estonia* accident 1994). These additional WOD requirements apply to all Ro-Ro passenger ships operating in the EU (so-called *Stockholm Agreement*), as well as in other developed countries worldwide (USA, Canada, etc.). The amount of water that is taken into account is a function of the ship's freeboard in a damage situation and the significant wave height in the ship's operational area (see also, Appendix E).

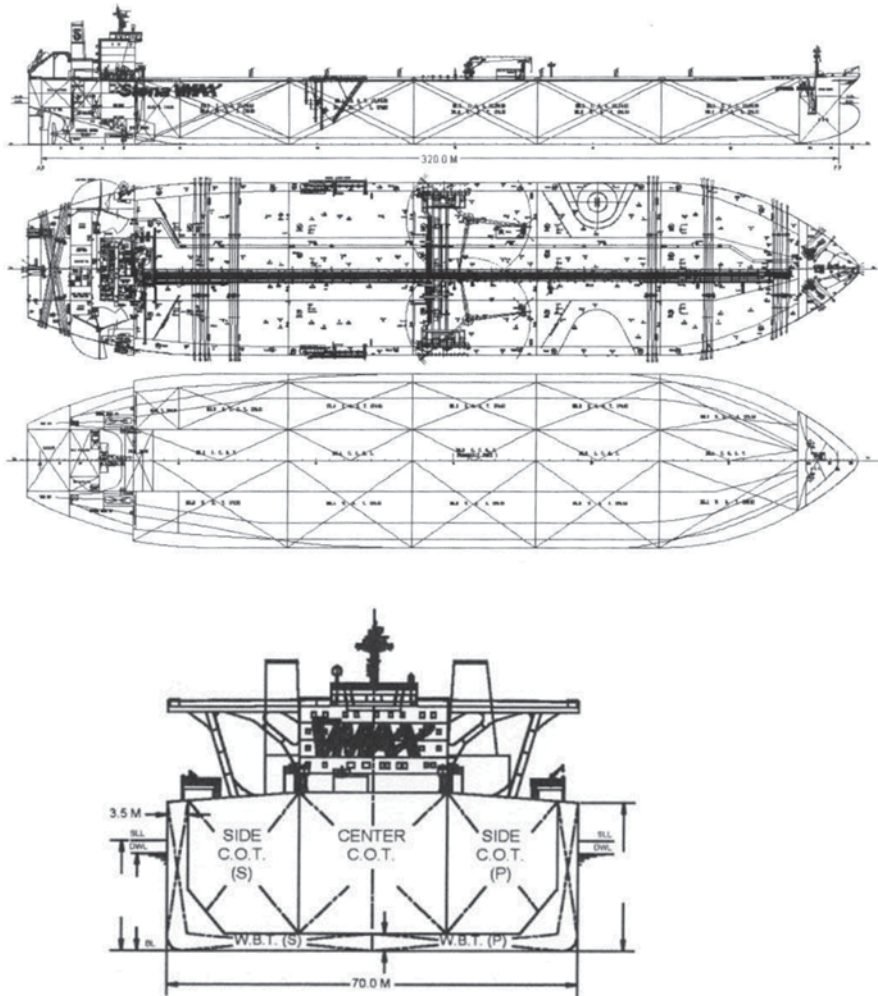

Fig. 4.16 General arrangement of a shallow draft VLCC tanker STENA VISION (Lamb 2003). (Dimensions: $L_{BP}=320.0$ m, $B=70.0$ m, $T_d=16.76$ m, $D=25.60$ m, $\Delta(T_d)=311,210$ t, DWT (T_d)=268,000 t)

- The *frame spacing*, which defined as the distance between the transverse strengthenings/frames of the ship, is specified by the relevant classification society's regulations. The exact distance is determined after specifying the (preliminary) location of the watertight bulkheads lengthwise, taking into account the following:
 - *Minimization* of ship's steel weight: decide on the distance of frames in conjunction with the fitting of reinforced web frames in between the simple frames

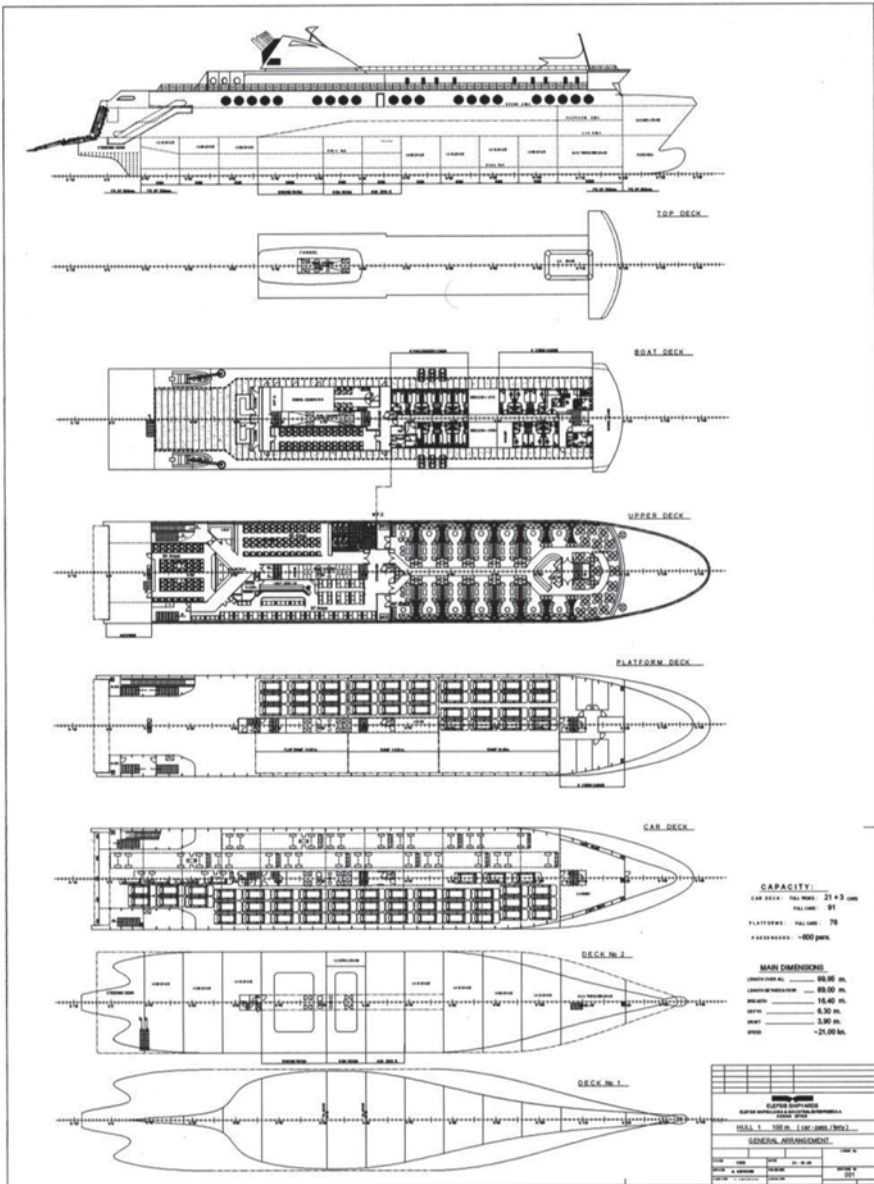

Fig. 4.17 General arrangement of a RoPax ship. Research project EPAN—Transport, NTUA—Elefsis Shipyard (2005–2007)

- *Uniform* distribution of structural elements, particularly keeping fixed distances of the web frames in the holds
- *Positioning* of the building frames along the ship’s general arrangement in such a way that coplanar structural frameworks are formed, e.g.,

The length of holds must correspond to a number of frames with a constant distance between them; transverse bulkheads are fitted exactly on building frames' position.

The lengthwise boundary of the superstructures and of their compartments must also correspond to a number frames with a constant distance between them.

- For the estimation of the frame spacing *around amidships* the directive of the Norwegian Classification Society, DNV, can be used:
 $s[\text{mm}] = 2(240 + L[\text{m}])$
- At the two ends of the ship (especially at the bow), the classification societies require *higher frame density* (smaller distances), compared to that at amidships, to account for the increased loads of the steel structure from wave loads at ship's ends (slamming).

2. Top-Down Views of Deck Plans The top-down views of the deck plans include:

- An intersection of the ceiling of double bottom and view of the plan of the tanks
- Intersections and plan views for all the decks, from the bridge down to the double bottom; the transverse and longitudinal subdivision of deck spaces is shown. Top-down plan views of the forecastle, bridge and poop, and generally of all the deckhouses (cargo ships) are included.
- In passenger ships, the main vertical *fire safety zones* are also shown; typically, they are extensions of the watertight bulkheads extending below the main deck. The distance of these fire zones should not exceed 40 m (according to the SOLAS regulations), and any exceedance of this limit must be justified by dedicated studies and approved by competent authorities.

3. Midship Section Plan It is presented as a transverse plane intersection below the main deck of the ship and as a view from ship bow above the main deck. However, very often it is omitted in the general arrangement of the ship in the preliminary design stage.

4.6 Capacity Plan

The *capacity plan* complements the main set of plans describing a ship's hull (lines plan) and the arrangement of spaces and equipment/outfitting of the ship (GA). This plan specifies the amount of cargo, fuel, fresh water, supplies, and seawater ballast, which the ship can carry, shows the spaces for their carriage. For the development of this plan, the *volumetric capacity curves* of the ship can be used (see Sect. 2.17.2).

This plan includes at least the following:

- Longitudinal (later profile) view of the ship as cut/intersection in ship's center-plane; it shows the arrangement of spaces and their use. The building frames of the ship are plotted on the baseline.
- The principle dimensions and other basic characteristic values of the ship

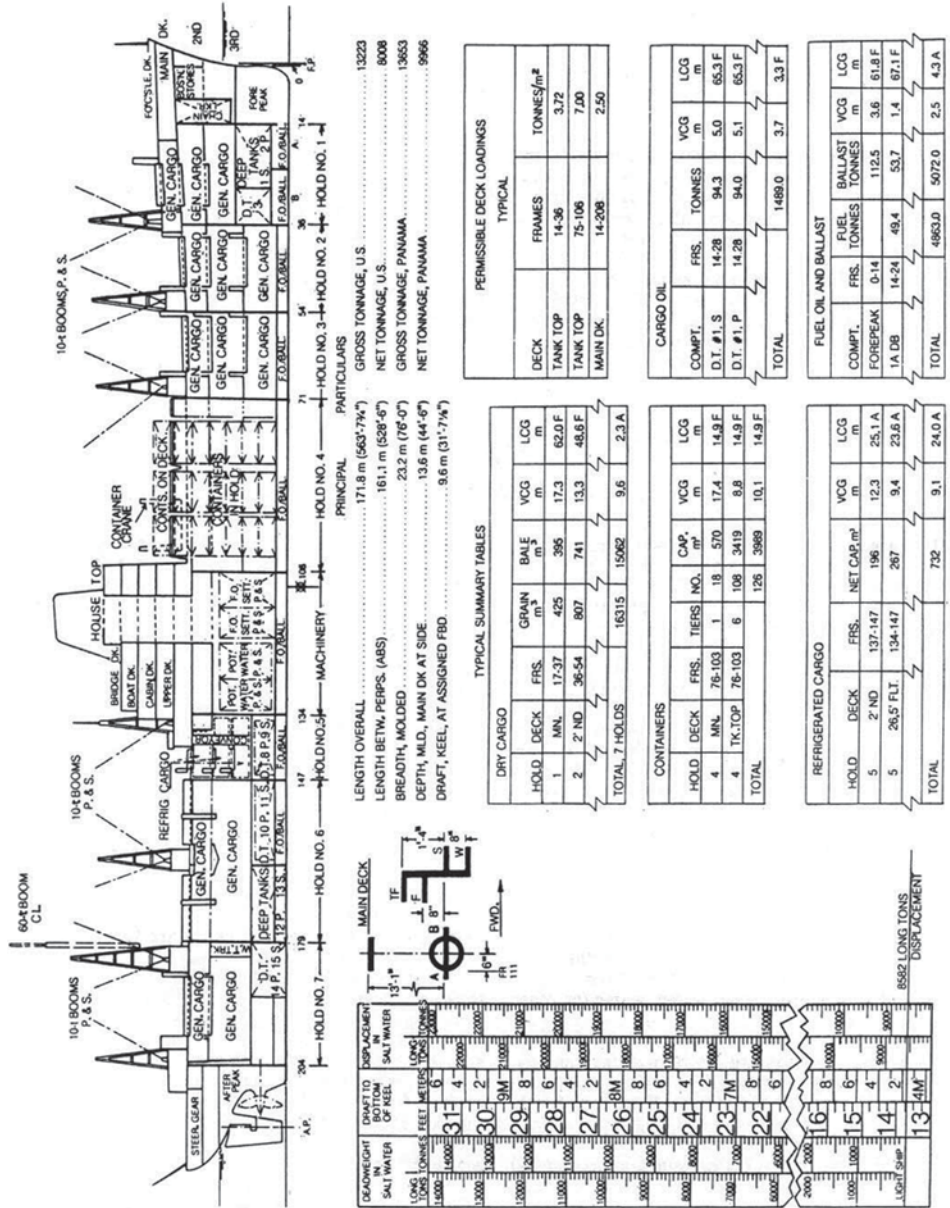

NOTE: LCG, FORD (F) AND AFT (A) MEASURED FROM AMIDSHIPS, 81.7m (268 FT) FORD OF A.P.

Fig. 4.18 Plan of a multipurpose cargo ship (Lamb 2003)

- The carried cargo quantities, fuel, fresh water, supplies, and seawater ballast and their location, including the longitudinal and vertical position of each weight group. In cases of asymmetric loading, the transverse position of the center of mass of each weight group is also required.
- *Deadweight scale* in correspondence to the scales of drafts and displacement⁸. Alongside these scales, also the corresponding TPcm and MTcm scales are often shown.⁹
- The freeboard marking and Load Line mark (Plimsoll mark).

The below example (Fig. 4.18, Lamb 2003) refers to the capacity plan of a multipurpose cargo ship, with transport capacity of 14,250 tons DWT, with 7 cargo holds, including one hold to accommodate containers in cells and a refrigerated cargo hold. The ship can carry in certain holds (deep tanks) oil, as well as containers on deck.

References

- Antoniou A, Perras P (1984) Ship design—special chapters (in Greek: Μελέτη Πλοίου - Ειδικά Κεφάλαια), Rev. 2. Foivos Publisher, Athens
- Eliopoulou E, Hamann R, Papanikolaou A, Golyshev P (2013) Casualty analysis of cellular container ships. Proceedings of the 5th international design for safety conference (IDFS 2013), Shanghai, Nov 2013
- Friis AM, Andersen P, Jensen JJ (2002) Ship design (Part I & II). Section of Maritime Engineering, Dept. of Mechanical Engineering, Technical University of Denmark. ISBN 87-89502-56-6
- International Maritime Organization, IMO (2013a) SOLAS, consolidated edition. Consolidated text of the International convention for the safety of life at sea, 1974, and its protocol of 1988: articles, annexes and certificates
- International Maritime Organization, IMO (2013b) MARPOL 73/78, consolidated edition
- Lamb T (ed) (2003) Ship design and construction. SNAME, New York (revision of the book: D'Arcangelo AM (ed) (1969) Ship design and construction. SNAME, New York)
- Papanikolaou A (2003) Ship design and outfitting II—detailed design (support course material, in Greek: Μελέτη και Εξοπλισμός Πλοίου II, Στοιχεία Αναλυτικής Σχεδίασης), National Technical University of Athens, Athens
- Papanikolaou A (2007) Review of damage stability of ships—recent developments and trends. Proceedings of PRADS 2007, Houston, Oct 2007
- Papanikolaou A (2009) Ship design—methodologies of preliminary ship design (in Greek: Μελέτη και Εξοπλισμός Πλοίου I, Μεθοδολογία Προμελέτης Πλοίου), Vol 1. SYMEON, Athens, ISBN 978-960-9600-09-01 and Vol. 2, ISBN 978-969-9400-11-4, Oct 2009
- Papanikolaou A, Anastassopoulos K (2002) Ship design and outfitting I (support material to the course, rev. 2 (in Greek: Μελέτη και Εξοπλισμός Πλοίου I, Μεθοδολογία Προμελέτης Πλοίου, Συλλογή Βοηθημάτων). National Technical University of Athens, Athens
- Papanikolaou A, Zaraphonitis G (1988) Computer applications in ship design. Hellenic Technical Chamber, Athens
- Perras P (1979) Formdata series of diagrams and instruction booklet. National Technical University of Athens, Laboratory of Ship Hydrodynamics, Rep. No. 10-79
- Schneekluth H (1985) Ship design (in German). Koehler, Herford
- Taggart R (ed) (1980) Ship design and construction. SNAME, New York

⁸ The draft scales refer to amidships.

⁹ TPcm: tons per centimeter immersion; MTcm: moment to change trim 1 cm.

Chapter 5

Machinery Installation, Propulsion and Steering Devices

Abstract The study of a ship's machinery installation and her propulsion plant, namely, of the main machinery (prime mover) and auxiliary engines, of the propeller and the required rudder, is a subject of specialized literature, a sample of which is cited in the given list of references. In the context of the present book, we will limit ourselves to some general comments on the selection criteria and the recommended procedure regarding the selection of ship's machinery installation and of the propulsive and steering devices as to meet the needs of the preliminary design of a ship.

5.1 Selection of Main Machinery

A. Selection Criteria

1. Acquisition cost
2. Safety in operation
3. Weight
4. Space requirements
5. Specific fuel oil consumption (SFOC)
6. Fuel type and fuel cost
7. Emission of toxic gases (SO_x , NO_x etc.)
8. Repair cost
9. Maintenance cost
10. Manoeuvrability
11. Vibrations
12. Automation of control

The above selection criteria for a ship's main engine installation are valid regardless of the specific conditions, which may apply to a particular ship. However, it is characteristic that certain aspects and selection criteria were strongly emphasized in the past, such as in the early 1970s, the introduction of automated systems in ship engine installations. Also, after the first oil crisis in the early 1970s and the rapid increase of crude (and fuel) oil price, the specific fuel oil consumption, the type of fuel and the savings of energy in general play a primary role in the selection of the appropriate main propulsion engine of a ship.

More recently (especially after 2008), following relevant discussions at the United Nations Organization (UNO) regarding the protection of the air environment from toxic gases emitted by engines of all types of transportation vehicles, the International Maritime Organization (IMO) proceeded introducing a framework of regulations for the reduction of gaseous pollutants (CO_2 , NO_x , SO_x) of marine engines, so as to define upper limits for the emissions of gaseous pollutants for ships. In this respect, an Energy Efficiency Design Index (EEDI)¹ has been introduced for most types of merchant ships, which needs to be kept below a certain limiting value that is specific to the ship's type and size.

The EEDI of a ship is a measure of the ship's energy efficiency and her green house gas (GHG) emission level, expressed in [grams CO_2 per tonne mile]; it is calculated by the following formula (see MEPC 212(63) 2012):

$$\begin{aligned} \text{EEDI} = & \left(\prod_{j=1}^n f_j \right) \left(\sum_{i=1}^{n\text{ME}} P_{\text{ME}(i)} \cdot C_{\text{FME}(i)} \cdot \text{SFC}_{\text{ME}(i)} \right) + \left(P_{\text{AE}} \cdot C_{\text{FAE}} \cdot \text{SFC}_{\text{AE}}^* \right) \\ & + \left(\left(\prod_{j=1}^n f_j \cdot \sum_{j=1}^{n\text{PTI}} P_{\text{PTI}(i)} - \sum_{i=1}^{n\text{eff}} f_{\text{eff}(i)} \cdot P_{\text{AEeff}(i)} \right) C_{\text{FAE}} \cdot \text{SFC}_{\text{AE}} \right) - \left(\sum_{i=1}^{n\text{eff}} f_{\text{eff}(i)} \cdot P_{\text{eff}(i)} \cdot C_{\text{FME}} \cdot \text{SFC}_{\text{ME}}^{**} \right) \\ & \frac{}{f_i \cdot f_c \cdot \text{Capacity} \cdot f_w \cdot V_{\text{ref}}} \end{aligned} \quad (5.1)$$

where:

C_F is a non-dimensional conversion factor between fuel consumption measured in gram and CO_2 emission also measured in gram based on carbon content. The subscripts $\text{ME}(i)$ and $\text{AE}(i)$ refer to the main and auxiliary engine(s) respectively. C_F corresponds to the fuel used when determining SFC listed in the applicable test report included in a Technical File as defined in paragraph 1.3.15 of NO_x Technical Code. The value of C_F as follows (in Table 5.1):

V_{ref} is the ship speed, measured in nautical miles per hour (knot), on deep water in the condition corresponding to the Capacity as defined below (in case of passenger ships and ro-ro passenger ships, this condition should be summer load draught) at the shaft power of the engine(s) and assuming the weather is calm with no wind and no waves.

Capacity is defined as follows:

- For bulk carriers, tankers, gas tankers, ro-ro cargo ships, general cargo ships, refrigerated cargo carrier and combination carriers, deadweight should be used as *Capacity*.
- For container ships, 70% of the deadweight (DWT) should be used as *Capacity*.

¹ The EEDI was made mandatory for *new* ships, as of January 1, 2013; this was decided at MEPC 62 (July 2011) with the adoption of amendments to MARPOL Annex VI (resolution MEPC.203(62)) and went along with the introduction of a Ship Energy Efficiency Management Plan (SEEMP) for *all* ships (see, also Chap. 1 of this book).

Table 5.1 C_F values

| Type of fuel | Reference | Carbon content | C_F (t-CO2/t-fuel) |
|----------------------------------|------------------------------------|----------------|----------------------|
| 1. Diesel/gas oil | ISO 8217 Grades DMX through DMB | 0.8744 | 3.206 |
| 2. Light fuel oil (LFO) | ISO 8217 Grades RMA through RMD | 0.8594 | 3.151 |
| 3. Heavy fuel oil (HFO) | ISO 8217 Grades RME through RMK | 0.8493 | 3.114 |
| 4. Liquefied petroleum gas (LPG) | Propane | 0.8182 | 3.000 |
| | Butane | 0.8264 | 3.030 |
| 5. Liquefied natural gas (LNG) | | 0.7500 | 2.750 |

Deadweight means the difference in tonnes between the displacement of a ship in water of relative density of 1,025 kg/m³ at the summer load draught and the lightweight of the ship. The summer load draught should be taken as the maximum summer draught as certified in the stability booklet approved by the administration or an organization recognized by it.

P is the power of the main and auxiliary engines, measured in kilowatt. The subscripts ME and AE refer to the main and auxiliary engine(s), respectively. The summation on *i* is for all engines with the number of engines (*n*ME).

V_{ref} , *Capacity* and *P* should be consistent with each other.

SFC is the certified specific fuel consumption, measured in gram per kilowatt-hour, of the engines. The subscripts ME(*i*) and AE(*i*) refer to the main and auxiliary engine(s), respectively. The SFC should be corrected to the value corresponding to the ISO standard reference conditions using the standard lower calorific value of the fuel oil (42,700 kJ/kg), referring to ISO 15550:2002 and ISO 3046-1:2002.

f_j is a correction factor to account for ship specific design elements.

f_w is a non-dimensional coefficient indicating the decrease of speed in representative sea conditions of wave height, wave frequency and wind speed (e.g. Beaufort Scale 6).

$f_{eff(i)}$ is the availability factor of each innovative energy efficiency technology.

$f_{eff(i)}$ for waste energy recovery system should be one (= 1.0).

f_i is the capacity factor for any technical/regulatory limitation on capacity, and should be assumed to be one (1.0) if no necessity of the factor is granted.

f_c is the cubic capacity correction factor and should be assumed to be one (= 1.0) if no necessity of the factor is granted.

Length between perpendiculars, *Lpp* means 96% of the total length on a waterline at 85% of the least moulded depth measured from the top of the keel, or the length from the foreside of the stem to the axis of the rudder stock on that waterline, if that were greater. In ships designed with a rake of keel the waterline on which this length is measured should be parallel to the designed waterline. *Lpp* should be measured in metre.

According to Regulation 20 of Annex VI of Chapter 4 IMO MARPOL 73/78 (IMO MEPC 203(62) 2011), the attained EEDI shall be calculated for each new ship, or

Table 5.2 Reduction factors (in %) for the EEDI relative to the EEDI reference line

| Ship type | Size | Phase 0 | Phase 1 | Phase 2 | Phase 3 |
|-------------------------|----------------------|------------------------|------------------------|------------------------|------------------------|
| | | 1 Jan 2013–31 Dec 2014 | 1 Jan 2015–31 Dec 2019 | 1 Jan 2020–31 Dec 2024 | 1 Jan 2025 and onwards |
| Bulk carrier | 20,000 DWT and above | 0 | 10 | 20 | 30 |
| | 10,000–20,000 DWT | n/a | 0–10* | 0–20* | 0–30* |
| Gas carrier | 10,000 DWT and above | 0 | 10 | 20 | 30 |
| | 2,000–10,000 DWT | n/a | 0–10* | 0–20* | 0–30* |
| Tanker | 20,000 DWT and above | 0 | 10 | 20 | 30 |
| | 4,000–20,000 DWT | n/a | 0–10* | 0–20* | 0–30* |
| Container ship | 15,000 DWT and above | n/a | 0–10* | 0–20* | 0–30* |
| | 10000–15000 DWT | n/a | 0–10* | 0–20* | 0–30* |
| General cargo ship | 15,000 DWT and above | 0 | 10 | 15 | 30 |
| | 3,000–15,000 DWT | n/a | 0–10* | 0–15* | 0–30* |
| Refrigerated cargo ship | 5,000 DWT and above | 0 | 10 | 15 | 30 |
| | 3,000–15,000 DWT | n/a | 0–10* | 0–15* | 0–30* |
| Combination carrier | 20,000 DWT and above | 0 | 10 | 20 | 30 |
| | 4,000–20,000 DWT | n/a | 0–10* | 0–20* | 0–30* |

* Reduction factor to be linearly interpolated between the two values dependent upon vessel size. The lower value of the reduction factor is to be applied to the smaller ship size.

any ship that has undergone a major conversion, which is so extensive that the ship is regarded by the Administration as a newly constructed ship which falls into one or more of the categories in regulations 2.25 to 2.35 (as shown in the below table). The attained EEDI shall be verified, based on the EEDI technical file, either by the administration or by any organization duly authorized by it.

According to Regulation 21 of Annex VI of Chapter 4 MARPOL 73/78, the attained EEDI shall be less/equal a required level, set by regulation, as follows:

$$\text{Attained EEDI} \leq \text{Required EEDI} = (1 - x) \text{ Reference line value} \quad (5.2)$$

where x is the reduction factor specified in Table 5.2 for the required EEDI compared to the EEDI Reference line.

The reference line values shall be calculated as follows (IMO MEPC 215(63) 2012):

Table 5.3 Parameters for determination of reference values for the different ship types

| Ship type defined in Regulation 2 of Annex VI of Chap. 1 MARPOL 73/78 | <i>a</i> | <i>b</i> = Capacity | <i>c</i> |
|---|----------|---------------------|----------|
| 2.25 Bulk carrier | 961.79 | DWT | 0.477 |
| 2.26 Gas carrier | 1120.00 | DWT | 0.456 |
| 2.27 Tanker | 1218.80 | DWT | 0.488 |
| 2.28 Container ship | 174.22 | DWT | 0.201 |
| 2.29 General cargo ship | 107.48 | DWT | 0.216 |
| 2.30 Refrigerated cargo carrier | 227.01 | DWT | 0.244 |
| 2.31 Combination carrier | 1219.00 | DWT | 0.488 |

$$\text{Reference line value} = a \times b^{-c} \tag{5.3}$$

where *a*, *b* and *c* are the parameters are given in Table 5.3.

The following figures represent typical reference lines for bulkcarriers, tankers and general cargo ships to be used in the assessment of EEDI according to the IMO MEPC 62/6/4 (2011): Consideration and adoption of amendments to mandatory instruments—Calculation of parameters for determination of EEDI reference values (Figs. 5.1, 5.2 and 5.3).

The following figure is from Lloyd’s Register (2012): Implementing the EEDI—Guidance for owners, operators, shipyards and tank test organizations (Fig. 5.4):

The key measures for reducing gaseous toxic emissions from marine engines, which goes along with the reduction of fuel consumption, are as follows:

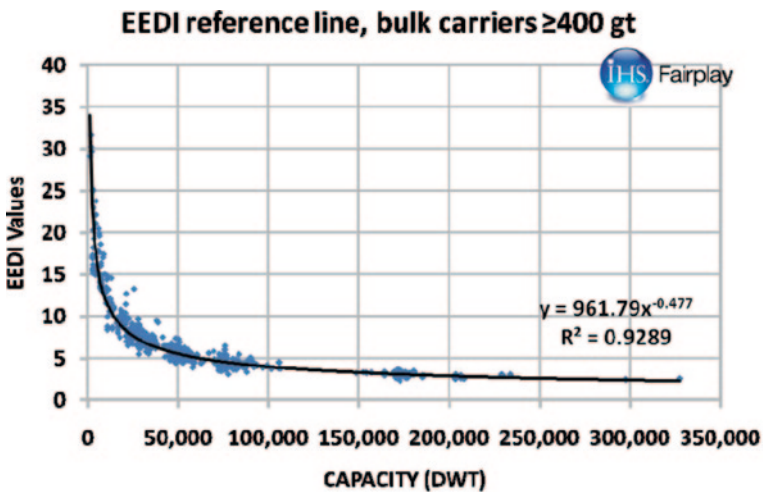

Fig. 5.1 Typical reference lines for bulk carriers (IMO MEPC 62/6/4 2011)

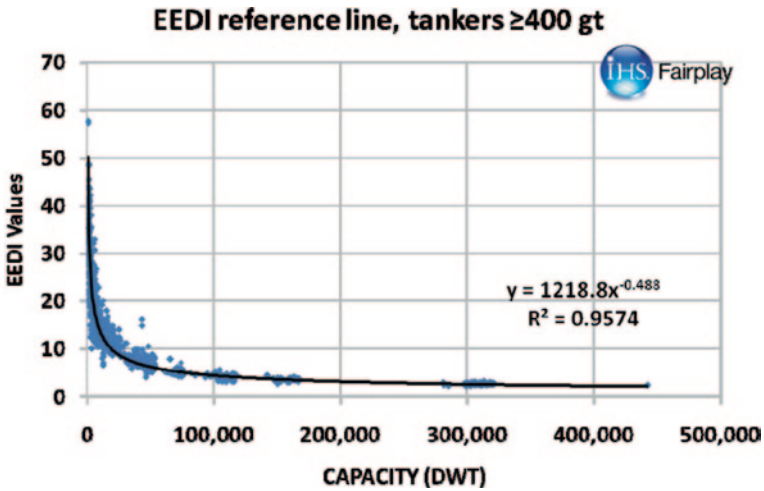

Fig. 5.2 Typical reference lines for tankers (IMO MEPC 62/6/4 2011)

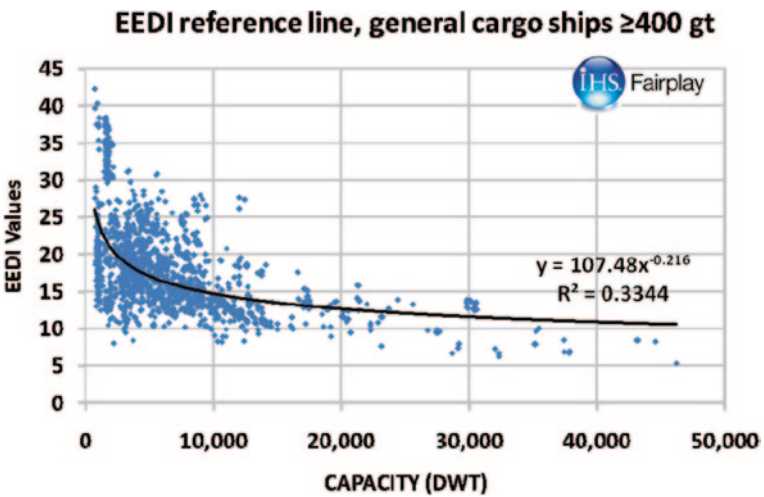

Fig. 5.3 Typical reference lines for general cargo ships (IMO MEPC 62/6/4 2011)

- Reduction of fuel consumption through reduction of ship's resistance and powering
 - Optimization of ship's hull form leading to a reduction of the required propulsion power for specified speed (calm water performance and added resistance in seaways, *new-buildings*)
 - Fitting of propulsive efficiency enhancing devices (stern flow ducts, spoilers, CPT propellers etc., for *existing ships and to some extent, new buildings*)

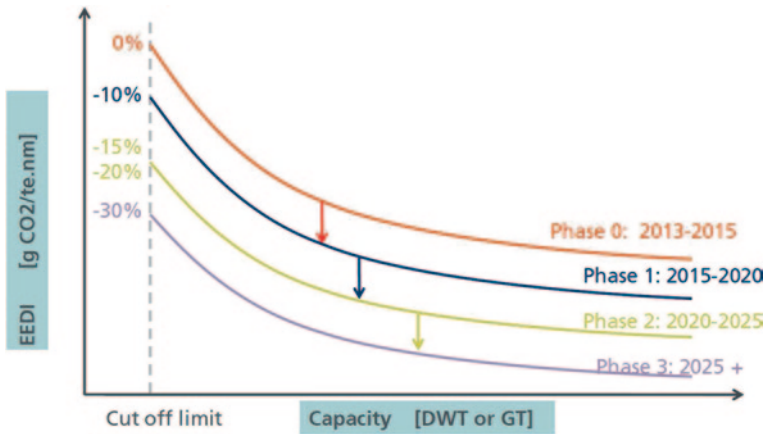

Fig. 5.4 EEDI concept (LR 2012)

- Refitting of bulbous bow (*existing ships*)
- Optimization of operational trim (*existing ships*)
- Minimization of the amount of carried ballast water (*new buildings and existing ships*)
- Reduction of viscous resistance through special treatment of wetted surface (paints etc.) and other innovation measures (release of air bubbles etc...) (*mainly new-buildings*)
- Optimization of ship's routing
- Reduction of service speed (*slow steaming*)
- Improvement of marine engines' technology
 - Reduction of SFOC
 - Reduction of toxic gas emissions
 - Dual fuel consumption (HFO/MDO-LNG)
- Improvement of fuel quality
 - Introduction of bio-fuels for marine engines

Figure 5.5 below shows indicative values for the specific fuel consumption, SFOC, and thermal efficiency of all basic types of main engines fitted to merchant ships. It is clear that in all commercial ship design scenarios, in which the installation of low speed diesel engines is feasible in terms of required engine room volume and weight, the low speed diesel engine will be the preferred type of engine and medium speed diesel engines will follow after. This is evident both from the point of view of lower specific fuel consumption for the low-speed diesel engines (see Fig. 5.1), and the lower price of their fuel; note that the cost for heavy fuel oil—HFO, which is the prime fuel for low-speed diesel engines, was about \$360/t in July 2009 and \$ 602/t in June 2014 (Rotterdam), whereas that of marine diesel oil—MDO for me-

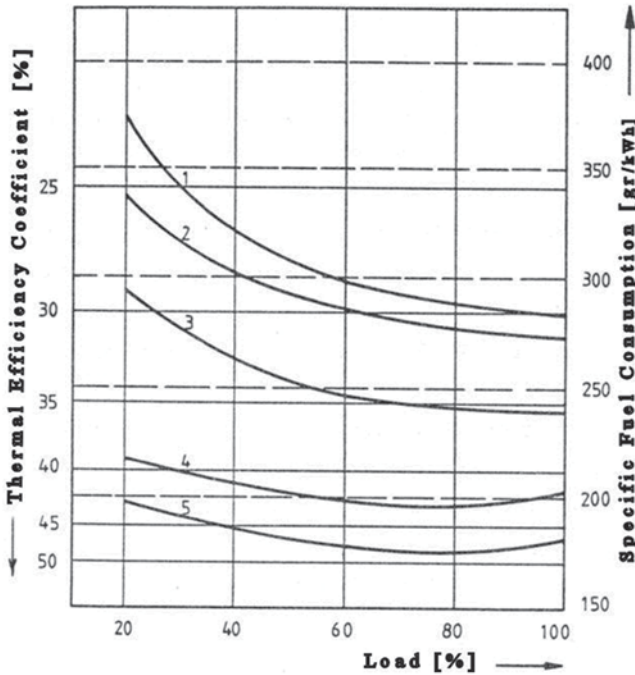

Fig. 5.5 SFOC and thermal efficiency of marine engines: 1 gas turbine, 2 steam turbine, power of 12 MW, 3 steam turbine, power of 30 MW, 4 medium-speed diesel engine, 5 low-speed diesel engine (Schneekluth 1985)

dium speed diesel engines was about \$472/t respectively, \$915/t in June 2014 (very drastic increase of fuel prices, while developments in medium speed diesel engines technology to run with inferior quality fuels are acknowledged).

Comparison of the Fuel Consumption of Different Transportation Means (Schneekluth 1985) A comparison of the fuel consumption of alternative (and partly competing) modes of transportation is outlined in the following. The following fuel consumptions refer to 100 km travelled distances with *non-stop and fully loaded* transportation means. Therefore the below benchmark is for an idealized condition, given the fact that neither the various transportation means are equally fully loaded, nor the fluctuations of loadings are the same. The reference fuel is *diesel oil*, except for the cases of airplanes and hovercraft ships, which are considered to run on *aviation kerosene* (gas turbine engine); ocean going ships are considered to run on *heavy fuel oil* (low speed diesel or steam turbine engines) (Tables 5.4, 5.5 and 5.6).

The above tables clearly illustrate the superiority of the ship as the most efficient (in terms of fuel consumption) and more environmentally friendly (in terms of gaseous emissions) transportation mean, particularly for merchandise and bulk cargo. However, it should be borne in mind that the above data do not take into account the transportation speed, which is important for high-value products and passengers, with high 'value of time'.

Table 5.4 Specific fuel consumption for transport of break bulk cargo

| Specific fuel consumption for transport of break bulk cargo | |
|---|--|
| Ship | 0.4 kg/(t 100 km) |
| Truck | 1.1–1.6 kg/(t 100 km) |
| Train | 0.7–1.6 kg/(t 100 km) |
| Airplane | 6–8 kg/(t 100 km) with respect to the airplane's transport capacity (including the weight of fuel) |
| | 11–14 kg/(t 100 km) with respect to the payload for transatlantic flights |

Table 5.5 Specific fuel consumption for passenger transportation (vehicles fully loaded, except otherwise mentioned)

| Specific fuel consumption for passenger transportation (vehicles fully loaded, except otherwise mentioned) | |
|--|----------------------------|
| Private car, only the driver as passenger | about 8 kg/(person 100 km) |
| Bus (55 passengers, speed 100 km/h) | 0.5 kg/(person 100 km) |
| German Intercity type train (10 wagons of 60 seats, 160 km/h) | 3 kg/(person 100 km) |
| German D type train (14 wagons of 72 seats, 140 km/h) | 1.5 kg/(person 100 km) |
| Airplane in transatlantic flight (with other load) | 17 kg/(person 100 km) |
| Airplane in European flight (no other load) | 3.6–6 kg/(person 100 km) |
| Hovercraft ship (600 passengers) | 5 kg/(person 100 km) |
| Contemporary cruise ship (500–1,000 passengers) | 16–18 kg/(person 100 km) |
| RoPax ship with passengers on deck (1,500 passengers) | 5–6 kg/(person 100 km) |
| Small river boat, with passenger seats on deck | 1.5 kg/(person 100 km) |
| Large river boat, with passenger seats on deck | 0.5 kg/(person 100 km) |

Table 5.6 Specific fuel consumption of modern aircraft per seat per kilometre. (Source: Scandinavian Airlines 2012, Traveller's Guide)

| Model | Maximum takeoff weight (metric tonnes) | Cruising speed (kilometre per hour) | Range (kilometre) | Fuel consumption (litre per seat per kilometre) |
|-----------------------------|--|-------------------------------------|-------------------|---|
| Airbus A340-300 | 275 | 875 | 12,800 | 0.039 |
| Airbus A330-300 | 233 | 875 | 10,100 | 0.033 |
| Airbus A321-200 | 89 | 840 | 3,800 | 0.029 |
| Airbus A319 | 75.5 | 840 | 5,100 | 0.033 |
| Airbus A320 | 73.5 | 840 | 3,500 | 0.029 |
| Airbus A737-600 | 59.9 | 840 | 2,400 | 0.038 |
| Airbus A737-700 | 69.9 | 840 | 4,400 | 0.032 |
| Airbus A737-800 | 79 | 840 | 4,200 | 0.028 |
| Airbus A737-400 | 63 | 800 | 3,150 | 0.034 |
| Airbus A737-500 | 57 | 800 | 4,100 | 0.039 |
| MD-82 | 67.8 | 820 | 2,400 | 0.041 |
| CRJ900 NG (next generation) | 38 | 840 | 2,100 | 0.039 |
| Boeing 717 | 53.5 | 820 | 2,800 | 0.037 |
| Dash 8-Q400 | 29.2 | 625 | 1,500 | 0.034 |
| Dash 8-Q300 | 19.5 | 485 | 1,500 | 0.034 |
| Dash 8-Q200 | 16.5 | 485 | 1,500 | 0.038 |
| Dash 8-Q100 | 15.6 | 515 | 1,500 | 0.038 |

B. Selection of the Propulsive Installation During the preliminary design stage, the knowledge of the weight and the required space for the main engine, as well as for auxiliary elements of the engine installation, including the fuel weight, is of prime importance. This applies in particular to fast ships (with high requirements on the installed power and substantial quantities of carried fuel), as well as to small ships, due to the increased importance of the above factors on the economic operation of the ship and on the distribution of ship's main weight groups.

The estimation of the machinery weight has been described in previous sections (see Sect. 2.15.6).

For diesel engines, it is noted that there is an upper limit of maximum delivered power per engine, which has reached the level of about 130,000 bhp for low-speed engines². If the required power exceeds the above limit or there is not available space and weight margin for the installation of a large low speed diesel engine, then the following options need to be explored:

1. Combination of power of more diesel engines through gearbox (applies mainly to medium-speed engines).
2. Multi-propeller propulsion installation with direct drive (one low-speed diesel engine per propeller) or through gearboxes (medium-speed diesels).
3. Fitting of steam turbine. It is assumed that the selection of steam turbine should be considered as a competitive option in all cases of high power requirement (>50,000 hp), due to the relatively low weight and simplicity of maintenance and operation.

Nevertheless, the rapid evolution of medium speed diesel engines (independently of the continuous growth of the upper limit of the horsepower of low-speed engines), especially their low weight/space requirements and their continuously decreasing specific fuel consumption, coupled with the high power output per cylinder, have made the medium-speed engines very competitive against all others for all the required power range of contemporary merchant ships (Fig. 5.6).

The use of gas turbines for merchant ships has almost disappeared in practice in the last 30 years, due to the dramatic increase of fuel costs and the high specific fuel consumption of gas turbines; exceptions from this rule are high-speed crafts, demanding very low-weight and limited-space engines and naval ships in general (gas turbines come often as 'boosters' in combined diesel and gas (CODAG) installations) (Figs. 5.7 and 5.8).

C. Specifications in the Shipyard–Owner Contract In general, the technical specifications of the contract between the shipyard and the interested ship owner specify a particular engine installation,³ as well as ship's speed in the *full load (at design draft) trial condition*.

² MAN B&W, 14K98MC with 108920 bhp at 94(r/min), 14K98MC-C with 108,640 bhp at 104 (r/min), 14K108ME-C with 132,300 bhp at 94 (r/min). Comparable performance have the SULZER engines (e.g. 112RTA 96C).

³ It is assumed that a study (numerical estimation and verification by model experiments) on the required power to achieve the specified speed has been conducted prior to the contract.



Fig. 5.6 Low-speed diesel engine MAN B&W 12K98MC (2004). 68,647 kW/93,360 PS, 94 rpm maximum. Heavy fuel oil: ISO-F-RMH, maximum viscosity 700 cSt. Consumption: 230 t/day for a 25-knot post-Panamax container ship

| Configuration with one slow speed two-stroke main engine | | | | Ships where common |
|--|-------------|----------------------------|---|---|
| FP propeller | Main engine | Gensets | 1 main engine 1 FP propeller 3 gensets | Most merchant ships from medium size and upwards |
| FP propeller | Main engine | Gensets Shaft generator | 1 main engine 1 FP propeller 2 gensets 1 shaft generator | Many merchant ships of the 1980s and 90s from medium size and upwards |
| CP propeller | Main engine | Gensets | 1 main engine 1 CP propeller 3 gensets | Some mostly medium size merchant ships |
| CP propeller | Main engine | Gensets Shaft generator | 1 main engine 1 CP propeller 2 gensets 1 shaft generator of the 1990s. | Some mostly medium size merchant ships |

Fig. 5.7 Typical arrangements of low-speed (two-stroke) diesel engines directly connected to either fixed or controllable pitch propeller, including arrangements of generator sets (Dudszus and Danckwardt 1982)

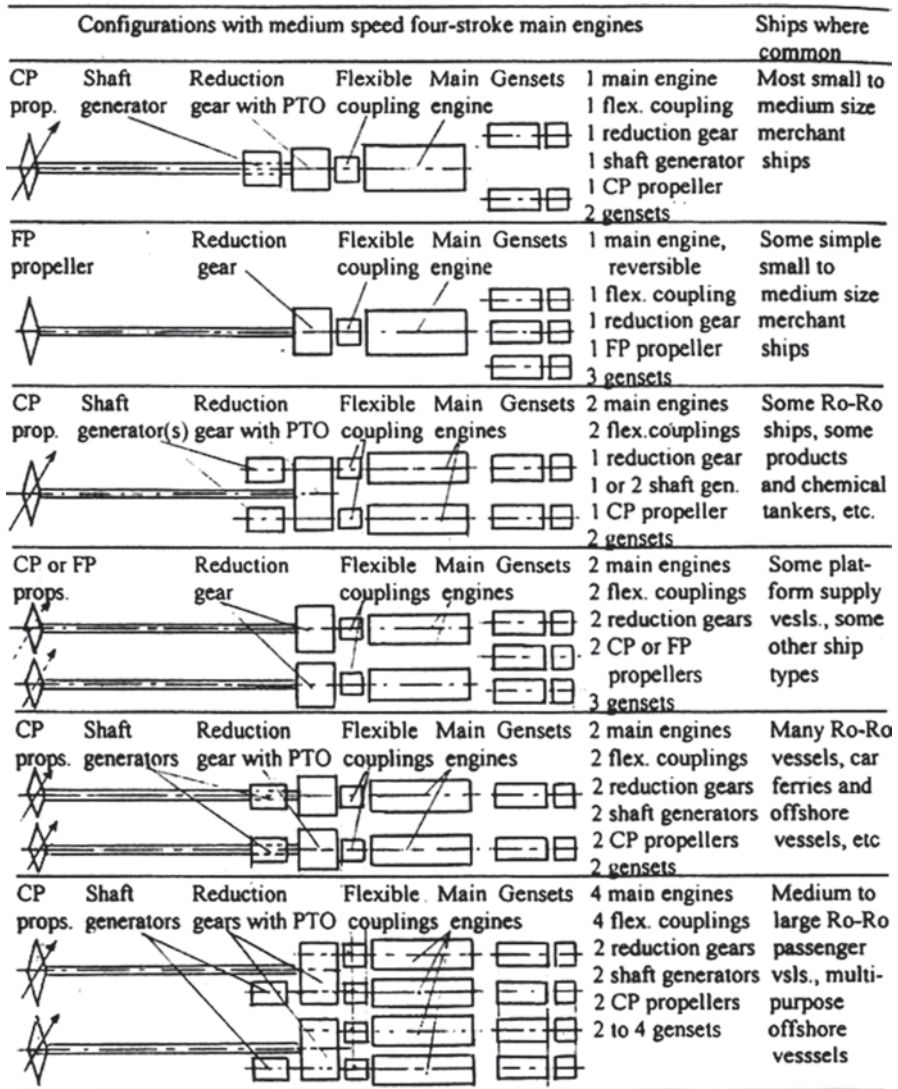

Fig. 5.8 Typical arrangements of medium-speed (four-stroke) diesel engines connected via reduction gear(s) to propeller(s) of fixed or controllable pitch, including arrangements of generator sets (Dudszus and Danckwardt 1982)

The specified/nominal engine power is defined according to the international ISO regulations as the maximum continuous power that the engine can deliver without interruption at corresponding revolutions and under conditions specified by the manufacturer. Interruptions for the necessary maintenance or repairs, which are prescribed by the manufacturer, are not taken into account. The above power is known with the abbreviation MCR (maximum continuous rating). Typical prescribed environmental conditions associated to MCR are (Table 5.7):

Table 5.7 Typical prescribed environmental conditions associated to MCR

| | |
|--|-----------|
| Atmospheric pressure: | 1000 mbar |
| Engine room temperature of: | 45 °C |
| Relative humidity of engine room: | 60% |
| Temperature of feed air and cooling water: | 32 °C |

The in-service loading and the rating of the delivered power of diesel engine machines, assumed today in the design condition, are usually 75–85% MCR for the following reasons:

1. The specific fuel consumption is minimal for diesel engines in this region (see Fig. 5.5).
2. The wear of the machine and the repair costs decrease significantly for reduced engine loading of less than nominal 100%.
3. If a fixed-pitch propeller is used, there is a fundamental problem to deliver the installed full MCR under service conditions in view of the gradual change of the operating conditions of propeller and engine. Specifically, due to the gradual resistance increase (fouling of the hull, rough sea etc.), a change of the relationship: required power $P_B = 100\% \text{ MCR} \Rightarrow 100\% n_M$ (engine revolutions) is concluded. Thus, the availability of approximately 15–25% power margin can cover possible *increases of propulsion power demands for maintaining the service speed*.

The above deliberations regarding the availability of power margin are nowadays further enhanced by considerations of *slow steaming* for certain transportation scenarios accounting for the high fuel prices and the competitive market conditions.

For every diesel engine (Fig. 5.9), the manufacturer informs the operator of the regions of engine speed-power for safe operation, both for the continuous operation (CSR: continuous service rating), the maximum continuous operation (MCR: maximum continuous rating), and the regions of limited/short time of operation (region 2: permitted/allowed short time of operation at reduced loading, region 3: permitted/allowed short time of overcharge of the engine).

Characteristic operational data of different types of diesel engines are given in Papanikolaou and Zaraphonitis (1988) and in known manufacturers' web sites.

D. Selection of Main Engine We consider that the required power of the main engine, which must be delivered and absorbed by ship's propeller for developing a speed V , is pre-determined by theoretical predictions and (in practice) validated subsequent model tests, that is, we have the $P_D = f(n)$ curve, where P_D : delivered horse power and n : propeller revolutions. In Fig. 5.5 (Dudszus and Danckwardt 1982) below, the following refers to the various shown curves.

- 1: trial condition, reduced draft, calm water;
- 2: ballast condition, relatively calm sea;
- 3: usual loading condition (70% DWT), moderate hull fouling, moderate sea state;
- 4: fully loaded (100% DWT), significant hull fouling, high seaways;
- 5: sailing in shallow waters;
- 6: towing condition, zero speed.

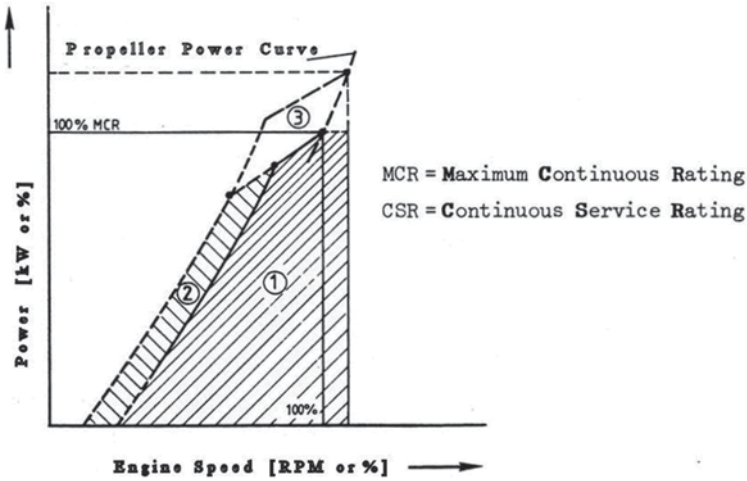

Fig. 5.9 Typical engine speed–power diagram of a ship’s diesel engine with typical regions of operation

In addition, for the engine to be selected, the maximum brake power P_B is considered, as given from the data of the manufacturer, where P_B = break horse power and the effective power $P_e = f(n_M)$, where P_e : effective horse power and n_M : corresponding revolutions of the main engine.

The delivered power to propeller $P_D = f(n)$ curves are of parabolic type. In contrast, the corresponding characteristic lines of diesel engine’s operation are straight $P_e = f(n_M)$, where P_e is the effective power of main engine, n_M : revolutions of main engine. The marked straight lines $P_e = f(n_M)$ in the previous graph correspond to various ratios of delivered engine’s torque/moment (M_d) or cylinder pressure (p_c), recalling the known relationship (Dudzus and Danckwardt 1982):

$$M_d = \frac{1}{2\pi} \frac{P_e}{n_M} = \frac{V_M \cdot p_c}{2\pi \cdot i} \tag{5.4}$$

where

- M_d Delivered engine torque/moment (kilonewton-metre)
- P_e Effective power (kilowatt)
- n_M engine revolutions (1/s)
- p_c mean effective cylinder pressure (megapascal) 1 MPa = 106 N/m²
- V_M volume of engine’s cylinders (cubic metre)
- i 1: two-stroke, 2: four-stroke diesel engine

From the above relationship it is concluded for the effective power P_e :

$$P_e = V_M \cdot p_c \cdot i^{-1} \cdot n_M \tag{5.5}$$

namely, for constant cylinder pressure p_e , of cubic capacity V_M , or for constant torque/moment M_d , there is a linear relationship:

$$P_e \propto n_M.$$

From the difference in the character of the curves $P_D=f(n)$ and $P_e=f(n_M)$, it is evident that an excess of the generated effective moment of the engine, even for reduced revolutions n_M in relation to the nominal (100%: nominal speed), may result.

Thus the manufacturer specifies the following operational regions and characteristic points of the engine:

- a. Maximum continuous power, maximum brake power (P_B), nominal power P_e

$$P_e = \text{MCR}$$

This power corresponds to 100% revolutions of the engine (nominal speed). It is recommended to avoid exceeding the MCR, in all cases, thus the operating points under service conditions are in the region of about 75–85% MCR.

- b. The operating region I corresponds to the usual, continuous service (CSR). This region is bounded by the lines of 100% P_B and 100% M_d (or p_e).
- c. The operating range II is only for limited duration (torque limit, operating range temporary admissible), e.g. during the acceleration or manoeuvres.

Notes (Fig. 5.10, Dudszus and Danckwardt 1982)

1. The vertical scale on the right side of the diagram refers to the ship's speed V in conditions 1 and 3, in relation to the trial speed ($V_T \equiv V_{1,0}$ for 100% MCR).
2. The speeds achievable in the conditions 1 (trial), 3 (service) for engine output 100, 75, 50 and 25% MCR (see curves 1 and 3) are given on the same scale.
3. The indices (1,0) mean:

$V_{1,0}$: trial speed

$n_{1,0}$: propeller revolution for $V_{1,0}$ or nominal engine revolutions

$P_{D1,0}$: delivered power to the propeller for $V_{1,0}$.

5.2 Selection of Propeller

A. General Issues

A.1. Fixed Pitch Propellers

History The fundamental idea of the function of a *screw/propeller* (and its companion the *impeller*) as a means to lift water for irrigation or thrust generated by fluids is due to the Great Greek mathematician, physicist, astronomer, engineer and innovator *Archimedes* (287–212 BC), when he introduced his screw pump (Fig. 5.11).

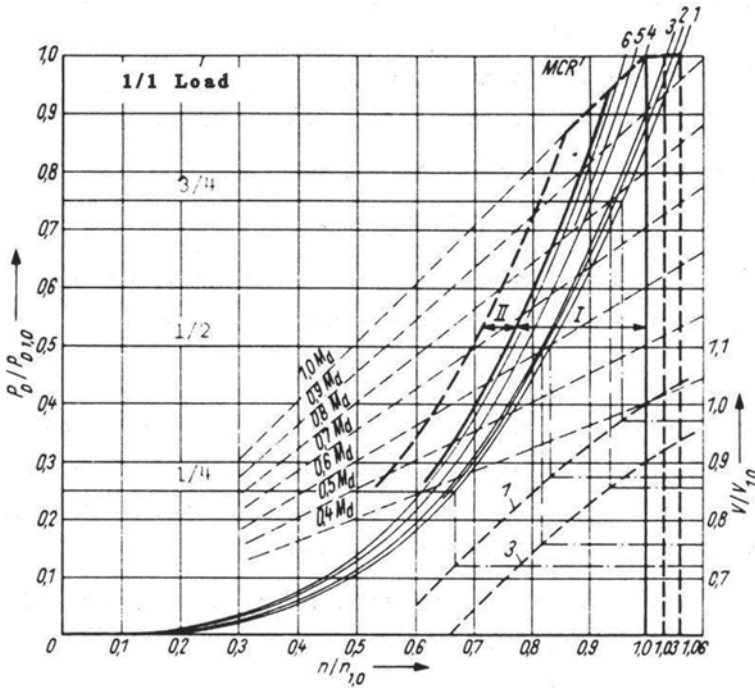
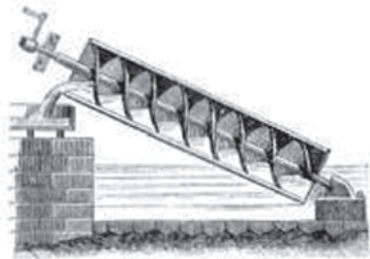

Fig. 5.10 Typical curves of propeller and diesel engine powering vs. propeller/engine revolutions for a cargo ship according to Dudzus and Danckwardt (1982); Region I: continuous operation without restrictions; Region II: short operation within time limits set by the manufacturer

Fig. 5.11 Archimedes' screw pump



Long after, the eminent scientist Daniel Bernoulli⁴ (1730) proposed the propeller as propulsive means of floating vehicles. Almost 100 years later, *R. Wilson, F. Sauvage, J. Ericsson and F. P. Smith*⁵ refined D. Bernoulli's proposal, so that a few

⁴ Daniel Bernoulli (1700-1782): Eminent Swiss mathematician and physicist, with pioneering contributions to fluid mechanics (conservation of energy, Bernoulli equation) and to the theory of probability and statistics (St Petersburg Paradox; risk theory); in his work 'Hydrodynamica' (published in 1738) he laid the foundations of the theory of watermills, windmills, water pumps and water propellers.

⁵ *J. Ericsson and F. P. Smith* filed in parallel controversial patents for the use of propeller as propulsive means of ships (1836); *Francis Pettit Smith* discovered the way of building screw propellers



Fig. 5.12 SS Great Eastern (launched 1858), propelled by two side paddle wheels plus one screw propeller

decades later the propeller replaced the paddle wheels as main propulsive means of ships. The first large ship to be fitted with a screw propeller was the famous *SS Great Eastern* of Isambard Kingdom Brunel. She was by far the largest ship ever built at the time of her launch, in 1858; she had a capacity of 4,000 passengers and could sail around the world without refuelling at a speed of 14 knots (Fig. 5.12).

a. Main Features (Comparison: propulsion with propeller against earlier used propulsion systems, e.g. side paddle wheels) :

- High efficiency
- Easy adaptation to alternative hull form designs and ship's operation
- Weak effect of seaway on its performance
- High number of propeller revolutions
- Protected location: less exposed, below the free surface at the stern
- Small disturbance on the general arrangement of the ship
- Small weight
- Possibility of receiving large delivered propulsion power; today, up to about 75,000 hp⁶ per propeller shaft.

b. Number of Blades

Two to six (seven) blades per propeller

Two: fast small boats, outboard engines

Three: multi-propeller ships, fast passenger ships, naval ships

Four: ordinary cargo ships

Five: sometimes for high-powered cargo ships, reduce vibration level

Six: rare, occasionally for high powered large ships and old transatlantic ocean liners, e.g. the former 'Queen Elisabeth II'

Six to seven: large naval submarines (nuclear-powered).

of the type we know them today accidentally. Up to that time, propellers were literally screws, of considerable length. But during the testing of a boat, the screw broke, leaving a fragment shaped much like a modern boat propeller. The boat moved faster with the broken propeller; this event may have led us to the ship propellers of today!

⁶ MEGA Containership Project: estimated propulsive power about 100,000 hp, diameter of propeller (if single screw) up to approximately 12 m (according to estimations of Lloyd's Register).

Fig. 5.13 The Rolls Royce Kamewa adjustable pitch propellers

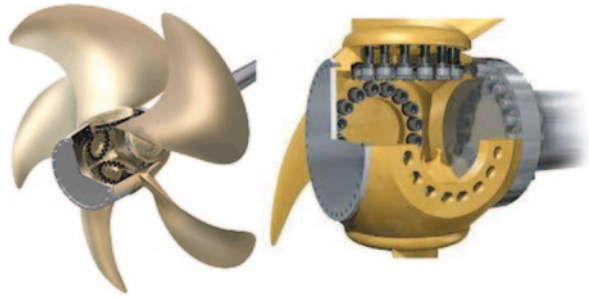

Fig. 5.14 Large, high powered, fixed-pitch propeller for post-Panamax container ship (2004). Diameter 9.10 m; six blades, total weight 102 t

c. Construction

Earlier times (until around the World War II): Individual blades bolted to the propeller hub.

Advantage: Easy casting of blades, easy repair; slight change of the pitch during docking possible.

Most recent developments: The Rolls Royce Kamewa adjustable pitch propellers (ABP) (Fig. 5.13); the concept is based on a hollow hub with blades bolted to it from the inside. In comparison to conventional monoblock fixed-pitch propellers (Figs. 5.14 and 5.15), the ABP has higher-quality blade machining and reduced overall weight, which results in easier shipment, handling and mounting. The slotted holes on the hub allow the blade pitch angle to be conveniently adjusted at commissioning, or in service to compensate for long-term

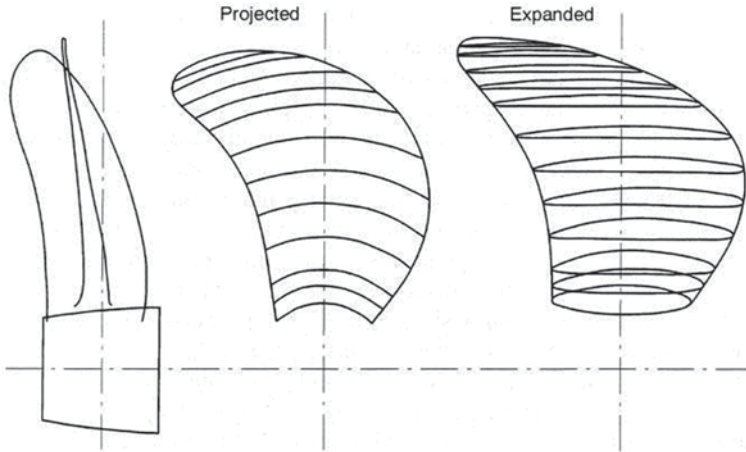

Fig. 5.15 Fixed pitch propeller geometry (Friis et al. 2002)

variations in hull resistance. Individual blades can be replaced without dry-docking, and only spare blades have to be stocked rather than a complete monoblock propeller.

Nowadays: Mostly casted, fixed-pitch monoblock propeller.

Advantage: Small hub: higher efficiency, better absorption of bending moments of the blades at the base of the hub

Construction material: Mainly manganese bronze and other copper-tin alloys.

A.2. CPP (Controllable Pitch Propellers)

a. Main features: Direct connection of engine's operational profile to the propeller for maximum absorption of generated horsepower, without changes in the engine and propeller's revolutions, by adaptation of the pitch of the propeller to the various operating conditions and thrust demand of the ship. It also eliminates the need for a reversing gear and allows for more rapid change to thrust, as the revolutions are constant.

Characteristics of Engines:

- **Reversing Capability**

Diesel engines: Easily reversing, but causing high thermal loading due to the low temperature of the supplied air at the startup

Steam turbine: Reversing power about 40% of that ahead, development of thermal stresses at the bearings of the blades

Gas turbines: Irreversible

Fig. 5.16 Relationship of torque vs. engine revolutions for diesel (a), steam turbine (b) and gas turbine (c)

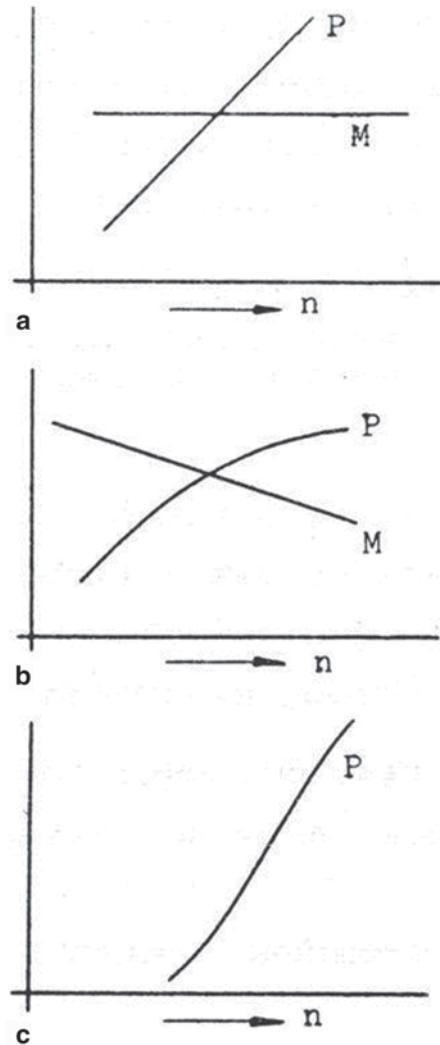

- **Relationship of Torque vs. Engine Revolutions**

Diesel engines: For constant fuel rating we obtain constant torque and a linear relationship between the effective power and the number of engine revolutions (see Fig. 5.16a).

Steam turbines: Decreasing torque with increasing number of engine revolutions, gradual increase of effective power (see Fig. 5.16b).

Gas turbines: Rapid increase of effective power with the increase of engine's revolutions (see Fig. 5.16c).

- **Minimum Revolutions**

Diesel engines: About 30% of the nominal number of revolutions (nominal speed)

Turbines: Very low limit compared to the nominal speed

B. Application of CPPs

Large Changes of Thrust Demand CPP is commonly applied to fishing vessels or tug boats, because of their two totally different operating conditions: *free cruising at high speed* to the service area (e.g. fishing area or work/assistance area for tugs) and *towing condition* (e.g. trawling of fish net or towing of other vessels by tugs) at *low speed* and high thrust demand. In the case of applying *fixed-pitch* propeller in towing condition, the engine revolutions may reduce by about 70% and correspondingly the delivered power of the main (diesel) engine drops. Also, due to the resulting high thrust rating (high thrust T at low speed), the efficiency of the propeller is significantly reduced and may drop down to 30%; thus, the total efficiency of the propulsive system (machine–propeller) is very low. With the application of CPP, the propeller pitch can be reduced so as to keep a high number of propeller revolutions and consequently of the speed of the engine, with high efficiencies on both ends.

Comparable heterogeneous conditions do not present for normal merchant ships in their operation, and therefore, it is not recommended to use CPPs in these cases, because of the involved additional installation costs and some other drawbacks. Exceptions to this rule are safety critical vessels, like passenger ships, where CPPs contribute to excellent steering/manoeuvring capability (berth manoeuvring in limited waters), thus typically they are applied as twin CPPs to all contemporary passenger ships.

Variable Engine and Propeller Loading of Naval Ships Particularly for naval ships, two characteristic operating conditions prevail:

Cruising at marsh speed: Requirement for low fuel consumption and operating cost, which is achieved by combined diesel and/or gas or steam turbine machines

Cruising at top speed: Requirement for the availability of additional, relatively light engines (*boosters*), which can boost the ship to top speed; e.g. gas turbines and CODAG systems.

If the propulsion plant considers the synchronous or individual use of different engines/machines for the marsh and top speed, the use of CPPs is practically imperative.

C. Efficiency of CPPs As the *radial* distribution of the pitch of the propeller blades is optimal for *only one* blade position, it is clear that for other positions of the blades, except for the optimal one, the efficiency decreases. In addition, the relatively large hub of CPPs *negatively* affects the propeller efficiency.

D. Operating Modes with CPPs CPPs can operate with constant speed/revolutions, which is anyway necessary if the propulsion plant is directly connected to electric generators. In the case of autonomous electric generator sets, it is attempted to achieve optimum propeller performance with the synchronous change of the propeller pitch *and* revolutions (through one single control lever). In the low revolution

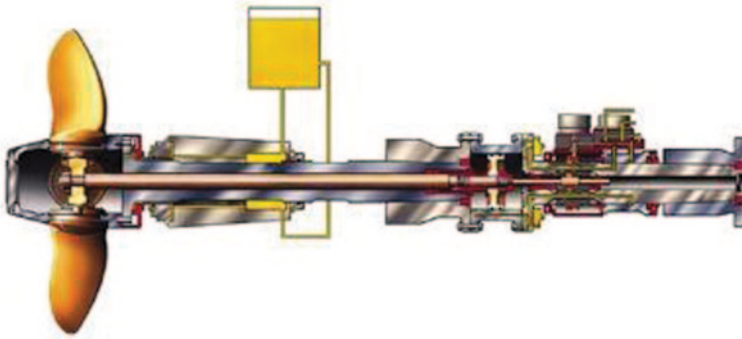

Fig. 5.17 Controllable pitch propeller

range, only the pitch adjustment is possible. Modern diesel–electric propulsion plants (mainly on passenger ships) allow the operation of the propulsion and electrical systems with best performance for both the engines and for the propulsive means.

Attention To keep *zero* thrust, with the engine turning, the blades of the CPP must turn almost perpendicular to the axis of the propeller; thus their projected disk area overlaps the rudder of the ship, preventing the water flow to the rudder; thus, due to the lack of a lifting force on the rudder, the manoeuvrability of the ship greatly reduces (Fig. 5.17).

B. Number of Propellers

B.1. Selection Criteria

a. Weight, space requirements, cost: A multiple-propeller ship is economically inferior to a single-propeller ship for the following reasons:

1. More bearings for engine, shafts etc.
2. Larger required engine room, if engine placed abaft
3. Higher space requirements in general (two propeller shaft tunnels)
4. More auxiliary machinery, piping etc.
5. More personnel, maintenance/repair effort
6. Higher weight
7. Higher acquisition/installation cost

b. Number of engines: The limited power of a single diesel engine, for instance, low-speed engines have today an upper limit of about 130,000 hp, but also the limiting value of maximum absorbed power by a single propeller, which is at about the same level, requires the installation of more than one propellers on specific types (and sizes) of ships with generally high horsepower requirements (e.g. large and fast container ships, large and fast RoPax ships, ultra large tankers and naval ships) .

For very high horsepower requirements on large ships, beyond a set of more than one low-speed diesel engines, or of medium speed engines, it is advisable to consider the use of steam turbines, with practically unlimited maximum delivered power.

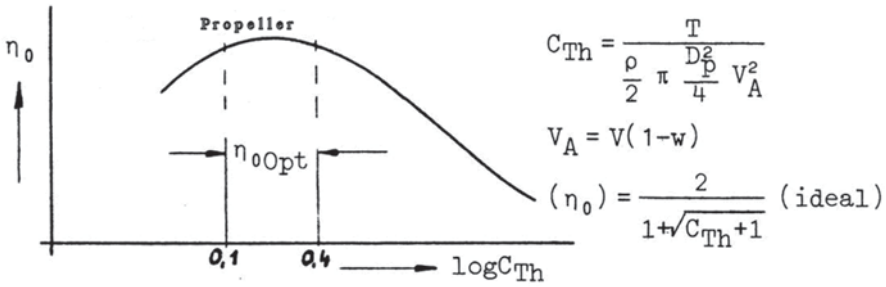

Fig. 5.18 Qualitative relationship of thrust coefficient C_{Th} and propeller efficiency

- c. **Propulsion redundancy:** Multi-propeller and multi-engine ships have the propulsion ability even in case of failure of one unit. Especially for RoPax and passenger ships in general, this is an important feature ensuring safe operation (see requirements of Safety of Life at Sea (SOLAS), ‘safe return to port’ provisions).
- d. **Steering:** In case of rudder failure, a twin-screw ship is able to perform limited manoeuvring by setting different revolutions for the two propellers. Also, opposite (contra-)rotating propellers can turn the ship in restricted waters (e.g. berthing at ports etc.). RoPax ships engaged in frequent manoeuvres at limited berthing ports are required according to SOLAS to dispose two independent propellers driven by two independent main engines.
- e. **Exploitation of wake losses:** As known, the frictional part of a ship’s wake decreases significantly in the transverse direction, as we depart from the ship’s centreplane. Thus, ships with at least one middle propeller have higher hull efficiency factor η_{Hr} , than twin-screw ships.
- f. **Propeller efficiency:** The propeller efficiency depends mainly on the thrust loading coefficient C_{Th} . Generally, in the common range of propeller operation, the propeller efficiency η_0 decreases significantly with the increase of C_{Th} and of propeller loading (see Fig. 5.18).

Thus, in case of high required thrust levels, particularly for low-speed design scenarios, i.e. high C_{Th} coefficients, the installation of two propellers is preferable, because this way the resulting C_{Th} is reduced and the efficiency η_0 increases. Thereby, it is assumed that the maximum allowable ship’s draft does not allow the installation of a single propeller of large diameter (maximum diameter: approximately 65–70% of the ship’s draft). The resulting relatively high efficiency η_0 of the multi-propeller ship compensates the aforementioned reduction of hull efficiency η_{Hr} .

Another way of reducing C_{Th} and thus increasing the propeller efficiency in high-thrust/low-speed conditions is the fitting of *Kort* type nozzles, leading to *ducted-propellers*, in which the onset flow speed to the propeller is increased and the propeller loading and C_{Th} decrease; it is applied frequently to tug boats and fishing vessels (Fig. 5.19).

- g. **Conclusion:** In general, the number of propulsive means should be kept at minimum. Taking into account the specific design and operational conditions of the study ship (requirements of space arrangement, thrust and speed conditions and

Fig. 5.19 Ludwig Kort's nozzle (invented 1934) and ducted propeller



magnitude of propulsive power) multi-propeller installations may be concluded; in that case, the propulsion installation must be carefully designed (for optimal water onset flow) to compensate for the additional costs for the propeller fitting and the operation of the ship.

B.2. Typical Number of Propellers

Cargo ships: commonly one, occasionally two for fast ships

Bulk carriers: always one, rarely two (large ships)

Tankers: usually one, large very large crude carrier (VLCC) and ultra-large crude carrier (ULCC): two

Short-sea cargo ships: always one

Container ships: one to two (depends on size), in the past up to three

Reefers: mostly one

Past transatlantic ocean liners: mostly four, occasionally two

RoPax: commonly two

Tugs: mostly one, occasionally two

Icebreakers: two, occasionally four

Naval ships: mostly two, occasionally three and four.

C. Arrangement of Propellers

C.1. Overview

a. Astern or Bow Propellers

The placement of the propeller at the stern of the ship is preferable for the following reasons:

1. The pitch and absolute motions of the stern of the ship are smaller than the corresponding motions of the bow; thus likely propeller emerging in seaways is reduced.
2. The protection of the propeller against damage is much higher at the stern.

3. Though the open water efficiency η_O of a bow propeller may be higher in calm water conditions, the overall propulsive efficiency of a stern propeller is higher, because through the stern propeller it is possible to regain part of the lost energy corresponding to the frictional part of the wake of the ship. This is reflected in the relatively high propulsive coefficient η_D .
4. The ship's general arrangement is less disturbed.

The application of bow propellers is sometimes seen on double-ended, small car ferries, with symmetrical bow and stern propulsive and navigational arrangements, and also on some icebreakers.

b. Propeller Diameter

As the diameter of the propeller increases, the thrust coefficient C_{Th} decreases rapidly with the square of the diameter, and consequently the efficiency increases. However, simultaneously, the peripheral speeds at the tips of the propeller blades also increase, in other words, the local hydrodynamic pressure decreases, which increase the risk of cavitation. In general and in the absence of other constraints, the propeller diameter is selected in the range of 65–70% of ship's design draft.

C.2. Single-Screw Ships

a. Typical diameter sizes:

Cargo ships 5.0–6.5 m

Reefer ships 4.8–5.3 m

Tankers up to about 10 m

Mega-container ships up to about 12 m (projected)

b. Propeller position as to the waterline: The partially (even periodically) emerging propeller induces strong fluctuations of generated thrust and vibrations, due to the trapping of air bubbles close to the propeller blades. It is considered that in the loaded condition, the propeller shaft/axis must be immersed by approximately *one diameter* below the waterline. In ballast condition of ordinary cargo ships, the propeller may emerge by one-seventh to one-third of its diameter. The negative effects of possible propeller emergence (*propeller racing*), which occurs rarely (mainly in ballast condition or in extremely rough seaways), are compensated by the good performance of a large diameter propeller in the full load, design condition. For tankers, due to their frequent cruising at ballast draft (half of their voyages), it is necessary to ensure that the propeller is fully immersed in the ballast condition (see regulations of International Convention for the Prevention of Pollution from ships (IMO MARPOL 73/78 2013)). Also, the optimization of their operational trim in ballast condition is a matter of prime interest to operators, in view of possible reductions of fuel cost expenses.

c. Clearances between propeller and stern hull: During the rotation of the propeller and in particular as the propeller blade tips approach the rudder and the stern hull, impulsive loading phenomena occur, which are expressed as fluctuations of propeller's thrust and torque, vibrations and noises, which are transmitted through the propeller shaft to the engine as well as to ship's hull in front of

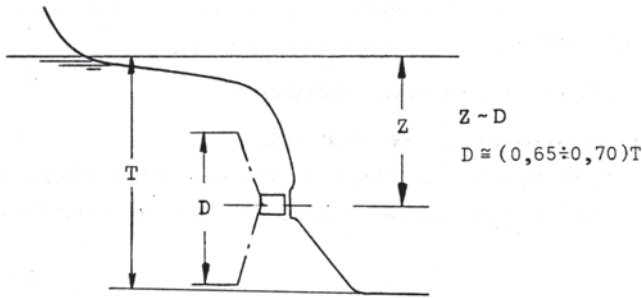

Fig. 5.20 Propeller diameter and magnitude of propeller immersion of single-screw ships

the propeller. Simultaneously, having the propeller astern (*in the wake*) of the hull causes fluctuations of the generated thrust, because of the uneven water onset flow to the propeller.

The minimum clearances between propeller and the neighbouring fittings and the hull of the ship are specified by classification societies and have been already commented on in Sect 3.5. It should be pointed out that since the early 1950s, with the introduction of *Mariner* class general cargo ships, the ‘hanging/suspended’ rudder without rudder heel has prevailed. Thereby, the induced oscillations are reduced and larger propeller diameters could be fitted with high efficiency (Fig. 5.20).

C.3. Multi-Screw Ships

- a. **Rotation direction:** Side propellers always rotate symmetrically, but contra-rotating; generally, looking from astern, from top to down and from inside to outside.
- b. **Arrangement and diameter:** Except for the fast naval ships, where the propellers can rotate partially below the keel line, it is recommended for the propeller tips of multi-screw ships to turn a little above the baseline.

Typical values of propeller diameters D_p and ratios to ship drafts T of multi-screw ships (Table 5.8):

- c. **Longitudinal position:** The longitudinal position of the side propellers should be located as sternward as possible, despite the associated extension of the propeller shaft. The internal and external propellers of four-screw ships (e.g. old, fast transatlantic passenger ships) are placed lengthwise shifted. Also, it must be considered that the projections of the disk areas of three-screw or four-screw ships do not overlap in the cross view (see Fig. 5.21 and Fig. 5.38).

Table 5.8 Typical values of propeller diameters D_p and ratios to ship drafts T of multi-screw ships

| | D_p (m) | D_p/T |
|-------------------------------|-----------|------------------------|
| Fast (historic) ocean liners: | 4.9–6.0 | 0.45–0.60 |
| Large passenger ships: | 4.8–5.6 | 0.58–0.67 |
| Modern RoPax: | 2.4–3.8 | 0.56–0.73 ^a |

^aModern fast RoPax ships may be fitted with twin propellers of very large diameter, when applying *tunnel-type* sections at the stern

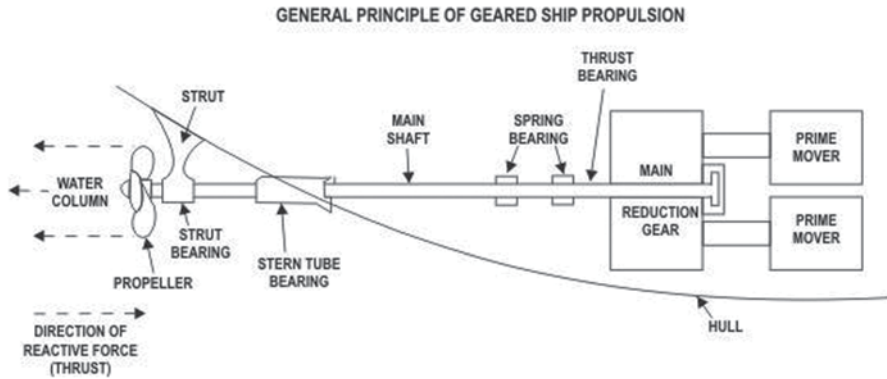

Fig. 5.21 General principle of geared ship propulsion (Lewis 1988)

d. Position of propeller end shaft and stern tube bearing: The simplest fitting solution is to install the propeller end shaft parallel to both the basic reference plane (keel) and the ship's centreplane. Differentiations, namely diverging axes as to the aforementioned planes, are often the result of specific arrangements/constraints of the propellers or the machinery.

Regarding the location of the stern tube bearing, there are two conflicting criteria: The bearing should be easily accessible to simplify the installation and maintenance of the propulsion system; however, the length of the end shaft should not exceed an upper limit, which may reach quite large values for large/slender ships.

e. Exits of propeller end-shafts

Alternative Fitting Solutions:

- a. Long shaft bossing
- b. Short shaft bossing and additional support (bracket)

Long shaft bossing is preferred on relatively full hulls (tankers), while on the contrary the fitting method (b) is usually applied to fine-slender ships.

The reasoning for these preferences is as follows: for full-type ships the length of the shaft bossing is limited in practice and the additional fitting of individual brackets is not required for reducing the bossing's wetted surface. In contrast, for fine-slender hulls the bossing would have been enlarged, leading to an increase of ship's viscous resistance, also in view of possible flow separation. Thus, the short bossing with shaft brackets in between is recommended for fine-slender hulls, which reduces the wetted surface and proves to be the more efficient solution, assuming that the cross-section and location of the brackets are properly designed by the conduct of model tests (and/or computational fluid dynamics (CFD) calculations).

Contemporary developments in the hull form optimization of the stern of full type, twin hull ships (e.g. large tankers or bulkcarriers) consider the design of *twin-skeg* stern arrangements, with excellent propulsive efficiency results, if properly optimized. (Fig. 5.22)

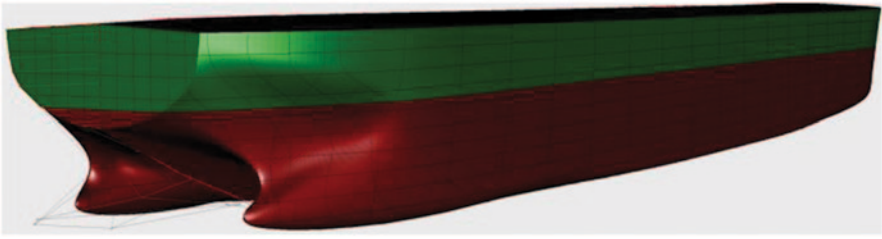

Fig. 5.22 Optimized twin skeg arrangement of innovative tanker (Nikolopoulos, NTUA-SDL 2012)

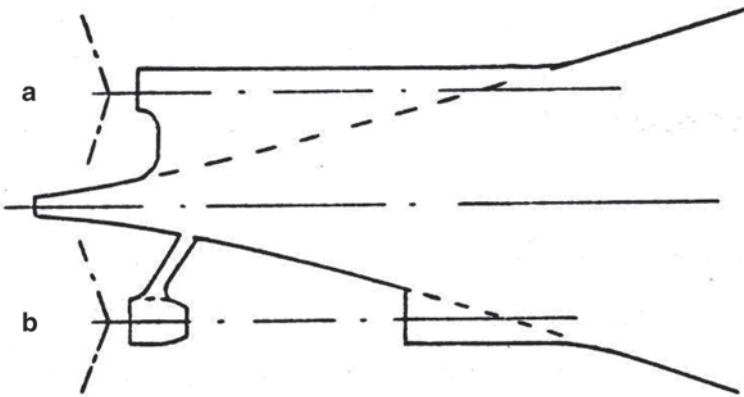

Fig. 5.23 Configuration of shaft bossing for multi-screw ships

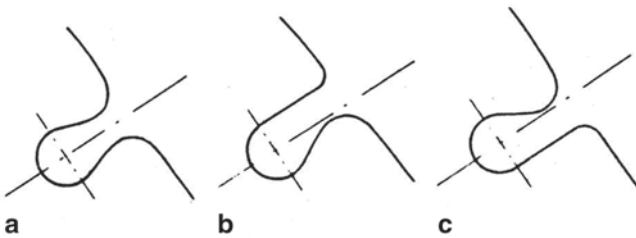

Fig. 5.24 Possible cross sections of shaft bossing for multi screw ships

Configuration of Bossings and Shaft Brackets Common configurations and forms of the cross section of shaft bossings are shown in Figs. 5.23 and 5.24. The symmetric form (a) is considered as the standard solution. Practical implementation are shown in Fig. 5.25.

The transverse symmetry axis of the bossing should be approximately perpendicular to the adjacent hull sections.

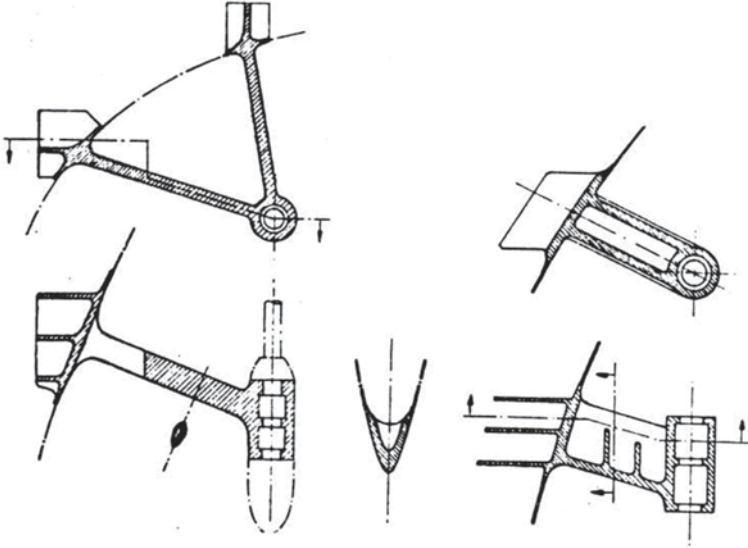

Fig. 5.25 Possible constructional solutions of shaft brackets of multi-screw ships

In the optimization of the arrangements of the stern sections and shaft axes/brackets of multi-screw ships, a smooth water flow *against* the direction of *propeller rotation* (*pre-whirling*) should be targeted. In this way, an exploitation of the induced angular momentum is aimed, so that the energy/resistance losses of the ship are mitigated.

Examples In earlier years of shipbuilding history, the long bossings with complete coverage of the shafts were preferred (see ocean liners ‘Bremen’ (1929), ‘Queen Mary’ (1936)). However, in recent times the short bossing with individual brackets and free axes prevail (see naval ships, contemporary passenger ships, container ships etc.). Most recent developments with the fitting of optimized twin skeg arrangements (practically leading back to longer bossings and eventually degenerating to stern bulbs) are notable.

D. Determination of Optimal Propeller The determination of the characteristics of propellers with optimum performance for a given ship and speed (assuming the ship’s resistance is known), is described in specialized literature (e.g. Lewis 1988, Politis and Lambrinidis 1993). In the lecture notes (Papanikolaou 2009, Vol.2) the author outlines the procedure for determining an optimal propeller of the Wageningen, B-series, assuming the propeller diameter pre-specified at maximum size ($D_p \approx 0.65\text{--}0.70 T$).

E. Contemporary Propulsive Means The explosive development of fast passenger ships and of propulsion technology in general over the past three decades has led to the introduction of a series of unconventional propulsion means with applications to various types of ships (in addition to passenger ships), such as (see, also, subsequent photo series, Figs. 5.26, 5.27 and 5.28) :

Fig. 5.26 Installation of waterjets on high-speed craft



Fig. 5.27 Installation of waterjets on high-speed craft. (concept originally proposed by the Italian inventor Secondo Campini in 1931; the first to apply it commercially was the New Zealand inventor Sir William Hamilton in 1954)

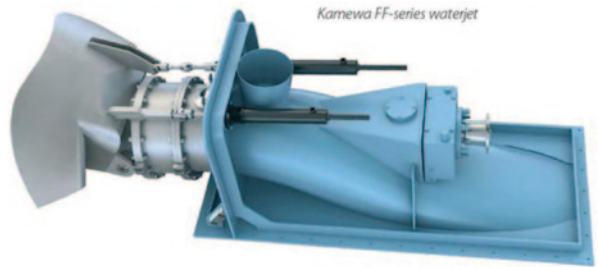
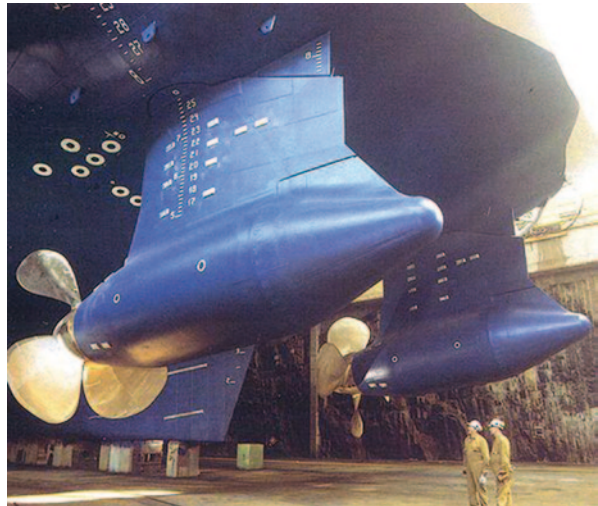

Fig. 5.28 Installation of azimuthal podded drives. The azimuth thruster using a Z-drive transmission was invented in 1950 by the German Joseph Becker, the founder of *Schottel* company. First applications came in the 1960s under the *Schottel* brand name and referred to as Rudder propeller ever since. Later, subsidiaries of ABB, also based in Finland, developed the *Azipod thruster*, with the electrically driven motor located in the pod itself. This kind of propulsion was actually first patented in 1955 by Pleuger, also from Germany.



1. Waterjets
2. Azimuthal podded drives
3. Voith–Schneider propeller system
4. Contra-rotating propellers on the same axis (co-axial)
5. Vane wheel system (patent of late Prof. Otto Grim⁷, Hamburg)

The above listed propulsion means (1–3) provide the ship, besides high-efficiency propulsion, significantly improved manoeuvring capabilities, so that there is no need to install a rudder for ship's safe operation. A comprehensive source of information on history and contemporary marine propellers and propulsion may be found in Carlton (2007; Figs. 5.29, 5.30, 5.31 and 5.32).



Fig. 5.29 Installation of Voith–Schneider propulsion system. The Voith–Schneider propeller was originally a design for a hydroelectric turbine. Its Austrian inventor, Ernst Schneider, worked with Voith's subsidiary in St. Pölten to further develop this concept to practical applications. It was found that Schneider's concept worked well as a pump, but, also, by changing the orientation of the vertical blades, it could function as an efficient propeller (first ship prototype in 1928)

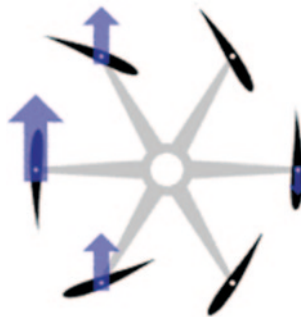

Fig. 5.30 Operational principle of Voith–Schneider Propeller

⁷ Grim Otto (1911–1994): Eminent Austrian professor of ship hydrodynamics and director of the Hamburg Ship Model Basin after WWII, with pioneering contributions to ship hydrodynamics, seakeeping, ship vibrations and ship propulsion; less known was his unique expertise and contributions to the structural design of submarines of the German navy during WWII.



Fig. 5.31 Installation of co-axial contra-rotating propellers (CRP). The history of CRPs goes back to 1836, when a patent was filed by *Ericsson* applying it to a 45-foot ship. In 1909 and 1939, the Italian and US navies applied CRP to small steam powered ships. Since then, CRP has been widely used for torpedo propulsion, for small vessels and of course for prop aircraft propulsion; however, mechanical difficulties in producing reliable CR shafting, for large propulsive power have hindered in the past wide application to large merchant ships.



Fig. 5.32 Installation of O. Grim's vane wheel. The *vane wheel* is a second propeller *downstream* of the main propeller, which runs *freely without torque on the shaft*. The *inner part* of the vane wheel, the *impeller or turbine part*, has a pitch such that the vane wheel is driven by the wake of the main propeller. The *outer part* of the blades of the vane wheel, the *propeller part*, has a different pitch, which causes the vane wheel to generate thrust of the main propeller. The concept was originally proposed and patented by the late Prof. Otto Grim (Hamburg) in the 1960s; it is also known as *Grim'sche Leitrad*. Vane wheels are subjected to strong fluctuations in loading and problems with the strength of the blades have been encountered frequently, which has led to limited applications in recent years, despite significant powering/fuel savings, when smoothly working.

5.3 Selection of Rudder

A. Overview A rudder, with area A_R gives the ship the turning/evolution moment (Figs. 5.33, 5.34, 5.35 and 5.36):

$$M_{ev} = C_{Ru} \cdot \frac{\rho}{2} V_{Ru}^2 \cdot A_R \cdot a = F_R \cdot a \tag{5.6}$$

where

- V_{Ru} Onset flow velocity to the rudder,
- $V_{Ru} < V_S$, for rudder outside the propeller flow
- $V_{Ru} > V_S$, for rudder abaft/within propeller flow
- C_{Ru} Rudder lift force coefficient dependent on the rudder foil form, the rudder profile (relationship to aspect ratio) and the incident angle of the water flow
- A_R Projected rudder area in the lateral plane
- a lever arm of application of the induced rudder force F_R with respect to the centre of mass of the ship,
- ρ density of water

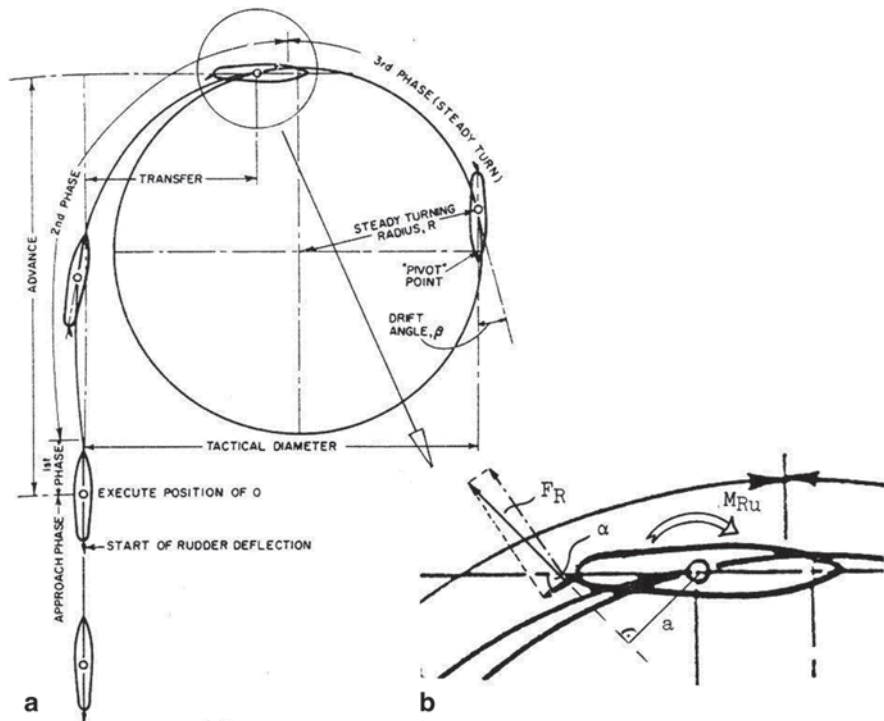

Fig. 5.33 a Turning course of a ship (Lewis 1988). b Effect of rudder, evolution moment M_{Ru}

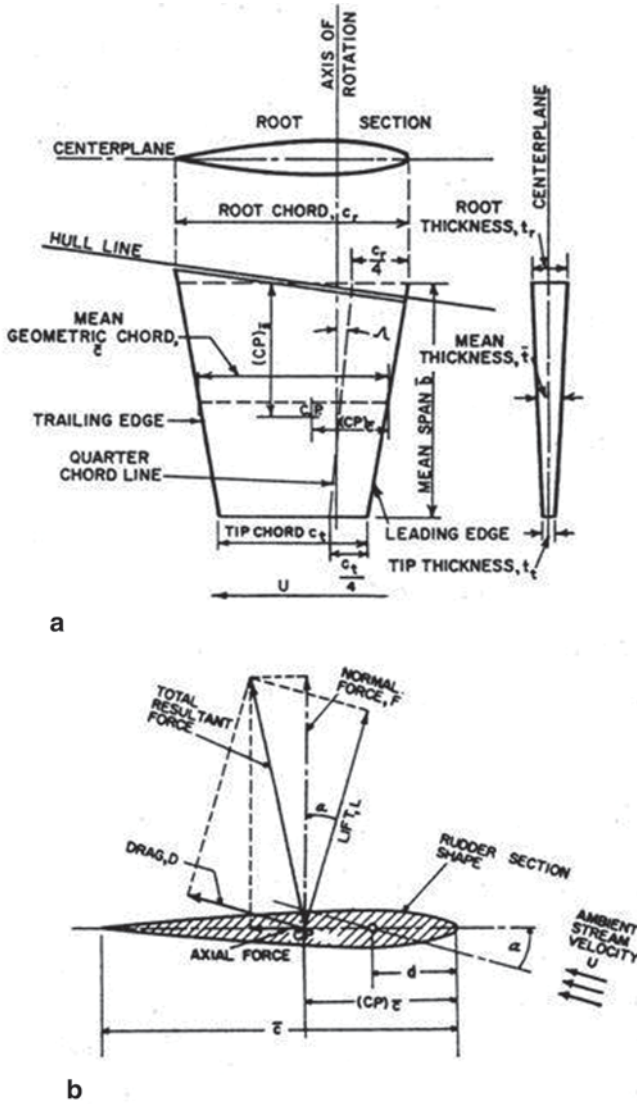

Fig. 5.34 a Typical dimensions of a rudder b Components of hydrodynamic rudder forces (Lewis 1988)

History The balanced rudder concept was first introduced by the ingenious British engineer *Isambard Kingdom Brunel* and used on the first ever built large iron ship, the SS *Great Britain*, launched in 1846 (Fig. 5.37). Its axis of rotation is behind its front edge. This means that when the rudder is turned, the hydrodynamic pressure acting upon the forward part of the rudder exerts a force which increases the angle of deflection, so counteracting the pressure acting on its rear part, which acts to

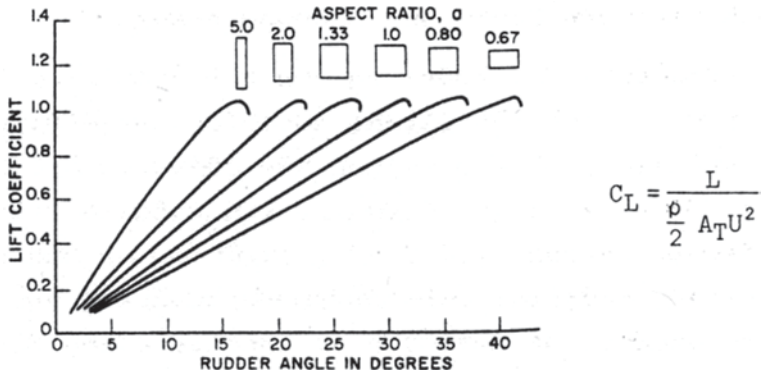

Fig. 5.35 Effect of aspect ratio on the lift coefficient C_L for various rudder angles α

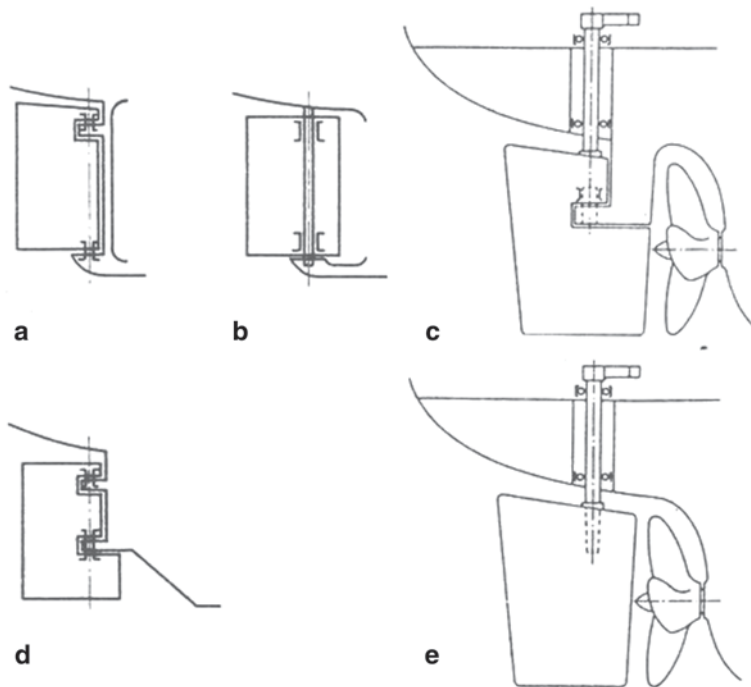

Fig. 5.36 Types of rudder. **a** Unbalanced rudder with upper and lower bearings. **b** Balanced rudder with bearings up and down. **c** Semi-balanced, half-hanging rudder with bearings (single screw). **d** Semi-balanced, half-hanging rudder for twin-screw ship. **e** Balanced, hanging rudder with upper bearing

Fig. 5.37 Rudder of SS
Great Britain



reduce the angle of deflection. To avoid rudder instability, the area in front of the pivot is less than that behind. This allows the rudder to be moved with less effort than is necessary with an unbalanced rudder.

B. Criteria for Selecting the Position and Rudder Number

Position of rudder: The fitting of the rudder behind the accelerated propeller flow generates for the ship larger steering forces, which reach values of double of the magnitude of the corresponding forces for rudders outside of the propeller flow. In addition, for low speeds, the flow abaft of the propeller induces satisfactory steering forces for the ship, as opposed to rudders outside of the propeller flow.

The hull efficiency η_H is positively affected by the fitting of the rudder in the wake of the propeller flow and it is for single-screw ships about 1.0 and larger, while for twin-screw ships it is usually less than one. Certainly, the effect of the rudder on the coefficients that are determining η_H , namely the wake and thrust reduction coefficient, is very complex. In any case, it is considered that the rudder regains part of angular momentum of the water flow released behind the propeller and induces additional thrust forces, thus eventually it is reducing the required power to achieve a specified speed (increase of η_D).

Number of rudders: The application of a single rudder in the centreplane of the ship is constructionally the simplest solution. In this way, only one rudder mechanism is required and its fitting to ship is also simplified. If ship's draft does not allow the installation of one rudder with adequately large area (e.g. shallow water riverboats), more than one rudders are installed.

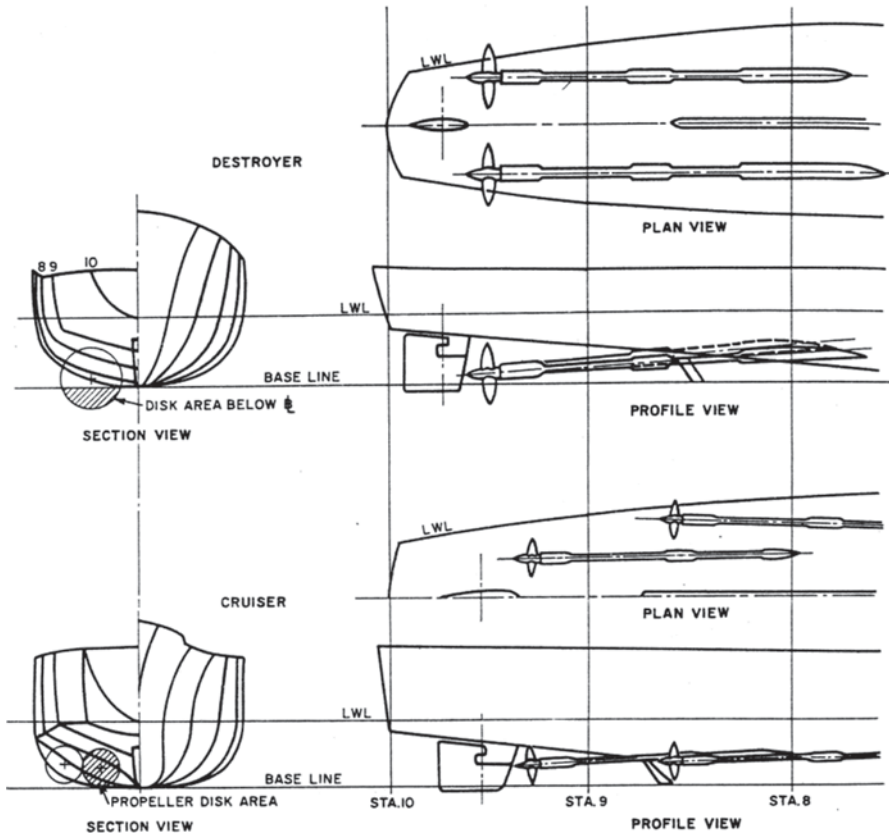

Fig. 5.38 Possible position of single rudder on multi-screw naval ships (Lewis 1988)

C. Applications

Single rudder behind a single propeller: It is the rule for practically all merchant ships. Attention should be paid to the pulling of the propeller end shaft for repairs, which should be not obstructed by the rudder (proves more problematic for CPPs and shafts).

Single rudder behind two (four) propellers: It may be found on past large passenger ships (ocean liners) and naval ships (see Fig. 5.38).

Two rudders behind two propellers: It is common to all ships with special requirements for easy manoeuvring, e.g. RoPax ferries, trawler-fishing vessels, river ships and naval ships.

The position of the axes (rudder stocks) of side rudders is often slightly inclined sideways, in the upper part. Also, lengthwise, the rudders are placed slightly outside the line of the propeller end shafts to facilitate their removal for repair.

Table 5.9 Typical values of rudder area coefficients for merchant ships according to Strohbusch (1971)

| Ship type | $C=L \cdot T/A_R$ |
|----------------------------------|-------------------|
| Cargo ships | 65–75 |
| Bulk carrier | 70–75 |
| Tankers | 60–80 |
| Short sea cargo ships | 30–50 |
| Reefers | 45–60 |
| Past ocean liner passenger ships | up to 85 |
| Large passenger ships | 55–70 |
| Car ferries/RoPax | 35–50 |
| Trawlers | 33–40 |
| Open sea tugs | 30–40 |

Two rudders behind three propellers: Sometimes applied to naval ships

Multiple rudders: Interconnected multi-rudder systems are applied to river ships (Henschke 1964).

D. Rudder Area Indicative values for the required rudder area A_R , in relation to the lateral plan projection of ship's wetted surface $\approx L \cdot T$, are given in Table 5.9:

E. Other and Alternative Rudder System Devices

- **Evolution of Stern Rudder:**

Kort nozzle rudder (a)

Pleuger active rudder (*propeller rudder*) (b)

Azimuthal podded drive (c) (Figs. 5.39, 5.40, 5.41 and 5.42)

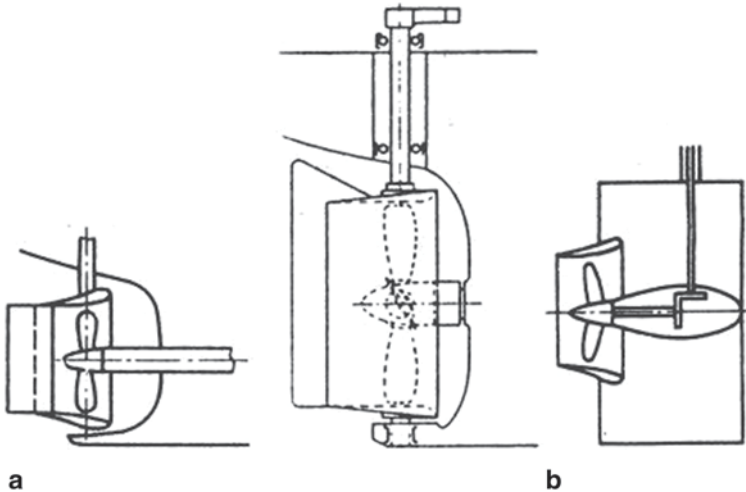

Fig. 5.39 a Kort nozzle rudder. b Pleuger active rudder

Fig. 5.40 *Kort* nozzle rudder



Fig. 5.41 *Pleuger* active rudder first fitted to *M/S Elisabeth Bowater* (1958)

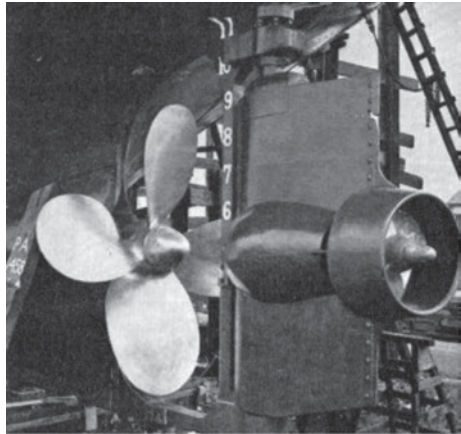

Fig. 5.42 Siemens–Schottel azimuth thrusters



Fig. 5.43 Bow thruster

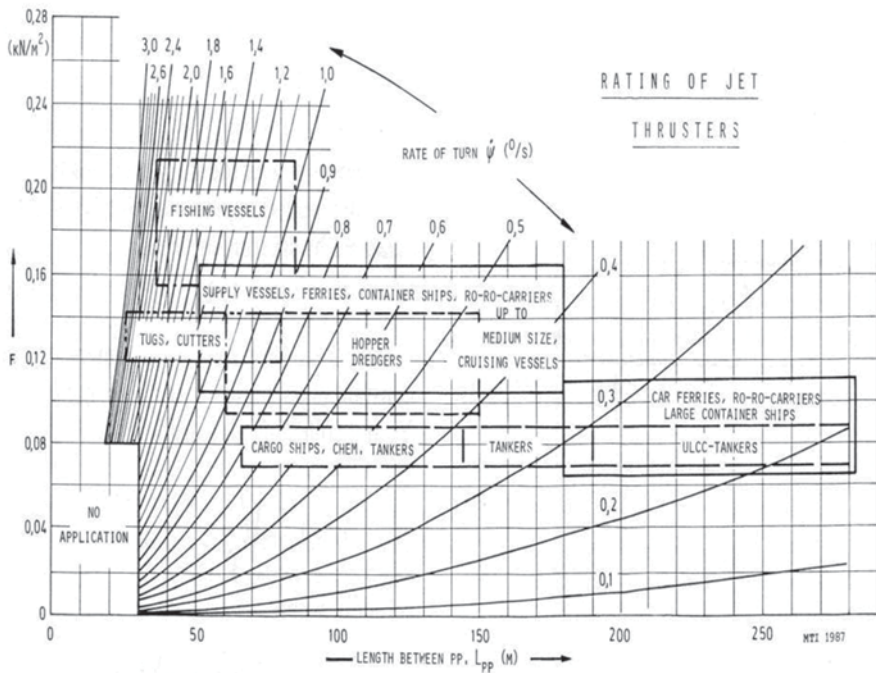
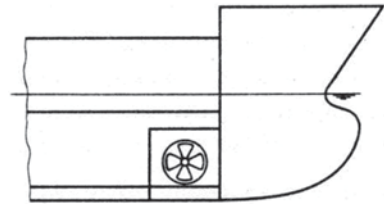

Fig. 5.44 Diagram for the selection of active bow thruster according to Brix (1993)

• **Bow Steering Devices:**

- Regular type bow rudder for ships with special manoeuvring requirements (car ferries and pilot boats).
- Active bow thrusters to facilitate manoeuvrability in limited waters, channels, ports etc. (car ferries, large passenger ships, large container ships etc.) (Figs. 5.43 and 5.44)

Lateral thrust: $Y_0 \text{ (kN)} = F \text{ (kN)} \cdot L_{pp} \cdot T$

Required power: $P_0 \text{ (kW)} = Y_0 / C_0$, where:

$C_0 \approx 0.150 \text{ kN/kW}$ (specific thrust coefficient for bow thruster; Fig. 5.45).

Fig. 5.45 Single and twin bow thrusters



The fitting of single and multiple *bow* thrusters is possible. For high manoeuvring performance ships (e.g. large passenger ships), the fitting of active *stern* side thrusters is also common, unless the ships are fitted with Azimuthal podded drives.

F. Manoeuvrability

- **General:** Good manoeuvrability disposes a ship with the following characteristics:
 - Small turning diameter (small ‘tactical diameter’)
 - Rapid turning
 - Rapid equilibration of forces in the fully developed turning circle
- **Requirements on manoeuvrability:**
 - Interim international standards for a ship’s manoeuvrability are laid down in IMO’s Resolution A.751, adopted on November 4, 1993; they refer to a set of criteria for a ship’s

Turning ability: The advance should not exceed 4.5 ship lengths and the tactical diameter should not exceed 5 ship lengths in the turning circle manoeuvre.

Initial turning ability: With the application of 10° rudder angle to port/starboard, the ship should not have travelled more than 2.5 ship lengths by the time the heading has changed by 10° from the original heading.

Yaw-checking and course-keeping ability: Control by conducted standard zig-zag tests

Stopping ability: The track reach in the full astern stopping should not exceed 15 ship lengths.

- For vessels with enhanced manoeuvring requirements, for instance, tugboats, a minimum turning tactical diameter is required, e.g. d_T/L up to $\cong 2.0$. The requirement for rapid turning is easily satisfied in practice due to their small size (small mass/inertia).
- For all common type merchant ships, ‘rapid turning’ is required for safety reasons against collision, which is controlled by the ship undergoing standardized zig-zag tests; for the turning tactical diameter we have mostly $d_T/L \cong 3.5 - 5.0$.

- **Effect of design parameters on manoeuvrability:**

- a. **Turning moment** (see Sect. 5.3, A): The turning moment can be increased by increasing the rudder area A_R and the placement of the rudder in the wake of the propeller flow (increase of V_{Ru}). In addition, the rudder should be positioned as sternward as possible (increase of the lever arm a).
- b. **Mass moment of inertia:** A ship’s mass moment of inertia can be reduced by reducing the weights and optimizing their distribution, though this is difficult in practice.
- c. **Hull form:** Sharp hull forms (large L/B) generally slow down the prompt turning. In particular, with respect to the lateral plan projection of the underwater hull surface, the fitting of a stern deadwood is enhancing the course-keeping ability of the ship, but adversely affects her turning ability. The same applies to vessels with stern trim. Generally, dominant V-type sections adversely affect the manoeuvrability of a vessel due to the relative increase of the projected underwater area.

G. Course Stability

- **General:** The course keeping ability/stability of a ship expresses ship’s capability to hold her course without continuous corrective actions by the rudder.
- **Requirements:** All ships should have adequate course keeping stability for the following reasons:
 - Reduced loading on the rudder bearings and driving mechanism,
 - Fuel saving,
 - Safe navigation in limited waters.
- **Effect of design parameters:**
 - a. **Mass and mass moment of inertia:** Generally, ships of large mass and large mass moment of inertia are difficult to be distracted from their course keeping, but also difficult to return to the original course, once deviating.

- b. Propeller flow:** The accelerated water flow due to the presence of the propeller generally stabilizes the course keeping of the ship, especially through the rudder that is located abaft, in the wake of the propeller.
- c. Hull form:** In general, those hull form characteristics that favour a ship's manoeuvring capabilities act adversely on her course-keeping ability. Thus, fine-lined, narrow ships (large L/B) favour the ship's course-keeping ability. Also, relatively sharp stern sections (of type V), with large draft close to the propeller and ending to a deadwood (like on upright keel on tugboats and fishing vessels), enhance a ship's course stability. Finally, a relatively large rudder (large area A_R) positively affects the constant course-keeping of the ship, in addition to the offered benefits of good manoeuvrability (Figs. 5.46, 5.47 and 5.48).

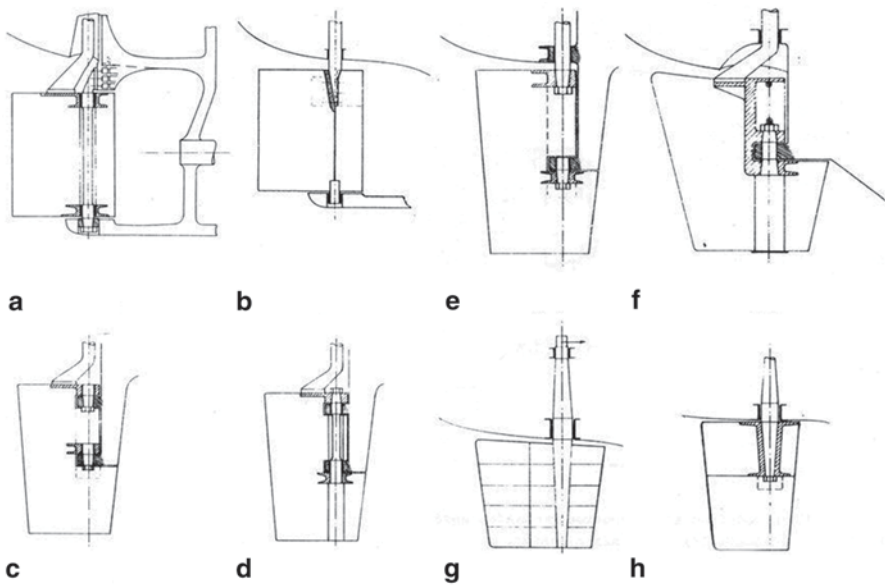

Fig. 5.46 Constructional examples of various types of rudders. **a** Old type balanced-rudder Simplex. **b** Similar to **a**, for small short sea ships. **c, d** Semi-balanced, half-hanging, new type Simplex. **e, f** Semi-balanced, half-hanging, new type. **g, h** Balanced/spade type, fully hanging, new type

Fig. 5.47 Example of bearing of fully hanging rudder by FAG-Kugelfischer (Schiff and Hafen 1986)

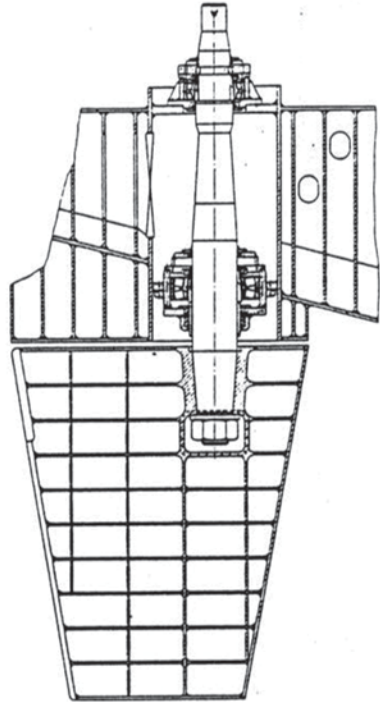
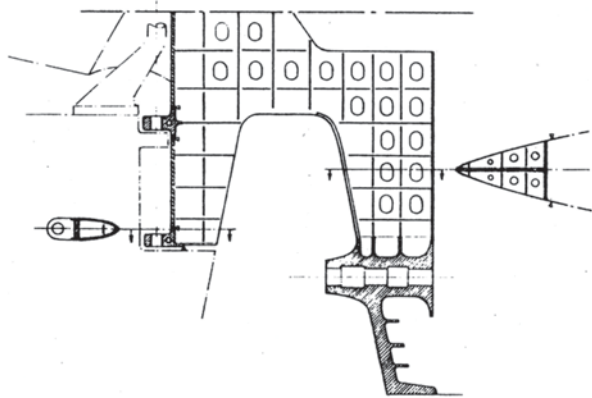

Fig. 5.48 Example of stern construction for semi-balanced, half-hanging rudder



References

- Brix J (1993) Manoeuvring technical manual. Seehafen, Hamburg
- Carlton J (2007) Marine propellers and propulsion, 2nd edn. Butterworth-Heinemann, Kidlington
- Dudszus A, Danckwardt E (1982) Schiffstechnik—Einführung und Grundbegriffe (in German). VEB Verlag Technik, Berlin
- Friis AM, Andersen P, Jensen JJ (2002) Ship design (Part I & II). Section of Maritime Engineering, Dept. of Mechanical Engineering, Technical University of Denmark, Kongens Lyngby. ISBN 87-89502-56-6
- Henschke W (1964) Schiffbautechnisches Handbuch (in German), vol II, VEB Verlag Technik, Berlin
- IMO MARPOL 73/78 (2013) Consolidated edition
- IMO MEPC 62/6/4 (2011) Consideration and adoption of amendments to mandatory instruments—Calculation of parameters for determination of EEDI reference values
- IMO MEPC 203(62) (2011) Amendments to the annex of the protocol of 1997 to amend the international convention for the prevention of pollution from ships, 1973, as modified by the protocol of 1978 relating thereto (Inclusion of Regulations On Energy Efficiency of Ships in MARPOL Annex IV), resolution adopted on 15th July 2011
- IMO MEPC 212(63) (2012) Guidelines on the method of calculation of the attained energy efficiency design index (EEDI) for new ships
- IMO MEPC 215(63) (2012) Guidelines for calculation of reference lines for use with the energy efficiency design index (EEDI)
- Journal Schiff & Hafen (1986) Seehafen Verlag, Hamburg
- Lewis EV (ed) (1988) Principles of naval architecture, vols. I–III. SNAME, Alexandria. Revision of the book: Comstock DP (ed) (1967) Principles of naval architecture. SNAME, New York
- Lloyd's Register (2012) Implementing the energy efficiency design index (EEDI)—Guidance for owners, operators, shipyards and tank test organizations
- Nikolopoulos L (2012) A holistic methodology for the optimization of tanker design and operation and its applications. Diploma thesis, Ship Design Laboratory, School of Naval Architecture & Marine Engineering, National Technical University of Athens
- Papanikolaou A (2009) Ship design—Methodologies of preliminary ship design (in Greek: Μελέτη Πλοίου—Μεθοδολογίες Προμελέτης Πλοίου), vol. 1, ISBN 978-960-9600-09-01 & vol. 2, ISBN 978-969-9400-11-4, October 2009. Symeon, Athens
- Papanikolaou A, Zaraphonitis G (1988) Computer applications in ship design. Hellenic Technical Chamber, Athens
- Politis G, Lambrinidis G (1993) Ship propulsion hydrodynamics (in Greek: Η Υδροδυναμική της Πρόωσης του Πλοίου). Asteros, Athens
- Scandinavian Airlines (SAS)(2012) SAS Traveller's Guide (www.flysas.com)
- Schneekluth H (1985) Ship design (in German). Koehler, Herford
- Strohbusch E (1971) Entwerfen von Schiffen I—IV. Lecture Notes (in German), Technical University, Berlin

Chapter 6

Estimation of Building Cost

Abstract This chapter deals with the estimation of ship's building cost for the needs of preliminary design, in which ship's main dimensions and other characteristics need to be determined, taking into account a given transport capacity and speed in accordance to the requirements of an interested ship owner. As the preliminary design procedure is inherently an optimization procedure of ship's main characteristics, we need to define first the optimization problem in hand and its relationship to the ship's building cost. We proceed then with an analysis of ship's building cost and present methods on how to estimate the main components of ship's building cost. The variability of the ship's building cost and volatility of ship market prices are highlighted.

6.1 Statement of the Optimization Problem

The present book elaborates the procedure of the preliminary design of ships, aiming at the proper selection of ship's main dimensions and of other ship parameters, which will meet the requirements and expectations of a concerned ship owner in an optimal way. These owner requirements specify, for the ship under consideration, the specific type, size, capacity, and speed (see statement of work/owner's requirements, section 1.3.5); and may be considered as *boundary conditions* of an optimization problem, without excluding their *irrational* formulation.

Essentially, the owner's requirements as to the transport capacity and speed of the ship under design and construction must be the *outcome* of a more global type optimization problem, which takes into account projected market conditions and tonnage capacity of the concerned owner from the supply side of available ships point of view (*supply and demand* of maritime transport determined by freight markets).

The present problem, namely, the optimization of the main dimensions and other ship parameters for a given transport capacity and speed in accordance to the requirements of an interested shipowner, corresponding to the *tender* of a shipyard to the concerned shipowner, has as main objective the "minimization of the building cost" or "minimization of acquisition cost" in the context of governing free market conditions.

The problem, however, from a shipowner's point of view, is more complex and goes even beyond the aforementioned exploitation of the total potential of available ships to the ship-owner (*optimization of fleet composition*). Even for a given

ship capacity and speed, the question of the appropriate dimensions and other ship parameters is associated to the “operating cost” of the ship, thus to the cost of fuel, crew costs, insurance cost, port charges and cargo handling cost, maintenance cost, and invested capital cost (interest rates, loan repayment schedule, etc.). Thus, the ship should be actually designed for *optimal economic performance* taking into account the *economic lifetime* of the ship (and the *time of investment depreciation*). More details in this general approach to the set techno-economic problem may be found in Buxton (1976), Schneekluth (1985), Benford (1991), and Stopford (2009).

It should be pointed out that the acquisition cost of a ship has substantial influence on ship’s profitability, since it constitutes the most significant payment of the ship-owner at the start of his investment. It has been shown by systematic studies (e.g., Schneekluth 1985), that optimizations of ship’s main dimensions with respect to:

1. the minimum building cost
2. the minimum annual operating cost
3. the maximum return on investment (ROI) or net present value (NPV)

lead to similar values for ship’s main dimensions regarding the criteria (1) and (3), that is, the main dimensions that are optimal from shipyard’s view (minimum building cost) eventually serve satisfactorily also the needs of the owner (maximum ROI or NPV, see Papanikolaou 1988). However, when optimizing only for a ship’s annual operating cost, the outcome differs and generally leads to ships with minimum fuel consumption¹.

For cargo ships (e.g., bulkcarriers and tankers), the optimization is more often conducted with respect to the transport cost for 1 t cargo (Fig. 6.1) or the required freight rate (RFR).

6.2 Building Cost Analysis

The building cost² of a ship is commonly analyzed according to the main building entities that make it up, thus the steel structure, the machinery, and outfitting (see 2.15.5, weight groups). Typical (indicative) values for the distribution of the building cost in various cost categories for a dry cargo ship are given in Table 6.1:

¹ Recent drastic increases of fuel cost have reinforced the importance of the *minimum operating cost* and *minimum fuel cost* criteria. This leads to more close results between the optimization solutions according to the above defined three criteria. Nevertheless, it is possible nowadays to conduct *holistic, multi-objective* optimizations with respect to a series of optimization criteria by use of genetic algorithms (see, Papanikolaou 2010).

² It should be noted that the *building cost* of a ship is not identical to the *acquisition cost* (*market price*) of the ship. For the estimation of the latter, in addition to the anticipated profit of the yard (if any), the market conditions (demand and supply) and freight rates must be taken into account. High freight rates, which occur in conditions of high transport demand, lead directly to high acquisition prices of ships. According to data of the renowned maritime research company Clarkson Research Services Limited (2008), the prices of tankers VLCC (320,000 DWT) have in-

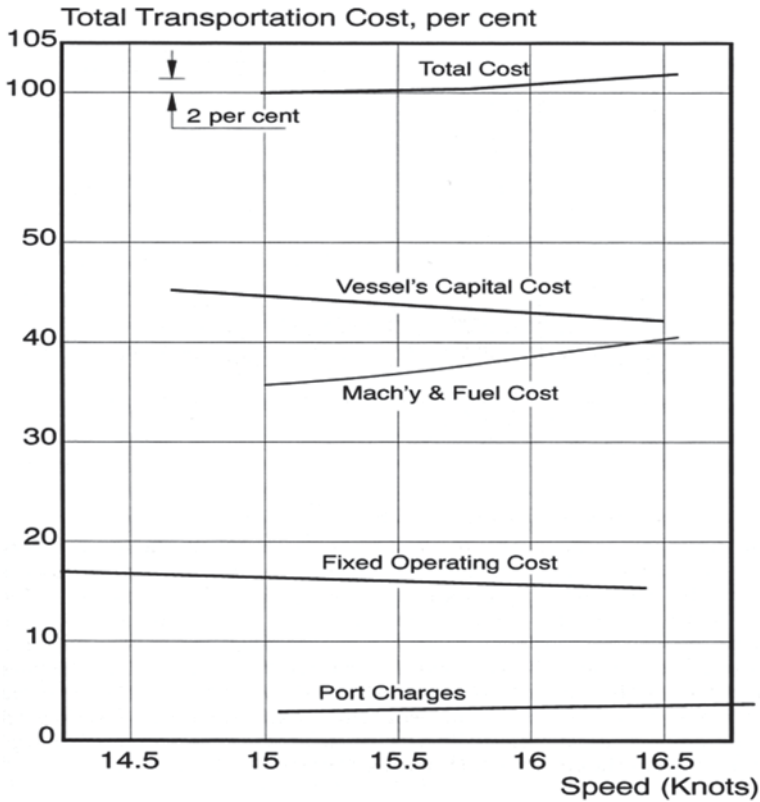

Fig. 6.1 Transport cost versus speed for large tankers. (Friis et al. 2002)

Table 6.1 Typical values for the distribution of the building cost for a dry cargo ship. (as % of total costs according to Schneekluth 1985)

| Weight group | Total building costs (%) |
|--|--------------------------|
| Steel structure (main hull) | 24–35 |
| Main engine | 8–13 |
| Other elements (superstructures, other machineries, accommodation, and equipment/outfitting) | 50–60 |

The above breakdown is obviously function of the ship type, the absolute dimensions of the ship, the manufacturer/shipyard, and the time of building. If the main

creased from US\$ 76.5 million in year 2000 to US\$ 146.0 million in 2008. For capsized bulkcarriers (180,000 DWT), the increase during the same period was from US\$ 40.5 million to US\$ 97.0 million. Similar increases were observed for all ship types and were associated to the dramatic increase of freight rates over the same period due to the high maritime transport demand in that period in the rapidly developing Far East countries (China and India). However, with the beginning of the world economic downturn at the end of 2008 and the collapse of the high freight rates, the prices for new buildings returned again to more rational levels.

engine is supplied by external manufacturers, as the great bulk of other equipment and outfitting, then approximately two-third of the building cost payments to the yard have to be transferred to external suppliers and merely about one-third remains for the costs of the yard (i.e., the *added value* of the shipyard).

Of the expenses of the shipyard for labor, about 17% refer to the design and management of the shipbuilding (payments of *white collars*) and 83% to the production process (payments of *blue collars*, according to data of German shipyard).

If during the preliminary design process the main objective is to achieve the “minimum building cost,” *then it is actually not required to accurately estimate all cost components*, i.e., the absolute building cost, *but only those cost components varying with ship’s main dimensions and parameters* affecting the specifications of the under design ship. These costs are:

1. **Cost of built/processed steel:** Assuming that in the preliminary design procedure, the extent of superstructures does not change, when varying ship’s main dimensions and other parameters, it is enough to accurately estimate the cost of the *steel structure of the main hull*.
2. **Cost of machinery/propulsion installation:** It is *not required to include* the cost of auxiliary machinery/fittings that *are not associated with the main engine* and are independent of the installed propulsion power.
3. **Cost of accommodation/equipment/outfitting:** It concerns *only the components varying with ship’s main dimensions* and other relevant ship parameters during the optimization.

6.3 Cost of Built/Processed Steel

The cost of the processed steel in the building of a ship can be grouped into two main categories:

- a. **Cost of unprocessed steel** (plates and stiffeners): This cost can be easily calculated based on the cost of required plates and stiffeners per ton.³ Note that it is necessary to include an increase of the estimated ship’s steel mass due to a wastage margin, depending on the type and size of the under construction ship, so as to better estimate the weight of the required steel, as it is ordered and paid by the yard to the steel supplier.

³ The cost of shipbuilding steel has increased drastically over the last years, in line with the high demand for ship new buildings until 2008 and before the commencement of the following global economic downturn. Thus, the cost of shipbuilding steel plates increased within 5 years from about US\$ 300/t (2003) to US\$ 1,000/t (first half of 2008), while the average construction cost has increased over the same period from about US\$ 850/t DWT (2003) to US\$ 1,500/t DWT (first half of 2008), according to the renowned maritime research group Clarkson Research Services Limited (2008). These increases are justified only by the high demand for new buildings, while there was no sufficient supply in terms of available shipbuilding shipyard capacity. However, with the start of the global economic downturn in 2008, the construction of new large shipyards and the increase of steel production in China, the prices returned to reasonable levels.

The estimated wastage arising during the construction of a full type ship, like a tanker or bulk carrier is in the order of 11–14%, for a general cargo ship 12–18%, while for more sophisticated, complex ships, for example, container-ships or RoPax, it reaches values of 16–20%. The above values are obviously a function of the following factors:

- Way of ordering steel plates (standard size or customized)
- Efficiency of cutting the plates by simpler or sophisticated cutting machines (minimization of wastage with optimal allocation of cutting pattern by computer (“nesting”), automated production systems supported by advanced hardware and software)
- Ship’s block coefficient (expresses the fullness of the hull, low C_B associated with extended uneven surfaces: high wastage)

b. Other costs: Here we understand mainly the staff costs and other general costs (overhead costs) of the yard. These costs are calculated based on the estimated/required working hours (man-hours) for the construction of the ship.

It is estimated that for a dry cargo ship or container ship, the required working hours per ton of steel structure is approximately 26–36 h/t (according to indicative data of H. Kerlen for German yards). Of course, this value depends on the productivity level of the yard and the difficulty of the particular ship’s construction.

It is considered that the effort in working hours to build 1 t of superstructure is about 30–40% higher than that for 1 t of the main hull. Roughly the same applies to the sections/blocks at the ends of ship in comparison with the sections in the middle.

Also, small ships are generally more laborious than the corresponding large ones. Thus, according to H. Kerlen (1981), the effort in man-hours resulting from an increase of the volume below the main deck from 20,000 to 70,000 m³ *decreases* by about 15% t⁻¹ of steel construction.

The cost of the steel structure (C_{ST}) of the main hull (without superstructure) can be calculated as follows:

$$C_{ST}[C] = K_{ST1}[C/t] \cdot W_{ST}[t] + K_{ST2}[C/h] \cdot MHS[h] \quad (6.1)$$

where

| | |
|-------------------------|---|
| C_{ST} [C] | Steel structure cost in currency units [C], e.g., in US\$, Euro, etc. |
| W_{ST} [t] | Weight of steel structure [t] |
| MHS [h] | Required working hours for steel structure |
| $W_{ST} K_{ST1}[C/t]^4$ | Cost of unprocessed steel per ton |
| $K_{ST2}[C/h]^5$ | Man-hour cost |

The above calculation method may be used by a yard on the basis of available cost and man-hour data typical to the yard in question (estimations of W_{ST} and MHS, K_{ST1} and K_{ST2}).

⁴ Typical values 2006: Greece ~650 €/t, China ~300 €/t

⁵ Typical values 2006: Greece ~35 €/h, China <5 €/h

Other, more simplified ways of calculating the cost C_{ST} are:

- Reducing the above relationship to a single cost value per ton of steel structure (very common approach)⁶:

$$C_{ST} = K_{ST1}[C/t] \cdot W_{ST}[t] \quad (6.2)$$

- Reducing it to a single cost value per man-hour of steel structure:

$$C_{ST} = K_{ST4}[C/h] \cdot MHS[h] \quad (6.3)$$

- Reducing it to cost values per square meter of *equivalent* plate area, i.e., $K_{ST5}[C/m^2]$. The latter equivalency is defined as the ratio between the total weight of the plates and the average weight of the plates per unit area.
- Reducing it to a cost value per meter of welding (see, practice of Japanese shipyards).

Approximation Formulas: H. Kerlen (cargo ships) Cost coefficient per ton of steel structure:

$$K_{ST}[C/t] = K_{ST0} \cdot \left(\frac{4}{\sqrt{3}L[m]} + \frac{3}{L[m]} + 0.2028 \right) \cdot \left(\frac{3}{2.58 + C_B^2} - 0.07 \frac{|0.65 - C_B|}{0.65} \right) \quad (6.4)$$

where

$K_{ST0} [C/t]$ Cost [C] per ton for a parental cargo ship ($L = 140$ m, $C_B = 0.65$).

Remarks

1. The above relationship, although initially proposed in the currency units of former West German ($C \equiv DEM \approx 0.5$ €), it can be implemented independently of cost units, if the unit cost of the parent ship (K_{ST0}) is known and appropriately adjusted.
2. According to **Kerlen** the relationship is valid for:

$$0.5 \leq C_B \leq 0.8 \quad \text{and} \quad 80\text{m} \leq L \leq 200\text{m}$$

Danckwardt's formula is as follows:

$$K_{ST}[C/t] = X \cdot W_{ST}^{-0.125} \quad (6.5)$$

⁶ Typical cost values of ton of steel structure (2006): Greece (Perama, small yards): $\sim 1,500$ €/t, (Large shipyards): $\sim 3,000$ €/t, China ~ 700 €/t

where

W_{ST} Weight of steel structure *without* wastage [t]

X Constant that is determined by the ship type and size, currency units, shipyard costs, etc.

Remark According to Danckwardt's formula, an increase of $W_{ST}=10,000$ t by 10% involves a *reduction* of K_{ST} by 1.2%.

For the sake of completeness, some relationships for the required man-hours that correspond to W_{ST} are listed. These relationships are of the general form:

$$MHS[h] = a \cdot (W_{ST})^b \quad (6.6)$$

where according to **Benford**:

| | |
|-----------|----------------------------|
| $a=243$ | $b=0.85$ for cargo ships |
| $a=175$ | $b=0.90$ for bulk-carriers |
| $a=141.2$ | $b=0.90$ for tankers |

Remarks

1. It is obvious that particularly the coefficient “a” greatly depends on the production level of the yard.
2. The above estimates of “a” and “b” of **Benford** refer to a typical large-scale American shipyard in the 60s decade; they have, of course, today little value in absolute terms; however, the general form of the relationship is valuable for qualitative studies.

6.4 Cost of Machinery and Propulsive Installation

The cost of the machinery and propulsive installation may be considered, to a major part, as directly associated to the propulsion power. Thus, if the cost per horsepower of the installed power is known, which obviously depends on the type of main engine and the manufacturer, the cost of this part of the propulsive installation is easily calculated by multiplying it with the required propulsive shaft horsepower (SHP):

$$C_M = K_M[C/SHP] \cdot P_S \text{ [HP]} \quad (6.7)$$

where

K_M Machinery/propulsive installation cost per installed horsepower

P_S Installed shaft horsepower [HP]

Certainly this estimation can be replaced by more accurate cost data for the main engine and likely of the gearbox (as applicable), according to quotation data of manufacturers, or their price catalog.

In this cost category, the additional costs for the propeller, bearings, shaft, exhaust ducts, control and supply systems of main engine, which correspond to 30–50% of the cost of main engine and gearbox, can be approximately included.

Other elements of the mechanical installation that are independent of the propulsion power, such as auxiliary machinery (electric generators), ballast systems (pipes, pumps), etc., can be considered as fixed costs with respect to the optimization of the main ship dimensions in the preliminary design of the ship.

Approximation Formulas (referring to the cost of the *complete* mechanical installation)

General Form

$$C_M = K_M [C/HP] \cdot P^\alpha, \quad (6.8)$$

where

$$\alpha = 0.5-0.7$$

Remark The K_M and α coefficients are function of the type of main engine (upper limit for α for diesel engines, lower limit of α for steam turbines), the position of the engine room and the size of the ship. Guideline values are given by H. Benford for diesel-engine and turbine-engine ships, however, they are outdated and of no essential value in absolute terms today.

6.5 Accommodation/Equipment/Outfitting Cost

In the framework of the optimization procedure of a ship, we need to identify what elements of ship's "Outfitting" vary with the main dimensions. It is clear that, depending on the type of the ship under design, certain elements can be regarded as either variable or fixed. Especially the following is noted:

1. The cost of the hatch covers for cargo ships, while it increases linearly proportional to the length of the cover, its increase with the width of the cover goes with the exponent 1.6. Thus, long and narrow covers are relatively cheaper than the beamier ones.
2. Certain equipment/outfitting items and their involved costs, such as the anchors, chains, ropes, etc., which depend on the *equipment index* of the ship, may change with the variation of the main dimensions, if the category of the equipment index of the classification society in charge of the ship changes.
3. Finally, other elements, such as electronic systems, etc., are to be considered fixed in the loops of a ship's preliminary design optimization.

Approximation Formula (referring to the cost of the complete accommodation/equipment/outfitting)

$$C_{OT} = (a_0 + a_1 W_{OT^1} + a_2 W_{OT^2} + a_3 W_{OT^3}) \cdot W_{OT} \quad (6.9)$$

W_{OT} Outfitting weight

a_0 to a_3 Factors depending on the specifications of the ship and the productivity level of the yard

The outfitting cost in the advanced design stages is estimated in detail based on manufacturers' catalogs and quotations of the suppliers of the yard.

References

- Benford H (1967) The practical application of economics to ship design. Journal Marine Technology. SNAME, New York
- Benford H (1991) A naval architect's guide to practical economics, Rep. No. 319, Dep. of Naval Arch. and Marine Eng., Univ. of Michigan
- Buxton IL (1976) Engineering economics and ship design, The British Ship Research Association (BSRA), 2nd edn.
- Clarkson Research Services Limited (2008) World shipyard monitor, report August 2008. Clarkson Research Services Limited, London
- Friis AM, Andersen P, Jensen JJ (2002) Ship design (Part I & II). Section of Maritime Engineering, Dept. of Mechanical Engineering, Technical University of Denmark, Denmark (ISBN 87-89502-56-6)
- Kerlen H (1981) On the influence of block coefficient on the cost of steel structure (in German), Dr. Dissertation, Tech. Hochschule Aachen
- Papanikolaou A (1988) Ship design. Handbook of ship design (in Greek: Μελέτη Πλοίου, Β' Τόμος, Εγχειρίδιο Μελέτης), vol 2. SYMON Publisher, Athens
- Papanikolaou A (2009) Ship design—methodologies of preliminary ship design (in Greek: Μελέτη Πλοίου—Μεθοδολογίες Προμελέτης Πλοίου), vol 1. SYMEON Publisher, Athens (ISBN 978-960-9600-09-01 & Vol. 2, ISBN 978-969-9400-11-4, October 2009)
- Papanikolaou A (2010) Holistic ship design optimization. Comput Aided Des 42(11):1028–1044
- Schneekluth H (1985) Entwerfen von Schiffen (in German), 3rd edn. KOEHLER Verlag, Herford
- Stopford M (2009) Maritime Economics, 3rd edn. Taylor & Francis Group, New York, ISBN 978-0-415-27557-6.

Appendix

Appendix A: Diagrams of Regression Analysis of Basic Design Values for Merchant Ships

Abstract: The present appendix A is a collection of design diagrams resulting from the statistical/regression analysis of the main dimensions of basic ship design quantities and pertain to various ship types. The main source of processed data is IHS Fairplay World Shipping Encyclopedia. The data processing was to a great extent conducted by diploma thesis students of the National Technical University of Athens and staff of the Ship Design Laboratory of NTUA.

Notes

1. Whenever an asterisk (*) is presented in the following diagrams, it means that:
 - The shown pink *outer* boundary curves represent the 95% *prediction interval*; thus, 95% of the statistical data are within this interval.
 - The shown pink *inside* boundary curves represent the statistical 95% *confidence interval* of the resulting regression formula.
2. A commonly used indicator of goodness of fit of shown regression formulas is the R-squared regression coefficient. Given regression formulas with R-squared less than about 0.60 should be used with great caution.

Bulk Carriers (Figs. A.1, A.2, A.3, A.4, A.5, A.6, A.7, A.8, A.9, A.10, A.11, A.12, A.13, A.14, A.15, A.16, A.17, A.18, A.19, A.20 and A.21)

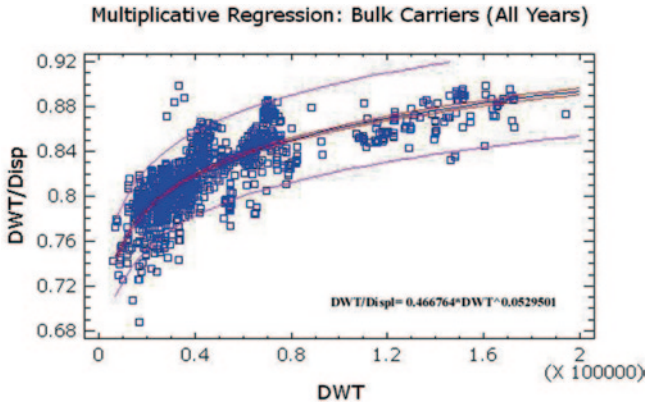

Fig. A.1 Regression analysis of ratio (DWT/Displacement) versus DWT [tons] for bulk carriers* (Kalokairinos et al. 2000–2005)

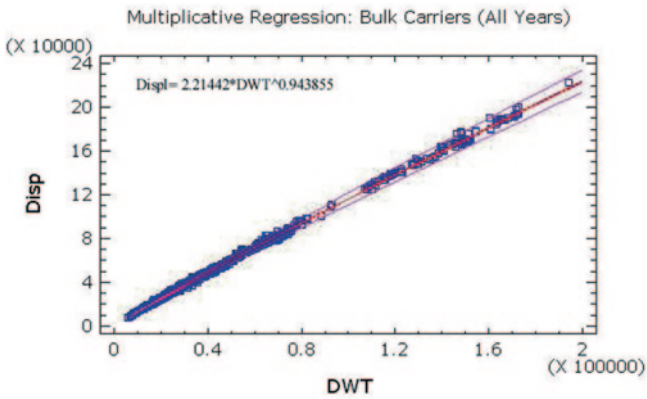

Fig. A.2 Regression analysis of displacement Δ [tons] versus DWT [tons] for bulk carriers* (Kalokairinos et al. 2000–2005)

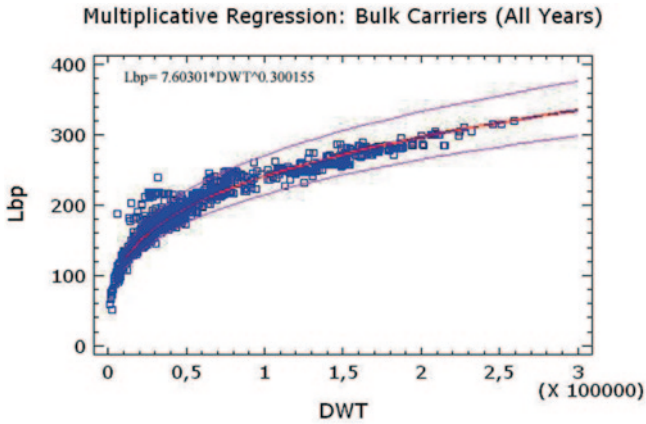

Fig. A.3 Regression analysis of length L_{BP} [m] versus DWT [tons] for bulk carriers* (Kalokairinos et al. 2000–2005)

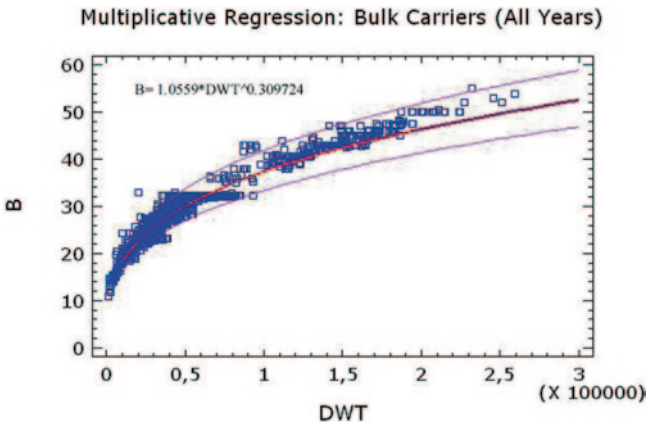

Fig. A.4 Regression analysis of beam B [m] versus DWT [tons] for bulk carriers* (Kalokairinos et al. 2000–2005)

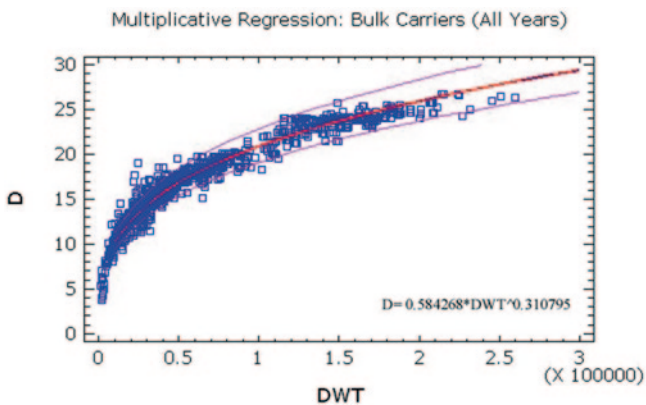

Fig. A.5 Regression analysis of side depth D [m] versus DWT [tons] for bulk carriers* (Kalokairinos et al. 2000–2005)

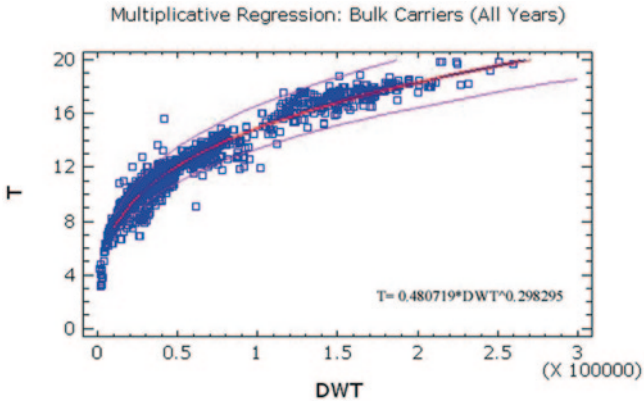

Fig. A.6 Regression analysis of draft T [m] versus DWT [tons] for bulk carriers* (Kalokairinos et al. 2000–2005)

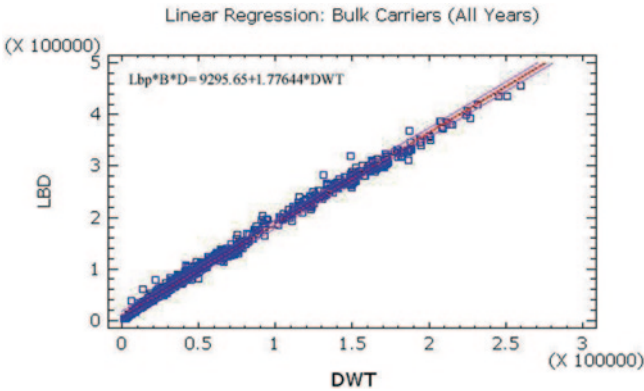

Fig. A.7 Regression analysis of the product $(L \times B \times D)$ [m³] versus DWT [tons] for bulk carriers* (Kalokairinos et al. 2000–2005)

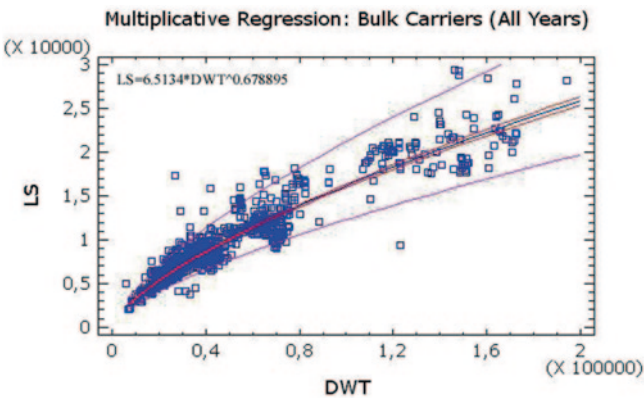

Fig. A.8 Regression analysis of lightship-weight (LS) [tons] versus DWT [tons] for bulk carriers* (Kalokairinos et al. 2000–2005)

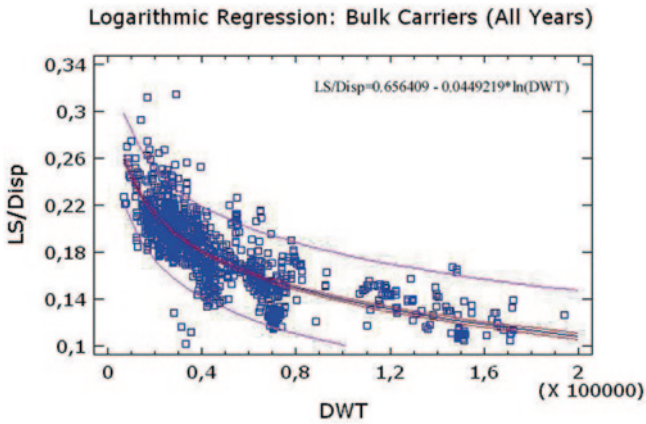

Fig. A.9 Regression analysis of ratio (LS/l) versus DWT [tons] for bulk carriers* (Kalokairinos et al. 2000–2005)

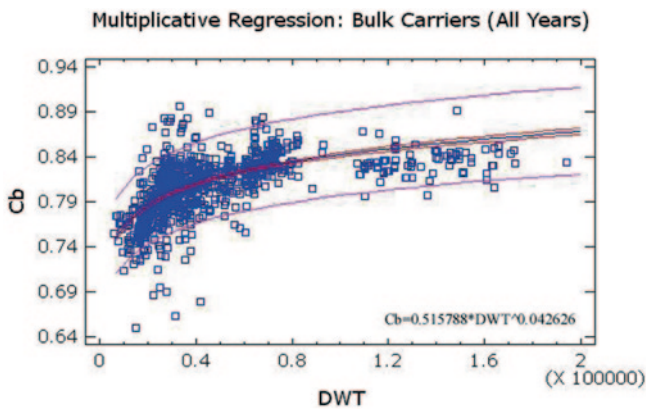

Fig. A.10 Regression analysis of block coefficient C_b versus DWT [tons] for bulk carriers* (Kalokairinos et al. 2000–2005)

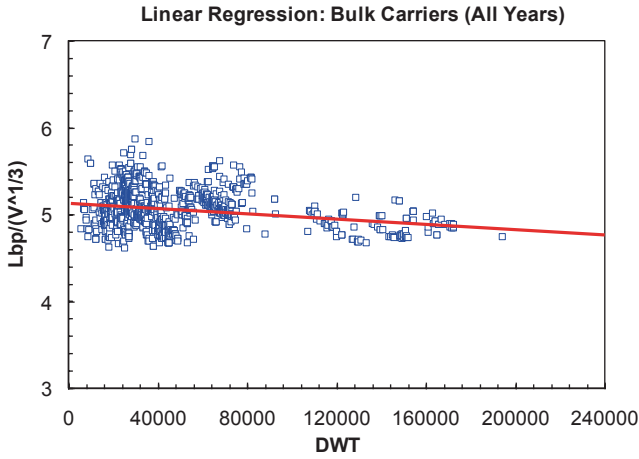

Fig. A.11 Regression analysis of slenderness ratio ($L/\nabla^{1/3}$) versus DWT [tons] for bulk carriers (Kalokairinos et al. 2000–2005)

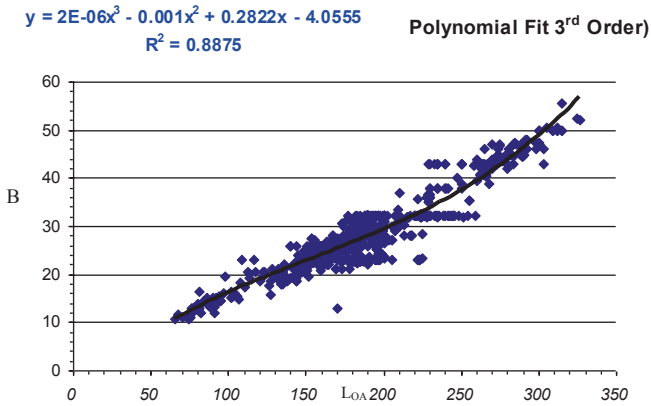

Fig. A.12 Regression analysis of B versus the L_{OA} for bulk carriers (Kalokairinos et al. 2000–2005)

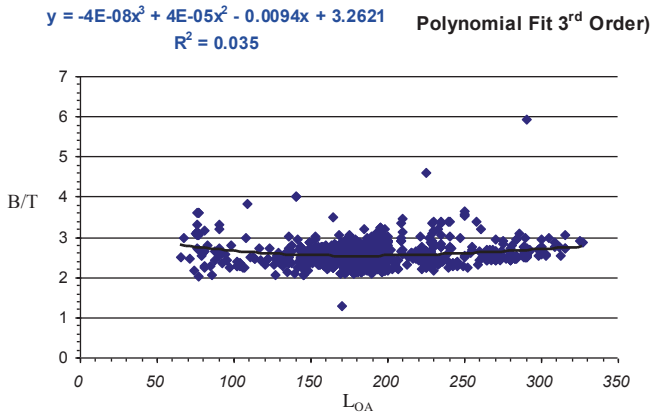

Fig. A.13 Regression analysis of the B/T versus the L_{OA} for bulk carriers (Kalokairinos et al. 2000–2005)

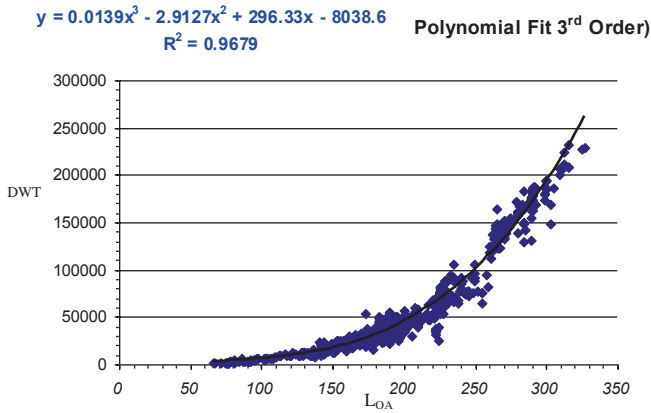

Fig. A.14 Regression analysis of the DWT versus the L_{OA} for bulk carriers (Kalokairinos et al. 2000–2005)

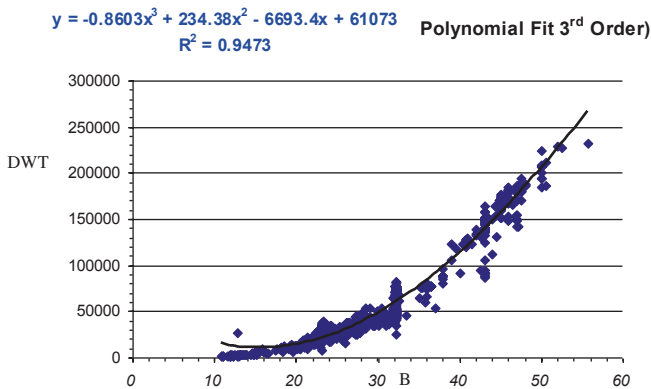

Fig. A.15 Regression analysis of the DWT versus the beam B for bulk carriers (Kalokairinos et al. 2000–2005)

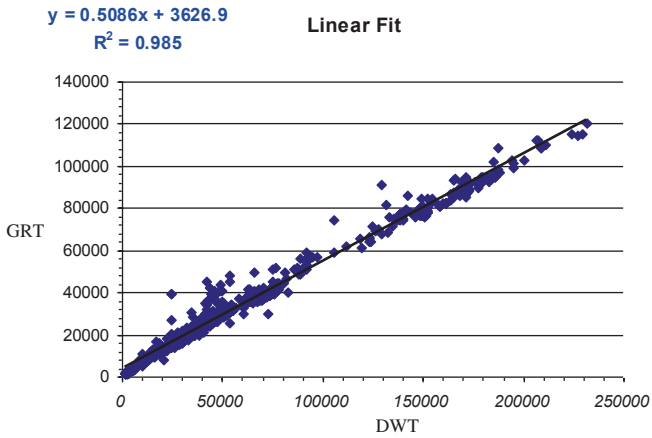

Fig. A.16 Regression analysis of the GRT versus the DWT for bulk carriers (Kalokairinos et al. 2000–2005)

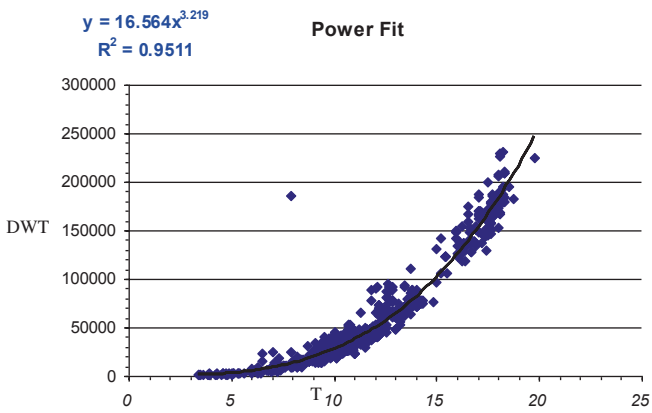

Fig. A.17 Regression analysis of the DWT versus the draft T for bulk carriers (Kalokairinos et al. 2000–2005)

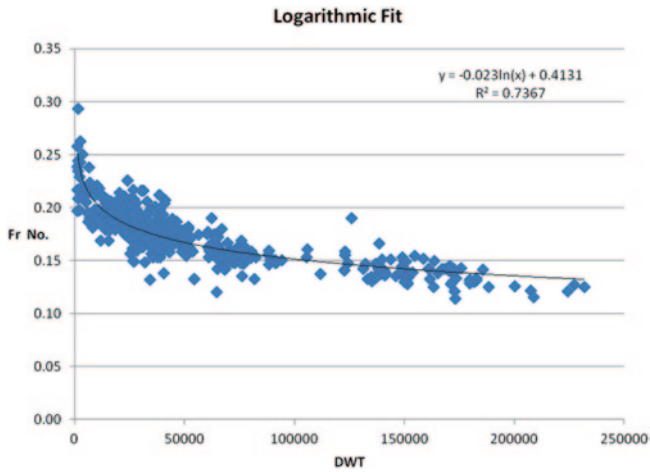

Fig. A.18 Regression analysis of the Froude No. versus the DWT for bulk carriers (Kalokairinos et al. 2000–2005)

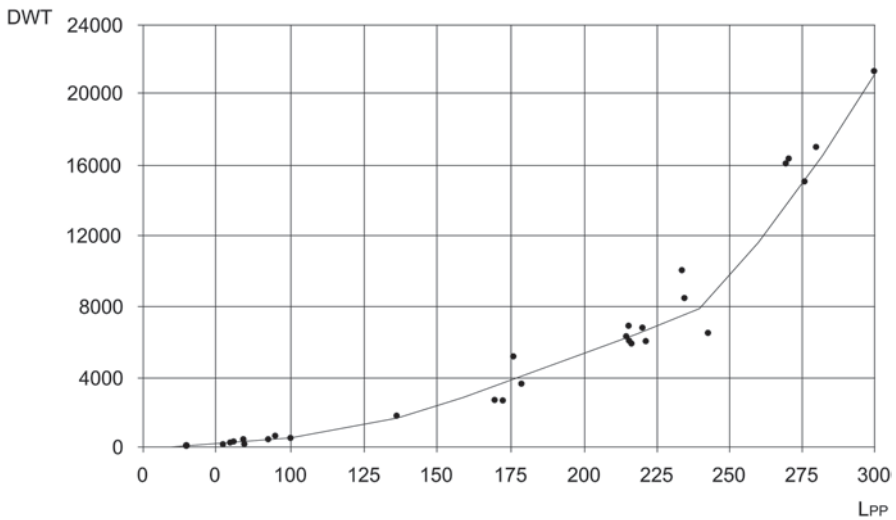

Fig. A.19 Regression analysis of the DWT [tons] versus the length L [m] for bulk carries according to Kristensen (2000) in Friis et al. (2002)

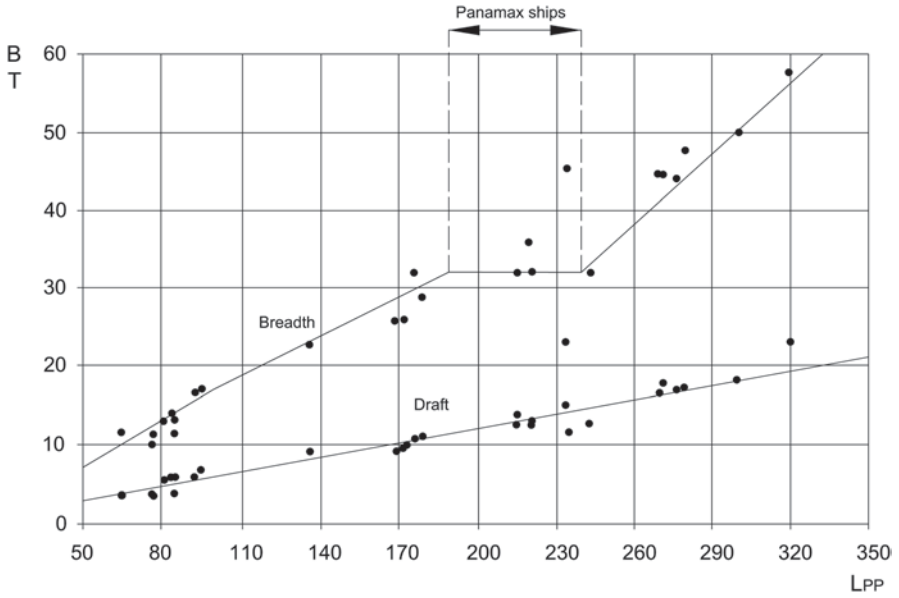

Fig. A.20 Regression analysis of the beam B [m] and the draft T [m] versus the length L [m] for bulk carries according to Kristensen (2000) in Friis et al. (2002)

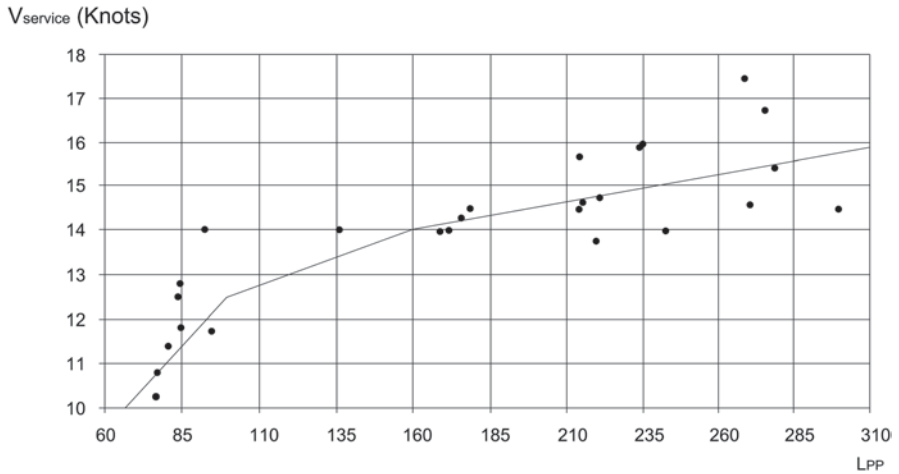

Fig. A.21 Regression analysis of the service speed V_s [knots] versus the length L [m] for bulk carries according to Kristensen (2000) in Friis et al. (2002)

OBO Carriers (Figs. A.22, A.23, A.24, A.25, A.26, A.27 and A.28)

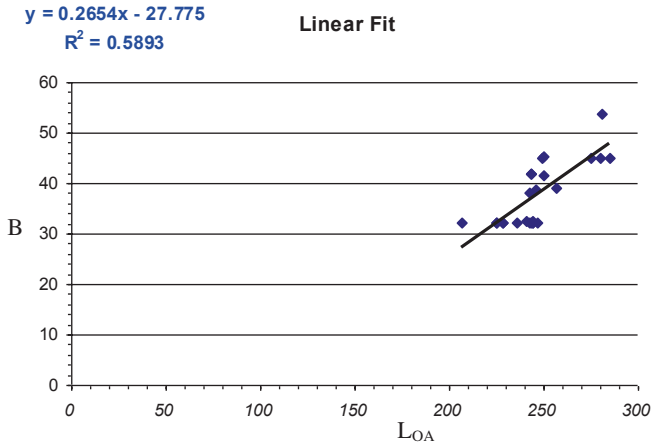

Fig. A.22 Regression analysis of beam B [m] versus length L_{OA} [m] for OBO carriers (Kalokairinos et al. 2000–2005)

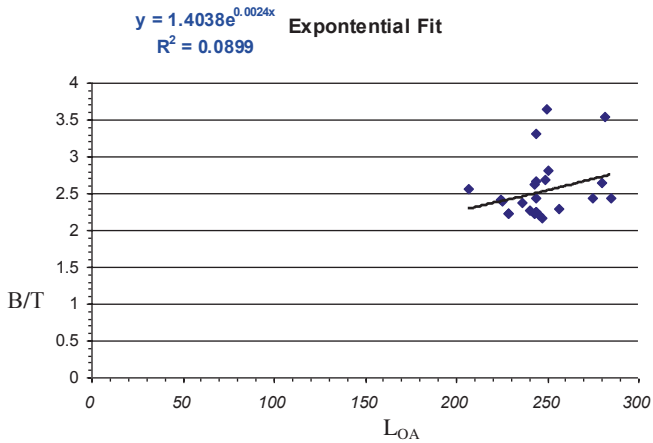

Fig. A.23 Regression analysis of ratio B/T versus length L_{OA} [m] for OBO carriers (Kalokairinos et al. 2000–2005)

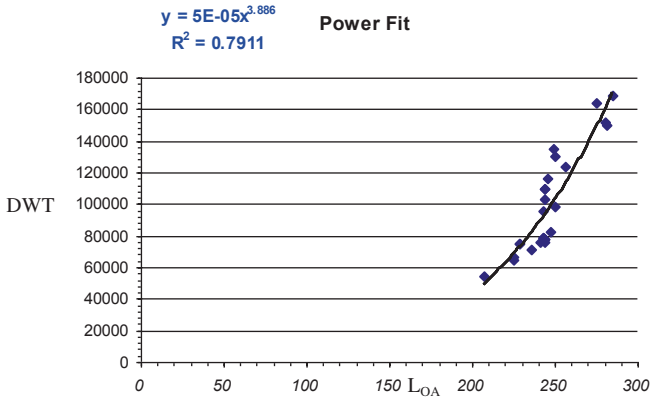

Fig. A.24 Regression analysis of the DWT [tons] versus length L_{OA} [m] for OBO carriers (Kalokairinos et al. 2000–2005)

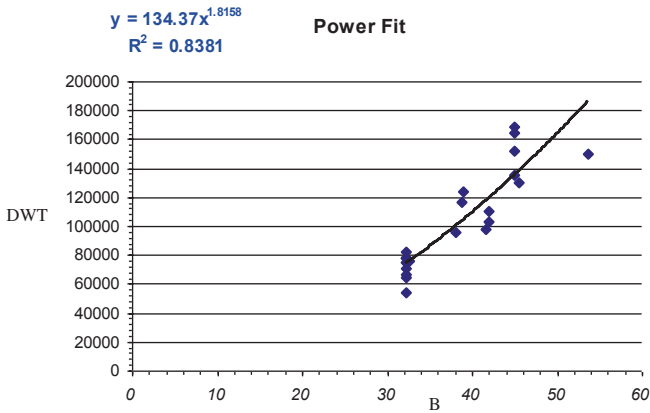

Fig. A.25 Regression analysis of DWT [tons] versus beam B [m] for OBO carriers (Kalokairinos et al. 2000–2005)

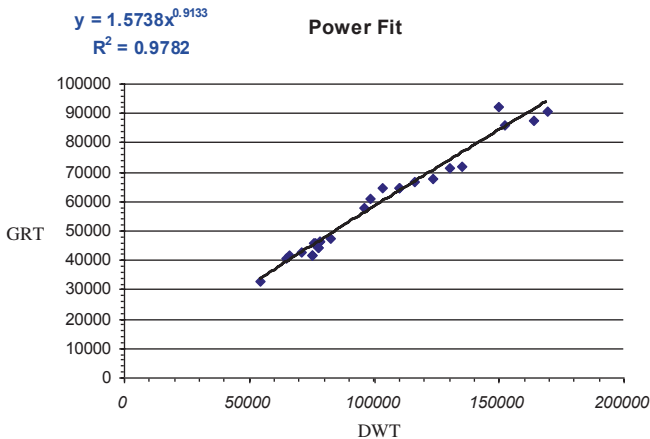

Fig. A.26 Regression analysis of GRT [RT] versus DWT [tons] for OBO carriers (Kalokairinos et al. 2000–2005)

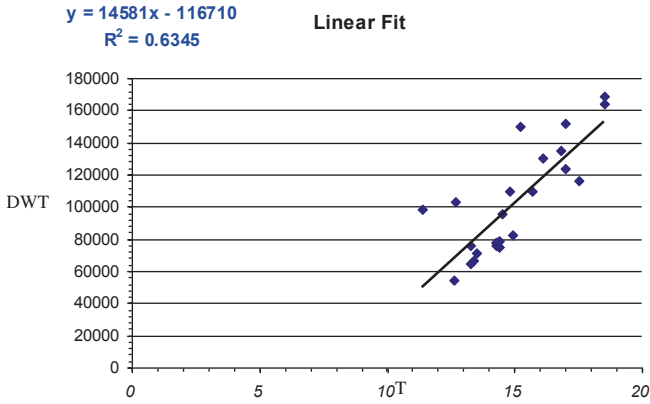

Fig. A.27 Regression analysis of DWT [tons] versus draft T [m] for OBO carriers (Kalokairinos et al. 2000–2005)

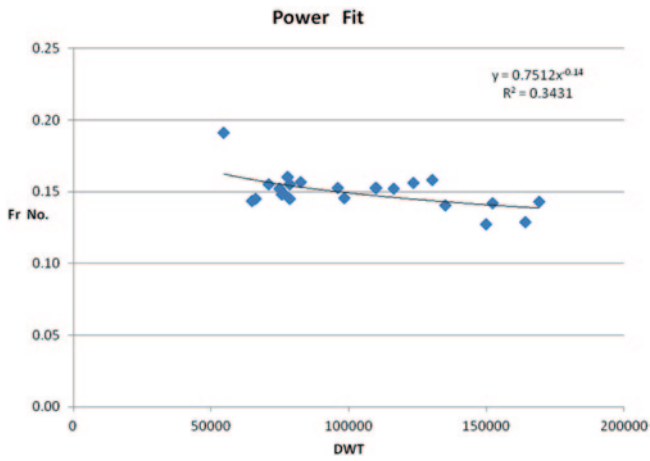

Fig. A.28 Regression analysis of the Froude No. versus DWT [tons] for OBO carriers (Kalokairinos et al. 2000–2005)

Containerships (Figs. A.29, A.30, A.31, A.32, A.33, A.34, A.35, A.36, A.37, A.38, A.39, A.40, A.41, A.42, A.43, A.44, A.45, A.46, A.47, A.48, A.49 and A.50)

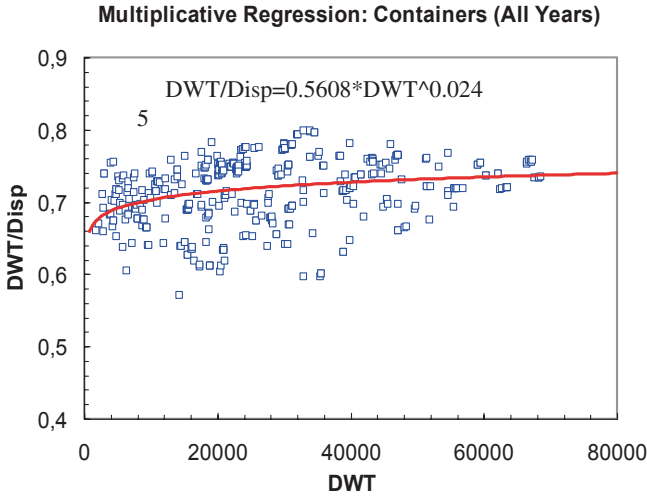

Fig. A.29 Regression analysis of ratio (DWT/ Δ) versus DWT [tons] for containerships (Kalokairinos et al. 2000–2005)

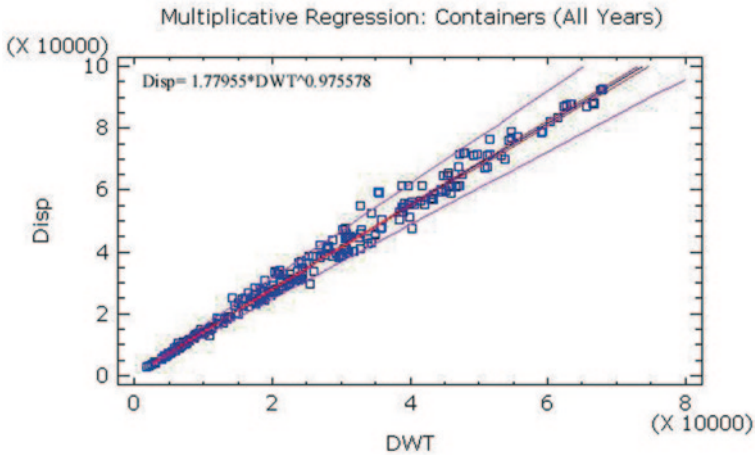

Fig. A.30 Regression analysis of displacement Δ [tons] versus DWT [tons] for containerships* (Kalokairinos et al. 2000–2005)

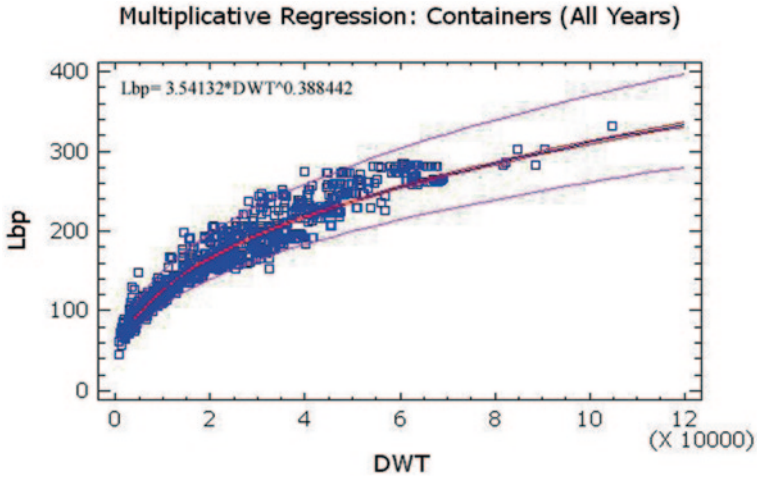

Fig. A.31 Regression analysis of length L_{BP} [m] versus DWT [tons] for containerships* (Kalokairinos et al. 2000–2005)

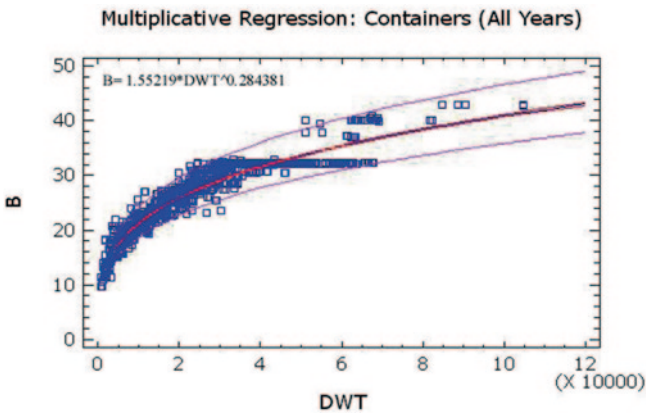

Fig. A.32 Regression analysis of beam B [m] versus DWT [tons] for containerships* (Kalokairinos et al. 2000–2005)

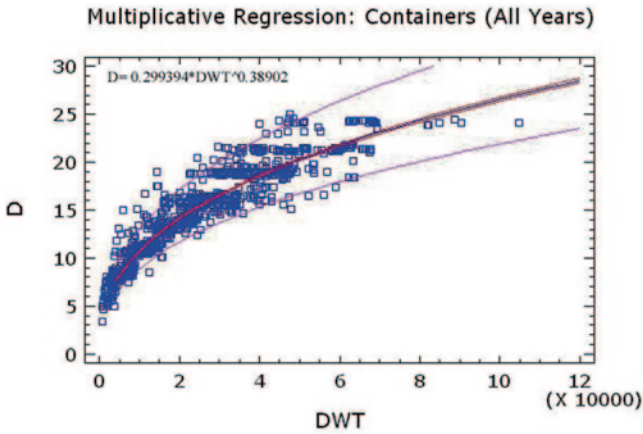

Fig. A.33 Regression analysis of side depth D [m] versus DWT [tons] for containerships* (Kalokairinos et al. 2000–2005)

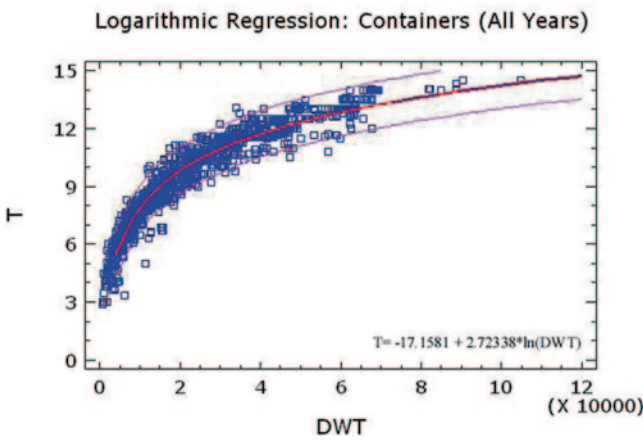

Fig. A.34 Regression analysis of draft T [m] versus DWT [tons] for containerships* (Kalokairinos et al. 2000–2005)

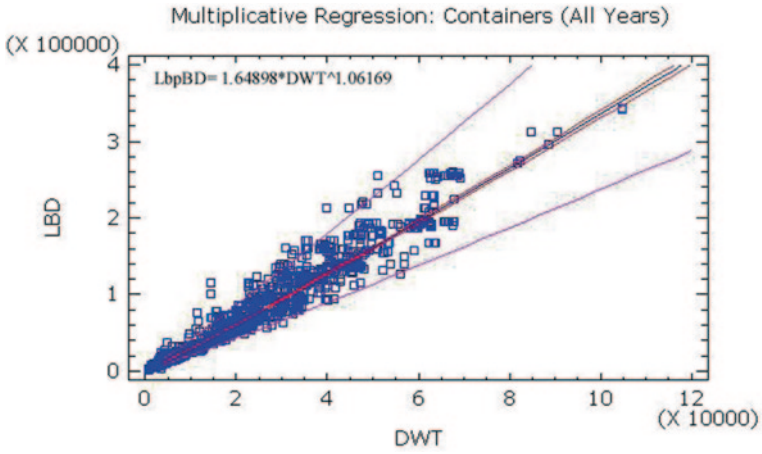

Fig. A.35 Regression analysis of volumetric product ($L \times B \times D$) [m^3] versus DWT [tons] for containerships* (Kalokairinos et al. 2000–2005)

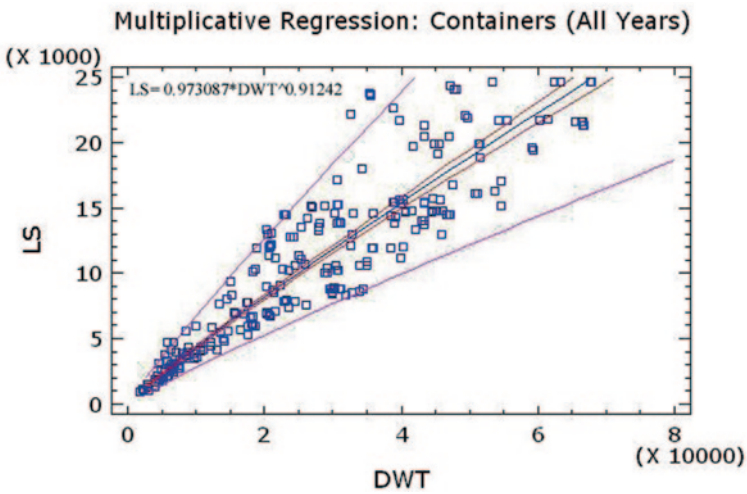

Fig. A.36 Regression analysis of lightship LS [tons] versus DWT [tons] for containerships* (Kalokairinos et al. 2000–2005)

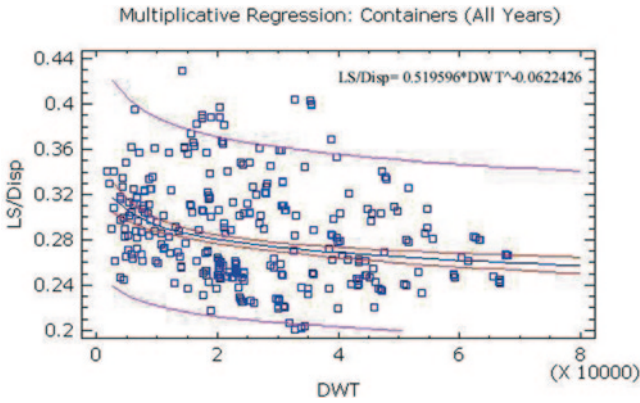

Fig. A.37 Regression analysis of ratio (LS/L) versus DWT [tons] for containerships* (Kalokairinos et al. 2000–2005)

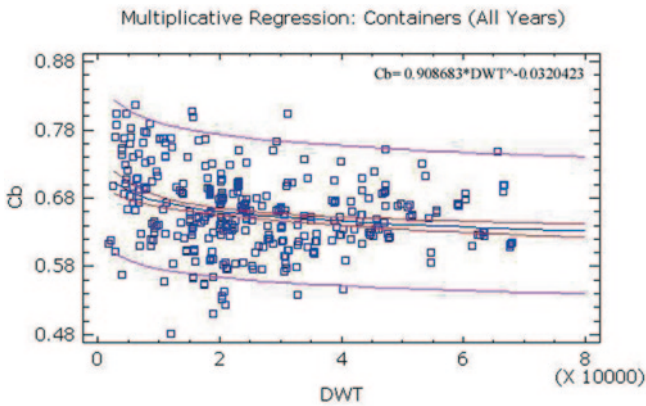

Fig. A.38 Regression analysis of block coefficient C_B versus DWT [tons] for containerships* (Kalokairinos et al. 2000–2005)

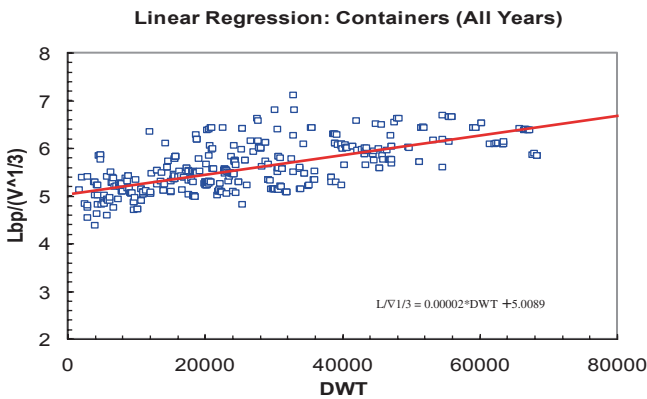

Fig. A.39 Regression analysis of slenderness ratio ($L/V^{1/3}$) versus DWT [tons] for containerships (Kalokairinos et al. 2000–2005)

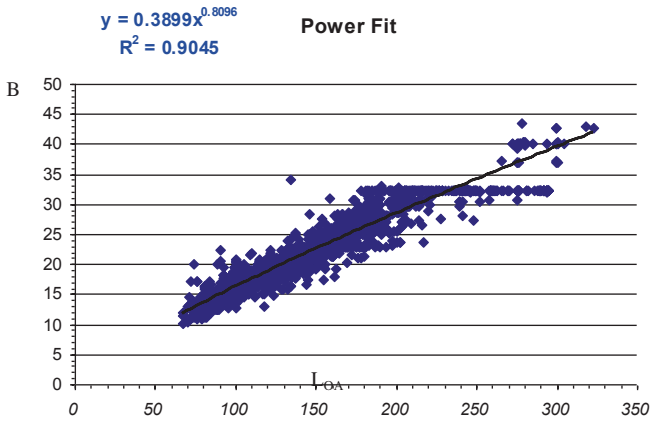

Fig. A.40 Regression analysis of beam B [m] versus L_{OA} [m] for containerships (Kalokairinos et al. 2000–2005)

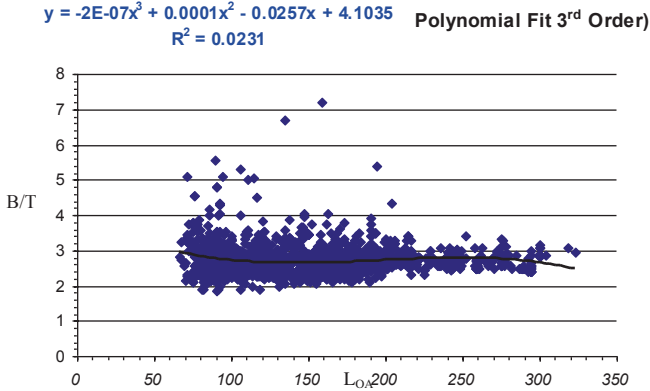

Fig. A.41 Regression analysis of ratio B/T versus L_{OA} [m] for containerships (Kalokairinos et al. 2000–2005)

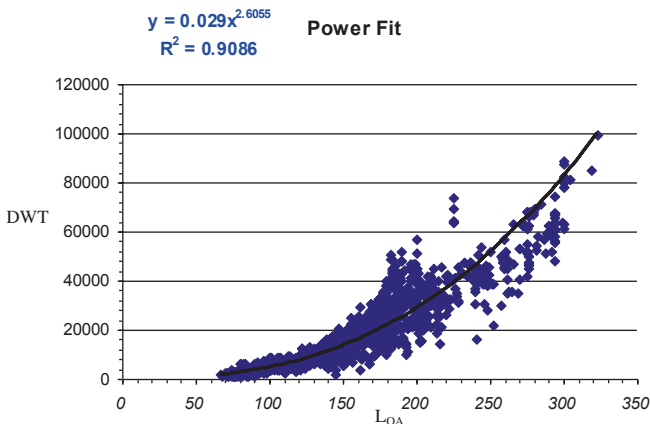

Fig. A.42 Regression analysis of DWT [tons] versus L_{OA} [m] for containerships (Kalokairinos et al. 2000–2005)

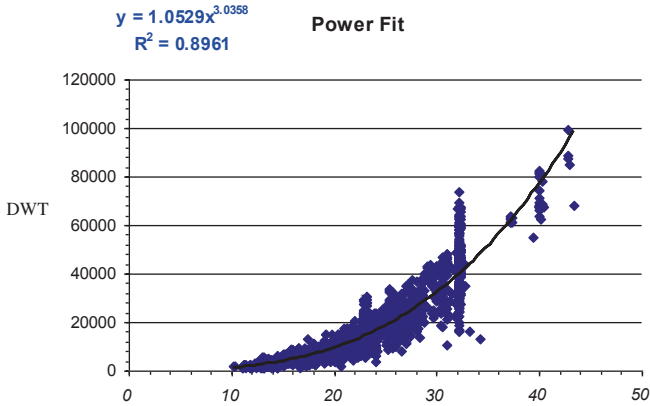

Fig. A.43 Regression analysis of DWT [tons] versus beam B [m] for containerships (Kalokairinos et al. 2000–2005)

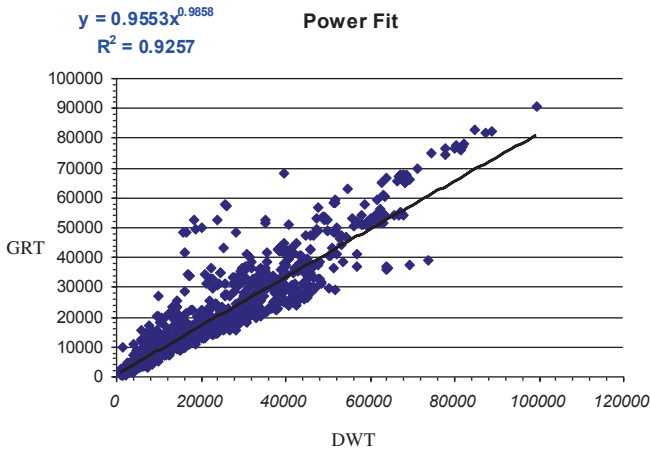

Fig. A.44 Regression analysis of GRT [RT] versus DWT [tons] for containerships (Kalokairinos et al. 2000–2005)

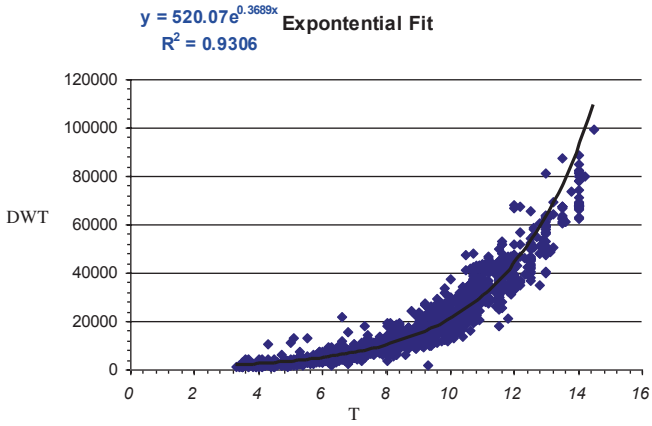

Fig. A.45 Regression analysis of DWT [tons] versus draft T [m] for containerships (Kalokairinos et al. 2000–2005)

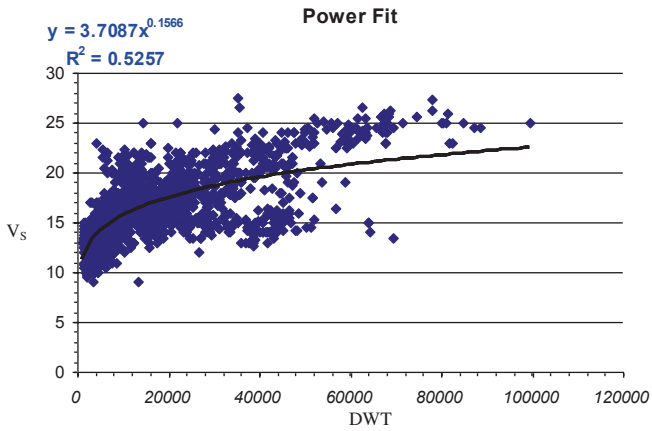

Fig. A.46 Regression analysis of the speed V [knots] versus DWT [tons] for containerships (Kalokairinos et al. 2000–2005)

No. of containers (TEU)

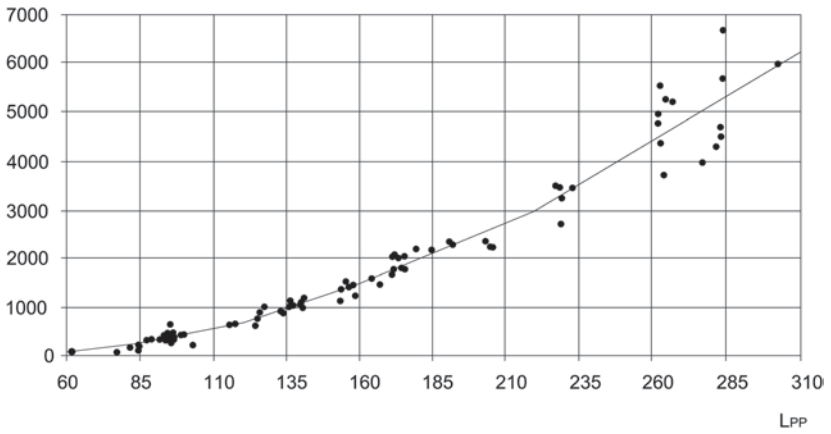

Fig. A.47 Regression analysis of the number of containers versus the length L [m] for container-ships according to Kristensen (2000) in Friis et al. (2002)

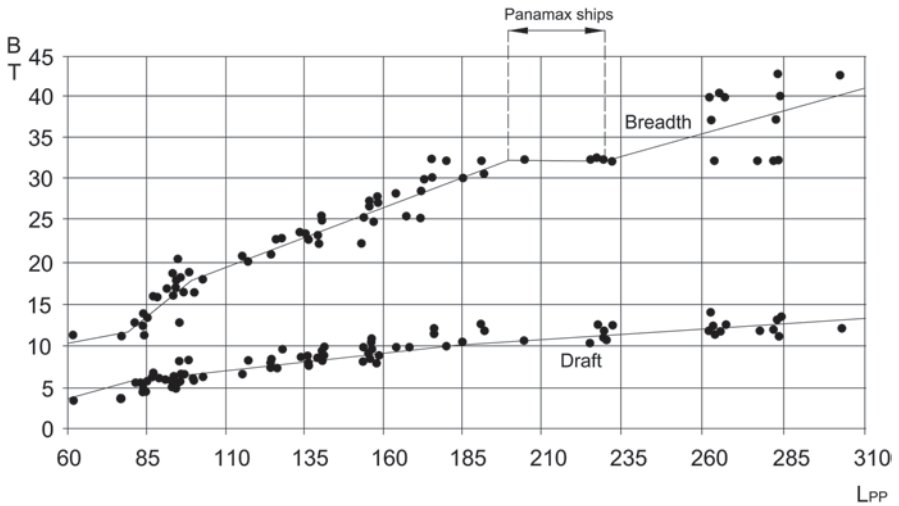

Fig. A.48 Regression analysis of the beam B [m] and the draft T [m] versus the length L [m] for container-ships according to Kristensen (2000) in Friis et al. (2002)

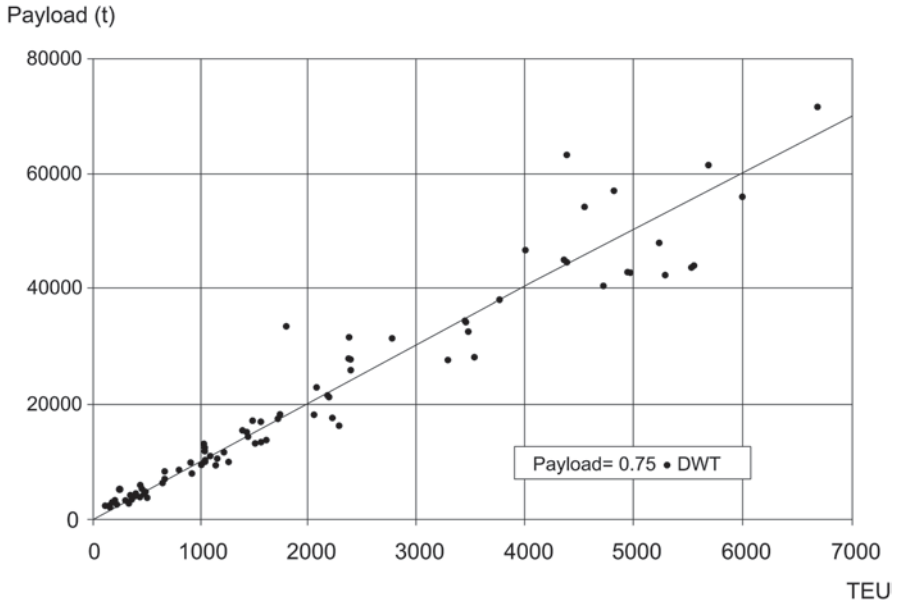

Fig. A.49 Regression analysis of the payload [tons] versus the number of containers for container-ships according to Kristensen (2000) in Friis et al. (2002)

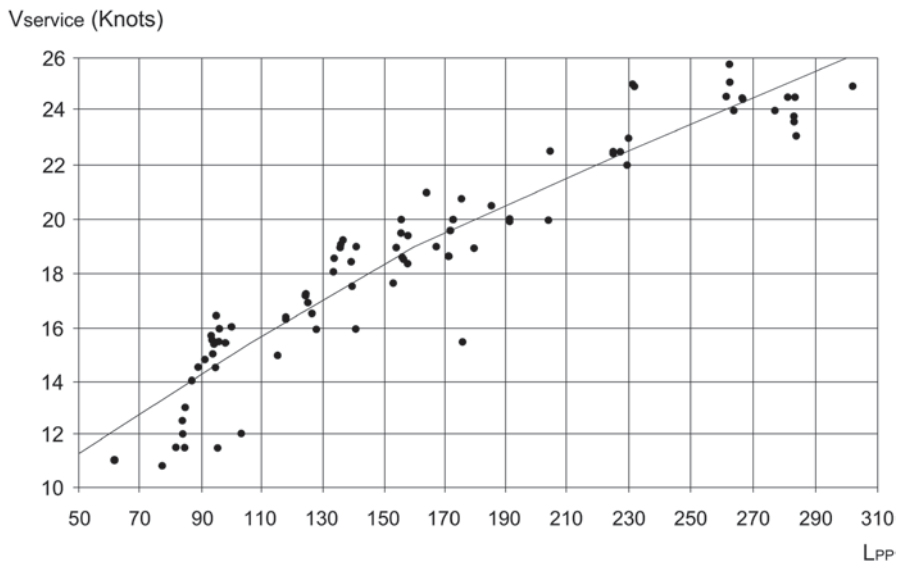

Fig. A.50 Regression analysis of the service speed V_s [knots] versus the length L [m] for container-ships according to Kristensen (2000) in Friis et al. (2002)

Tankers (Figs. A.51, A.52, A.53, A.54, A.55, A.56, A.57, A.58, A.59 and A.60)

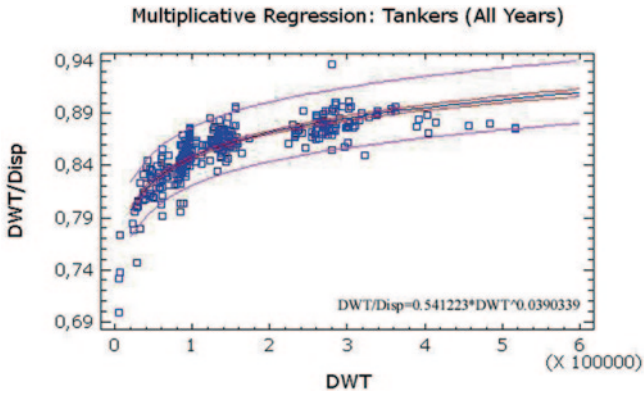

Fig. A.51 Regression analysis of ratio (DWT/ Δ) versus DWT [tons] for tankers* (Kalokairinos et al. 2000–2005)

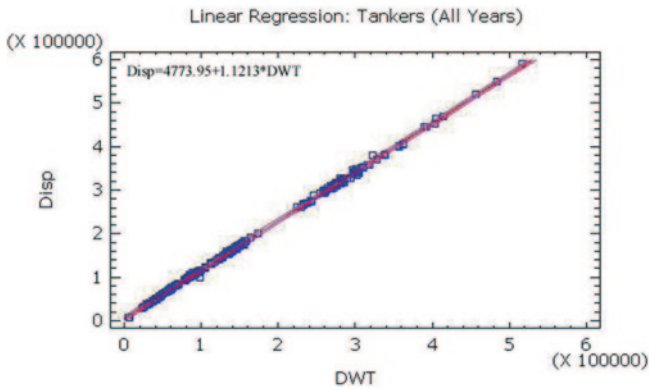

Fig. A.52 Regression analysis of displacement Δ [tons] versus DWT [tons] for tankers* (Kalokairinos et al. 2000–2005)

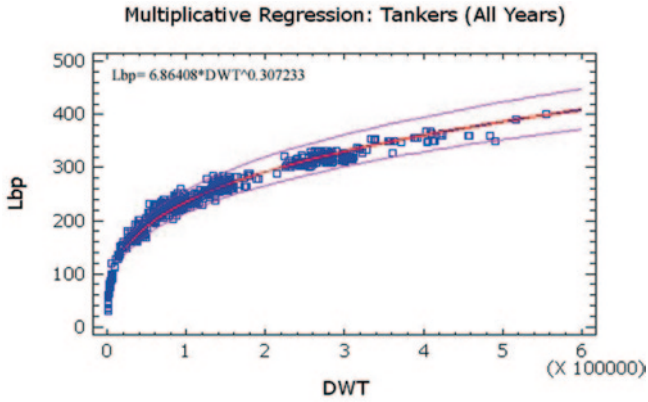

Fig. A.53 Regression analysis of length L_{BP} [m] versus DWT [tons] for tankers* (Kalokairinos et al. 2000–2005)

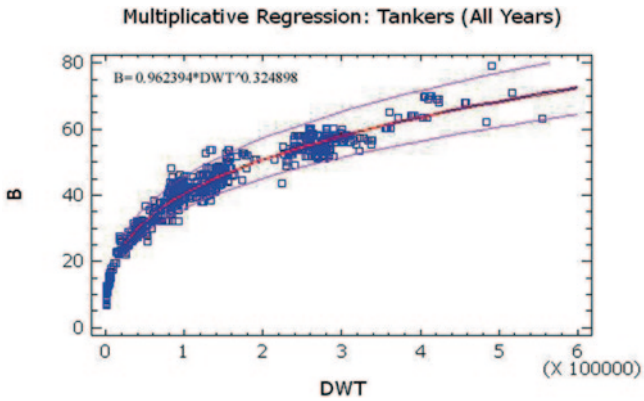

Fig. A.54 Regression analysis of beam B [m] versus DWT [tons] for tankers* (Kalokairinos et al. 2000–2005)

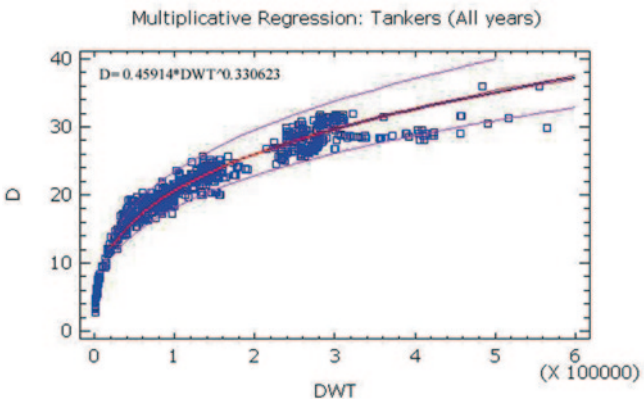

Fig. A.55 Regression analysis of side depth D [m] versus DWT [m] for tankers* (Kalokairinos et al. 2000–2005)

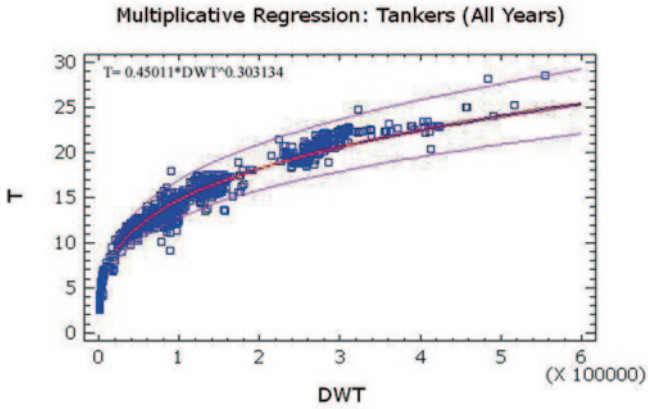

Fig. A.56 Regression analysis of draft T [m] versus DWT [tons] for tankers* (Kalokairinos et al. 2000–2005)

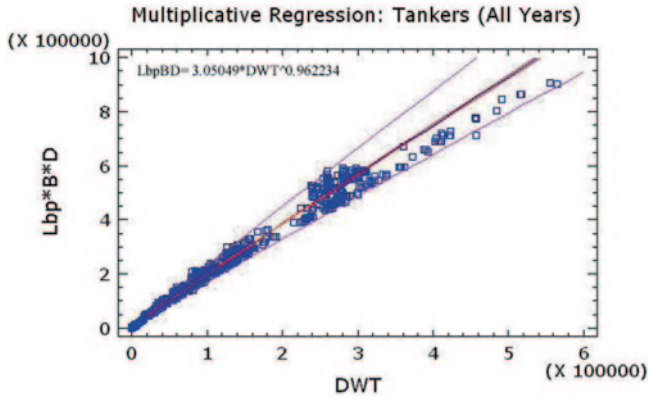

Fig. A.57 Regression analysis of volumetric product ($L \times B \times D$) [m³] versus DWT [tons] for tankers* (Kalokairinos et al. 2000–2005)

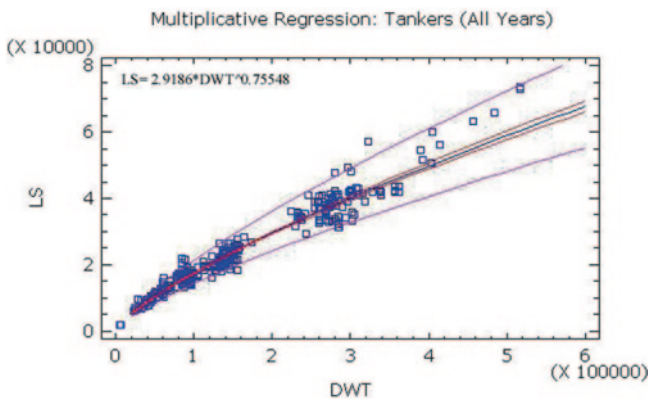

Fig. A.58 Regression analysis of lightship (LS) [tons] versus DWT [tons] for tankers* (Kalokairinos et al. 2000–2005)

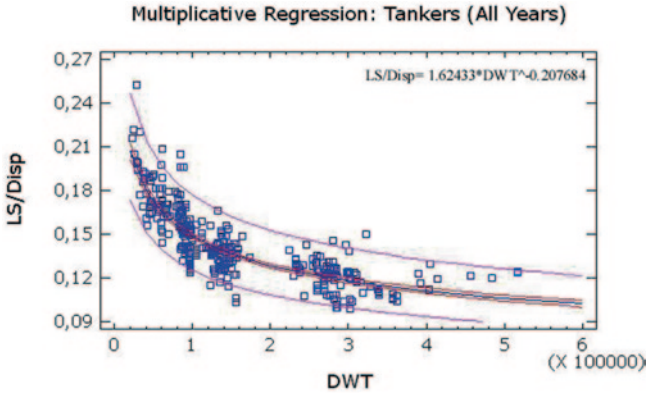

Fig. A.59 Regression analysis of ratio (LS/ Δ) versus DWT [tons] for tankers* (Kalokairinos et al. 2000–2005)

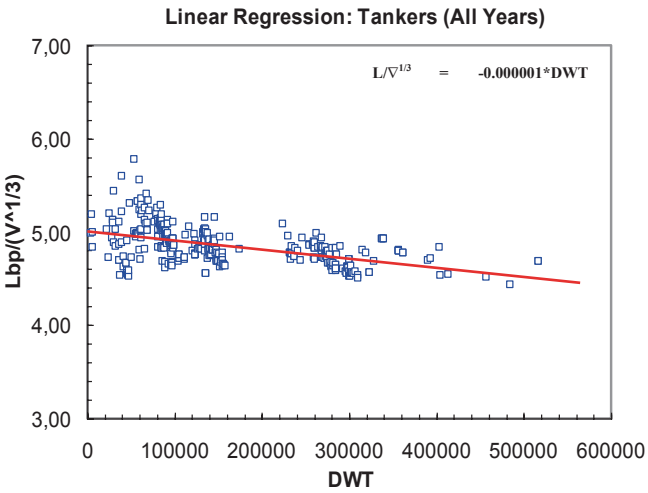

Fig. A.60 Regression analysis of slenderness ratio ($L/V^{1/3}$) versus DWT [tons] for tankers (Kalokairinos et al. 2000–2005)

Product Carriers (Figs. A.61, A.62, A.63, A.64, A.65, A.66, A.67, A.68, A.69, A.70, A.71, A.72 and A.73)

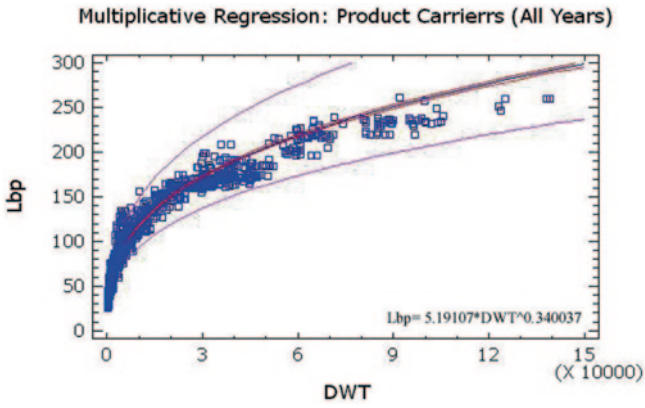

Fig. A.61 Regression analysis of length L_{BP} [m] versus DWT [tons] for product carriers* (Kalokairinos et al. 2000–2005)

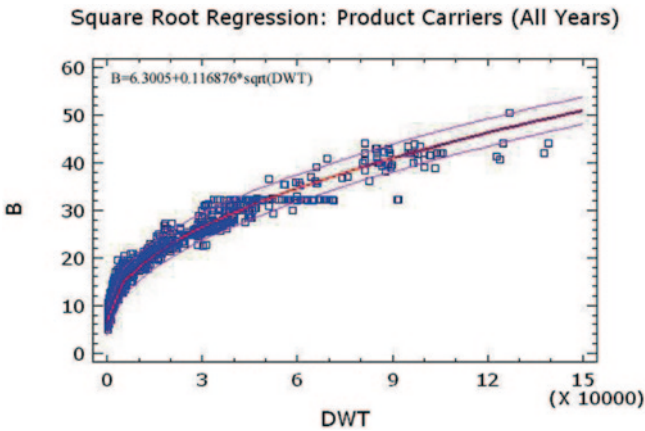

Fig. A.62 Regression analysis of beam B [m] versus DWT [m] for product carriers* (Kalokairinos et al. 2000–2005)

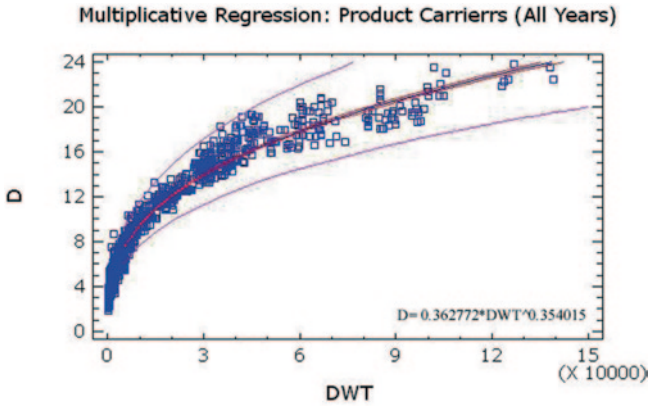

Fig. A.63 Regression analysis of side depth D [m] versus DWT [m] for product carriers* (Kalokairinos et al. 2000–2005)

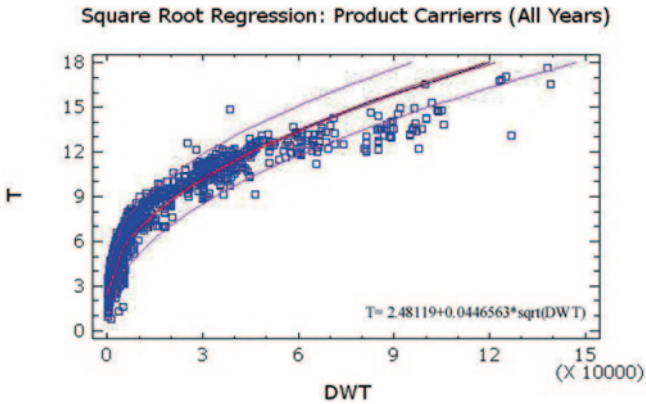

Fig. A.64 Regression analysis of draft T [m] versus DWT [tons] for product carriers* (Kalokairinos et al. 2000–2005)

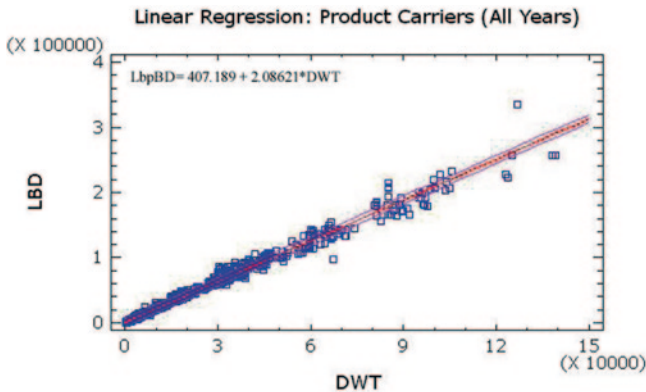

Fig. A.65 Regression analysis of volumetric product $(L \times B \times D)$ [m³] versus DWT [tons] for product carriers* (Kalokairinos et al. 2000–2005)

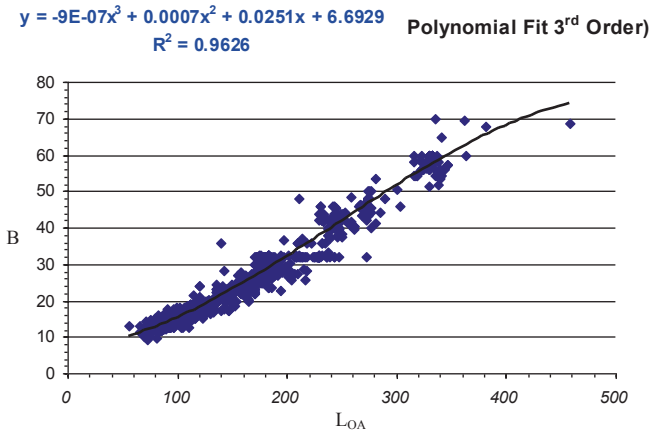

Fig. A.66 Regression analysis of beam B [m] versus length L_{OA} [m] for product carriers (Kalogairinos et al. 2000–2005)

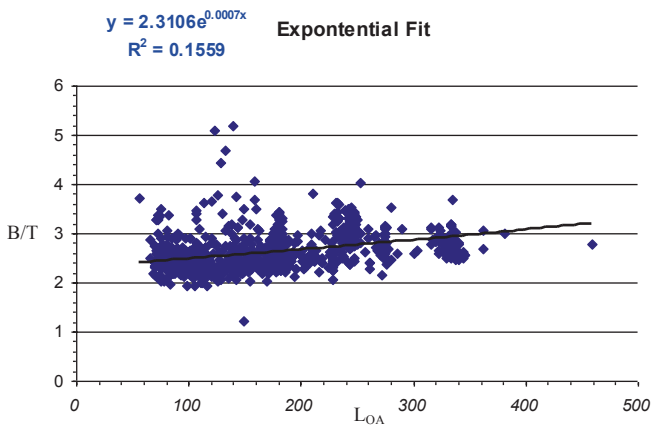

Fig. A.67 Regression analysis of ratio B/T versus the length L_{OA} [m] for product carriers (Kalogairinos et al. 2000–2005)

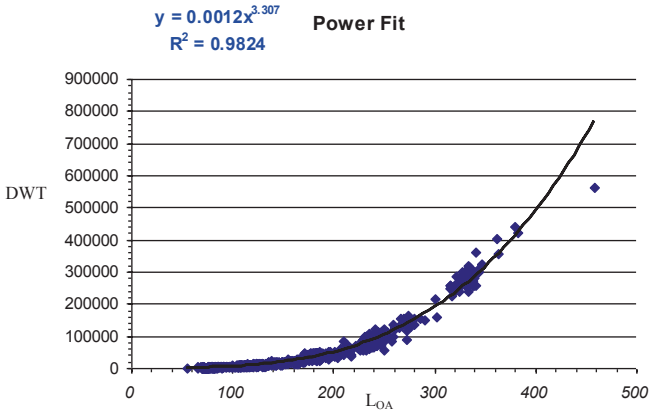

Fig. A.68 Regression analysis of DWT [tons] versus the length L_{OA} [m] for product carriers (Kalokairinos et al. 2000–2005)

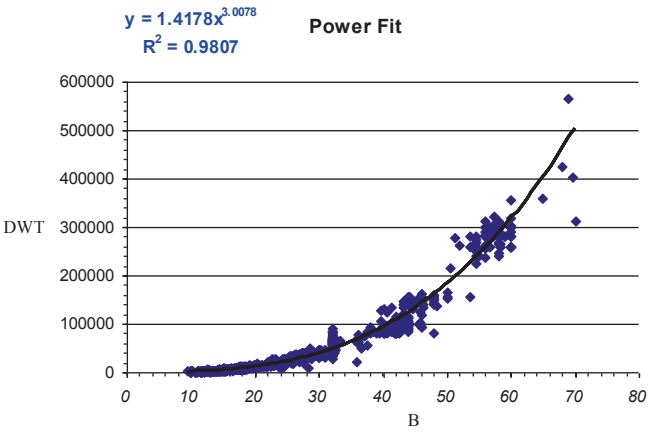

Fig. A.69 Regression analysis of DWT [tons] versus beam B [m] for product carriers (Kalokairinos et al. 2000–2005)

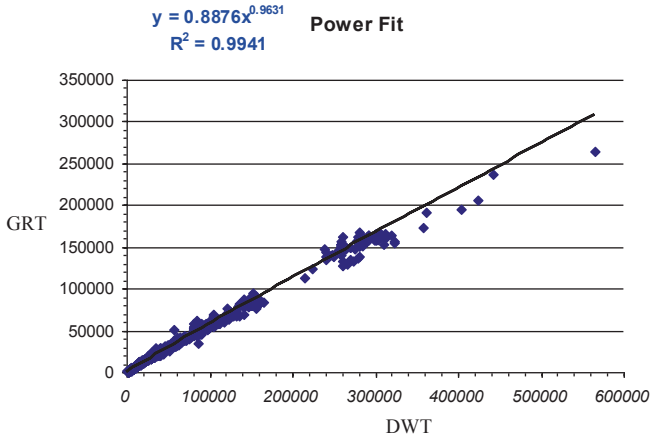

Fig. A.70 Regression analysis of GRT [RT] versus DWT [tons] for product carriers (Kalokairinos et al. 2000–2005)

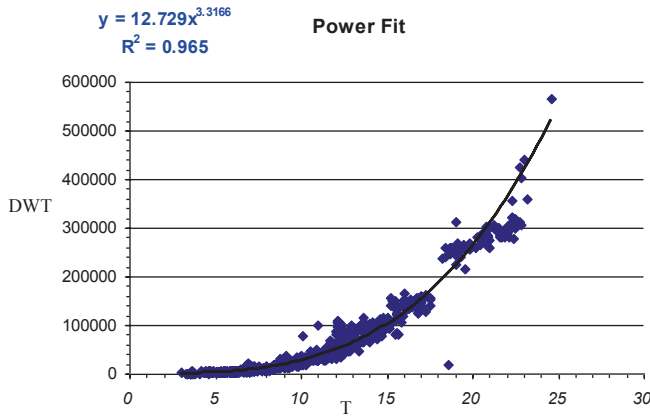

Fig. A.71 Regression analysis of DWT [tons] versus draft T [m] for product carriers (Kalokairinos et al. 2000–2005)

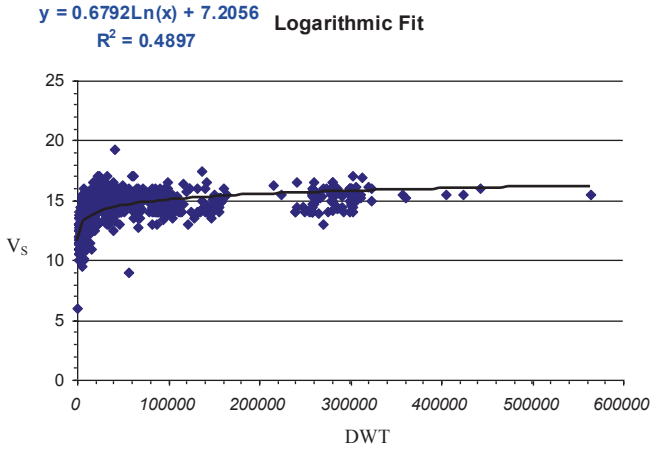

Fig. A.72 Regression analysis of the speed V [knots] versus DWT [tons] for product carriers (Kalokairinos et al. 2000–2005)

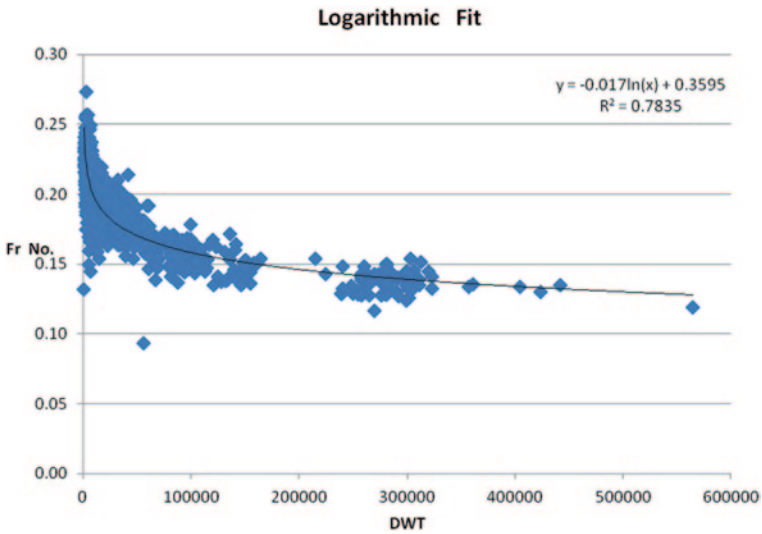

Fig. A.73 Regression analysis of the Froude No. versus DWT [tons] for product carriers (Kalokairinos et al. 2000–2005)

Chemical Carriers (Figs. A.74, A.75, A.76, A.77, A.78, A.79, A.80, and A.81)

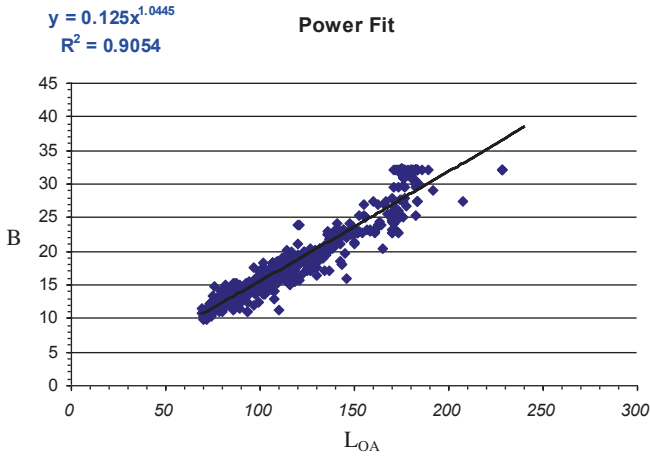

Fig. A.74 Regression analysis of beam B [m] versus length L_{OA} [m] for chemical carriers (Kalokairinos et al. 2000–2005)

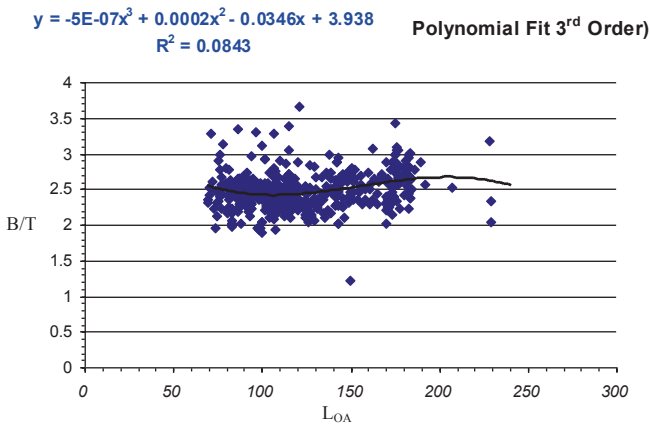

Fig. A.75 Regression analysis of ratio B/T versus length L_{OA} [m] for chemical carriers (Kalokairinos et al. 2000–2005)

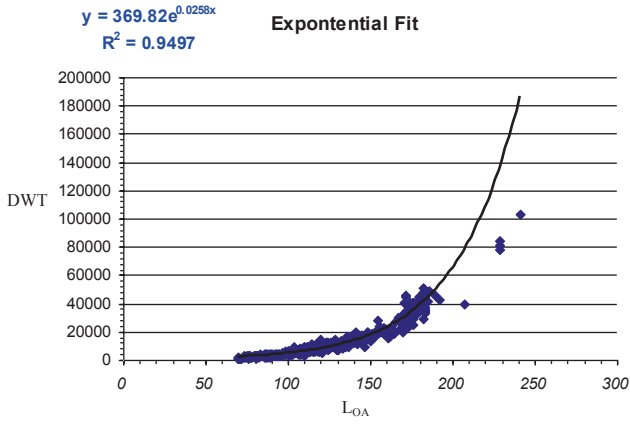

Fig. A.76 Regression analysis of DWT [tons] versus length L_{OA} [m] for chemical carriers (Kalo-kairinos et al. 2000–2005)

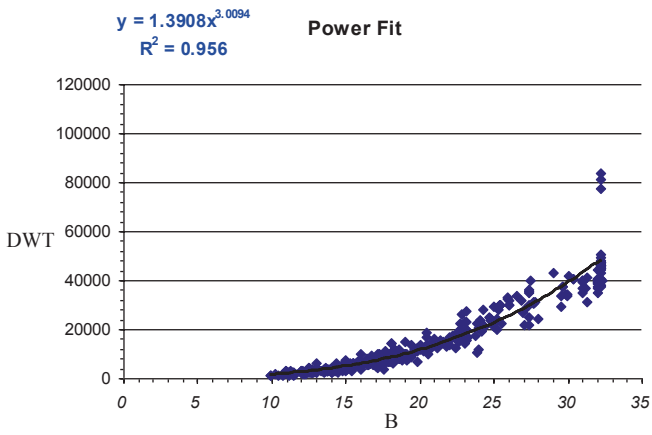

Fig. A.77 Regression analysis of DWT [tons] versus beam B [m] for chemical carriers (Kalo-kairinos et al. 2000–2005)

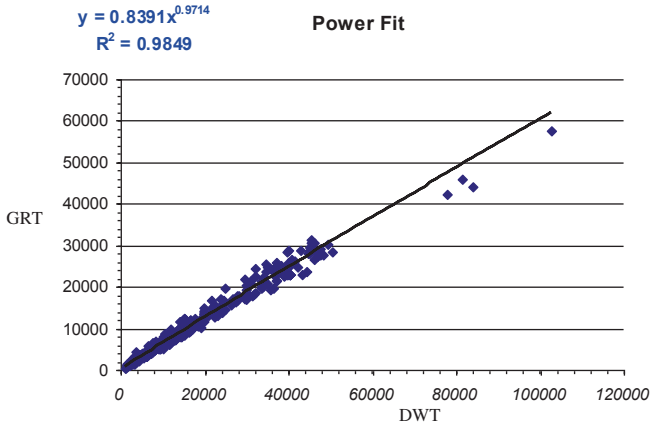

Fig. A.78 Regression analysis of GRT [RT] versus DWT [tons] for chemical carriers (Kalokairinos et al. 2000–2005)

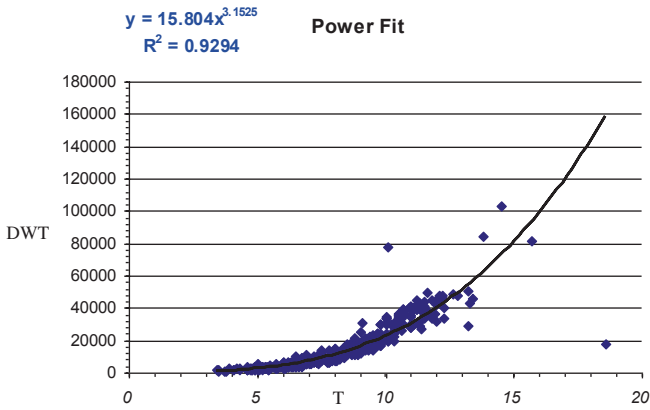

Fig. A.79 Regression analysis of DWT [tons] versus draft T [m] for chemical carriers (Kalokairinos et al. 2000–2005)

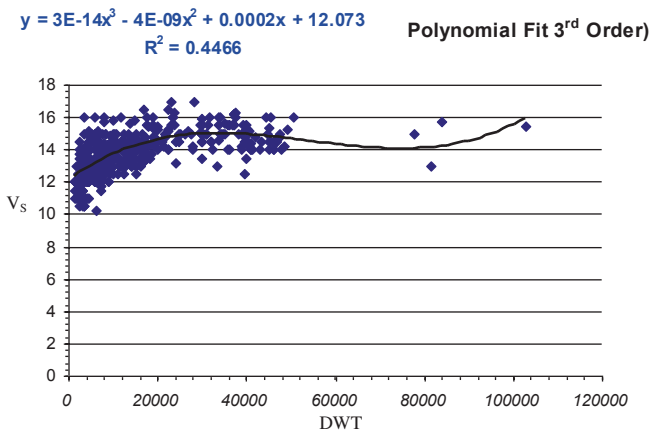

Fig. A.80 Regression analysis of the speed V [knots] versus DWT [tons] for chemical carriers (Kalokairinos et al. 2000–2005)

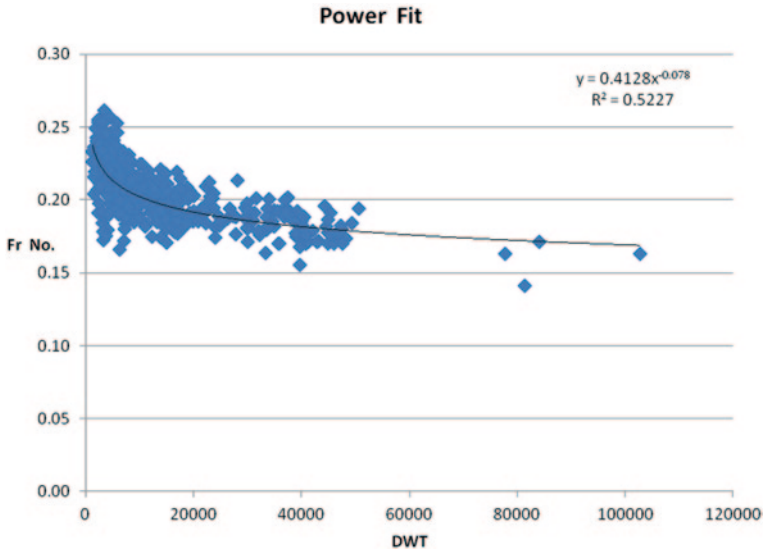

Fig. A.81 Regression analysis of the Froude No. versus DWT [tons] for chemical carriers (Kalokairinos et al. 2000–2005)

General Cargo Carriers (Figs. A.82, A.83, A.84, A.85, A.86, A.87 and A.88)

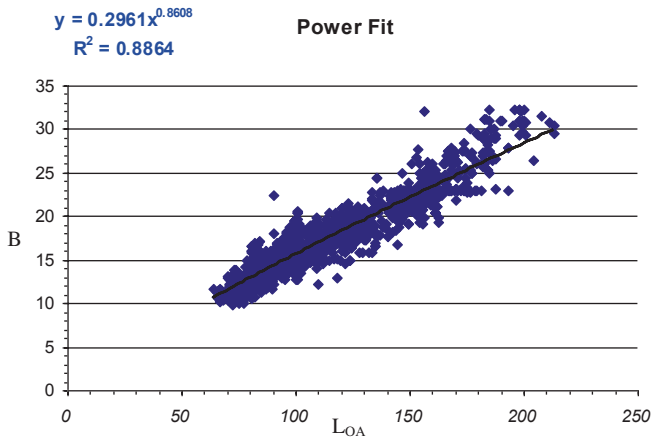

Fig. A.82 Regression analysis of beam B [m] versus length L_{OA} [m] for general cargo carriers (Kalokairinos et al. 2000–2005)

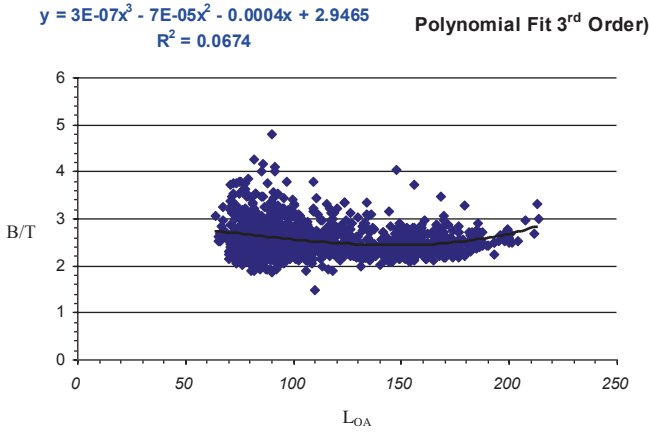

Fig. A.83 Regression analysis of ratio B/T versus length L_{OA} [m] for general cargo carriers (Kalokairinos et al. 2000–2005)

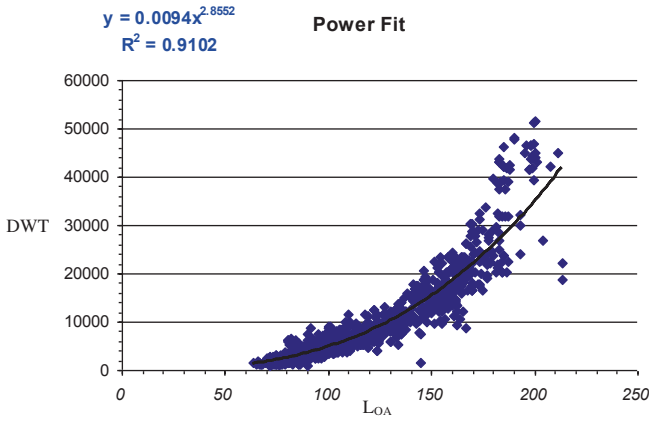

Fig. A.84 Regression analysis of the DWT [tons] versus length L_{OA} [m] for general cargo carriers (Kalokairinos et al. 2000–2005)

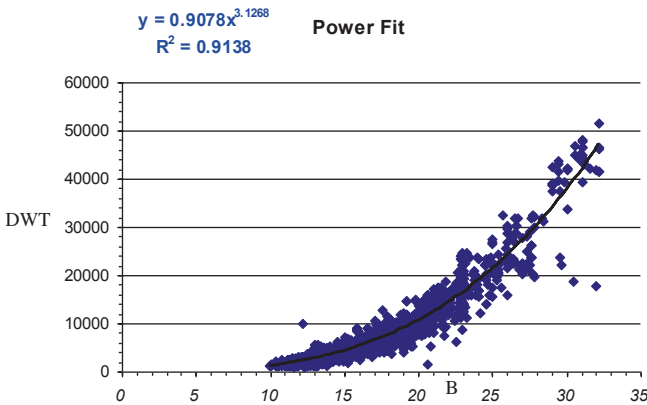

Fig. A.85 Regression analysis of DWT [tons] versus the beam B [m] for general cargo carriers (Kalokairinos et al. 2000–2005)

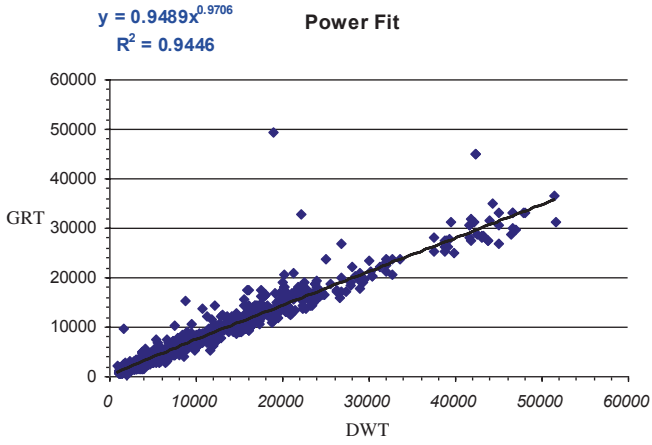

Fig. A.86 Regression analysis of GRT [RT] versus DWT [tons] for general cargo carriers (Kalokairinos et al. 2000–2005)

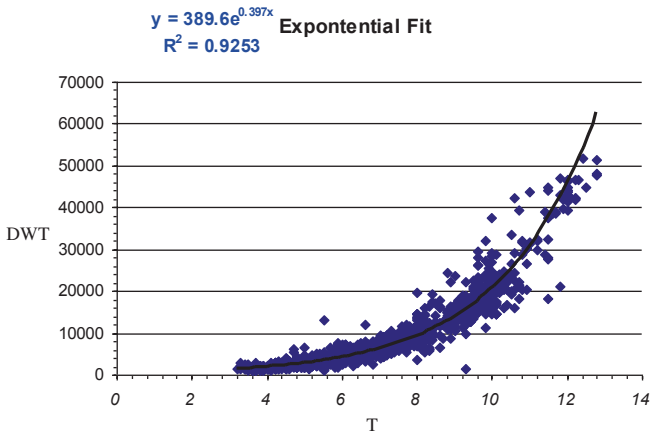

Fig. A.87 Regression analysis of DWT [tons] versus the draft T [m] for general cargo carriers (Kalokairinos et al. 2000–2005)

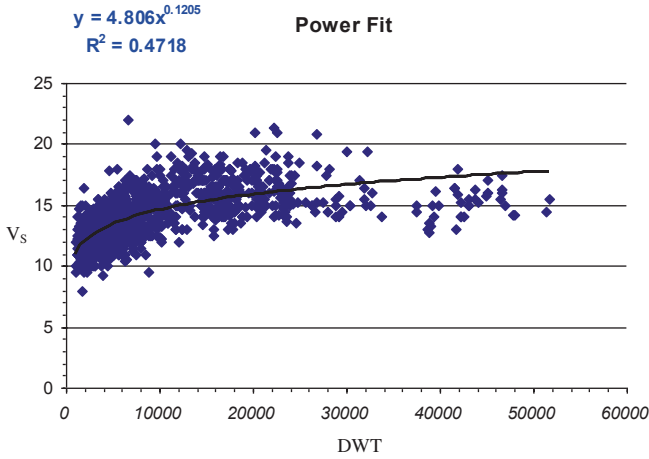

Fig. A.88 Regression analysis of the speed V [knots] versus DWT [tons] for general cargo carriers (Kalokairinos et al. 2000–2005)

RO–RO Cargo Ships (Figs. A.89, A.90, A.91, A.92, A.93, A.94, A.95, A.96, A.97 and A.98)

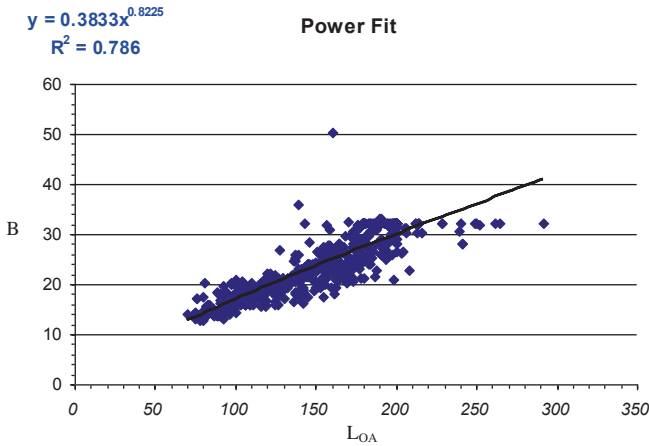

Fig. A.89 Regression analysis of beam B [m] versus length L_{OA} [m] for Ro–Ro cargo ships (Kalokairinos et al. 2000–2005)

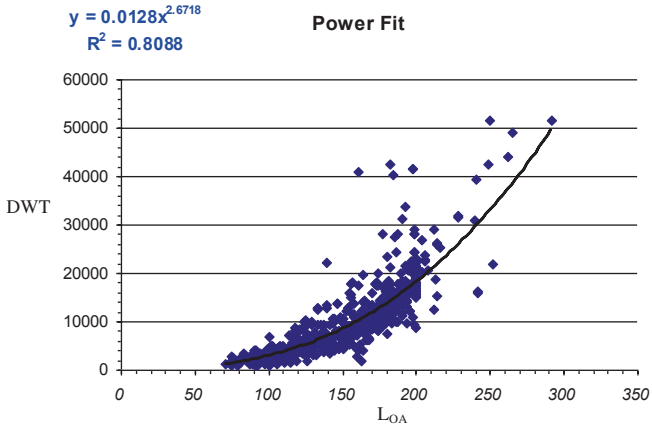

Fig. A.90 Regression analysis of DWT [tons] versus length L_{OA} [m] for Ro-Ro cargo ships (Kalo-kairinos et al. 2000–2005)

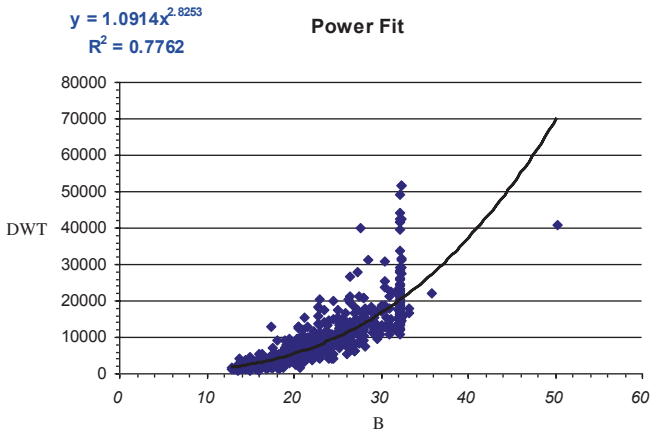

Fig. A.91 Regression analysis of DWT [tons] versus beam B [m] for Ro-Ro cargo ships (Kalo-kairinos et al. 2000–2005)

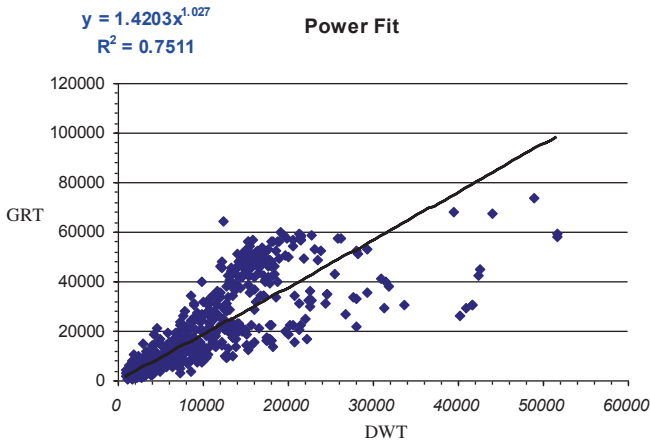

Fig. A.92 Regression analysis of GRT [RT] versus DWT [tons] for Ro-Ro cargo ships (Kalokairinos et al. 2000–2005)

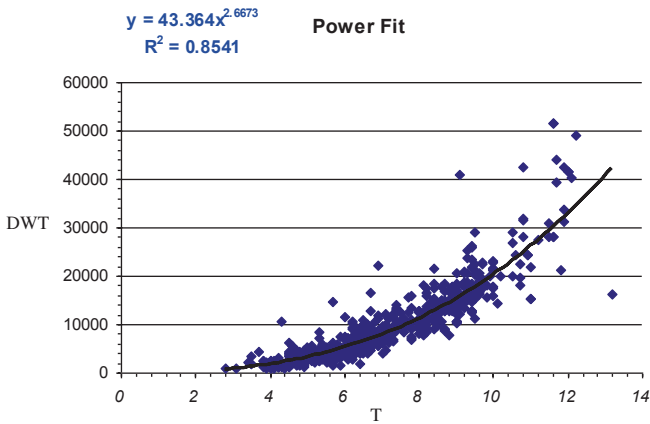

Fig. A.93 Regression analysis of DWT [tons] versus draft T [m] for Ro-Ro cargo ships (Kalokairinos et al. 2000–2005)

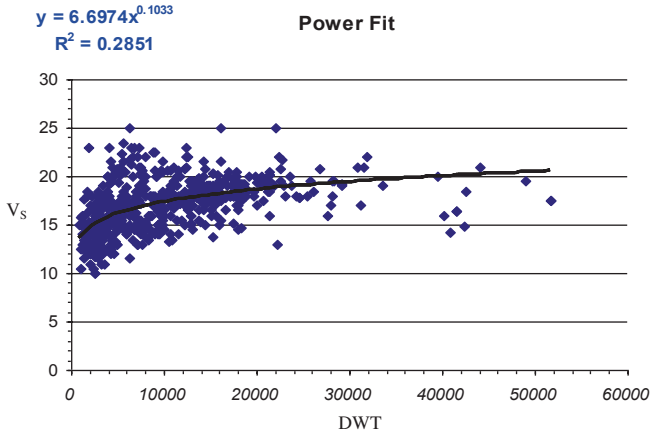

Fig. A.94 Regression analysis of the speed V [knots] versus DWT [tons] for Ro—Ro cargo ships (Kalokairinos et al. 2000–2005)

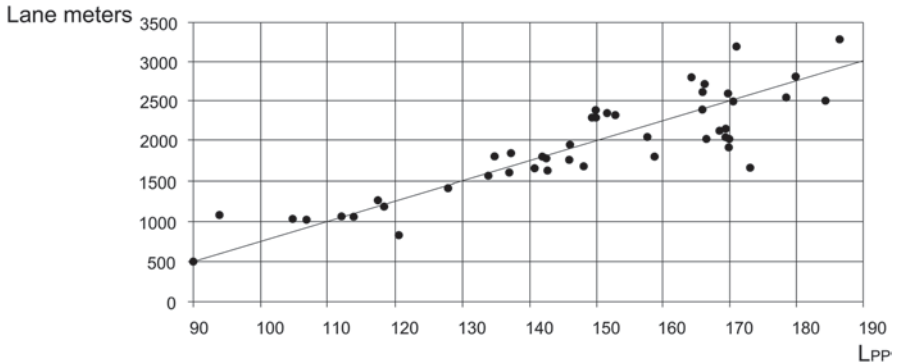

Fig. A.95 Regression analysis of vehicles' lane length [m] versus the length L [m] for Ro—Ro cargo ships according to Kristensen (2000) in Friis et al. (2002)

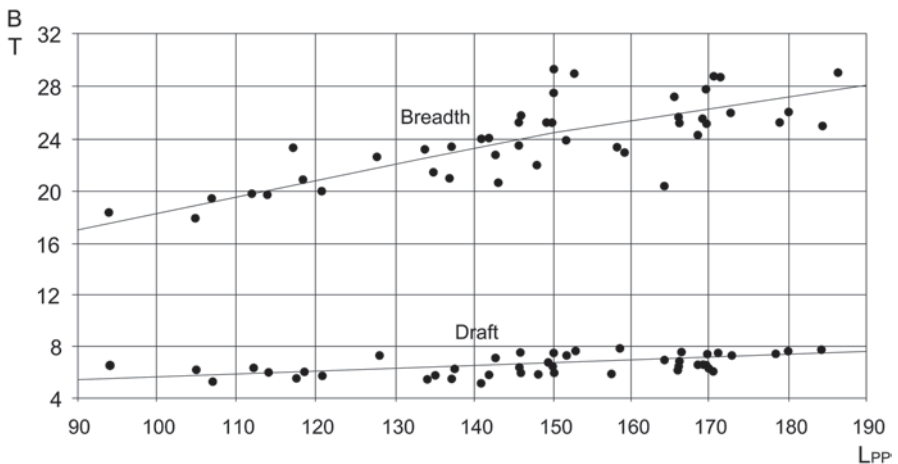

Fig. A.96 Regression analysis of the beam B [m] and the draft T [m] versus the length L [m] for Ro—Ro cargo ships according to Kristensen (2000) in Friis et al. (2002)

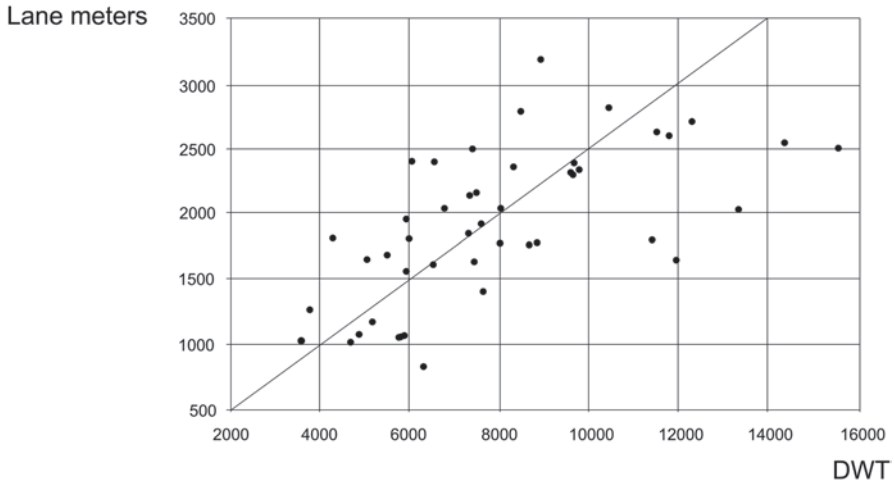

Fig. A.97 Regression analysis of the vehicles' lanes length [m] versus the DWT [tons] for Ro-Ro cargo ships according to Kristensen (2000) in Friis et al. (2002)

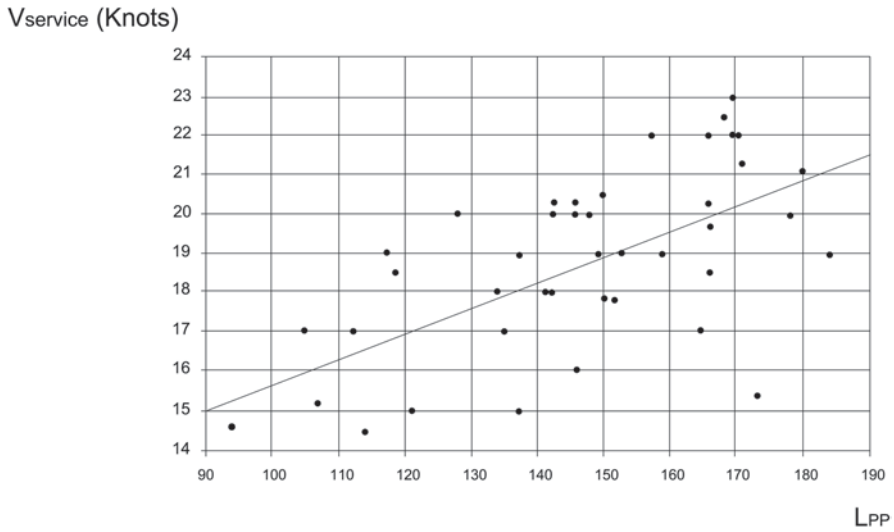

Fig. A.98 Regression analysis of the service speed V_s [knots] versus the ship length L [m] for Ro-Ro cargo ships according to Kristensen (2000) in Friis et al. (2002)

RO-RO Passenger Ferries (Figs. A.99, A.100, A.101, A.102, A.103, A.104 and A.105)

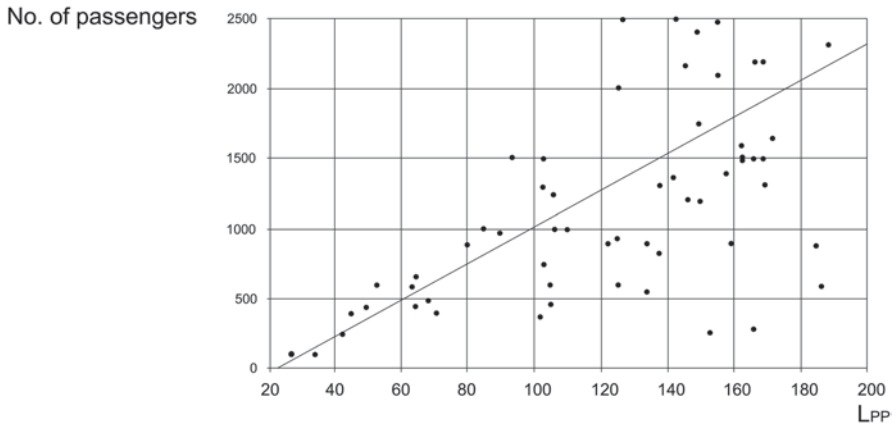

Fig. A.99 Regression analysis of the number of passengers versus the ship length L [m] for RoPAX ships according to Kristensen (2000) in Friis et al. (2002)

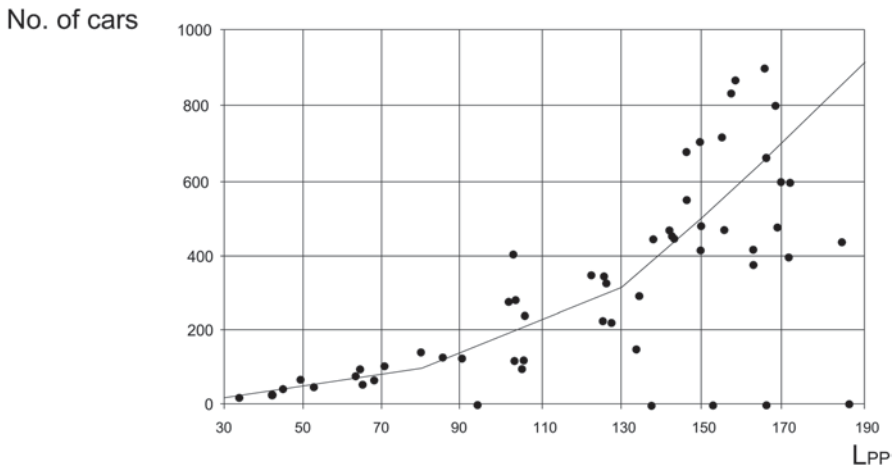

Fig. A.100 Regression analysis of the number of vehicles versus the ship length L [m] for RoPAX ships according to Kristensen (2000) in Friis et al. (2002)

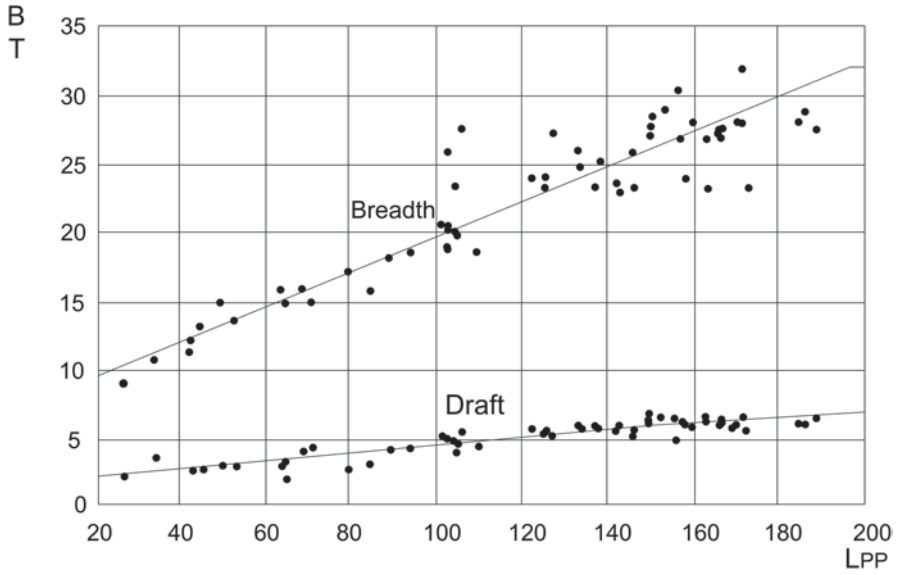

Fig. A.101 Regression analysis of the beam B [m] and the draft T [m] versus the length L [m] for RoPAX ships according to Kristensen (2000) in Friis et al. (2002)

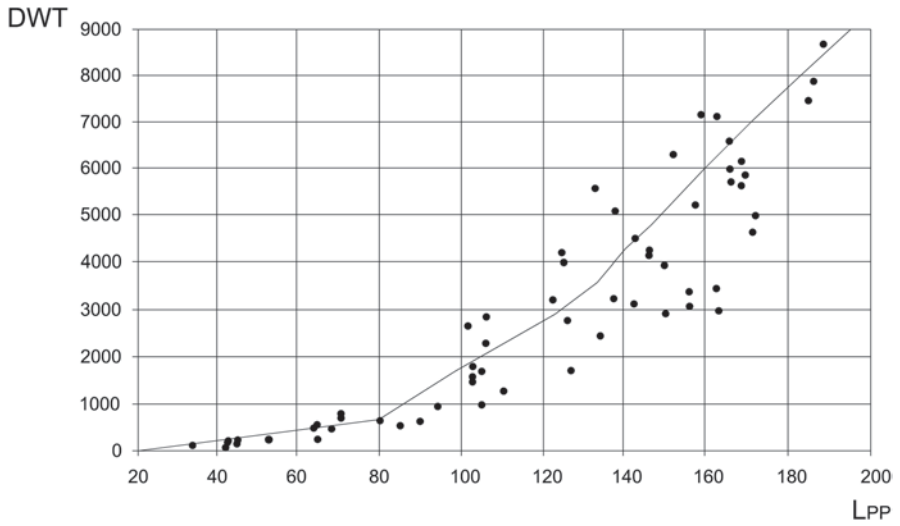

Fig. A.102 Regression analysis of the DWT [tons] versus the ship length L [m] for RoPAX ships according to Kristensen (2000) in Friis et al. (2002)

Lane meters

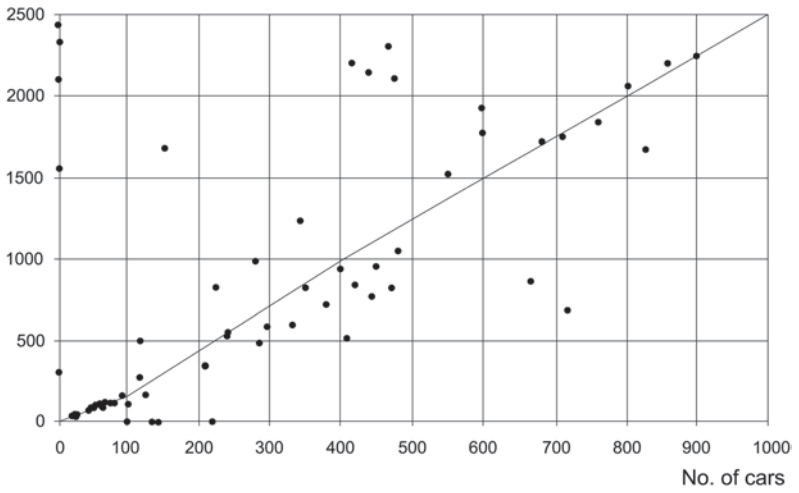

Fig. A.103 Regression analysis of the vehicles' lane length [m] versus the number of vehicles for RoPAX ships according to Kristensen (2000) in Friis et al. (2002)

0.6 • Deadweight
Lane meters

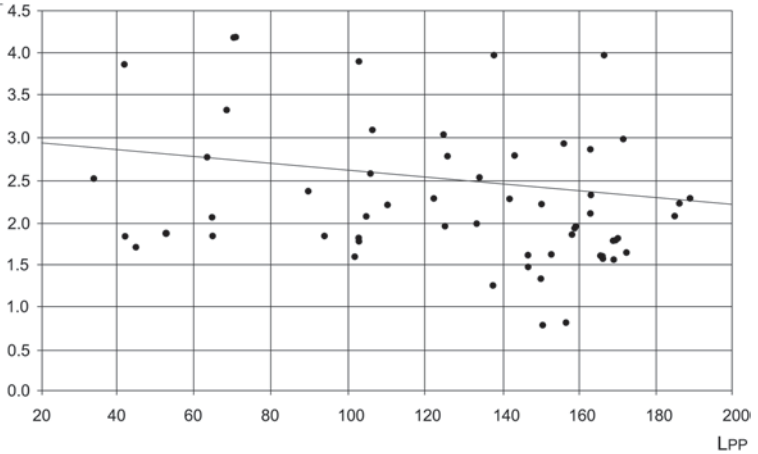

Fig. A.104 Regression analysis of the ratio of 60% of DWT [tons] to the vehicle lane length [m] versus the length L [m] for RoPAX ships according to Kristensen (2000) in Friis et al. (2002)

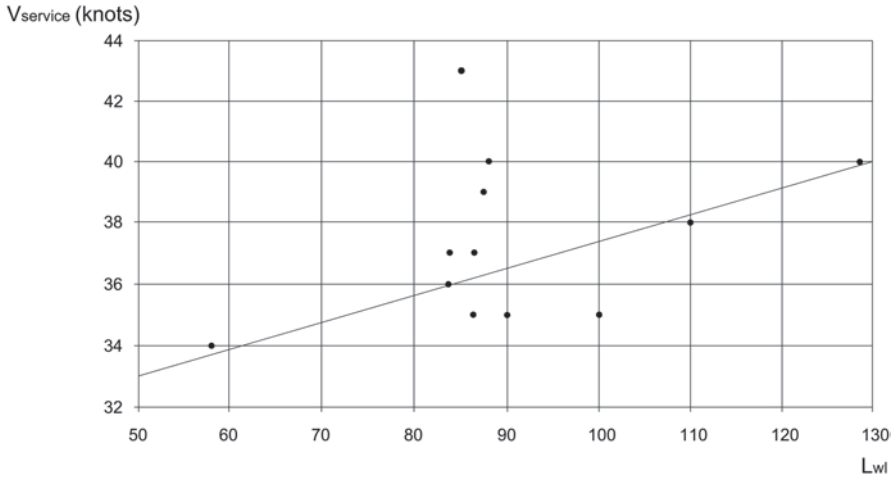

Fig. A.105 Regression analysis of the service speed V_s [knots] versus the length L [m] for RoPAX ships according to Kristensen (2000) in Friis et al. (2002)

Single-Hull Fast Ferries (Figs. A.106, A.107, A.108, A.109, A.110 and A.111)

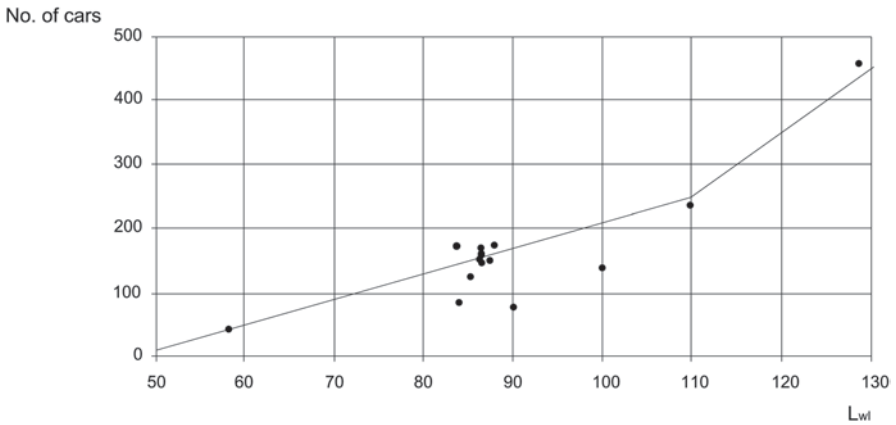

Fig. A.106 Regression analysis of the vehicle number versus the length L_{wl} [m] for fast single-hull ferries according to Kristensen (2000) in Friis et al. (2002)

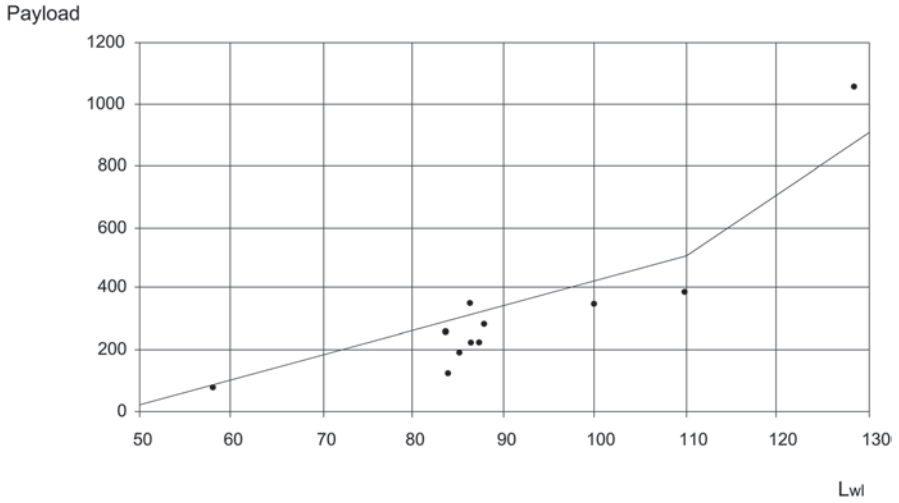

Fig. A.107 Regression analysis of the payload [tons] versus the length L_{wl} [m] for fast single-hull ferries according to Kristensen (2000) in Friis et al. (2002)

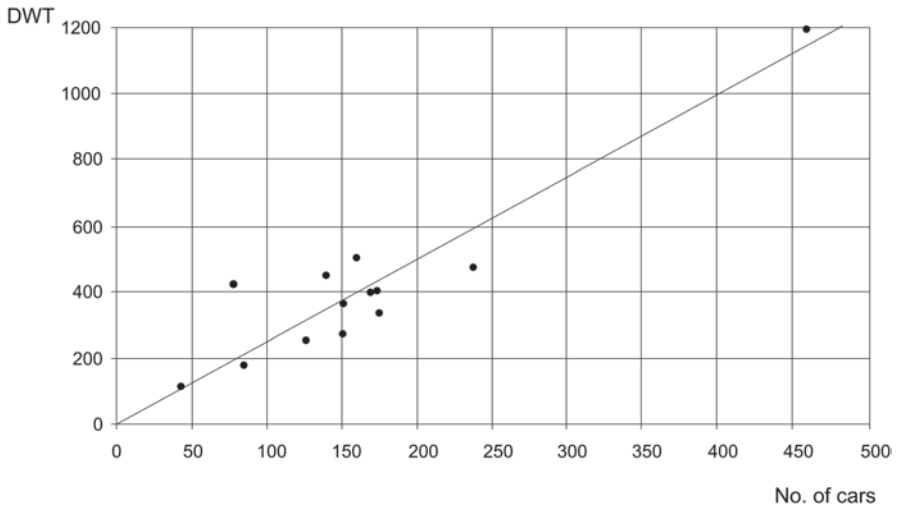

Fig. A.108 Regression analysis of the DWT [tons] versus the vehicle number for fast single-hull ferries according to Kristensen (2000) in Friis et al. (2002)

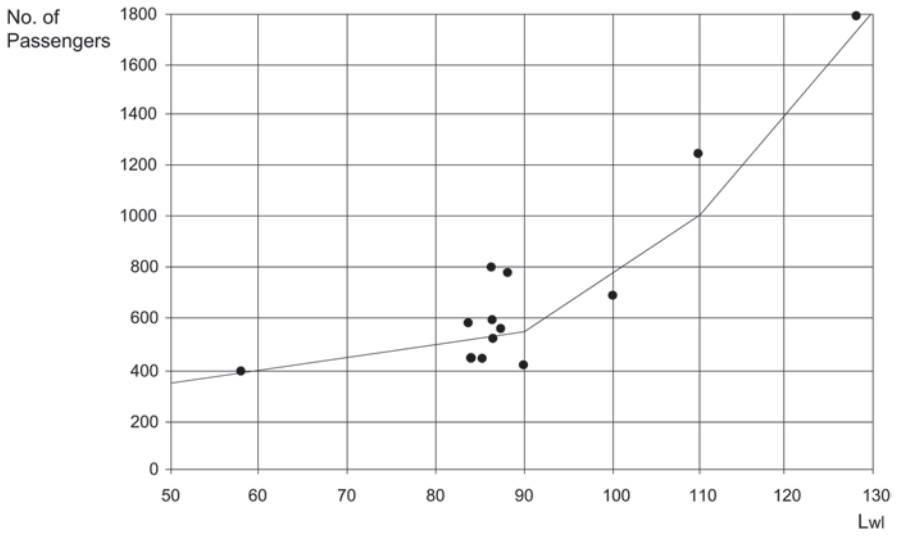

Fig. A.109 Regression analysis of the number of passengers versus the length L_{wl} [m] for fast single-hull ferries according to Kristensen (2000) in Friis et al. (2002)

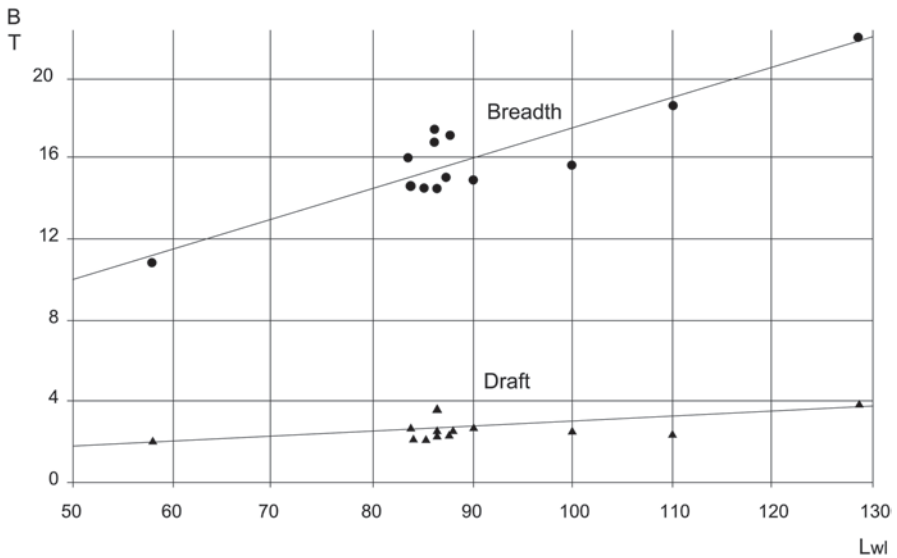

Fig. A.110 Regression analysis of the beam B [m] and draft T [m] versus the length L_{wl} [m] for fast single-hull ferries according to Kristensen (2000) in Friis et al. (2002)

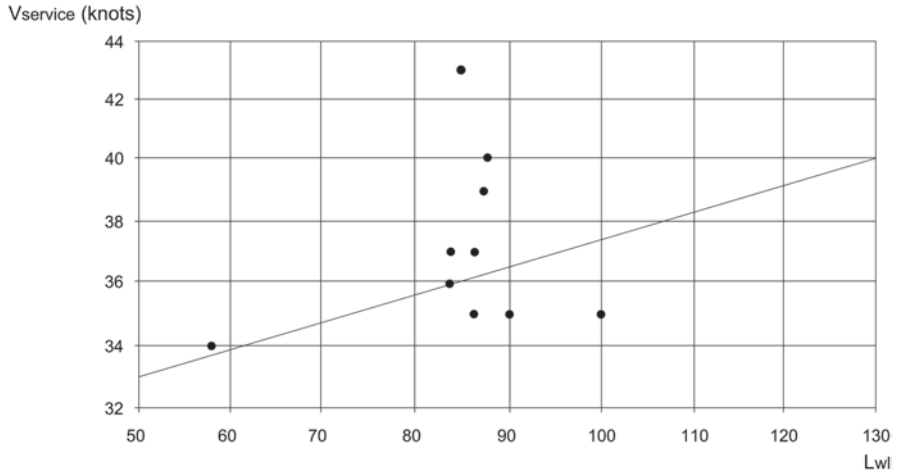

Fig. A.111 Regression analysis of the service speed V_s [knots] versus the length L_{wl} [m] for fast single-hull ferries according to Kristensen (2000) in Friis et al. (2002)

Car Carrying Catamarans (Figs. A.112, A.113, A.114 and A.115)

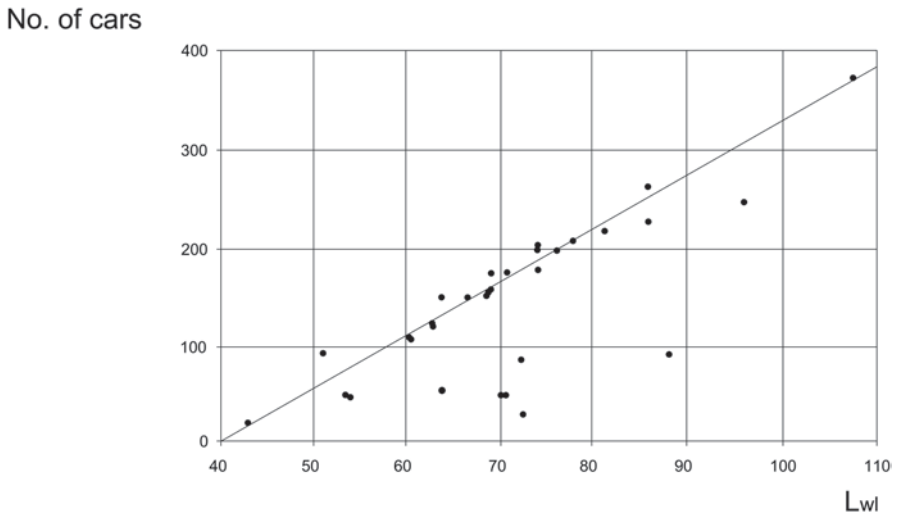

Fig. A.112 Regression analysis of the vehicle number versus the length L_{wl} [m] for catamaran according to Kristensen (2000) in Friis et al. (2002)

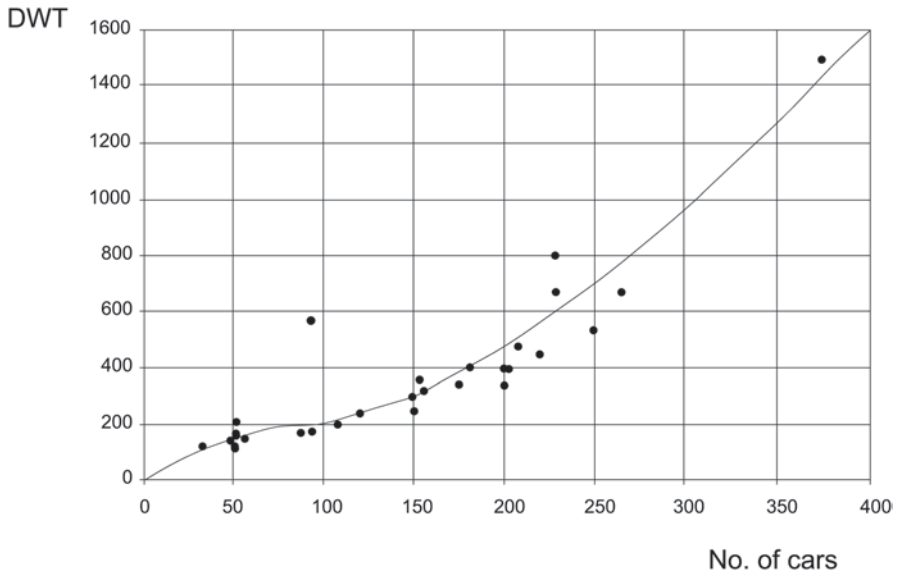

Fig. A.113 Regression analysis of the DWT [tons] versus the vehicle number for catamaran according to Kristensen (2000) in Friis et al. (2002)

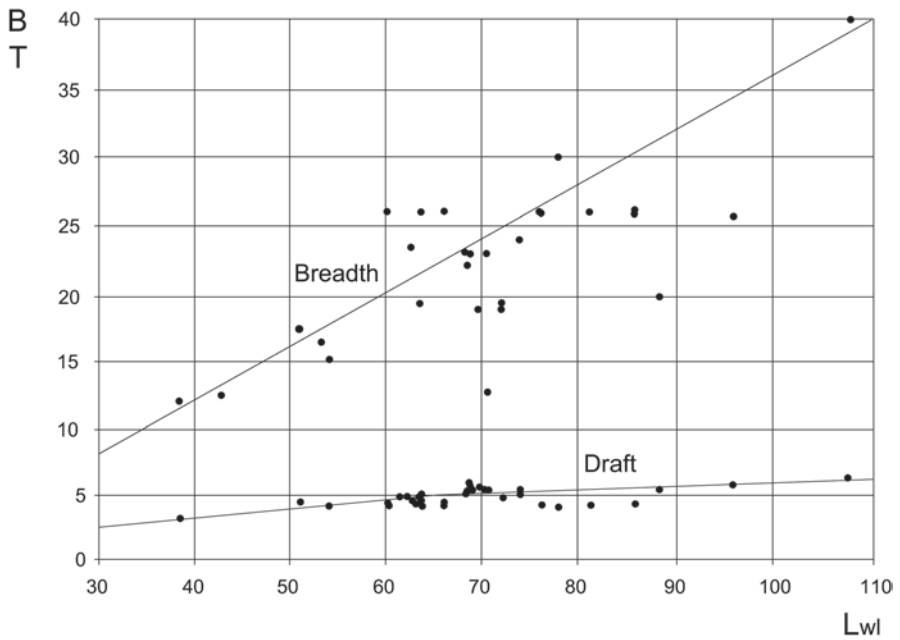

Fig. A.114 Regression analysis of the beam B [m] versus the length L_{wl} [m] for catamaran according to Kristensen (2000) in Friis et al. (2002)

V_{service} (knots)

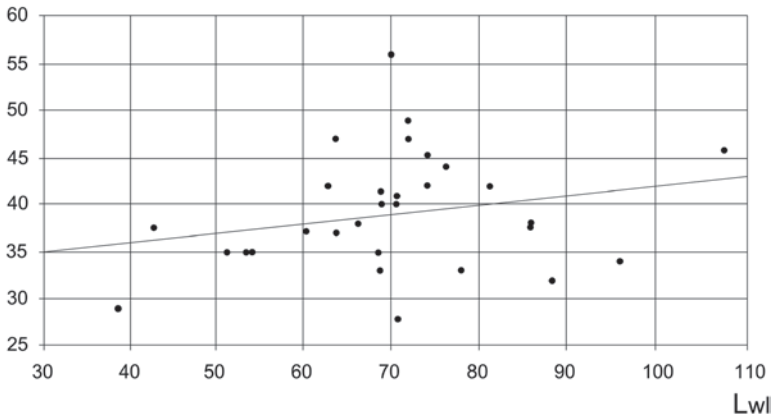

Fig. A.115 Regression analysis of the service speed V_s [knots] versus the length L_{wl} [m] for catamaran ferries according to Kristensen (2000) in Friis et al. (2002)

Reefer Ships (Figs. A.116, A.117, A.118, A.119, A.120, A.121, A.122 and A.123)

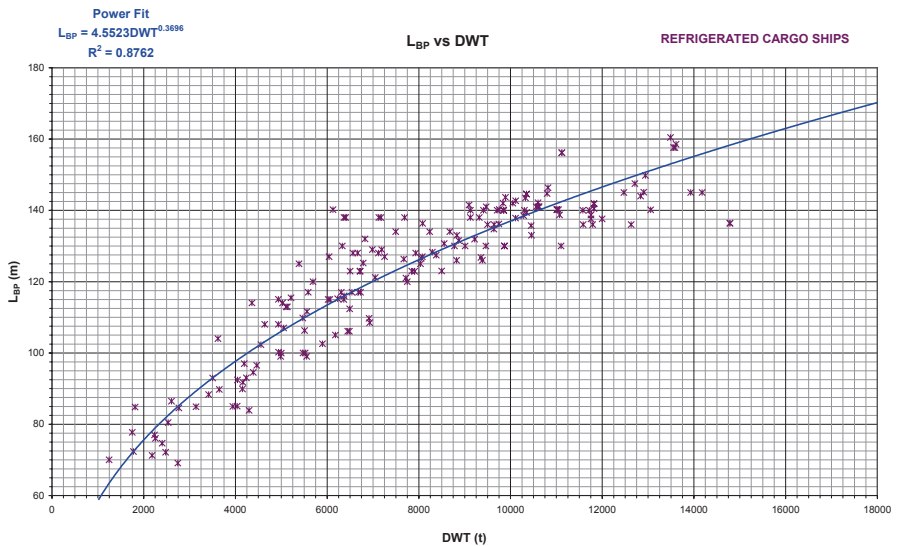

Fig. A.116 Regression analysis of the length L_{BP} [m] versus the DWT [tons] for reefer ships (Kalokairinos et al. 2000–2005)

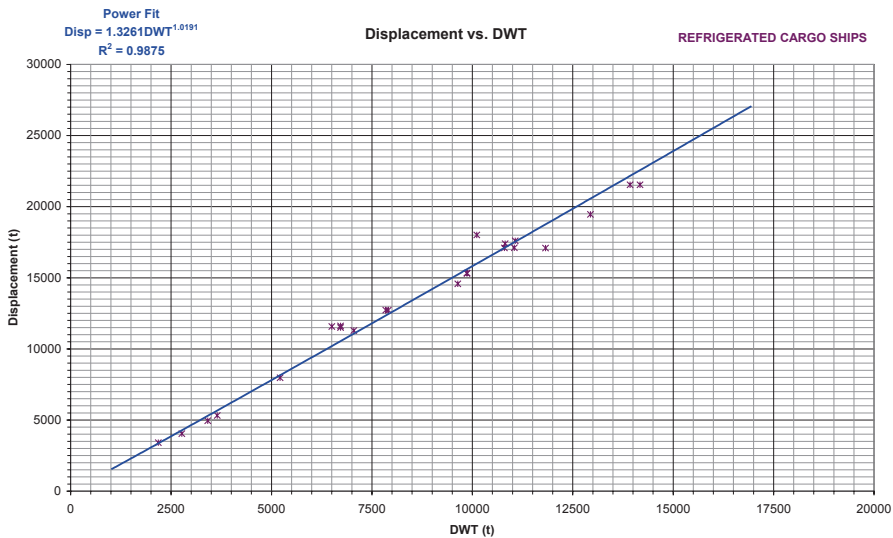

Fig. A.117 Regression analysis of the displacement Δ [tons] versus the DWT [tons] for reefer ships (Kalokairinos et al. 2000–2005)

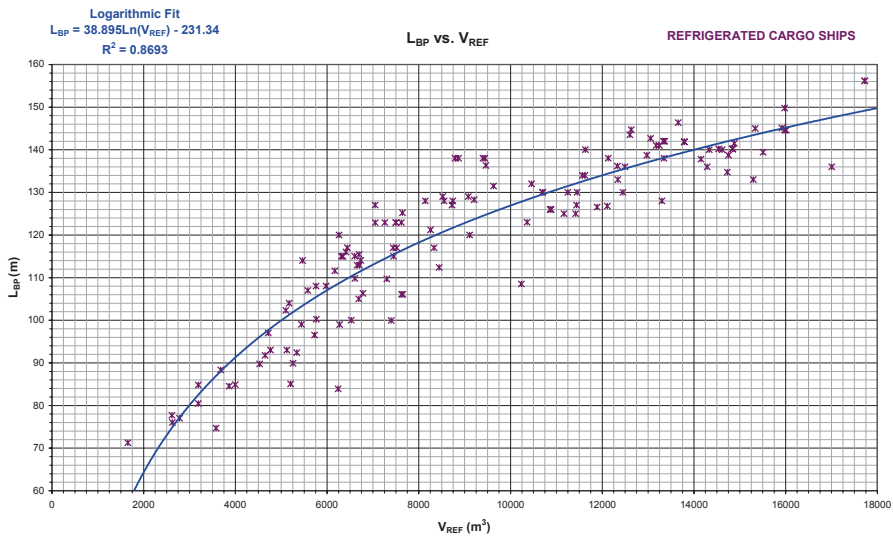

Fig. A.118 Regression analysis of the length L_{BP} [m] versus the hold volume V_{REF} [m³] for reefer ships (Kalokairinos et al. 2000–2005)

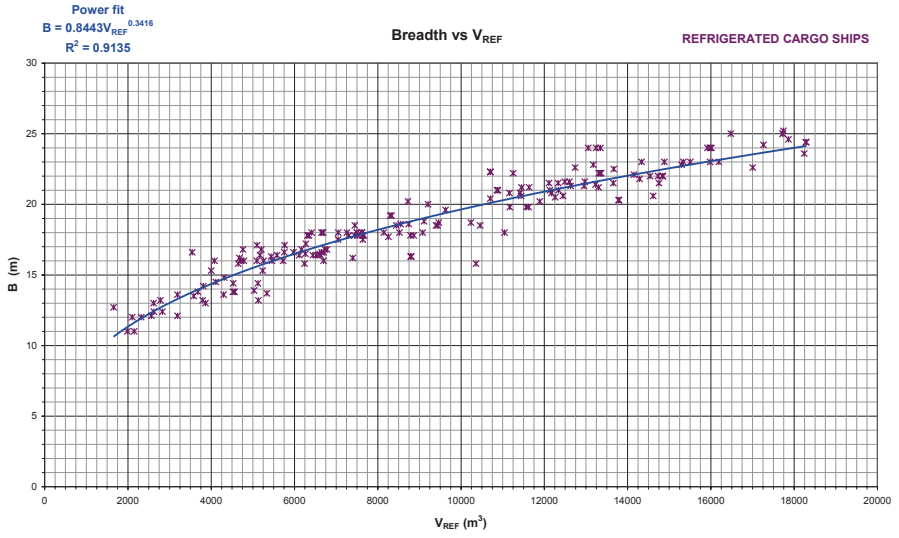

Fig. A.119 Regression analysis of the beam B [m] versus the hold volume V_{REF} [m^3] for reefer ships (Kalokairinos et al. 2000–2005)

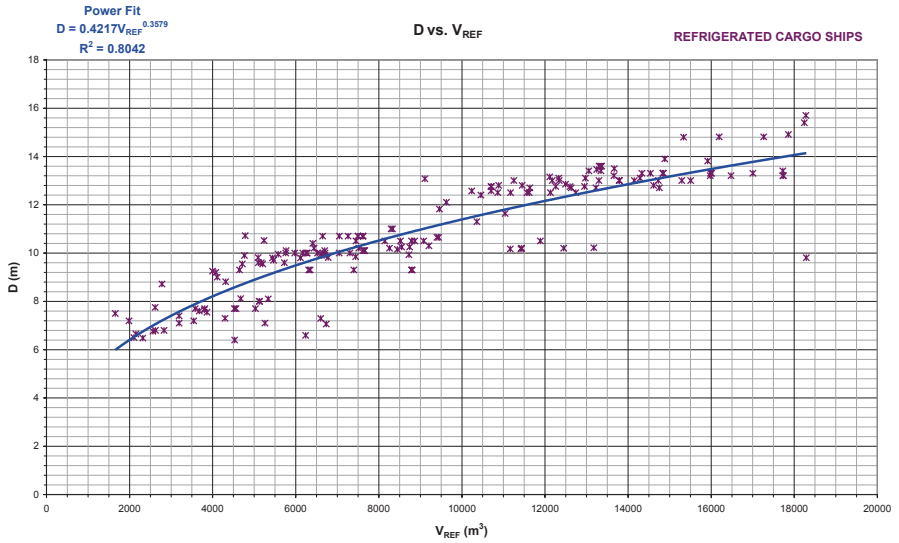

Fig. A.120 Regression analysis of the side depth D [m] versus the hold volume V_{REF} [m^3] for reefer ships (Kalokairinos et al. 2000–2005)

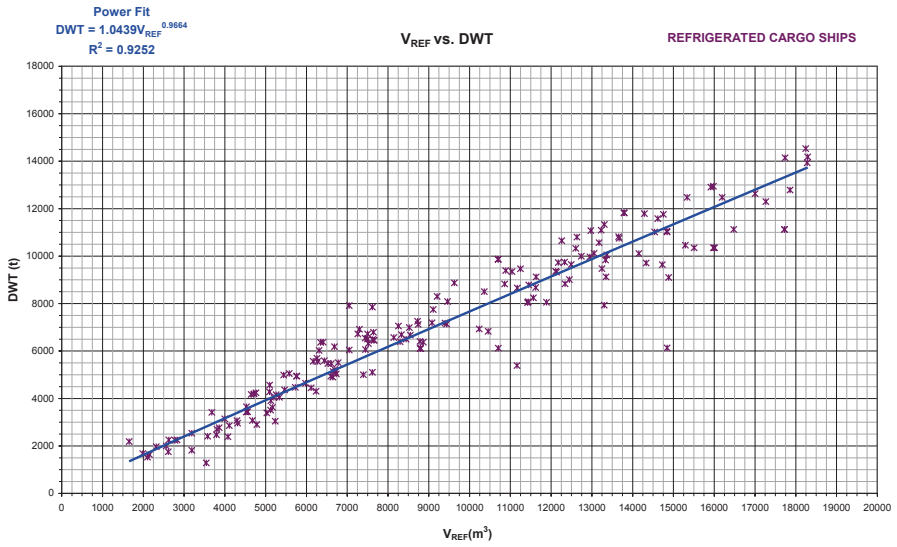

Fig. A.121 Regression analysis of the DWT [tons] versus the hold volume V_{REF} [m³] for reefer ships (Kalokairinos et al. 2000–2005)

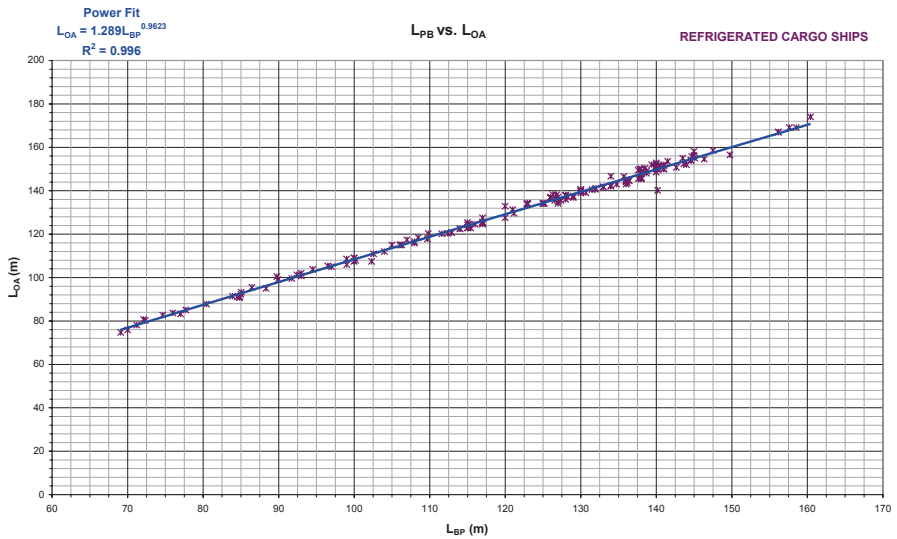

Fig. A.122 Regression analysis of the overall length L_{OA} [m] versus the length between perpendiculars L_{BP} [m] for reefer ships (Kalokairinos et al. 2000–2005)

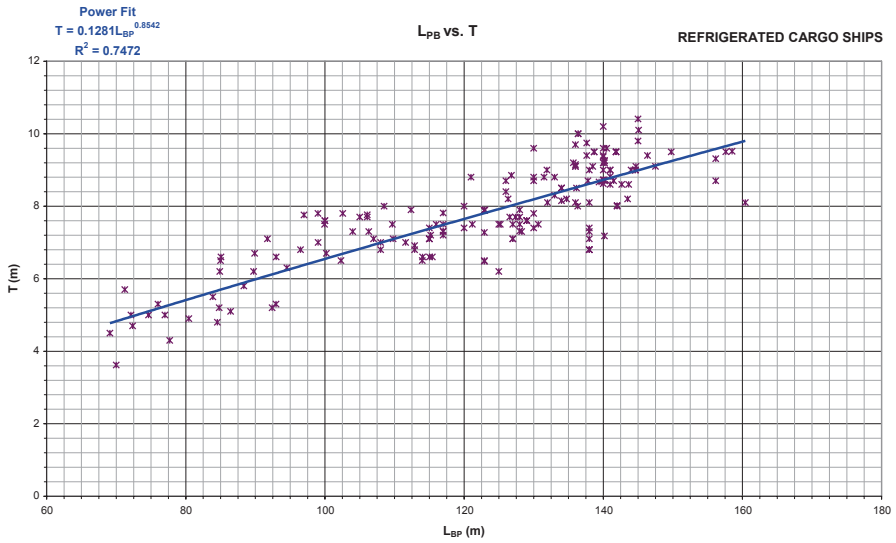

Fig. A.123 Regression analysis of the draft T [m] versus the length between perpendiculars L_{BP} [m] for reefer ships (Kalokairinos et al. 2000–2005)

Passenger/Cruise Ships (Figs. A.124, A.125, A.126, A.127, A.128, A.129 and A.130)

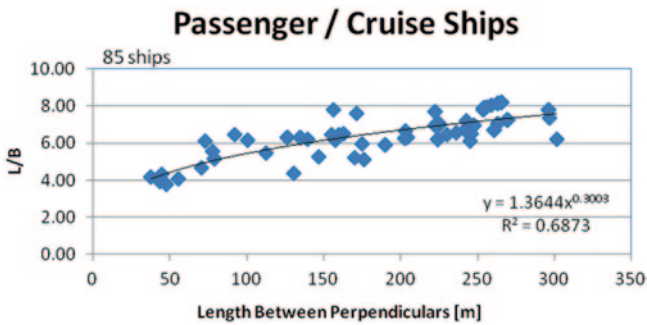

Fig. A.124 Regression analysis of the L/B versus the length between perpendiculars L_{BP} [m] for cruise ships (IHS Fairplay 2011)

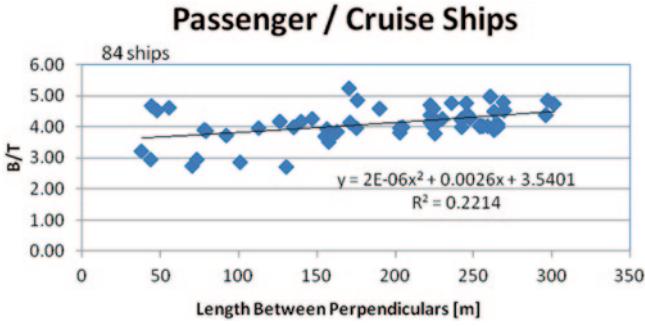

Fig. A.125 Regression analysis of the B/T versus the length between perpendiculars L_{BP} [m] for cruise ships (IHS Fairplay 2011)

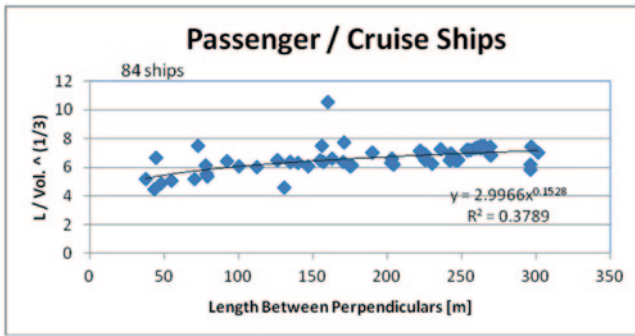

Fig. A.126 Regression analysis of the $L/V^{1/3}$ versus the length between perpendiculars L_{BP} [m] for cruise ships (IHS Fairplay 2011)

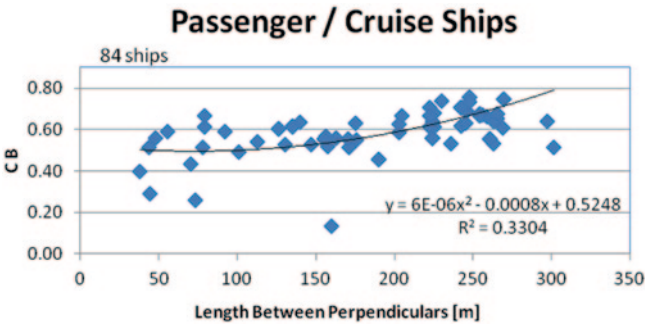

Fig. A.127 Regression analysis of C_B versus the length between perpendiculars L_{BP} [m] for cruise ships (IHS Fairplay 2011)

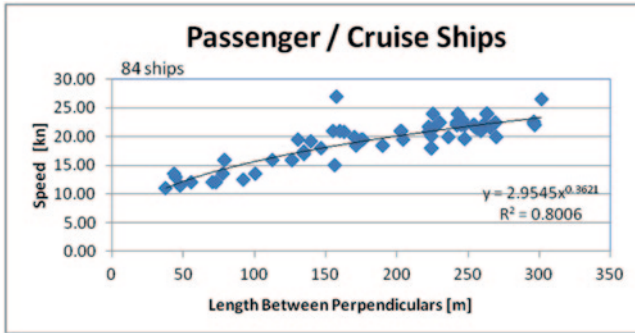

Fig. A.128 Regression analysis of the speed versus the length between perpendiculars L_{BP} [m] for cruise ships (IHS Fairplay 2011)

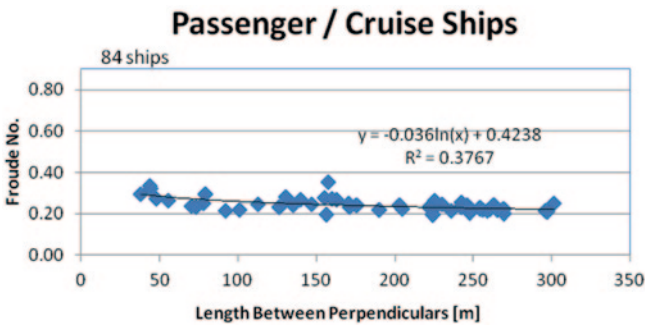

Fig. A.129 Regression analysis of the Froude No. versus the length between perpendiculars L_{BP} [m] for cruise ships (IHS Fairplay 2011)

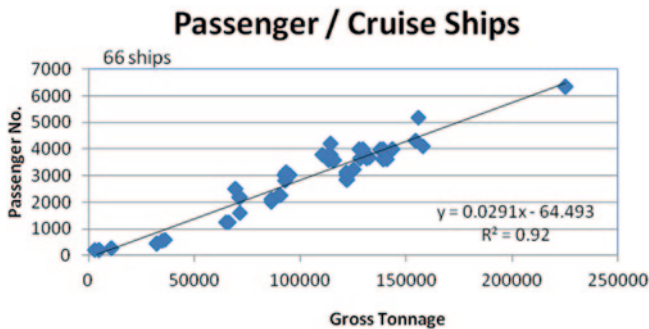

Fig. A.130 Regression analysis of the no. of passengers versus GT for cruise ships

Offshore Tug/Supply Ships (Figs. A.131, A.132, A.133, A.134, A.135, A.136, A.137, A.138 and A.139)

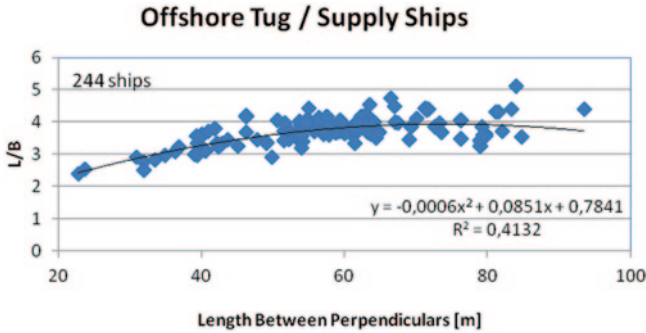

Fig. A.131 Regression analysis of the L/B ratio versus the length between perpendiculars L_{BP} [m] for offshore tug/supply ships (IHS Fairplay 2011)

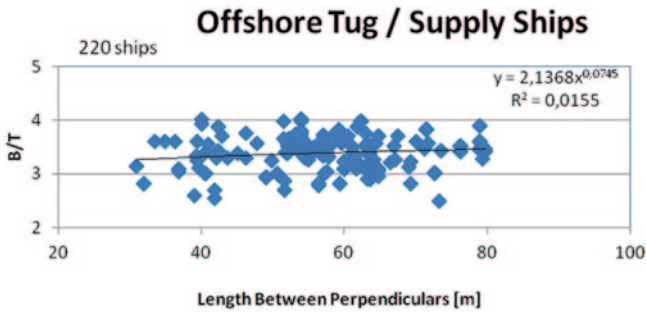

Fig. A.132 Regression analysis of the B/T ratio versus the length between perpendiculars L_{BP} [m] for offshore tug/supply ships (IHS Fairplay 2011)

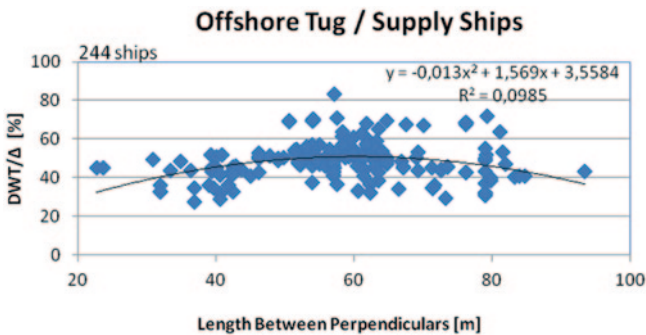

Fig. A.133 Regression analysis of the % DWT/Displacement ratio versus the length between perpendiculars L_{BP} [m] for offshore tug/supply ships (IHS Fairplay 2011)

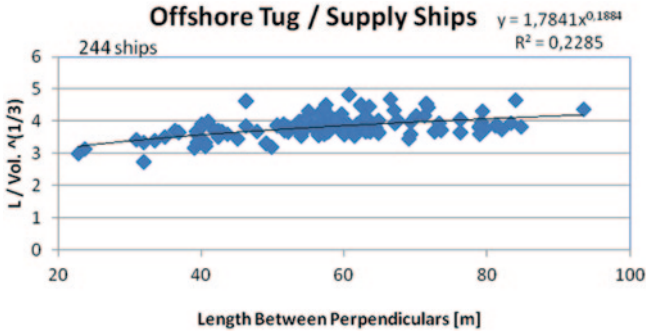

Fig. A.134 Regression analysis of the $L/V^{1/3}$ ratio versus the length between perpendiculars L_{BP} [m] for Offshore Tug/Supply Ships (IHS Fairplay 2011)

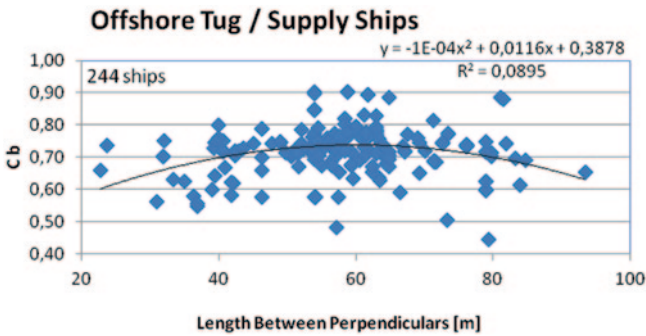

Fig. A.135 Regression analysis of the C_B versus the length between perpendiculars L_{BP} [m] for offshore tug/supply ships (IHS Fairplay 2011)

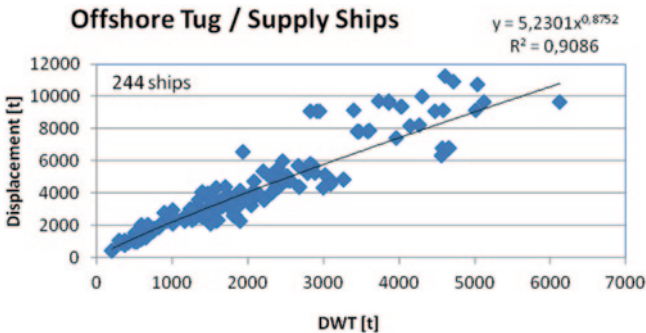

Fig. A.136 Regression analysis of the displacement [t] versus the DWT [t] for offshore tug/supply ships (IHS Fairplay 2011)

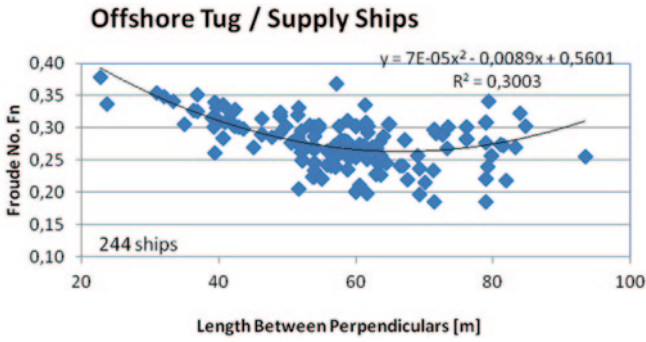

Fig. A.137 Regression analysis of the Froude No. versus the length between perpendiculars L_{BP} [m] for offshore tug/supply ships (IHS Fairplay 2011)

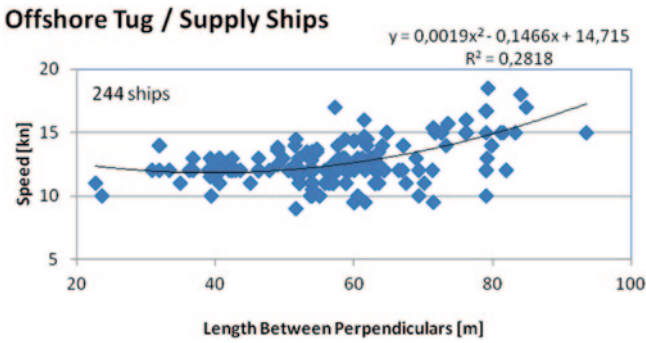

Fig. A.138 Regression analysis of the speed [kn] versus the length between perpendiculars L_{BP} [m] for offshore tug/supply ships (IHS Fairplay 2011)

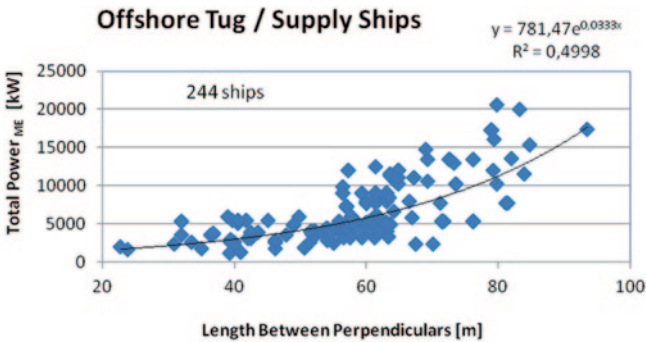

Fig. A.139 Regression analysis of the main engine total power [kW] versus the length between perpendiculars L_{BP} [m] for offshore tug/supply ships (IHS Fairplay 2011)

Fishing Vessels (Figs. A.140, A.141, A.142, A.143, A.144, A.145, A.146, A.147, A.148, A.149, A.150, A.151, A.152, A.153 and A.154)

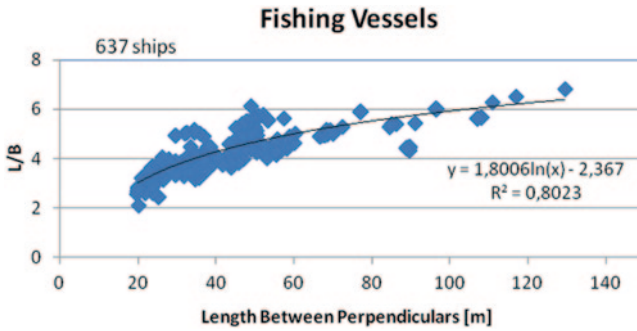

Fig. A.140 Regression analysis of the L/B ratio versus the length between perpendiculars L_{BP} [m] for fishing vessels (IHS Fairplay 2011)

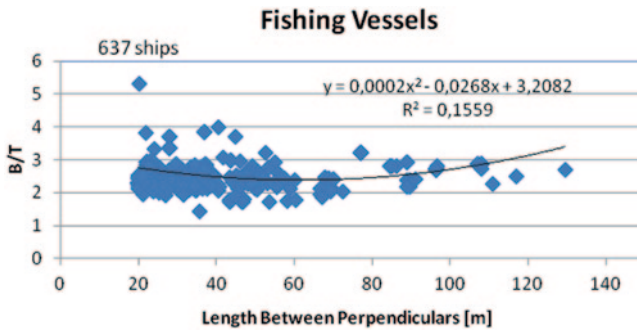

Fig. A.141 Regression analysis of the B/T ratio versus the length between perpendiculars L_{BP} [m] for fishing vessels (IHS Fairplay 2011)

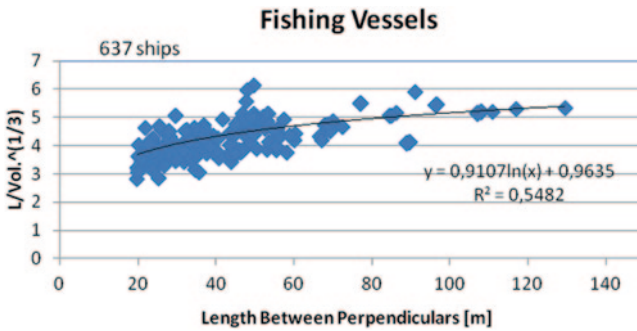

Fig. A.142 Regression analysis of the $L/V^{1/3}$ ratio versus the length between perpendiculars L_{BP} [m] for fishing vessels (IHS Fairplay 2011)

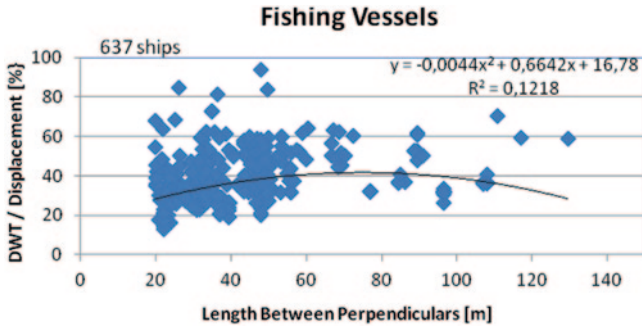

Fig. A.143 Regression analysis of the % DWT/Displacement ratio versus the length between perpendiculars L_{BP} [m] for fishing vessels (IHS Fairplay 2011)

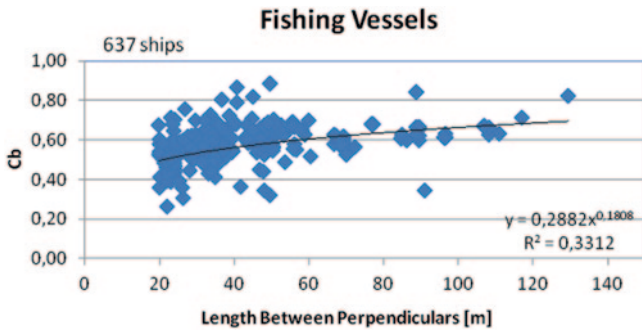

Fig. A.144 Regression analysis of the C_B versus the length between perpendiculars L_{BP} [m] for fishing vessels (IHS Fairplay 2011)

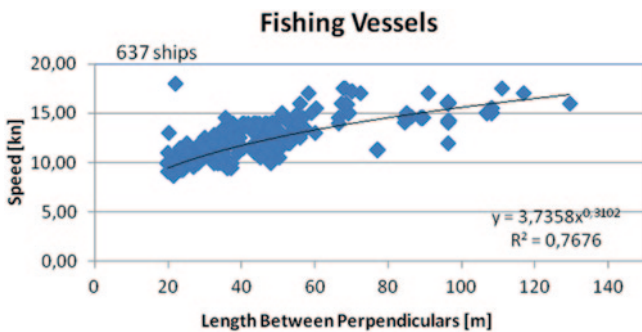

Fig. A.145 Regression analysis of the speed [kn] versus the length between perpendiculars L_{BP} [m] for fishing vessels (IHS Fairplay 2011)

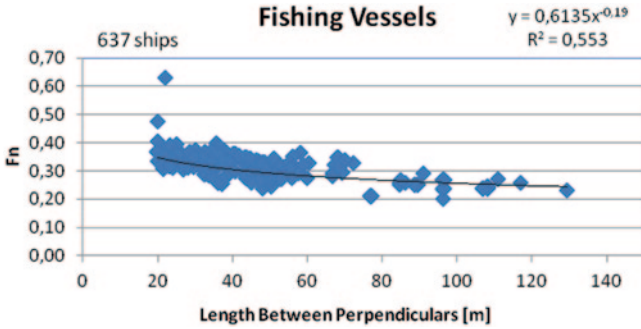

Fig. A.146 Regression analysis of the Froude No. versus the length between perpendiculars L_{BP} [m] for fishing vessels (IHS Fairplay 2011)

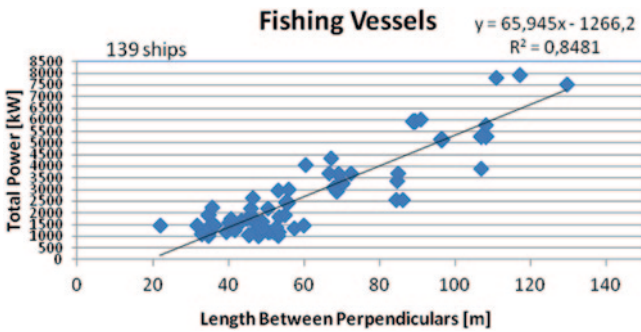

Fig. A.147 Regression analysis of the main engine total power [kW] versus the length between perpendiculars L_{BP} [m] for fishing vessels (IHS Fairplay 2011)

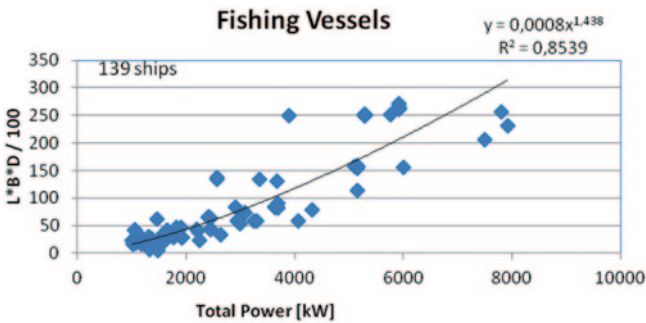

Fig. A.148 Regression analysis of the LBD/100 versus the main engine total power [kW] for fishing vessels (IHS Fairplay 2011)

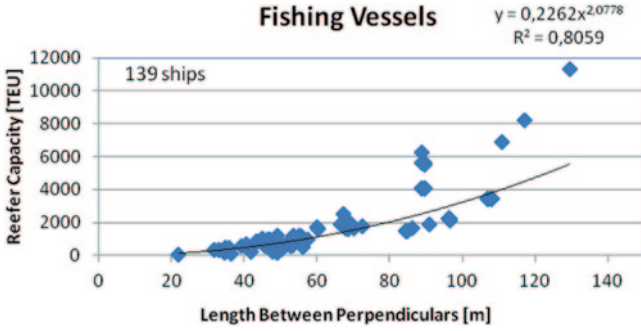

Fig. A.149 Regression analysis of the reeper capacity [TEU] versus the length between perpendiculars L_{BP} [m] for fishing vessels (IHS Fairplay 2011)

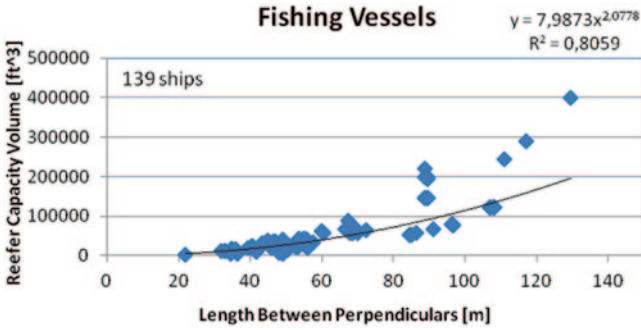

Fig. A.150 Regression analysis of the reeper capacity volume [ft³] versus the length between perpendiculars L_{BP} [m] for fishing vessels (IHS Fairplay 2011)

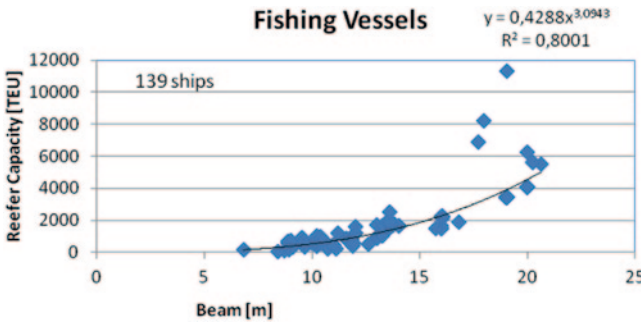

Fig. A.151 Regression analysis of the reeper capacity [TEU] versus beam B [m] for fishing vessels (IHS Fairplay 2011)

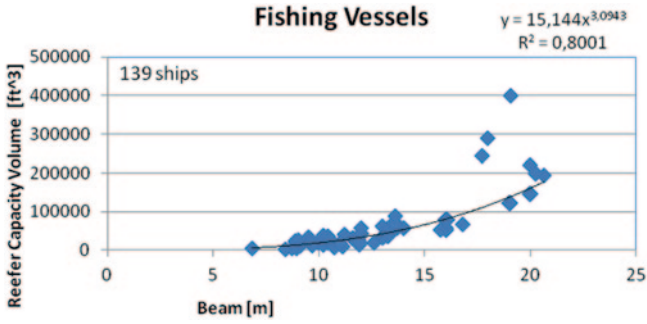

Fig. A.152 Regression analysis of the reeper capacity volume [ft³] versus the beam B [m] for fishing vessels (IHS Fairplay 2011)

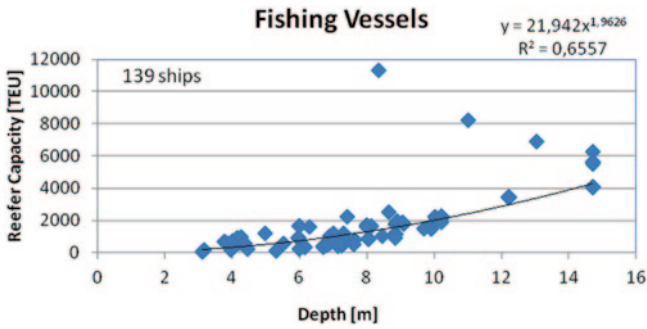

Fig. A.153 Regression analysis of the reeper capacity [TEU] versus the depth D [m] for fishing vessels (IHS Fairplay 2011)

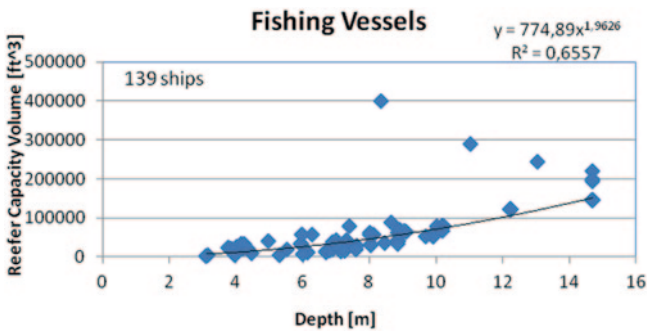

Fig. A.154 Regression analysis of the reeper capacity volume [ft³] versus the depth D [m] for fishing vessels (IHS Fairplay 2011)

References

1. IHS Fairplay World Shipping Encyclopedia version 12.01 (2011) <http://www.ihs.com/products/maritime-information/ships/world-shipping-encyclopedia.aspx>
2. Kalokairinos, E., Mavroeidis, T., Radou, G., Zachariou, Z. (2000–2005) Regression analysis of basic ship design values for merchant ships, Diploma Theses, National Technical University of Athens

Appendix B: Systematic Hull Form—Model Series

Abstract: The shape of the sectional area curve and/or the ship lines can be deduced from similar/parent ships and/or systematic hull form series of ship models, which resulted from systematic research of renowned ship hydrodynamics laboratories/towing tanks. Such ship model series, for which also experimental data of the residuary resistance exist (in certain cases, also, of additional hydrodynamic data, like seakeeping and maneuvering data) are generally known:

- The Wageningen-Lap series (The Netherlands)
- The David Taylor Model basin (DTMB) Standard Series 60 (USA)
- The FORMDATA series (Denmark)

Which are described in the following paragraphs. Despite the fact that the above hull form series are outdated, they still form the foundations of ship hull form design after WWII and are used in naval architectural education and practice until today.

Introduction: Among all known systematic, ship hull form series, which are in the public domain, the FORMDATA series is the most complete and modern one, though this was created back in the 1960s; it leads to hull forms with satisfactory or even absolutely good hydrodynamic performance; however, this has been already superseded by more modern hull forms in recent years (which are not in the public domain), as a result of hull form optimization with CFD tools and accumulated experience of ship model experiments.

Other known standard hull form series, for which a detailed description is herein omitted, are (the following list is not exhaustive):

- The Taylor-Gertler series (DTMB–USA, 1910–1954, for relatively sharp/fine hulls, $C_p = 0.48 \sim 0.80$)
- The BSRA series (NPL-U.K., early 1954, $C_B = 0.55 \sim 0.85$)
- The SSPA cargo ship series (Goeteborg-Sweden, early 1956, for cargo ships, $C_B = 0.525 \sim 0.750$)
- The NPL coasters series (U.K.-Dawson 1954–1959, $C_B = 0.65, 0.70$) for small short-sea cargo ships (coasters)
- The SSPA coasters series (Sweden-Warholm/Lindgren 1953–1955, $C_B = 0.60–0.70$) for small short-sea cargo ships (coasters)
- The SRI series (Japan–Tsuchida et al. $C_B = 0.77–0.84$), for tankers and bulk-carriers
- The NPL fishing vessels series (U.K.–Doust-O’Brien 1959, $C_p = 0.60–0.70$), for fishing ships/open-sea trawlers
- The series of Stevens Inst. (USA, Roach, 1954, $C_B = 0.458–0.560$), for open-sea tug boats
- Various series of high-speed craft
 - Royal Inst. of Technology (Sweden, Nordstrom, 1951),
 - Duisburg (W. Germany, Graff/Sturtzel, 1958),
 - DTMB Series 64 (USA, Yeh, 1965)
 - NPL round bilge displacement series (UK, Bailey, 1976)
 - MARIN high speed displacement hull series (Netherlands, Blok and Beukelmann, 1984)

- NSMB high speed displacement hull series (Netherlands, Oossanen, 1985)
- Laboratory of Ship and Marine Hydrodynamics—NTUA double chine series (Greece, NTUA-LSMH, Loukakis/Grigoropoulos)
- The series of fishing vessels of the towing tank of Potsdam, Berlin (medium and coastal fisheries) (Henschke 1964).
- The Ridgely–Nevitt trawler series (1963)
- The MARAD series (USA, Roseman, 1987 $C_B = 0.800\text{--}0.875$, $L/B = 4.5\text{--}6$, $5, B/T = 3.00$ to 3.75), for bulky ships, tankers and bulk-carriers.

More information about the aforementioned and other model series are given in Krappinger (1963), Henschke (1964), Roseman (1987), and more recently in Moland, Turnock, Hudson (2011).

Wageningen-Lap Series

Reference

- W. Lap, Journal of Int. Shipbuilding Progress, 1954
- Auf'm Keller, Journal of Int. Shipbuilding Progress, 1973

Application Procedure

1. We assume that the displacement and the prismatic coefficient C_p are pre-determined.
2. Based on the C_p and the specified speed (F_n number), the desired longitudinal position of the center of buoyancy LCB can be estimated (see Sect. 3.1.1).
3. With the position of LCB determined, the category of the ship according to *W. Lap* (categories A to E for single-screw ships, D to H for twin-screw ships, see Fig. B.1), is estimated, based on the given value of C_p .
4. Based on the selected ship category (linear interpolation allowed), and the given C_p , the prismatic coefficient of entrance C_{PE} and run C_{PR} are found from Fig. B.2.
5. With the coefficients C_{PE} and C_{PR} determined, the areas of section 0 (aft perpendicular) and up to section 19, are given in Figs. B.3 and B.4 as percentages of the area of midship section A_M , thus, the lengthwise displacement distribution is determined.

Notes The prismatic coefficients of entrance and run are defined as following:

$$C_{PE} = \frac{\nabla_E}{A_M \cdot L_E} \quad C_{PR} = \frac{\nabla_R}{A_M \cdot L_R}$$

where $\nabla_E, L_E, \nabla_R, L_R$: displaced volumes and corresponding lengths of entrance/run of the sectional area curve.

The Lap series is valid for $C_p = 0.60 \sim 0.80$ (0.85).

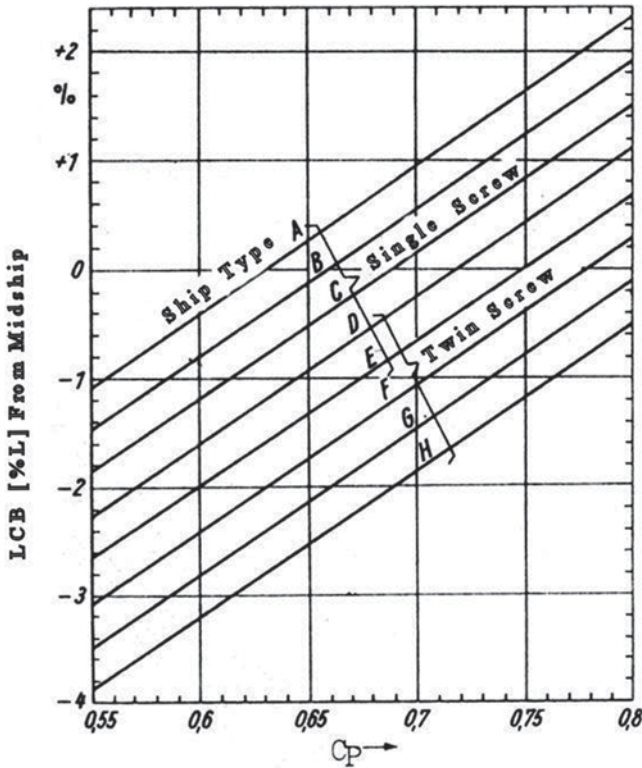

Fig. B.1 Longitudinal position of center of buoyancy LCB according to W. Lap (Henschke 1964)

Series 60 Hull Form—Todd et al.

Bibliography

- F. H. Todd, G. R. Struntz, P. C. Pien, Trans. SNAME 1957.

Application Procedure

The procedure is similar to that followed for the Wageningen series of W. Lap. Attention is drawn to the following:

1. The prismatic coefficients of entrance C_{pE} and run C_{pR} are selected as functions of LCB and C_B from Fig. B.5.
2. The length of entrance L_E , of parallel body L_p (thus: $L_R = L - L_p - L_E$) and the curvature radius of midship section, are selected from Figs. B.6 and B.7.

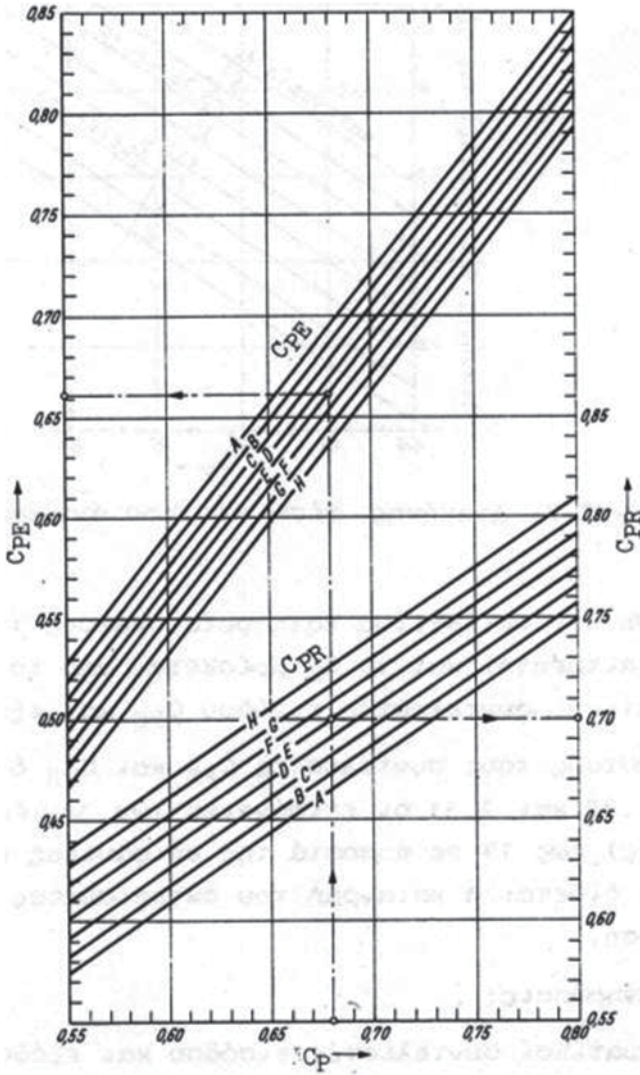

Fig. B.2 Prismatic coefficient of entrance C_{PE} and exit C_{PR} according to W. Lap (Henschke 1964)

3. For the selected prismatic coefficients C_{PE} and C_{PR} , the sectional areas, as percentages of A_M , are selected from Figs. B.8 (fore-body) and B.9 (aft-body). Attention is drawn to the method of measuring the sections according to US convention (section 0: is at the forward perpendicular, section 20: is at the after perpendicular).

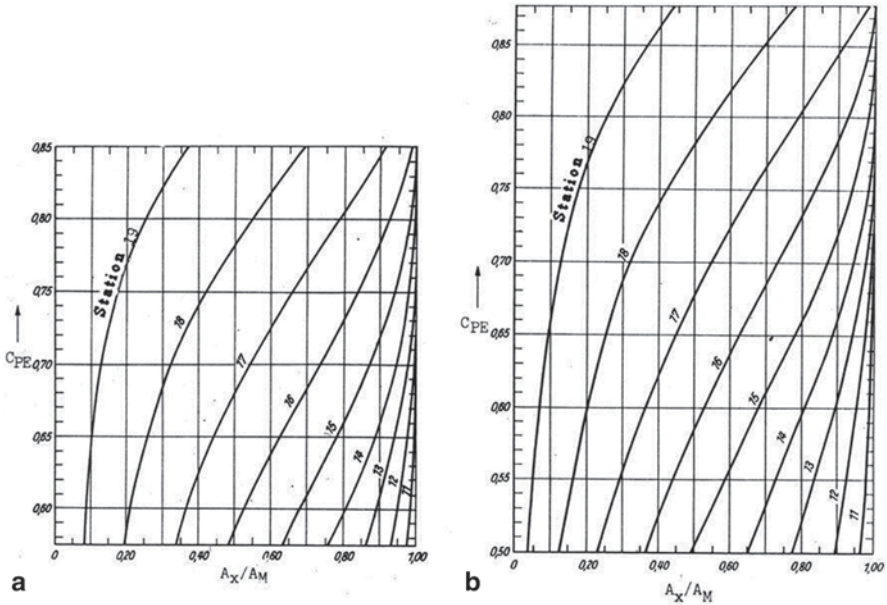

Fig. B.3 Percentage distribution of sectional areas of fore-body according to W. Lap (Henschke 1964). **a** For single-screw ships. **b** For twin-screw ships

Notes

- The series of LAP and Series 60 may be applied independently to cases of forward/aft prismatic coefficients, which are different from the recommended ones. In that case, a shift of the recommended center of buoyancy of the hull results. Of course, in that case, the use of experimental results of the residuary resistance of the corresponding series are less accurate.
- The use of fore/aft body block coefficient C_B , in the course of determining the displacement distribution, is proposed by Schneekluth [17], which is independent of the C_{PE} and C_{PR} values, as they result from the series of LAP and Series 60. Thus, we obtain:

$$C_B = 0.5 \cdot (C_{BF} + C_{BA})$$

where

$$C_{BF} = \frac{\nabla_F}{0.5 \cdot A_M \cdot L_{pp}} \quad C_{BA} = \frac{\nabla_A}{0.5 \cdot A_M \cdot L_{pp}}$$

and

$$C_{BF} = C_B + a, \quad C_{BA} = C_B - a,$$

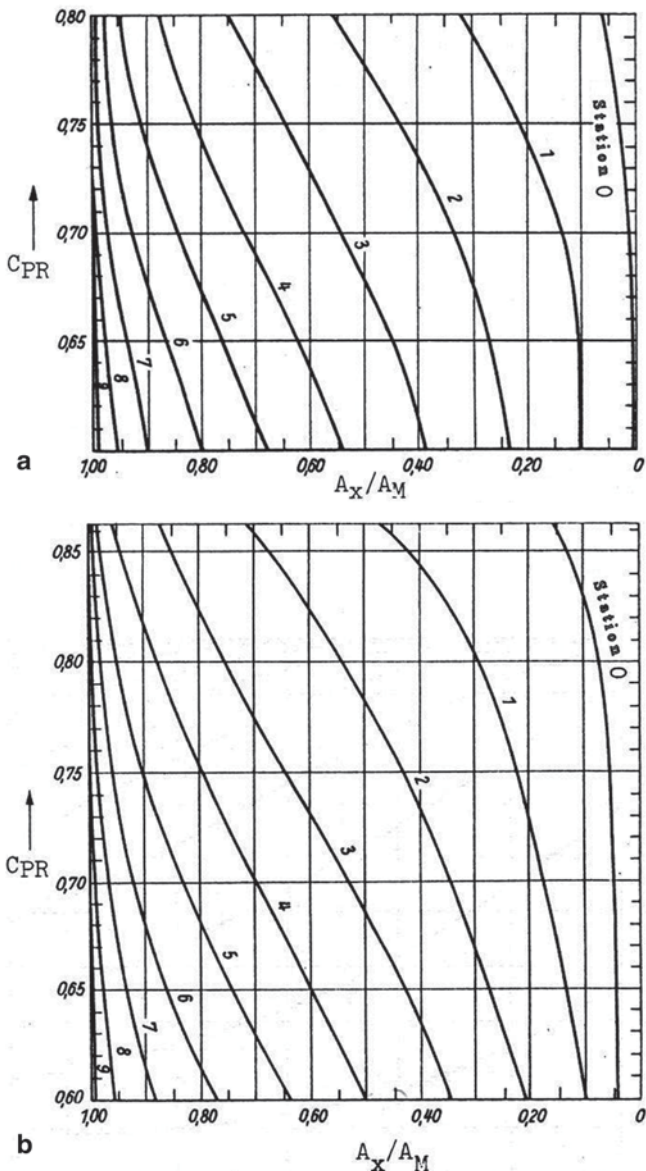

Fig. B.4 Percentage distribution of sectional areas of aft-body according to W. Lap (Henschke 1694). **a** For single-screw ships. **b** For twin-screw ships

where $a = 0.0211 + (LCB/44) - 0.027 C_B$, with LCB: longitudinal position of center of buoyancy [%] L_{pp}

The above formula is valid for merchant ships, with $C_M \geq 0.94$, without bulbous bow.

Fig. B.5 $C_{PE}/C_{PR} = f(LCB/L_{pp}, C_B)$, Series 60

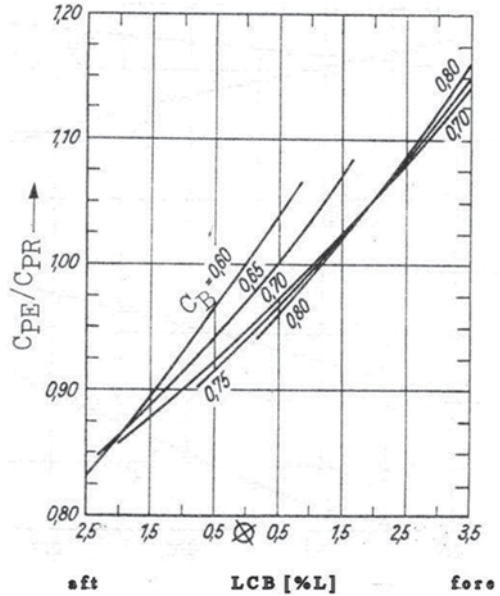
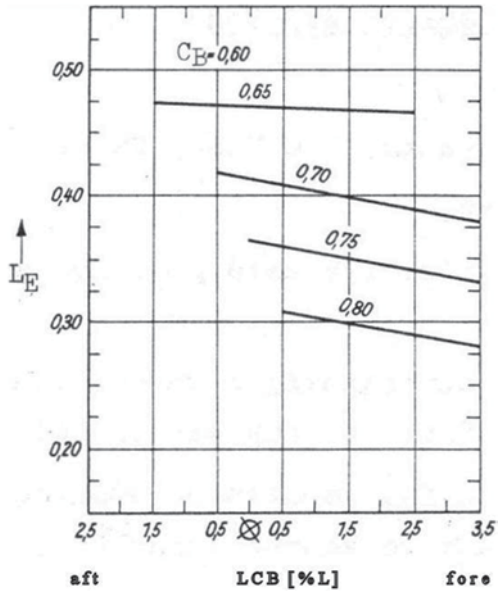

Fig. B.6 $L_E = f(LCB/L_{pp}, C_B)$, Series 60



For ships with C_M independently of the above formula constraint, the following holds

$$a = C_M \cdot (LCB + 0.89) / 43 - 0.027C_B$$

The existence of bulbous bow can be accounted for by balancing the resulting moment exerted by the bulbous bow volume about the midship section.

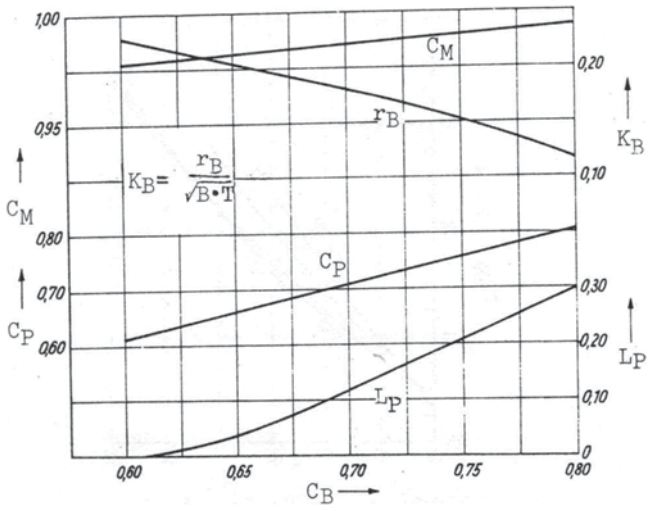

Fig. B.7 $L_P, C_M, K_B = f(C_B)$, Series 60

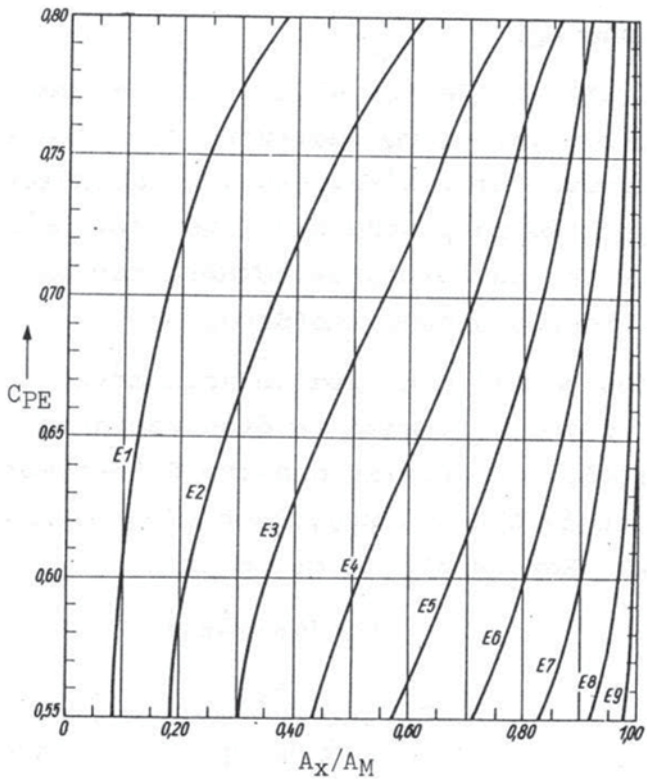

Fig. B.8 Distribution of areas of fore-body sections $A_X = f(C_{PE})$, Series 60

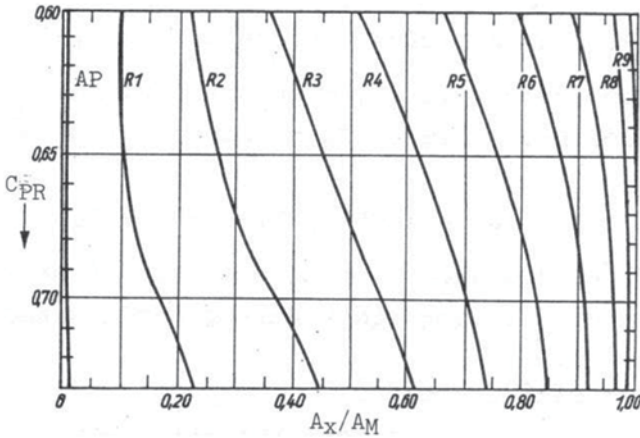

Fig. B.9 Distribution of areas of aft-body sections $A_x=f(C_{PR})$, Series 60

FORMDATA Series

The systematic series of FORMDATA of the Technical University, Denmark, Lyngby (Copenhagen—Denmark) is still considered today as the most complete of the public domain series and responds well to the hull form requirements of modern merchant ships. It has been developed based on the systematic analysis of the geometric data of series of existing ships of the 60ties and of earlier systematic series, considering, also, their calm water hydrodynamics (resistance).

The FORMDATA series provides data both for the determination of the hydrostatic/stability characteristics of the ship during the preliminary design stage, before finalizing the ship lines, and for the required propulsive power (see, Guldhammer and Harvald 1974).

In contrast to the previously elaborated series of Lap and Series 60, the present systematic series provides in a systematic way the *ordinates of sections (offsets) in dimensionless percentages of the beam and of the reference draft*; that is, there is no need to develop the ship sections on the basis of determined sectional areas, but their form is given in proper scale; this greatly reduces the effort spent for the drafting of the ship lines.

Characteristics of the FORMDATA series

1. It refers to ships with vertical sides at the midship section. The recommended midship section coefficients ($C_M=0.74\sim 0.995$) are shown in the following figure and are arranged according to the numbers 1 to 6 (Fig. B.10).
2. Three basic section forms are offered: sections of strong U character (full lines of U shape), V type sections (shape V) and N type sections (normal sections, without pronounced character).

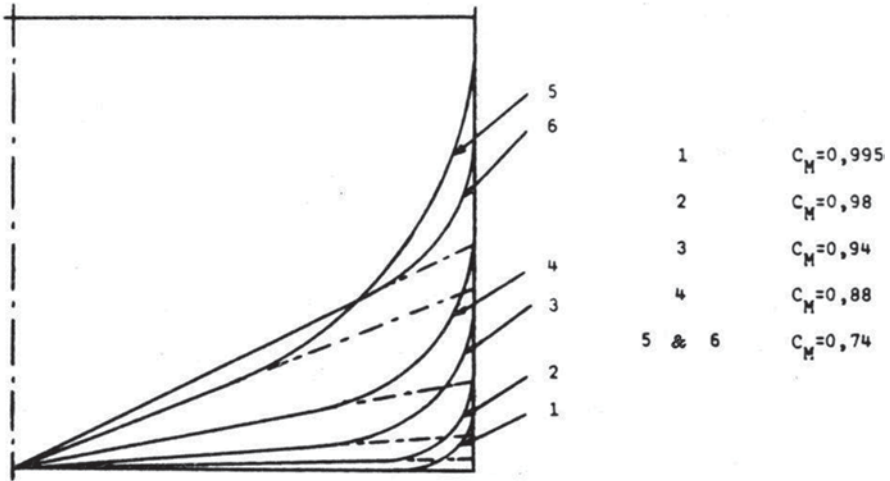

Fig. B.10 Corresponding code number of midship section coefficient C_M

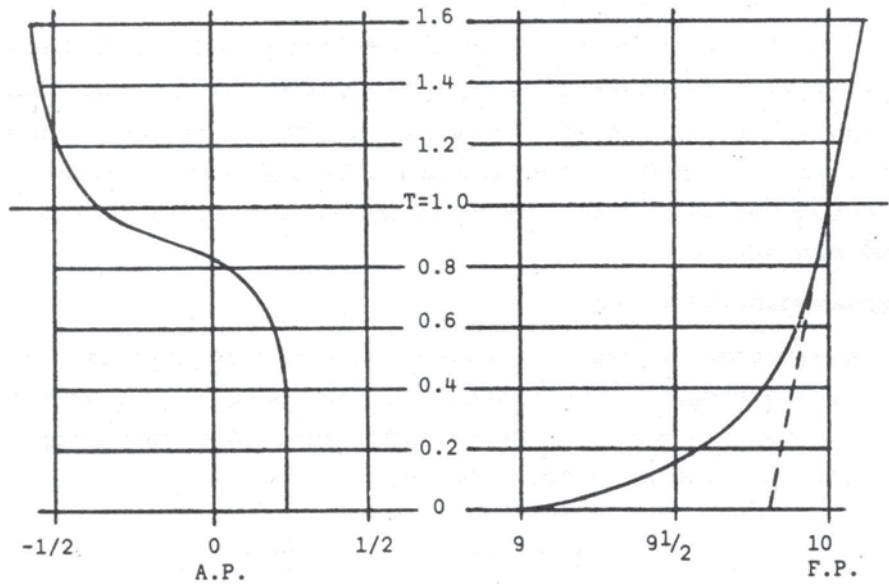

Fig. B.11 a Profile of conventional cruiser stern associated to U, N, V sectional forms. b Profile of conventional bow associated to U, N, V forms

3. The above U, V and N sections are combined with two sets of stern A (aft) and bow F (forward) sections.
4. The configuration of the bow and stern is in principle possible in conventional manner (U, V and N forms) (see Fig. B.11). Also, various types of bulbous bow

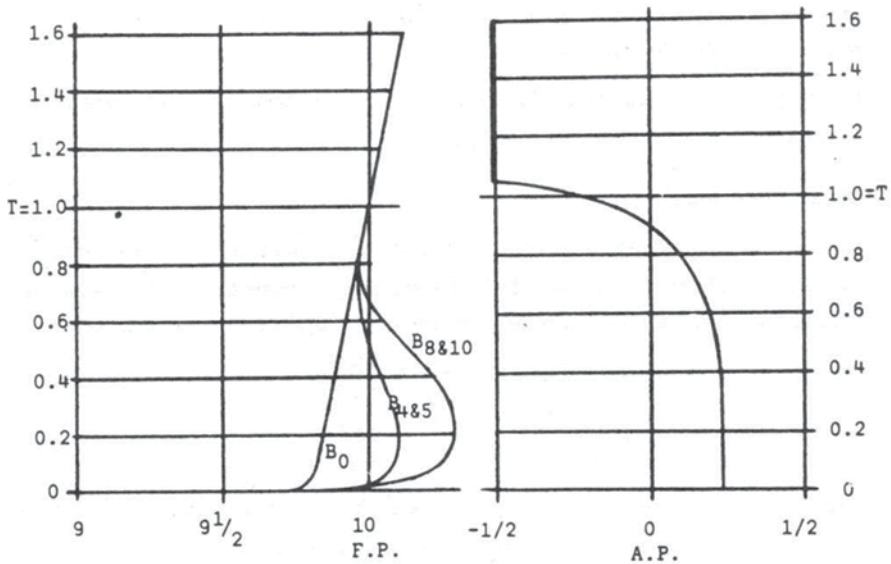

Fig. B.12 a Profile of bow forms B (bulbous bow). b Profile of stern forms C (transom stern)

(symbol B), transom stern (symbol C¹), or conventional cruiser stern (symbol: T), are offered (see Fig. B.12).

- Every set of the given curves is encoded by a combination of symbols and numbers, consisting of three characters, and sometimes in addition with one index, e.g. U2 F, B₀1 F, T_B2A.

Explanations

- The first character of section's symbol: it refers to the type of sections, of bow (U, N, V) and stern (C, T).
- The second character (number): refers to the corresponding C_M (see Fig. B.10).
- Occasional index (number 0, 4, 5, 8, 10 to the character B) denotes the ratio of bulbous area at F.P. to the area A_M .
- Occasional index (symbol of A, B, C, D to the letter C): denotes the relative slope of the transom stern against the vertical position (index D).
- The third character (symbol A or F): is a reference to the aft- or fore-body of the vessel.

¹ The symbols C (transom stern) and T (cruiser stern) can be easily mistaken and applied just the other way around, namely C for cruiser stern and T for transom stern. However, here the original definition by *Guldhammer*, who refers to the cruiser stern as that for tankers and hence this symbol T is maintained.

Application Procedure

- Selection of the fore and aft-body block coefficients based on the known C_B and LCB (longitudinal distance of the center of buoyancy from the middle section, + means abaft of midship).

$$C_{BF} = C_B (1.003 - 3.5 LCB/L_{pp})$$

$$C_{BA} = C_B (0.997 + 3.5 LCB/L_{pp})$$

Based on the coefficients C_{BF} and C_{BA} , it is possible to select a combination of the character of the fore-body and aft-body sections. In the following Tables B.1 and B.2, the feasible fore-body forms are indicated in the first row, in the second row the corresponding values of C_{BF} , while in the first column the possible aft-body forms are listed with the corresponding coefficients C_{BA} . The values shown in the table, which cross-connecting possible combinations of fore- and aft-body, concern the limits of variation of C_B (first row) and of LCB (% L_{pp} -second row).
- Typical set of curves of the FORMDATA series for various combinations of C_M , C_B , type of sections and the bow/stern, are given in the following figures. The complete set of FORMDATA curves is given in the following reference: H. E. Guldhammer, FORMDATA I–V, Danish Technical Press, 1962 (FORMDATA I: various forms), 1963 (FORMDATA II: full and fine ships), 1967 (FORMDATA III: tanker and bulbous bow ships), 1969 (FORMDATA IV: fishing boats series).
- Limits of application of the series (Figs. B.13, B.14, B.15, B.16, B.17, B.18, B.19, B.20, B.21, B.22, B.23, B.24, B.25, B.26, B.27 and B.28):

$$C_B = 0.50-0.850$$

$$C_M = 0.74-0.995$$

$$C_{wp} = 0.50-0.950$$

Table B.1 Combinations of cruiser stem and bulbous bow of the FORMDATA series according to Guldhammer

| SECTIONS SERIES | C_{BF} C_{BA} | B_0 1F | B_5 1F | B_{10} 1F | B_0 2F | B_4 2F | B_8 2F | B_0 3F | B_4 3F | B_8 3F |
|-----------------|----------------------|--------------------------------------|--------------------------------------|--------------------------------------|--------------------------------------|--------------------------------------|--------------------------------------|--------------------------------------|--------------------------------------|--------------------------------------|
| T1A | $0.70 - 0.85$ | $0.70 - 0.90$ | $0.70 - 0.90$ | $0.70 - 0.85$ $(-4.50) - (+3.52)$ | $0.50 - 0.75$ | $0.50 - 0.75$ | $0.50 - 0.75$ | $0.50 - 0.70$ | $0.50 - 0.70$ | $0.50 - 0.70$ |
| U1A | $0.70 - 0.80$ | $0.70 - 0.85$ $(-4.50) - (+2.38)$ | $0.70 - 0.85$ $(-4.50) - (+3.52)$ | $0.70 - 0.85$ $(-4.50) - (+2.38)$ | | | | | $C_{B1} / X_{B1} (\%_{LBP})$ | |
| U2A | $0.55 - 0.75$ | | | | $0.53 - 0.75$ $(-4.50) - (+5.10)$ | $0.53 - 0.75$ $(-4.50) - (+5.10)$ | $0.53 - 0.75$ $(-4.50) - (+5.10)$ | | | |
| N2A | $0.55 - 0.75$ | | | | $0.53 - 0.75$ $(-4.50) - (+5.10)$ | $0.53 - 0.75$ $(-4.50) - (+5.10)$ | $0.53 - 0.75$ $(-4.50) - (+5.10)$ | | | |
| V2A | $0.60 - 0.70$ | | | | $0.55 - 0.73$ $(-3.38) - (+4.92)$ | $0.55 - 0.73$ $(-3.38) - (+4.92)$ | $0.55 - 0.73$ $(-3.38) - (+4.92)$ | | | |
| U3A | $0.50 - 0.70$ | | | | | | | $0.50 - 0.70$ $(-4.64) - (+4.92)$ | $0.50 - 0.70$ $(-4.64) - (+4.92)$ | $0.50 - 0.70$ $(-4.64) - (+4.92)$ |
| N3A | $0.50 - 0.70$ | | | | | | | $0.50 - 0.70$ $(-4.64) - (+4.92)$ | $0.50 - 0.70$ $(-4.64) - (+4.92)$ | $0.50 - 0.70$ $(-4.64) - (+4.92)$ |
| V3A | $0.50 - 0.70$ | | | | | | | $0.50 - 0.70$ $(-4.64) - (+4.92)$ | $0.50 - 0.70$ $(-4.64) - (+4.92)$ | $0.50 - 0.70$ $(-4.64) - (+4.92)$ |

Table B.2 Combinations of cruiser stern and non-bulbous bow of the FORMDATA series according to Gulddammer

| SECTIONS SERIES | C_{BF} | U1F | U2F | N2F | V2F | U3F | N3F | V3F | N4F |
|-----------------|-------------|---|--------------------------------|--------------------------------|--------------------------------|--------------------------------|--------------------------------|--------------------------------|--------------------------------|
| | C_{BA} | | | | | | | | |
| T1A | 0.70 - 0.85 | 0.70 - 0.80 0.70 - 0.83 (-2.20)-(+3.52) | 0.55 - 0.65 | 0.55 - 0.75 | 0.55 - 0.65 | 0.50 - 0.70 | 0.50 - 0.70 | 0.50 - 0.70 | 0.45 - 0.65 |
| U1A | 0.70 - 0.80 | 0.70 - 0.80 (-2.20)-(+2.36) | | | | | | C_{B1}/X_{B1} (% A_{B1}) | |
| U2A | 0.55 - 0.75 | | 0.55 - 0.70 (-2.25)-(+4.80) | | | | | | |
| N2A | 0.55 - 0.75 | | | 0.55 - 0.75 (-4.50)-(+4.80) | | | | | |
| V2A | 0.60 - 0.70 | | | | 0.58 - 0.68 (-1.08)-(+3.68) | | | | |
| U3A | 0.50 - 0.70 | | | | | 0.50 - 0.70 (-4.64)-(+4.92) | | | |
| N3A | 0.50 - 0.70 | | | | | | 0.50 - 0.70 (-4.64)-(+4.92) | | |
| V3A | 0.50 - 0.70 | | | | | | | 0.50 - 0.70 (-4.64)-(+4.92) | |
| N4A | 0.45 - 0.65 | | | | | | | | 0.50 - 0.65 (-4.82)-(+5.10) |

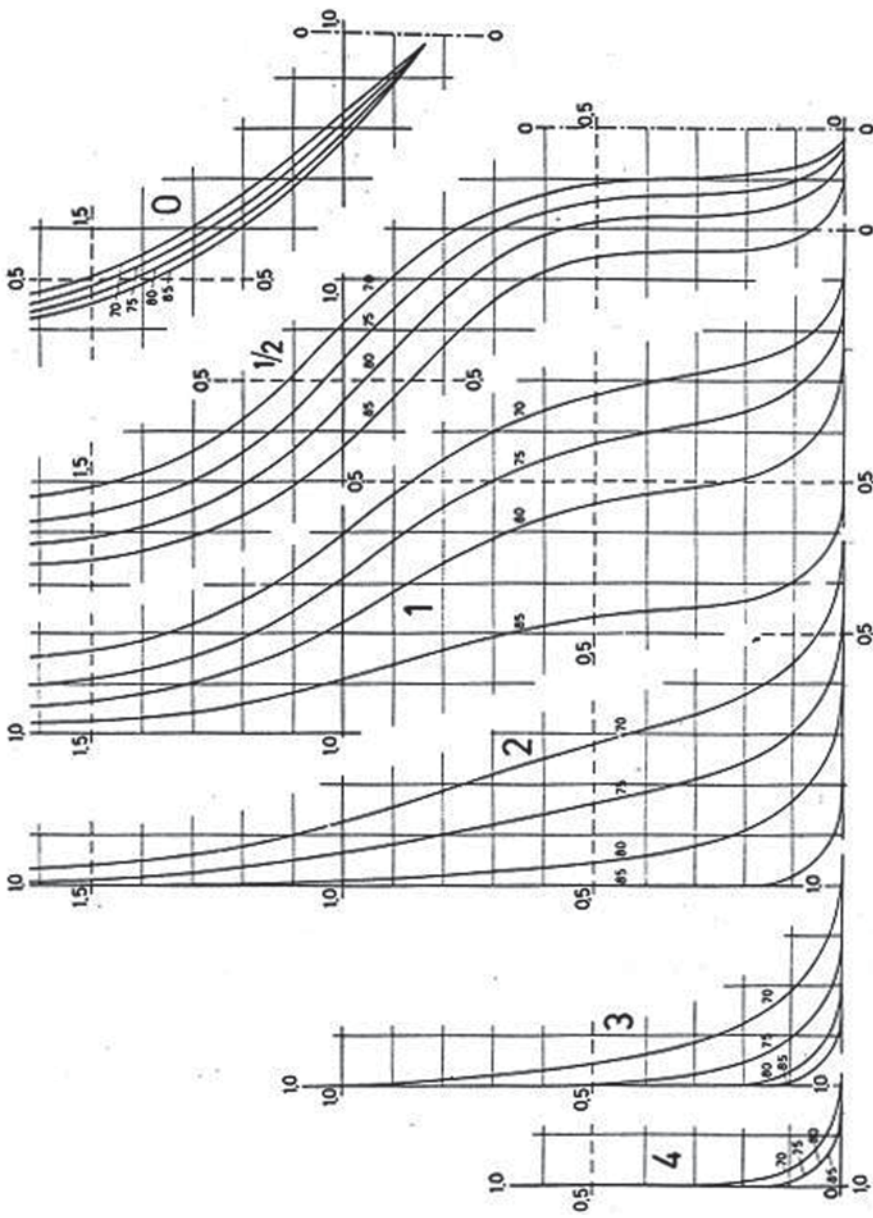

Fig. B.13 Dimensionless sections TIA-FORMDATA for stem section of U type, series of tankers (T: tanker), cruiser $C_M = 0.995$ and $C_{BA} = 0.70 - 0.75 - 0.80 - 0.85$

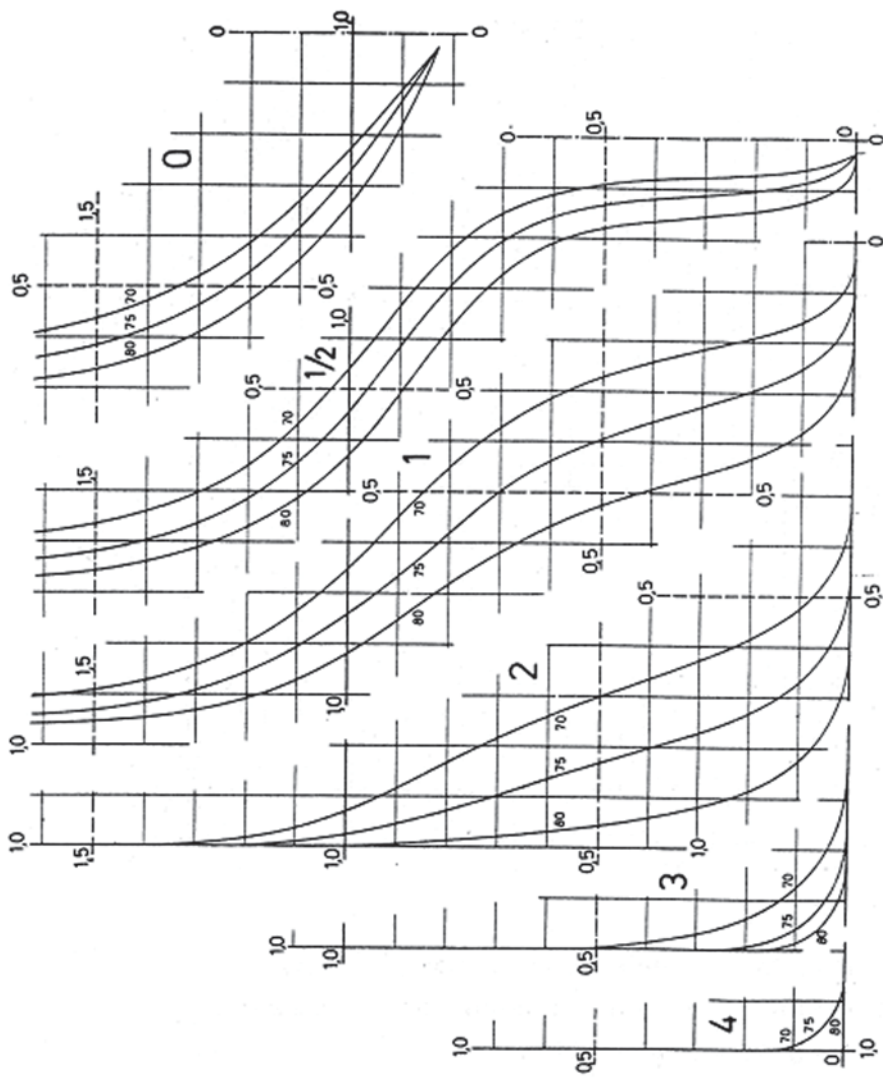

Fig. B.14 Dimensionless sections U1A-FORMDATA for stem section of U type, $C_M = 0.995$ and $C_{BA} = 0.70 - 0.75 - 0.80$

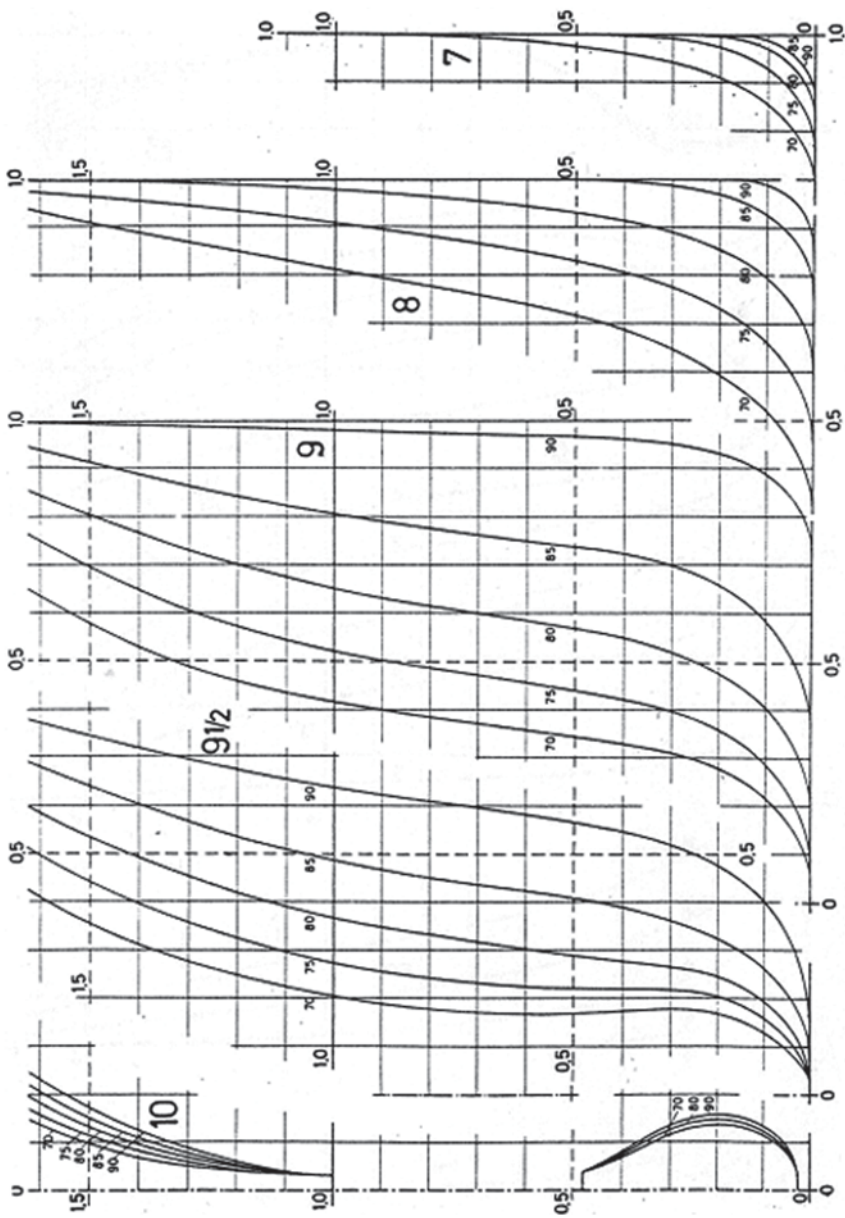

Fig. B.15 Dimensionless sections of B_5 IF-FORMDATA for bulbous bow section, bulb area 5% A_M , $C_M = 0.995$ and $C_{BF} = 0.70 - 0.75 - 0.80 - 0.85 - 0.90$

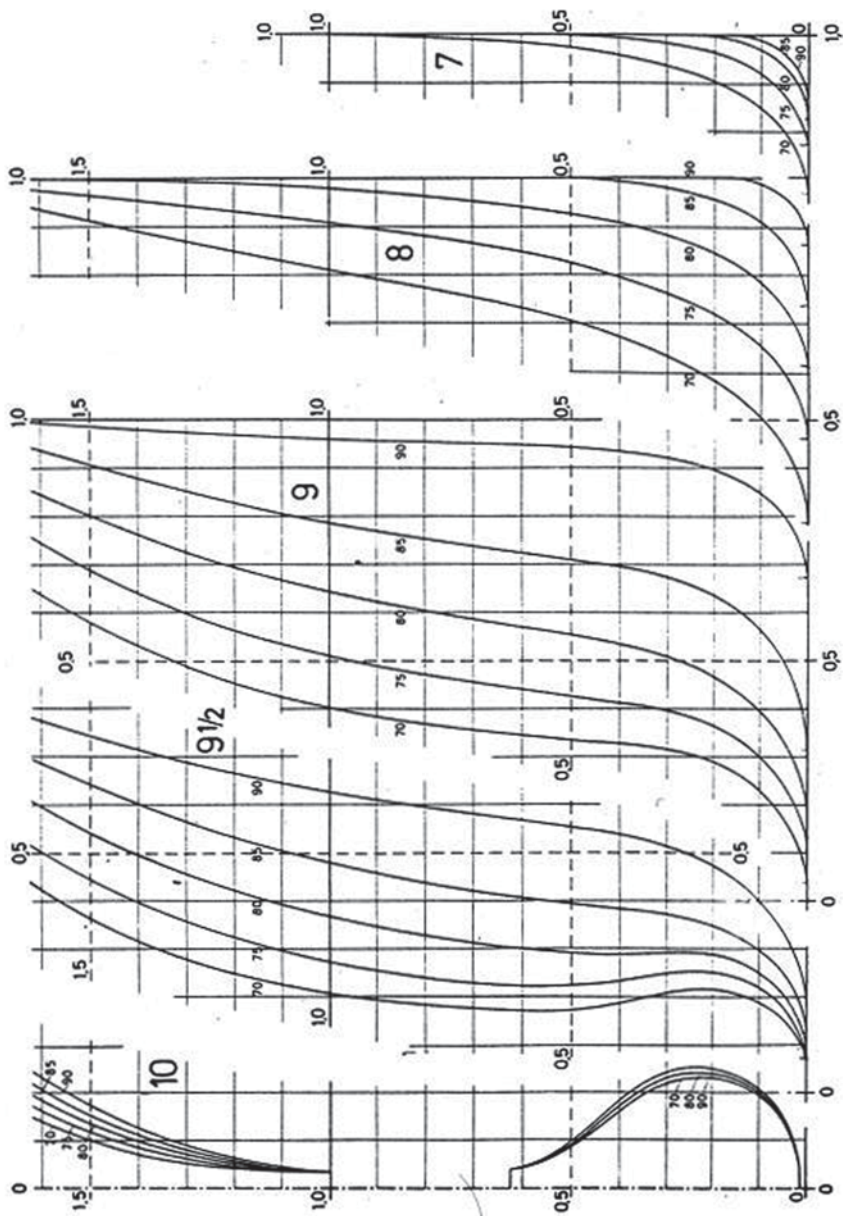

Fig. B.16 Dimensionless sections of B_{10} IF-FORMDATA for bulbous bow section, bulb area 10% A_M , $C_{M1} = 0.995$ and $C_{BF} = 0.70 - 0.75 - 0.8$
 0 - 0.85 - 0.90

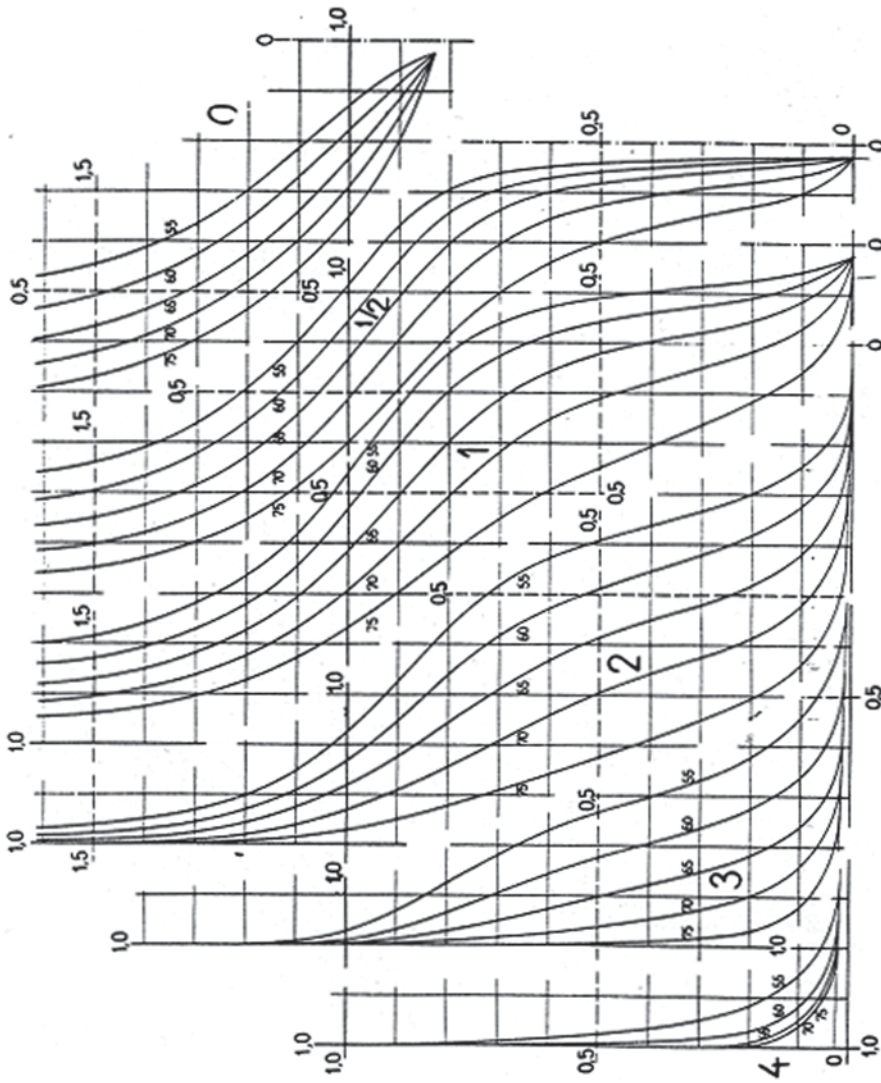

Fig. B.17 Dimensionless sections U2A-FORMDATA for stern section of U type, $C_M = 0.98$ and $C_{BA} = 0.55 - 0.60 - 0.65 - 0.70 - 0.75$

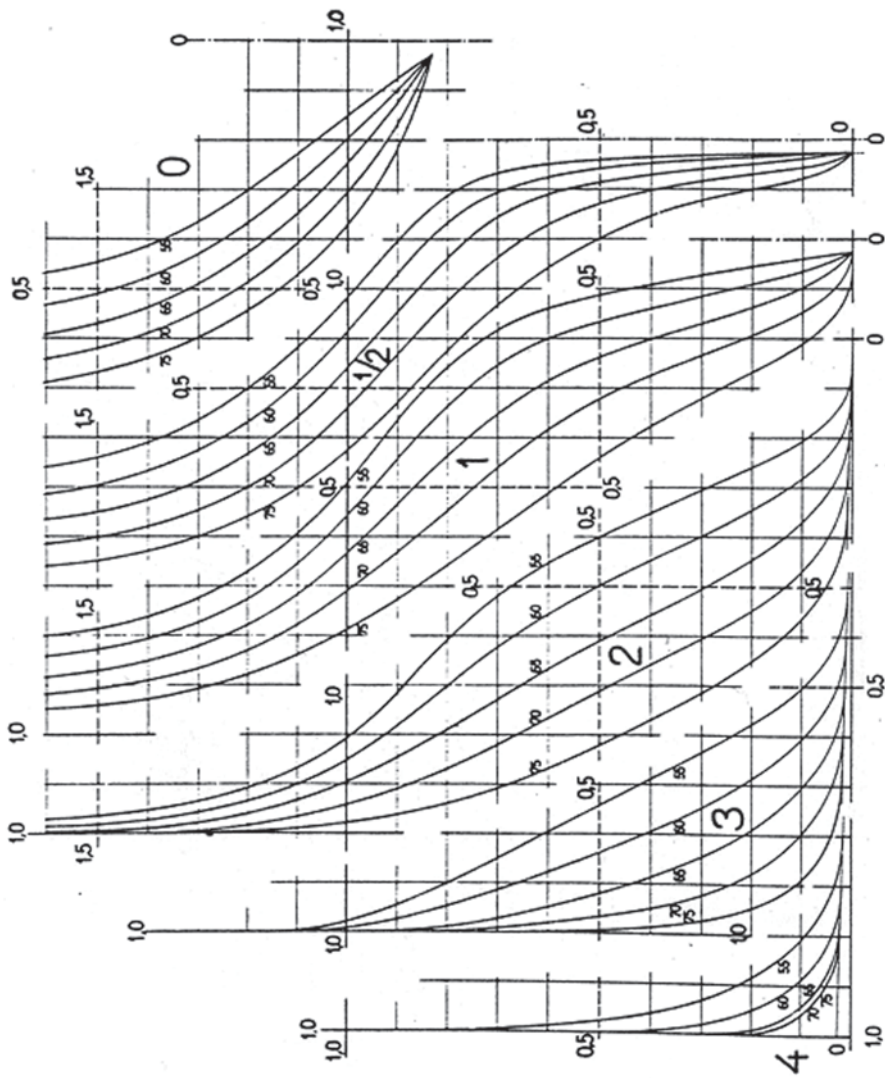

Fig. B.18 Dimensionless sections N2A-FORMDATA for stem section of N type, $C_M=0.98$ and $C_{BA}=0.55-0.60-0.65-0.70-0.75$

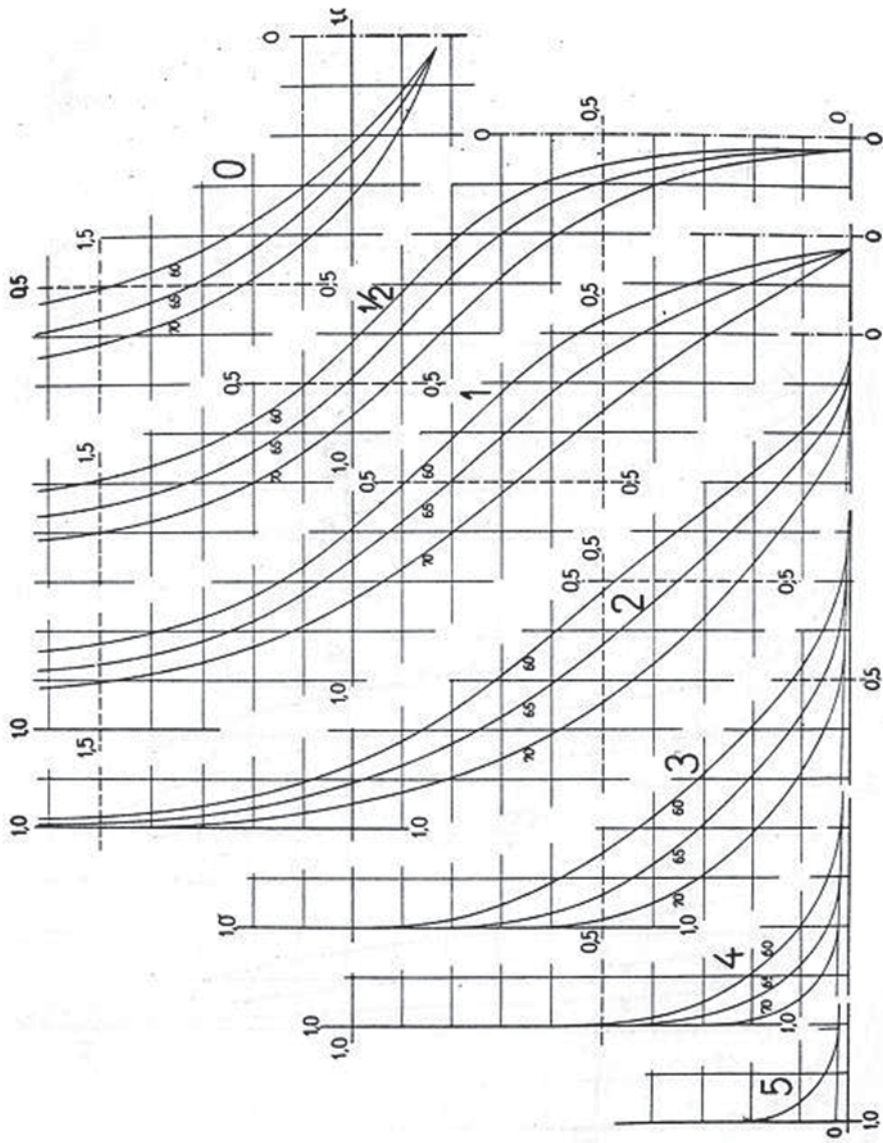

Fig. B. 19 Dimensionless sections V2A-FORMDATA for stern section of V type, $C_M = 0.98$ and $C_{BP} = 0.60 - 0.65 - 0.70$

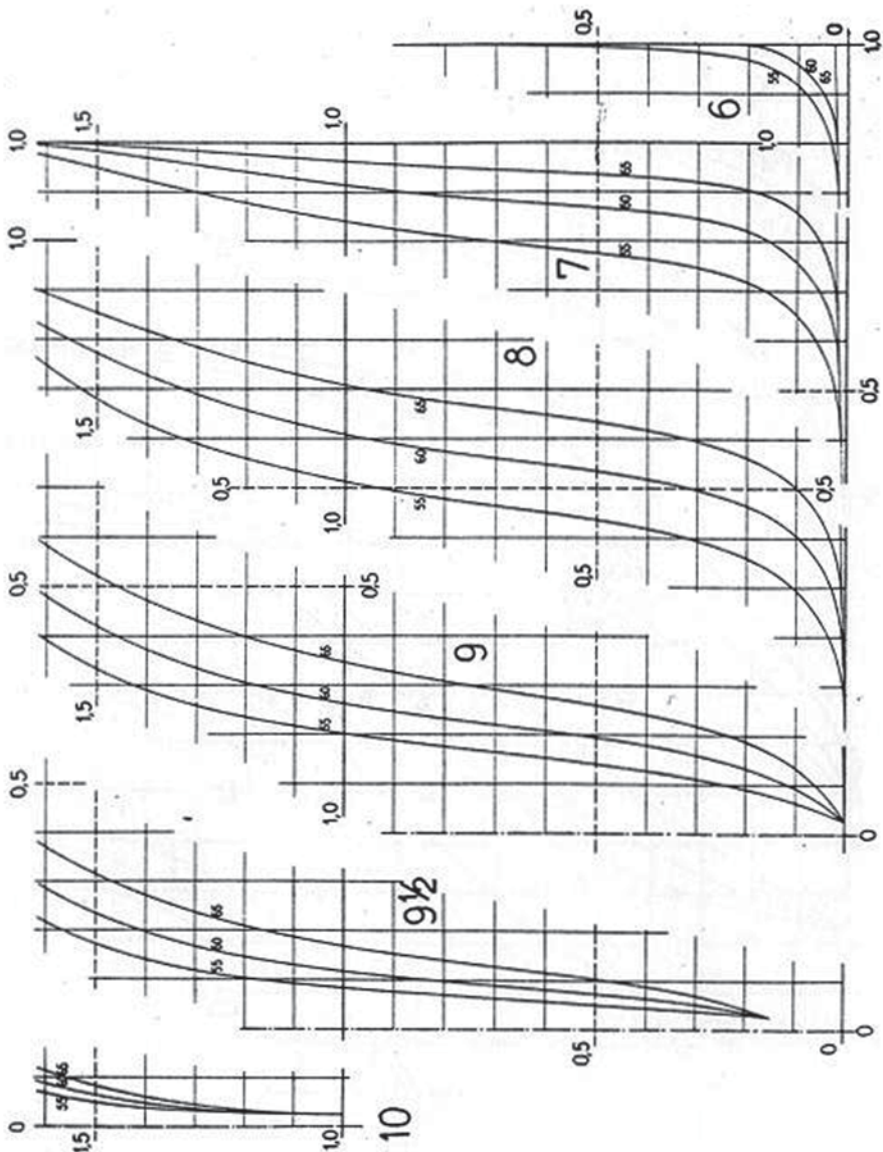

Fig. B.20 Dimensionless sections U2F-FORMDATA for bow section of U type, $C_M = 0.98$ and $C_{BF} = 0.55 - 0.60 - 0.65$

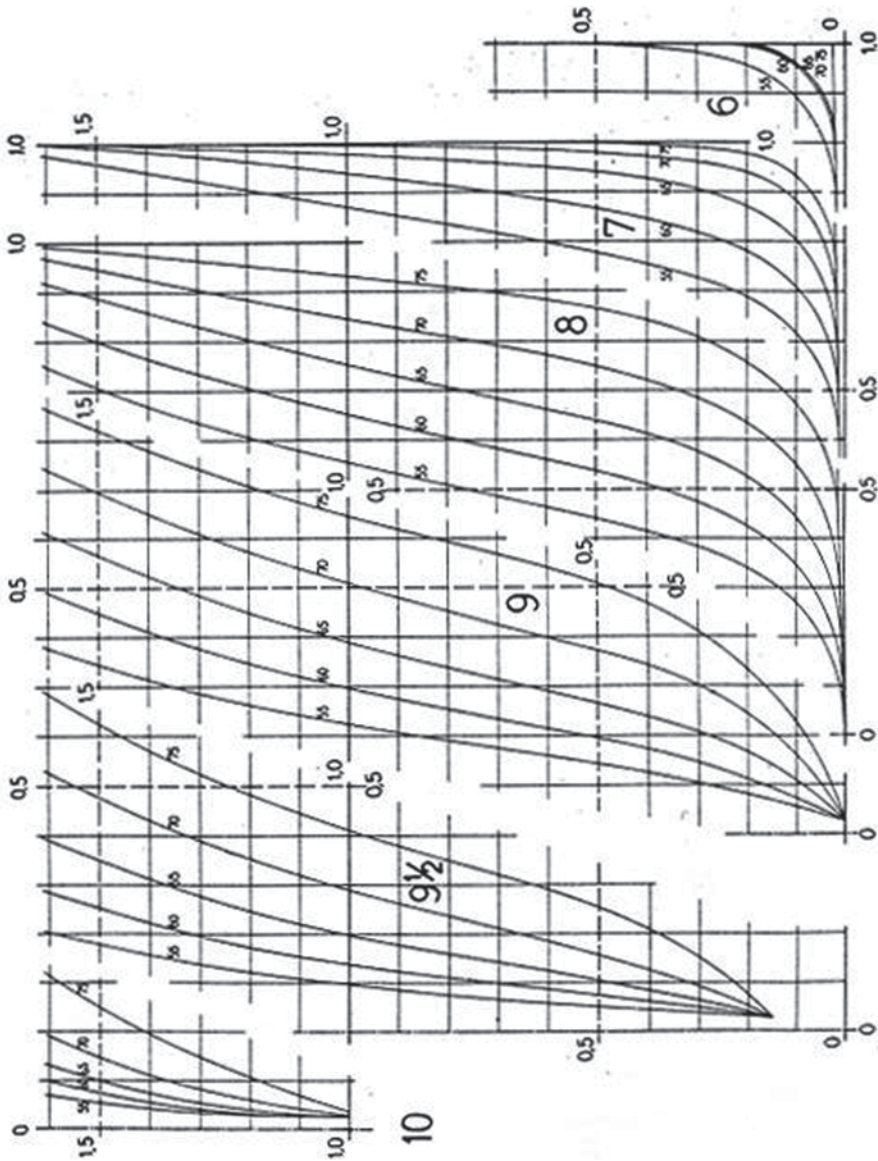

Fig. B.21 Dimensionless sections N2F-FORMDATA for bow section of N type, $C_M = 0.98$ and $C_{BF} = 0.55-0.60-0.65-0.70-0.75$

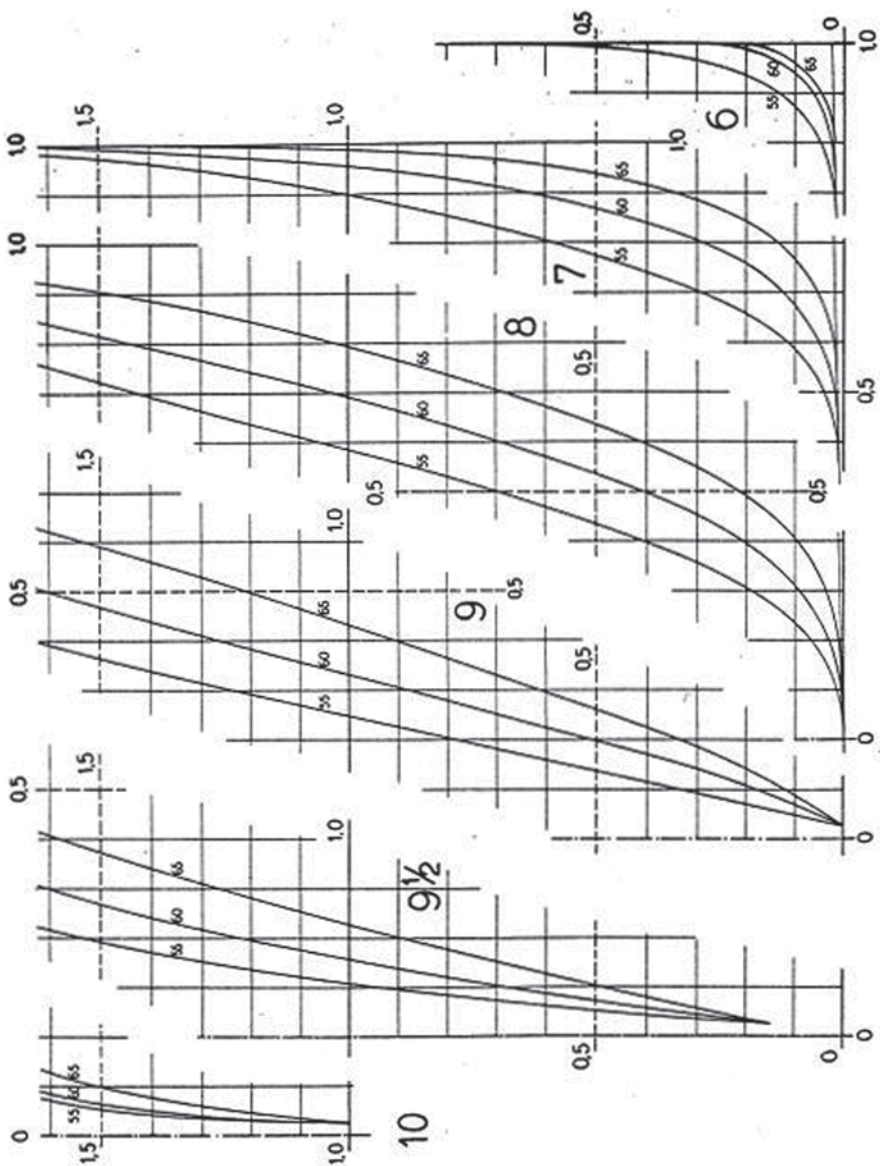

Fig. B.22 Dimensionless sections V2F-FORMDATA for bow section of V type, $C_M=0.98$ and $C_{BF}=0.55-0.60-0.65$

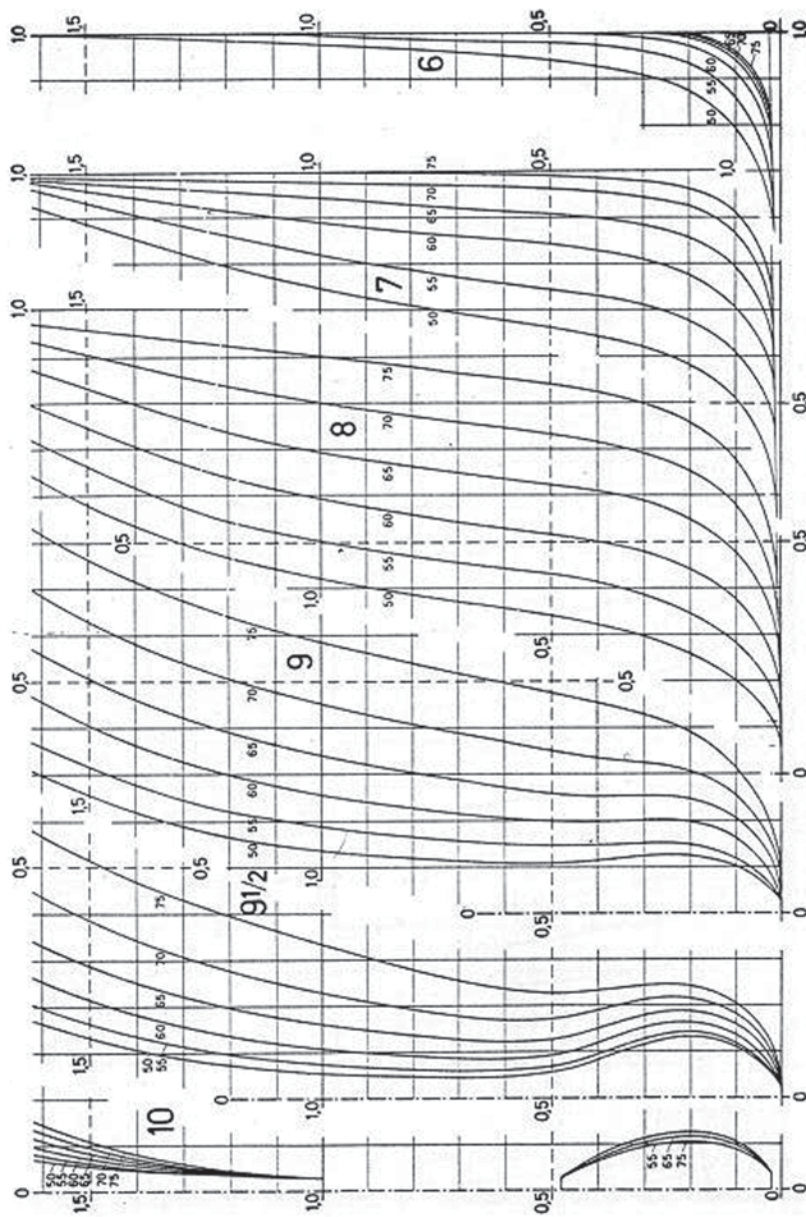

Fig. B.23 Dimensionless sections B_{2F} -FORMDATA for bulbous type bow, bulb area 4%, $A_M = 0.98$ and $C_{BF} = 0.50 - 0.55 - 0.60 - 0.65 - 0.70 - 0.75$

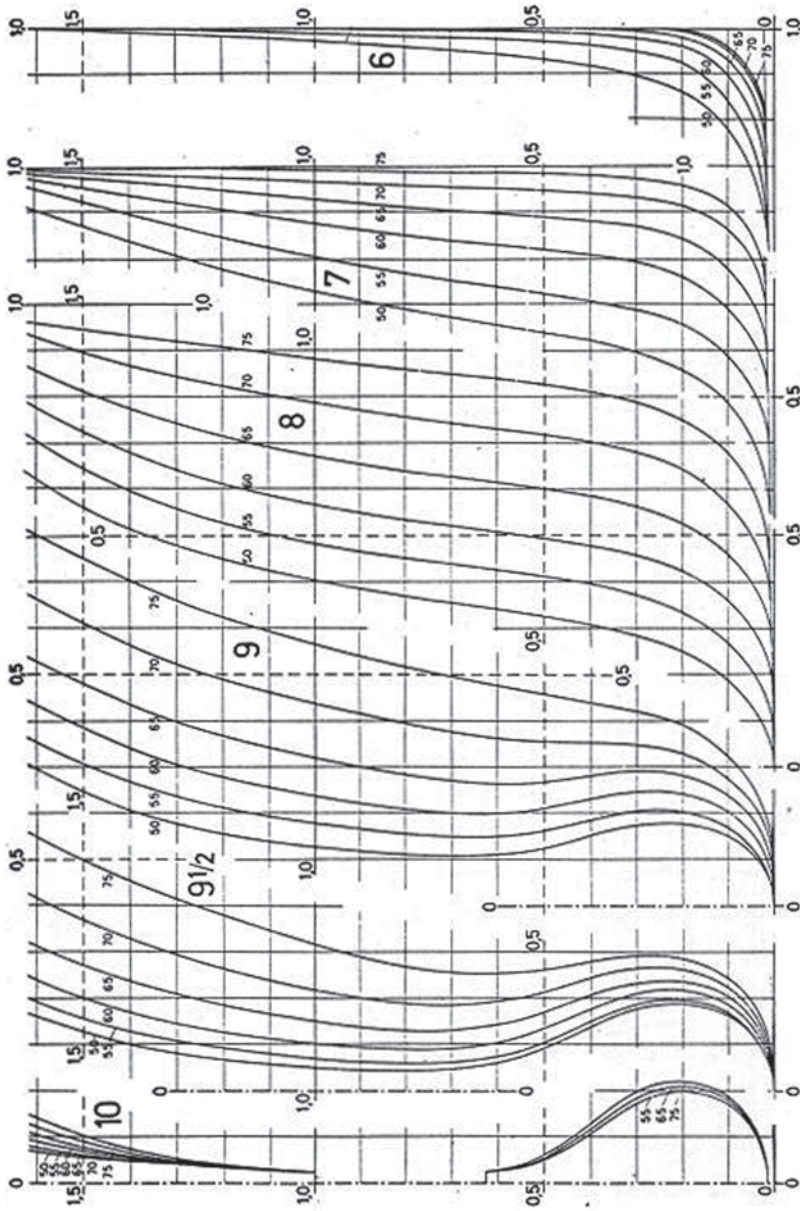

Fig. B.24 Dimensionless sections $B_{\delta}2F$ -FORMDATA for bulbous type bows, bulb area 8% A_{Mf} , $C_M = 0.98$ and $C_{BF} = 0.50 - 0.55 - 0.60 - 0.65 - 0.70 - 0.75$

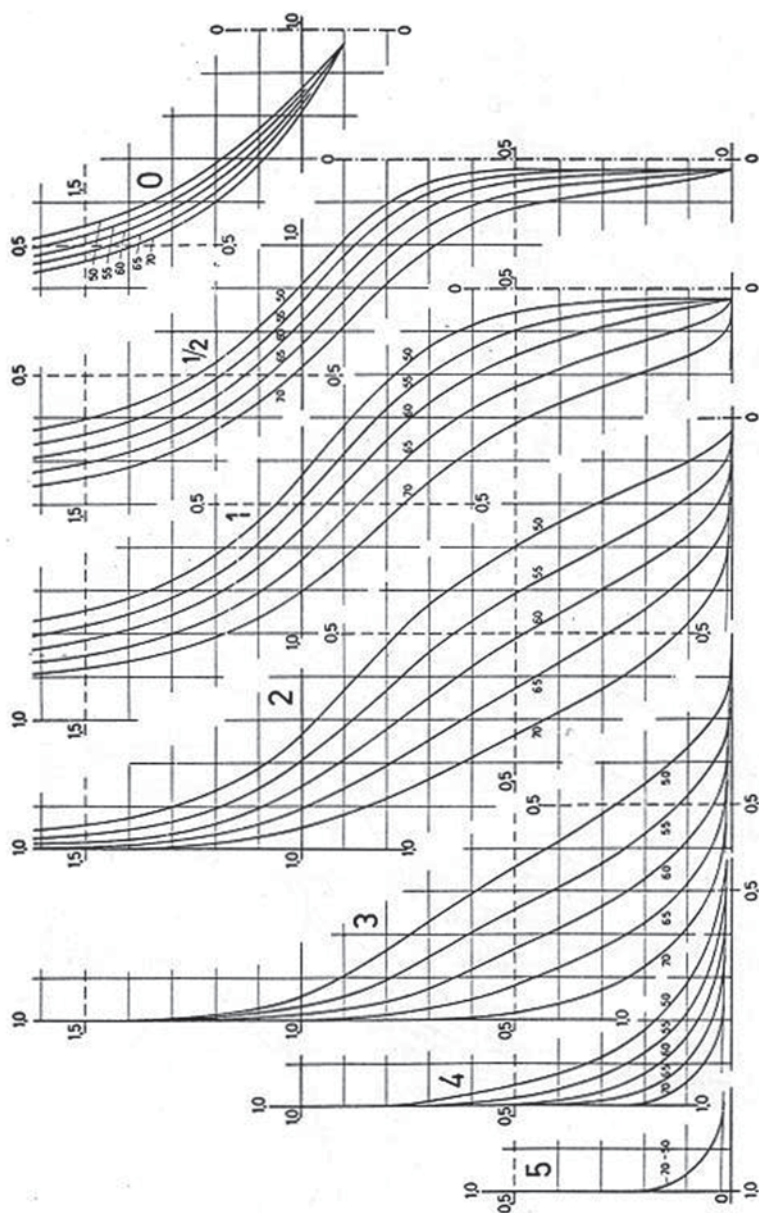

Fig. B.25 Dimensionless sections C_{λ} 2A-FORMDATA for stern section of transom type with slope A , $C_M = 0.98$ and $C_{BA} = 0.50 - 0.55 - 0.60 - 0.65 - 0.70$

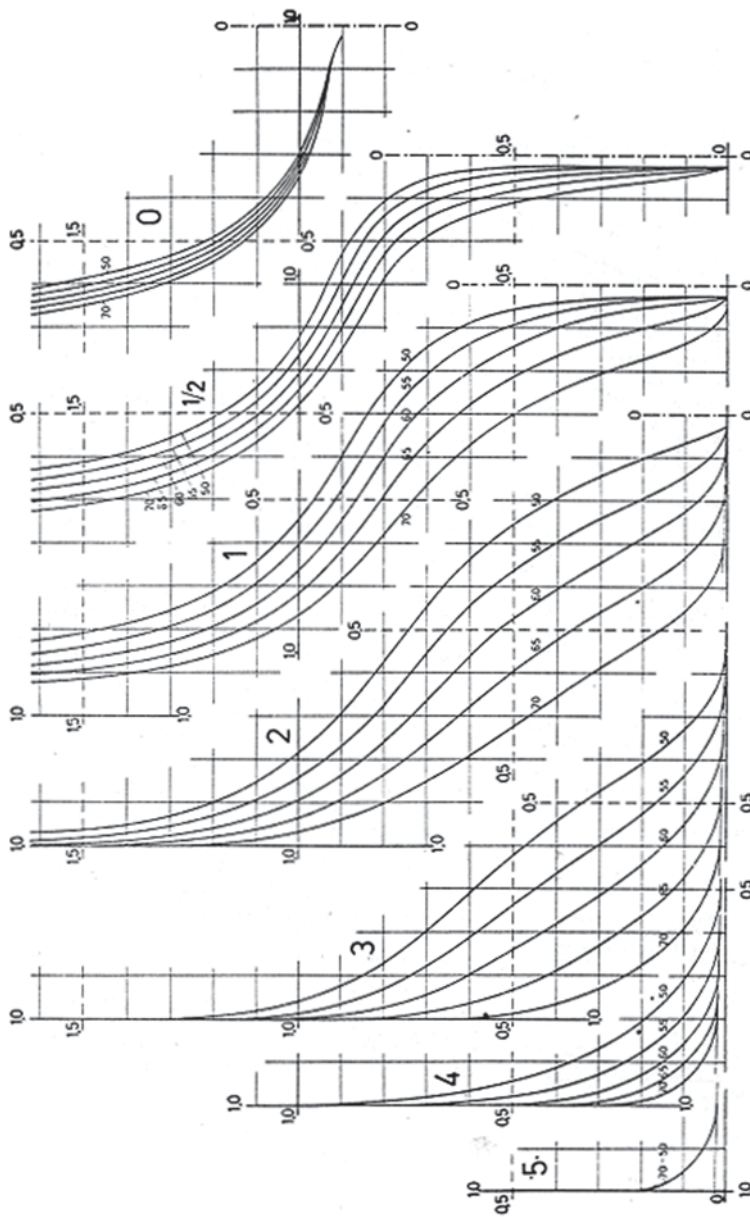

Fig. B.26 Dimensionless sections C_{B-2-A} -FORMDATA for stern section of transom type with slope B , $C_M = 0.98$ and $C_{BA} = 0.50-0.55-0.60-0.65-0.70$

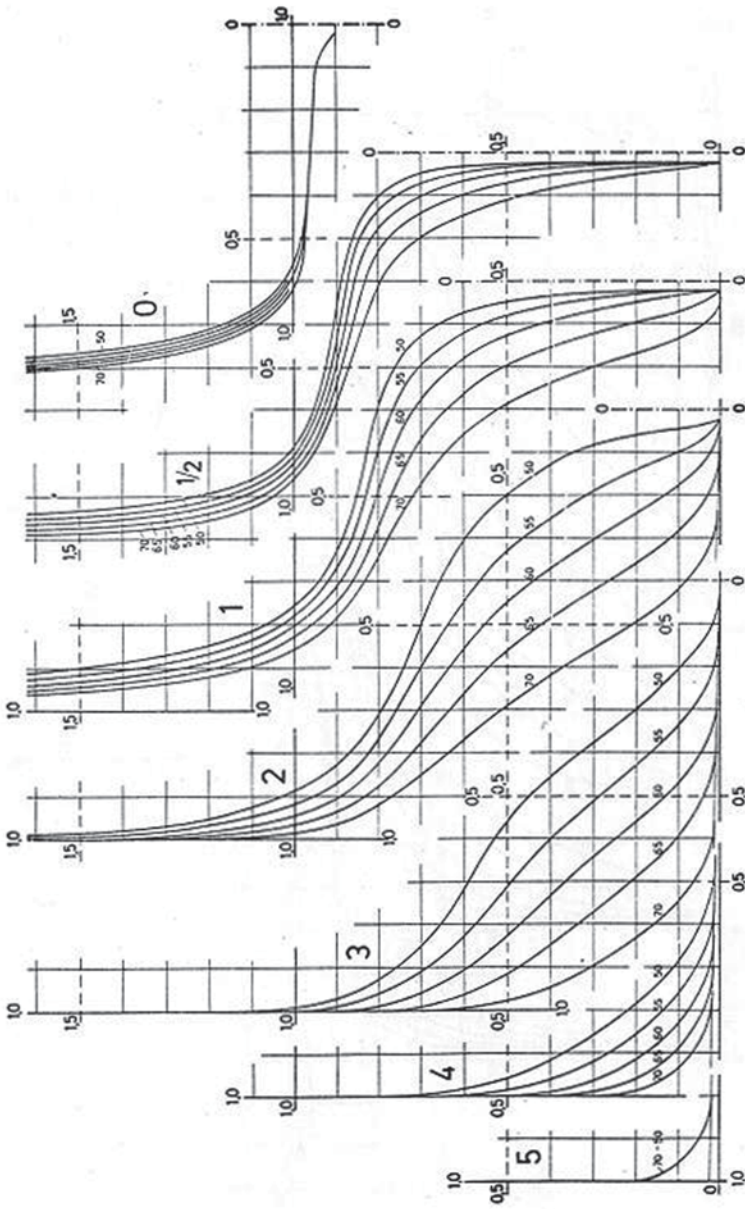

Fig. B.27 Dimensionless sections C_{c2A} -FORMDATA for stern section of transom type with slope C , $C_M = 0.98$ and $C_{BA} = 0.50 - 0.55 - 0.60 - 0.65 - 0.70$

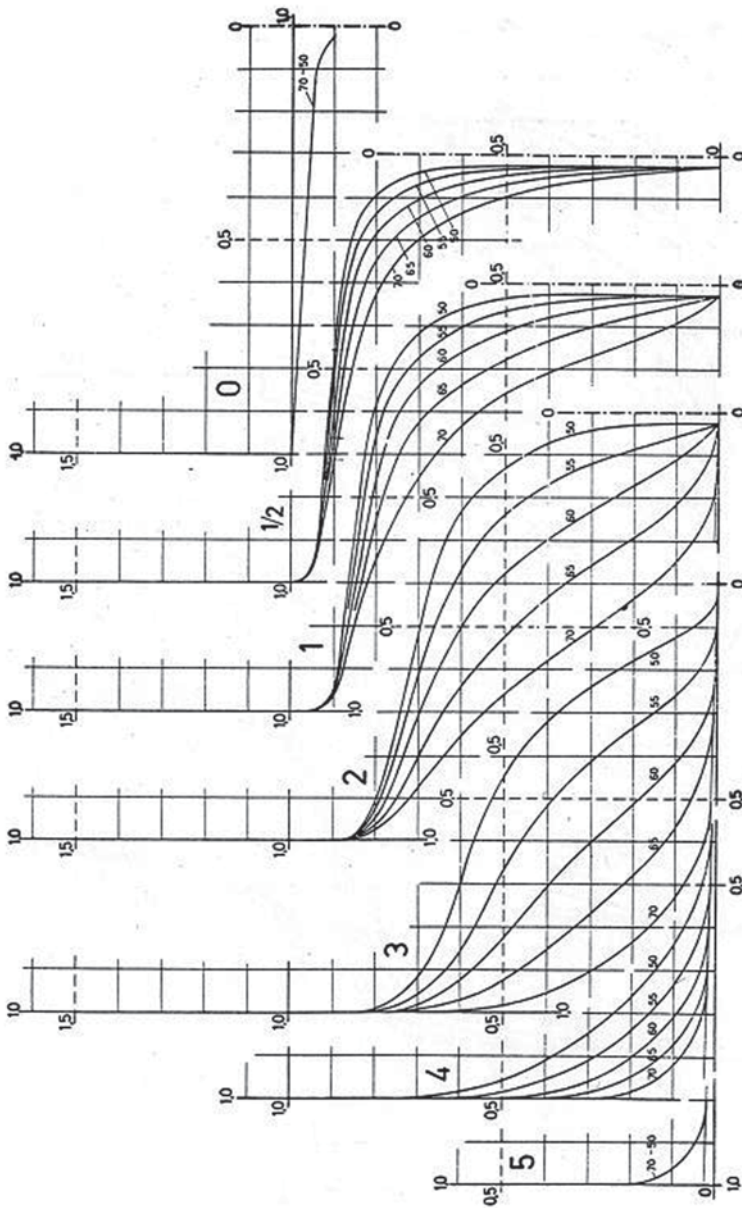

Fig. B.28 Dimensionless sections $C_{D,2A}$ -FORMDATA for stern section of transom type with slope D , $C_M=0.98$ and $C_{BA}=0.50-0.55-0.60-0.65-0.70$

MARAD Series

For MARAD series, see (Fig. B.29; Tables B.3, B.4, B.5, B.6, B.7, B.8, B.9, B.10, B.11 and B.12)

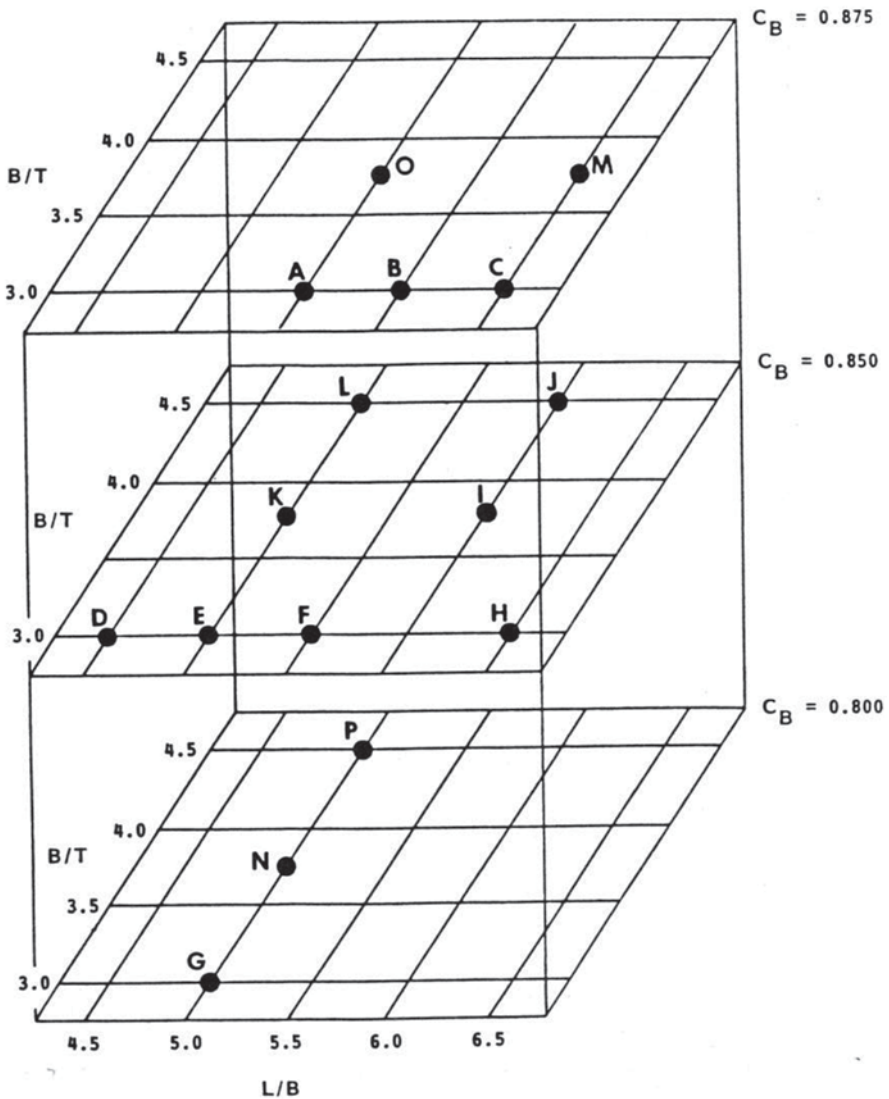

Fig. B.29 Geometrical characteristics of the series MARAD (USA, Roseman 1987) for full type vessels, tankers and bulk carriers with $C_B \geq 0.800$

Table B.3 Dimensionless geometrical parameters of the series MARAD (according to Roseman)

| Parameter | Designation | | | | | | | | | | | | | | | |
|-------------------|-------------|-------|-------|--------|--------|-------|--------|-------|-------|-------|-------|-------|-------|-------|--------|-------|
| | A | B | C | D | E | F | G | H | I | J | K | L | M | N | O | P |
| C_B | 0.875 | 0.875 | 0.875 | 0.850 | 0.850 | 0.850 | 0.800 | 0.850 | 0.850 | 0.850 | 0.850 | 0.850 | 0.875 | 0.800 | 0.875 | 0.800 |
| L/B | 5.500 | 6.000 | 6.500 | 4.500 | 5.000 | 5.500 | 5.000 | 6.500 | 6.000 | 6.000 | 5.000 | 5.000 | 5.500 | 5.000 | 5.500 | 5.000 |
| B/T | 3.000 | 3.000 | 3.000 | 3.000 | 3.000 | 3.000 | 3.000 | 3.000 | 3.750 | 4.500 | 3.750 | 4.500 | 3.750 | 3.750 | 3.750 | 4.500 |
| LCB | 2.500 | 2.500 | 2.500 | 2.500 | 2.500 | 2.500 | 2.500 | 2.500 | 2.500 | 2.500 | 2.500 | 2.500 | 2.500 | 2.500 | 2.500 | 2.500 |
| C_M | 0.99A | 0.99A | 0.99A | 0.99A | 0.99A | 0.99A | 0.99A | 0.99A | 0.99A | 0.99A | 0.99A | 0.99A | 0.99A | 0.99A | 0.99A | 0.99A |
| $1000 \nabla/L^3$ | 9.639 | 8.100 | 6.902 | 13.992 | 11.331 | 9.366 | 10.667 | 6.706 | 6.296 | 5.247 | 9.067 | 7.556 | 5.523 | 8.533 | 7.713 | 7.111 |
| S/A^3 | 6.243 | 6.302 | 6.463 | 5.749 | 5.946 | 6.127 | 5.942 | 6.457 | 6.706 | 7.114 | 6.376 | 6.745 | 6.863 | 6.331 | 6.533 | 6.750 |
| $S/(V_L)^{1/3}$ | 2.828 | 2.824 | 2.820 | 2.822 | 2.818 | 2.813 | 2.788 | 2.804 | 2.882 | 2.978 | 2.892 | 2.988 | 2.894 | 2.862 | 2.904 | 2.960 |
| L_c/L | 0.117 | 0.117 | 0.117 | 0.160 | 0.160 | 0.160 | 0.160 | 0.160 | 0.160 | 0.160 | 0.160 | 0.160 | 0.117 | 0.245 | 0.117 | 0.245 |
| L_M/L | 0.537 | 0.537 | 0.537 | 0.443 | 0.443 | 0.443 | 0.251 | 0.443 | 0.443 | 0.443 | 0.443 | 0.443 | 0.537 | 0.251 | 0.537 | 0.251 |
| L_N/L | 0.346 | 0.346 | 0.346 | 0.397 | 0.397 | 0.397 | 0.504 | 0.397 | 0.397 | 0.397 | 0.397 | 0.397 | 0.346 | 0.504 | 0.346 | 0.504 |
| L_H/B | 1.903 | 2.076 | 2.249 | 1.787 | 1.985 | 2.184 | 2.520 | 2.581 | 2.382 | 2.382 | 1.985 | 1.985 | 2.249 | 2.520 | 0.1903 | 2.520 |
| C_{DE} | 0.723 | 0.723 | 0.723 | 0.723 | 0.723 | 0.723 | 0.723 | 0.723 | 0.723 | 0.723 | 0.723 | 0.723 | 0.723 | 0.723 | 0.723 | 0.723 |
| C_{DN} | 0.742 | 0.742 | 0.742 | 0.742 | 0.742 | 0.742 | 0.742 | 0.742 | 0.742 | 0.742 | 0.742 | 0.742 | 0.742 | 0.742 | 0.742 | 0.742 |
| C_{DI} | 0.99A | 0.99A | 0.99A | 0.99A | 0.99A | 0.99A | 0.99A | 0.99A | 0.99A | 0.99A | 0.99A | 0.99A | 0.99A | 0.99A | 0.99A | 0.99A |

Notes: Length between perpendiculars, denoted as L, is used as the characteristic length for the hull parameters listed in this table. Values of these parameters apply to the Design full-load condition. LCB is expressed as percentage of L forward of midships.

Table B.4 Dimensionless ordinates and x/L_E of series MARAD

| Waterline | Station and x/L_E Measured from FP | | | | | | | | | | |
|-----------|--------------------------------------|---------------|--------|----------------|--------|----------------|--------|----------------|--------|--------|--------|
| | $\frac{1}{6}$ | $\frac{1}{3}$ | 1 | $1\frac{1}{2}$ | 2 | $2\frac{1}{2}$ | 3 | $3\frac{1}{2}$ | 4 | 5 | 6 |
| 0.00 | 0.0417 | 0.0833 | 0.1667 | 0.2500 | 0.3333 | 0.4167 | 0.5000 | 0.5833 | 0.6667 | 0.8333 | 1.0000 |
| 0.05 | | 0.0921 | 0.0167 | 0.1200 | 0.2050 | 0.2979 | 0.3904 | 0.4792 | 0.5562 | 0.7717 | 0.8729 |
| 0.10 | 0.0529 | 0.1508 | 0.2104 | 0.3008 | 0.3979 | 0.4983 | 0.5867 | 0.6662 | 0.7825 | 0.9175 | 0.9542 |
| 0.15 | 0.0992 | 0.1925 | 0.2687 | 0.3687 | 0.4662 | 0.5667 | 0.6621 | 0.7662 | 0.8471 | 0.9496 | 0.9812 |
| 0.20 | 0.1312 | 0.2204 | 0.3417 | 0.4575 | 0.5587 | 0.6179 | 0.7175 | 0.8095 | 0.8792 | 0.9675 | 0.9958 |
| 0.25 | 0.1575 | 0.2421 | 0.3692 | 0.4862 | 0.5687 | 0.6883 | 0.7783 | 0.8379 | 0.9000 | 0.9796 | 1.0000 |
| 0.30 | 0.1767 | 0.2604 | 0.3921 | 0.5092 | 0.6129 | 0.7104 | 0.7962 | 0.8546 | 0.9133 | 0.9850 | 1.0000 |
| 0.35 | 0.1929 | 0.2779 | 0.4112 | 0.5279 | 0.6333 | 0.7283 | 0.8108 | 0.8767 | 0.9292 | 0.9417 | 1.0000 |
| 0.40 | 0.2046 | 0.2921 | 0.4262 | 0.5425 | 0.6492 | 0.7437 | 0.8217 | 0.8846 | 0.9342 | 0.9950 | 1.0000 |
| 0.45 | 0.2158 | 0.3067 | 0.4404 | 0.5571 | 0.6633 | 0.7558 | 0.8312 | 0.8917 | 0.9375 | 0.9979 | 1.0000 |
| 0.50 | 0.2250 | 0.3192 | 0.4529 | 0.5687 | 0.6578 | 0.7662 | 0.8387 | 0.8975 | 0.9408 | 0.9996 | 1.0000 |
| 0.55 | 0.2337 | 0.3308 | 0.4642 | 0.5804 | 0.6875 | 0.7758 | 0.8498 | 0.9021 | 0.9437 | 1.0000 | 1.0000 |
| 0.60 | 0.2412 | 0.3412 | 0.4758 | 0.5908 | 0.6979 | 0.7833 | 0.8517 | 0.9067 | 0.9467 | 1.0000 | 1.0000 |
| 0.65 | 0.2487 | 0.3504 | 0.4862 | 0.6008 | 0.7075 | 0.7904 | 0.8583 | 0.9108 | 0.9487 | 1.0000 | 1.0000 |
| 0.70 | 0.2546 | 0.3587 | 0.4954 | 0.6096 | 0.7158 | 0.7967 | 0.8637 | 0.9142 | 0.9517 | 1.0000 | 1.0000 |
| 0.75 | 0.2617 | 0.3671 | 0.5050 | 0.6196 | 0.7237 | 0.8033 | 0.8679 | 0.9179 | 0.9542 | 1.0000 | 1.0000 |
| 0.80 | 0.2687 | 0.3750 | 0.5142 | 0.6283 | 0.7312 | 0.8087 | 0.8721 | 0.9212 | 0.9567 | 1.0000 | 1.0000 |
| 0.85 | 0.2742 | 0.3817 | 0.5233 | 0.6371 | 0.7379 | 0.8146 | 0.8762 | 0.9242 | 0.9587 | 1.0000 | 1.0000 |
| 0.90 | 0.2796 | 0.3879 | 0.5308 | 0.6442 | 0.7433 | 0.8196 | 0.8804 | 0.9271 | 0.9604 | 1.0000 | 1.0000 |
| 0.95 | 0.2850 | 0.3950 | 0.5392 | 0.6517 | 0.7496 | 0.8250 | 0.8846 | 0.9333 | 0.9633 | 1.0000 | 1.0000 |
| 1.00 | 0.2917 | 0.4017 | 0.5467 | 0.6592 | 0.7550 | 0.8296 | 0.8883 | 0.9300 | 0.9646 | 1.0000 | 1.0000 |
| 1.10 | 0.3029 | 0.4133 | 0.5600 | 0.6721 | 0.7654 | 0.8379 | 0.8942 | 0.9383 | 0.9679 | 1.0000 | 1.0000 |
| 1.20 | 0.3187 | 0.4283 | 0.5754 | 0.6854 | 0.7754 | 0.8462 | 0.9008 | 0.9437 | 0.9725 | 1.0000 | 1.0000 |
| 1.30 | 0.3383 | 0.4433 | 0.5887 | 0.6971 | 0.7842 | 0.8533 | 0.9071 | 0.9479 | 0.9758 | 1.0000 | 1.0000 |
| 1.40 | 0.3629 | 0.4604 | 0.5937 | 0.7079 | 0.7925 | 0.8600 | 0.9133 | 0.9529 | 0.9787 | 1.0000 | 1.0000 |
| 1.50 | 0.3950 | 0.4833 | 0.6162 | 0.7187 | 0.8000 | 0.8658 | 0.9183 | 0.9562 | 0.9812 | 1.0000 | 1.0000 |

Note: Half-breadths of waterlines at each station listed in the table are given as fractions of half maximum beam. Waterline heights are given as fractions of design full-load draft.

Table B.6 Dimensionless ordinates and x/L_R for hull forms A and O of the series MARAD

| Waterline | Station and x/L_R Measured from AP | | | | | | | | | | | | |
|-----------|--------------------------------------|---------|---------|--------|--------|--------|--------|--------|--------|--------|--------|--------|--------|
| | -1½ | i | -1 | -½ | 0 | ½ | 1 | 1½ | 2 | 2½ | 3 | 3½ | 4 |
| 0.00 | -0.1250 | -0.0833 | -0.0417 | 0 | 0.0417 | 0.0833 | 0.1250 | 0.1667 | 0.2083 | 0.2500 | 0.2917 | 0.3333 | 0.3333 |
| 0.05 | | | | | | | 0.0025 | 0.0042 | 0.0325 | 0.0667 | 0.0667 | 0.0667 | 0.0833 |
| 0.10 | | | | | | | 0.0254 | 0.0487 | 0.0862 | 0.1262 | 0.1587 | 0.2012 | 0.2012 |
| 0.15 | | | | | | | 0.0333 | 0.0658 | 0.1075 | 0.1579 | 0.2054 | 0.2612 | 0.2612 |
| 0.20 | | | | | | | 0.0362 | 0.0779 | 0.1237 | 0.1821 | 0.2446 | 0.3146 | 0.3146 |
| 0.25 | | | | | | | 0.0371 | 0.0871 | 0.1381 | 0.2071 | 0.2821 | 0.3679 | 0.3679 |
| 0.30 | | | | | | | 0.0354 | 0.0937 | 0.1562 | 0.2350 | 0.3237 | 0.4271 | 0.4271 |
| 0.35 | | | | | | | 0.0342 | 0.0996 | 0.1754 | 0.2671 | 0.3721 | 0.4917 | 0.4917 |
| 0.40 | | | | | | | 0.0346 | 0.1050 | 0.1975 | 0.3058 | 0.4354 | 0.5604 | 0.5604 |
| 0.45 | | | | | | | 0.0362 | 0.1137 | 0.2267 | 0.3562 | 0.5075 | 0.6383 | 0.6383 |
| 0.50 | | | | | | | 0.0408 | 0.1312 | 0.2796 | 0.4371 | 0.5950 | 0.7229 | 0.7229 |
| 0.55 | | | | | | | 0.0479 | 0.1612 | 0.3679 | 0.5521 | 0.6912 | 0.7950 | 0.7950 |
| 0.60 | | | | | | | 0.0504 | 0.2242 | 0.4871 | 0.6767 | 0.7750 | 0.8508 | 0.8508 |
| 0.65 | | | | | | | 0.0942 | 0.4329 | 0.6442 | 0.7687 | 0.8417 | 0.8967 | 0.8967 |
| 0.70 | | | | | | | 0.3312 | 0.6154 | 0.7537 | 0.8383 | 0.8912 | 0.9304 | 0.9304 |
| 0.75 | | | | | | 0.2087 | 0.5625 | 0.7279 | 0.8242 | 0.8867 | 0.9250 | 0.9554 | 0.9554 |
| 0.80 | | | | | | 0.4987 | 0.6967 | 0.8017 | 0.8750 | 0.9229 | 0.9492 | 0.9750 | 0.9750 |
| 0.85 | | | | | 0.2958 | 0.4087 | 0.7783 | 0.8521 | 0.9112 | 0.9467 | 0.9658 | 0.9857 | 0.9857 |
| 0.90 | | | | | 0.5150 | 0.5975 | 0.8308 | 0.8883 | 0.9342 | 0.9617 | 0.9775 | 0.9938 | 0.9938 |
| 0.95 | | | | | 0.6262 | 0.7521 | 0.8662 | 0.9154 | 0.9508 | 0.9733 | 0.9854 | 1.0000 | 1.0000 |
| 1.00 | | | | | 0.6929 | 0.7917 | 0.8946 | 0.9346 | 0.9621 | 0.9804 | 0.9908 | 1.0000 | 1.0000 |
| 1.10 | 0.3696 | 0.3267 | 0.5479 | 0.5525 | 0.6929 | 0.7917 | 0.8854 | 0.9492 | 0.9708 | 0.9867 | 0.9942 | 1.0000 | 1.0000 |
| 1.20 | 0.5137 | 0.6267 | 0.6658 | 0.7233 | 0.7642 | 0.8104 | 0.8992 | 0.9442 | 0.9796 | 0.9917 | 0.9975 | 1.0000 | 1.0000 |
| 1.30 | 0.5725 | 0.6696 | 0.7333 | 0.7533 | 0.8033 | 0.8667 | 0.9467 | 0.9717 | 0.9833 | 0.9937 | 0.9975 | 1.0000 | 1.0000 |
| 1.40 | 0.5950 | 0.6842 | 0.7654 | 0.7842 | 0.8221 | 0.8804 | 0.9521 | 0.9725 | 0.9833 | 0.9937 | 0.9975 | 1.0000 | 1.0000 |
| 1.50 | 0.5992 | 0.6858 | 0.7662 | 0.7833 | 0.8300 | 0.8833 | 0.9521 | 0.9725 | 0.9833 | 0.9937 | 0.9975 | 1.0000 | 1.0000 |

Table B.7 Dimensionless ordinates and x/L_R for hull forms B of the series MARAD

| Waterline | Station and x/L_R Measured from AP | | | | | | | | | | | |
|-----------|--------------------------------------|---------|----------------|--------|---------------|--------|----------------|--------|----------------|--------|----------------|--------|
| | $-1\frac{1}{2}$ | -1 | $-\frac{1}{2}$ | 0 | $\frac{1}{2}$ | 1 | $1\frac{1}{2}$ | 2 | $2\frac{1}{2}$ | 3 | $3\frac{1}{2}$ | 4 |
| 0.00 | -0.1250 | -0.0833 | -0.0417 | 0 | 0.0417 | 0.0833 | 0.1250 | 0.1667 | 0.2083 | 0.2500 | 0.2917 | 0.3333 |
| 0.05 | | | | | | | 0.0008 | 0.0025 | 0.0167 | 0.0354 | 0.0521 | 0.0646 |
| 0.10 | | | | | | | 0.0187 | 0.0479 | 0.0833 | 0.1242 | 0.1562 | 0.1996 |
| 0.15 | | | | | | | 0.0300 | 0.0671 | 0.1087 | 0.1583 | 0.2042 | 0.2637 |
| 0.20 | | | | | | | 0.0379 | 0.0804 | 0.1296 | 0.1833 | 0.2437 | 0.3179 |
| 0.25 | | | | | | | 0.0429 | 0.0900 | 0.1471 | 0.2083 | 0.2808 | 0.3696 |
| 0.30 | | | | | | | 0.0454 | 0.0983 | 0.1625 | 0.2375 | 0.3246 | 0.4287 |
| 0.35 | | | | | | | 0.0458 | 0.1050 | 0.1804 | 0.2717 | 0.3783 | 0.4921 |
| 0.40 | | | | | | | 0.0450 | 0.1121 | 0.2033 | 0.3121 | 0.4408 | 0.5617 |
| 0.45 | | | | | | | 0.0450 | 0.1200 | 0.2362 | 0.3683 | 0.5162 | 0.6442 |
| 0.50 | | | | | | | 0.0471 | 0.1362 | 0.2912 | 0.4471 | 0.6050 | 0.7242 |
| 0.55 | | | | | | | 0.0508 | 0.1700 | 0.3792 | 0.5633 | 0.7000 | 0.7942 |
| 0.60 | | | | | | | 0.0725 | 0.2571 | 0.5008 | 0.6775 | 0.7829 | 0.8508 |
| 0.65 | | | | | | | 0.1312 | 0.4450 | 0.6500 | 0.7700 | 0.8450 | 0.8958 |
| 0.70 | | | | | | | 0.3571 | 0.6100 | 0.7575 | 0.8367 | 0.8908 | 0.9296 |
| 0.75 | | | | | | | 0.2367 | 0.5225 | 0.7271 | 0.8229 | 0.8837 | 0.9237 |
| 0.80 | | | | | 0.0312 | 0.4892 | 0.6887 | 0.8000 | 0.8700 | 0.9195 | 0.9496 | 0.9733 |
| 0.85 | | | | | 0.1033 | 0.6397 | 0.7657 | 0.8179 | 0.9054 | 0.9433 | 0.9767 | 0.9846 |
| 0.90 | | | | 0.2446 | 0.5762 | 0.7258 | 0.8208 | 0.8850 | 0.9300 | 0.9508 | 0.9779 | 0.9921 |
| 0.95 | | | | 0.4796 | 0.6679 | 0.7817 | 0.8592 | 0.9129 | 0.9475 | 0.9725 | 0.9957 | 1.0000 |
| 1.00 | | | | 0.5908 | 0.7304 | 0.8217 | 0.8867 | 0.9317 | 0.9592 | 0.9800 | 0.9917 | 0.9987 |
| 1.10 | 0.2679 | 0.2167 | 0.3675 | 0.6604 | 0.7742 | 0.8521 | 0.9079 | 0.9458 | 0.9683 | 0.9846 | 0.9946 | 1.0000 |
| 1.20 | 0.4542 | 0.4946 | 0.6287 | 0.7387 | 0.8250 | 0.8867 | 0.9308 | 0.9508 | 0.9775 | 0.9908 | 1.0387 | 1.0000 |
| 1.30 | 0.5217 | 0.5779 | 0.6871 | 0.7796 | 0.8512 | 0.9052 | 0.9417 | 0.9683 | 0.9833 | 0.9942 | 1.0387 | 1.0000 |
| 1.40 | 0.5512 | 0.6237 | 0.7179 | 0.7992 | 0.8654 | 0.9133 | 0.9454 | 0.9708 | 0.9854 | 0.9958 | 0.9983 | 1.0000 |
| 1.50 | 0.5575 | 0.6446 | 0.7329 | 0.8083 | 0.8704 | 0.9175 | 0.9462 | 0.9708 | 0.9854 | 0.9958 | 0.9983 | 1.0000 |
| | | | 0.7392 | 0.8117 | 0.8717 | 0.9183 | 0.9462 | 0.9708 | 0.9854 | 0.9958 | 0.9983 | 1.0000 |

Table B.8 Dimensionless ordinates and x/L_R for hull forms C and M of the series MARAD

| Waterline | Station and x/L_R Measured from AP | | | | | | | | | | | |
|-----------|--------------------------------------|---------|---------|--------|--------|--------|--------|--------|--------|--------|--------|--------|
| | -1½ | -1 | -½ | 0 | ½ | 1 | 1½ | 2 | 2½ | 3 | 3½ | 4 |
| 0.00 | -0.1250 | -0.0833 | -0.0417 | 0 | 0.0417 | 0.0833 | 0.1250 | 0.1667 | 0.2083 | 0.2500 | 0.2917 | 0.3333 |
| 0.05 | | | | | | | 0.0017 | 0.0062 | 0.0217 | 0.0417 | 0.0567 | 0.0717 |
| 0.10 | | | | | | | 0.0304 | 0.0503 | 0.0846 | 0.1258 | 0.1571 | 0.1979 |
| 0.15 | | | | | | | 0.0400 | 0.0692 | 0.1112 | 0.1596 | 0.2042 | 0.2625 |
| 0.20 | | | | | | | 0.0450 | 0.0837 | 0.1317 | 0.1867 | 0.2442 | 0.3171 |
| 0.25 | | | | | | | 0.0471 | 0.0950 | 0.1475 | 0.2117 | 0.2825 | 0.3717 |
| 0.30 | | | | | | | 0.0479 | 0.1037 | 0.1637 | 0.2421 | 0.3287 | 0.4308 |
| 0.35 | | | | | | | 0.0487 | 0.1104 | 0.1842 | 0.2758 | 0.3812 | 0.4896 |
| 0.40 | | | | | | | 0.0500 | 0.1162 | 0.2096 | 0.3158 | 0.4454 | 0.5629 |
| 0.45 | | | | | | | 0.0512 | 0.1262 | 0.2471 | 0.3733 | 0.5183 | 0.6454 |
| 0.50 | | | | | | | 0.0562 | 0.1487 | 0.3033 | 0.4542 | 0.6062 | 0.7242 |
| 0.55 | | | | | | | 0.0671 | 0.1975 | 0.3895 | 0.5662 | 0.6987 | 0.7954 |
| 0.60 | | | | | | | 0.0892 | 0.2875 | 0.5117 | 0.6754 | 0.7796 | 0.8508 |
| 0.65 | | | | | | 0.0046 | 0.1546 | 0.4467 | 0.6392 | 0.7658 | 0.8329 | 0.8954 |
| 0.70 | | | | | | 0.0379 | 0.3604 | 0.6021 | 0.7467 | 0.8329 | 0.8896 | 0.9296 |
| 0.75 | | | | | | 0.2495 | 0.5450 | 0.7175 | 0.8162 | 0.8812 | 0.9242 | 0.9554 |
| 0.80 | | | | | | 0.4712 | 0.6775 | 0.7942 | 0.8662 | 0.9183 | 0.9492 | 0.9746 |
| 0.85 | | | | | | 0.6167 | 0.7575 | 0.8425 | 0.9033 | 0.9425 | 0.9667 | 0.9850 |
| 0.90 | | | | 0.2150 | 0.0708 | 0.7104 | 0.8104 | 0.8796 | 0.9283 | 0.9592 | 0.9775 | 0.9921 |
| 0.95 | | | | 0.4337 | 0.5446 | 0.6167 | 0.6751 | 0.7092 | 0.7462 | 0.7700 | 0.7954 | 0.8192 |
| 1.00 | | | | 0.5562 | 0.6167 | 0.6833 | 0.7321 | 0.7629 | 0.7862 | 0.8033 | 0.8192 | 0.8333 |
| 1.10 | | | | 0.6375 | 0.7587 | 0.8437 | 0.9050 | 0.9429 | 0.9667 | 0.9829 | 0.9933 | 0.9992 |
| 1.20 | 0.1492 | 0.4429 | 0.5975 | 0.7180 | 0.8104 | 0.8775 | 0.9250 | 0.9567 | 0.9754 | 0.9883 | 0.9933 | 0.9992 |
| 1.30 | 0.3857 | 0.5371 | 0.6562 | 0.7583 | 0.8358 | 0.8946 | 0.9354 | 0.9633 | 0.9792 | 0.9904 | 0.9933 | 0.9992 |
| 1.40 | 0.4729 | 0.5833 | 0.6867 | 0.7775 | 0.8487 | 0.9033 | 0.9575 | 0.9642 | 0.9792 | 0.9904 | 0.9933 | 0.9992 |
| 1.50 | 0.5058 | 0.6100 | 0.7042 | 0.7883 | 0.8550 | 0.9075 | 0.9400 | 0.9642 | 0.9792 | 0.9904 | 0.9933 | 0.9992 |
| | 0.5167 | 0.6192 | 0.7133 | 0.7933 | 0.8592 | 0.9092 | 0.9400 | 0.9642 | 0.9792 | 0.9904 | 0.9933 | 0.9992 |

Table B.9 Dimensionless ordinates and x/L_R for hull forms D of the series MARAD

| Waterline | Station and x/L_R Measured from AP | | | | | | | | | | | |
|-----------|--------------------------------------|---------|---------|--------|--------|--------|--------|--------|--------|--------|--------|--------|
| | -1½ | -1 | -¾ | 0 | ¼ | 1 | 1½ | 2 | 2½ | 3 | 3½ | 4 |
| 0.00 | -0.1250 | -0.0833 | -0.0417 | 0 | 0.0417 | 0.0833 | 0.1250 | 0.1667 | 0.2083 | 0.2500 | 0.2917 | 0.3333 |
| 0.05 | | | | | | | 0.0008 | 0.0017 | 0.0271 | 0.0521 | 0.0646 | 0.0742 |
| 0.10 | | | | | | | 0.0162 | 0.0446 | 0.1079 | 0.1262 | 0.1575 | 0.1992 |
| 0.15 | | | | | | | 0.0254 | 0.0521 | 0.1079 | 0.1579 | 0.2021 | 0.2612 |
| 0.20 | | | | | | | 0.0304 | 0.0742 | 0.1254 | 0.1804 | 0.2417 | 0.3162 |
| 0.25 | | | | | | | 0.0329 | 0.0825 | 0.1400 | 0.2033 | 0.2783 | 0.3696 |
| 0.30 | | | | | | | 0.0342 | 0.0903 | 0.1533 | 0.2312 | 0.3217 | 0.4296 |
| 0.35 | | | | | | | 0.0346 | 0.0954 | 0.1696 | 0.2630 | 0.3721 | 0.4925 |
| 0.40 | | | | | | | 0.0342 | 0.1000 | 0.1917 | 0.3030 | 0.4346 | 0.5512 |
| 0.45 | | | | | | | 0.0333 | 0.1058 | 0.2208 | 0.3575 | 0.5079 | 0.6412 |
| 0.50 | | | | | | | 0.0325 | 0.1187 | 0.2730 | 0.4412 | 0.5992 | 0.7250 |
| 0.55 | | | | | | | 0.0371 | 0.1504 | 0.3642 | 0.5617 | 0.6983 | 0.7971 |
| 0.60 | | | | | | | 0.0479 | 0.2304 | 0.4983 | 0.6791 | 0.7817 | 0.8529 |
| 0.65 | | | | | | | 0.0787 | 0.4250 | 0.6471 | 0.7695 | 0.8458 | 0.8962 |
| 0.70 | | | | | | | 0.3350 | 0.6200 | 0.7587 | 0.8383 | 0.8929 | 0.9304 |
| 0.75 | | | | | | | 0.5737 | 0.7337 | 0.8279 | 0.8862 | 0.9254 | 0.9554 |
| 0.80 | | | | | | | 0.7062 | 0.8058 | 0.8762 | 0.9212 | 0.9504 | 0.9737 |
| 0.85 | | | | | | | 0.7817 | 0.8546 | 0.9096 | 0.9467 | 0.9571 | 0.9850 |
| 0.90 | | | | 0.3533 | | | 0.8696 | 0.9171 | 0.9329 | 0.9621 | 0.9779 | 0.9912 |
| 0.95 | | | 0.1837 | 0.5521 | | | 0.9100 | 0.9171 | 0.9483 | 0.9725 | 0.9858 | 0.9950 |
| 1.00 | | 0.3850 | 0.4675 | 0.6470 | | | 0.9362 | 0.9374 | 0.9500 | 0.9700 | 0.9904 | 0.9957 |
| 1.10 | 0.0162 | 0.5754 | 0.5825 | 0.7083 | 0.8008 | 0.8683 | 0.9158 | 0.9492 | 0.9692 | 0.9854 | 0.9942 | 1.0000 |
| 1.20 | 0.5492 | 0.6479 | 0.6904 | 0.7792 | 0.8192 | 0.9025 | 0.9396 | 0.9654 | 0.9796 | 0.9921 | 0.9983 | 1.0000 |
| 1.30 | 0.5967 | 0.6858 | 0.7412 | 0.8162 | 0.8750 | 0.9212 | 0.9521 | 0.9742 | 0.9846 | 0.9937 | 0.9983 | 1.0000 |
| 1.40 | 0.6183 | 0.7033 | 0.7667 | 0.8354 | 0.8883 | 0.9296 | 0.9550 | 0.9758 | 0.9862 | 0.9937 | 0.9983 | 1.0000 |
| 1.50 | 0.6242 | 0.7087 | 0.7796 | 0.8429 | 0.8933 | 0.9308 | 0.9558 | 0.9758 | 0.9862 | 0.9937 | 0.9983 | 1.0000 |
| | | | 0.7837 | 0.8433 | 0.8933 | 0.9308 | 0.9558 | 0.9758 | 0.9862 | 0.9937 | 0.9983 | 1.0000 |

Table B.10 Dimensionless ordinates and x/L_R for hull forms E, K and L of the series MARAD

| Waterline | Station and x/L_R Measured from AP | | | | | | | | | | | |
|-----------|--------------------------------------|--------|----|--------|--------|--------|--------|--------|--------|--------|--------|--------|
| | -1½ | -1 | -½ | 0 | ½ | 1 | 1½ | 2 | 2½ | 3 | 3½ | 4 |
| 0.00 | | | | | | | 0.0008 | 0.0017 | 0.0246 | 0.0450 | 0.0550 | 0.0596 |
| 0.05 | | | | | | | 0.0195 | 0.0462 | 0.0842 | 0.1242 | 0.1575 | 0.2004 |
| 0.10 | | | | | | | 0.0296 | 0.0658 | 0.1092 | 0.1592 | 0.2037 | 0.2629 |
| 0.15 | | | | | | | 0.0350 | 0.0780 | 0.1279 | 0.1829 | 0.2442 | 0.3175 |
| 0.20 | | | | | | | 0.0396 | 0.0879 | 0.1437 | 0.2075 | 0.2817 | 0.3717 |
| 0.25 | | | | | | | 0.0417 | 0.0934 | 0.1587 | 0.2358 | 0.3233 | 0.4283 |
| 0.30 | | | | | | | 0.0429 | 0.1017 | 0.1770 | 0.2679 | 0.3742 | 0.4892 |
| 0.35 | | | | | | | 0.0433 | 0.1083 | 0.2004 | 0.3100 | 0.4371 | 0.5621 |
| 0.40 | | | | | | | 0.0425 | 0.1162 | 0.2321 | 0.3658 | 0.5142 | 0.6450 |
| 0.45 | | | | | | | 0.0450 | 0.1312 | 0.2829 | 0.4512 | 0.6054 | 0.7271 |
| 0.50 | | | | | | | 0.0508 | 0.1683 | 0.3737 | 0.5704 | 0.7029 | 0.7996 |
| 0.55 | | | | | | | 0.0642 | 0.2562 | 0.5112 | 0.6854 | 0.7858 | 0.8550 |
| 0.60 | | | | | | | 0.1054 | 0.4500 | 0.6550 | 0.7746 | 0.8483 | 0.8979 |
| 0.65 | | | | | | | 0.3621 | 0.6133 | 0.7587 | 0.8408 | 0.8942 | 0.9321 |
| 0.70 | | | | | | 0.2212 | 0.5700 | 0.7287 | 0.8267 | 0.8875 | 0.9275 | 0.9567 |
| 0.75 | | | | | | 0.4895 | 0.6983 | 0.8033 | 0.8746 | 0.9217 | 0.9517 | 0.9750 |
| 0.80 | | | | | 0.0200 | 0.6467 | 0.7737 | 0.8537 | 0.9079 | 0.9458 | 0.9575 | 0.9654 |
| 0.85 | | | | 0.2733 | 0.5900 | 0.7304 | 0.8275 | 0.8900 | 0.9325 | 0.9621 | 0.9792 | 0.9912 |
| 0.90 | | | | 0.4983 | 0.6821 | 0.7875 | 0.8650 | 0.9158 | 0.9479 | 0.9737 | 0.9875 | 0.9950 |
| 1.00 | | | | 0.6175 | 0.7400 | 0.8777 | 0.8912 | 0.9330 | 0.9600 | 0.9808 | 0.9925 | 0.9967 |
| 1.10 | | 0.2658 | | 0.6779 | 0.7842 | 0.8583 | 0.9112 | 0.9475 | 0.9692 | 0.9862 | 0.9954 | 0.9992 |
| 1.20 | 0.3237 | 0.5196 | | 0.7525 | 0.8325 | 0.8917 | 0.9337 | 0.9625 | 0.9787 | 0.9912 | 0.9983 | 1.0000 |
| 1.30 | 0.4821 | 0.6012 | | 0.7921 | 0.8592 | 0.9117 | 0.9458 | 0.9704 | 0.9833 | 0.9942 | 0.9983 | 1.0000 |
| 1.40 | 0.5467 | 0.6442 | | 0.8117 | 0.8725 | 0.9200 | 0.9491 | 0.9717 | 0.9850 | 0.9942 | 0.9983 | 1.0000 |
| 1.50 | 0.5747 | 0.6642 | | 0.8204 | 0.8783 | 0.9208 | 0.9491 | 0.9717 | 0.9850 | 0.9942 | 0.9983 | 1.0000 |
| 1.50 | 0.5775 | 0.6700 | | 0.8212 | 0.8792 | 0.9212 | 0.9491 | 0.9717 | 0.9850 | 0.9942 | 0.9983 | 1.0000 |

Table B.11 Dimensionless ordinates and x/L_R for hull forms F of the series MARAD

| Waterline | Station and x/L_R Measured from AP | | | | | | | | | | | |
|-----------|--------------------------------------|---------|----------------|---|---------------|--------|----------------|--------|----------------|--------|----------------|--------|
| | $-1\frac{1}{2}$ | -1 | $-\frac{1}{2}$ | 0 | $\frac{1}{2}$ | 1 | $1\frac{1}{2}$ | 2 | $2\frac{1}{2}$ | 3 | $3\frac{1}{2}$ | 4 |
| 0.00 | -0.1250 | -0.0833 | -0.0417 | 0 | 0.0417 | 0.0833 | 0.1250 | 0.1667 | 0.2083 | 0.2500 | 0.2917 | 0.3333 |
| 0.05 | | | | | | | 0.0008 | 0.0058 | 0.0225 | 0.0408 | 0.0546 | 0.0717 |
| 0.10 | | | | | | | 0.0237 | 0.0508 | 0.0858 | 0.1250 | 0.1587 | 0.2033 |
| 0.15 | | | | | | | 0.0346 | 0.0704 | 0.1121 | 0.1596 | 0.2054 | 0.2654 |
| 0.20 | | | | | | | 0.0417 | 0.0837 | 0.1321 | 0.1875 | 0.2467 | 0.3192 |
| 0.25 | | | | | | | 0.0458 | 0.0937 | 0.1504 | 0.2130 | 0.2854 | 0.3742 |
| 0.30 | | | | | | | 0.0492 | 0.1033 | 0.1675 | 0.2421 | 0.3283 | 0.4325 |
| 0.35 | | | | | | | 0.0512 | 0.1100 | 0.1867 | 0.2758 | 0.3812 | 0.4950 |
| 0.40 | | | | | | | 0.0521 | 0.1171 | 0.2108 | 0.3171 | 0.4450 | 0.5650 |
| 0.45 | | | | | | | 0.0529 | 0.1262 | 0.2450 | 0.3737 | 0.5233 | 0.6492 |
| 0.50 | | | | | | | 0.0517 | 0.1458 | 0.2983 | 0.4675 | 0.6125 | 0.7308 |
| 0.55 | | | | | | | 0.0650 | 0.1892 | 0.3862 | 0.5754 | 0.7096 | 0.8021 |
| 0.60 | | | | | | | 0.0846 | 0.2812 | 0.5171 | 0.6887 | 0.7900 | 0.8575 |
| 0.65 | | | | | | | 0.1596 | 0.4550 | 0.6550 | 0.7787 | 0.8508 | 0.9008 |
| 0.70 | | | | | | | 0.3646 | 0.6137 | 0.7587 | 0.8425 | 0.8954 | 0.9337 |
| 0.75 | | | | | | | 0.2462 | 0.5650 | 0.7254 | 0.8271 | 0.8879 | 0.9575 |
| 0.80 | | | | | | | 0.4892 | 0.6871 | 0.8017 | 0.8742 | 0.9212 | 0.9742 |
| 0.85 | | | | | | | 0.3875 | 0.6342 | 0.7667 | 0.8512 | 0.9142 | 0.9696 |
| 0.90 | | | | | | | 0.5667 | 0.7200 | 0.8267 | 0.9075 | 0.9604 | 0.9933 |
| 0.95 | | | | | | | 0.6617 | 0.7767 | 0.8596 | 0.9129 | 0.9725 | 0.9983 |
| 1.00 | | | | | | | 0.2254 | 0.8175 | 0.8854 | 0.9600 | 0.9800 | 1.0000 |
| 1.10 | | | | | | | 0.4833 | 0.8483 | 0.9062 | 0.9458 | 0.9683 | 1.0000 |
| 1.20 | | | | | | | 0.8829 | 0.8829 | 0.9283 | 0.9600 | 0.9787 | 1.0000 |
| 1.30 | | | | | | | 0.9029 | 0.9392 | 0.9683 | 0.9837 | 0.9983 | 1.0000 |
| 1.40 | | | | | | | 0.9121 | 0.9437 | 0.9712 | 0.9950 | 0.9983 | 1.0000 |
| 1.50 | | | | | | | 0.9142 | 0.9446 | 0.9712 | 0.9950 | 0.9983 | 1.0000 |
| | | | | | | | 0.9142 | 0.9446 | 0.9712 | 0.9950 | 0.9983 | 1.0000 |

Table B.12 Dimensionless ordinates and x/L_R for hull forms G, N and P of the series MARAD

| Waterline | Station and x/L_R Measured from AP | | | | | | | | | | | |
|-----------|--------------------------------------|---------|---------|--------|--------|--------|--------|--------|--------|--------|--------|--------|
| | -1½ | -1 | -½ | 0 | ½ | 1 | 1½ | 2 | 2½ | 3 | 3½ | 4 |
| 0 | -0.1250 | -0.0833 | -0.0417 | 0 | 0.0417 | 0.0833 | 0.1250 | 0.1667 | 0.2083 | 0.2500 | 0.2917 | 0.3333 |
| 0.05 | | | | | | | 0.0025 | 0.0075 | 0.0183 | 0.0338 | 0.0567 | 0.0700 |
| 0.10 | | | | | | 0.0096 | 0.0342 | 0.0542 | 0.0888 | 0.1267 | 0.1583 | 0.2029 |
| 0.15 | | | | | | 0.0204 | 0.0454 | 0.0775 | 0.1175 | 0.1617 | 0.2058 | 0.2662 |
| 0.20 | | | | | | 0.0288 | 0.0538 | 0.0938 | 0.1400 | 0.1912 | 0.2462 | 0.3212 |
| 0.25 | | | | | | 0.0288 | 0.0596 | 0.1058 | 0.1600 | 0.2204 | 0.2912 | 0.3788 |
| 0.30 | | | | | | 0.0342 | 0.0629 | 0.1150 | 0.1779 | 0.2525 | 0.3396 | 0.4388 |
| 0.35 | | | | | | 0.0296 | 0.0654 | 0.1229 | 0.2004 | 0.2900 | 0.3954 | 0.5038 |
| 0.40 | | | | | | 0.0275 | 0.0667 | 0.1321 | 0.2271 | 0.3346 | 0.4583 | 0.5750 |
| 0.45 | | | | | | 0.0254 | 0.0688 | 0.1467 | 0.2667 | 0.3946 | 0.5350 | 0.6579 |
| 0.50 | | | | | | 0.0262 | 0.0767 | 0.1748 | 0.3250 | 0.4754 | 0.6267 | 0.7362 |
| 0.55 | | | | | | 0.0308 | 0.0921 | 0.2254 | 0.3758 | 0.5871 | 0.7146 | 0.8050 |
| 0.60 | | | | | | 0.0433 | 0.1183 | 0.3179 | 0.5362 | 0.6921 | 0.7921 | 0.8600 |
| 0.65 | | | | | | 0.0800 | 0.2129 | 0.4721 | 0.6592 | 0.7792 | 0.8521 | 0.9029 |
| 0.70 | | | | | | 0.2700 | 0.3800 | 0.6175 | 0.7521 | 0.8392 | 0.8979 | 0.9362 |
| 0.75 | | | | | | 0.4646 | 0.5525 | 0.7217 | 0.8229 | 0.8871 | 0.9312 | 0.9604 |
| 0.80 | | | | | | 0.6046 | 0.6733 | 0.7917 | 0.8742 | 0.9229 | 0.9546 | 0.9762 |
| 0.85 | | | | 0.1650 | 0.0975 | 0.3583 | 0.7542 | 0.8442 | 0.9108 | 0.9467 | 0.9712 | 0.9875 |
| 0.90 | | | | 0.3858 | 0.5196 | 0.6967 | 0.8088 | 0.8842 | 0.9338 | 0.9617 | 0.9825 | 0.9946 |
| 0.95 | | | | 0.5162 | 0.6183 | 0.7525 | 0.8492 | 0.9117 | 0.9479 | 0.9204 | 0.9883 | 0.9971 |
| 1.00 | | | | 0.7288 | 0.6846 | 0.7954 | 0.8775 | 0.9283 | 0.9583 | 0.9788 | 0.9933 | 0.9992 |
| 1.10 | | | 0.2100 | 0.5922 | 0.7321 | 0.8288 | 0.9408 | 0.9408 | 0.9662 | 0.9338 | 0.9962 | 1.0000 |
| 1.20 | 0.3054 | 0.3667 | 0.5483 | 0.6838 | 0.7933 | 0.8692 | 0.9212 | 0.9567 | 0.9758 | 0.9908 | 0.9979 | 1.0000 |
| 1.30 | 0.3979 | 0.4838 | 0.6183 | 0.7288 | 0.8175 | 0.8842 | 0.9292 | 0.9625 | 0.9796 | 0.9933 | 0.9979 | 1.0000 |
| 1.40 | 0.4433 | 0.5025 | 0.6504 | 0.7479 | 0.8292 | 0.8917 | 0.9325 | 0.9642 | 0.9808 | 0.9923 | 0.9979 | 1.0000 |
| 1.50 | 0.4550 | 0.5700 | 0.6654 | 0.7588 | 0.8362 | 0.8950 | 0.9329 | 0.9512 | 0.9808 | 0.9933 | 0.9979 | 1.0000 |
| | | | 0.6717 | 0.7633 | 0.8396 | 0.8958 | 0.9329 | 0.9642 | 0.9808 | 0.9933 | 0.9979 | 1.0000 |

Table B.13 Dimensionless ordinates and x/L_R for hull forms H of series MARAD

| Waterline | Station and x/L_R Measured from AP | | | | | | | | | | | |
|-----------|--------------------------------------|---------|---------|--------|--------|--------|--------|--------|--------|--------|--------|--------|
| | -1½ | -1 | -¾ | 0 | ¼ | 1 | 1½ | 2 | 2½ | 3 | 3½ | 4 |
| 0 | | | | | | | | | | | | |
| 0.05 | -0.1240 | -0.0833 | -0.0417 | 0 | 0.0417 | 0.0833 | 0.1250 | 0.1667 | 0.2083 | 0.2500 | 0.2917 | 0.3333 |
| 0.10 | | | | | | | 0.0042 | 0.0083 | 0.0208 | 0.0508 | 0.0683 | 0.0721 |
| 0.15 | | | | | | 0.0142 | 0.0329 | 0.0604 | 0.0888 | 0.1279 | 0.1592 | 0.1983 |
| 0.20 | | | | | | 0.0221 | 0.0450 | 0.0767 | 0.1150 | 0.1613 | 0.2075 | 0.2654 |
| 0.25 | | | | | | 0.0267 | 0.0529 | 0.0883 | 0.1363 | 0.1908 | 0.2500 | 0.3246 |
| 0.30 | | | | | | 0.0300 | 0.0550 | 0.0971 | 0.1542 | 0.2179 | 0.2904 | 0.3788 |
| 0.35 | | | | | | 0.0275 | 0.0563 | 0.1158 | 0.1742 | 0.2488 | 0.3379 | 0.4408 |
| 0.40 | | | | | | 0.0238 | 0.0575 | 0.1279 | 0.1950 | 0.2850 | 0.3917 | 0.5054 |
| 0.45 | | | | | | 0.0217 | 0.0613 | 0.1438 | 0.2200 | 0.3308 | 0.4554 | 0.5758 |
| 0.50 | | | | | | 0.0213 | 0.0671 | 0.1679 | 0.2588 | 0.3900 | 0.5317 | 0.6542 |
| 0.55 | | | | | | 0.0263 | 0.0792 | 0.2063 | 0.3179 | 0.4917 | 0.6200 | 0.7350 |
| 0.60 | | | | | | 0.0383 | 0.1063 | 0.3050 | 0.4033 | 0.5800 | 0.7029 | 0.8008 |
| 0.65 | | | | | | 0.1075 | 0.1792 | 0.4729 | 0.6588 | 0.6817 | 0.7875 | 0.8588 |
| 0.70 | | | | | | 0.7888 | 0.4025 | 0.6217 | 0.7600 | 0.7763 | 0.8558 | 0.9033 |
| 0.75 | | | | | | 0.4763 | 0.5583 | 0.7142 | 0.8263 | 0.8892 | 0.9308 | 0.9579 |
| 0.80 | | | | | 0.1429 | 0.3804 | 0.6833 | 0.7996 | 0.8746 | 0.9221 | 0.9542 | 0.9750 |
| 0.85 | | | | | 0.3804 | 0.6150 | 0.7638 | 0.8492 | 0.9067 | 0.9446 | 0.9696 | 0.9858 |
| 0.90 | | | | | 0.5792 | 0.7071 | 0.8167 | 0.8858 | 0.9296 | 0.9600 | 0.9808 | 0.9933 |
| 0.95 | | | | | 0.6388 | 0.7683 | 0.8554 | 0.9121 | 0.9421 | 0.9704 | 0.9875 | 0.9973 |
| 1.00 | | | | | 0.7021 | 0.8079 | 0.8804 | 0.9296 | 0.9679 | 0.9779 | 0.9921 | 0.9992 |
| 1.10 | 0.0925 | 0.4075 | 0.5729 | 0.7004 | 0.7475 | 0.8375 | 0.9004 | 0.9425 | 0.9671 | 0.9833 | 0.9950 | 1.0000 |
| 1.20 | 0.3379 | 0.5075 | 0.6333 | 0.7417 | 0.8283 | 0.8917 | 0.9246 | 0.9583 | 0.9779 | 0.9908 | 0.9992 | 1.0000 |
| 1.30 | 0.4263 | 0.5546 | 0.6658 | 0.7633 | 0.8425 | 0.9013 | 0.9350 | 0.9650 | 0.9825 | 0.9946 | 1.0000 | 1.0000 |
| 1.40 | 0.4175 | 0.5783 | 0.6833 | 0.7742 | 0.8479 | 0.9033 | 0.9383 | 0.9658 | 0.9833 | 0.9950 | 1.0000 | 1.0000 |
| 1.50 | 0.4838 | 0.5888 | 0.6908 | 0.7783 | 0.8492 | 0.9033 | 0.9383 | 0.9658 | 0.9833 | 0.9950 | 1.0000 | 1.0000 |

Table B.14 Dimensionless ordinates and x/L_R for hull forms I and J of the series MARAD

| Waterline | Station and x/L_R Measured from AP | | | | | | | | | | | |
|-----------|--------------------------------------|---------|---------|--------|--------|--------|--------|--------|--------|--------|--------|--------|
| | -11 | -1 | -1/2 | 0 | 1/2 | 1 | 1 1/2 | 2 | 2 1/2 | 3 | 3 1/2 | 4 |
| 0.00 | -0.1740 | -0.0833 | -0.0417 | 0 | 0.0417 | 0.0833 | 0.1250 | 0.1667 | 0.2083 | 0.2500 | 0.2917 | 0.3333 |
| 0.05 | | | | | | | 0.0042 | 0.0083 | 0.0208 | 0.0508 | 0.0683 | 0.0721 |
| 0.10 | | | | | | | 0.0329 | 0.0604 | 0.0888 | 0.1279 | 0.1592 | 0.1983 |
| 0.15 | | | | | | 0.0142 | 0.0450 | 0.0767 | 0.1150 | 0.1613 | 0.2075 | 0.2654 |
| 0.20 | | | | | | 0.0221 | 0.0508 | 0.0883 | 0.1363 | 0.1908 | 0.2500 | 0.3246 |
| 0.25 | | | | | | 0.0267 | 0.0550 | 0.0971 | 0.1542 | 0.2179 | 0.2904 | 0.3788 |
| 0.30 | | | | | | 0.0300 | 0.0563 | 0.1063 | 0.1742 | 0.2488 | 0.3379 | 0.4408 |
| 0.35 | | | | | | 0.0275 | 0.0575 | 0.1158 | 0.1950 | 0.2850 | 0.3917 | 0.5054 |
| 0.40 | | | | | | 0.0238 | 0.0613 | 0.1279 | 0.2200 | 0.3308 | 0.4554 | 0.5758 |
| 0.45 | | | | | | 0.0217 | 0.0671 | 0.1438 | 0.2588 | 0.3900 | 0.5317 | 0.6542 |
| 0.50 | | | | | | 0.0213 | 0.0792 | 0.1679 | 0.3179 | 0.4917 | 0.6200 | 0.7350 |
| 0.55 | | | | | | 0.0263 | 0.1063 | 0.2063 | 0.4033 | 0.5800 | 0.7029 | 0.8008 |
| 0.60 | | | | | | 0.0383 | 0.1792 | 0.3050 | 0.5296 | 0.6817 | 0.7875 | 0.8588 |
| 0.65 | | | | | | 0.1075 | 0.4025 | 0.6217 | 0.6588 | 0.7763 | 0.8558 | 0.9033 |
| 0.70 | | | | | | 0.7888 | 0.5583 | 0.7142 | 0.7600 | 0.8450 | 0.9008 | 0.9358 |
| 0.75 | | | | | | 0.4763 | 0.6833 | 0.7996 | 0.8263 | 0.8892 | 0.9308 | 0.9579 |
| 0.80 | | | | | 0.1429 | 0.6150 | 0.7638 | 0.8492 | 0.8746 | 0.9221 | 0.9542 | 0.9750 |
| 0.85 | | | | | 0.3804 | 0.7071 | 0.8167 | 0.8858 | 0.9067 | 0.9446 | 0.9696 | 0.9858 |
| 0.90 | | | | 0.4175 | 0.6388 | 0.7683 | 0.8554 | 0.8929 | 0.9296 | 0.9600 | 0.9808 | 0.9933 |
| 0.95 | | | | 0.5375 | 0.7021 | 0.8079 | 0.8804 | 0.9121 | 0.9421 | 0.9704 | 0.9875 | 0.9975 |
| 1.00 | | | | 0.6154 | 0.7475 | 0.8375 | 0.9004 | 0.9296 | 0.9579 | 0.9779 | 0.9921 | 0.9992 |
| 1.10 | | 0.1075 | | 0.7004 | 0.8008 | 0.8729 | 0.9246 | 0.9483 | 0.9671 | 0.9833 | 0.9950 | 1.0000 |
| 1.20 | 0.3379 | 0.5075 | | 0.7417 | 0.8283 | 0.8917 | 0.9350 | 0.9583 | 0.9779 | 0.9908 | 0.9992 | 1.0000 |
| 1.30 | 0.4233 | 0.5546 | | 0.7733 | 0.8425 | 0.9013 | 0.9383 | 0.9558 | 0.9825 | 0.9946 | 1.0000 | 1.0000 |
| 1.40 | 0.4175 | 0.5283 | | 0.7742 | 0.8479 | 0.9033 | 0.9383 | 0.9558 | 0.9833 | 0.9950 | 1.0000 | 1.0000 |
| 1.50 | 0.4938 | 0.5888 | | 0.7783 | 0.8492 | 0.9033 | 0.9383 | 0.9558 | 0.9833 | 0.9950 | 1.0000 | 1.0000 |

References

1. Guldhammer H. E. FORMDATA I-V, Danish Technical Press, 1962 (FORMDATA I: various forms), 1963 (FORMDATA II: full and fine ships), 1967 (FORMDATA III: tanker and bulbous bow ships), 1969 (FORMDATA IV: fishing boats series)
2. Henschke W., (1964) Schiffbautechnisches Handbuch, Vol. II, VEB Verlag Technik, Berlin
3. Krappinger, O. (1963) Schiffswiderstand and Propulsion. Handbuch der Werften, Vol. VII
4. Roseman, D. P. (1987) The MARAD systematic series of hull form ship models. SNAME Publ.
5. Guldhammer & Harvald, (1974) Ship Resistance, Effect of Form and Principal Dimensions. Copenhagen, Akademisk Forlag
6. Molland, A., Turnock, S., Hudson, D. (2011), Ship Resistance and Propulsion: Practical Estimation of Propulsive Power, Cambridge University Press

Appendix C: Determination of Ship's Displacement with the Relational Method of Normand

Abstract: This chapter deals with the so-called “*Relational Method of Normand*”, by use of which the displacement and the weight components of a new ship can be determined on the basis of relevant data of a parent ship. Though some empirical coefficients used in the method are outdated, the methodological approach itself is of continuing value and can be readily used/adjusted to the needs of modern, computer-aided ship design optimization procedures, in which alternative designs are parametrically generated from the characteristics of parent hulls (optimization by use of genetic algorithms, Papanikolaou 2010).

Introduction: Assuming that there is a parent ship available, similar to the under design ship, for which the components of the various weight groups are wholly or partly known (weights of steel structure, equipment-outfitting, machinery, etc.), then the dimensions, the displacement and the weight breakdown of the new ship can be determined by the so-called “*Relational Method of Normand*”.

For the implementation of the above method, the knowledge of the functional relationships between the individual weight groups W_i to the displacement Δ , as well as to the other design parameters that are considered to be independent of the displacement (speed, range-endurance, etc.), is required.

The general form of the relationship for every different weight group W_i (index i) is given by:

$$W_i = w_{i0} (\Delta^{\mu_i} x^{\alpha_i} y^{\beta_i} z^{\gamma_i} \dots)^{n_i} k_i = w_{i0} (F_i)^{n_i} k_i \quad (C.1)$$

where,

- W_i : weight of group (i) (e.g. steel structure, outfitting, etc.)
- Δ : displacement
- x, y, z, \dots : design parameters, which are independent of displacement, but are affecting the W_i (e.g., speed, range-endurance, etc.)
- $\mu_i, \alpha_i, \beta_i, \gamma_i$: exponents of Δ, x, y, z related to the change of W_i with respect to Δ, x, y, z , which are considered to be known for similar ships
- n_i : exponent of the relational function $F_i = \Delta^{\mu_i} x^{\alpha_i} y^{\beta_i} z^{\gamma_i}$.
- w_{i0} : corrective coefficient of weight group W_i resulting from the ratio of a known weight group W_{i0} (parent ship, index: 0) to the known relational function $F_{i0}^{n_i} = (\Delta_0^{\mu_i} x_0^{\alpha_i} y_0^{\beta_i} z_0^{\gamma_i} \dots)^{n_i}$, that is, it is determined as:
 $w_{i0} = W_{i0} / F_{i0}^{n_i}$
- k_i : coefficient of specificity of the ship, which describes deviations of main characteristics from the parent ship (e.g., for a general cargo ship: transportation of heavy cargoes, strengthening for ice navigation, etc.); it is given for the different weight groups as an overall correction coefficient and is defined as: $k_i = w_{i1} / w_{i0}$

Equation of Displacement for Small Deviations

The following methodology for calculating the displacement Δ can be applied when the deviations of the study ship from the parent are relatively small. These deviations should not exceed 10–20% with respect to the displacement, especially when it comes to small vessels (lower limit of possible deviation).

It is considered that under the above assumptions the weight groups W_i vary as to the displacement with the exponential powers: $(n\mu)_i=0, 2/3$ and 1, i.e., $\Delta^0, \Delta^{2/3}$ and Δ^1 and they are independent of other parameters, namely: $\alpha_i = \beta_i = \gamma_i = 0$.

The equation of the displacement, as the sum of weights, has the form:

$$\Delta = \sum_{i=1}^8 W_i \quad (C.2)$$

where:

$$W_L \begin{cases} W_1 \equiv W_{ST} : \text{Steel Structure Weight} \\ W_2 \equiv W_{OT} : \text{Outfitting Weight} \\ W_3 \equiv W_M : \text{Machinery Installation Weight} \end{cases}$$

$$DWT \begin{cases} W_4 \equiv W_{LO} : \text{Payload Weight} \\ W_5 \equiv W_P : \text{Weight of Passengers and effects (luggage)} \\ W_6 \equiv W_{CR} : \text{Weight of Crew and effects (luggage)} \\ W_7 \equiv W_{PR} : \text{Weight of Provisions and Stores} \\ W_8 \equiv W_F : \text{Weight of Fuel} \end{cases}$$

$$W_L = \sum_{i=1}^3 W_i : \text{Light Ship Weight} \quad (C.3)$$

$$DWT = \sum_{i=4}^8 W_i : \text{Deadweight} \quad (C.4)$$

The functional relationships of the above groups W_i with the displacement Δ are as follows:

1. **Steel Structure** ($i=1$)
 $W_{ST} \propto \Delta^1$, exponent: 1
2. **Equipment-Outfitting** ($i=2$)
 $W_{OT} \propto \Delta^1$, exponent: 1
3. **Machinery Installation** ($i=3$)

$$W_M \propto P_B = \frac{\Delta^{2/3} \cdot V^3}{C_N}, \text{ exponent: } 2/3 \quad (C.5)$$

(based on the formula of the British Admiralty for the propulsive/break power P_B , C_N : Admiralty constant).

4. **Deadweight** ($i=4-8$)

The DWT is usually specified by the ship owner and is considered to be known and an independent parameter.

In case that only the *payload* W_{LO} ($i=4$) is predetermined by the owner (but not the *deadweight*), the remaining W_i values ($i=5-8$) are estimated as follows:

4a. **Payload** ($i=4$)

W_{LO} independent of Δ , exponent: 0

4b. **Weight of passengers** ($i=5$)

W_p independent of Δ , exponent: 0

(Number of passengers is determined by the shipowner)

4c. **Weight of crew** ($i=6$)

$W_{CR} \propto \Delta^{2/3}$, exponent: 2/3

The crew number is determined by relevant regulations and the owner; it is actually dependent on ship's type, tonnage GRT and installed power; in case it is not given, we assume approximately the number of crew being proportional to the installed power, as for the weight of machinery installation.

4d. **Weight of provisions and stores** ($i=7$)

$W_{PR} \propto N_{Pers} \cdot R/V$, exponent: 0

N_{Pers} : number of crew and passengers

R : range, endurance radius

V : speed

4e. **Weight of Fuel** ($i=8$)

$$W_F \propto P_B \cdot \frac{R}{V} = \frac{\Delta^{2/3} \cdot V^3}{C_N} \cdot \frac{R}{V}, \text{ exponent: } 2/3$$

Summing up the terms with *the same exponential power for the displacement*, we obtain for the parent ship (index: 0)

$$\text{exponent: } 1, A_0 = (1/\Delta_0^1) (W_{10} + W_{20})$$

$$\text{exponent: } 2/3, B_0 = (1/\Delta_0^{2/3}) (W_{30} + W_{60} + W_{80})$$

$$\text{exponent: } 0, C_0 = (1/\Delta_0^0) (W_{40} + W_{50} + W_{70})$$

For the ship under design (index: 1) it shows correspondingly:

$$\begin{aligned}
 A_1 &= (1/\Delta_1^1)(W_{11} + W_{21}) \\
 &= w_{10} \cdot k_1 + w_{20} \cdot k_2 \\
 B_1 &= (1/\Delta_1^{2/3})(W_{31} + W_{61} + W_{81}) \\
 &= (w_{30}k_3V_1^3 + w_{80}k_8V_1^2R_1)(1/C_{N1}) + w_{60}k_6 \\
 C_1 &= (1/\Delta_1^0)(W_{41} + W_{51} + W_{71}) \\
 &= w_{41} + w_{51} + w_{71}
 \end{aligned}$$

Comments/Notes

1. The first index (i) in the double indexing in the coefficients W_{ij} refers to each group of weights ($i=1$ to 8) and the second one (j) to the original (parent) ($j=0$) or the study ship ($j=1$).
2. All the values of the coefficients w_{ij} and k_i are considered given or calculable from data of the parent ship; they are defined as (see introduction):

$$w_{i0} = W_{i0} / (\Delta_0^{\mu_i} x_0^{\alpha_i} y_0^{\beta_i} z_0^{\gamma_i})^{n_i}$$

or

$$w_{i0} \cong W_{i0} / \Delta_0^{\mu_i n_i} \text{ (for small deviations)}$$

where $(\mu_i n_i)$ the known exponents 1, 2/3, 0 and W_{i0} , Δ_0 the corresponding weight groups and the displacement of the parent ship.

Likewise, we obtain for the coefficients of specificity:

$$k_i = w_{i1} / w_{i0}$$

where the prevailing sizes for the k_i are about one (1.0) and in dependence on the type of ship (see the following Sect. C.2).

3. The parameters V_1 (speed) and R_1 (range) are considered to be given by owner's specifications for the study ship. The Admiralty constant C_{N1} may differ from that of the parent vessel C_{N0} and this is expressed by the coefficient $k_C = C_{N0}/C_{N1}$

After the substitution of above relations in the equation for ship's displacement, we obtain:

$$\Delta = A \cdot \Delta + B \cdot \Delta^{2/3} + C$$

or with the index: 1 (for the study ship)

$$(1 - A_1) \cdot \Delta_1 - B_1 \Delta_1^{2/3} = C_1$$

where the unknown is the Δ_1 , while the constants A_1, B_1, C_1 are considered to be known.

The solution of the above nonlinear algebraic equation can be readily obtained graphically, by depicting the function corresponding to the left side of the equation for consecutive values of Δ and finding the intersecting point with the constant on the right side of the equation. Furthermore, the solution may be easily obtained by successive approximation of Δ (*trial and error*) or the method of Newton–Raphson (*regula falsi*).

The above described simplified method of Normand can be used for small deviations of the independent design parameters (Δ, V, R) from those of the parent ship, which should not exceed 10% (up to 20% marginally for large ships) for all the aforementioned parameters.

Displacement Equation for Larger Deviations

For larger deviations between the under design and the parent ship the described methodology in the preceding section is reformulated using more accurate relationships for the weight groups W_i with the displacement Δ and the other parameters x, y, z (e.g., speed, range, etc.), as they were defined in the introduction of the method:

$$W_i = w_{i0} (\Delta^{\mu_i} x^{\alpha_i} y^{\beta_i} z^{\gamma_i})^{n_i} \cdot k_i \quad (\text{C.6})$$

In the following, the exponential values $\mu_i, n_i, \alpha_i, \beta_i, \gamma_i$ and the coefficients k_i are defined more precisely in dependence to ship type and the special constructional features of the ship under design. The below given quantities are deduced from systematic variations of prototype constructional solutions² (acc. to Danckwardt in Lamb eds. 2003).

1. Steel Structure

$$W_{ST} \cong w_{ST0} \Delta^{\mu_{ST}} \alpha_{ST1} \kappa_{ST1} \quad (\text{C.7})$$

where

$$w_{ST0} = \frac{W_{ST0}}{\Delta_0^{\mu_{ST}}}$$

$$\alpha_{ST1} = \left[\frac{(\nabla_N / \text{DWT})_1}{(\nabla_N / \text{DWT})_0} \right]^{1/3}$$

² It should be noted that though the Relational Method is conceptually applicable to all types of ships and independently of the year of built, the given empirical coefficients greatly depend on ship's year of built, associated shipbuilding technology and ship type/size; thus, employed empirical coefficients need to be revisited, before use.

Table C.1 Correction coefficient accounting for special structural features

| | $(\kappa_{ST})_i$ |
|-------------------------------------|-------------------|
| Riveting, depending on the extent | $\pm 0.01-0.10$ |
| Strengthening for navigation in ice | $\pm 0.015-0.045$ |
| Ore transportation | ± 0.06 |
| Heavy lift equipment | ± 0.04 |
| Open sea shipping | ± 0.03 |

∇_N : normal hold volume (N: normal)
 = grain volume + volume of tanks above the double bottom (deep-tanks) + net volume of refrigerated cargo (net-net)

κ_{ST} : correction coefficient accounting for special structural features of the study ship compared to the parent ship. Generally:

$$\kappa_{ST} = 1.0 + \sum_{(i)} \kappa_{STi}$$

μ_{ST} : displacement exponent

= 0.92 for tankers

= 0.93 for ore carriers with 2 longitudinal bulkheads

= 0.98 for bulk carriers

= 0.975 for general cargo ships with $L/B=7$, $L/D=11$ and 2 decks,
 for ± 1 deck: ± 0.03

for ± 1 unit of difference of L/D : ± 0.02 (valid for $\Delta > 3500$ t).

Comments/Notes

1. In the above correction coefficients $(\kappa_{ST})_p$, the upper (positive) sign applies to cases for which the corresponding strengthening or feature is planned for the under design ship, but is not present at the parent ship. The opposite applies to the negative sign.
2. The use of coefficient κ_{ST} for structural differences other than those mentioned for the $(\kappa_{ST})_i$ is not appropriate, because of the lack of a direct relationship of the displacement Δ to such possible differences (e.g., extent of superstructures, bulkheads number etc.). It is recommended that such special structural features are taken into account separately; namely, by using appropriate methods or diagrams (e.g. Puchstein's method for the varying number of decks of general cargo ships or for the increase of weight by 0.05 t for every 1 m³ volume of deep-tanks). The resulting values of weight differences are added to or subtracted from the corresponding values of the parent ship.
3. For small deviations the formula is simplified as follows:

$$W_{ST} \cong w_{ST0} \cdot \Delta \cdot \kappa_{ST}$$

2. Equipment-Outfitting

The weight of this group category can be subdivided into several subgroups³, such as:

$$W_{OT} = W_{OTM} + W_{OTR} + W_{OTC} + W_{OTP} + W_{OTL} \quad (C.8)$$

where

- W_{OTM} : weight of main outfitting, beyond those listed below
- W_{OTR} : weight of reefer installation and insulation
- W_{OTC} : outfitting weight of crew
- W_{OTP} : outfitting weight of passengers
- W_{OTL} : weight of heavy lift equipment.

Apparently, this subdivision may be different for various ship types (see alternatively Sect. 2.4.5); it is herein recommended for general cargo ships, transporting refrigerated cargo, up to 12 passengers beyond the crew and general cargo.

2a. Calculation of subgroup weight W_{OTM}

$$w_{OT0} = \left(\frac{W_{OT}}{\Delta^{\mu_{OT}}} \right)_0 W_{OTM} = W_{OT0} \Delta^{\mu_{OT}} b_{OT1} c_{OT1} k_{OT1} \quad (C.9)$$

$b_{OT1} = 1 \pm 0.05$ for ± 1 deck of accommodation

$c_{OT1} = 1 \pm 0.10$ for the existence (or not) of steel hatch covers in the intermediate decks

$k_{OT1} = w_{OT1}/w_{OT0}$ coefficient of specificity of outfitting (e.g. *quality* of accommodation)

$\mu_{OTM} \cong 0.90$ (independent of ship's main dimensions)

2b. Calculation of subgroup weight W_{OTR}

$$w_{OTR} = \left(\frac{W_{OTR}}{\Delta^{\mu_{OTR}}} \right)_0 W_{OTR} = W_{OTR} \Delta^{\mu_{OTR}} k_{OTR} \quad (C.10)$$

where

$$w_{OTR} = \left(\frac{W_{OTR}}{\Delta^{\mu_{OTR}}} \right)_0$$

$$\mu_{OTR} \cong 0.67$$

$$\left. \begin{array}{l} k_{OTR} = 1 + 0.45 \text{ for insulation with cork} \\ \\ = 1 - 0.15 \text{ for insulation with Alfol} \end{array} \right\} \text{Instead of insulation with glass wool}$$

³ As applicable to different ship types.

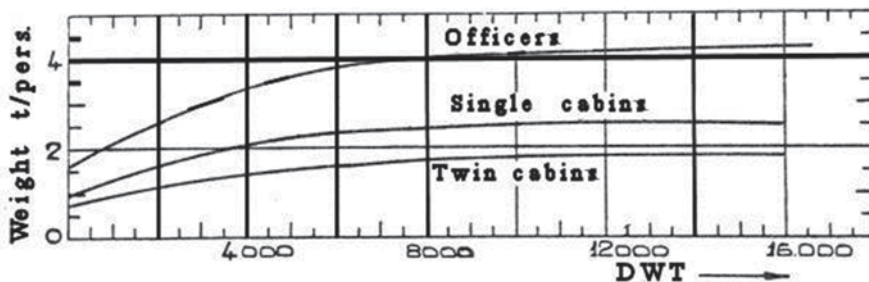

Fig. C.1 Outfitting weight of accommodation, depending on the crew

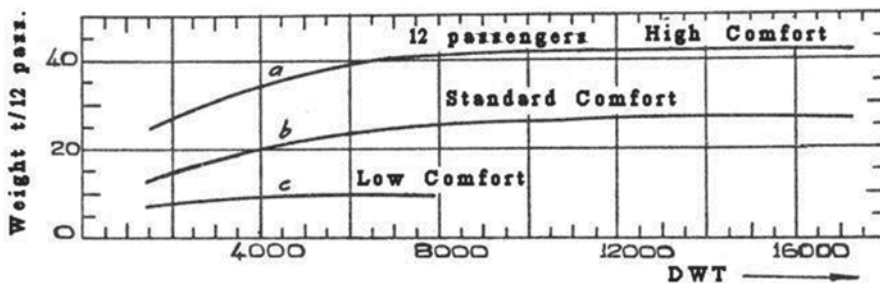

Fig. C.2 Outfitting weight of accommodation for 12 passengers onboard of cargo ships

2c. Calculation of subgroup weight W_{OTC}

$$w_{OTC} = \left(\frac{W_{OTC}}{\Delta^{\mu_{OTC}}} \right)_0 \quad W_{OTC} = w_{OTC} \Delta^{\mu_{OTC}} \quad (C.11)$$

$$\begin{aligned} \mu_{OTC} &\cong 0.667 \text{ for } \Delta < 7,000 \text{ t} \\ &0.250 \text{ for } \Delta > 7,000 \text{ t} \end{aligned}$$

Remarks: As the ship owner usually predefines the number and composition of the crew, the weight of the subgroup W_{OTC} may be considered as independent of the other variables and can be calculated on the basis of the given crew number N_{CR} :

$$W_{OTC} = f(N_{CR}) \text{ (see Fig. C.1)}$$

2d. Calculation of subgroup weight W_{OTP}

Given the number of passengers N_p and the quality of accommodation according to the specifications of the ship owner, the weight of W_{OTP} is calculated as:

$$W_{OTP} = f(N_p, \text{ quality of accommodation})$$

from proper diagrams (see, e.g., Fig. C.2)

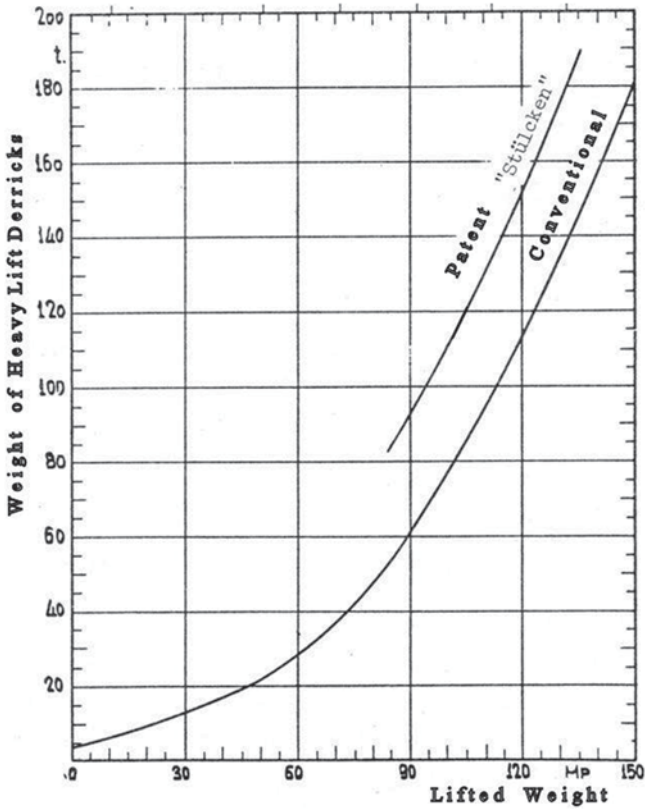

Fig. C.3 Weight of heavy lift derricks including masts, booms and rigging as a function of lifting capacity in tons

2e. Calculation of subgroup weight W_{OTL}

Given the lifting capability F_L of the heavy derricks/cranes, the subgroup weight W_{OTL} is obtained as:

$$W_{OTL} = f(F_L)$$

from proper diagrams (see, e.g., Fig. C.3)

2f. Empirical formula for the overall outfitting of general cargo ships, without specificities of 2b, 2d and 2e

$$W_{OT} = w_{OT0} \Delta^{\mu_{OT}} b_{OT1} c_{OT1} \tag{C.12}$$

where $b_{OT1} = 1 \pm 0.04$
 $c_{OT1} = 1 \pm 0.04$

w_{OT0} and μ_{OT} are the same as in the above formula (C.9).

2h. Empirical formula for the overall outfitting of tankers (including pumps and pipelines of tanks) and bulk carriers

$$W_{OT} = w_{OT0} \Delta^{\mu_{OT}} \quad (C.13)$$

where $w_{OT0} = \left(\frac{W_{OT}}{\Delta^{\mu_{OT}}} \right)_0$ (from similar type tanker ships)

$$\begin{aligned} \mu_{OT} &\cong 0.667 \text{ for } \Delta < 20,000 \text{ tons} \\ &\cong 0.360 \text{ for } \Delta > 20,000 \text{ tons.} \end{aligned}$$

Similar exponents of the same formula are given for ore carriers:

$$\begin{aligned} \mu_{OT} &\cong 0.77 \text{ for } \Delta < 20,000 \text{ t} \\ &\cong 0.60 \text{ for } \Delta > 20,000 \text{ t} \end{aligned}$$

Bulk carriers:

$$\mu_{OT} \cong 0.50 \text{ (regardless of their size)}$$

3. Machinery Installation

The weight of the machinery installation is concluded from the pre-estimated required propulsive power P (shaft or break horse power), the estimation of which was explained in Sect. 2.14. Splitting the weight of machinery installation W_M into the weight of the main machinery W_{MM} (for diesel engines, including the gearbox, as applicable) and the weight of the rest machinery installation W_{MR} (*Rest Machinery*: pipes, pumps and auxiliaries in the machinery room, etc., but also propeller shafts and propellers, if not calculated separately), we obtain for the total weight W_M :

$$W_M = W_{MM} + W_{MR} \quad (C.14)$$

where $W_{MM} \cong w_{MM0} P_S^{\mu_{MM}} k_{MM1}$

$$w_{MM0} = \left(\frac{W_{MM}}{P_S^{\mu_{MM}}} \right)_0$$

where P_S : propulsive shaft horse power.

$$k_{MM1} = \left(\frac{W_{MM1}}{W_{MM0}} \right)$$

$$\begin{aligned} \mu_{MM} &\cong 1.0 \text{ for } P_S < 7,000 \text{ HP} \\ &0.57 \text{ for } P_S > 7,000 \text{ HP} \end{aligned} \left. \vphantom{\begin{aligned} \mu_{MM} &\cong 1.0 \text{ for } P_S < 7,000 \text{ HP} \\ &0.57 \text{ for } P_S > 7,000 \text{ HP} \end{aligned}} \right\} \text{ turbine engine} \\ &0.90 \text{ for } P_S > 2,000 \text{ HP, diesel engine without turbocharger} \\ &0.82 \text{ for } P_S > 2,000 \text{ HP, diesel engine with turbocharger} \end{aligned}$$

In any case, when it comes to diesel engine propulsive installation, the weights of the main engine and the gearbox (if any) can be accurately estimated by using the manufacturers' catalogs. The weight of the rest machinery installation for a diesel engine propulsion system can be approximated as:

$$W_{MR} \cong w_{MR0} P_S^{\mu_{MR}} k_{MR} \quad (C.15)$$

Where

$$w_{MR0} = \left(\frac{W_{MR}}{P_S^{\mu_{MR}}} \right)_0$$

$$k_{MR1} = w_{MR1} / w_{MR0}$$

$$\begin{array}{l} \mu_{MR} \cong 0.80 \text{ for } P_S < 4,000 \text{ HP} \\ \quad 0.67 \text{ for } P_S > 4,000 \text{ HP} \\ \quad 0.67 \text{ for } P_S > 3,000 \text{ HP} \end{array} \left. \vphantom{\begin{array}{l} \mu_{MR} \cong 0.80 \text{ for } P_S < 4,000 \text{ HP} \\ \quad 0.67 \text{ for } P_S > 4,000 \text{ HP} \\ \quad 0.67 \text{ for } P_S > 3,000 \text{ HP} \end{array}} \right\} \text{engine room amidships}$$

$$\begin{array}{l} 0.675 \text{ for } P_S < 4,000 \text{ HP} \\ \quad 0.61 \text{ for } P_S > 4,000 \text{ HP} \\ \quad 0.49 \text{ turbine engine} \end{array} \left. \vphantom{\begin{array}{l} 0.675 \text{ for } P_S < 4,000 \text{ HP} \\ \quad 0.61 \text{ for } P_S > 4,000 \text{ HP} \\ \quad 0.49 \text{ turbine engine} \end{array}} \right\} \text{engine room atstern}$$

Comments/Notes

1. Coefficient of specificity $k_{MR1} \cong 1$ for an engine room position as for the parent ship, $k_{MR1} \cong 0.85$ for an engine room position of the study ship at stern, instead of at amidships for the parent ship.
2. Applies to relatively large ships with $P_S > 3,000$ HP

4. Deadweight DWT

The DWT is usually specified by the ship owner, who defines in this way the desired transport capacity of the ship. Consequently, the DWT is actually an independent parameter and should not be directly affected by the sought displacement. However, the ship owner may predetermine only the payload, so the rest components of DWT may be considered variable, except for the weight of the passengers (if any) and their effects, which is also independent of the displacement, as the number of passengers is specified by the ship owner as part of ship's payload.

For the variable components of DWT, we have:

4a. Weight of crew:

$$W_{CR} \cong w_{CR0} \Delta^{\mu_{CR}} k_{CR1} \quad (C.16)$$

$$w_{CR0} = \left(\frac{W_{CR}}{\Delta^{\mu_{CR}}} \right)_0$$

$$k_{CR1} = w_{CR1} / w_{CR0}$$

$$\mu_{CR} \cong 0.667 \text{ for } \Delta < 7,000 \text{ t}$$

$$0.250 \text{ for } \Delta > 7,000 \text{ t}$$

If the ship owner predefines the crew number N_{CR} , the W_{CR} is considered to be independent of Δ and is calculated as a function the N_{CR} .

4b. Weight of fuel:

$$W_F \cong w_{FO} \cdot P_S^{\mu_F} \cdot (R/V) \cdot k_{F1} \quad (C.17)$$

$$w_{FO} = \left(\frac{W_F}{P_S^{\mu_F}} \right)_0$$

V : speed [kn]

R : range [sm]

k_{F1} : coefficient of fuel specificity; takes into account differences in the specific gravity of the fuel (fuel oil quality)

μ_F : $\cong 1.0$

4c. Weight of provisions and stores:

• **Crew (CR):**

$$W_{PR} \cong w_{PR0} \cdot N_{CR} \cdot R/24V \quad (C.18)$$

$R/(24 V)$: days of the journey

$$w_{PR} = \left(\frac{W_{PR}}{N_{CR} \text{ day}} \right)_0 \text{ (weight of provisions per person per day)}$$

R : range [sm]

V : service speed [kn]

N_{CR} : is predetermined by the ship owner or relevant regulations

• **Passengers (P):**

$$W_{PR} \cong w_{PR0} \cdot N_P \cdot (R/24V) \cdot k_{PR1} \quad (C.19)$$

N_p : number of passengers

k_{PRI} : takes into account the quality of accommodation of passengers (use of water, etc.).

Comments (on the relationships for the weight groups 1~4):

- 1) The listed relationships for the different weight groups cannot fully satisfy all types of ships, the different sizes and their specificities. However, based on these relationships and the data of at least two to three similar ships, one can correct possible deficiencies of the aforementioned empirical exponents μ_i or of the specificity coefficients k_i and reach satisfactory approximations.
- 2) For groups of weights, which can be approximated by more accurate methods, for instance, the machinery installation (main machine), it is recommended to calculate them with the available more accurate data and further process this weight group as independent of displacement.

5. Differential solution of the displacement equation

The displacement of a ship under design (index: 1) is obtained from the corresponding parent ship (index: 0) by the relation:

$$\begin{aligned} \Delta_1 &= \Delta_0 + \delta\Delta = \sum_{(i)} (W_{io} + \delta W_i) \\ &= \sum_{(i)} W_{io} + \sum_{(i)} \delta W_i \end{aligned} \tag{C.20}$$

The differences δW_i can be calculated from a differential development of the function:

$$W_i = w_i \left(\Delta^{\mu_i} x^{\alpha_i} y^{\beta_i} z^{\gamma_i} \dots \right)^{n_i} k_i$$

keeping the first derivatives in terms of the independent variables Δ , x , y , z and k_i and omitting second order terms for small changes of these variables:

$$\delta W_i = \left[\frac{\partial W_i}{\partial \Delta} \delta\Delta + \frac{\partial W_i}{\partial x} \delta x + \frac{\partial W_i}{\partial y} \delta y + \frac{\partial W_i}{\partial z} \delta z + \frac{\partial W_i}{\partial k_i} \delta k \right] + \dots$$

where

$$\frac{\partial W_i}{\partial \Delta} = w_{io} \left[(n_i \mu_i) \Delta^{n_i \mu_i - 1} (x^{\alpha_i} y^{\beta_i} z^{\gamma_i} \dots)^{n_i} k_i \right]$$

$$\frac{\partial W_i}{\partial x} = w_{io} \left[(n_i \alpha_i) x^{n_i \alpha_i - 1} (\Delta^{\mu_i} y^{\beta_i} z^{\gamma_i} \dots)^{n_i} k_i \right]$$

and accordingly $\frac{\partial W_i}{\partial y}, \dots, \frac{\partial W_i}{\partial z}, \dots, \frac{\partial W_i}{\partial k}$.

Taking into account of the above derivatives, which can be calculated for the parent ship (index: 0), it can be shown by substitution in the formula for δW_i that:

$$\delta W_i = w_{io} \left[(n_i \mu_i) \frac{\delta \Delta}{\Delta_0} + n_i \left(\alpha_i \frac{\delta x}{x_0} + \beta_i \frac{\delta y}{y_0} + \gamma_i \frac{\delta z}{z_0} + \dots \right) + \frac{\delta k_i}{k_{i0}} \right]$$

Thus the displacement for the study ship (index 1) Δ_1 is obtained as:

$$\begin{aligned} \Delta_1 &= \sum_i W_{io} + \frac{\delta \Delta}{\Delta_0} \sum_{(i)} (n_i \mu_i) W_{io} \\ &+ \Delta_0 \sum_{(i)} \frac{W_{io}}{\Delta_0} \left[n_i \left(\alpha_i \frac{\delta x}{x_0} + \beta_i \frac{\delta y}{y_0} + \gamma_i \frac{\delta z}{z_0} + \dots \right) + \frac{\delta k_i}{k_{i0}} \right] \end{aligned}$$

Introducing the obtained relationships for weight groups W_i and the independent variables, for instance, Δ and $x \equiv V, y \equiv R$, which were presented previously (see subparagraphs 1–4), in the above equation, we can rewrite it in the following format:

$$\Delta_1 = \Delta_0 + \frac{\delta \Delta}{\Delta_0} \cdot A + \frac{\delta V}{V_0} \cdot B + \frac{\delta R}{R_0} \cdot C + D \quad (\text{C.21})$$

where the constants A, B, C, D are calculated based on the corresponding data of the parent ship, namely:

$$\begin{aligned} A &= \left[\mu_{ST} \frac{W_{ST0}}{\Delta_0} + \mu_{OT} \frac{W_{OT0}}{\Delta_0} + \mu_{OTR} \frac{W_{OTR0}}{\Delta_0} \right. \\ &\left. + \mu_{CR} \left(\frac{W_{CR0}}{\Delta_0} + \frac{W_{PR0}}{\Delta_0} + \frac{W_{OTC0}}{\Delta_0} \right) \right] \cdot \Delta_0 \end{aligned}$$

and likewise for the other constants B, C and D .

The above relationship for Δ_1 can be rearranged as follows:

Thus the differential of displacement $\delta \Delta$ is obtained:

$$\delta \Delta = G / (1 - E)$$

where

$$G = \Delta_0 \cdot F$$

$$F = \frac{\delta V}{V_0} \frac{B}{\Delta_0} + \frac{\delta R}{R_0} \frac{C}{\Delta_0} + \frac{D}{\Delta_0}$$

and

$$E = A/\Delta_0.$$

In the above expression for $\delta\Delta$, the denominator $(1-E)$, which is a dimensionless value, includes the changes of the different weight groups that are affected by the change of the displacement (see constant A). In contrary, the term G (numerator in the $\delta\Delta$ equation) refers to the effect of changing the other design variables, for instance, the velocity V , range R , coefficient of specificity k_p , which are independent of the displacement and are determined by the requirements of the ship owner.

By calculating the differential $\delta\Delta$, based on the data of the parent ship and the specificities of the under design ship, the solution of the equation of the displacement for the Δ_1 can be obtained.

From the above relations, it is concluded as well that for any weight group W_i , of the under design ship:

$$W_{i1} = W_{i0} + \delta W_i \quad (\text{C.22})$$

$$\delta W_i = W_{i0} \left[(n_i \mu_i) \frac{\delta\Delta}{\Delta_0} + n_i \left(\alpha_i \frac{\delta x}{x_0} + \beta_i \frac{\delta y}{y_0} + \gamma_i \frac{\delta z}{z_0} + \dots \right) + \frac{\delta k_i}{k_i} \right]$$

where $x \equiv V$ (speed)

$$y \equiv R \text{ (range)}$$

and accordingly for the other independent variables, if any.

Normand's Number

Studying the equation for the differential $\delta\Delta$:

$$\delta\Delta = G/(1-E) \quad (\text{C.23})$$

we may note that the denominator $(1-E)$ is a constant, for every category of similar ships. The ratio

$$N = 1/1-E \quad (\text{C.24})$$

is called “*Enhancement Coefficient or Number of Normand*”, obviously, it needs to be computed only once, when it comes to a category of similar ships. Thus the displacement is obtained as:

$$\Delta_1 = \Delta_0 + N \cdot G \quad (\text{C.25})$$

and for parametric, techno-economic feasibility studies (see Harvald in Friis et al. 2002) the work is restricted to the parametric calculation of G , where the parameters V and R can be varied systematically.

Normand's number can be calculated approximately by the following formulas:

a) According to *G. Manning*:

$$N = \frac{\Delta}{\Delta - (W_1 + W_4) - (2/3)(W_2 + W_3)} \quad (\text{C.26})$$

where

$$W_1 = W_{ST} + W_{OT} + W_{CR} + W_P$$

$$W_2 = W_M$$

$$W_3 = W_F$$

$$W_4 = W_{PR}$$

b) According to S. Harvald:

$$N = \frac{\Delta}{DWT + 0.2W_M + 0.53W_{OT}} \quad (\text{C.27})$$

or based on the relationship:

$$N = \frac{\Delta}{\Delta - P_a \Delta - (2/3)P_b \Delta^{2/3} - (1/3)P_c \Delta^{1/3}} \quad (\text{C.28})$$

where it has been assumed that the following applies to the displacement:

$$\Delta = P_a \Delta + P_b \Delta^{2/3} + P_c \Delta^{1/3} + P_d \Delta^0 \quad (\text{C.29})$$

The coefficients P_a , P_b and the Normand's number N can be determined by use of the diagrams 4 to 6 for small and large merchant ships. The coefficient P_c can be assumed as a constant equal to 7.5. The given curves of Normand's number, as a function of displacement and ship type, show the following trends:

- 1) Large dispersion of the points for some types of ships, where the speed, outfitting and structure is heterogeneous (for instance, passenger ships, general cargo ships). In contrast, low dispersion for tankers, bulk carriers, etc.
- 2) In general, an increase of the displacement and DWT entails a reduction of the number N . Indicative values are:

$$N \cong 1.25 - 1.35: \text{ tankers, bulk carriers}$$

$$\cong 1.35 - 1.65: \text{ general cargo ships and reefers}$$

$$\cong 2.00 - 2.50: \text{ passenger ships}$$

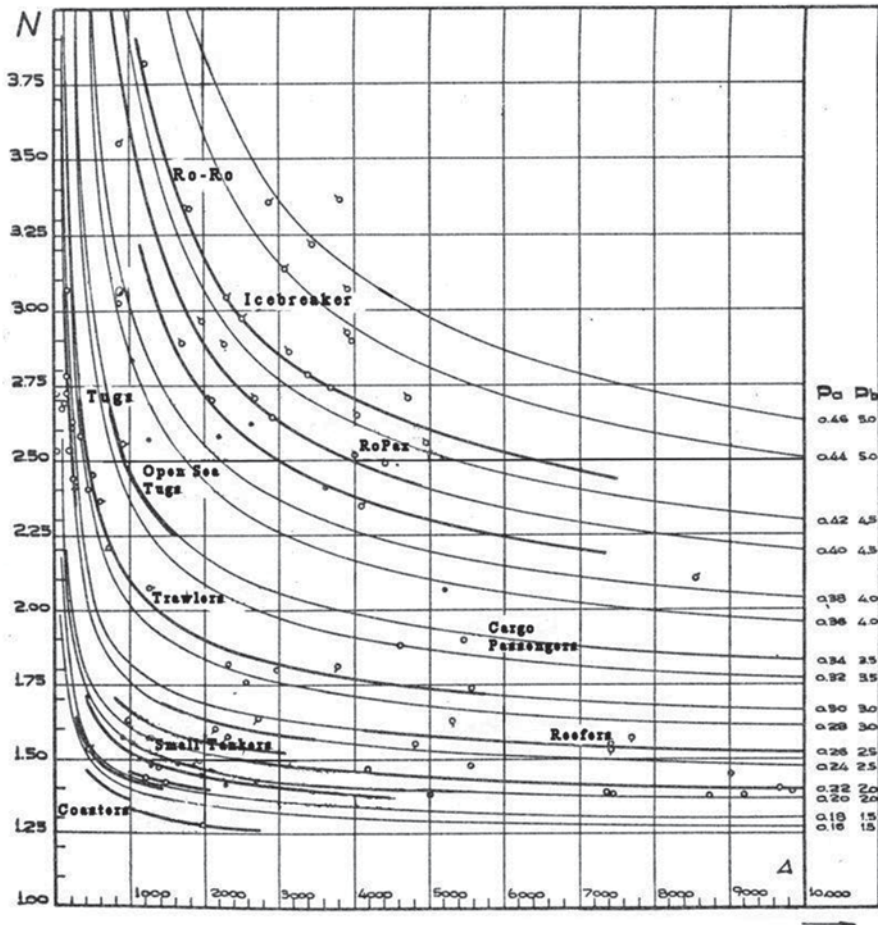

Fig. C.4 Normand's number for small merchant ships (Journal European Shipbuilding Progress, 1964)

The lower limits of the number N correspond to ships of restricted speed and outfitting. It is noted that the values for the Normand's number are similar to the *capacity factors* of the corresponding ship types (*ratio of deadweight to hold volume*, see Sect. 15.5.5, also Fig. 2.79).

- 3) Variation of the displacement, for the same type of ship, results in a change of the number N , but to a different gradient for different types and absolute sizes of ships; for instance, for a tanker with $\Delta = 100,000$ t a change of $\delta\Delta = 0.1\Delta$ implies $\delta N = 0.02N$, while for a cargo ship of 5,000 t displacement the change of Δ by 10% involves $\delta N = 0.04N$ (slope/gradient of $N = f(\Delta)$ curve is steeper; Figs. C.4, C.5 and C.6).

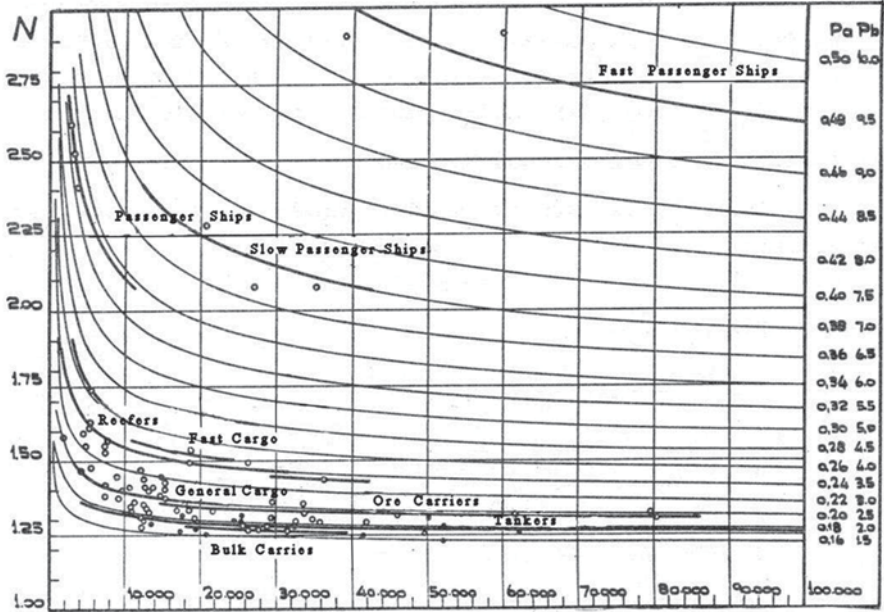

Fig. C.5 Normand's number for large merchant ships (Journal European Shipbuilding Progress, 1964)

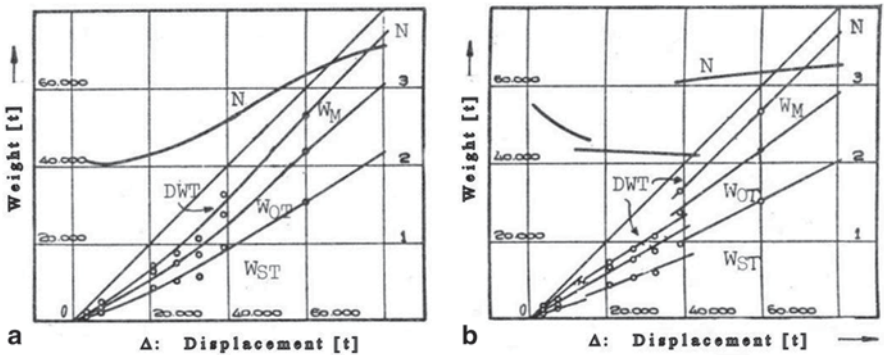

Fig. C.6 Breakdown of weights and Normand's number for passenger ships with continuous (a) and discontinuous (b) change of the breakdown of weights (Journal European Shipbuilding Progress, 1964)

c) Analytical formula for calculating Normand's number

Based on the relationships of the groups of weights with the displacement it shows:

$$N = 1/1 - E$$

Where

$$\begin{aligned}
 E &= \sum_i (n_i \mu_i) \frac{W_{io}}{\Delta_0} \\
 &= \mu_{ST} \frac{W_{ST_0}}{\Delta_0} + \mu_{OT} \frac{W_{OT_0}}{\Delta_0} + \mu_{OTR} \frac{W_{OTR}}{\Delta_0} \\
 &\quad + \mu_{CR} \left(\frac{W_{CR_0}}{\Delta_o} + \frac{W_{PR_0}}{\Delta_0} + \frac{W_{OT_0}}{\Delta_0} \right) \\
 &\quad + \frac{2}{3} \mu_{MR} \frac{W_{MR_0}}{\Delta_0} + \mu F \frac{W_{F_0}}{\Delta_0}
 \end{aligned}$$

in which we assume for the calculation of the propulsion break horsepower P_B for the W_{MR} and W_F :

$$P_B \propto \Delta^{2/3} V^3$$

according to the formula of the British Admiralty.

d) Simplifications of the relationships for small variations $\delta\Delta$, δV , δR :

$$\begin{aligned}
 \text{Steel structure : } W_{ST} &\cong k_{ST_0} \Delta^1 \\
 \text{Equipment - Outfitting : } W_{OT} &\cong k_{OT_0} \Delta^{2/3} \\
 \text{Reefer installation : } W_{OTR} &\cong k_{OTR_0} \Delta^{2/3} \\
 \text{Machinery installation : } W_M &\cong k_{M_0} \Delta^{2/3} V^3 \\
 \text{Fuel and lubricants : } W_F &\cong k_{F_0} \Delta^{2/3} V^2 R \\
 \text{Provisions and stores : } W_{PR} &\cong k_{PR_0} R/V \\
 \text{Payload : } W_L &: \text{ independent weight}
 \end{aligned}$$

Normand's number:

$$N = \frac{\Delta_0}{\Delta_0 - W_{ST_0} - \frac{2}{3} (W_{OT_0} + W_{OTR} + W_{M_0} + W_{F_0})}$$

Differential displacement:

$$\delta\Delta = N \left[\frac{\delta V}{V_0} (3W_{M_0} + 2W_{F_0} - W_{PR_0}) + \frac{\delta R}{R_0} (W_{F_0} + W_{PR_0}) + \delta W_L \right]$$

Differences in groups of weights:

$$\delta W_{ST} = W_{ST0} (\delta\Delta/\Delta_0)$$

$$\delta W_{OT} = W_{OT0} (\delta\Delta/\Delta_0)$$

$$\delta W_{OTR} = W_{OTR0} (2/3)(\delta\Delta/\Delta_0)$$

$$\delta W_M = W_{M0} \left(\frac{2}{3} \frac{\delta\Delta}{\Delta_0} + 3 \frac{\delta V}{V_0} \right)$$

$$\delta W_F = W_{F0} \left(\frac{2}{3} \frac{\delta\Delta}{\Delta_0} + 3 \frac{\delta V}{V_0} + \frac{\delta R}{R_0} \right)$$

$$\delta W_{PR} = W_{PR0} \left(\frac{\delta R}{R_0} - \frac{\delta V}{V_0} \right)$$

δW_L : independent weight

Differences of main dimensions (length, beam etc.) for geometrically similar ships,

namely, for $C_{B1} = C_{B0}$, $L_1/B_1 = L_0/B_0 = C_1$,
 $L_1/T_1 = L_0/T_0 = C_2, \dots$

$$\delta L \cong L_0 \left[\frac{1}{3} \frac{\delta\Delta}{\Delta_0} - \frac{1}{9} \left(\frac{\delta\Delta}{\Delta_0} \right)^2 \right]$$

$$\delta B \cong B_0 \left[\frac{1}{3} \frac{\delta\Delta}{\Delta_0} - \frac{1}{9} \left(\frac{\delta\Delta}{\Delta_0} \right)^2 \right]$$

$$\delta T \cong T_0 \left[\frac{1}{3} \frac{\delta\Delta}{\Delta_0} - \frac{1}{9} \left(\frac{\delta\Delta}{\Delta_0} \right)^2 \right]$$

The last relationships are derived by differential calculus of geometrically similar ships.

Accuracy of the Displacement Equation

Obviously, the accuracy of the calculations of Δ on the basis of the displacement equation by use of the relational (differential) method of Normand, as discussed above, depends on the following factors:

- a) Accuracy of exponents and correction factors in the relationships of weight groups.
- b) Reliability of the hypothesis that the above exponents and coefficients are independent of the displacement and the other independent variables. This assumption is valid only for small variations of the variables. In particular, for small ships, with $\Delta < 3,000$ t, a high dependence of $\mu_p, \alpha_p, \beta_p, \gamma_p, k_i$ on the displacement is present.
- c) The application of the method of calculating Δ on the basis of the solution of the displacement equation is appropriate for relatively small differences of the independent variables; particularly on small ships, $\delta\Delta$ may be up to 25% Δ . For larger ships, the differences may be larger and up to $\delta\Delta \cong 50\%$ and simultaneously δV up to 25% V . Moreover, the differences of the independent weights should be limited.
- d) An example of applying this method to a general cargo ship is given in Papanikolaou (1988).

References

1. Friis, A.M., Andersen, P., Jensen, J.J. (2002) Ship design (Part I & II). Section of Maritime Engineering, Dept. of Mechanical Engineering, Technical University of Denmark, ISBN 87-89502-56-6
2. Lamb, T. (eds) (2003) Ship design and construction. SNAME publication, revision of the book: D'Arcangelo, A.M. (eds) (1969) Ship design and construction. SNAME publication, New York
3. Papanikolaou A (1988) Ship Design, Vol. 2, Handbook of ship design (in Greek: Μελέτη Πλοίου, Β' Τόμος, Εγχειρίδιο Μελέτης), SYMEON Publisher, Athens
4. Papanikolaou, A. (2009), Ship Design—Methodologies of Preliminary Ship Design (in Greek: *Μελέτη Πλοίου—Μεθοδολογίες Προμελέτης Πλοίου*), SYMEON Publisher, Athens, Vol. 1, ISBN 978-960-9600-09-01 & Vol. 2, ISBN 978-969-9400-11-4, October 2009
5. Journal European Shipbuilding Progress (1964) Normand's Number (Vol. No. 1)

Appendix D: Historical Evolution of Shipbuilding

Abstract: The present Appendix D gives a retrospective view of developments of shipbuilding and related disciplines in science and technology from the BC era until today. The presented material is based on a lecture of the author presented on the occasion of the 170 years anniversary since the foundation of the National Technical University of Athens (venue: Evgenides Foundation Conference Center, December 7, 2007).

Fig. D.1 Relief of a trireme, about 410–400 BC, found in 1852 by Les Norman. It is today exhibited at the Acropolis Museum in Athens

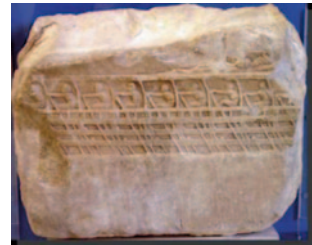

The art of the shipbuilding master

*«Κι αφού σκάρωσε κατάστρωμα και αρμολόγησε στραβόζηλα πυκνά,
το μαστόρευε...*

*και μέσα στήριξε κατάρτι με ταιριασμένη αντένα
κι έκαμε και το τιμόνι του να κυβερνάει το σκάφος...
κι η Καλύψω λινά του κουβαλούσε για τα πανιά.*

*Κι αυτός με τέχνη τά 'φτιαξε κι αυτά,
κι έδεσε μέσα ζάρτια και караβόσκοινα»*

Οδύσσεια, ε 253–260

*«And after he fixed the deck and assembled the curved wooden frames
densely, he worked on this ...*

*and he fitted inside the mast with proper head
and he prepared the steering wheel so to steer the boat ...
and Calypso was carrying him linens for the sails. And he artfully fixed
these too, and he lashed them with the rigs and shrouds.*

The Odyssey, Book 5, 253–260

Fig. D.2 Reconstructed ancient Athenian trireme 'Olympias'



Before Christ Era

The close relationship of human beings with the sea was enabled through ships and shipbuilding: from the primitive rafts of the Paleolithic and Neolithic times, the carved tree trunks, the canoes and the papyrelles⁴ to the first small boats with keel, planking, frames, railings, masts, sails, and to larger ships with side rudders and oars that appeared with the introduction of the bronze craft tools at the beginning of second millennium BC (Fig. D.3).

It should be recalled that Noah's Ark was the first floating vessel of human history described in fairly detailed manner in the *Genesis* flood narrative (*Genesis* Chaps. 6–9); following this, *Patriarch Noah* saved his family and a remnant of all the world's animals from a catastrophic flood that lasted 150 days and wiped out every living creature on the earth. God gave Noah detailed instructions for building the ark: it was to be of gopher wood, smeared inside and outside with pitch, with three decks and internal compartments; it should be 300 cubits⁵ long, 50 wide, and 30 high (approximately 137 by 23 by 14 m)⁶; it should have a roof “finished to a cubit upward”, and an entrance on the side (Fig. D.4).

The Phoenicians and the Egyptians seem to have significantly developed the art of shipbuilding, as was revealed, among others, through the discovery of a vessel from the 2,500 BC era near the Great Pyramid of Giza.

In Greece, the first known shipbuilders were coming from the Cycladic islands (third to second millennium BC), who passed the torch to the Cretans of the Minoan period (1700 to 1450 BC); the Mycenaean era followed (*Trojan War*).

Much later, in about the sixth century BC, the Athenians dominated with a particularly effective combat fleet. The renowned *Athenian trireme* was an oared ship with *tetragonal* sails, 35–45 m in length, 5–6 m wide, 1 m draft, 1.6 m freeboard, carrying up to 200 crew members, with 3 rows of oars per side, which gave her a speed of about 9 knots (may be up to 11 knots). According to *Herodotus*, 378 triremes took part in the naval battle of SALAMIS in the Saronic Bay of Attica (480 BC, 2nd Persian invasion of Greece) and under the lead of the Athenian General *Themistocles* badly defeated 1,207 Persian ships led by the Persian King *Xerxes* (Fig. D.5).

According to Aristotle, *Alexander the Great* was the first to use an *underwater* vehicle for a reconnaissance mission during the siege of Tyros (*Tyre*) in 332 BC (Fig. D.6). The famous *Kyrenia* shipwreck, which was found in very good condi-

⁴ Papyrella, was a primitive, pre-historical “ship” made from papyrus. The papyrus plant was abundant in the Nile Delta of Egypt and in wetland regions throughout the Mediterranean area. It was used as writing material in ancient Egypt, but also for the building of boats and the preparation of mats, ropes, baskets etc. Note that this kind of “ship” could be found in the Greek island of Corfu until few years ago.

⁵ The cubit is an archaic unit of length corresponding to the length of the forearm from the elbow to the tip of the middle finger. The Biblical cubit, first mentioned in the Hebrew Bible in the book of Genesis, refers to Noah's Arch and is estimated to be approximately 18 in. (or 45.72 cm).

⁶ *Amazingly, the length to beam ratio of Noah's Arch is 6.0 and length to side depth 10.0, thus within common ratios of main dimensions of modern ships!* (see Tables 2.4 and 2.5).

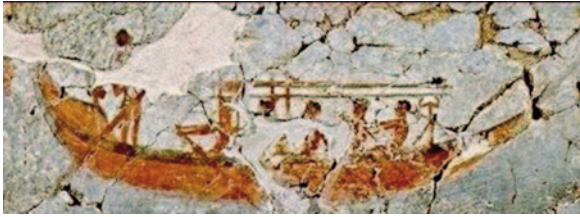

Fig. D.3 Archaeological findings indicate that some form of floating vehicles existed in the Aegean Sea already in the seventh millennium BC

Fig. D.4 Painting by Edward Hicks (1780–1849), 1846 Philadelphia Museum of Art



Fig. D.5 Reconstructed ancient Athenian trireme 'Olympias'. Length: 36.9 m, beam: 5.5 m, draft: 1.25 m, displacement: 70 t, propulsion power: two large squared sails and 170 oarsmen, speed: over 9 knots, complement (in antiquity): 200 crew + 5 officers (launched 1987)



tion, so that it could be rebuilt in the last years, was stemming from the same period (Fig. D.7).

Fundamental to ship theory and the evolution of shipbuilding were the contributions of the great Greek mathematician and scientist *Archimedes* (287–212 BC), with the introduction of the principle of buoyancy, of the basic laws of stability of floating bodies (Fig. D.8a) and of the functioning of propellers (Archimedes' screw; Fig. D.8b).

Fig. D.6 Seize of Tyros by Alexander the Great, (drawing by André Castaigne, 1888–1889)



Fig. D.7 Kyrenia shipwreck and replica (Kyrenia castle museum, Cyprus) Ship sank in year 288 (± 62) BC; it was discovered in year 1965; main ship dimensions 14 m length, 4.42 m wide, single square sail, 4–5 knots speed, 4 crew

The principles of stability of floating bodies are contained in Archimedes' most important treatise on ship's stability, namely «On Floating Bodies»⁷. This is a treatise

⁷ Original title of the treatise is *περί «οχομένων»*, literally translated: «on vehicles». This Archimedean treatise sets the foundations of ship's stability and introduces the fundamental concept

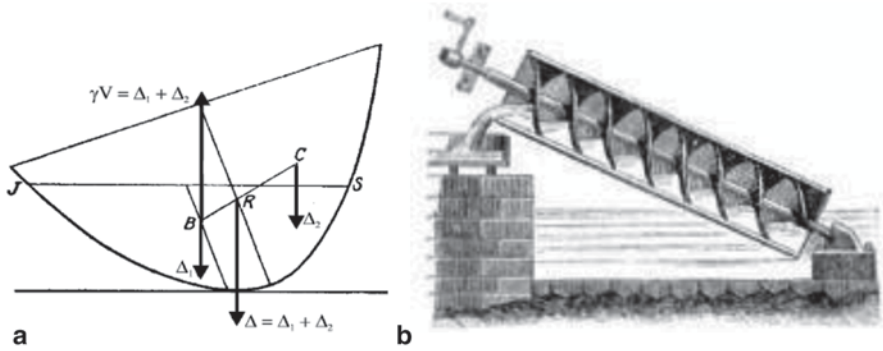

Fig. D.8 a Archimedes' approach to the stability of a floating paraboloid b Archimedes' screw

Fig. D.9 The famous *codex* of Archimedes *Palimpsest* (Walters Art Museum of Baltimore)



tise contained in the famous *codex* of Archimedes *Palimpsest*, which was lost in the sixteenth century AD until its reappearance at an auction in New York in year 1998. Since then, it is exhibited in the *Walters Art Museum of Baltimore* (<http://www.archimedespalimpsest.org/>) and is under investigation for reading the parts of the *codex*, which were not recognized or were possibly wrongly interpreted by previous historians-scholars (Fig. D.9).

Middle Ages—Renaissance

Shipbuilding has evolved slowly over the years and until the Middle Ages the basic characteristics of ships did not change dramatically, except for the increase of the size/transportation capacity and the number of oarsmen (the mythic *tessarakonteres* galley of Ptolemy IV, with assumed 4,000 oarsmen and later Roman galleys).

of couple of forces or moments for determining the stability of solids, including that of floating bodies. It is remarkable that the (until recently) generally accepted as founders of ship's stability, namely *Leonard Euler* and *Pierre Bouguer*, who introduced the notion of *metacenter* to ship theory and stability, did not take reference to Archimedes' work, which was conducted about 2,000 years earlier. The reasons for this omission are disputable.

Fig. D.10 Compass



A key point for the development of open *seagoing* ships was the invention of the modern compass, which enabled the long-distance sailing/navigation (1269 AD; Fig. D.10)⁸.

At the end of the Middle Ages, truly seagoing ships with extensive sails made their first appearance, while the displacements increased from abt. 100 to 300 t (up to 1,500 t the largest ones) disposing much larger transportation capacity.

One of the renowned seagoing ship designs was the French Caravel. With such a ship, *Cristoforo Colombo* (Columbus) discovered the Americas in 1492 (onboard of *Santa Maria*, length 29.8 m, displacement 130 t, sails 250.8 m²; Fig. D.11).

The period of great explorations of the fifteenth to seventeenth century was combined with the further developments of ships, but without radical changes in shipbuilding. The ships of the famous *Spanish Armada* of 1588 differed only slightly from the ships that took part in the disastrous for Spain naval battle of Trafalgar two centuries later (1802) (Fig. D.12).

Industrial Revolution

The industrial revolution in the nineteenth century influenced radically the evolution of modern shipbuilding:

- Brought the use of steam for power/energy generation (1769, J. Watt), about 2,000 years after the *steam engine of Heron from Alexandria* (*‘Spiritalia seu Pneumatica’*)
- Introduced the use of propellers for ship’s propulsion (1835, Sir Francis Pettit Smith), 2,000 years after the invention of Archimedes’ screw

⁸ The magnetic compass was developed in its original form in China between 1040 AD and 1117 AD; it was applied to the navigation of sailing ships in low visibility conditions. However, the contemporary magnetic compass with a rotating needle inside a tight box was later invented in Europe, namely in the thirteenth century AD. The depicted photo shows such a compass from a copy of the *‘Epistola de magnetē’* of Peter Peregrinus (1269).

Fig. D.11 Paint of van Eertvelt (1628) «Santa Maria»



Fig. D.12 Painting of Nicholas Pocock “the naval battle of Trafalgar” (1802)



- Brought the replacement of wood as the main construction material of ships by iron
- Solved fundamental issues of ship hydrodynamics and ship theory (resistance, propulsion and stability of ships, *s*) (Fig. D.13).

A most notable showcase of shipbuilding developments in the nineteenth century was the launching of *SS Great Britain* in 1843, which was the first steam powered ship, built of iron, with screw propeller propulsion; it was the second in a series of three large ships (*Great Western*, *Great Britain*, *Great Eastern*) designed the famous British *multi-discipline* engineer *Isambard Brunel* (Fig. D.14).

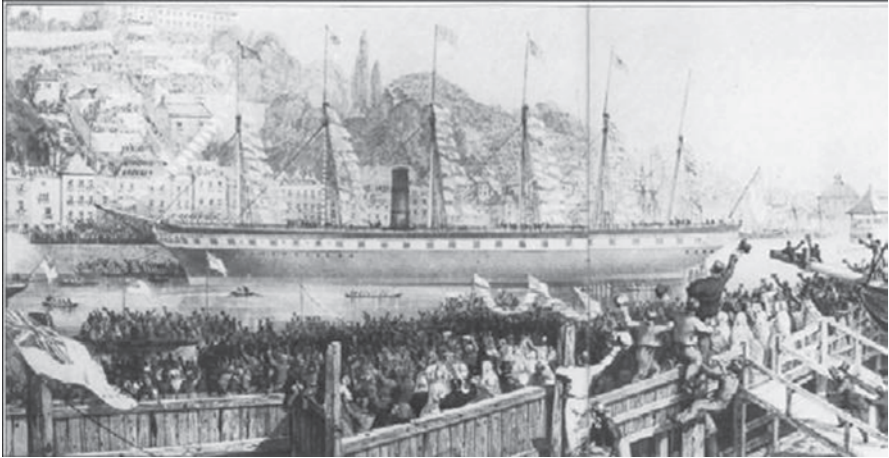

Fig. D.13 Great Britain 1843

Fig. D.14 Isambard Brunel
(1806–1859)



Engraving taken from a photo Isambard Kingdom Brunel in the year he died

In 1800 *Sir Humphry Davy* discovered the electric arc so that the introduction of welding with electrodes was enabled in the late nineteenth century by works of the Russian *Nikolai Slavyanov* and the American *C. L. Coffin* (Fig. D.15).



Fig. D.15 Welding

Fig. D.16 Replica of SS *Great Britain*'s original six-bladed propeller



The basic idea of Archimedes to propel water through a propeller (Archimedes' screw or 'helix') remained as a ship's propulsion means unexploited until 1835, when *Francis Pettit Smith* accidentally discovered that a propeller with *one single spiral* propelled a boat faster than a propeller with *many spirals*. Approximately at the same time, *Frédéric Sauvage* and *John Ericsson* submitted similar patents to protect the idea of a propeller with one spiral as propulsion means (Fig. D.16).

Finally, at the end of the nineteenth century the internal-combustion engines were introduced by the Germans *Nicolaus Otto* (1876, 4 stroke engine) and *Rudolf Diesel* (1893, 2 stroke engine).

The SS Great Eastern

The most important demonstrator of contemporary shipbuilding technology in the nineteenth century was the design of *SS Great Eastern* by *Isambard Brunel* (1806–1859), one of the 7 'wonders' of the industrial revolution. The ship was built by the Scottish civil and naval architect *J. Scott Russell & Co.* at Millwall on the River Thames, London. It had a length of 211 m, a beam of 25 m, a draft of 8 m and displacement of 22,000 t. She was by far the largest ship ever built at the time of her 1858 launch, and had the capacity to carry 4,000 passengers across the Atlantic Ocean (Fig. D.17).

Fig. D.17 Photo of SS Great Eastern

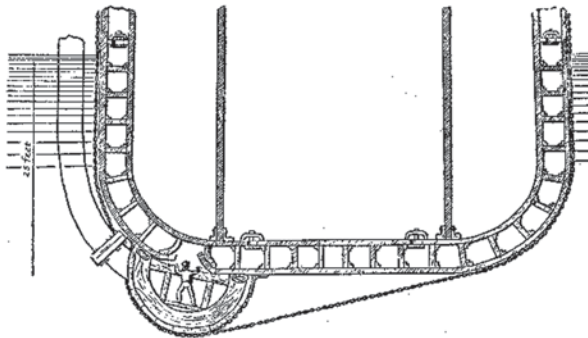

Sectional diagram of Renwick's cofferdam on the *Great Eastern*, from *Scientific American*.

Fig. D.18 SS *Great Eastern*: her remarkable *double-hull* design concept. (source: “The Great Iron Ship” by James Dugan); In late August of 1862, *SS Great Eastern* grounded on her way to New York, but she made it a few hours later without big trouble, listing a little to starboard. The outer hull had been ripped open by rock spire, still called Great Eastern Rock on the charts. *The breach was 83 feet long by 9 wide, perhaps 60 times the area of Titanic's damage—but the inner hull was unhurt and the inside was dry.* The above sketch from a 1917 article in the *Scientific American* shows her being repaired using a carved wooden cofferdam clamped to her side, an invention of another great engineer, Professor James Renwick of Columbia University (source: lecture by Roy Brander, “The RMS Titanic and its Times: When Accountants Ruled the Waves”, 69th Shock & Vibration Symposium, Minneapolis, 1998).

The *SS Great Eastern* was an entirely riveted iron construction made of 19 mm thickness, 0.86 m wide iron plates, reinforced with strengthening frames at every 1.8 m.

It was the first ship that had *double-hull side walls* (with a gap of 2 ft 10 in to the outer shell), an idea that was widely applied much later (in the 1980s–1990s and so far) in the design of RoPax and tanker ships, ensuring increased survivability respectively protection against oil spillage in the event of damage of ship's outer hull shell (Fig. D.18).

FACTS ABOUT THE GREAT EASTERN

Propulsion

- 2 paddles diameter 17 metres (56 feet)
- powered by 4 boilers producing 1000 horsepower
- sail area 604 square metres (6,500 square feet)
- screw diameter 7 metres (24 feet)
- powered by 6 boilers producing 1600 horsepower
- maximum speed 26kph (14 knots, 16mph)
- passenger capacity 4,000 (or up to 10,000 troops)

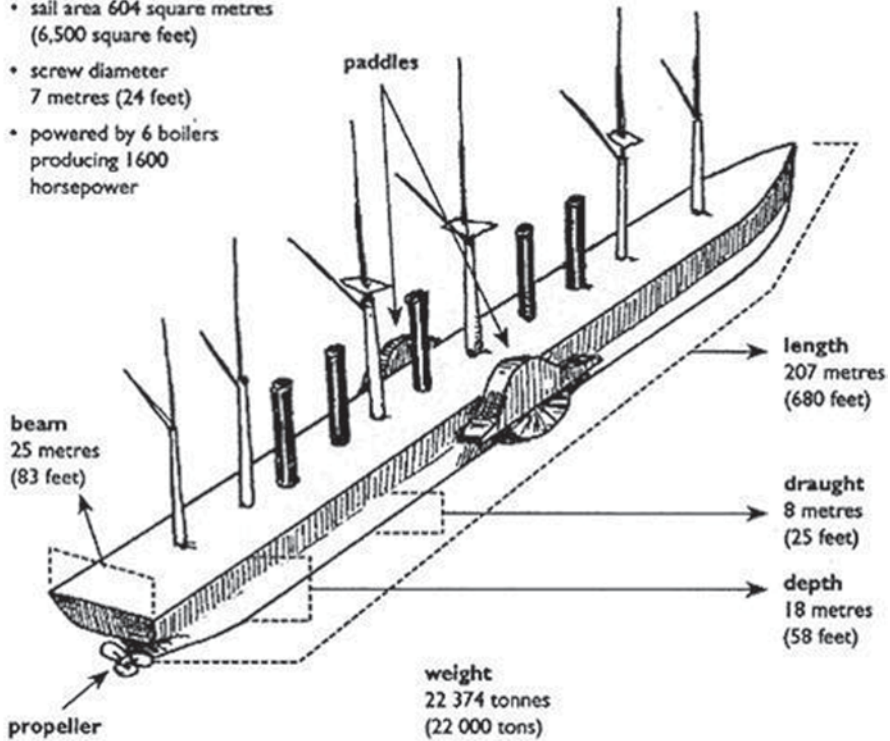

Fig. D.19 Main characteristics of the SS Great Eastern

She was propelled by two side paddle wheels of 18 m diameter that were driven by four 1,000 HP steam engines, while she possessed in addition a 4-bladed propeller of 7.3 m diameter driven by six 1,600 HP steam engines. Her speed was 13–14 kn. She had five 30 m high funnels of 2 m diameter. At her 6 masts she was carrying sails of a total area of 1,686 m². Her regular capacity was for 4,000 passengers, but could carry up to 10,000 troops (Figs. D.19 and D.20).

The following chart shows the enormous size of *SS Great Eastern* in comparison to other ships of the same period and ships constructed much later (Fig. D.21).

SS Great Eastern did not meet the expectations of *I. Brunel*, who died shortly after her problematic side-launching. After working for some years as transatlantic passenger liner, she was eventually converted to a cable-laying ship and enabled the laying of the *first lasting transatlantic telegraph cable in 1866*. In the last years of her life she was operated as a floating music hall in Liverpool; she was broken up in 1889.

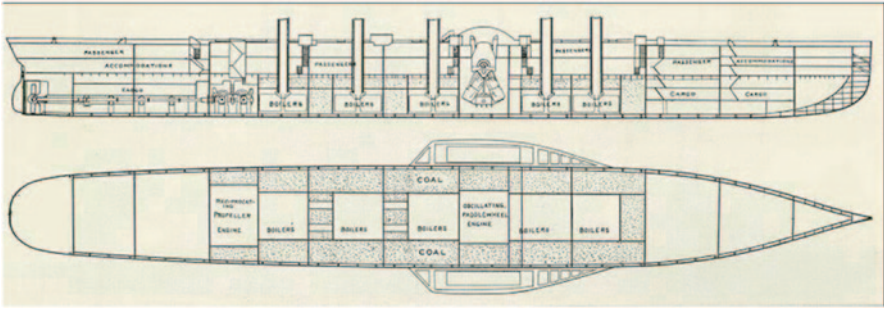

Fig. D.20 General arrangement of SS Great Eastern

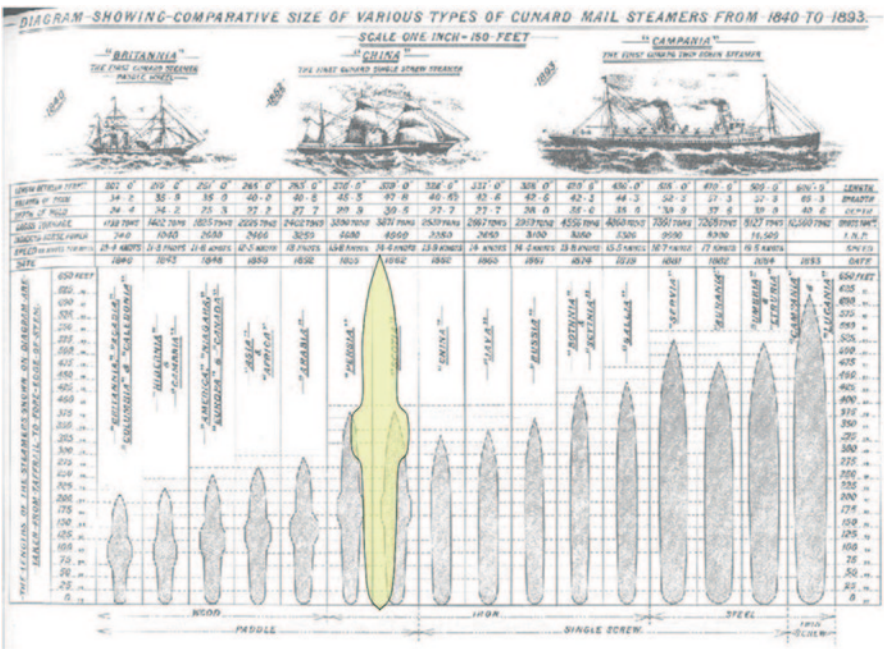
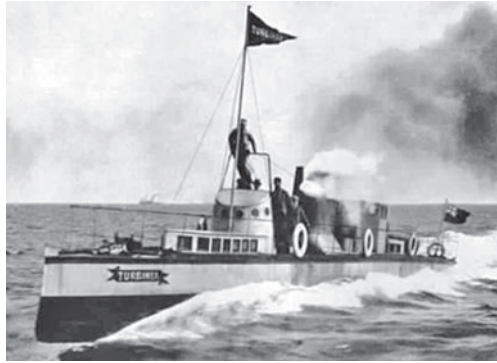

Fig. D.21 Comparison of the SS Great Eastern with other ships of the same period and ships constructed much later

First Half of the Twentieth Century

In 1884 C. A. Parsons invented the steam turbine and in 1894 the first steam turbine powered, high speed boat, the "Turbinia" (length 31.6 m, speed 34.5 knots) was launched (Fig. D.22).

The first steam-turbine powered tanker ship was the German *Glücksauf*, of 3,000 t DWT, launched in 1886.

Fig. D.22 Turbinia**Fig. D.23** MS Selandia

In 1904 the French Navy fitted the first marine diesel engine to the ‘Z’ type submarines and in 1911 the *MS Selandia*⁹, the first ocean-going diesel ship, was launched at *Burmeister & Wain* Shipyard in Copenhagen (Fig. D.23).

In 1912, the sinking of the “*RMS Titanic*” on her maiden voyage and the loss of 1,500 lives¹⁰ led to the establishment of the first international regulations for the safety of human lives at sea, SOLAS 1914 (Fig. D.24).

⁹ The *MS Selandia*, a combined cargo-passenger ship, was the most advanced ocean-going *diesel motor ship* of her time. She was ordered by the Danish East Asiatic Company (EAC) for service between Scandinavia, Genoa, Italy, and Bangkok, Thailand. She was built under the direction of *Ivar Knudsen*, who closely worked with *Rudolph Diesel* for ship’s innovative diesel machinery, at *Burmeister & Wain* Shipyard in Copenhagen, Denmark, and was launched on 4 November 1911. Apparently, she was not the world’s very first diesel-driven ocean-going ship, as the small Dutch tanker “*MS Vulcanus*” went to sea already in December 1910. However, she was certainly the largest and most advanced diesel-driven ship at the time of her maiden voyage in January 1912.

¹⁰ *RMS Titanic* was a British passenger liner that sank in the North Atlantic Ocean on 15 April 1912 after colliding with an iceberg during her maiden voyage from Southampton, UK to New York City, USA. She was believed to be unsinkable, in view of her dense subdivision by 15 transverse bulkheads, which, however, did not ensure water-tightness of subdivided spaces, *because of the lack of an upper watertight boundary* (lack of bulkhead deck). Remarkably, this accident happened 50 years after the grounding of *Great Eastern* on the same voyage (see footnote 7). In view of *Great Eastern*’s *double hull* concept, however, the outer hull damage did not lead at that

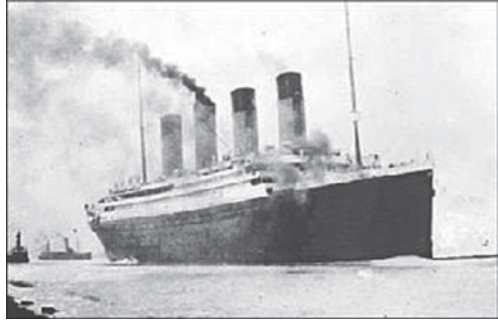
Fig. D.24 RMS Titanic**Fig. D.25** Liberty

During the WWI the British built the first fully welded ship, the *Fulagar*. Welding became the primary method of building ships during WWII, and the productivity increased drastically, culminating with the assembly and launching of a cargo ship of *Liberty* type in U.S. shipyards in *4 days and 15½ h* from laying down the keel (Fig. D.25).

Second Half of the Twentieth Century

The invention of radar and sonar radically improved navigation and the safety of ships' navigation significantly increased (Fig. D.26).

The discovery of the potential of nuclear energy led to the use of nuclear reactors on ships with unlimited autonomy of propulsion; however, this has been applied

time to ship's sinking. Also, as pointed out by Roy Brander, "*the Great Eastern, like the Titanic, had fifteen transverse bulkheads. Hers, however, went a full 30' above the water line, right to the top deck in the fore and aft. In the engine rooms, they were lower, but the engines were further protected by longitudinal bulkheads on either side. The middle deck was also watertight, further subdividing the compartments into some 50 in all...This was defense in depth against flooding*" (source: lecture by Roy Brander, "The RMS Titanic and its Times: When Accountants Ruled the Waves", 69th Shock & Vibration Symposium, Minneapolis, 1998)

Fig. D.26 Radar**Fig. D.27** Nuclear Submarine

until now widely only to large naval ships and naval submarines in view of the environmental hazards¹¹ (Fig. D.27).

Ships started being designed for dedicated mission, namely according to the specific transportation needs:

¹¹ See, however, nuclear powered icebreakers and experimental, nuclear powered cargo ships: the US Savannah (1959), the German Otto Hahn (1962), the Japanese Mutsu (1970), the Russian Sevmorput (1988).

Fig. D.28 The IMO building in London Embankment



Fig. D.29 SOLAS



- Tankers for liquid cargo
- Ships carrying bulk cargo, grain, ore, etc.
- Containerships carrying unitized cargo (TEU)
- Reefer ships
- RoPax and cruise ships, etc.

The international safety regulations (establishment of the International Maritime Organization IMO, Geneva, 1948, UN, <http://www.imo.org>) improved continuously and their scope of work include all operational aspects of the ship and the potential risks to the ship, her occupants and the environment (SOLAS, ICLL, MARPOL, STCW, SAR, GMDSS, ISPS, SUA; Figs. D.28 and Fig. D.29).

The introduction of powerful computer systems (hardware and software) after the 1970s, has enabled the drastic improvement of the quality and productivity of ship design/drawings/construction/operation of ships and the implementation of innovative designs and constructions (Fig. D.30).

Fig. D.30 Personal computer



Fig. D.31 Modern Asian Shipyard

The center of the shipbuilding industry gradually moved from Europe to the far east (initially Japan, later South Korea and today China; Fig. D.31).

Contemporary Period

The main objectives of contemporary shipbuilding may be summarized to the *optimization* of ship's basic characteristics, such as:

- The reliability of ship's structure
- Ship's overall safety



Fig. D.32 High speed craft

Fig. D.33 Mega-tanker



- The speed
- Passengers' comfort
- Fuel efficiency
- The ratio of transport capacity to displacement etc.

and the decrease of

- The environmental impact,
- The construction time,
- The acquisition cost,
- The operating costs etc.

New technologies are implemented with the use of:

- Advanced hull forms and innovative types of ships (Fig. D.32)
- Composite materials of lightweight and high performance
- Contemporary means of propulsion
- Automation, satellite communications, etc.
- Advanced engine installations, electric generators, and eco-friendly fuels
- Powerful, integrated software systems for the design, drawing, analysis, construction and operation of ships.

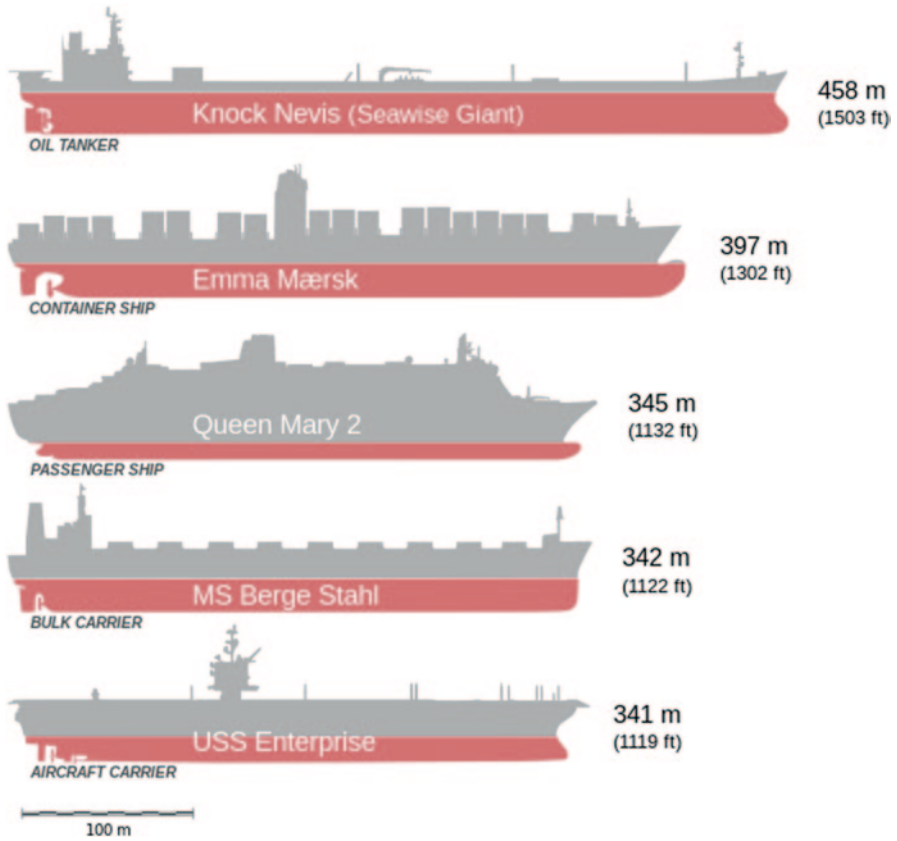

Fig. D.34 Comparison of largest mega-tanker with large representatives of various ship types

Gigantism of Ships (Fig. D.34)

One of the striking characteristics of present shipbuilding is the gigantism of ship's size (in view of the "economy of scale"):

- Mega-tankers ULCCs (Fig. D.32)
- Mega-containerships
- Mega-ore carriers
- Mega-LNG
- Mega-cruise ships
- Mega-yachts

Mega-Yachts

Large private pleasure boats have increased significantly their size, reaching today lengths over 160 m, with the tendency to further increase in size (Figs. D.35 and D.36).



Fig. D.35 M/Y Eclipse of Russian tycoon Roman Abramovich, length 162.50 m, GRT 13,000, 70 crew, builder Blohm & Voss, in service Dec. 2010, cost about 340 Mio €



Fig. D.36 Largest superyacht in the world “AZZAM” ($L=180$ m, $V>30$ knots, powered by a set of two gas turbines and two diesel engines with a total of 94,000 hp), launched in April 2013

Ultra Large Crude Carriers (ULCC)

These ships were first introduced in the 1960s, then they decreased in number, especially after the first oil crisis in the 1970s; they reappeared later on when serving efficiently the increased worldwide fuel/energy needs. However, their number decreased again significantly, especially after some catastrophic oil pollution tanker accidents, in view of major environmental concerns and associated risks; last but not least, in view of potentially high compensation payments in case of accidents (Fig. D.37).

Fig. D.37 The MV Hellepont Metropolis is the largest built double-hull ULCC (Daewoo Heavy Industries). It has a length of 380 m, a beam of 68 m, a draft of 24.5 m and 442,000 dwt.



Mega-Containerships

The growth in demand of transport of high-value goods in standardized containers has led to the rapid increase of the size of containerships (13,000+TEU, M/S EMMA MAERSK¹²; Figs. D.38, D.39 and D.40).



Fig. D.38 M/S EMMA MÆRSK

¹² The M/S EMMA MÆRSK is the first of a series of mega-containerships, which was built by the shipyard Odense Steel Shipyard Ltd. on behalf of A.P. Moller—Maersk Group. Her length is 397 m (LOA), beam 56 m, side depth 30 m, and engine 14-cylinder Wärtsilä diesel, of 110,000 BHP power at 102 RPM. The passage of ships of this class through the Panama Canal will be possible after the completion of its enlargement (New-PANAMAX).



Fig. D.39 MÆRSK mega containership

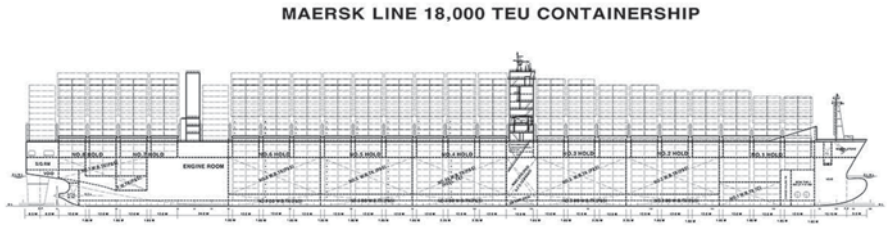

Fig. D.40 New generation of MÆRSK mega containership 18,000 TEU

Most recent developments in the maximum size of containerships are determined by the delivery of the first of a series of MAERSK’s Triple E class of 18,000 TEU capacity, in June 2013 by the South Korean Daewoo Shipbuilding & Marine Engineering Co., Ltd. (DSME) (www.worldlargestship.com).

Liquefied Natural Gas Carriers-LNCG

The use of natural gas as an alternative fuel, the need to transport it over long distances and the risks in the transfer terminals have led to the development of large LNCG and floating terminals for their loading and unloading (Figs. D.41, D.42 and D.43).

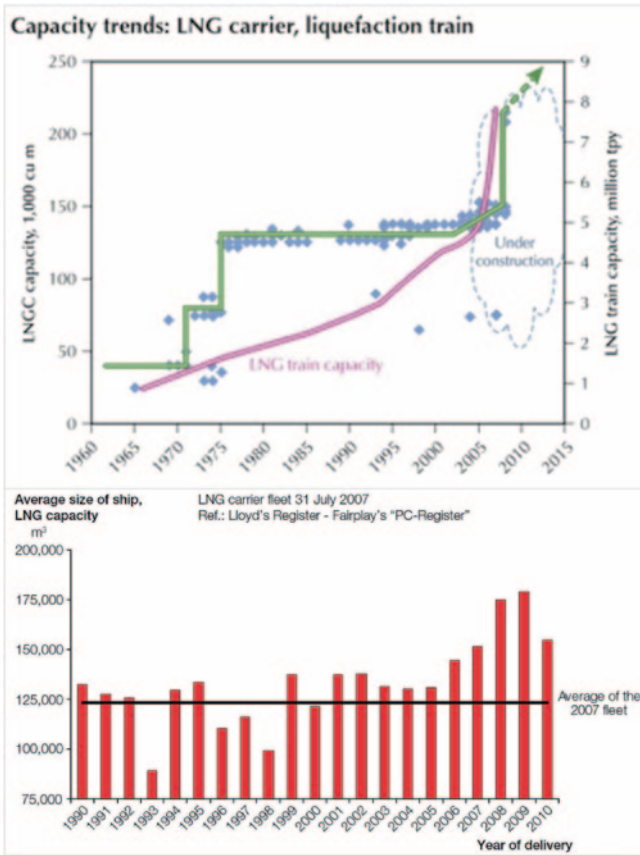

Fig. D.41 LNG carrier capacity trends

Fig. D.42 MOSS & Membrane LNG carriers

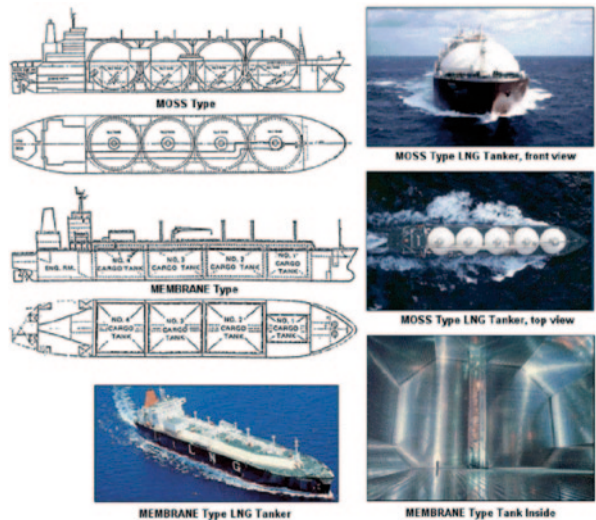

Fig. D.43 Floating LNG terminal EC FP7 research project GIFT (2005–2007) (coordinator: Doris Engineering, France, partner: NTUA)



Mega-Cruise ships—“Genesis” Class

Two ships of *Genesis Class* type were constructed on behalf of Royal Caribbean at Aker/STX Yards (Finland), with delivery 2009/2010. Their capacity is 6400 passengers (+2,000 crew) and tonnage abt. 220,000 GRT. The cost reached more than 2.0 billion € and the project effort was associated to 12,000 man-years. The length of the ships is 360 m, breadth at the waterline 47 m, height 73 m and their displacement exceeds 100,000 t.

There are already designs/drawings of cruise ships for 8,000 to 10,000 passengers (Figs. D.44 and D.45).



Fig. D.44 MS Oasis of the Seas of Royal Caribbean (maiden voyage Dec. 2009), 225,282 GRT, cost US\$ 1.4 Billion Builder: STX Finland

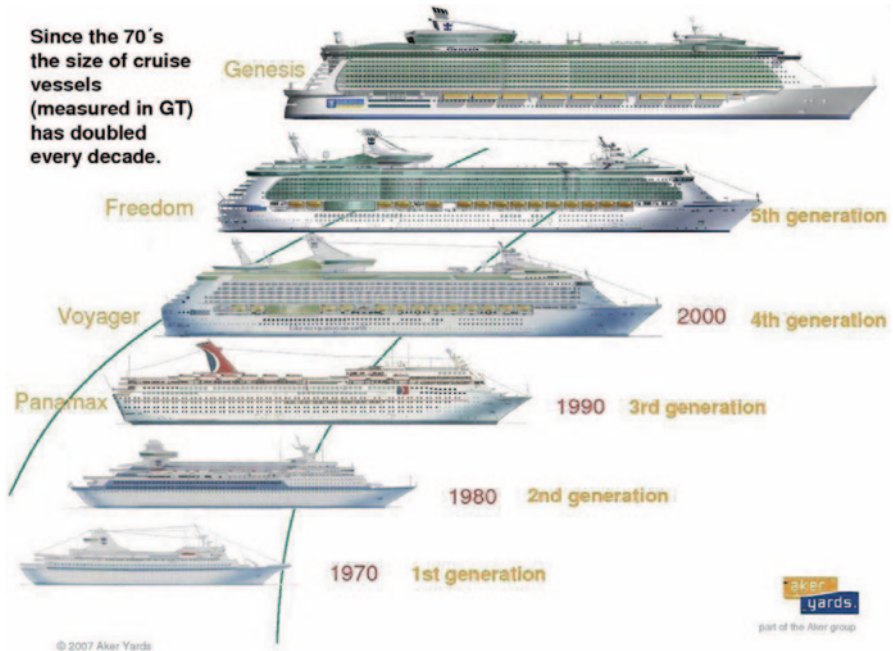

Fig. D.45 Rapid growth of cruise ships after 1970

Advanced Technology Ships

The desire to achieve extremely high speeds and greater comfort for passengers, as well as the need for transport of high-value products, led to the introduction of novel ideas in shipbuilding, with the adoption of new technologies (‘Advanced Marine Vehicles’ AMVs; e.g. Fig. D.46).

There are various design concepts implementing this concept, such as (see Fig. 1.1 for the routes of development of Advanced Marine Vehicles)

Fig. D.46 STENA’s HS1500 High-speed hybrid SWATH (built 1996 by Finnyards, all aluminum alloy LOA 126.6m twin hull construction, 1,500 passengers and 375 cars, trial speed 51 knots, service over 40 knots)



Fig. D.47 Small WIG craft



Fig. D.48 USN trimaran design (Independence class littoral combat high-speed corvette)



Fig. D.49 USN hybrid SWATH design with stealth superstructure

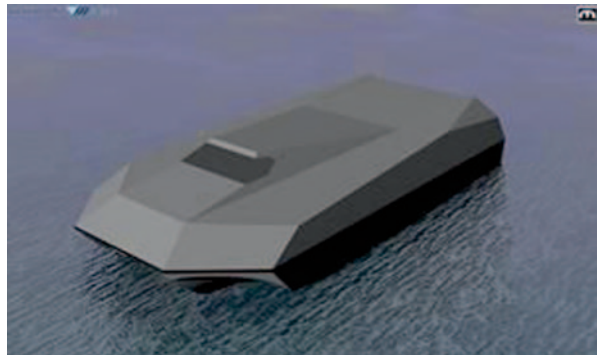

- Catamarans with two hulls
- Trimarans with three hulls
- Pentamarans with five hulls
- Small waterplane area twin hulls (SWATH),
- Surface effect ships (SES)
- Air cushion vehicles (ACV)
- Wing in ground crafts (WIGs) (Fig. D.47)
- Various hybrids

We may find all advanced vehicle concepts first tested in military applications, thus innovative designs with high performance in terms of speed, behavior in waves, service range, low acoustic and overall detectable signature in both surface ships and submarines (stealth technologies, remotely operated or self-operated, intelligent vehicles etc.; Figs. D.48 and D.49).

Fig. D.50 Ship encountering freak waves



Future Developments

- Restructuring of the world merchant fleet (fleet shares and development of ship types).
- Safety of ships (survival/safe return to port after damage or in extreme seas conditions, fire safety, dynamic stability; Fig. D.50).
- Safety of Environment
 - Pollution from oil spills (Exxon Valdez Accident, see Fig D.51)
 - Emissions of toxic gases-greenhouse pollutants, CO_2 , NO_x , SO_x .
 - Demolition of old ships and recyclability.
- Extension of the use of natural gas for propulsion and power generation, using fuel cells on merchant ships.



Exxon Valdez oil spill
Cutler Cleveland and NOAA

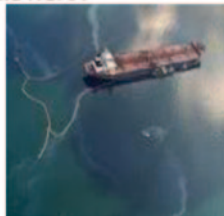

Fig. D.51 Exxon Valdez oil spill

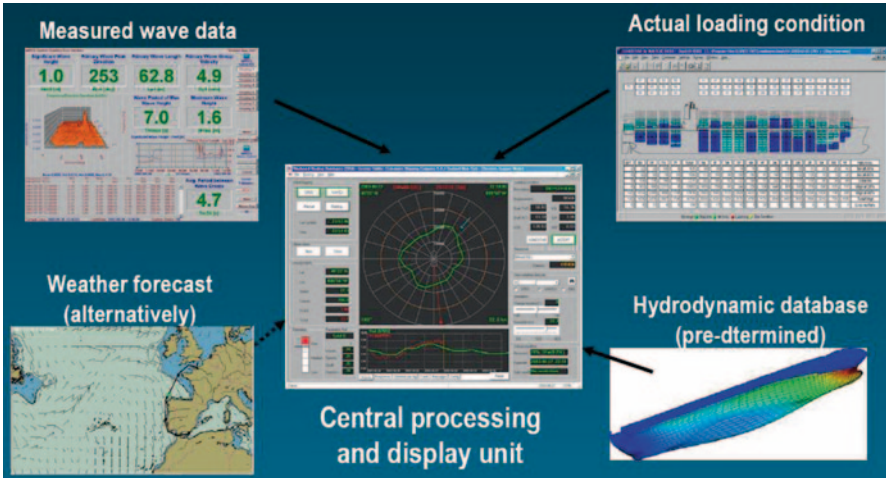

Fig. D.52 Modern shipboard routing assistance systems (SRAS) by Germanischer Lloyd



Fig. D.53 Bulkcarrier fighting his way in heavy seas

- Further increase of the size of large ships, faster speeds versus fuel costs, optimization of seakeeping behavior.
- More extensive use of robotic systems in the construction of ships and extended use of composite materials.
- Education-training/specialization/support of crew with modern navigational means and decision support systems for captain's assistance in crisis conditions (Figs. D.52 and D.53).

Appendix E: Subdivision and Damage Stability of Ships— Historical Developments and the Way Ahead

Abstract: The present appendix E uses material of the published paper *Ship Buoyancy, Stability and Subdivision: From Archimedes to SOLAS 90 and the Way Ahead*, by A. Francescutto and A. Papanikolaou, *Journal of Engineering for the Maritime Environment (JEME)*, Proc. IMechE Vol. 225 Part M, 2010; we present in the following only the part referring to ship's subdivision and damage stability, composed by the book author, A. Papanikolaou. The treatise consists of three sections and is structured as following:

- *Section 1:* from the first considerations of ship's watertight subdivision and damage stability at international level (after the sinking of *Titanic* and the 1st SOLAS convention in 1914) and up to the introduction in the 90ties of the most recent *deterministic* damage stability framework for passenger ships, embedded in SOLAS90 (including the SOLAS95-Stockholm Agreement provisions);
- *Section 2:* from the first developments of the *probabilistic* damage stability framework in the 70ties, embedded in SOLAS74 and amendments thereof in the early 90ties for dry cargo ships, up to the most recent introduction of the harmonized SOLAS2009 regulations pertaining to both passenger and dry cargo ships;
- *Section 3:* the latest developments of the new *risk based* (and *goal based*) damage stability framework, currently underway, likely to be completed and introduced at international level in the present decade.

The Evolution of Deterministic Damage Stability Standards

Since the loss of *Titanic* in 1912 and the first SOLAS Convention shortly after in 1914, ship damage stability regulations and relevant compliance criteria for passenger ships were slowly but steadily amended over the years, adapting to findings from new ship losses and following a more or less a 'trial and error', semi empirical procedure; this continuously improved the safety level of passenger ships, though less satisfactorily from the scientific point of view. However, since the late 80ties and particularly after the spectacular sinking of the British ferry '*Herald of Free Enterprise*' in 1987, regulatory developments concerning the stability of passenger ships started being scrutinized for loopholes and for further improvements; this became a focal point of IMO regulatory work in the 90ties. Notably, there were no specific damage stability criteria or subdivision requirements for *cargo ships* until the early 90ties, when SOLAS74 was amended to cater for *dry cargo ships' damage stability* by use of the probabilistic concept (see Fig. E.1).

Significant ship accidents, particularly of modern time passenger ships, related to ship's damage stability were until now mainly the result of a chain of failures of ship's mastering and/or of proper control mechanisms (by authorities in charge)

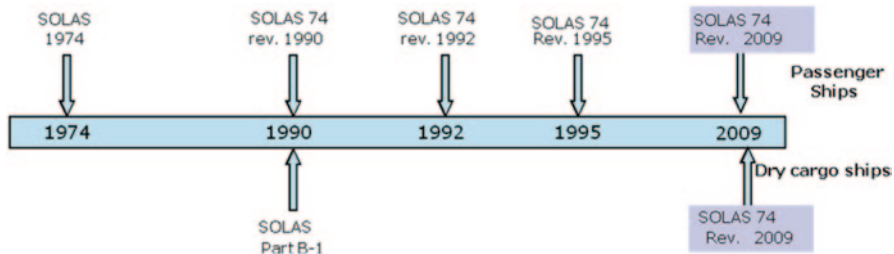

Fig. E.1 Evolution of damage stability rules over the last 40 years for dry cargo and passenger ships

with respect to the compliance of ship's construction and outfitting with in force safety regulations. In very rare cases in the post WWII history of naval architecture, catastrophic accidents happened merely because of failure of ship's design, namely when it was entirely complying with at that time in force stability regulations. It should be anyway herein noted that due the so-called "*grandfather clause*", when new safety regulations are decided at international level (IMO) and implemented in practice, *existing ships* are in general *excluded* of the request for immediate compliance and only *newbuildings* are directly affected by relevant provisions. Exceptions from this rule are rare and if so decided existing ships are put for practical reasons on a 'phase-in' or 'phase-out' compliance procedure, stretched over a period of years.

The damage stability requirements for passenger ships, which were in force until very recently (namely, until the end of 2008), were *deterministic* or *rules-based assessment* concepts in nature; so, the so-called SOLAS 90—*two compartment standard*, which was associated with stability criteria to ensure the survivability of the ship in case of flooding of up to *two adjacent compartments*; smaller passenger ships were in general of *one compartment standard*, whereas very large ships may have had *2+ and higher compartment standard*, depending on their size and number of people carried onboard; the standard was practically a semi-empirical concept developed continuously over the years, namely by the analysis of damage cases and of stability data of ships that led to ships' capsize/sinking vs. the data of ships considered to be of "state of the art" in terms of stability/floatability properties. Relevant criteria led to the specification of the characteristics of the GZ-restoring arm curve and of ship's equilibrium position in case of damage. Of course, innovative ship designs and ships of sizes well exceeding current practice could not be accounted for by this semi-empirical concept.

It should be noted that former versions of the deterministic damage stability criteria (SOLAS 60) did include only requirements for a *positive GM* and *maximum heeling angle* after damage, what according to today's knowledge is regarded insufficient. The radical development of the deterministic damage stability requirements (from SOLAS 48 to SOLAS 90) for passenger ships is shown schematically in Fig. E.2.

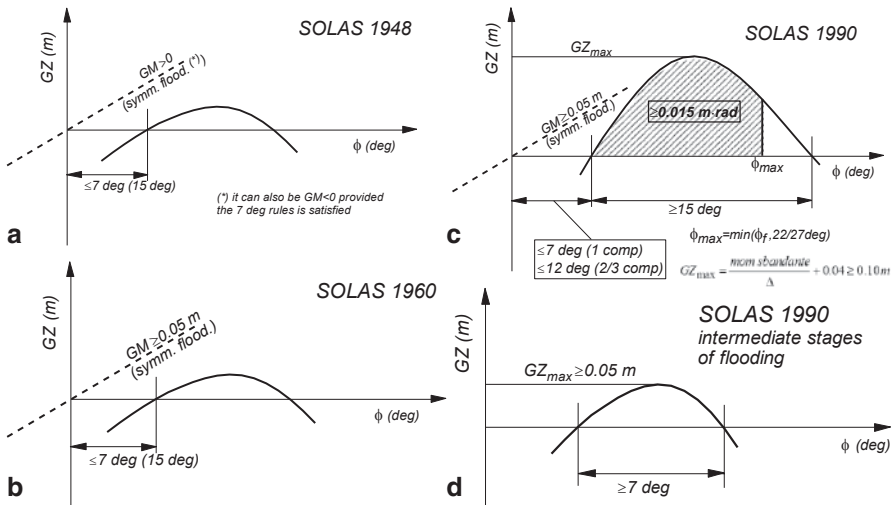

Fig. E.2 Evolution of damage stability standards for passenger ships in SOLAS. **a** Requirements acc. to SOLAS1948, **b** Requirements acc. to SOLAS1960, **c** Requirements acc. to SOLAS1990, **d** Requirements acc. to SOLAS1990 for intermediate stages of flooding

The damage stability criteria of SOLAS 90 (in IMO SOLAS 1997a) for passenger ships are generally considered to be a good ship stability-safety standard¹³. However, two very tragic accidents in the last two decades in Europe, in which water could flood ship's car deck, namely the lost RoPax ferries *Herald of Free Enterprise*, 1987 and particularly *Estonia*, 1994, with the latter causing the loss of 852 lives, shuttered the international maritime community and led IMO to appoint directly after the *Estonia* accident, following an unprecedented emergency procedure, an international Panel of Experts to investigate the effect of water on deck (WOD) on the damage stability of Ro-Ro passenger ships and to propose within shortest time corrective measures accounting for insufficiencies of SOLAS 90 to satisfactorily account for WOD effects. The SOLAS 95 conference could not conclude on changing the SOLAS 90 damage stability requirements as a worldwide standard, noting that both above mentioned accident ships were of SOLAS74 standard, whereas it was uncertain to what extent ships of SOLAS 90 standard could sustain WOD damages in specific seaways; however, it was decided to accelerate the compliance of existing passenger ships with the requirements of SOLAS 90 and to allow member states to conclude regional agreements enhancing the SOLAS 90 requirements with respect to WOD under the action of seaway in collision damage; also, for the first time in IMO history, a *performance based* regulatory procedure was adopted by IMO, allowing a verification of the compliance of a

¹³ It should be, however, noted that the semi-empirical SOLAS 90 did not cater for the explosive development of the size of passenger/cruise ships, which were developed in the last 2 decades reaching the size of *Genesis Class* cruise ships (Loa=361 m, GT 225,282, capacity: close to 8,700 passengers and crew); thus, it is insufficient for large and mega size passenger ships in general.

ship with damage stability requirements through an *equivalent model test* procedure (Res. 14, SOLAS 95). Following the SOLAS 95 conference, seven North-West European countries concluded a regional (North-West European wide) agreement, the so-called *Stockholm Regional Agreement*, imposing enhanced damage stability requirements beyond SOLAS 90 for ships operating between ports of their authority. The Stockholm Agreement provisions consider the fulfillment of the SOLAS 90 damage stability criteria under the assumption of flooding of the ship's main car deck with an amount of water of up to 50 cm height (the assumed amount of water depends on ship's damage freeboard and the significant wave height in the region of operation, see IMO SOLAS 1995, Res.14 and IMO, Circular letter 1891/1996).

The formal application of the Stockholm Agreement provisions *to existing ships* led to an additional transverse and partly longitudinal subdivision of ship's car deck by movable or fixed bulkheads, the fitting of sponsons or duck-tails to ship's hull, the possible reduction of ship's transport capacity for increasing ship's freeboard, all this with severe impact on ship's operation and efficiency (besides the cost for ship's modification) (Vassalos and Papanikolaou 2002). The impact on new buildings was less severe, noting that ships were designed with increased intact (and damage) freeboard, thus keeping the probability of flooding of their car deck at a minimum (Papanikolaou 2002). Finally, it is noted that in the meantime the *Stockholm Regional Agreement* provisions for passenger ships have been extended to all over Europe (the application to South European ships was accelerated after the sinking of the Greek ferry *Express Samina* in year 2000) and are in fact in place in all developed countries worldwide (USA, Canada, etc.), despite their *regional* original character.

Independently of the fact that the regulatory damage stability provisions of SOLAS 90, supplemented by those of Stockholm Agreement, are considered and proved until now fully satisfactory, a major drawback of these deterministic requirements is that the associated safety level is unknown, though it proved satisfactory until now in practice (Papanikolaou 1997).

Present Status: Probabilistic Assessment

The probabilistic approach to the assessment of the damage stability of ships was introduced by the German Professor *Kurt Wendel* in the late 50ties (Wendel 1960); he aimed at introducing a more rational method for the assessment of the probability of survival of a ship in case of damage (breach of ship's outer shell by collision or grounding) and flooding of internal spaces. Additionally, the introduced new assessment method allowed the definition of a global '*safety factor*' (*Sicherheitsgrad*) through which the stability characteristics of ships of different size and type could be quantified; thus, the safety of different ships became directly comparable. The method allows conceptually, through systematic application, the optimization of the watertight subdivision of ships for the least number of watertight bulkheads at the greatest possible degree of safety against capsizing and sinking (see EU funded RTD projects NEREUS & ROROPROB). A fundamental property of the probabilistic

approach to the assessment of ship's damage stability is the possibility to integrate the risks associated to a variety of ship casualties/hazards (collision, grounding, fire, etc.) in an overall safety assessment procedure, namely the risk-based assessment concept (*risk-based design, regulation, approval and operation*, see, Project SAFEDOR and the following Sect. E.3 of the present appendix).

The full exploitation of the probabilistic approach of *K. Wendel* was enabled by the development of computer technology and of relevant calculation software. It should be noted that the probabilistic approach was already embedded in international regulations as part of SOLAS 1974 (IMCO Res. A265) as an alternative to the deterministic regulations for the assessment of the damage stability of Ro-Ro ferries and passenger ships. Due to the complexity of relevant calculations, however, it was rarely applied in practice. The concept was several years later modified and embedded in the 1992 revision of SOLAS74 pertaining to the damage stability of *all dry cargo* ships of 100 m (then reduced to 80 m) and above in length built after 1992 (IMO SOLAS 1997-b).

An ideal approach to the probabilistic analysis of the survival of a ship in case of damage of her outer shell encompasses three main categories of probabilities:

1. The probability that the ship sustains a damage,
2. The probability that the incurred damage happens at a certain location along the ship (including the spatial extent of damage) and the
3. Probability that the ship survives the sustained damage.

In most common probabilistic approaches to ship's damage stability the first probability (*sustain of damage*), which is strongly depended on ship's routing and navigational properties, is neglected (see, however Pedersen 1995) and it is assumed that a damage has occurred. Thus, what remains to be determined is the probability of survival of statistically determined damages of ship's outer shell, while the damage characteristics are determined by a statistical analysis of registered ship damages (due to collision and in some cases grounding). It should be herein noted that most existing approaches at IMO level (IMO SLF 43/16, 46/16 and 47/17) or of international research teams (see Project HARDER), do consider primarily only collision damages, as this type of damages lead in general to the most onerous consequences. Furthermore, because the set problem is very complicated and comprehensive statistical survival/capsize data are not readily available, it is necessary for the application of the method in practice to assume certain deterministic type of models for the assessment of ship's probability of survival.

The probabilistic approach to ship's damage stability leads eventually to the determination of characteristic *safety factors* for the ship under consideration (conceptually like those introduced by *K. Wendel*). The first factor is the so-called *attained subdivision index A*, representing a measure for the probability of survival of the ship in case of a damage. The second factor, namely the so-called *required subdivision index R*, is the minimum value for the attained index *A* and represents a generally accepted (imposed in regulations) survival level for the ship under consideration, corresponding to her size and the number of people onboard exposed to the collision hazard. Trivially, it is required by regulation that

$$A \geq R.$$

Thus, through the direct comparison of A and R of a ship, her level of relative safety with respect to her survivability in case of collision is established.

The general formulation of the index A is:

$$A = \sum_i p_i v_i s_i,$$

where the sum has to be taken over all watertight compartments or group of compartments. Herein, the factor p_i represents the probability that the compartment of group of compartments under consideration i is flooded, without the consideration of possibly fitted horizontal subdivisions (boundaries) of compartment i , and v_i the probability that a space above an existing horizontal boundary is not flooded. Both above factors directly depend on the geometry of ship's construction and are determined by a statistical analysis of systematically collected damage ship data. The factor s_i represents the probability of survival after flooding of the compartment or group of compartments under consideration, including the possible existence of horizontal boundaries. It is determined by comparison of ship's stability properties after damage with the deterministic criteria of SOLAS 90 or likewise.

Based on a decision of the MSC committee of IMO, all damage stability assessment concepts (deterministic and probabilistic) for passenger (see IMO SOLAS 1997-a and IMCO Res. A.265) and dry cargo ships (IMO SOLAS 1997-b), which were in force in the 1990s, should be harmonised and integrated in one assessment concept, so that in the future the damage stability of all types of ships could be assessed by one unique probabilistic method (*harmonised*) (IMO SLF 41/18). After several years of hard work by researchers all over the world and through relevant IMO subcommittees, the deliberations about the harmonisation of damage stability rules were completed in 2004 (IMO SLF 47/17) and final decisions were taken in 2005 (see Papanikolaou 2007; Papanikolaou and Eliopoulou 2008).

The required subdivision index R according to SOLAS 2009, entered into force on January 1 2009 (IMO MSC.216(82)) and are applicable to all new buildings, for passenger ships is determined as follows:

$$R = 1 - \frac{5,000}{L_s + 2.5N + 15,225}$$

where:

L_s Subdivision length

N $N1 + 2 N2$,

$N1$ Number of persons for whom lifeboats are provided and

$N2$ Number of persons (including officers and crew) the ship is permitted to carry in excess of $N1$.

Likewise, the required index for cargo ships (dry cargo) is calculated according to the following formula (also according to SOLAS 2009):

Future Developments of International Regulations and Concepts: Risk and Goal based standards

All above approaches and safety concepts have had and continue to have a significant impact on the philosophy of new designs. The damage stability of a ship must be considered in the early design stage. The necessity to introduce the damage stability characteristics of a ship in a rational and integrated safety concept led to the modeling of ship's stability by probabilistic approaches, which rely on greatly improved damage statistics and allow a better insight into the various parameters of the complicated stability problem. This allows the integration of the ship's damage stability assessment into risk-based design procedures, as developed recently in the project SAFEDOR (2005–2009). It is generally accepted that the risk-based design concept will form the basis for the design of all types of ships in the future (Papanikolaou eds. 2009).

Though the new probabilistic damaged stability regulations for dry cargo and passenger ships (Papanikolaou and Eliopoulou 2008), which entered into force on January 1, 2009, represent a major step forward in achieving an improved safety standard through the rationalization and harmonization of damaged stability requirements, there are still serious concerns regarding the adopted formulation for the calculation of the survival probability of passenger ships, particularly for ROPAX and very large cruise vessels; thus eventually of the Attained and Required Subdivision Indices for passenger ships. Furthermore, the SOLAS 2009 damaged stability regulations account only for *collision damages*, despite the fact that accidents statistics, particularly of passenger ships, indicate the profound importance of *grounding* accidents.

A recently completed EU project (GOALDS, 2009–2012, see also Papanikolaou et al. 2010), coordinated by the Ship Design Laboratory of NTUA and with strong partners representing all stakeholders of the European maritime industry and relevant R&D organizations, addressed the above critical issues by:

- Improving and extending the formulation introduced by SOLAS 2009 (IMO MSC.216(82)) for the assessment of probability of survival of ROPAX and cruise ships in damaged condition, based on the extensive use of numerical simulations; for ROPAX ships, water on deck effects should be considered.
- Performing extensive model testing to investigate the process of ship stability deterioration in damaged condition and to provide the required basis for the validation of the numerical simulation results.
- Elaborating damage statistics and probability functions for the damage location, length, breadth and penetration in case of a grounding accident, based on a thorough review of available information regarding grounding accidents worldwide.
- Formulating a new probabilistic damage stability concept for ROPAX and cruise ships, incorporating collision and grounding damages, along with an improved method for calculation of the survival probability.
- Establishing new risk-based damage stability requirements of ROPAX and cruise vessels based on a cost/benefit analyses to establish the highest level for the required subdivision index.

- Investigating the impact of the new formulation for the probabilistic damage stability evaluation of passenger ships on the design and operational characteristics of a typical set ROPAX and cruiser vessel designs (case studies).
- Preparing and submitting a summary of results and recommendations for consideration to IMO (December 2012).

Independently, it appears that eventually performance-based methods and standards may form the only rational (scientific) approach to the assessment of the survivability of a damaged ship in specific environmental conditions. Because the great variety of damage and operational conditions (including seaway and wind conditions) cannot be assessed effectively by physical model experiments, it appears that the employment of numerical simulation methods for the identification of the most critical conditions (to be verified, in some cases, also by physical model experiments) is the way ahead in the future. For a review of present “state of the art” of scientific methods for the assessment of ship’s damage stability the reference (Papanikolaou 2007) may be consulted.

Conclusions

Looking into ship stability 23 centuries after Archimedes, it is trivial to say that developments have been significant, thus greatly improving the safety of people and cargo onboard even in very harsh environmental conditions. Transportation by ship, especially of bulk cargo, remains the most efficient and environmental friendly mode of transport thanks to the Archimedean principle of buoyancy and support of ship’s weight by the sea, which is provided ‘free of charge’ by nature. The Archimedean principles of buoyancy and stability of floating bodies (balance of moments) remain the governing principles of ship design.

Since Archimedes, known developments and changes in ship stability have been very slow over the centuries until practically the end of the eighteenth century A.D. with the works of Euler and Bouguer. Even after the industrial revolution in the nineteenth century nothing significant was registered, despite the radical increase of ship sizes, until after WWII. However, the time scales of most recent related developments (last two decades) are reducing drastically, owing to the fact that scientific approaches to ship safety come to maturity and expectations of society regarding maritime safety are extremely high.

An evident new development in maritime regulatory matters, including those related to ship’s stability and subdivision, is the introduction of *proactive* rather than *reactive* methods. This is entirely in the frame of so-called Formal Safety Assessment (FSA) procedures, in which safety regulations and properties (like ship stability) are assessed in terms of *societal acceptance criteria*, eventually postulating an acceptable number of fatalities for people onboard of ships per year.

Related to FSA procedures are two recently introduced, innovative *holistic* approaches to ship design and safety, namely *Risk-Based Ship Design* (RBD), thus design for acceptable risk levels, and design for *Goal-Based Standards* (GBS), cur-

rently discussed at IMO. Assessing ship's damage stability by the new harmonized probabilistic concept is entirely within the risk-based design concept (see Sect. E.2 of the present appendix), namely by comparing the achieved risk level of capsize/sinking with the required, acceptable risk level. Further improvements will be related to including in the assessment of ship's stability after damage the *Time To Capsize or Sink* (TTCS) as additional criterion, namely the time available to people onboard to safely evacuate the ship in case of need. This is particularly important for the ultra-large passenger ships recently built. Numerical simulations of ship motions in damage condition and under seaway's excitation and physical model experiments will be followed for a satisfactory approach to this complicated problem.

Notes

1. *Archimedes'* treatise *On Floating Bodies* ('περί οχουμένων', literally translated from Greek 'on vehicles') set the foundations of ship's stability; this work was found by studying the recently re-discovered lost *Palimpsest* of *Archimedes* (www.archimedespalimpsest.org)
2. *Pierre Bouguer* (1698–1758) was a French mathematician and astronomer. He is considered by some historians of the scientific developments of naval architecture as “the father of naval architecture”. In 1727 he gained a prize given by the French Academy of Sciences for his paper *On the mastering of ships*, beating *Leonhard Euler*; and two other prizes, one for his dissertation *On the best method of observing the altitude of stars at sea*, the other for his paper *On the best method of observing the variation of the compass at sea*. In 1746 he published the first treatise of naval architecture, *Traité du Navire*, in which among other achievements he first explained the use of the metacenter as a measure of ships' stability.
3. *Leonhard Paul Euler* (1707–1783) was a pioneering Swiss mathematician, physicist and astronomer. Euler made important discoveries in fields as diverse as calculus, graph and ship theory. He also introduced much of the modern mathematical terminology and notation, particularly for mathematical analysis, such as the notion of a mathematical function. He is also renowned for his work in mechanics, optics, and astronomy. For his contribution to ship theory, see *H. Nowacki*, '*Leonard Euler and Theory of Ships*', Technical University of Berlin. Visiting Scholar. Max Planck Institute for the History of Science.
4. The name “metacenter” stems from *Bouguer* and was never used by *Euler*, who was not familiar with this terminology. But in fact both *Bouguer* and *Euler* derive the magnitude of GM (the vertical distance between the ship's center of gravity and the *metacenter*, which is a property of ship's *form*) by the same expression in order to assess ship's initial stability., see *Nowacki, H. & Ferreiro, L. D.*: “*Historical Roots of the Theory of Hydrostatic Stability of Ships*”, Proc. 8th Intl. Conf. on the Stability of Ships and Ocean Vehicles, Madrid, 2003, also Preprint No. 237, Max Planck Institute for the History of Science, Berlin, 2003 and *Ferreiro, L. D.*, “*Ships and Science: The Birth of Naval Architecture in the Scientific Revolution 1600–1800*”, Cambridge, MIT Press, 2007.

5. The *Great Eastern* was for her time a giant ship (length 207 m, displacing 22,352 tons, speed 14 knots) designed by the great English engineer *Isambard Kingdom Brunel*. With a capacity of 4,000 passengers in good comfort or 10,000 troops squeezed together she was at the time of her launch in 1858 the largest built ship in the world. It integrated the latest technological achievements in naval architecture and marine engineering at the time of her built: built from iron and riveted, steam powered and propelled by two side paddle wheels and one stern propeller. Remarkably, she disposed not only watertight subdivision, but also a ‘double hull’, thus a ‘safety belt’ inside the wetted part of ship’s hull, ensuring that in case of breaching of the outer shell in case of a ‘shallow’ but long grounding (‘raking’), the flooding of water would be confined to the space between the outer and the inner hull, thus enhancing her survivability. This by today’s standards very modern double hull concept appears to have saved the ship from foundering in one of her transatlantic voyages, namely after she had rubbed against the later named “Great Eastern Rocks” off New York, sustaining a raking damage of 25 m length and over 2.7 m width!
6. The *Titanic* was an *Olympic*-class passenger liner owned by the White Star Line and built at the Harland and Wolff shipyard in UK. On the night of 14 April 1912, during her maiden voyage, *Titanic* struck an iceberg, and sank two hours and forty minutes later in early 15 April 1912. At the time of her launching in 1912, she was the largest passenger steamship in the world. The sinking resulted in the deaths of 1,517 people¹⁴, ranking it as one of the worst peacetime maritime disasters in history and by far the most infamous. The *Titanic* used some of the most advanced technology available at the time and was commonly believed to be “unsinkable”. It proved, however, in practice that her watertight subdivision was not sufficient to withstand the incurred raking damage by the iceberg. In fact, though her subdivision extent was superb even by today’s standards in terms of size and number of watertight compartments, the practical implementation of ‘watertightness’ was insufficient, namely fitted watertight bulkheads allowed the spreading of flood water to neighboring compartments in their upper part (there was no bulkhead deck!). Also, the ‘double hull’ concept known from *Great Eastern* and which is widely used in modern ship designs was not exploited.
7. The *Estonia* disaster occurred on September 28, 1994 as the ship was crossing the Baltic Sea, en route from Tallinn, Estonia, to Stockholm, Sweden. The official accident report, which is at some parts disputed, blamed the accident on the failure of locks on the bow visor that broke under the impact of the waves. When the visor broke off the ship, it damaged the ramp which covered the opening to the car deck behind the visor. This allowed water into the car deck, which destabilized the ship and began a catastrophic chain of events. Out of a total of 989 passengers and crew on board only 137 were saved. Flooding on the car deck also capsized the *Herald of Free Enterprise* (1987), where the bow door was left

¹⁴ Above figure is acc. to wikipedia.org; the exact number of lost lives in the Titanic disaster is however disputed by various authors; the interested reader may find detailed information about the victims by search in www.encyclopedia-titanica.org.

open, resulting in the deaths of 193 passengers and crew. Roll-on/roll-off ferries are particularly vulnerable to capsizing due to the free surface effect if the car deck is even slightly flooded.

References

1. IMCO Res. A.265 (1974) Regulations on Subdivision and Stability of Passenger Ships as an Equivalent to Part B of Chapter II of the International Convention for the Safety of Life at Sea, 1960, IMO, London, 1974
2. IMO SLF 46/16 (2003) Report to the Maritime Safety Committee—Summary of Decisions, London
3. IMO SLF 47/17 (2004) Report to the Maritime Safety Committee—Summary of Decisions, London
4. IMO SOLAS (1997-a) Stability in damage conditions. SOLAS 74 as amended, Chapter II-1, Part B-1, Regulation 8, Consolidated Edition 1997
5. IMO SOLAS (1997-b) Cargo ships constructed on or after February 1992, SOLAS 74 as amended, Chapter II-1, Part B-1, Regulation 25, Consolidated Edition 1997
6. IMO, Circ. 1891 (1996) Agreement concerning specific stability requirements for Ro-Ro passenger ships undertaking regular scheduled international voyages between or to or from designated ports in North West Europe and the Baltic Sea, IMO Circular letter No 1891, 29 April 1996
7. IMO, MSC. 216(82) (2009) Adoption of Amendments to the International Convention for the Safety of Life at Sea, 1974, as amended, adopted 8th December 2006 (SOLAS 2009)
8. IMO, SLF 43/16 (2000) Report to the Maritime Safety Committee, London
9. IMO, SOLAS 95—RESOLUTION 14 (1995) Regional Agreement on specific stability requirements for Ro-Ro Passenger Ships, incl. Appendix on Equivalent Model Test Method, Resolution 14 of the Conference of Contracting Governments to the International Convention for the Safety of Life at Sea, 1974 adopted on 29 November 1995
10. Papanikolaou, A. (1997) Critical review and practical implications of the new SOLAS regulations pertaining to the damage stability of Ro-Ro passenger vessels. In: Proc. 6th STAB Conference, September 1997, Varna, pp. 63–80
11. Papanikolaou, A. (2002) Design and safety of Ro-Ro passenger ships (Entwurf und Sicherheit von Ro-Ro Passagierschiffen, in German), Handbuch der Werften, Vol. XXVI, Schiffahrts-Verlag HANSA, Hamburg
12. Papanikolaou, A. (2007) Review of Damage Stability of Ships—Recent Developments and Trends. In: Proc. 10th International Symposium on Practical Design of Ships and Other Floating Structures, PRADS 2007, Houston
13. Papanikolaou, A. (eds.) (2009) Risk-based Ship Design—Methods, Tools and Applications. SPRINGER, ISBN 978–3–540–89041–6, February 2009
14. Pedersen, P. (1995) Collision and grounding mechanics. In: Proc. West European Conference of Maritime Technology Societies (WEMT '95), pp. 125–157
15. Project HARDER (2000–2003) Harmonization of Rules and Design Rational, European Commission, DG XII—BRITE, contract no.: G3RD-CT-1999-00028
16. Project GOALDS (2009–2012) Goal-Based Damaged Stability, European Commission, FP7, DG Research, Grant agreement no.: 233876, <http://www.goalds.org>
17. Project NEREUS (2000–2003) First Principles Design for Damage Resistance against Capsizing, European Commission, DG XII—BRITE, contract no.: G3RD-CT-1999-00029
18. Project ROROPROB (2000–2003) Probabilistic Rules-Based Optimal Design of Ro-Ro Passenger Ships, European Commission, DG XII-BRITE, contract no.: G3RD-CT-1999-00030
19. Project SAFEDOR, Design, Operation and Regulation for Safety, European Union research project of the FP6 Sustainable Surface Transport Programme, <http://www.safedor.org>, 2005–2009

20. Papanikolaou, A., Hamann, R., Lee, B. S., Mains, C., Olufsen, O., Tvedt, E., Vassalos, D., Zaraphonitis, G. (2013) GOALDS: Goal-Based Damage Stability of Passenger Ships. In: Proc. SNAME 2013 Annual Meeting, Seattle, November 2013
21. Wendel, K. (1960) The probability of survival of damages (Die Wahrscheinlichkeit des Überstehens von Verletzungen, in German), Schiffstechnik, Heft. 36, Bd. 7, s. 47, Schiffahrts-Verlag HANSA, Hamburg
22. Papanikolaou, A., Eliopoulou, E. (2008) On the development of the new harmonized damage stability regulations for dry cargo and passenger ships. Journal of Reliability Engineering and System Safety (RESS), Elsevier Science
23. Vassalos, D., Papanikolaou, A. (2002) Stockholm Agreement—Past, Present & Future, Part I & II, Journal Marine Technology, SNAME Publ., July 2002

Index

A

Abicht, W., 289
ABS, *See* American Bureau of Shipping
Admiralty constant, 56, 88, 166, 564
Advanced Marine Vehicle (AMV), 27, 182
Air Cushion Vehicle
 hovercraft, 182
Air Lubricated Hull (ALH), 182
Akagi, S., 5–7, 9
Alexander's formula, 87
Alissafaki, A., 125
American Bureau of Shipping, 133, 384
Andrews, D., 16
Angle of entrance, 296, 305, 308
Angle of heel, 264–266, 268, 269
Angle of inclination, 125, 266, 356
 large, 125, 262, 272, 273, 282
 small, 134, 255, 259, 272
Angle of run, 296, 309
Anstassopoulos, K., 177
Antoniou, A., 132
Appendages, 164
Archimedes, 407, 584
Aristotle, 15, 583
Asymmetric stern, 318–320
Athenian trireme, 582–584
Attained subdivision index A, 46, 48, 49, 62, 384, 614
Averof (WWI Greek naval ship), 325
Ayre, 103

B

B-60 and B-100 bulk carriers, 62, 132
Bale volume, 247
Ballast, 98, 137, 195, 231, 239, 245, 249, 300, 308, 336, 341
 water, 177, 242–246, 271, 300, 399

Beam, 74, 91–99, 114–138, 150, 152, 155, 156, 160, 163, 165, 185, 257, 309, 328, 355
Bilge, 131, 151, 154, 156, 239, 259, 266, 301, 312
Birmingham, R., 21, 22, 30, 65
Block coefficient CB, 24, 61, 63, 73–75, 96, 107, 115–122, 125, 136, 140, 142, 153, 157, 163, 180, 191, 197, 198, 200, 244, 267, 270, 274, 275, 280, 373–376, 443, 453, 466, 521
Boulougouris, E., 13, 46–50
Bow, 81, 84, 86, 87, 136, 144, 146, 148, 163, 307, 308, 311, 314, 316, 321, 323, 328–332, 336, 339, 342, 345, 416
 height, 146, 271–274
 thruster, 342, 432, 433
Break bulk, 131, 148, 300
Bremen (ocean liner), 331
Brunel, I., 409, 426
Building costs, 440
Bulbous bow, 145, 197, 297, 300, 301, 305, 308, 323, 330–332, 339, 342, 399
Bulbous sections, 313
Bulkcarrier, 81, 131, 132, 138, 144, 162, 176, 179, 195, 208, 209, 278, 280, 300, 339, 345, 397, 419, 440
Bulkhead deck, 35, 118, 132, 275, 276, 289, 385, 594
Buoyancy center, 150, 160, 297, 299, 341
Buxton, I.L., 440

C

Canal, 74, 111, 115, 138, 250, 343
Capacity, 394, 395, 407, 409, 439
 factor, 395
 plan, 25, 359, 361, 389, 391

- Capital, 440
- Carlton, J., 423
- Cavitation, 417
- Center of buoyancy longitudinal (LCB), 300, 370, 373
- Center of gravity, 134, 177–179, 208, 268, 316, 618
- Centre of mass, 130, 270, 278, 425
- Class, 196, 418
- Classification society, 74, 113, 133, 201, 207
- Coefficient
 - block, 74, 75
 - machinery weight, 181
 - midship section, 75, 95, 135, 140–142, 151
 - prismatic, 75, 122, 140, 142, 144
 - steel weight, 186
 - water plane area, 75, 122, 140, 141, 160
- Collision, 192, 300, 336, 343, 434
- Combined diesel and gas turbines (CODAG), 37, 402, 413
- Compass, 587, 614, 618
- Computational fluid dynamics (CFD), 156, 336, 419
- Computer-aided ship design (CASD), 45, 46, 57, 370
- Construction, 74, 95, 142, 151, 207, 211, 269, 280, 301, 309, 315, 317, 328, 331, 439, 443
 - cost, 74, 76, 97, 98, 103, 135, 145, 147, 154, 175, 206, 209, 214, 343–345
- Construction water line (CWL), 307, 311, 350, 356
- Containership, 97, 99, 117, 131, 133, 148, 155, 179, 196, 200, 208, 244, 264, 394, 414, 421, 443
- Contract, 402
- Controllable pitch propellers (CPP), 411, 413, 414
- Cruise ship, 243
- Cubic coefficient method, 252

- D**
- Damage stability, 134, 256, 272, 289
- Danckwardt, E., 178, 297, 405, 406
- Danckwardt's method, 192
- David Taylor Model Basin (DTMB), 296
- Deadweight (DWT), 133, 151, 185, 218, 239, 245, 248, 251, 394
 - carrier, 69, 115, 165, 278
- Deck cranes, 225
- Deckhouse, 176, 178, 186, 190, 202–205, 209, 211, 266
- Deep, V, 182

- Depth
 - side, 73, 74, 115, 118–120, 122, 124, 132–136, 138, 218, 275, 277, 315
- Design
 - equation, 164
- Design waterplane, 137, 311, 314, 315
 - waterline DWL 307, 309
- Detailed design, 215
- Diesel, 181, 208, 231, 234, 235, 241, 400, 413
- Dimensions, 73, 74, 96, 115, 118–122, 132, 133, 138, 142, 147, 154, 160, 180, 185, 190, 208, 213, 260, 278, 439–441, 446
- Distortion methods, 359, 372
- Double bottom, 133, 192, 195, 197, 201, 205, 207, 231, 245, 247, 251–253, 300, 380, 384, 389, 566
- Draft, 74
- Draught, 185, 246, 251, 266, 394, 395
- Dudszus, A., 178, 297, 405, 406
- Dynamic stability, 129, 146, 322, 355

- E**
- Economic criteria of optimization, 76
- Efficiency
 - hull, 318, 346, 351, 355, 415, 428
 - propeller, 318, 340, 350, 413, 415
 - relative rotative, 318
- Electric power, 181
- Eliopoulou, E., 11, 12, 384, 615, 616
- EMMA MAERSK mega
 - containership, 409, 602
- Energy Efficiency Design Index (EEDI), 394, 397
- Engine
 - auxiliary, 240, 393–395
 - main, 93, 99, 176, 231, 234, 236, 240, 243, 393, 402–406, 445
 - plant, 236
- Equipment and outfitting, 214, 442
- Estonia, M.V., 134, 386, 612, 619
- Euler, Leonhard Paul, 618
- Evans, J.H., 19, 20
- Exxon Valdez, 385, 608

- F**
- Fishing vessel, 87, 115, 136, 275, 282, 322, 415, 435
- Flare of sections, 309
- Floating production storage and offloading terminals (FPSO), 36
- FOILCAT, 182
- Form factor, 269
- FORMDATA, 114, 145, 259, 299, 341

Forward section form, 328
 Freeboard, 74, 100, 118–120, 132–136, 146,
 272–280, 283, 287–290, 315, 321,
 330, 336
 Fresh water, 241
 Friction resistance, 320
 Friis, A.M., 120, 186, 297
 Froude number, 44, 74, 77, 79–82, 86, 87, 90,
 98, 101, 113, 125, 127, 136, 144, 145,
 148, 150, 156, 163, 166, 177, 180, 296,
 297, 301, 303, 307, 336, 339, 341, 349,
 353, 355
 Fuel consumption, 9, 11, 13, 14, 24, 90, 98,
 145, 240, 300, 394, 395, 397–402, 405,
 413, 440

G

Gabrielli, G., 5
 Gas turbines, 241, 402, 412, 413
 Gearbox, 176, 181, 208, 235, 236, 238, 402
 General
 arrangement, 99, 300
 cargo ship, 72, 133, 200, 205, 223, 279,
 300, 394, 397, 418, 443
 Genesis class mega cruise ship, 229
 Germansicher Lloyd (GL), 207, 236, 350
 Gilfillan, A.W., 190
Glücksauf, 593
 GM, *See* Metacentric height
 Goal Based Standards–GBS, 209
 Grain volume, 192, 247
 Great Eastern, 409
 Great Britan (ship)
 SS Great Britain, 426, 428, 588
 Green water, 321, 322
 Gross
 tonnage, 249, 250
 volume, 220, 246, 247
 Guldhammer, 114, 145, 259, 341
 GZ, 269
 righting arm (stability), 124, 264, 269

H

Harvald, S.A., 168
 Hatch coamings, 176, 199, 208, 269, 270
 Heave motions, 100
 Heeling moment, 268
 Henschke, W., 279, 430
 Herald of Free Enterprise, 610, 612, 619
 High-tensile steel (HTS), 179, 196, 208, 209,
 213, 236
 Hogging, 93
 Hold volume, 119, 132, 133, 155, 221, 247,
 251, 252

Holistic, 15, 617
 Hollenbach's method, 166
 Holtrop's method, 166
 Horn, Fritz, 88
 Hull form, 75, 76, 86, 118, 142, 145, 148,
 151, 166, 180, 185, 258, 259, 296, 299,
 304, 307, 308, 311, 314, 318, 339, 435
 coefficients, 73, 140, 256, 260
 Hull steel, 97, 128, 443

I

Ice, 180, 343
 IHS Fairplay database, 69
 Initial stability, 117, 119, 122, 129, 133, 137,
 149, 155, 161, 255, 260, 262, 272, 278,
 314, 349
 Intact stability criteria, 64, 256, 264
 International Association of Classification
 Societies (IACS), 32, 93, 196,
 209, 210
 International Code on Intact
 Stability, 264, 265
 International Convention on Load Lines
 (ICLL), 274, 275, 278, 283, 289
 International Maritime Organisation
 (IMO), 74, 209, 250, 264, 289, 397
 International Towing Tank Conference
 (ITTTC), 75, 78
 Interpolation methods, 374

J

Jensen, J.J., 186

K

Kariambas, H., 46
 von Karman, Th., 5
 Kennell, C., 6, 8–10
 Kerlen, H., 443
 Kort nozzle, 430

L

Lamb, T., 208
 Lambrinidis, G., 421
 LASH (Lighter Abroad Ship), 36, 41, 97,
 99, 131
 Lashing of containers, 225, 227
 Length, 73–75, 81, 84, 86–90, 94, 95, 98–100,
 103, 114, 115, 128–138, 142, 146, 150,
 156, 160, 165, 185, 190, 197, 225, 257,
 261, 269, 275, 277, 287, 289, 300, 342,
 351, 395, 419, 446
 of entrance, 76, 154, 294–296, 303, 519
 of run, 295, 296, 303, 304

Levander, K., 15, 17
 Lewis, E.V., 77, 83, 100, 130, 221, 305, 421
 Liberty (ship), 348, 595
 Light weight, 185, 209
 Lighter Aboard Ship (LASH), 97, 99, 131
 Linear dimension ships, 69, 117
 Liquefied Natural Gas (LNG) carrier, 99, 399
 Liquefied Petroleum Gas (LPG) carrier, 120
 Lloyds Register of Shipping (LR), 190
 Loading equipment, 180
 Longitudinal center of buoyancy (LCB),
 295–297, 299–301, 311
 Low Wash Catamaran (LWC), 181
 LOWI (loss of watertight integrity), 256, 384

M

Machinery, 70, 77, 175, 180, 181, 185, 214,
 215, 231, 233, 234, 250, 300, 442
 selection, 165, 393
 Maintenance, 75, 331, 343, 402, 404,
 419, 440
 Malacca Straits, 75
 Maneuvering, 137, 342, 413, 415, 423,
 429, 433, 435
 MARAD series, 547
 Margin of weight, 227, 246
 MARPOL, 179, 244, 268, 300, 395, 396, 417
 Mauritania (ship), 324
 Maximum Continuous Rating
 (MCR), 404, 405
 Medium Waterplane Area Twin Hull
 (MWATH), 181
 Meier–Peter, H., 243
 Metacentric, 117
 height, 117, 256, 262, 264, 322
 radius, 118, 162, 257
 MIDFOIL, ship, 181
 MS Selandia, 594
 Müller-Köster method, 197, 198, 200, 202
 Mumford exponents, 125

N

Naval ship, 87, 100, 131, 231, 275, 348, 349,
 353, 402, 413, 414, 418, 430
 Net-net volume (*reefer ships*), 248
 Net hold volume, 31, 247
 Net present value (NPV), 74, 440
 Net tonnage (NT), 250
 Noah's Ark, 583
 Nönnecke, 318, 319
 Normand, 55, 218, 256, 257, 331, 561, 565,
 575–580
 Nowacki, H., 1, 46, 372, 618
 Nozzle, *See* Kort nozzle

O

Oasis of the Seas (cruise ship)
 MS Oasis of the Seas, 605
 OPA90, 11, 179, 212
 Optimization, 213, 417, 439
 methods, 179
 Overhead, 443

P

Panama canal, 115
 PANAMAX, 36, 65, 66, 75, 115, 117, 131,
 180, 365, 366, 385, 403, 602
 Papanikolaou, A., 72, 77, 125, 134, 142, 166,
 177, 178, 218, 226, 230, 236, 256, 275,
 341, 405, 421, 440
 Parabolic bow, 308, 345
 Parallel body, 141, 142, 154, 295, 301
 Parametric, 77
 roll, 164, 322
 Pareto front, 45, 48, 49
 Passenger ship, 125, 132, 138, 177, 179, 196,
 221, 229, 243, 268, 288, 296, 312, 320,
 332, 394, 413, 418, 421, 433
 Passengers, 129, 131, 146, 177, 192, 221,
 263, 268, 409
 Payload, 77, 175, 177, 239, 243
 Perras, P., 132, 185, 256, 289
 Pitch motions, 100, 146, 311, 321, 342
 Plimsoll, Samuel, 273
 Plimsoll's mark, 290, 391
 Politis, G., 421
 Posdunine, 104
 Preliminary design, 69, 93, 115, 141, 160,
 161, 164, 165, 175, 176, 186, 194, 213,
 232, 262, 264, 442
 Prismatic coefficient CP, 61, 75, 114, 140,
 142–145, 161, 162, 297, 301–307, 310,
 371, 378, 518–521
 Profile, 84, 94, 307, 323, 332, 339, 342,
 350, 425
 Propeller, 76, 115, 136, 137, 141, 156, 162,
 165, 236, 238, 297, 309, 317–320, 340,
 346, 348, 350, 402, 405, 408–419, 421,
 428, 429, 435
 Propulsion, 77, 88, 90, 136, 141, 156, 162,
 168, 192, 233, 238, 240, 297, 300, 317,
 331, 339, 341, 343, 393, 402, 409,
 413–415, 421, 445
 Provisions, 185, 264, 268, 415

R

Ramp, 185, 225
 Range, 76, 90, 118, 124, 133, 134, 152, 220,
 257, 341, 402, 414

- Rawson, K.J., 256
- Reefer ship, 131, 133, 181, 185, 231, 247, 248, 331, 353
- Refrigeration, 231, 248
- Registro Italiano Navale (RINA), 218, 220
- Relational method, 218
- Required Freight Rate (RFR), 74, 76, 440
- Required subdivision index R, 62, 614, 615
- Resistance, 74, 77, 78, 81, 83, 86–90, 100, 113–117, 125, 129, 136, 141, 144–146, 150–152, 155, 160, 162, 163, 295, 297, 300, 301, 304, 305, 309, 316–320, 330–332, 338–342, 351, 405, 411, 419, 421
- Resonance, 100, 113, 130, 146, 263, 321, 322, 342
- Righting arm, 118, 134, 264
- Roll, 129, 130, 146, 156, 265
- Roll period, 131, 263, 322
- Ro-Ro cargo ship, 394
- Ro-Ro passenger ship (RoPax), 125, 276, 278, 394
- Roughness, 405, 417
- Rudder, 98, 137, 165, 176, 214, 346, 349, 351, 395, 414, 418, 423, 425, 426, 428–430, 432, 434
- Rudolph Diesel, 594, 613
- S**
- SAFEDOR, 614, 616
- Safety, 76, 129, 132, 175, 179, 195, 210, 214, 250, 262–265, 273, 289, 290, 336, 413, 434
- Safety Of Life At Sea (SOLAS), 27, 28, 31, 62, 64, 132, 134, 207, 269, 273, 276, 289, 381, 384–389, 415, 594, 597, 610–615
- Sagging, 93
- Schneekluth, H., 103, 131, 132, 145, 146, 151, 164, 177, 178, 214, 221, 235–237, 243, 301, 331, 343, 352, 400, 440
- Sea state, 240, 405
- SEABEE, 36, 38, 41
- Seakeeping, 74, 113, 137, 146, 147, 150, 156, 162, 163, 280, 287, 289, 311, 316, 343
- Sectional area curve (SAC), 154, 251, 295, 296, 301, 303, 305, 307
- Sen, P., 21, 22, 30, 47, 65
- Sensitivity study, 343
- SERIES 60, 296, 299, 310
- SFC, 9, 394, 395
- Shallow water, 97, 428
- Sheer, 274, 277, 280, 282, 287–289
- Shelterdeck, 132
- Ship lines, 164, 330
- Shipowner's requirements, 74
- Slenderness ratio, 114, 144, 145
- Small Waterplane Area Twin Hull (SWATH), 181
- Space
 - exploitation, 145, 148, 150, 151, 301, 317, 349
- Special purpose ships, 264
- Speed, 83, 407, 416, 417, 421, 428, 439
 - trail, 407
- Spoilers, 398
- Spray, 321
- Stability, 115–118, 121, 124, 131–137, 141, 152, 155, 156, 160, 163, 164, 175, 243, 245, 246, 255, 259, 264, 269, 272, 289, 315, 395, 435
- Steam turbines, 236, 241, 412, 414
- Steel, 72, 77, 96, 127, 146, 185, 186, 192, 195, 207–211, 214, 221, 236, 245, 315, 442
- Steering, 339, 413, 415, 428
- Stern, 81, 86, 137, 144, 163, 297, 305, 307, 309, 314, 317, 320, 340, 346, 348
 - cruiser, 163, 347–349, 352, 355
 - elliptical, 347–349
 - profile, 76
 - transom, 142, 258, 309, 314, 347–349, 352, 353, 355
- Stockholm Agreement, 134, 613
- Stowage factor (SF), 69, 248, 278
- Stülcken derrick, 226
- Strohbusch, E., 93, 178
- Structure, 70, 74, 97, 115, 121, 128–130, 146, 150, 154, 176, 179, 186, 195, 202, 205, 208, 210, 214, 343, 443
- Suez canal, 75
- SuperSlender Twin Hull (SSTH), 183
- Superstructure, 96, 130, 134, 176–179, 185, 190, 196, 197, 200–205, 211, 214, 218, 266, 275, 277–280, 289, 313, 442, 443
- Surface Effect Ship (SES), 181, 183
- T**
- Taggart, R., 19, 20, 22–27, 44, 45, 360, 361
- Tanker ship, 179
- Taylor, D.W., 81
- Tender design, 29
- Thrust deduction, 318
- Titanic, 276
- Tonnage, 17, 28, 132, 185, 250
- Transport, 148
 - capacity, 165, 177
- TRICAT, 181

Trim, 136, 146, 164, 243, 246, 255, 271–274, 299, 300, 311, 316, 336, 339, 341, 343, 349, 353, 354, 399, 417, 434

Trireme, 323

Turbinia, 593, 594

Tug, 115, 136, 138, 141, 143, 177, 282, 287, 288, 349, 413

Tunnel sections, 320

Tupper, E.C., 256

Twenty Feet Equivalent Unit (TEU), 107

U

Ultra Large Crude Carrier (ULCC), 208

United States (ocean liner), 332, 333

U-section, 314, 316

US Savannah, 596

V

Value of time, 9, 400

Very Large Crude Carrier (VLCC), 208

Voith-Schneider propeller, 423

Völker, H., 177

Volume carriers, 69, 70, 74, 165, 278, 345

Volume molded (sectional), 247

Volume of hold

bale, 247, 251

grain, 133, 192, 247

gross, 253

Volumetric/capacity curves, 251, 252

net-net, 248

W

Wageningen-Lap Series, 517, 518

Wake, 317–320, 340, 346, 351, 355, 415, 418, 428, 434, 435

Wake effective factor, 318

Watson, D.G.M., 104, 107, 190, 192, 211, 222, 233

Weight

machinery, 165, 180, 181, 185, 231, 234, 236, 238, 402, 419, 440

margin, 227, 402

steel, 97, 121, 133, 208

Weinblum, George, 3, 183, 305, 307

Wetted surface, 80, 90, 95, 114, 116, 125,

136, 144, 152, 162, 316, 399, 419, 430

Width, 131, 156, 316, 332, 338, 345, 356, 446

Winch, 197, 204, 205

Wind, 90, 240, 264–266, 394, 395

Wing In Ground effect craft (WIG), 181

Y

Yield Strength (YS), 208

Z

Zaraphonitis, G., 405

Zero ballast, 243