

Electro-mechano-acoustical circuits

CHAPTER OUTLINE

Part VI: Mechanical circuits	65
3.1 Introduction	65
3.2 Physical and mathematical meanings of circuit elements	66
3.3 Mechanical elements	69
Part VII: Acoustical circuits	84
3.4 Acoustical elements	84
Part VIII: Transducers	94
3.5 Electromechanical transducers	94
3.5.1 Electromagnetic-mechanical transducer	94
3.5.2 Electrostatic-mechanical transducer	96
3.6 Mechano-acoustic transducer	101
3.7 Examples of transducer calculations	102
Part IX: Circuit theorems, energy, and power	104
3.8 Conversion from admittance-type analogies to impedance-type analogies	104
3.9 Thévenin's theorem	106
3.10 Transducer impedances	107

PART VI: MECHANICAL CIRCUITS

3.1 INTRODUCTION

The subject of electro-mechano-acoustics (some-times called dynamical analogies) is the application of electrical-circuit theory to the solution of mechanical and acoustical problems. In classical mechanics, vibrational phenomena are represented entirely by differential equations. This situation existed also early in the history of telephony and radio. As telephone and radio communication developed, it became obvious that a schematic representation of the elements and their interconnections was valuable. Unlike a mechanical drawing, a schematic representation simply shows how the individual circuit elements are connected, or their topology, rather than where they are physically located. One of the most celebrated examples outside the field of engineering is the map of the London Underground, which was designed by an electrical engineer [1] who realized that passengers simply wanted a clear diagram of how to get from one place to another without the geographical details of the

route. Schematic diagrams made it possible for engineers to visualize the performance of a circuit without laboriously solving its equations. Such a study would have been hopelessly difficult if only the equations of the system were available.

There is another important advantage of a schematic diagram besides its usefulness in visualizing the system. Often one has a piece of equipment for which one desires the differential equations. The schematic diagram may then be drawn from visual inspection of the equipment. Following this, the differential equations may be formed directly from the schematic diagrams. Most engineers are trained to follow this procedure rather than to attempt to formulate the differential equations directly.

Schematic diagrams have their simplest applications in circuits that contain lumped elements, i.e., where the only independent variable is time. Such elements are valid when the wavelength greatly exceeds the dimensions of the component. In other words, lumped element models are models with zero space dimensions. In distributed systems, which are common in acoustics, there may be as many as three space variables and a time variable. Here, a schematic diagram becomes more complicated to visualize than the differential equations, and the classical theory comes into its own again. There are many problems in acoustics, however, in which the elements are lumped and the schematic diagram may be used to good advantage.

Four principal requirements are fulfilled by the methods used in this text to establish schematic representations for acoustic and mechanical devices. They are as follows.

The methods must permit the formation of schematic diagrams from visual inspection of devices. They must be capable of such manipulation as will make possible the combination of electrical, mechanical, and acoustical elements into one schematic diagram.

They must preserve the identity of each element in combined circuits so that one can recognize immediately a force, voltage, mass, inductance, and so on.

They must use the familiar symbols and the rules of manipulation for electrical circuits.

Several methods that have been devised fulfill one or two of the above four requirements, but not all four. A purpose of this chapter is to present a new method for handling combined electrical, mechanical, and acoustic systems. It incorporates the good features of previous theories and also fulfills the above four requirements. The symbols used conform with those of earlier texts wherever possible. [2–6]

Note that a simple procedure for conversion of admittance-type circuits to impedance-type circuits is given in Part IX, Sec. 3.8.

3.2 PHYSICAL AND MATHEMATICAL MEANINGS OF CIRCUIT ELEMENTS

The circuit elements we shall use in forming a schematic diagram are those of electrical-circuit theory. These elements and their mathematical meaning are tabulated in Table 3.1 and should be learned at this time. There are generators of two types. There are five types of circuit elements: resistance, capacitance, inductance, transformation, and gyration. There are three generic quantities: (a) the drop across the circuit element; (b) the flow through the circuit element; and (c) the magnitude of the circuit element. [7]

Attention should be paid to the fact that the quantity \tilde{a} is not restricted to voltage \tilde{e} , nor \tilde{b} to electrical current \tilde{i} . In some problems \tilde{a} will represent force \tilde{f} , or velocity \tilde{u} , or pressure \tilde{p} , or volume velocity \tilde{U} . In those cases \tilde{b} will represent, respectively, velocity \tilde{u} , or force \tilde{f} , or volume velocity \tilde{U} , or pressure \tilde{p} . Similarly, the quantity \tilde{c} might be any appropriate quantity such as mass, compliance,

Table 3.1 Mathematical and physical significance of symbols

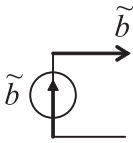
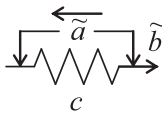
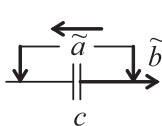
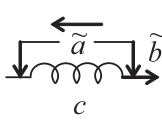
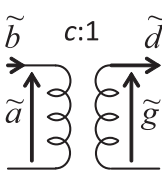
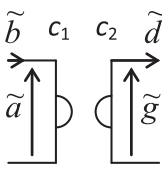
Symbol	Name	Meaning	
		Transient	Steady-state
	Constant-drop generator	The drop \tilde{a} is independent of what is connected to the generator. Its internal impedance is zero so that if one of any number of generators in a circuit is switched off, it is replaced by a short circuit. The arrow points to the positive terminal of the generator.	
	Constant-flow generator	The flow \tilde{b} is independent of what is connected to the generator. Its internal impedance is infinity so that if one of any number of generators in a circuit is switched off, it is replaced by an open circuit. The arrows point in the direction of positive flow.	
	Resistance-type element	$a = bc$	$\tilde{a} = \tilde{b}c$
	Capacitance-type element	$a = \frac{1}{c} \int b dt$	$\tilde{a} = \frac{\tilde{b}}{j\omega c}$
	Inductance-type element	$a = c \frac{db}{dt}$	$\tilde{a} = j\omega c \tilde{b}$
	Transformation-type element	$a = cg$ $b = \frac{d}{c}$ $\frac{a}{b} = c^2 \frac{g}{d}$	$\tilde{a} = c\tilde{g}$ $\tilde{b} = \frac{\tilde{d}}{c}$ $\frac{\tilde{a}}{\tilde{b}} = c^2 \frac{\tilde{g}}{\tilde{d}}$
	Gyration-type element	$c_1 a = d$ $b = c_2 g$ $\frac{a}{b} = \frac{1}{c_1 c_2} \frac{d}{g}$	$c_1 \tilde{a} = \tilde{d}$ $\tilde{b} = c_2 \tilde{g}$ $\frac{\tilde{a}}{\tilde{b}} = \frac{1}{c_1 c_2} \frac{\tilde{d}}{\tilde{g}}$

Copyright © 2012, Elsevier Science & Technology. All rights reserved.

inductance, resistance, etc. The physical meaning of the circuit elements c depends on the way in which the quantities \tilde{a} and \tilde{b} are chosen, with the restriction that $\frac{\tilde{a}^*}{\sqrt{2}} \cdot \frac{\tilde{b}}{\sqrt{2}}$ has the dimension of power in all cases. The complete array of alternatives is shown in Table 3.2.

An important idea to fix in your mind is that the *mathematical operations associated with a given symbol are invariant*. If the element is of the inductance type, for example, the drop \tilde{a} across it is equal to the time derivative of the flow \tilde{b} through it multiplied by its size c . Note that this rule is not always followed in electrical-circuit theory because there conductance and resistance are often indiscriminately written beside the symbol for a resistance-type element. The invariant operations to be associated with each symbol are shown in columns 3 and 4 of Table 3.1.

An infinite impedance generator is a flow generator in the impedance analogy and a drop generator in the admittance analogy. Conversely, a zero impedance generator is a drop generator in the impedance analogy and a flow generator in the admittance analogy. A drop generator “hates” short circuits for obvious reasons. A flow generator “hates” open circuits because when the flow is blocked, the drop rises to infinity. In fact a flow generator can be approximated by a very large drop generator with a very large series resistance whose value is the drop divided by the desired flow.

The transformation element is ideal in that it neither creates nor dissipates power. Hence the dot product $\tilde{a}^* \cdot \tilde{b}$ on the primary side is always equal to $\tilde{g}^* \cdot \tilde{d}$ on the secondary side. It is also reversible,

Table 3.2 Values for a , b , and c in electrical, mechanical, and acoustical circuits

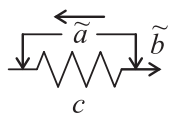
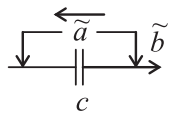
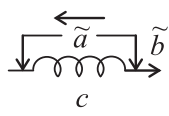
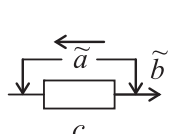
Element	Electrical	Mechanical		Acoustical	
		Admittance analogy	Impedance analogy	Impedance analogy	Admittance analogy
\tilde{a}	\tilde{e}	\tilde{u}	\tilde{f}	\tilde{p}	\tilde{U}
\tilde{b}	\tilde{i}	\tilde{f}	\tilde{u}	\tilde{U}	\tilde{p}
	$c = R_E$	$c = \frac{1}{R_M} = Y_M$	$c = R_M$	$c = R_A$	$c = \frac{1}{R_A} = Y_A$
	$c = C_E$	$c = M_M$	$c = C_M$	$c = C_A$	$c = M_A$
	$c = L$	$c = C_M$	$c = M_M$	$c = M_A$	$c = C_A$
	$c = Z_E = \frac{\tilde{e}}{\tilde{i}}$	$c = Y_M = \frac{\tilde{u}}{\tilde{f}}$ $= \frac{1}{Z_M}$	$c = Z_M = \frac{\tilde{f}}{\tilde{u}}$ $= \frac{1}{Y_M}$	$c = Z_A = \frac{\tilde{p}}{\tilde{U}}$ $= \frac{1}{Y_A}$	$c = Y_M = \frac{\tilde{U}}{\tilde{p}}$ $= \frac{1}{Z_A}$

Copyright © 2012, Elsevier Science & Technology. All rights reserved.

unlike, for example, an amplifier. If the transformation ratio is $c:1$, as illustrated in Table 3.1, then you divide the drop \tilde{a} on the primary side to obtain the drop \tilde{g} on the secondary side. Conversely, if the transformation ratio is $1:c$, then you multiply the drop \tilde{a} on the primary side to obtain the drop \tilde{g} on the secondary side. Of course, to conserve power, the opposite operation is performed on the flow, so that it increases by the same ratio that the drop decreases or vice versa.

The gyration element is used to convert an admittance-type circuit to an impedance-type one or vice versa. This means that the flow \tilde{d} on the secondary side is equal to the drop \tilde{a} on the primary side multiplied by the forward mutual conductance c_1 . Likewise, the flow \tilde{b} on the primary side is equal to the drop \tilde{g} on the secondary side multiplied by reverse mutual conductance c_2 . The forward and reverse mutual conductances c_1 and c_2 respectively may have different values in which case energy is either consumed (as in an amplifier) or dissipated. In this text, it will be used exclusively as an energy conserving element in passive transducers, in which case $c_1 = c_2 = c$.

3.3 MECHANICAL ELEMENTS

Mechanical-circuit elements need not always be represented by electrical symbols. Since one frequently draws a mechanical circuit directly from inspection of the mechanical device, more obvious forms of mechanical elements are sometimes useful, at least until the student is thoroughly familiar with the analogous circuit. We shall accordingly devise a set of “mechanical” elements to be used as an introduction to the elements of Table 3.1.

In electrical circuits, a voltage measurement is made by attaching the leads from a voltmeter *across* the two terminals of the element. Voltage is a quantity that we can measure without breaking into the circuit. To measure electric current, however, we must break into the circuit because this quantity acts *through* the element. In mechanical devices, on the other hand, we can measure the velocity (or the displacement) without disturbing the machine by using a capacitive or inertially operated vibration pickup to determine the quantity at any point on the machine. It is not velocity but force that is analogous to electric current. Force cannot be measured unless one breaks into the device.

It becomes apparent then that if a mechanical element is strictly analogous to an electrical element it must have a velocity difference appearing between (or across) its two terminals and a force acting through it. Analogously, also, the product of the rms force f in N and the in-phase component of the rms velocity u in m/s is the power in W. We shall call this type of analogy, in which a velocity corresponds to a voltage and a force to a current, the *admittance-type analogy*. It is also known as the “inverse” analogy.

Many texts teach in addition a “direct” analogy. It is the opposite of the admittance analogy in that force is made to correspond to voltage and velocity to current. In this text we shall call this kind of analogy an *impedance-type analogy*. To familiarize the student with both concepts, all examples will be given here both in admittance-type and impedance-type analogies. Table 3.3 shows a comparison of the symbolic representation of elements in each analogy.

Mechanical impedance Z_M , and *mechanical admittance* Y_M . The mechanical impedance is the complex ratio of force to velocity at a given point in a mechanical device. We commonly use the symbol Z_M for mechanical impedance, where the subscript M stands for “mechanical.” The unit is N·s/m, or mechanical ohm.

Table 3.3 Conversion from admittance-type analogy to impedance-type analogy, or vice versa

Element	Mechanical analogies		Acoustical analogies	
	Admittance type	Impedance type	Admittance type	Impedance type
Infinite impedance generator (impedance analogy) and zero admittance generator (admittance analogy)				
Zero impedance generator (impedance analogy) and infinite admittance generator (admittance analogy)				
Dissipative element – resistance (impedance analogy) and conductance (admittance analogy)				
Mass element				
Compliant element				
Impedance element (impedance analogy) and admittance element (admittance analogy)				
Transformation element – converts from one impedance to another and is useful for coupling between electrical, mechanical or acoustical domains	Mech. to acous. (admittance type) $\tilde{u} = \frac{\tilde{U}}{S}$ $\tilde{f} = S\tilde{p}$		Mech. to acous. (impedance type) $\tilde{f} = S\tilde{p}$ $\tilde{u} = \frac{\tilde{U}}{S}$	

Copyright © 2012, Elsevier Science & Technology. All rights reserved.

Table 3.3 Conversion from admittance-type analogy to impedance-type analogy, or vice versa—*cont'd*

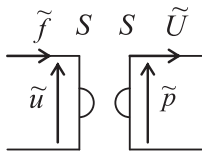
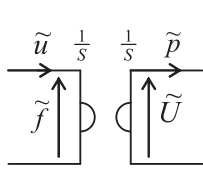
Element	Mechanical analogies		Acoustical analogies	
	Admittance type	Impedance type	Admittance type	Impedance type
Gyration element – converts an admittance circuit to an impedance one or vice versa and is useful for coupling between electrical, mechanical or acoustical domains	Mech. (admittance) to acous. (imp.)	Mech. (imp.) to acous. (admittance)		
	 $\tilde{U} = S\tilde{u}$ $\tilde{f} = S\tilde{p}$	 $\tilde{p} = \frac{\tilde{f}}{S}$ $\tilde{u} = \frac{\tilde{U}}{S}$		

In the admittance analogy, the mechanical admittance is the inverse of the mechanical impedance. It may also be referred to as the mechanical mobility, but we shall use the more commonly used term admittance. It is the complex ratio of velocity to force at a given point in a mechanical device. We commonly use the symbol Y_M for mechanical admittance. The unit is $\text{m}\cdot\text{N}^{-1}\cdot\text{s}^{-1}$, or mechanical siemens (S).

Mass M_M . Mass is that physical quantity which when acted on by a force is accelerated in direct proportion to that force. The unit is kg. At first sight, mass appears to be a one-terminal quantity because only one connection is needed to set it in motion. However, the force acting on a mass and the resultant acceleration are reckoned with respect to the earth (inertial frame) so that in reality the second terminal of mass is the earth.

The mechanical symbol used to represent mass is shown in Fig. 3.1 The upper end of the mass moves with a velocity \tilde{u} with respect to the ground. The J-shaped configuration represents the “second” terminal of the mass and has zero velocity. The force can be measured by a suitable device inserted between the point 1 and the next element or generator connecting to it.

Mass M_M obeys Newton’s second law that

$$f(t) = M_M \frac{du(t)}{dt}, \tag{3.1}$$

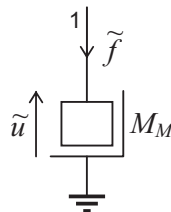

FIG. 3.1 Mechanical symbol for a mass.

Copyright © 2012, Elsevier Science & Technology. All rights reserved.

where $f(t)$ is the instantaneous force in N, M_M is the mass in kg, and $u(t)$ is the instantaneous velocity in m/s.

In the steady state [see Eqs. (2.36) to (2.44)], with an angular frequency ω equal to 2π times the frequency of vibration, we have the special case of Newton's second law,

$$\tilde{f} = j\omega M_M \tilde{u}, \quad (3.2)$$

where $j = \sqrt{-1}$ as usual.

The admittance-type analogous symbol that we use as a replacement for the mechanical symbol in our circuits is a capacitance type. It is shown in Fig. 3.2a. The mathematical operation invariant for this symbol is found from Table 3.1. In the steady state we have

$$\tilde{a} = \frac{\tilde{b}}{j\omega c} \quad \text{or} \quad \tilde{u} = \frac{\tilde{f}}{j\omega M_M}. \quad (3.3)$$

This equation is seen to satisfy the physical law given in Eq. (3.2). Note the similarity in appearance of the mechanical and analogous symbols in Fig. 3.1 and Fig. 3.2a. In electrical circuits the time integral of the current through a capacitor is charge. The analogous quantity here is the time integral of force, which is momentum.

The impedance-type analogous symbol for a mass is an inductance. It is shown in Fig. 3.2b. The invariant operation for steady state is $\tilde{a} = j\omega c \tilde{b}$ or $\tilde{f} = j\omega M_M \tilde{u}$. It also satisfies Eq. (3.2). Note, however, that in this analogy one side of the mass element is not necessarily grounded; this often leads to confusion. In electrical circuits the time integral of the voltage across an inductance is flux-turns. The analogous quantity here is momentum.

Mechanical compliance C_M . A physical structure is said to be a mechanical compliance C_M if, when it is acted on by a force, it is displaced in direct proportion to the force. The unit is m/N. Compliant elements usually have two apparent terminals.

The mechanical symbol used to represent a mechanical compliance is a spring. It is shown in Fig. 3.3. The upper end of the element moves with a velocity \tilde{u}_1 and the lower end with a velocity \tilde{u}_2 . The force required to produce the difference between the velocities \tilde{u}_1 and \tilde{u}_2 may be measured by breaking into the machine at either point 1 or point 2. Just as the same current would be measured at either end of an element in an electrical circuit, so the same force will be found here at either end of the compliant element.

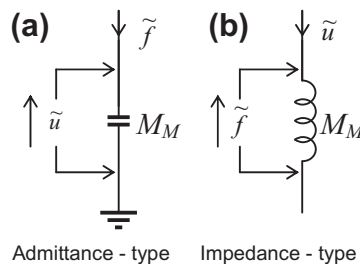

FIG. 3.2 (a) Admittance-type and (b) impedance-type symbols for a mass.



FIG. 3.3 Mechanical symbol for a mechanical compliance.

Mechanical compliance C_M obeys the following physical law:

$$a = \frac{1}{c} \int b \, dt \quad \text{or} \quad f(t) = \frac{1}{C_M} \int u(t) \, dt, \tag{3.4}$$

where C_M is the mechanical compliance in m/N and $u(t)$ is the instantaneous velocity in m/s equal to $\tilde{u}_1 - \tilde{u}_2$, the difference in velocity of the two ends.

In the steady state, with an angular frequency ω , equal to 2π times the frequency of vibration, we have

$$\tilde{f} = \frac{\tilde{u}}{j\omega C_M}, \tag{3.5}$$

where \tilde{f} and \tilde{u} are taken to be complex quantities.

The admittance-type analogous symbol used as a replacement for the mechanical symbol in our circuits is an inductance. It is shown in Fig. 3.4a. The invariant mathematical operation that this symbol represents is given in Table 3.1. In the steady state we have

$$\tilde{u} = j\omega C_M \tilde{f}. \tag{3.6}$$

In electrical circuits the time integral of the voltage across an inductance is flux-turns. The analogous quantity here is the time integral of velocity, which is displacement.

This equation satisfies the physical law given in Eq. (3.5). Note the similarity in appearance of the mechanical and analogous symbols in Fig. 3.3 and Fig. 3.4a.

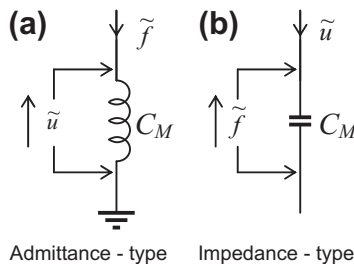

FIG. 3.4 (a) Admittance-type and (b) impedance-type symbols for a mechanical compliance.

Copyright © 2012, Elsevier Science & Technology. All rights reserved.

The impedance-type analogous symbol for a mechanical compliance is a capacitance. It is shown in Fig. 3.4*b*. The invariant operation for steady state is $\tilde{a} = \tilde{b}/j\omega c$, or $\tilde{f} = \tilde{u}/j\omega C_M$. It also satisfies Eq. (3.5). In electrical circuits the time integral of the current through a capacitor is the charge. The analogous quantity here is the displacement.

Mechanical resistance R_M , and mechanical conductance G_M . A physical structure is said to be a mechanical resistance R_M if, when it is acted on by a force, it moves with a velocity directly proportional to the force. The unit is $\text{N}\cdot\text{s}/\text{m}$ or $\text{rayls}\cdot\text{m}^2$.

We also define here a quantity G_M , the mechanical conductance, that is the reciprocal of R_M . The unit of conductance is $\text{m}\cdot\text{N}^{-1}\cdot\text{s}^{-1}$ or $\text{rayls}^{-1}\cdot\text{m}^{-2}$.

The above representation for mechanical resistance is usually limited to viscous resistance. Frictional resistance is excluded because, for it, the ratio of force to velocity is not a constant. Both terminals of resistive elements can usually be located by visual inspection.

The mechanical element used to represent viscous resistance is the fluid dashpot shown schematically in Fig. 3.5. The upper end of the element moves with a velocity \tilde{u}_1 and the lower with a velocity \tilde{u}_2 . The force required to produce the difference between the two velocities \tilde{u}_1 and \tilde{u}_2 may be measured by breaking into the machine at either point 1 or point 2.

Mechanical resistance R_M obeys the following physical law:

$$\tilde{f} = R_M \tilde{u} = \frac{1}{G_M} \tilde{u}, \quad (3.7)$$

where \tilde{f} is the force in N, \tilde{u} is the difference between the velocities \tilde{u}_1 and \tilde{u}_2 of the two ends, R_M is the mechanical resistance in $\text{N}\cdot\text{s}/\text{m}$, and G_M is the mechanical conductance in $\text{m}\cdot\text{N}^{-1}\cdot\text{s}^{-1}$.

The admittance-type analogous symbol used to replace the mechanical symbol in our circuits is a resistance. It is shown in Fig. 3.6*a*. The invariant mathematical operation that this symbol represents is given in Table 3.1. In either the steady or transient state we have

$$\tilde{u} = G_M \tilde{f} = \frac{1}{R_M} \tilde{f}. \quad (3.8)$$

In the steady state \tilde{u} and \tilde{f} are taken to be complex quantities. This equation satisfies the physical law given in Eq. (3.7).

The impedance-type analogous symbol for a mechanical resistance is shown in Fig. 3.6*b*. It also satisfies Eq. (3.7).

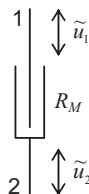

FIG. 3.5 Mechanical symbol for mechanical (viscous) resistance.

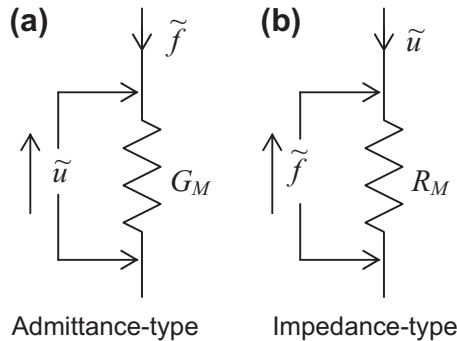

FIG. 3.6 (a) Admittance-type and (b) impedance-type symbols for a mechanical resistance.

Mechanical generators. The mechanical generators considered will be one of two types: constant-velocity or constant-force. A *constant-velocity generator* is represented as a very strong motor attached to a shuttle mechanism in the manner shown in Fig.3.7. The opposite ends of the generator have velocities \tilde{u}_1 and \tilde{u}_2 . One of these velocities, either \tilde{u}_1 or \tilde{u}_2 , is determined by factors external to the generator. The difference between the velocities \tilde{u}_1 and \tilde{u}_2 , however, is a velocity \tilde{u} that is independent of the external load connected to the generator.

The symbols that we used in the two analogies to replace the mechanical symbol for a constant-velocity generator are shown in Fig. 3.8. The invariant mathematical operations that these symbols represent are also given in Table 3.1. The tips of the arrows point to the “positive” terminals of the generators. The wave inside the circle in Fig. 3.8a indicates that the internal admittance of the generator is zero. The arrow inside the circle of Fig. 3.8b indicates that the internal impedance of the generator is infinite.

A *constant-force generator* is represented here by an electromagnetic transducer (e.g., a moving-coil loudspeaker) in the primary of which an electric current of constant amplitude is maintained. Such a generator produces a force equal to the product of the current \tilde{i} , the flux density B , and the effective length of the wire l cutting the flux ($\tilde{f} = B\tilde{i}l$). This device is shown schematically in Fig. 3.9. The opposite ends of the generator have velocities \tilde{u}_1 and \tilde{u}_2 that are determined by factors external to the

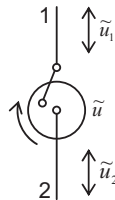

FIG. 3.7 Mechanical symbol for a constant-velocity generator.

Copyright © 2012, Elsevier Science & Technology. All rights reserved.

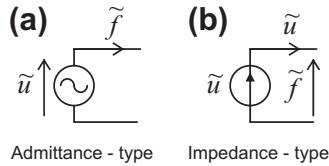

FIG. 3.8 (a) Admittance-type and (b) impedance-type symbols for a constant-velocity generator.

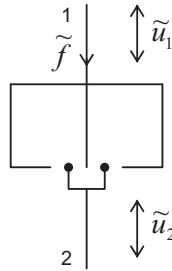

FIG. 3.9 Mechanical symbol for a constant-force generator.

generator. The force that the generator produces and that may be measured by breaking into the device at either point 1 or point 2 is a constant force, independent of what is connected to the generator.

The symbols used in the two analogies to replace the mechanical symbol for a constant-force generator are given in Fig. 3.10. The invariant mathematical operations that these symbols represent are also given in Table 3.1. The arrows point in the direction of positive flow. Here the arrow inside the circle indicates infinite admittance and the wave inside the circle zero impedance.

Levers.

Simple lever It is apparent that the lever is a device closely analogous to a transformer. The lever in its simplest form consists of a weightless bar resting on an immovable fulcrum, so arranged that a downward force on one end causes an upward force on the other end (see Fig. 3.11). From elementary physics we may write the equation of balance of moments around the fulcrum:

$$\tilde{f}_1 l_1 = \tilde{f}_2 l_2$$

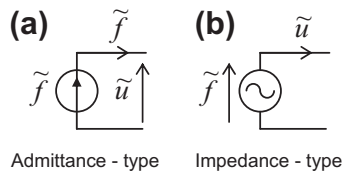

FIG. 3.10 (a) Admittance-type and (b) impedance-type symbols for a constant-force generator.

Copyright © 2012, Elsevier Science & Technology. All rights reserved.

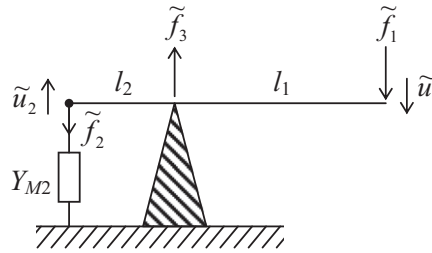

FIG. 3.11 Simple lever.

or, if not balanced, assuming small displacements,

$$\tilde{u}_1 l_2 = \tilde{u}_2 l_1. \tag{3.9}$$

Also,

$$Y_{M1} = \frac{\tilde{u}_1}{\tilde{f}_1} = \left(\frac{l_1}{l_2}\right)^2 Y_{M2}, \tag{3.10}$$

$$Z_{M1} = \frac{\tilde{f}_1}{\tilde{u}_1} = \left(\frac{l_2}{l_1}\right)^2 Z_{M2}.$$

The above equations may be represented by the ideal transformers of Fig. 3.12, having a transformation ratio of $(l_1/l_2) : 1$ for the admittance type and $(l_2/l_1) : 1$ for the impedance type.

Floating lever As an example of a simple floating lever, consider a weightless bar resting on a fulcrum that yields under force. The bar is so arranged that a downward force on one end tends to produce an upward force on the other end. An example is shown in Fig. 3.13.

To solve this type of problem, we first write the equations of moments. Summing the moments about the center support gives

$$l_1 \tilde{f}_1 = l_2 \tilde{f}_2$$

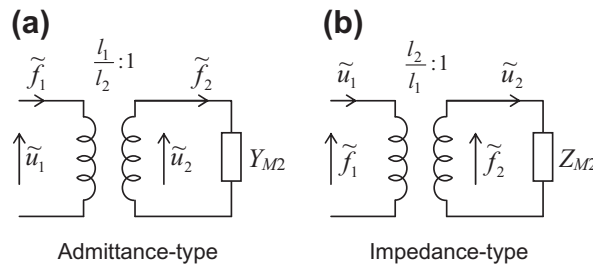

FIG. 3.12 (a) Admittance-type and (b) impedance-type symbols for a simple lever.

Copyright © 2012, Elsevier Science & Technology. All rights reserved.

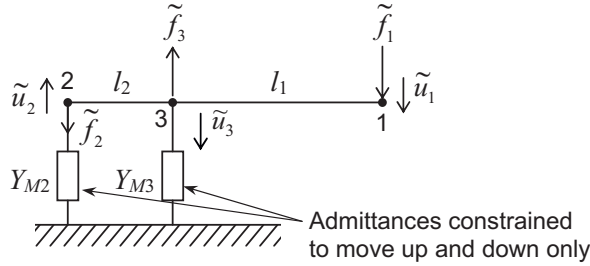

FIG. 3.13 Floating lever.

and summing the moments about the end support gives

$$(l_1 + l_2)\tilde{f}_1 = l_2 \tilde{f}_3. \tag{3.11}$$

When the forces are not balanced, and if we assume infinitesimal displacements, the velocities are related to the forces through the admittances, so that

$$\tilde{u}_3 = Y_{M3}\tilde{f}_3 = Y_{M3} \frac{l_1 + l_2}{l_2} \tilde{f}_1, \tag{3.12}$$

$$\tilde{u}_2 = Y_{M2}\tilde{f}_2 = Y_{M2} \frac{l_1}{l_2} \tilde{f}_1.$$

Also, by superposition, it is seen from simple geometry that

$$\tilde{u}'_1 = \tilde{u}_3 \frac{l_1 + l_2}{l_2} \text{ for } \tilde{u}_2 = 0,$$

$$\tilde{u}''_1 = \tilde{u}_2 \frac{l_1}{l_2} \text{ for } \tilde{u}_3 = 0,$$

so that

$$\tilde{u}_1 = \tilde{u}'_1 + \tilde{u}''_1 = \frac{l_1 + l_2}{l_2} \tilde{u}_3 + \frac{l_1}{l_2} \tilde{u}_2 \tag{3.13}$$

and, finally,

$$\frac{\tilde{u}_1}{\tilde{f}_1} = Y_{M1} = Y_{M3} \left(\frac{l_1 + l_2}{l_2} \right)^2 + Y_{M2} \left(\frac{l_1}{l_2} \right)^2. \tag{3.14}$$

This equation may be represented by the analogous circuit of Fig. 3.14. The lever loads the generator with two admittances connected in series, each of which behaves as a simple lever when the other is equal to zero. It will be seen that this is a way of obtaining the equivalent of two series masses without a common zero-velocity (ground) point. This will be illustrated in Example 3.3.

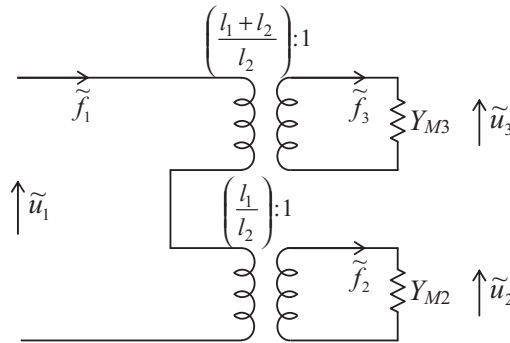

FIG. 3.14 Admittance-type symbol for a floating lever.

Example 3.1. The mechanical device of Fig. 3.15 consists of a piston of mass M_{M1} sliding on an oil surface inside a cylinder of mass M_{M2} . This cylinder in turn slides in an oiled groove cut in a rigid body. The sliding (viscous) resistances are R_{M1} and R_{M2} , respectively. The cylinder is held by a spring of compliance C_M . The mechanical generator maintains a constant sinusoidal velocity of angular frequency ω , whose magnitude is \tilde{u} m/s. Solve for the force \tilde{f} produced by the generator.

Solution. Although the force will be determined ultimately from an analysis of the admittance-type analogous circuit for this mechanical device, it is frequently useful to draw a mechanical-circuit diagram. This interim step to the desired circuit will be especially helpful to the student who is inexperienced in the use of analogies. Its use virtually eliminates errors from the final circuit.

To draw the mechanical circuit, note first the junction points of two or more elements. This locates all element terminals which move with the same velocity. There are in this example two velocities, \tilde{u} and \tilde{u}_2 , in addition to “ground,” or zero velocity. These two velocities are represented in the mechanical-circuit diagram by the velocities of two imaginary rigid bars, 1 and 2 of Fig. 3.16, which oscillate in a vertical direction. The circuit drawing is made by attaching all element terminals with velocity \tilde{u} to the first bar and all terminals with velocity \tilde{u}_2 to the second bar. All terminals with zero velocity are drawn to a ground bar. Note that a mass always has one terminal on ground. [8] Three elements of Fig. 3.15 have one terminal with the velocity \tilde{u} : the generator, the mass M_{M1} , and the

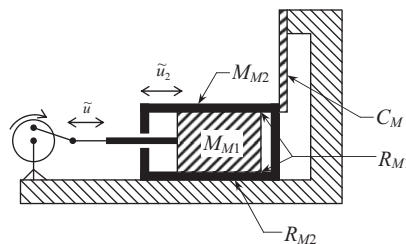

FIG. 3.15 Six-element mechanical device.

Copyright © 2012, Elsevier Science & Technology. All rights reserved.

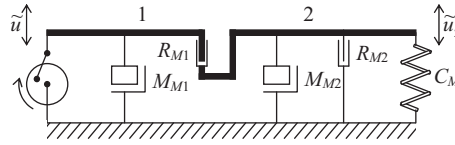

FIG. 3.16 Mechanical circuit for the device of Fig. 3.15.

viscous resistance R_{M1} . These are attached to bar 1. Four elements have one terminal with the velocity \tilde{u}_2 : the viscous resistances R_{M1} and R_{M2} , the mass M_{M2} , and the compliance C_M . These are attached to bar 2. Five elements have one terminal with zero velocity: the generator, both masses, the viscous resistance R_{M2} , and the compliance C_M .

We are now in a position to transform the mechanical circuit into an admittance-type analogous circuit. This is accomplished simply by replacing the mechanical elements with the analogous admittance-type elements. The circuit becomes that shown in Fig. 3.17. Remember that, in the admittance-type analogy, force “flows” through the elements and velocity is the drop across them. The resistors must have G 's written alongside them. As defined above, $G_M = 1/R_M$, and the unit is $\text{m} \cdot \text{N}^{-1} \cdot \text{s}^{-1}$ or mechanical siemens.

The equations for this circuit are found in the usual manner, using the rules of Table 3.1. Let us determine $Y_M = \tilde{u}/\tilde{f}$, the mechanical admittance presented to the generator. The mechanical admittance of the three elements in parallel on the right-hand side of the schematic diagram is

$$\begin{aligned} \frac{\tilde{u}_2}{\tilde{f}_2} &= \frac{1}{\frac{1}{j\omega M_{M2}} + G_{M2} + \frac{1}{j\omega C_M}} \\ &= \frac{1}{j\omega M_{M2} + R_{M2} + \frac{1}{j\omega C_M}}. \end{aligned}$$

Including the element G_{M1} the mechanical admittance for that part of the circuit through which \tilde{f}_2 flows is, then,

$$\frac{\tilde{u}}{\tilde{f}_2} = G_{M1} + \frac{1}{j\omega M_{M2} + R_{M2} + \frac{1}{j\omega C_M}}.$$

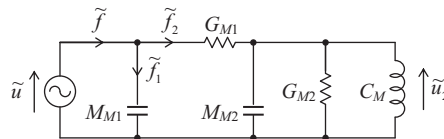

FIG. 3.17 Admittance-type analogous circuit for the device of Fig. 3.15.

Copyright © 2012, Elsevier Science & Technology. All rights reserved.

Note that the input mechanical admittance Y_M is given by

$$Y_M = \frac{\tilde{u}}{\tilde{f}} + \frac{\tilde{u}}{\tilde{f}_1 + \tilde{f}_2}$$

and

$$\tilde{f}_1 = \frac{\tilde{u}}{1/j\omega M_{M1}} = j\omega M_{M1}\tilde{u}$$

Substituting \tilde{f}_1 , and \tilde{f}_2 into the second equation preceding gives us the input admittance:

$$Y_M = \frac{\tilde{u}}{\tilde{f}} = \frac{1}{j\omega M_{M1} + \frac{1}{G_{M1} + \frac{1}{j\omega M_{M2} + R_{M2} + \frac{1}{j\omega C_M}}}} \tag{3.15a}$$

The mechanical impedance is the reciprocal of Eq. (3.15a):

$$Z_M = \frac{\tilde{f}}{\tilde{u}} = j\omega M_{M1} + \frac{1}{G_{M1} + \frac{1}{j\omega M_{M2} + R_{M2} + \frac{1}{j\omega C_M}}} \tag{3.15b}$$

The result is

$$\tilde{f} = Z_M \tilde{u} \text{ N.} \tag{3.16}$$

Example 3.2. As a further example of a mechanical circuit, let us consider the two masses of 2 and 4 kg shown in Fig. 3.18. They are assumed to rest on a frictionless plane surface and to be connected together through a generator of constant velocity that is also free to slide on the frictionless plane surface.

Let its velocity be

$$u_0(t) = 2 \cos 1000t \text{ cm/s}$$

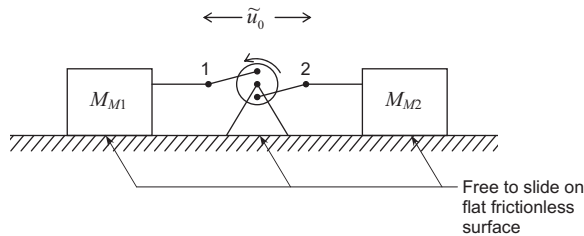

FIG. 3.18 Three-element mechanical device.

so that

$$\tilde{u}_0 = 2e^{j1000t} \text{ cm/s}$$

or

$$|\tilde{u}_0| = 2 \text{ cm/s at } \omega = 1000 \text{ Hz.}$$

Draw the admittance-type analogous circuit, and determine the force \tilde{f} produced by the generator. Also, determine the admittance presented to the generator.

Solution. The masses do not have the same velocity with respect to ground. The difference between the velocities of the two masses is \tilde{u}_0 . The element representing a mass is that shown in Fig. 3.2a with one end grounded and the other moving at the velocity of the mass.

The admittance-type circuit for this example is shown in Fig. 3.19. The velocity \tilde{u}_0 equals $\tilde{u}_1 + \tilde{u}_2$, where \tilde{u}_1 is the velocity *with respect to ground* of M_1 , and \tilde{u}_2 is that for M_2 . The force \tilde{f} is

$$\begin{aligned} \tilde{f} &= \frac{1}{(1/j\omega M_{M1}) + (1/j\omega M_{M2})} |\tilde{u}_0| e^{j1000t} \\ &= \frac{j\omega M_{M1} M_{M2}}{M_{M1} + M_{M2}} |\tilde{u}_0| e^{j1000t} \\ &= \frac{j1000 \times 2 \times 4 \times 0.02}{2 + 4} e^{j1000t} = j26.7 e^{j1000t} \text{ N.} \end{aligned} \tag{3.17}$$

The j indicates that the time phase of the force is 90° leading with respect to that of the velocity of the generator. Hence the rms force is

$$f_{\text{rms}} = \frac{|\tilde{f}|}{\sqrt{2}} \angle 90^\circ = 18.9 \text{ N} \angle 90^\circ \tag{3.18}$$

Obviously, when one mass is large compared with the other, the force is that necessary to move the smaller one alone. This example reveals the only type of case in which masses can be in series without the introduction of floating levers. At most, only two masses can be in series because a common ground is necessary.

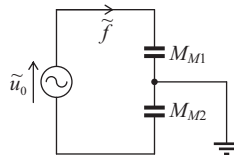

FIG. 3.19 Admittance-type analogous circuit for the device of Fig. 3.18.

Copyright © 2012, Elsevier Science & Technology. All rights reserved.

The admittance presented to the generator is

$$\begin{aligned}
 Y_M &= \frac{\tilde{u}_0}{\tilde{f}} = \frac{M_{M1} + M_{M2}}{j\omega M_{M1}M_{M2}} \\
 &= \frac{6}{j1000 \times 8} = -j7.5 \times 10^{-4} \text{ m} \cdot \text{N}^{-1} \cdot \text{s}^{-1}
 \end{aligned}
 \tag{3.19}$$

Example 3.3. An example of a mechanical device embodying a floating lever is shown in Fig. 3.20. The masses attached at points 2 and 3 may be assumed to be resting on very compliant springs. The driving force \tilde{f}_1 will be assumed to have a frequency well above the resonance frequencies of the masses and their spring supports so that

$$Y_{M2} \approx \frac{1}{j\omega M_{M2}}$$

$$Y_{M3} \approx \frac{1}{j\omega M_{M3}}$$

Also, assume that a mass is attached to the weightless lever bar at point 1, with an admittance

$$Y_{M1} = \frac{1}{j\omega M_{M1}}.$$

Solve for the total admittance presented to the constant-force generator \tilde{f}_1 .

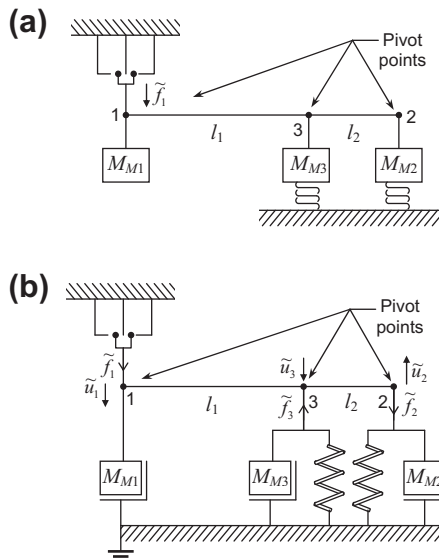

FIG. 3.20 (a) Mechanical device embodying a floating lever. (b) Mechanical diagram of (a).

The compliances of the springs are very large so that all of \tilde{f}_2 and \tilde{f}_3 go to move M_{M2} and M_{M3} .

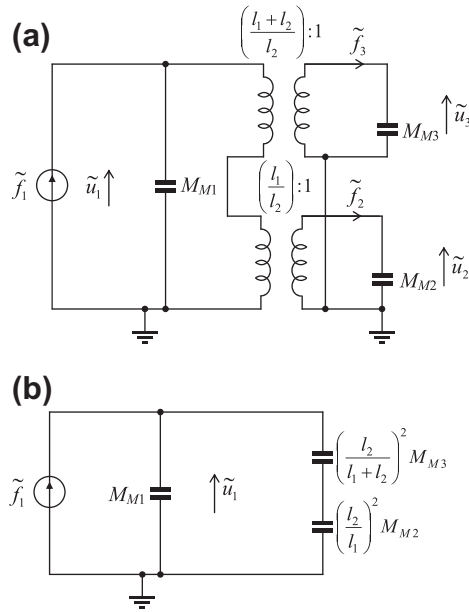

FIG. 3.21 (a) Admittance-type analogous circuit for the device of Fig. 3.20. (b) Same as (a) but with transformers removed.

Solution. By inspection, the admittance-type analogous circuit is drawn as shown in Fig. 3.21a and Fig. 3.21b. Solving for $Y_M = \tilde{u}_1/\tilde{f}_1$, we get

$$Y_M = \frac{1}{j\omega \left[\frac{M_{M2}M_{M3}l_2^2}{M_{M3}l_1^2 + M_{M2}(l_1 + l_2)^2} + M_{M1} \right]} \quad (3.20)$$

Note that if $l_2 \rightarrow 0$, the admittance is simply that of the mass M_{M1} . Also, if $l_1 \rightarrow 0$, the admittance is that of M_{M1} and M_{M3} , that is,

$$Y_M = \frac{1}{j\omega(M_{M3} + M_{M1})} \quad (3.21)$$

In an admittance-type circuit (with transformers eliminated), it is possible with one or more floating levers to have one or more M_M 's with no ground terminal (s).

PART VII: ACOUSTICAL CIRCUITS

3.4 ACOUSTICAL ELEMENTS

Acoustical circuits are frequently more difficult to draw than mechanical ones because the elements are less easy to identify. As was the case for mechanical circuits, the more obvious forms of the

elements will be useful as an intermediate step toward drawing the analogous circuit diagram. When the student is more familiar with acoustical circuits, he or she will be able to pass directly from the acoustic device to the final form of the equivalent circuit.

In acoustic devices, the quantity we are able to measure most easily without modification of the device is sound pressure. Such a measurement is made by inserting a small hollow probe tube into the sound field at the desired point. This probe tube leads to one side of a microphone diaphragm. The other side of the diaphragm is exposed to atmospheric pressure. A movement of the diaphragm takes place when there is a difference in pressure across it. This difference between atmospheric pressure and the incremental pressure created by the sound field is the sound pressure \tilde{p} .

Because we can measure sound pressure by such a probe-tube arrangement without disturbing the device, it seems that sound pressure is analogous to voltage in electrical circuits. Such a choice requires us to consider current as being analogous to some quantity which is proportional to velocity. As we shall show shortly, a good choice is to make current analogous to volume velocity, the volume of gas displaced per second.

A strong argument can be made for this choice of analogy when one considers the relations governing the flow of air inside such acoustic devices as loudspeakers, microphones, and noise filters. Inside a certain type of microphone, for example, there is an air cavity that connects to the outside air through a small tube (see Fig. 3.22). Assume, now, that the outer end of this tube is placed in a sound wave. The wave will cause a movement of the air particles in the tube. Obviously, there is a junction between the tube and the cavity at the inner end of the tube at point A . Let us ask ourselves the question, “What physical quantities are continuous at this junction point?”

First, the sound pressure just inside the tube at A is the same as that in the cavity just outside A . That is to say, we have continuity of sound pressure. Second, the quantity of air leaving the inner end of the small tube in a given interval of time is the quantity that enters the cavity in the same interval of time. That is, the mass per second of gas leaving the small tube equals the mass per second of gas entering the volume. Because the pressure is the same at both places, the density of the gas must also be the same, and it follows that there is continuity of volume velocity (cubic meters per second or m^3/s) at this junction. Analogously, in the case of electricity, there is continuity of electric current at a junction. Continuity of volume velocity must exist even if there are several tubes or cavities joining near one point. A violation of the law of conservation of mass otherwise would occur.

We conclude that the quantity that flows *through* our acoustical elements must be the volume velocity U in m^3/s and the drop across our acoustical elements must be the pressure p in Pa. This

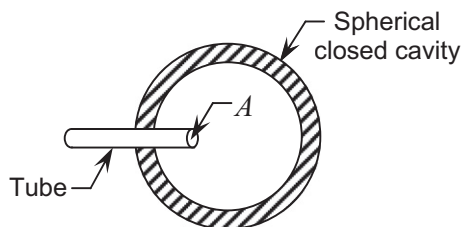

FIG. 3.22 Closed cavity connecting to the outside air through a tube of cross-sectional area S .

The junction plane between the tube and the cavity occurs at A .

conclusion indicates that the impedance type of analogy is the preferred analogy for acoustical circuits. The product of the effective sound pressure p times the in-phase component of the effective volume velocity U gives the acoustic power in W .

In this part, we shall discuss the more general aspects of acoustical circuits. In Chapter 4 of this book, we explain fully the approximations involved and the rules for using the concepts enunciated here in practical problems.

Acoustic mass M_A . Acoustic mass is a quantity proportional to mass but having the dimensions of kg/m^4 . It is associated with a mass of air accelerated by a net force which acts to displace the gas without appreciably compressing it. The concept of acceleration without compression is an important one to remember. It will assist you in distinguishing acoustic masses from other elements.

The acoustical element that is used to represent an acoustic mass is a tube filled with the gas as shown in Fig. 3.23.

The physical law governing the motion of a mass that is acted on by a force is Newton's second law, $f(t) = M_M du(t)/dt$. This law may be expressed in acoustical terms as follows:

$$\frac{f(t)}{S} = \frac{M_M}{S} \frac{d[u(t)S]}{dt S} = p(t) = \frac{M_M}{S^2} \frac{dU(t)}{dt}$$

$$p(t) = M_A \frac{dU(t)}{dt} \quad (3.22)$$

where

$p(t)$ is the instantaneous difference between pressures in Pa existing at each end of a mass of gas of M_M kg undergoing acceleration.

$M_A = M_M/S^2$ is the acoustic mass in kg/m^4 of the gas undergoing acceleration. This quantity is nearly equal to the mass of the gas inside the containing tube divided by the square of the cross-sectional area. To be more exact we must note that the gas in the immediate vicinity of the ends of the tube also adds to the mass. Hence, there are "end corrections" which must be considered. These corrections are discussed in Chapter 4 (page 121).

$U(t)$ is the instantaneous volume velocity of the gas in m^3/s across any cross-sectional plane in the tube. The volume velocity $U(t)$ is equal to the linear velocity $u(t)$ multiplied by the cross-sectional area S .

In the steady state, with an angular frequency ω , we have

$$\tilde{p} = j\omega M_A \tilde{U} \quad (3.23)$$

where \tilde{p} and \tilde{U} are taken to be complex quantities.

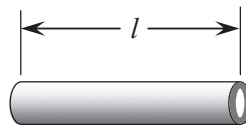

FIG. 3.23 Tube of length l and cross-sectional area S .

The impedance-type analogous symbol for acoustic mass is shown in Fig. 3.24a, and the admittance-type is given in Fig. 3.24b. In the steady state, for either, we get Eq. (3.23). The arrows point in the direction of positive flow or positive drop.

Acoustic compliance C_A . Acoustic compliance is a constant quantity having the dimensions of m^5/N . It is associated with a volume of air that is compressed by a net force without an appreciable average displacement of the center of gravity of air in the volume. In other words, compression without acceleration identifies an acoustic compliance.

The acoustical element that is used to represent an acoustic compliance is a volume of air drawn as shown in Fig. 3.25.

The physical law governing the compression of a volume of air being acted on by a net force was given as

$$f(t) = (1/C_M) \int u(t) dt.$$

Converting from mechanical to acoustical terms,

$$\frac{f(t)}{S} = \frac{1}{C_M S} \int u(t) \frac{S}{S} dt \quad \text{or} \quad p(t) = \frac{1}{C_M S^2} \int U(t) dt$$

or

$$p(t) = \frac{1}{C_A} \int U(t) dt. \tag{3.24}$$

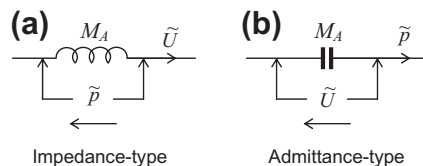

FIG. 3.24 (a) Impedance-type and (b) admittance-type symbols for an acoustic mass.

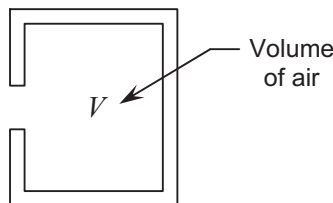

FIG. 3.25 Enclosed volume of air V with opening for entrance of pressure variations.

Copyright © 2012, Elsevier Science & Technology. All rights reserved.

where

$p(t)$ is instantaneous pressure in Pa acting to compress the volume V of the air.
 $C_A = C_M S^2$ is acoustic compliance in m^5/N of the volume of the air undergoing compression. The acoustic compliance is nearly equal to the volume of air divided by γP_0 , as we shall see in Chapter 4 (page 121 to 125).
 $U(t)$ is instantaneous volume velocity in m^3/s of the air flowing into the volume that is undergoing compression. The volume velocity $U(t)$ is equal to the linear velocity $u(t)$ multiplied by the cross-sectional area S .

In the steady state with an angular frequency ω , we have

$$\tilde{p} = \frac{\tilde{U}}{j\omega C_A}, \tag{3.25}$$

where \tilde{p} and \tilde{U} are taken to be complex quantities.

The impedance-type analogous element for acoustic compliance is shown in Fig. 3.26a and the admittance-type in Fig. 3.26b. In the steady state for either, Eq. (3.25) applies.

Acoustic resistance R_A , and acoustic conductance G_A . Acoustic resistance R_A is associated with the dissipative losses occurring when there is a viscous movement of a quantity of gas through a fine-mesh screen or through a capillary tube. The unit is $N \cdot s/m^5$ or rayls/m².

The acoustic element used to represent an acoustic resistance is a fine-mesh screen drawn as shown in Fig. 3.27.

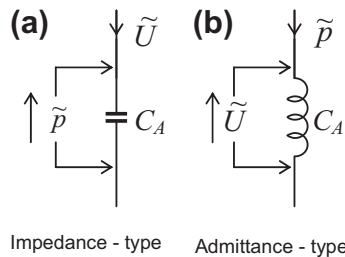

FIG. 3.26 (a) Impedance- type and (b) admittance-type symbols for an acoustic compliance.



FIG. 3.27 Fine-mesh screen which serves as an acoustical symbol for acoustic resistance.

The reciprocal of acoustic resistance is the acoustic conductance G_A . The unit is $\text{m}^5 \cdot \text{N}^{-1} \cdot \text{s}^{-1}$ or acoustic siemens.

The physical law governing dissipative effects in a mechanical system was given by $f(t) = R_M u(t)$, or, in terms of acoustical quantities,

$$p(t) = R_A U(t) = \frac{1}{G_A} U(t), \tag{3.26}$$

where

$p(t)$ is the difference between instantaneous pressures in Pa across the dissipative element.

$R_A = R_M/S^2$ is acoustic resistance in $\text{N} \cdot \text{s}/\text{m}^5$.

$G_A = G_M/S^2$ is acoustic conductance in $\text{m}^5 \cdot \text{N}^{-1} \cdot \text{s}^{-1}$.

$U(t)$ is instantaneous volume velocity in m^3/s of the gas through the cross-sectional area of resistance.

The impedance-type analogous symbol for acoustic resistance is shown in Fig. 3.28a and the admittance-type in Fig. 3.28b.

Acoustic generators. Acoustic generators can be of either the constant-volume velocity or the constant-pressure type. The prime movers in our acoustical circuits will be exactly like those shown in Fig. 3.7 and Fig. 3.9 except that \tilde{u}_2 often will be zero and \tilde{u}_1 will be the velocity of a small piston of area S . Remembering that $\tilde{u} = \tilde{u}_1 - \tilde{u}_2$, we see that the generator of Fig. 3.7 has a constant-volume velocity $\tilde{U} = \tilde{u}S$ and that of Fig. 3.9 a constant pressure of $\tilde{p} = \tilde{f}/S$.

The two types of analogous symbols for acoustic generators are given in Fig. 3.29 and Fig. 3.30. The arrows point in the direction of the positive terminal or the positive flow. As before, a wave inside the

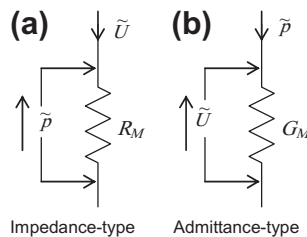

FIG. 3.28 (a) Impedance-type symbol for acoustic resistance and (b) admittance-type symbol for acoustic conductance.

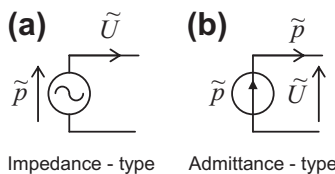

FIG. 3.29 (a) Impedance-type and (b) admittance-type symbols for a constant pressure generator.

Copyright © 2012, Elsevier Science & Technology. All rights reserved.

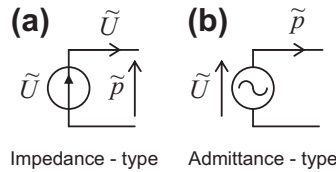

FIG. 3.30 (a) Impedance-type and (b) admittance-type symbols for a constant-volume velocity generator.

circle indicates zero impedance or admittance and an arrow inside the circle indicates infinite impedance or admittance.

Example 3.4. The acoustic device of Fig. 3.31 consists of three cavities V_1 , V_2 and V_3 , two fine-mesh screens R_{A1} and R_{A2} , four short lengths of tube T_1 , T_2 , T_3 , and T_4 , and a constant-pressure generator. Because the air in the tubes is not confined, it experiences negligible compression. Because the air in each of the cavities is confined, it experiences little average movement. Let the force of the generator be

$$f(t) = 10^{-5} \cos \omega t \text{ N}$$

so that

$$\tilde{f} = 10^{-5} e^{j\omega t} \text{ N}$$

or

$$|\tilde{f}| = 10^{-5} \text{ N at } \omega = 1000 \text{ Hz.}$$

Also, let the radius of the tube $a = 0.5 \text{ cm}$; the length of each of the four tubes $l = 5 \text{ cm}$; the volume of each of the three cavities $V = 10 \text{ cm}^3$; and the magnitude of the two acoustic resistances $R_A = 10 \text{ N} \cdot \text{s} / \text{m}^5$. Neglecting end corrections, solve for the volume velocity \tilde{U}_0 at the end of the tube T_4 .

Solution. Remembering that there is continuity of volume velocity and pressure at the junctions, we can draw the impedance-type analogous circuit from inspection. It is shown in Fig. 3.32. The bottom line of the schematic diagram represents atmospheric pressure, which means that here the variational pressure \tilde{p} is equal to zero. At each of the junctions of the elements 1 to 4, a different variational pressure can be observed. The end of the fourth tube (T_4) opens to the atmosphere, which requires that M_{A4} be connected directly to the bottom line of Fig. 3.32.

Note that the volume velocity of the gas leaving the tube T_1 is equal to the sum of the volume velocities of the gas entering V_1 and T_2 . The volume velocity of the gas leaving T_2 is the same as that flowing through the screen R_{A1} and is equal to the sum of the volume velocities of the gas entering V_2 and T_3 .

One test of the validity of an analogous circuit is its behavior for direct current. If one removes the piston and blows into the end of the tube T_1 (Fig. 3.31), a steady flow of air from T_4 is observed. Some resistance to this flow will be offered by the two screens R_{A1} and R_{A2} . Similarly in the schematic diagram of Fig. 3.32, a steady pressure \tilde{p} will produce a steady flow \tilde{U} through M_{A4} , resisted only by R_{A1} and R_{A2} .

As an aside, let us note that an acoustic compliance can occur in a circuit without one of the terminals being at ground potential only if it is produced by an elastic diaphragm. For example, if the

Copyright © 2012, Elsevier Science & Technology. All rights reserved.

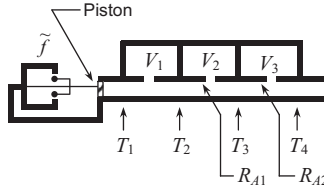

FIG. 3.31 Acoustic device consisting of four tubes, three cavities, and two screens driven by a constant-pressure generator.

resistance in Fig. 3.31 were replaced by an impervious but elastic diaphragm, the element R_{A1} in Fig. 3.32 would be replaced by a compliance-type element with both terminals above ground potential. In this case a steady flow of air could not be maintained through the device of Fig. 3.31 as can also be seen from the circuit of Fig. 3.32, with R_{A1} replaced by a compliance.

Determine the element sizes of Fig. 3.32:

$$\tilde{p} = \frac{\tilde{f}}{S} = \frac{10^{-5}e^{j1000t}}{\pi(5 \times 10^{-3})^2} = 0.1273e^{j1000t} \text{ Pa,}$$

$$M_{A1} = M_{A2} = M_{A3} = M_{A4} = \frac{\rho_0 l}{S} = \frac{1.18 \times 0.05}{7.85 \times 10^{-5}} = 750 \text{ kg/m}^4,$$

$$C_{A1} = C_{A2} = C_{A3} = \frac{V}{\gamma P_0} = \frac{10^{-5}}{1.4 \times 10^5} = 7.15 \times 10^{-11} \text{ m}^5/\text{N,}$$

$$R_{A1} = R_{A2} = 10 \text{ N}\cdot\text{s/m}^5.$$

We now determine the ratio \tilde{p}/\tilde{U}_0 .

$$\tilde{p}_4 = j\omega M_{A4}\tilde{U}_0 = j7.5 \times 10^5 \times \tilde{U}_0 \text{ Pa}$$

$$\tilde{U}_5 = j\omega C_{A3}\tilde{p}_4 = -5.36 \times 10^{-2} \times \tilde{U}_0 \text{ m}^3/\text{s}$$

$$\tilde{U}_4 = \tilde{U}_5 + \tilde{U}_0 = 0.946\tilde{U}_0$$

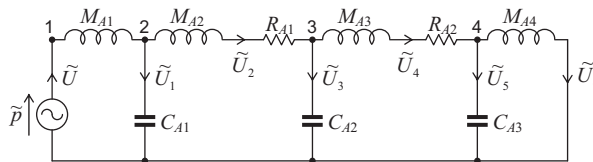

FIG. 3.32 Impedance-type analogous circuit for the acoustic device of Fig. 3.31.

Copyright © 2012, Elsevier Science & Technology. All rights reserved.

$$\begin{aligned} \tilde{p}_3 &= (R_{A2} + j\omega M_{A3})\tilde{U}_4 + \tilde{p}_4 = (9.46 + j14.6 \times 10^5)\tilde{U}_0 \\ \tilde{U}_3 &= j\omega C_{A2}\tilde{p}_3 = (-0.1043 + j6.77 \times 10^{-7})\tilde{U}_0 \\ \tilde{U}_2 &= \tilde{U}_3 + \tilde{U}_4 = (0.842 + j6.77 \times 10^{-7})\tilde{U}_0 \\ \tilde{p}_2 &= (R_{A1} + j\omega M_{A2})\tilde{U}_2 + \tilde{p}_3 = (17.37 + j2.091 \times 10^6)\tilde{U}_0 \\ \tilde{U}_1 &= j\omega C_{A1}\tilde{p}_2 = (-0.1496 + j1.242 \times 10^{-6})\tilde{U}_0 \\ \tilde{U} &= \tilde{U}_2 + \tilde{U}_1 = (0.692 + j1.919 \times 10^{-6})\tilde{U}_0 \\ \tilde{p} &= j\omega M_{A1}\tilde{U} + \tilde{p}_2 = (15.93 + j2.61 \times 10^6)\tilde{U}_0. \end{aligned}$$

The desired value of \tilde{U}_0 is

$$\tilde{U}_0 = \frac{0.1273e^{j1000t}}{15.93 + j2.61 \times 10^6}$$

or

$$\begin{aligned} U(t) &\approx 4.88 \times 10^{-8} \cos(1000t - 90^\circ) \\ &\approx 4.88 \times 10^{-8} \sin 1000t. \end{aligned}$$

In other words, the impedance is principally that of the four acoustic masses in series so that \tilde{U}_0 lags \tilde{p} by nearly 90° .

Example 3.5. A Helmholtz resonator is frequently used as a means for eliminating an undesired frequency component from an acoustic system. An example is given in Fig. 3.33a. A constant-force generator G produces a series of tones, among which is one that is not wanted. These tones actuate a microphone M whose acoustic impedance is $500 \text{ N} \cdot \text{s}/\text{m}^2$. If the tube T has a cross-sectional area of 5 cm^2 , $l_1 = l_2 = 5 \text{ cm}$, $l_3 = 1 \text{ cm}$, $V = 1000 \text{ cm}^3$, and the cross-sectional area of l_3 is 2 cm^2 , what frequency is eliminated from the system?

Solution. By inspection we may draw the impedance-type analogous circuit of Fig. 3.33b. The element sizes are

$$M_{A1} = M_{A2} = \frac{\rho_0 l_1}{S_T} = \frac{1.18 \times 0.05}{5 \times 10^{-4}} = 118 \text{ kg}/\text{m}^4,$$

$$M_{A3} = \frac{\rho_0 l_3}{S_R} = \frac{1.18 \times 0.01}{2 \times 10^{-4}} = 59 \text{ kg}/\text{m}^4,$$

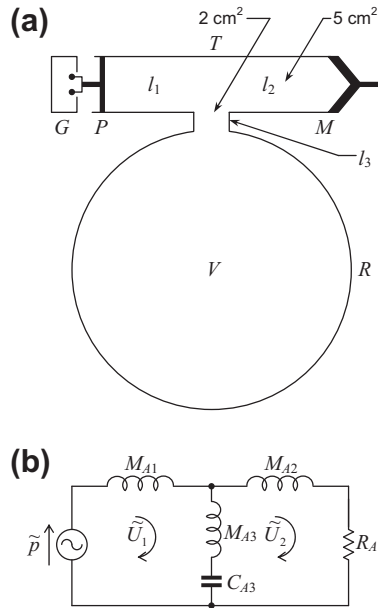

FIG. 3.33 (a) Acoustic device consisting of a constant-force generator G , piston P , tube T with length $l_1 + l_2$, microphone M , and Helmholtz resonator R with volume V and connecting tube as shown. (b) Impedance-type analogous circuit for the device of (a).

$$C_{A3} = \frac{V}{\gamma P_0} = \frac{10^{-3}}{1.4 \times 10^5} = 7.15 \times 10^{-9} \text{ m}^5/\text{N},$$

$$R_{A1} = 500 \text{ N}\cdot\text{s}/\text{m}^5.$$

It is obvious that the volume velocity \tilde{U}_2 of the transducer M will be zero when the shunt branch is at resonance. Hence,

$$\omega = \frac{1}{\sqrt{M_{A3}C_{A3}}} = \frac{10^4}{\sqrt{42.2}} = 1540 \text{ rad/s},$$

$$f = 245 \text{ Hz}.$$

Mechanical rotational systems. Mechanical rotational systems are handled in the same manner as mechanical rectilinear systems. Table 3.4 shows quantities analogous in the two systems.

Copyright © 2012, Elsevier Science & Technology. All rights reserved.

Table 3.4 Analogous quantities in rectilinear and rotational systems

Rectilinear systems			Rotational systems		
Symbol	Quantity	Unit	Symbol	Quantity	Unit
\tilde{f}	Force	N	\tilde{T}	Torque	N·m
\tilde{u}	Velocity	m/s	$\tilde{\theta}$	Angular velocity	rad/s
$\tilde{\xi}$	Displacement	m	$\tilde{\phi}$	Angular displacement	rad
$Z_M = \tilde{f}/\tilde{u}$	Mechanical impedance	N·s/m	$Z_R = \tilde{T}/\tilde{\theta}$	Rotational impedance	N·m·s/rad
$Y_M = \tilde{u}/\tilde{f}$	Mechanical admittance	m·N ⁻¹ ·s ⁻¹	$Y_R = \tilde{\theta}/\tilde{T}$	Rotational admittance	rad·N ⁻¹ ·m ⁻¹ ·s ⁻¹
R_M	Mechanical resistance	N·s/m	R_R	Rotational resistance	N·m·s/rad
G_M	Mechanical conductance	m·N ⁻¹ ·s ⁻¹	G_R	Rotational conductance	rad·N ⁻¹ ·m ⁻¹ ·s ⁻¹
M_M	Mass	kg	I_R	Moment of inertia	kg·m ²
C_M	Mechanical compliance	m/N	C_R	Rotational compliance	rad/N·m
W_M	Mechanical power	W	W_R	Rotational power	W

PART VIII: TRANSDUCERS

A transducer is defined as a device for converting energy from one form to another. Of importance in this text is the electromechanical transducer for converting electrical energy into mechanical energy, and vice versa. There are many types of such transducers. In acoustics we are concerned with microphones, earphones, loudspeakers, and vibration pickups and vibration producers which are generally linear passive reversible networks.

The type of electromechanical transducer chosen for each of these instruments depends upon such factors as the desired electrical and mechanical impedances, durability, and cost. It will not be possible here to discuss all means for electromechanical transduction. Instead we shall limit the discussion to electromagnetic and electrostatic types. Also, we shall deal with mechano-acoustic transducers for converting mechanical energy into acoustic energy.

3.5 ELECTROMECHANICAL TRANSDUCERS

Two types of electromechanical transducers, electromagnetic and electrostatic, are commonly employed in loudspeakers and microphones. Both may be represented by transformers with properties that permit the joining of mechanical and electrical circuits into one schematic diagram.

3.5.1 Electromagnetic-mechanical transducer

This type of transducer can be characterized by four terminals. Two have voltage and current associated with them. The other two have velocity and force as the measurable properties. Familiar

examples are the moving-coil loudspeaker or microphone and the variable-reluctance earphone or microphone.

The simplest type of moving-coil transducer is a single length of wire in a uniform magnetic field as shown in Fig. 3.34. When a wire is moved upward with a velocity \tilde{u} as shown in Fig. 3.34a, a potential difference \tilde{e} will be produced in the wire such that terminal 2 is positive. If, on the other hand, the wire is fixed in the magnetic field (Fig. 3.34b) and a current \tilde{i} is caused to flow into terminal 2 (therefore, 2 is positive), a force \tilde{f} will be produced that acts on the wire upward in the same direction as that indicated previously for the velocity.

The basic equations applicable to the moving-coil type of transducer are

$$\tilde{f} = Bl \tilde{i}, \tag{3.27a}$$

$$\tilde{e} = Bl \tilde{u}, \tag{3.27b}$$

where

- \tilde{i} is electrical current in A,
- \tilde{f} is “open-circuit” force in N produced on the mechanical circuit by the current \tilde{i} ,
- B is magnetic-flux density in T,
- l is effective length in m of the electrical conductor that moves at right angles across the lines of force of flux density B
- \tilde{u} is velocity in m/s
- \tilde{e} is “open-circuit” electrical voltage in V produced by a velocity \tilde{u} .

The right-hand sides of Eqs. (3.27) have the same sign because when \tilde{u} and \tilde{f} are in the same direction the electrical terminals have the same sign.

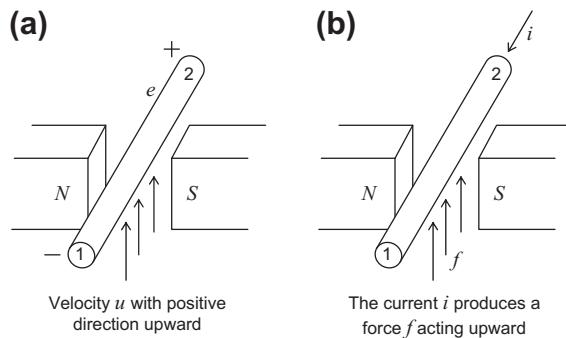

FIG. 3.34 Simplified form of moving-coil transducer consisting of a single length of wire cutting a magnetic field of flux density B .

(a) The conductor is moving vertically at constant velocity so as to generate an open-circuit voltage across terminals 1 and 2. (b) A constant current is entering terminal 2 to produce a force on the conductor in a vertical direction.

Copyright © 2012, Elsevier Science & Technology. All rights reserved.

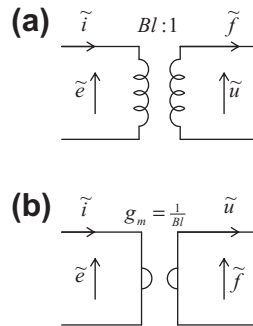

FIG. 3.35 Analogous symbols for the electromagnetic-transducer of Fig. 3.34.

(a) The mechanical side is of the admittance type. (b) The mechanical side is of the impedance type.

One analogous symbol for this type of transducer is the “ideal” transformer given in Fig. 3.35a. The “windings” on this ideal transformer have infinite impedance, and the transformer obeys Eqs. (3.27) at all frequencies, including steady flow. The mechanical side of this symbol necessarily is of the admittance type if current flows in the primary. The other analogous symbol is the “ideal” gyrator given in Fig. 3.35b. It is customary to define the mutual conductance g_m of a gyrator, which is the same in both directions, as the ratio of the flow on one side to the drop on the other. The mechanical side of this symbol necessarily is of the impedance type if current flows in the primary. The invariant mathematical operations which these symbols represent are given in Table 3.1. They lead directly to Eqs. (3.27). The arrows point in the directions of positive flow or positive potential.

3.5.2 Electrostatic-mechanical transducer

This type of transducer may also be characterized by four terminals. At two of them, voltages and currents can be measured. At the other two, forces and velocities can be measured.

An example is a piezoelectric crystal microphone such as is shown in Fig. 3.36. A force \tilde{f} applied uniformly over the face of the crystal causes an inward displacement of magnitude $\tilde{\xi}$ in meters. As a result of this displacement, a voltage \tilde{e} appears across the electrical terminals 1 and 2. Let us assume that a positive displacement (inward) of the crystal causes terminal 1 to become positive. For small displacements, the induced voltage is proportional to displacement. The inverse of this effect occurs when no external force acts on the crystal face but an electrical generator is connected to the terminals 1 and 2. If the external generator is connected so that terminal 1 is positive, an internal force \tilde{f} is produced which acts to expand the crystal. For small displacements, the developed force \tilde{f} is proportional to the electric charge \tilde{q} stored in the electrodes.

Using the above relationships, we can write

$$\tilde{q} = C_E \tilde{e} - d_{31} \tilde{f} \tag{3.28a}$$

Copyright © 2012, Elsevier Science & Technology. All rights reserved.

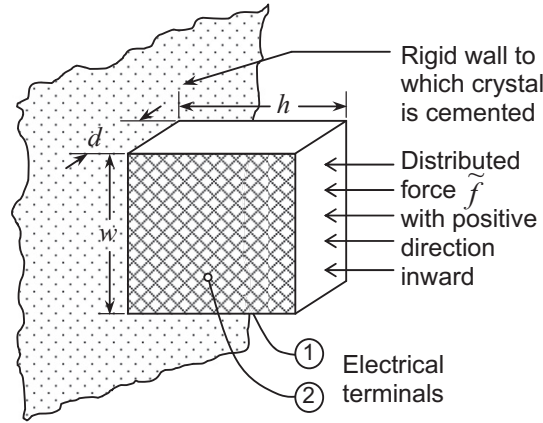

FIG. 3.36 Piezoelectric crystal transducer mounted on a rigid wall.

$$\tilde{\xi} = d_{31}\tilde{e} - C_M\tilde{f} \tag{3.28b}$$

where

\tilde{q} is electrical charge in C stored in the electrodes of the piezoelectric device,
 \tilde{e} is “open-circuit” electrical voltage in V produced by a displacement $\tilde{\xi}$,
 \tilde{f} is “open-circuit” force in N produced by an electrical charge \tilde{q} ,
 $\tilde{\xi}$ is displacement in m of a dimension of the piezoelectric device in m,
 d_{31} is *piezoelectric strain coefficient* with dimensions of C/N or m/V. It is a real number when the network is linear, passive, and reversible. (The subscripts denote the relative directions of the applied field and resulting movement or *vice versa*. In this case, the two are at right-angles. If they were in the same direction, for example, we would use d_{11} , d_{22} , or d_{33} , where 1, 2, and 3 can be regarded as denoting the x , y , or z directions.)

and the electrical capacitance C_E and mechanical compliance C_M are given by

$$C_E = \frac{\epsilon_0\epsilon_rhw}{d} \tag{3.29}$$

$$C_M = \frac{h}{Ydw} \tag{3.30}$$

where

ϵ_0 is permittivity of free space in F/m,
 ϵ_r is relative permittivity of the piezoelectric dielectric (dimensionless),
 Y is Young’s modulus of elasticity in N/m².

In reality, C_E and C_M vary with displacement $\tilde{\xi}$, but it is assumed that the displacement is very small, so these are *linearized* equations. If the material shows no piezoelectric effect, applying an external force

\tilde{f} simply leads to a deflection $\tilde{\xi}$ according to Hooke's law. Due to the piezoelectric effect, the displacement also leads to an induced charge \tilde{q} on the electrodes, which in turn leads to a voltage (electrical force) \tilde{e} . Conversely, applying an electrical voltage leads to a mechanical force. Solving Eqs. (3.28a) and (3.28b) for \tilde{e} and \tilde{f} gives

$$\tilde{e} = \frac{1}{1 - k_{31}^2} \left(\frac{1}{C_E} \tilde{q} - \frac{d_{31}}{C_E C_M} \tilde{\xi} \right) \tag{3.31a}$$

$$\tilde{f} = \frac{1}{1 - k_{31}^2} \left(\frac{d_{31}}{C_E C_M} \tilde{q} - \frac{1}{C_M} \tilde{\xi} \right) \tag{3.31b}$$

where k_{31} is the dimensionless *piezoelectric coupling coefficient* which is related to the piezoelectric strain coefficient d_{31} by

$$k_{31} = \frac{d_{31}}{\sqrt{C_E C_M}} = d_{31} \sqrt{\frac{Y}{\epsilon_0 \epsilon_r}}, \quad 0 < k_{31} < 1 \tag{3.32}$$

Another commonly used parameter is the *piezoelectric stress coefficient* g_{31} in Vm/N or m²/C, which is defined by

$$g_{31} = \frac{d_{31}}{\epsilon_0 \epsilon_r} = \frac{k_{31}}{\sqrt{\epsilon_0 \epsilon_r Y}} \tag{3.33}$$

Equations (3.31) are often inconvenient to use because they contain charge and displacement. One prefers to deal with current and velocity, which appear directly in the equation for power. Conversion to current and velocity may be made by the relations

$$\tilde{u} = \frac{d\xi}{dt} = j\omega \tilde{\xi}, \tag{3.34a}$$

$$\tilde{i} = \frac{dq}{dt} = j\omega \tilde{q}, \tag{3.34b}$$

so that Eqs. (3.31) become, in *z*-parameter matrix form,

$$\begin{bmatrix} \tilde{e} \\ \tilde{f} \end{bmatrix} = \begin{bmatrix} \frac{1}{j\omega C'_E} & \frac{d_{31}}{j\omega C'_E C_M} \\ \frac{d_{31}}{j\omega C'_E C_M} & \frac{1}{j\omega C'_M} \end{bmatrix} \begin{bmatrix} \tilde{i} \\ -\tilde{u} \end{bmatrix}. \tag{3.35}$$

The elements of Eq. (3.35) are related by the equations

$$C'_E = (1 - k_{31}^2) C_E \tag{3.36}$$

$$C'_M = (1 - k_{31}^2)C_M \tag{3.37}$$

Note in particular that

C'_E is electrical capacitance measured with the mechanical “terminals” blocked so that no motion occurs ($\tilde{u} = 0$).

C_E is electrical capacitance measured with the mechanical “terminals” operating into zero mechanical impedance so that no force is built up ($\tilde{f} = 0$).

C'_M is mechanical compliance measured with the electrical terminals open-circuited ($\tilde{i} = 0$).

C_M is mechanical compliance measured with the electrical terminals short-circuited ($\tilde{e} = 0$).

The equivalent circuit shown in Fig. 3.37a is essentially a two-port network defined by the z -parameters in the matrix of Eq. (3.35), although z -parameter matrices will be discussed in greater detail in Sec. 3.10. Noting from Eqs. (3.36) and (3.37) that $C'_E C_M = C_E C'_M$, Eqs. (3.31) can alternatively be written

$$\begin{bmatrix} \tilde{e} \\ \tilde{f} \end{bmatrix} = \begin{bmatrix} \frac{1}{j\omega C'_E} & \frac{d_{31}}{j\omega C_E C'_M} \\ \frac{d_{31}}{j\omega C_E C'_M} & \frac{1}{j\omega C'_M} \end{bmatrix} \begin{bmatrix} \tilde{i} \\ -\tilde{u} \end{bmatrix} \tag{3.38}$$

which is represented by the equivalent circuit shown in Fig. 3.37b. The mechanical sides of Fig. 3.37a and Fig. 3.37b are of the impedance-type analogy. Let us discuss Fig. 3.37a first.

Looking into the electrical terminals 1 and 2, the element C'_E is the electrical capacitance of the transducer. In order to measure C'_E , a sinusoidal driving voltage \tilde{e} is applied to the transducer terminals 1 and 2, and the resulting sinusoidal current is measured. During this measurement, the mechanical terminals 3 and 4 are *open-circuited* (driving force blocked, $\tilde{u} = 0$). A very low driving frequency is used so that the mass reactance and mechanical resistance can be neglected. The negative capacitance $-C'_E$ represents the force of attraction between the electrodes which varies with the displacement.

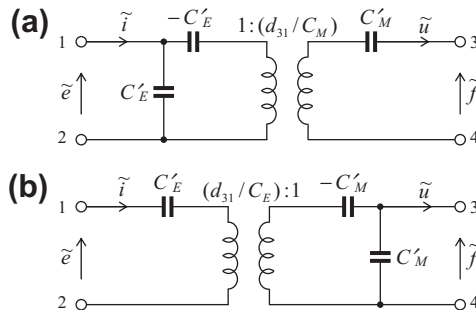

FIG. 3.37 Two forms of analogous symbols for piezoelectric transducers.

The mechanical sides are of the impedance type.

Copyright © 2012, Elsevier Science & Technology. All rights reserved.

Hence, it can be thought of as a negative stiffness which can be subtracted from the natural stiffness of the material.

Looking into the mechanical terminals 3 and 4 of Fig. 3.37b, C'_M is the mechanical compliance of the transducer measured at low frequencies with the electrical terminals 1 and 2 *open-circuited* ($\tilde{i} = 0$). A sinusoidal driving force \tilde{f} is applied to terminals 3 and 4 of the transducer and the resulting sinusoidal displacement is measured. Again, the negative compliance $-C'_M$ is due to the force of attraction between the electrodes. Eliminating \tilde{q} and $\tilde{\xi}$ between Eqs. (3.31) leads to the following simplified equations

$$\tilde{f} = \frac{d_{33}}{C_M} \tilde{e} - \frac{1}{C_M} \tilde{\xi} \tag{3.39a}$$

$$\tilde{e} = \frac{d_{33}}{C_E} \tilde{f} + \frac{1}{C_E} \tilde{q} \tag{3.39b}$$

In the steady state $\tilde{u} = j\omega\tilde{\xi}$ and $\tilde{i} = j\omega\tilde{q}$ so that

$$\tilde{f} = \frac{d_{33}}{C_M} \tilde{e} - \frac{1}{j\omega C_M} \tilde{u} \tag{3.40a}$$

$$\tilde{e} = \frac{d_{33}}{C_E} \tilde{f} + \frac{1}{j\omega C_E} \tilde{i} \tag{3.40b}$$

from which we obtain the two simplified equivalent electrical circuits shown in Fig. 3.38.

Looking into the mechanical terminals 3 and 4 of Fig. 3.38a, the element C_M is the mechanical compliance of the transducer but measured in a different way. A sinusoidal driving force \tilde{f} is applied to terminals 3 and 4 of the transducer at a very low frequency so that the mass reactance and mechanical resistance can be neglected, and the resulting sinusoidal displacement is measured. During this measurement the electrical terminals 1 and 2 are short-circuited ($\tilde{e} = 0$). Looking into the electrical terminals 1 and 2 of Fig. 3.38b, the element C'_E is the electrical

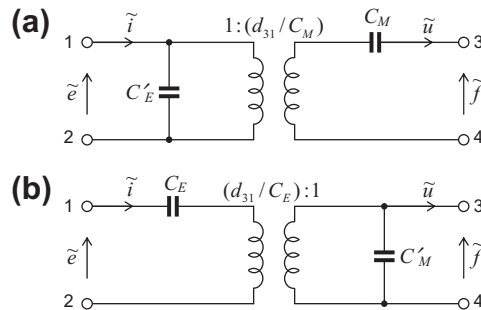

FIG. 3.38 Two simplified forms of analogous symbols for piezoelectric transducers.

The mechanical sides are of the impedance type.

capacitance measured at low frequencies with the mechanical terminals 3 and 4 *short-circuited* ($\tilde{f} = 0$).

A sinusoidal driving voltage e applied to the terminals 1 and 2 of Fig. 3.38a produces an open-circuit force

$$\tilde{f} = \frac{d_{31}}{C_M} \tilde{e}. \quad (3.41)$$

A sinusoidal driving force \tilde{f} applied to the terminals 3 and 4 of Fig. 3.38b produces an open-circuit voltage

$$\tilde{e} = \frac{d_{31}}{C_E} \tilde{f}. \quad (3.42)$$

The choice between the alternative analogous symbols of Fig. 3.38 is usually made on the basis of the use to which the transducer will be put. If the electrostatic transducer is a microphone, it usually is operated into the gate of a field-effect transistor (FET) so that the electrical terminals are essentially open-circuited. In this case the circuit of Fig. 3.38b is the better one to use, because C_E can be neglected in the analysis when $\tilde{i} = 0$. On the other hand, if the transducer is a loudspeaker, it usually is operated from a low-impedance amplifier so that the electrical terminals are essentially short-circuited. In this case the circuit of Fig. 3.38a is the one to use, because $C'_E \omega$ is small in comparison with the output admittance of the amplifier.

The circuit of Fig. 3.38a corresponds more closely to the physical facts than does that of Fig. 3.38b. If the device could be held motionless ($\tilde{u} = 0$) when a voltage was impressed across terminals 1 and 2, there would be no stored mechanical energy. All the stored energy would be electrical. This is the case for circuit (a), but not for (b). In other respects the two circuits are identical.

At higher frequencies, the mass M_M and the resistance R_M of the crystal must be considered in the circuit. These elements can be added in series with terminal 3 of Fig. 3.38.

These analogous symbols indicate an important difference between electromagnetic and electrostatic types of coupling. For the electro-magnetic case, we ordinarily use an admittance-type analogy, but for the electrostatic case we usually employ the impedance-type analogy.

In the next part we shall introduce a different method for handling electrostatic transducers. It involves the use of the admittance-type analog in place of the impedance-type analog. The simplification in analysis that results will be immediately apparent. By this new method it will also be possible to use the impedance-type analog for the electromagnetic case.

3.6 MECHANO-ACOUSTIC TRANSDUCER

This type of transducer occurs at a junction point between the mechanical and acoustical parts of an analogous circuit. An example is the plane at which a loudspeaker diaphragm acts against the air. This transducer may also be characterized by four terminals. At two of the terminals, forces and velocities can be measured. At the other two, pressures and volume velocities can be measured. The basic equations applicable to the mechano-acoustic transducer are:

$$\tilde{f} = S\tilde{p}, \quad (3.43a)$$

$$\tilde{U} = S\tilde{u}, \quad (3.43b)$$

where

- \tilde{f} is force in N,
- \tilde{p} is pressure in Pa,
- \tilde{U} is volume velocity in m^3/s ,
- \tilde{u} is velocity in m/s ,
- S is area in m^2 .

The analogous symbols for this type of transducer are given at the bottom of Table 3.3 (page 70). They are seen to lead directly to Eqs. (3.43).

3.7 EXAMPLES OF TRANSDUCER CALCULATIONS

Example 3.6. An ideal moving-coil loudspeaker produces 2 W of acoustic power into an acoustic load of $4 \times 10^4 \text{ N}\cdot\text{s}/\text{m}^5$ when driven from an amplifier with a constant-voltage output of 1.0 V rms. The area of the diaphragm is 100 cm^2 . What open-circuit voltage will it produce when operated as a microphone with an rms diaphragm velocity of 10 cm/s ?

Solution. From Fig. 3.35 we see that, always,

$$\tilde{e} = Bl\tilde{u}.$$

The power dissipated W gives us the rms volume velocity of the diaphragm U_{rms} :

$$U_{\text{rms}} = \sqrt{\frac{W}{R_A}} = \sqrt{\frac{2}{4 \times 10^4}} = 7.07 \times 10^{-3} \text{ m}^3/\text{s}$$

or

$$u_{\text{rms}} = 0.707 \text{ m/s},$$

$$Bl = \frac{e_{\text{rms}}}{u_{\text{rms}}} = \frac{1}{0.707} = 1.414 \text{ T}$$

Hence, the open-circuit voltage for an rms velocity of 0.1 m/s is

$$e_{\text{rms}} = 1.414 \times 0.1 = 0.1414 \text{ V}.$$

Example 3.7. A lead magnesium niobate-lead titanate (PMN-PT) crystal as shown in Fig. 3.36 with $w = 0.5 \text{ mm}$, $d = 2 \text{ mm}$ $h = 2 \text{ mm}$ has the following mechanical and electrical properties:

$$\begin{aligned} d_{31} &= 750 \times 10^{-12} \text{ C/N, or m/V} \\ Y &= 20 \times 10^9 \text{ N/m}^2 \\ \rho &= 8000 \text{ kg/m}^3 \\ \epsilon_0 &= 8.85 \times 10^{-12} \text{ F/m} \\ \epsilon_r &= 6500 \end{aligned}$$

$$k_{31} = d_{31} \sqrt{\frac{Y}{\epsilon_0 \epsilon_r}} = 0.442$$

This crystal is to be used in a microphone with a circular (weightless) diaphragm. Determine the diameter of the diaphragm if the microphone is to yield an open-circuit voltage of -70 dB re 1 V rms for a sound pressure level of 74 dB re 20 μ Pa at 100 kHz.

Solution. The circuit for this transducer with the transformer removed is shown in Fig. 3.39, where the circuit elements are defined by

$$C'_M = (1 - k_{31}^2) \frac{h}{Ywd} = \frac{1 - 0.442^2}{20 \times 0.5 \times 10^6} = 8 \times 10^{-8} \text{ m/N},$$

$$M_M = \frac{4}{\pi^2} \rho wd h = \frac{4 \times 8 \times 0.5 \times 2 \times 2 \times 10^{-6}}{\pi^2} = 6.5 \times 10^{-6} \text{ kg/m}^3,$$

$$C_E = \frac{\epsilon_0 \epsilon_r wh}{d} = 8.85 \times 10^{-12} \times 6.5 \times 0.5 = 28.8 \times 10^{-12} \text{ F},$$

$R_M =$ negligibly small.

Because only the open-circuit voltage is desired, C_E may be neglected in the calculations. f_{rms} is the total force applied to the crystal by the diaphragm. Solving for e_{rms} yields

$$e_{\text{rms}} = \frac{f_{\text{rms}}(d_{31}/C_E)}{1 - \omega^2 M_M C'_M}.$$

The force f equals the area of the diaphragm S times the sound pressure p . Solving for p ,

$$\begin{aligned} p_{\text{rms}} &= 20 \times 10^{-6} \times 10^{74/20} \\ &= 0.1 \text{ N/m}^2 \end{aligned}$$

Solving for e ,

$$\frac{1}{e_{\text{rms}}} = 10^{70/20} = 3.16 \times 10^3,$$

or

$$e_{\text{rms}} = 3.16 \times 10^{-4} \text{ V}.$$

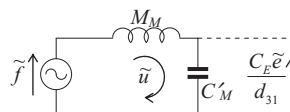

FIG. 3.39 Analogous circuit of the impedance type for a crystal microphone.

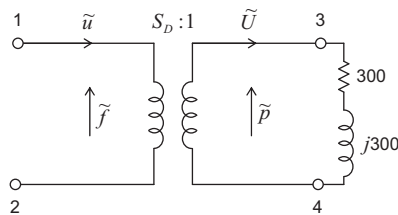

FIG. 3.40 Example of a mechano-acoustic transducer.

The acoustic impedance of a horn (at terminals 3 and 4) loads the diaphragm with a mechanical impedance $S_D^2(300 + j300) \text{ N}\cdot\text{s/m}$.

Hence,

$$\begin{aligned} S &= \frac{f_{\text{rms}}}{p_{\text{rms}}} = \frac{3.16 \times 10^{-4}(1 - 6.28^2 \times 10^{10} \times 6.5 \times 8 \times 10^{-14})}{0.1 \times (750/28.8)} \\ &= 9.65 \times 10^{-5} \text{ m}^2 \\ S &= 0.965 \text{ cm}^2. \end{aligned}$$

This corresponds to a diaphragm with a diameter of about 1.1 cm.

Example 3.8. A loudspeaker diaphragm couples to the throat of an exponential horn that has an acoustic impedance of $300 + j300 \text{ N}\cdot\text{s/m}^5$. If the area of the loudspeaker diaphragm S_D is 0.08 m^2 , determine the mechanical-impedance load on the diaphragm due to the horn.

Solution. The analogous circuit is shown in Fig. 3.40. The mechanical impedance at terminals 1 and 2 represent the load on the diaphragm:

$$\begin{aligned} Z_M &= \frac{\tilde{f}}{\tilde{u}} = S_D^2(300 + j300) \\ &= 6.4 \times 10^{-3}(300 + j300) \\ &= 1.92 + 1.92 \text{ N}\cdot\text{s/m}. \end{aligned}$$

PART IX: CIRCUIT THEOREMS, ENERGY, AND POWER

In this part we discuss conversions from one type of analogy to the other, Thévenin's theorem, energy and power relations, transducer impedances, and combinations of transducers.

3.8 CONVERSION FROM ADMITTANCE-TYPE ANALOGIES TO IMPEDANCE-TYPE ANALOGIES

In the preceding parts we showed that electromagnetic and electrostatic transducers require two different types of analogy if they are to be represented by the networks shown in Table 3.1. A further

need for two types of analogy is apparent from the standpoint of ease of drawing an analogous circuit by inspection. The admittance type of analogy is better for mechanical systems and the impedance type for acoustic systems. The circuits we shall use, however, will frequently contain electrical, mechanical, and acoustical elements. Since analogies cannot be mixed in a given circuit, we must have a simple means for converting from one to the other.

We may readily derive one analogy from the other if we recognize that:

Elements in series in the circuit of one analogy correspond to elements in parallel in the other. Resistance-type elements become conductance-type elements, capacitance-type elements become inductance-type elements, and inductance-type elements become capacitance-type elements.

The sum of the drops across the series elements in a mesh of one analogy corresponds to the sum of the currents at a branch point of the other analogy.

This is equivalent to saying that one analogy is the *dual* of the other. In electrical-circuit theory one learns that the quantities that “flow” in one circuit are the same as the “drops” in the dual of that circuit. This is also true here.

To facilitate the conversion from one type of analogy to another, a method that we shall dub the “dot” method is used. [9] Assume that we have the admittance-type analog of Fig. 3.17 and that we wish to convert it to an impedance-type analog. The procedure is as follows (see Fig. 3.41):

Place a dot at the center of each mesh of the circuit and one dot outside all meshes. Number these dots consecutively.

Connect the dots together with lines so that there is a line through each element and so that no line passes through more than one element.

Draw a new circuit such that each line connecting two dots now contains an element that is the inverse of that in the original circuit. The inverse of any given element may be seen by comparing corresponding columns for admittance-type analogies and impedance-type analogies of Table 3.3. The complete inversion (dual) of Fig. 3.41 is shown in Fig. 3.42.

Solving for the velocities or the forces in the two circuits using the rules of Table 3.1 will readily reveal that they give the same results.

After completing the formation of an analogous circuit, it is always profitable to ask concerning each element, If this element becomes very small or very large, does the circuit behave in the same way the device itself would behave? If the circuit behaves properly in the extremes, it is probably correct.

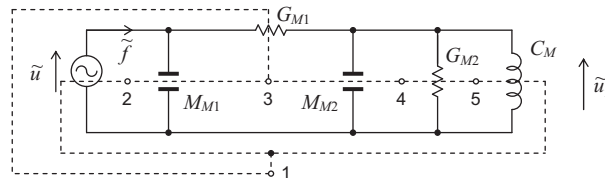

FIG. 3.41 Preparation by the “dot” method for taking the dual of Fig. 3.17.

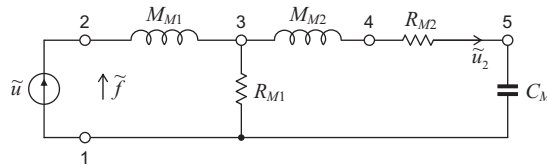

FIG. 3.42 Dual of the circuit of Fig. 3.40.

Solving for the forces or velocities in this circuit using the rules of Table 3.1 yields the same values as solving for the forces or velocities in Fig. 3.41.

3.9 THÉVENIN'S THEOREM

It appears possible, from the foregoing discussions, to represent the operation of a transducer as a combination of electrical, mechanical, and acoustical elements. The connection between the electrical and mechanical circuit takes place through an electromechanical transducer. Similarly, the connection between the mechanical and acoustical circuit takes place through a mechano-acoustic transducer. A Thévenin's theorem may be written for the combined circuits, just as is written for electrical circuits only.

The requirements which must be satisfied in the proper statement and use of Thévenin's theorem are that all the elements be linear and there be no hysteresis effects.

In the next few paragraphs we shall demonstrate the application of Thévenin's theorem to a loudspeaker problem. The mechanical-radiation impedance presented by the air to the vibrating diaphragm of a loudspeaker or microphone will be represented simply as Z_{MR} in the impedance-type analogy or $Y_{MR} = 1/Z_{MR}$ in the admittance-type analogy. The exact physical nature of Z_{MR} will be discussed in Chapters 4, 12, and 13.

Assume a simple electrodynamic (moving-coil) loudspeaker with a diaphragm that has only mass and a voice coil that has only electrical resistance (see Fig. 3.43a). Let this loudspeaker be driven by a constant-voltage generator. By making use of Thévenin's theorem, we wish to find the equivalent mechanical generator \tilde{u}_0 and the equivalent mechanical admittance Y_{MS} of the loudspeaker, as seen in the interface between the diaphragm and the air. The circuit of Fig. 3.43a with the transformer removed is shown in Fig. 3.43b. The Thévenin's equivalent circuit is shown in Fig. 3.43c.

We arrive at the values of \tilde{u}_0 and Y_{MS} in two steps.

Step 1. Determine the open-circuit velocity \tilde{u}_0 by terminating the loudspeaker in an infinite admittance, $Y_{MA} = \infty$ (that is, $Z_{MA} = 0$) and then measuring the velocity of the diaphragm \tilde{u}_0 . As we discussed in Part II, $Z_{MA} = 0$ can be obtained by acoustically connecting the diaphragm to a tube whose length is equal to one-fourth wavelength. This is possible at low frequencies. Inspection of Fig. 3.43b shows that

$$\tilde{u}_0 = \frac{\tilde{e}Bl}{j\omega M_{MD}R_E + (Bl)^2}. \quad (3.44)$$

Step 2. Short-circuit the generator e without changing the mesh impedance in that part of the electrical circuit. Then determine the admittance Y_{MS} looking back into the output terminals of the

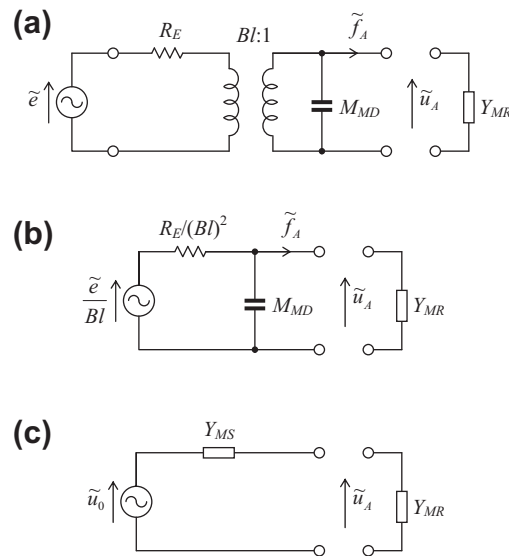

FIG. 3.43 Analogous circuits for a simplified moving-coil loudspeaker radiating sound into air.

(a) Analogous circuit. (b) Same with transformer removed. (c) Same, reduced to its Thévenin's equivalent.

loudspeaker. For example, Y_{MS} for the circuit of Fig. 3.43b is equal to the parallel combination of $1/j\omega M_{MD}$ and $R_E/(Bl)^2$, that is,

$$Y_{MS} = \frac{R_E}{j\omega M_{MD}R_E + (Bl)^2}. \quad (3.45)$$

The Thévenin's equivalent circuit for the loudspeaker (looking into the diaphragm) is shown schematically in Fig. 3.43c, where \tilde{u}_0 and the admittance Y_{MS} are given by Eqs. (3.44) and (3.45), respectively.

The application of Thévenin's theorem as discussed above is an example of how general theorems originally applying to linear passive electrical networks can be applied to great advantage to the analogs of mechanical and acoustic systems, including transducers.

3.10 TRANSDUCER IMPEDANCES

Let us look a little closer at the impedances at the terminals of electromechanical transducers. It has become popular over the years for electrical-circuit specialists to express the equations for their circuits in matrix form. The matrix notation is a condensed manner of writing systems of linear equations. [10,11] We shall express the properties of transducers in matrix form for those who are familiar with this concept. An explanation of the various mathematical operations to be performed

with matrices is beyond the scope of this book. The student not familiar with matrix theory is advised to deal directly with the simultaneous equations from which the matrix is derived. A knowledge of matrix theory is not necessary, however, for an understanding of any material in this text.

Transmission matrix for an electrical 2-port network. As we shall see, transmission matrices are particularly useful because an overall transmission matrix \mathbf{M} can be easily obtained by multiplying together the individual transmission matrices for each circuit element. The general 2-port network shown in Fig. 3.44 can be represented by the following matrix equation:

$$\begin{bmatrix} \tilde{e}_{in} \\ \tilde{i}_{in} \end{bmatrix} = \mathbf{A} \cdot \begin{bmatrix} \tilde{e}_{out} \\ \tilde{i}_{out} \end{bmatrix} = \begin{bmatrix} a_{11} & a_{12} \\ a_{21} & a_{22} \end{bmatrix} \cdot \begin{bmatrix} \tilde{e}_{out} \\ \tilde{i}_{out} \end{bmatrix}, \quad (3.46)$$

where the transmission-parameters are given by

$$a_{11} = \left. \frac{\tilde{e}_{in}}{\tilde{e}_{out}} \right|_{\tilde{i}_{out} = 0}, \quad (3.47)$$

$$a_{12} = \left. \frac{\tilde{e}_{in}}{\tilde{i}_{out}} \right|_{\tilde{e}_{out} = 0}, \quad (3.48)$$

$$a_{21} = \left. \frac{\tilde{i}_{in}}{\tilde{e}_{out}} \right|_{\tilde{i}_{out} = 0}, \quad (3.49)$$

$$a_{22} = \left. \frac{\tilde{i}_{in}}{\tilde{i}_{out}} \right|_{\tilde{e}_{out} = 0}, \quad (3.50)$$

In other words:

a_{11} is ratio of applied input voltage to output voltage measured with the output terminals *open-circuited*.

a_{12} is ratio of applied input voltage to output current measured with the output terminals *short-circuited*.

a_{21} is ratio of applied input current to output voltage measured with the output terminals *open-circuited*.

a_{22} is ratio of applied input current to output current measured with the output terminals *short-circuited*.

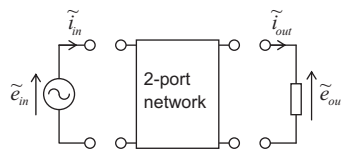

FIG. 3.44 Electrical 2-port network.

Transmission matrix for an electromagnetic-mechanical transducer. Let us determine the transmission matrix for the electromagnetic-mechanical transducer of Fig. 3.45. In that circuit Z_E is the electrical impedance measured with the mechanical terminals “blocked,” that is, $\tilde{u} = 0$; Z_M is the mechanical impedance of the mechanical elements in the transducer measured with the electrical circuit “open-circuited”; and Z_L is the mechanical impedance of the acoustic load on the diaphragm. The quantity Bl is the product of the flux density times the effective length of the wire cutting the lines of force perpendicularly. The individual transmission matrices for each element can be written from inspection

$$\begin{bmatrix} \tilde{e}_0 \\ \tilde{i}_0 \end{bmatrix} = \begin{bmatrix} 1 & Z_E \\ 0 & 1 \end{bmatrix} \cdot \begin{bmatrix} \tilde{e}_1 \\ \tilde{i}_1 \end{bmatrix} = \mathbf{M}_0 \cdot \begin{bmatrix} \tilde{e}_1 \\ \tilde{i}_1 \end{bmatrix}, \tag{3.51}$$

$$\begin{bmatrix} \tilde{e}_1 \\ \tilde{i}_1 \end{bmatrix} = \begin{bmatrix} 0 & Bl \\ 1/Bl & 0 \end{bmatrix} \cdot \begin{bmatrix} \tilde{f} \\ \tilde{u} \end{bmatrix} = \mathbf{M}_1 \cdot \begin{bmatrix} \tilde{f} \\ \tilde{u} \end{bmatrix}, \tag{3.52}$$

$$\begin{bmatrix} \tilde{f} \\ \tilde{u} \end{bmatrix} = \begin{bmatrix} 1 & Z_M \\ 0 & 1 \end{bmatrix} \cdot \begin{bmatrix} \tilde{f}_L \\ \tilde{u}_L \end{bmatrix} = \mathbf{M}_2 \cdot \begin{bmatrix} \tilde{f}_L \\ \tilde{u}_L \end{bmatrix}, \tag{3.53}$$

$$\begin{bmatrix} \tilde{f}_L \\ \tilde{u}_L \end{bmatrix} = \begin{bmatrix} 1 & 0 \\ 1/Z_L & 1 \end{bmatrix} \cdot \begin{bmatrix} \tilde{f}_0 \\ \tilde{u}_0 \end{bmatrix} = \mathbf{M}_3 \cdot \begin{bmatrix} \tilde{f}_0 \\ \tilde{u}_0 \end{bmatrix}. \tag{3.54}$$

The overall transmission matrix is then obtained as follows

$$\begin{aligned} \mathbf{M} &= \mathbf{M}_0 \cdot \mathbf{M}_1 \cdot \mathbf{M}_2 \cdot \mathbf{M}_3 \\ &= \begin{bmatrix} 1 & Z_E \\ 0 & 1 \end{bmatrix} \cdot \begin{bmatrix} 0 & Bl \\ 1/Bl & 0 \end{bmatrix} \cdot \begin{bmatrix} 1 & Z_M \\ 0 & 1 \end{bmatrix} \cdot \begin{bmatrix} 1 & 0 \\ 1/Z_L & 1 \end{bmatrix} \\ &= \begin{bmatrix} A_{11} & A_{12} \\ A_{21} & A_{22} \end{bmatrix}, \end{aligned} \tag{3.55}$$

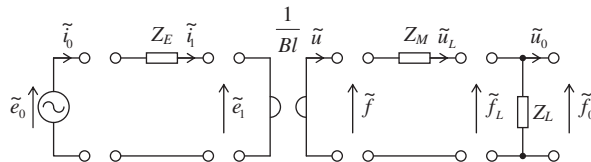

FIG. 3.45 Analogous circuit for an electromagnetic-mechanical transducer.

The mechanical side is of the impedance type.

Copyright © 2012, Elsevier Science & Technology. All rights reserved.

where

$$A_{11} = \frac{Bl}{Z_L} + \frac{Z_E}{Bl} \left(1 + \frac{Z_M}{Z_L}\right), \quad (3.56)$$

$$A_{12} = Bl + \frac{Z_E Z_M}{Bl}, \quad (3.57)$$

$$A_{21} = \frac{1}{Bl} \left(1 + \frac{Z_M}{Z_L}\right), \quad (3.58)$$

$$A_{22} = \frac{Z_M}{Bl}. \quad (3.59)$$

We see from Fig. 3.45 that $\tilde{u}_0 = 0$ so that

$$\begin{bmatrix} \tilde{e}_0 \\ \tilde{i}_0 \end{bmatrix} = \begin{bmatrix} A_{11} & A_{12} \\ A_{21} & A_{22} \end{bmatrix} \cdot \begin{bmatrix} \tilde{f}_0 \\ 0 \end{bmatrix} \quad (3.60)$$

From this matrix, we can gather everything we need to know about the transducer. For example, the parameters at the interfaces between the circuit elements (voltages, currents, forces and velocities, etc.) can be obtained through a combination of the overall transmission matrix and elemental matrices. Straight away we obtain the force exerted upon the load

$$\tilde{f}_L = \tilde{f}_0 = \frac{\tilde{e}_0}{A_{11}} = \frac{Z_L Bl \tilde{e}_0}{Z_E(Z_M + Z_L) + (Bl)^2} \quad (3.61)$$

and hence also the load velocity

$$\tilde{u}_L = \frac{\tilde{e}_0}{A_{11} Z_L} = \frac{Bl \tilde{e}_0}{Z_E(Z_M + Z_L) + (Bl)^2} \quad (3.62)$$

The latter is important for evaluating the radiated sound pressure, as will be explained in Chapters 4, 12, and 13. The total electrical impedance Z_{ET} as viewed from the voltage generator is found to be

$$Z_{ET} = \frac{\tilde{e}_0}{\tilde{i}_0} = \frac{A_{11} \tilde{f}_0}{A_{21} \tilde{f}_0} = Z_E + \frac{(Bl)^2}{Z_M + Z_L} \quad (3.63)$$

The second term on the right-hand side is usually called the *motional impedance* because, if the mechanical side is blocked so there is no movement (that is, $Z_L \rightarrow \infty$), then $Z_{ET} = Z_E$, which is the *static impedance*. This equation illustrates a striking fact, viz., that the electromagnetic transducer is an *impedance inverter*. By an inverter we mean that a mass reactance on the mechanical side becomes a capacitance reactance when referred to the electrical side of the transformer, and vice versa. Similarly, an inductance on the electrical side reflects through the transformer as a mechanical compliance.

Impedance matrix for an electromagnetic-mechanical transducer. Refer to Fig. 3.44. Another type of matrix in common usage is the impedance matrix based upon z -parameters:

$$\begin{bmatrix} \tilde{e}_{in} \\ \tilde{e}_{out} \end{bmatrix} = \mathbf{Z} \cdot \begin{bmatrix} \tilde{i}_{in} \\ -\tilde{i}_{out} \end{bmatrix} = \begin{bmatrix} z_{11} & z_{12} \\ z_{21} & z_{22} \end{bmatrix} \cdot \begin{bmatrix} \tilde{i}_{in} \\ -\tilde{i}_{out} \end{bmatrix}, \quad (3.64)$$

where the z -parameters are given by

$$z_{11} = \left. \frac{\tilde{e}_{in}}{\tilde{i}_{in}} \right|_{\tilde{i}_{out} = 0}, \quad (3.65)$$

$$z_{12} = \left. \frac{\tilde{e}_{in}}{-\tilde{i}_{out}} \right|_{\tilde{i}_{in} = 0}, \quad (3.66)$$

$$z_{21} = \left. \frac{\tilde{e}_{out}}{\tilde{i}_{in}} \right|_{\tilde{i}_{out} = 0}, \quad (3.67)$$

$$z_{22} = \left. \frac{\tilde{e}_{out}}{-\tilde{i}_{out}} \right|_{\tilde{i}_{in} = 0} \quad (3.68)$$

In other words:

z_{11} is ratio of input voltage to applied input current measured with the output terminals *open-circuited*.

z_{12} is ratio of input voltage to applied output current measured with the input terminals *open-circuited*.

z_{21} is ratio of output voltage to applied input current measured with the output terminals *open-circuited*.

z_{22} is ratio of output voltage to applied output current measured with the input terminals *open-circuited*.

Comparing Eq. (3.64) with Eq. (3.46), we can solve for the following transmission-parameter to z -parameter transformation equations

$$z_{11} = a_{11}/a_{21}, \quad (3.69)$$

$$z_{12} = \det(\mathbf{A})/a_{21}, \quad (3.70)$$

$$z_{21} = 1/a_{21}, \quad (3.71)$$

$$z_{22} = a_{22}/a_{21}, \quad (3.72)$$

where

$$\det(\mathbf{A}) = a_{11}a_{22} - a_{12}a_{21}. \quad (3.73)$$

Many passive networks, especially ones in which no energy is created or lost, have a determinant whose magnitude is unity, in which case the z -parameter matrix is symmetrical about the diagonal. That is, $z_{12} = z_{21}$. However, we shall see that in the case of an electromagnetic-mechanical transducer, it turns out to be skew-symmetrical, that is with $z_{12} = -z_{21}$, because $\det(\mathbf{A}) = -1$, which in turn is due to the fact that the current flow in a wire resulting from movement through a magnetic field is in the opposite direction to that producing the same movement (Fleming's generator rule versus motor rule). The reverse transformation equations are of the same form:

$$a_{11} = z_{11}/z_{21}, \quad (3.74)$$

$$a_{12} = \det(\mathbf{Z})/z_{21}, \quad (3.75)$$

$$a_{21} = 1/z_{21}, \quad (3.76)$$

$$a_{22} = z_{22}/z_{21}, \quad (3.77)$$

where

$$\det(\mathbf{Z}) = z_{11}z_{22} - z_{12}z_{21}. \quad (3.78)$$

Applying the transformations of Eqs. (3.69) to (3.72) to the transmission-parameters of Eqs. (3.56) to (3.59), while noting that in this instance $\tilde{u}_0 = 0$ and $\tilde{f}_0 = \tilde{f}_L$, yields the following z -parameter impedance matrix:

$$\begin{bmatrix} \tilde{e}_0 \\ \tilde{f}_L \end{bmatrix} = \begin{bmatrix} Z_E + \frac{(Bl)^2}{Z_M + Z_L} & \frac{-BlZ_L}{Z_M + Z_L} \\ \frac{BlZ_L}{Z_M + Z_L} & \frac{Z_M Z_L}{Z_M + Z_L} \end{bmatrix} \cdot \begin{bmatrix} \tilde{i}_0 \\ 0 \end{bmatrix}, \quad (3.79)$$

Not surprisingly, $z_{11} = Z_{ET}$ as given by Eq. (3.63). If we remove the load impedance by letting $Z_L \rightarrow \infty$, we obtain the following simple z -parameter impedance matrix for just the transducer without any external load:

$$\begin{bmatrix} \tilde{e}_0 \\ \tilde{f}_L \end{bmatrix} = \begin{bmatrix} Z_E & -Bl \\ Bl & Z_M \end{bmatrix} \cdot \begin{bmatrix} \tilde{i}_0 \\ -\tilde{u}_L \end{bmatrix} \quad (3.80)$$

Transmission matrix for an electrostatic-mechanical transducer. For the electrostatic-mechanical transducer of the type shown in Fig. 3.46: Z_E = the electrical impedance with the mechanical motion free ($\tilde{f} = 0$),

$$Z'_E \equiv Z_E + \frac{1}{j\omega C'_E}$$

is the electrical impedance with the mechanical motion blocked ($\tilde{u} = 0$).
 Z_L is the mechanical impedance of the acoustical load on the diaphragm.

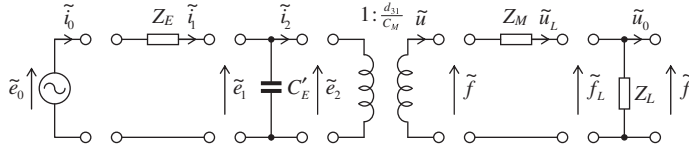

FIG. 3.46 Analogous circuit for an electrostatic-mechanical transducer.

The mechanical side is of the impedance type.

$$Z_M \equiv R_M + j\omega M_M + \frac{1}{j\omega C_M}$$

is the mechanical impedance of the mechanical elements in the transducer measured with the electrical terminals short-circuited ($\tilde{e}_1 = 0$). Z_M' is the mechanical impedance of the mechanical elements measured with the electrical terminals open-circuit ($\tilde{i}_1 = 0$). It is defined by the same expression as that for Z_M above except that C_M is replaced by

$$C'_M = \left(1 - \frac{d_{31}^2}{C_E C_M}\right) C_M$$

which is the mechanical compliance in the transducer with $\tilde{i}_1 = 0$.

The individual transmission matrices for each element can be written from inspection:

$$\begin{bmatrix} \tilde{e}_0 \\ \tilde{i}_0 \end{bmatrix} = \begin{bmatrix} 1 & Z_E \\ 0 & 1 \end{bmatrix} \cdot \begin{bmatrix} \tilde{e}_1 \\ \tilde{i}_1 \end{bmatrix} = \mathbf{M}_0 \cdot \begin{bmatrix} \tilde{e}_1 \\ \tilde{i}_1 \end{bmatrix}, \tag{3.81}$$

$$\begin{bmatrix} \tilde{e}_1 \\ \tilde{i}_1 \end{bmatrix} = \begin{bmatrix} 1 & 0 \\ j\omega C'_E & 1 \end{bmatrix} \cdot \begin{bmatrix} \tilde{e}_2 \\ \tilde{i}_2 \end{bmatrix} = \mathbf{M}_1 \cdot \begin{bmatrix} \tilde{e}_2 \\ \tilde{i}_2 \end{bmatrix}, \tag{3.82}$$

$$\begin{bmatrix} \tilde{e}_2 \\ \tilde{i}_2 \end{bmatrix} = \begin{bmatrix} C_M/d_{31} & 0 \\ 0 & d_{31}/C_M \end{bmatrix} \cdot \begin{bmatrix} \tilde{f} \\ \tilde{u} \end{bmatrix} = \mathbf{M}_2 \cdot \begin{bmatrix} \tilde{f} \\ \tilde{u} \end{bmatrix}, \tag{3.83}$$

$$\begin{bmatrix} \tilde{f} \\ \tilde{u} \end{bmatrix} = \begin{bmatrix} 1 & Z_M \\ 0 & 1 \end{bmatrix} \cdot \begin{bmatrix} \tilde{f}_L \\ \tilde{u}_L \end{bmatrix} = \mathbf{M}_3 \cdot \begin{bmatrix} \tilde{f}_L \\ \tilde{u}_L \end{bmatrix}, \tag{3.84}$$

$$\begin{bmatrix} \tilde{f}_L \\ \tilde{u}_L \end{bmatrix} = \begin{bmatrix} 1 & 0 \\ 1/Z_L & 1 \end{bmatrix} \cdot \begin{bmatrix} \tilde{f}_0 \\ \tilde{u}_0 \end{bmatrix} = \mathbf{M}_4 \cdot \begin{bmatrix} \tilde{f}_0 \\ \tilde{u}_0 \end{bmatrix}. \tag{3.85}$$

Copyright © 2012, Elsevier Science & Technology. All rights reserved.

Using the relationship $C'_E C_M = C_E C'_M$ from Eqs. (3.36) and (3.37), the overall transmission matrix is then obtained as follows:

$$\begin{aligned}
 \mathbf{M} &= \mathbf{M}_0 \cdot \mathbf{M}_1 \cdot \mathbf{M}_2 \cdot \mathbf{M}_3 \cdot \mathbf{M}_4 \\
 &= \begin{bmatrix} 1 & Z_E \\ 0 & 1 \end{bmatrix} \cdot \begin{bmatrix} 1 & 0 \\ j\omega C'_E & 1 \end{bmatrix} \cdot \begin{bmatrix} C_M/d_{31} & 0 \\ 0 & d_{31}/C_M \end{bmatrix} \cdot \begin{bmatrix} 1 & Z_M \\ 0 & 1 \end{bmatrix} \cdot \begin{bmatrix} 1 & 0 \\ 1/Z_L & 1 \end{bmatrix} \\
 &= \begin{bmatrix} A_{11} & A_{12} \\ A_{21} & A_{22} \end{bmatrix},
 \end{aligned} \tag{3.86}$$

where

$$A_{11} = \frac{j\omega C'_E C_M}{d_{31}} \left(1 + \frac{Z'_M}{Z_L} \right) \left(Z'_E + \frac{d_{31}^2}{\omega^2 C_E'^2 C_M^2 (Z'_M + Z_L)} \right), \tag{3.87}$$

$$A_{12} = \frac{j\omega C'_E C_M}{d_{31}} Z'_M \left(Z'_E + \frac{d_{31}^2}{\omega^2 C_E'^2 C_M^2 Z'_M} \right), \tag{3.88}$$

$$A_{21} = \frac{j\omega C'_E C_M}{d_{31}} \left(1 + \frac{Z'_M}{Z_L} \right), \tag{3.89}$$

$$A_{22} = \frac{j\omega C'_E C_M}{d_{31}} Z'_M. \tag{3.90}$$

Impedance matrix for an electrostatic-mechanical transducer. Applying the transformations of Eqs. (3.69) to (3.72) to the transmission-parameters of Eqs. (3.87) to (3.90), while noting that in this instance $\tilde{u}_0 = 0$ and $\tilde{f}_0 = \tilde{f}_L$, yields the following z -parameter impedance matrix:

$$\begin{bmatrix} \tilde{e}_0 \\ \tilde{f}_L \end{bmatrix} = \begin{bmatrix} Z'_E + \left(\frac{d_{31}}{\omega C'_E C_M} \right)^2 \frac{1}{Z'_M + Z_L} & \frac{d_{31}}{j\omega C'_E C_M} \frac{Z_L}{Z'_M + Z_L} \\ \frac{d_{31}}{j\omega C'_E C_M} \frac{Z_L}{Z'_M + Z_L} & \frac{Z'_M Z_L}{Z'_M + Z_L} \end{bmatrix} \cdot \begin{bmatrix} \tilde{i}_0 \\ 0 \end{bmatrix}, \tag{3.91}$$

If we remove the load impedance by letting $Z_L \rightarrow \infty$, we obtain the following simple z -parameter impedance matrix for just the transducer without any external load:

$$\begin{bmatrix} \tilde{e}_0 \\ \tilde{f}_L \end{bmatrix} = \begin{bmatrix} Z'_E & \frac{d_{31}}{j\omega C'_E C_M} \\ \frac{d_{31}}{j\omega C'_E C_M} & Z'_M \end{bmatrix} \cdot \begin{bmatrix} \tilde{i}_0 \\ -\tilde{u}_L \end{bmatrix}. \tag{3.92}$$

This matrix is symmetrical about the main diagonal, as for any ordinary electrical passive network. By contrast matrix (3.80) is skew-symmetrical because the off-diagonal elements have opposite signs. For transient problems, replace $j\omega$ by the operator $s = d/dt$ [9].

The impedance matrix for the electrostatic transducer is almost identical in form to that for the electromagnetic transducer, the difference being that the mutual terms have the same sign, as contrasted to opposite signs for the electromagnetic case. This means that whereas electrostatic transducers are *reciprocal*, electromagnetic transducers are *anti-reciprocal*. For the electrostatic transducer the total impedance is given from Eq. (3.91) as

$$Z_{ET} = z_{11} = Z'_E + \left(\frac{d_{31}}{\omega C'_E C_M} \right)^2 \frac{1}{Z'_M + Z_L}. \quad (3.93)$$

The first and second terms on the right-hand side are called the static and motional impedances respectively as before.

Again we see that the transducer acts as a sort of *impedance inverter*. An added positive mechanical reactance ($+X_M$) comes through the transducer as a negative electrical reactance.

Some interesting facts can be illustrated by assuming that we have an electrostatic and an electromagnetic transducer, each stiffness controlled on the mechanical side so that

$$Z_M + Z_L = \frac{1}{j\omega C_{M1}}. \quad (3.94)$$

Substitution of Eq. (3.94) into (3.63) yields

$$Z_{ET} = Z_E + j\omega(B^2 l^2 C_{M1}). \quad (3.95)$$

The mechanical compliance C_M appears from the electrical side to be an inductance with a magnitude $B^2 l^2 C_{M1}$. We now substitute Eq. (3.94) into (3.93) to obtain

$$Z_{ET} = z_{11} = Z'_E + j \left(\frac{d_{31}}{C'_E C_M} \right)^2 \frac{C'_{M1}}{\omega}. \quad (3.96)$$

The mechanical compliance C'_M of this transducer appears from the electrical side to be a negative capacitance (see Fig. 3.37b), that is to say, C'_{M1} appears to be an inductance with a magnitude that varies inversely with ω^2 . The effect of this is simply to reduce the value of C'_M . Another way of looking at this is to note from Fig. 3.46 that with $R_M = M_M = 0$ and $Z_L = 1/j\omega C'_{ML}$, the total compliance is less than C'_M because of the added compliance C'_{ML} .

Example 3.9. A moving-coil earphone which is driven at frequencies above its first resonance frequency, may be represented by the circuit of Fig. 3.43a. Its mechanical and electrical characteristics are:

$$\begin{aligned} R_E &= 8 \Omega \\ B &= 1 \text{ T } (10^4 \text{ gauss}) \\ l &= \frac{3}{4} \text{ m} \\ M_{MD} &= 60 \text{ mg} \\ Y_{MR} &= j\omega 2.7 \times 10^{-3} \text{ m} \cdot \text{N}^{-1} \cdot \text{s}^{-1} \end{aligned}$$

where Y_{MR} is the admittance that the diaphragm sees when the earphone is on the ear (due to the stiffness of the air trapped in the ear cavity), M_{MD} is the mass of the diaphragm, R_E and l are the resistance and the length of wire wound on the voice coil, and B is the flux density cut by the moving coil. Determine the sound pressure level produced at the ear at 1000 Hz when the earphone is operated

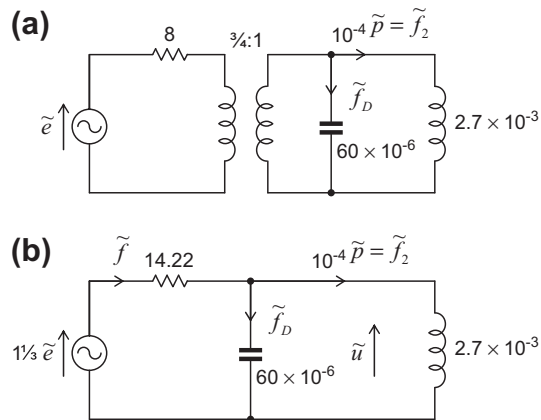

FIG. 3.47 Analogous circuits for Example 3.9.

from a very low impedance amplifier with an output voltage of $e_{\text{rms}} = 1$ V. Assume that the area of the diaphragm is 1 cm^2 .

Solution. The circuit diagram for the earphone with the element sizes given in SI units is shown in Fig. 3.47a. Eliminating the transformer gives the circuit of Fig. 3.47b. Solving, we get

$$\begin{aligned}\tilde{u} &= \tilde{f}_2 Y_{MR} = (10^{-4} \tilde{p}) j6280(2.7 \times 10^{-3}) \\ &= (j1.7 \times 10^{-3}) \tilde{p}, \\ \tilde{f}_D &= j\omega M_{MD} \tilde{u} = (-6.4 \times 10^{-4}) \tilde{p}, \\ \tilde{f} &= \tilde{f}_D + \tilde{f}_2 = (-5.4 \times 10^{-4}) \tilde{p}, \\ \frac{1}{3} \tilde{e} &= \tilde{u} + 14.22 \tilde{f} = (j1.7 \times 10^{-3} - 7.67 \times 10^{-3}) \tilde{p},\end{aligned}$$

$$|p_{\text{rms}}| = \frac{1.33 \times 10^3}{\sqrt{1.7^2 + 7.67^2}} \approx 170 \text{ Pa},$$

$$\text{SPL} = 20 \log \frac{170}{2 \times 10^{-5}} = 138.6 \text{ dB re } 20 \mu\text{Pa}.$$

Example 3.10. Two transducers, one a piezoelectric crystal and the other a moving coil in a magnetic field, are connected to a mass M_{M2} of 6.27 g as shown in Fig. 3.48a. Determine the total stored mechanical energy in the masses M_{M1} and M_{M2} at 10 kHz for the following constants:

$$\begin{aligned}e_{\text{rms}} &= 1 \text{ V} \\ R_E &= 10 \Omega \\ B &= 1 \text{ T} \\ l &= 20 \text{ m} \\ C_E &= 1.3 \times 10^{-9} \text{ F} \\ M_{M1} &= 6.4 \times 10^{-3} \text{ kg} \\ M_{M2} &= 6.27 \times 10^{-3} \text{ kg} \\ C_M &= 2 \times 10^{-8} \text{ m/N}\end{aligned}$$

$$d_{33} = 10^{-9} \text{ C/N}$$

$$\omega = 62800 \text{ rad/s}$$

Solution. The transducers are shown schematically in (b) of Fig. 3.48. A further simplification of this diagram is shown in (c). Let us determine the value of Z_M first.

$$Z_{M1} = j\omega(M_{M1} + M_{M2}) - j\frac{1}{C_M\omega}$$

$$= j(402 + 394) - j796 = 0.$$

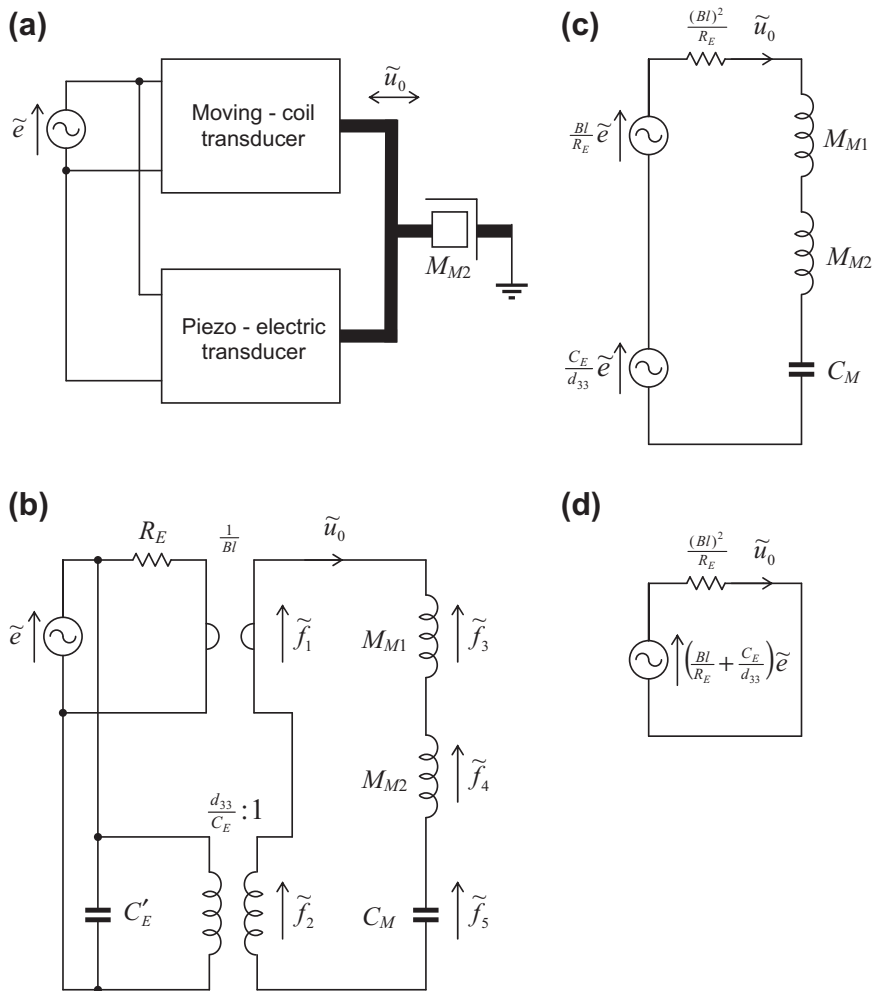

FIG. 3.48 Combined electrostatic-electromagnetic transducers.

- (a) Block mechanical diagram of the device. (b) Analogous circuit with impedances on mechanical side. (c) Same as (b), except that the electrical elements are referred to the mechanical side. (d) Because the mechanical part of circuit (c) has zero impedance, (c) simplifies to this form.

Copyright © 2012, Elsevier Science & Technology. All rights reserved.

In other words, the impedance is zero at 10 kHz. Hence, circuit (c) simplifies to that shown in (d). Then the velocity \tilde{u}_0 of the two masses M_{M1} and M_{M2} is

$$\begin{aligned}\tilde{u}_0 &= \left(\frac{Bl}{R_E} + \frac{C_E}{d_{33}} \right) \frac{R_E}{(Bl)^2} \tilde{e} \\ &= \left(\frac{1}{Bl} + \frac{R_E C_E}{(Bl)^2 d_{33}} \right) \tilde{e} \\ &= \left(\frac{1}{20} + \frac{10 \times 1.3}{20^2} \right) \tilde{e} = (82.5 \times 10^{-3}) \tilde{e}\end{aligned}$$

so that $u_{0rms} = 82.5 \times 10^{-3}$ m/s. The total mechanical stored energy in the two masses M_{M1} and M_{M2} is

$$\frac{1}{2}(M_{M1} + M_{M2})u_{0rms}^2 = 0.5 \times (6.4 + 6.27) \times 82.5^2 \times 10^{-9} = 4.31 \times 10^{-5} \text{ W}\cdot\text{s}.$$

Notes

- [1] The London Underground map was designed by Harry Beck and introduced in 1933. He received only 5 guineas for his efforts.
- [2] B. Gehlshoj, *Electromechanical and Electroacoustical Analogies* (Academy of Technical Sciences, Copenhagen, 1947).
- [3] Firestone FA. A New Analogy between Mechanical and Electrical Systems. *J Acoust Soc Am* 1933;4:249–67. The Mobility Method of Computing the Vibrations of Linear Mechanical and Acoustical Systems: Mechanical-electrical Analogies. *J Appl Phys* 1938;9:373–478.
- [4] Olson HF. *Dynamical Analogies*. New York: D. Van Nostrand Company, Inc.; 1943.
- [5] Mason WP. Electrical and Mechanical Analogies. *Bell System Tech J* 1941;20:405–14.
- [6] Bloch A. Electro-mechanical Analogies and Their Use for the Analysis of Mechanical and Electro-mechanical Systems. *J Inst Elec Eng* 1945;92:157–69.
- [7] Among the four circuit elements, the first three are two-poles. This list is exhaustive. The transformation element is a four-pole. There are other lossless four-poles which one might have chosen in addition, e.g., the ideal gyrator.
- [8] An exception to this rule may occur when the mechanical device embodies one or more floating levers, as we just learned.
- [9] Gardner MF, Barnes JL. *Transients in Linear Systems*. New York: John Wiley & Sons, Inc.; 1942. p. 46–49.
- [10] Jeffrey A. *Mathematics for Engineers and Scientists*. 6th ed. London: Chapman & Hall; 2005. p. 463–548.
- [11] Attia JO. *Electronics and Circuit Analysis using MATLAB*. 2nd ed. Boca Raton, Florida: CRC; 2004. p. 151–181.