



## CONVERSION



### I. CUTTING and CREASING

Cutting on a platen.... A technique of high quality and profitability

### II. ASSEMBLY

1. Assembly techniques
2. Gluing

“

The conversion of Priplak® gives it a predefined shape and volume. This last stage of designing a finished product means that ideas can be tailored to individual requirements.

”

## I. CUTTING-CREASING

### CUTTING ON A PLATEN.... A TECHNIQUE OF A HIGH QUALITY AND PROFITABILITY

"Cold" cutting and creasing in one operation gives a number of advantages :

- it is the most effective process for Priplak® conversion,
- it permits cutting out complicated shapes with a speed of 1200 sheets per hour on a manual platen and up to 5000 sheets per hour on an automatic platen,
- Priplak® can be cut and creased on machines commonly used for cartonboard and other substrates, thereby increasing production flexibility.
- all the accessories on the finished product are pre-positioned, avoiding any error during the production process.

Simplicity, reliability and profitability are the greatest advantages of this process. It permits precise results during production.

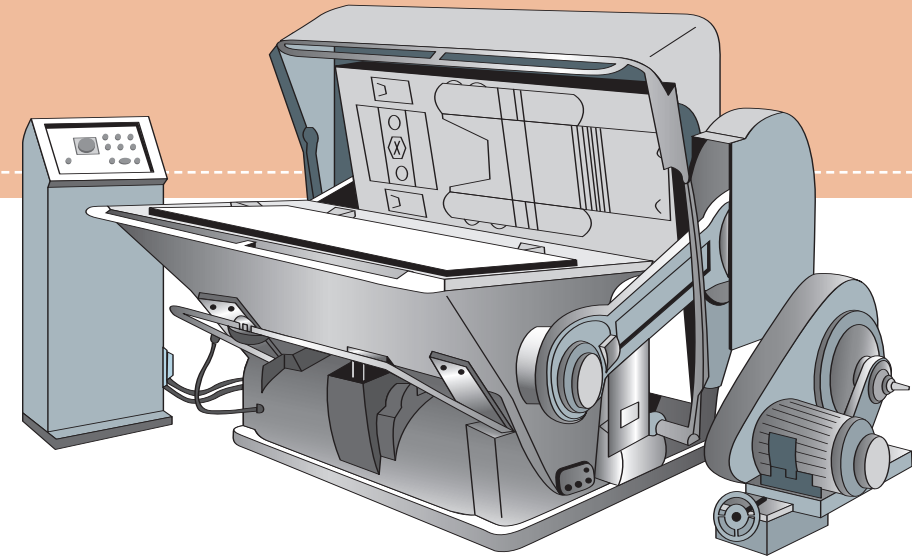

#### ••• Maximum resistance

Creasing crushes and lengthens Priplak® sheets without reducing its strength. Unlike carton board, Priplak® molecules lie on the creased part in a way that reinforces their resistance to flexion.

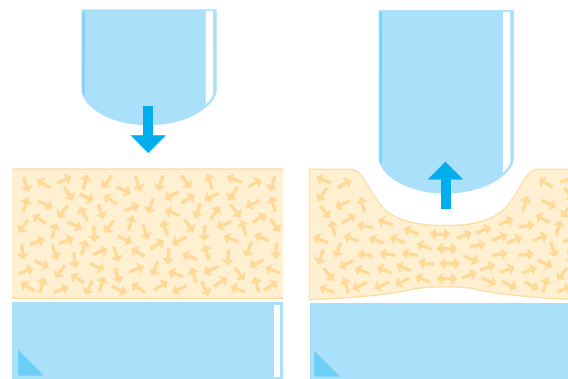

With hinges made by this process, a folder can be opened and closed millions of times.

#### ••• Comment

Most creasing is carried out "cold", i.e. at a normal working temperature of 18°C for both the material and the work place. A pallet at zero degrees will need at least 24 hours to be acclimatised to 18°C.

A good hinge must stay flexible. It should therefore be marked out clearly, and not creased too deeply as this causes cracking with wear.

When heat creasing, do not overheat Priplak® as it causes the plastic to mould into another shape. When this happens, instead of producing a hinge-like effect, you will obtain thinning of the material, in which the molecules have not yet been subjected to orientation and become brittle.

# I. CUTTING-CREASING

## ••• Comparison of “cold” and “heat” creasing

Cold creasing	Heat creasing
Produces a good hinge.	A more flexible hinge, an advantage for folders.
On a mechanical press (notching type), creasing is carried out piece by piece and crease by crease, unless the tool consists of several blades.	Heat creasing is carried out with a mechanical press or a platen. You can use a machine with the appropriate configuration for this processing method or adapt tools on a standard machine. On a mechanical press the backplate can also be heated.
Most Priplak® products in the usual thicknesses (0.5 to 1.2 mm) can be “cold” creased when they are being cut out on a platen.	On a mechanical press or a platen, a dwell time is needed in order to achieve optimum results.
Priplak® is perfectly suited to “cold” creasing which means that there is a good balance between conversion costs and product quality.	Heat creasing is mainly suited to thicknesses over 1.4 mm, or for special cases.
	In order to obtain better quality in terms of the opening and closing of a folder, for example, as well as a nice presentation, you may use a double creasing tool spaced with interval of 6 mm.

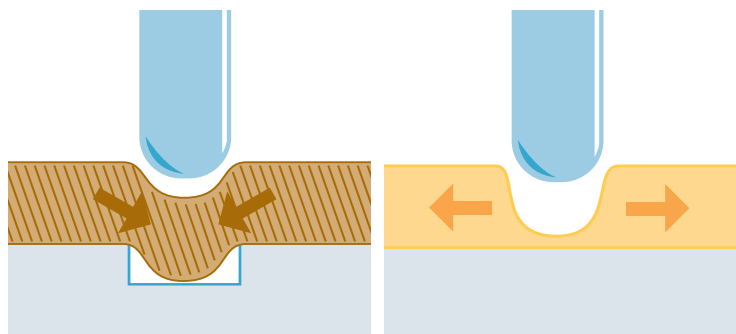

Unlike carton board, where the creasing blade comes down onto a matrix and causes the material to shrink, Priplak® creasing is carried out on a flat bed and lengthens the material.

## ••• The advantages of repeated “cold” creasing

This technique produces hinges with less springy characteristics.

After the perforations and cuts, the folders, boxes, cases and other products are individually on a mechanical press or all together on a platen.

If a platen is used for the repeated creasing of folders, care should be taken to provide several slits so that the spine can be produced in varying widths.

The tool has several creasing blades that are a few centimetres wider than the creasing width.

Two-point rules are the ones most frequently used but three or four-point rules can also be chosen. We recommend that you carry out tests before manufacture. This is the best way to check if the result obtained corresponds with the intended effect.

Repeated “cold” creasing can also be carried out on letterpress machines or on cylinder cutting presses. In this case, the creasing blades must be perpendicular to the cylinder axis.

## ••• The advantages of double or multiple creasing

For hinges that need to open and close more easily, the creases need to be doubled and spaced at intervals of 4 to 5 mm, which would produce a pleasant aesthetic effect.

This technique is particularly used for folders which need to achieve perfect flatness and squareness of the product when closed. We recommend that you carry out tests before manufacture.

# I. CUTTING-CREASING

Several creasing blades can be used to produce blocks of creases. In such cases, you should make sure that the necessary pressure does not exceed the pressure specified by the manufacturer of the machine. In this particular case, flat-bed cylinder presses can be used. For great thicknesses, reinforcement of grippers will be necessary.

## ••• Precautions

### **Pressure**

The pressure required to cut out a sheet of Priplak® is 100 kg per centimetre of rule, whatever the type of rule used. For complex cutting out, for instance when there are many assembly tabs or holes, higher pressure is needed. For further information, the die cutter should be asked for advice.

### **Multiple Tools**

Cutting out several shapes at a time can be achieved when the shapes are relatively simple. If they are complex, gains on cutting and printing may be lost because costs are higher : tooling is more expensive and positioning is longer and more difficult.

### **Positioning the tool**

Adjustments need to be made carefully and progressively, in order to make sure the tool last longer than 10 000 pieces.

To adjust the form, it is loaded by positioning thin strips of metal on the backs of the rules to be slotted in and by increasing pressure little by little.

### **Production Monitoring**

Cutting rules which have cut many times tend to wear down and lose height. This height difference must be made up in increased pressure, so that the cut remains clean. The creasing rules should also be checked to ensure they do not cut the material : they should be pulled upwards through the form (thin metal blade or adhesive stimulates cutting in order to increase the pressure).

If this is not enough, creasing rule height should be changed or the template should be re-ruled with new cutting rules.

Safety : the cut-out pieces should be examined every 500 passes.

### **Cutting Out Blanks**

Cutting out blanks is cutting out with no sheet of Priplak® between the tool and the platen. This causes damage to the cutting tool, shortening its working life.

### **Stripping**

Stripping, is when the piece is removed from the surrounding sheet. To avoid tearing the cutting out piece, it is better to take small quantities of 10-20 sheets maximum.

## ••• Binding

### **Guillotining**

Guillotine only small quantities of sheets. This will avoid sheets slipping and not being cut square as well as the guillotine blade blocking.

### **Squaring the Sheets**

It is essential that sheets be square on all 4 sides for double sided offset or screen printing. See our technical specifications to find out which materials cannot be guillotined trimmed on 4 sides.

### **Notching, Perforation, Rounded Corners**

To carry out these operations product by product and in small quantities, a universal notcher equipped with suitable tools is used.

These mechanical presses can perforate, crease, lift and notch.

Although they are more expensive than traditional cutting tools, they have a longer life and their standard models are very often sufficient.

### **Use of Metal Cutting Tools**

These are often the only technical solution for particular cutting out problems such as narrow slots, repeated perforations, etc. Metal cutting tools are used, as for aluminium, with a punch and a die. These tools also have automatic ejection for the various types of perforation.

## II. ASSEMBLY

1

### ALL THE ASSEMBLY TECHNIQUES

Techniques	Advantages	Disadvantages
<b>RIVETING</b>	<ul style="list-style-type: none"> <li>• No thickness limit</li> <li>• Decorative aspect</li> <li>• Flexibility</li> </ul>	<ul style="list-style-type: none"> <li>• Expensive if using many rivets</li> </ul>
<b>SEWING</b>	<ul style="list-style-type: none"> <li>• Permit assembling sheets of Priplak® with materials of different structures</li> </ul>	<ul style="list-style-type: none"> <li>• Manpower costs</li> </ul>
<b>BINDING</b>	<ul style="list-style-type: none"> <li>• Easy and practical if there are many similar elements to assembly</li> </ul>	<ul style="list-style-type: none"> <li>• Permits manufacture of simple products only</li> </ul>
<b>WELDING</b> <ul style="list-style-type: none"> <li>• Heated mirror</li> <li>• Heated block</li> <li>• Ultrasound</li> <li>• High frequency</li> <li>• Impulsion</li> <li>• Hot air</li> </ul>	<ul style="list-style-type: none"> <li>• Permits assembling two sheets one with the other</li> <li>• Permits welding a thin film on a thicker sheet of Priplak®</li> <li>• Permits welding a thin film on a thicker sheet of Priplak®</li> <li>• Ecological</li> </ul>	<ul style="list-style-type: none"> <li>• Industrial aspect</li> <li>• Slow rating</li> <li>• Visible welding points</li> <li>• Cannot be used with polypropylene</li> <li>• Slow rating</li> <li>• Applicable only for a number of thicknesses</li> </ul>
<b>GLUING</b>	<ul style="list-style-type: none"> <li>• High precision</li> <li>• Continuous machine, rapid and automatic</li> <li>• Often used by professionals</li> </ul>	<ul style="list-style-type: none"> <li>• Limited choice of glues</li> </ul>

## II. ASSEMBLY

2

### GLUING PROCESS

In order to join two materials (either identical or different), gluing should be carried out by applying a glue to one or two substrates. The change from a liquid solid state will ensure adhesion.

Water, solvents or fusion convert the active agent in the glue.

**Two types of adhesives are particularly suitable for Priplak® gluing :**

- Reactive polyurethanes hot melt glues (also called PUR),
- Cyanoacrylate glues (also called Cyano).

You will find below a number of definitions and gluing vocabulary as well as specifications of the glues mentioned above.

••• **A few definitions to get familiar with gluing process**

- **Polymerization** is a reaction in which double-bond monomers influenced by an active agent create a polymer.

- **Tack** is the capacity of an adhesive to form a bond immediately after two substrates are brought together into contact. It is the first stage of assembling before adhesion that permits gluing.
- **Substrate** qualifies a support on which a glue will be spread.

Various glues represent different mechanical resistance to different processes, like :

- **Peeling-off :** When one of the support remains fixed while the other one is pulled back.

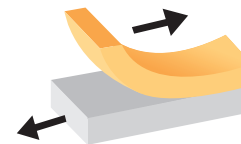

- **Shearing :** A force on the contact area is transferred by the gluing surface.

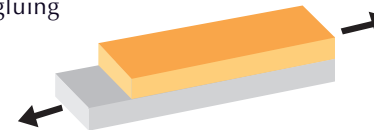

- **Tension :** A stress that acts perpendicularly on the surface may cause creep if it is not uniform.

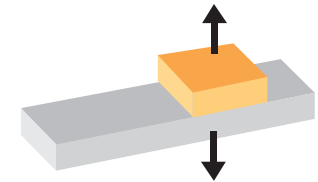

- **Slippage :** In the case of rigid substrates, a stress on the surface is not uniform. Slippage is inevitable.

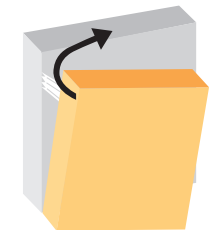

••• **Remark**

The word "glue" is used as a general term to describe both glues and adhesives, which have separate properties. Unlike an adhesive, the tack of a glue is not immediate.

**A glue** is made of natural material (animal, mineral or vegetable).

**An adhesive** is a synthetic products made of elastomers. .

**The Corona process is necessary for good adhesion and gluing of your creations.**

## II. ASSEMBLY

These are suitable for your Priplak® projects.

### ••• Thermofusible glues

#### • Hot melt glues

They are 100% dry. Their technological development has revolutionised “solvent” or “water” gluing.

Their 3 biggest qualities are : being affordable, efficient and clean to use, which means less machine stoppage, and value added to products and processes.

Their liquid structure is obtained by melting of a solid product (granulates in a melting machine, a generator or pellets in a heating pistol) before its application to a substrate.

Melting temperature and softening points may vary depending on the adhesive components. Heat brings about the tack of an adhesive and its fluidity, but it may be sometimes necessary to add plasticizers.

The adhesive becomes cross-linked when it cools down. However, the glue joint may become liquid again if the product is exposed to high temperature.

Thus, the parameters of “curing” are glue thickness, cooling time and temperature of application.

#### • Reactive polyurethanes hot melt glues

Their cross-linking depends on humidity in the air. These cross-linking adhesives resist a number of chemical agents. Their reactivity, humidity and temperature influence their curing.

These glues resist damp conditions very well.

### ••• Cyanoacrylate glues

Because of their chemical nature, the polymerization of these glues is catalysed by a soft base (anion, in general OH<sup>2</sup> present in the form of “humidity” (see the picture below) in the ambient air on the surface to be glued. The molecules of the monomer<sup>(1)</sup> react like metal particles that attract one another like magnets (OH ions) and create the big molecule of the polymer<sup>(3)</sup>.

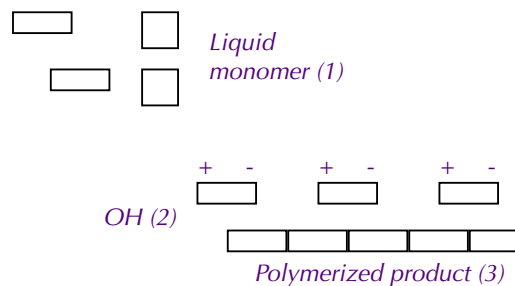

There are a great number of advantages represented by cyano glues. They polymerize at an ambient temperature, they are transparent and their “curing” time is particularly short - the biggest part of the adhesion is obtained after a few seconds only.

The biggest difference between these glues and the polyurethanes is the lack of bubbles in the glue joint.

This polymerization, also called polyaddition, consists of four stages :

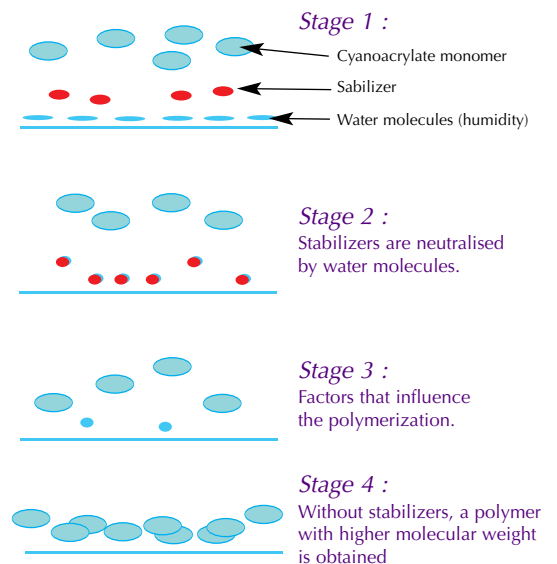

## II. ASSEMBLY

- **Preferences for a reliable and definitive polymerization**

- **Optimal conditions of environment :**

Relative humidity in the air (between 30 and 80%)

Temperature (between 15 and 30 °C)

- **Optimal surface :**

The larger the contact area the better the adhesion of a glue.

- **Optimal film thickness :**

Close contact between pieces < 0.2 mm.

Ideal thickness of glue film = 0.02 mm.

This thickness influences the time of polymerization and the final resistance of the glue.

Thus, for optimal results, the adhesive film should be very thin. A liquid monomer applied to a thin layer will ensure a resistant film and transparent glue.

Drying takes place in ambient temperature.

Because the quantity of an adhesive is most important factor in the adhesion process, special equipment is used to apply the minimum quantities of the product (adjusted drops).

Joint forming and final resistance are respectively more rapid and efficient thanks to a thin layer of adhesive film.

- **Cyanos specifications**

Although most of these glues do not resist shearing, some of them contain an elastomer stage that improves their resistance to impacts and peeling.

They do not resist high temperature as above 95°C, they soften. As far as "plastic to plastic" gluing, their resistance is good.

- **Remark**

- The surface to be glued should be determined in order to find out whether gluing can be carried out with cyanos.
- For heterogeneous gluing, the glue should be applied on the material that is the least rapid for glue applying.
- For a good execution of cyano gluing, the pieces to be glued should be carefully surfaced in order to avoid air bubbles and ensure good adhesion, that will result in a strong link.

- In case of good storage conditions (dry, dark place with fresh air) glue can be stored about a year.
- There are surface actuators of organic base which accelerate polymerization of cyano adhesives.

Although, unlike primers, they do not improve the adhesion, they may be recommended in some cases :

- in an unfriendly environment like cold or too dry atmosphere,
- on inert surfaces,
- in case of a thick film.

- Cyanos' solvents (nitromethane, acetone) can be used in some cases :
  - to separate assemblies,
  - to clean tools or pieces,
  - to ensure maintenance of dismantling devices, tubes or head draining.
- We recommend that you use a solvent or water to clean the support surface and activate the adhesive.



## II. ASSEMBLY

### ••• Adhesive comparison

Adhesive	Hot melt	Reactive polyurethane	Cyanoacrylates
<b>Advantages</b>	<ul style="list-style-type: none"> <li>• Easy control of fluidity</li> <li>• Anti-UV</li> <li>• Different forms of nozzles available, permitting various application forms and joint types</li> <li>• Gluing techniques easily controlled</li> </ul>	<ul style="list-style-type: none"> <li>• Transparent glue joint</li> <li>• High rating</li> <li>• Easy to control curing</li> <li>• Expensive machine is rapidly made profitable thanks to high rating</li> <li>• Folder/gluer machines can be easily adapted to Priplak® gluing</li> <li>• Assembling of all supports</li> </ul>	<ul style="list-style-type: none"> <li>• Immediate adhesion</li> <li>• Transparent joint without bubbles</li> <li>• Easy to use</li> <li>• Good resistance to solvents (ethanol, benzene, trichloethylene)</li> </ul>
<b>Disadvantages</b>	<ul style="list-style-type: none"> <li>• Demanding storage conditions</li> <li>• Possible reactivation depending on storage temperature of finished product</li> </ul>	<ul style="list-style-type: none"> <li>• Application conditions requiring a controlled atmosphere</li> <li>• Expensive adhesive</li> <li>• Unsuitable for contact with food</li> <li>• Joint with bubbles</li> </ul>	<ul style="list-style-type: none"> <li>• Little resistance to chocks (breakable glue joint)</li> <li>• Little resistance to peeling-off and shearing</li> <li>• Very expensive, but small quantity needed</li> <li>• Need to supply only small quantities as the adhesive cross-links during the storage</li> <li>• Need of total equipment development including workforce protection</li> <li>• Unsuitable for contact with food</li> <li>• Σ environment unfriendly</li> </ul>

**NOTA** : Glues and gluing techniques improve all the time, you may contact glues suppliers for further information. Before applying any glue, you should carry out appropriate tests.