

Conventional applications of Thin Films

Jari Koskinen

Hardness, protection and wear

Diamond-like carbon



Art & Decoration



Titanium Nitride,
Titanium Dioxide



Applications of thin films

- **Electronic components**
 - semiconducting, dielectric, insulating, conductors, barriers...
- **Hard protective coatings**
 - Tribology short
 - Cutting tools: metal
 - Metal forming
 - Comonets
 - Combustion engine
 - Turbine blades
- **Decorative films**
 - Metal
 - Interference coatings
 - Pagaging,
- **Decorative and wear-resistant (decorative/functional) coatings**
 - TiN
- **Permeation barriers for moisture and gases**
 - Bottle
 - Pacaging (Aluminium)
- **Corrosion resistant films**
 - ALD
- **Dry film solid lubricants**
 - DLC, MoS₂

■ Coatings tribology

Parameters influencing friction and wear

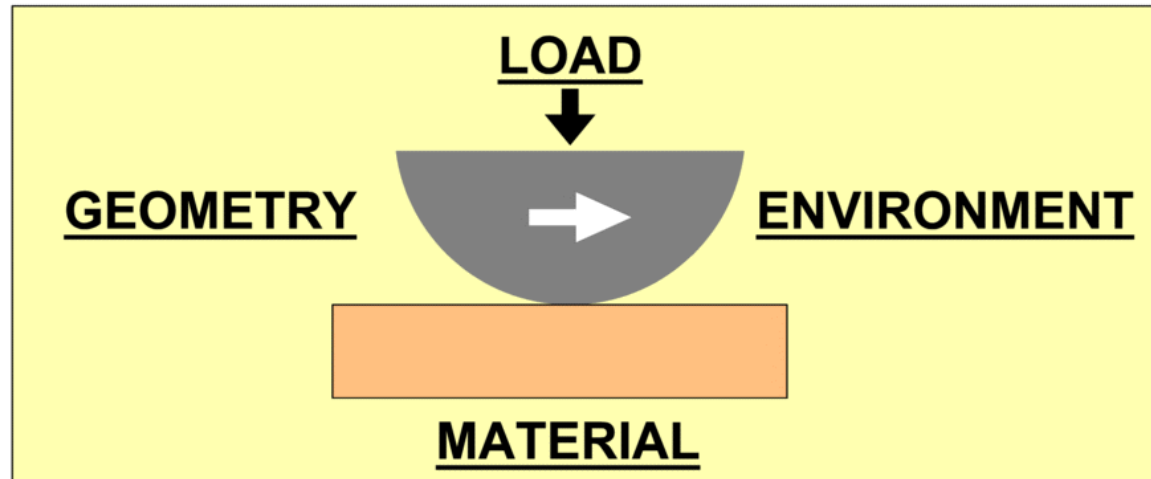

kgh1.dsf

GEOMETRY

- Macrogeometry
- Topography
- Debris
- Transfer layers
- Coating thickness

LOAD

- Normal load
- Tangential load
- ➔ Speed

ENVIRONMENT

- Temperature
- Humidity
- Gas, liquid
- Radiation

MATERIAL

- Elasticity
- Plasticity
- Fracture toughness
- Chemical reactivity

kghcf1.dsf

Features of a (metal) surface in contact

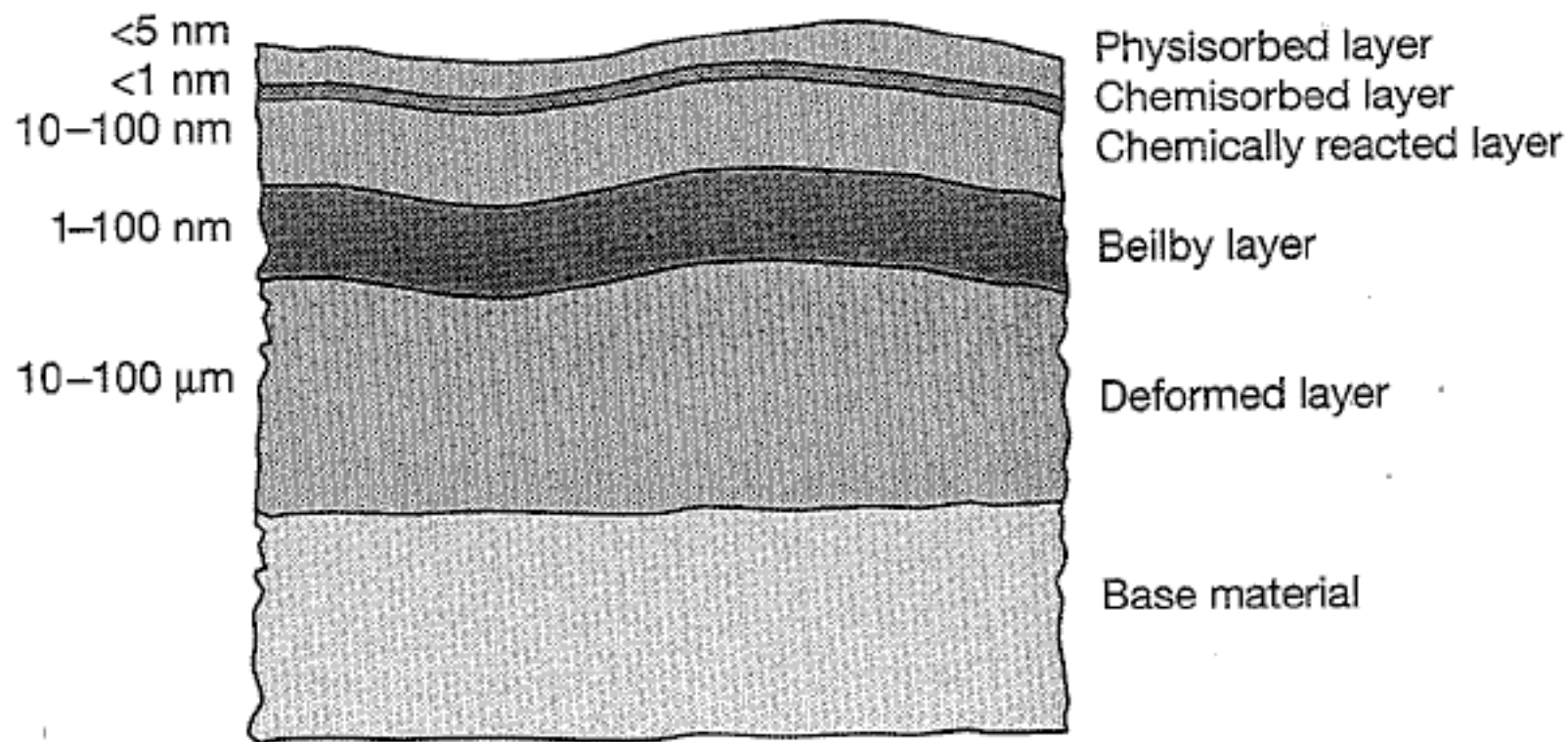

Sizes ranges

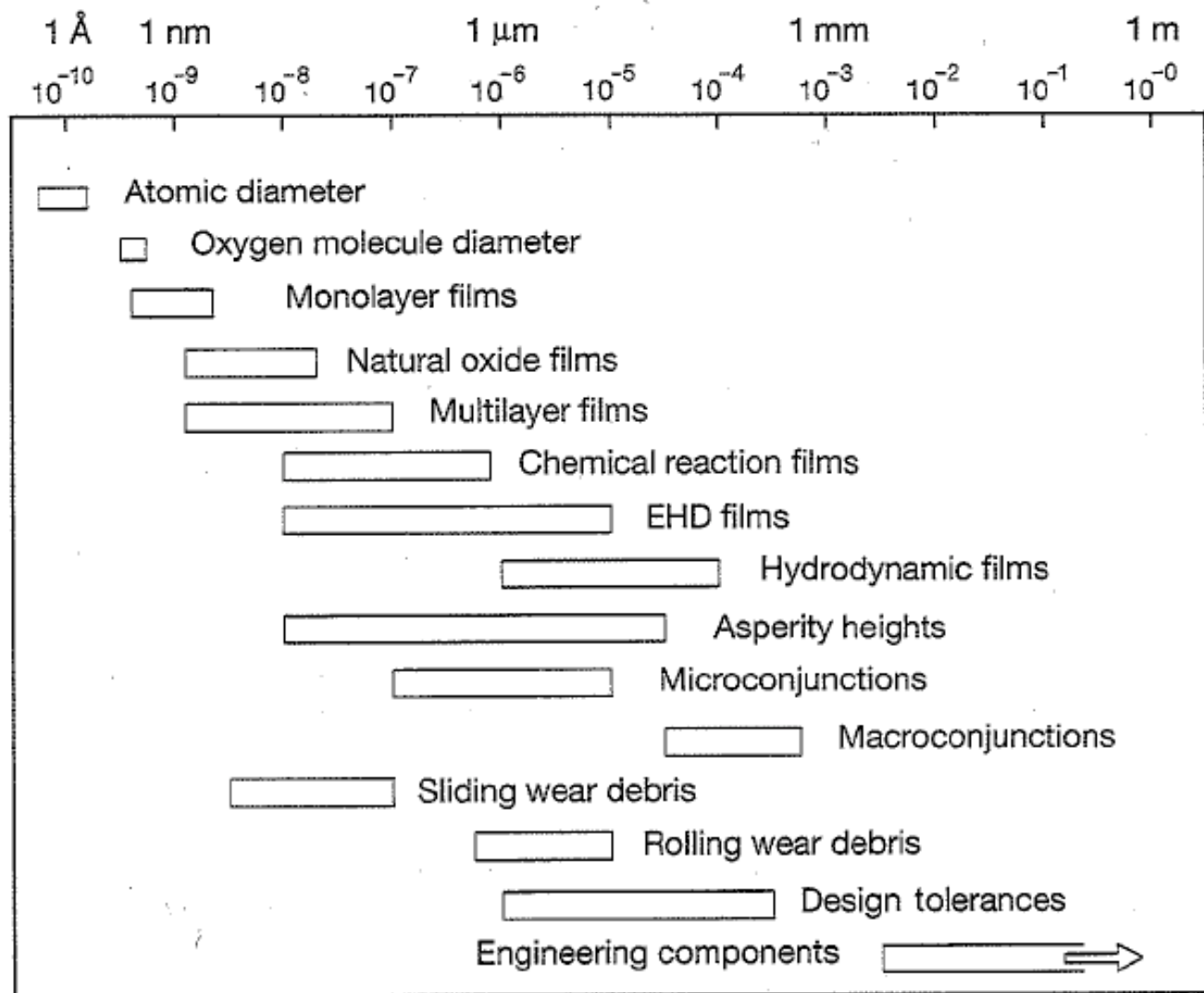

Fig. 3.5. Sizes of surface elements and surface-related phenomena.

Processes from loading to wear

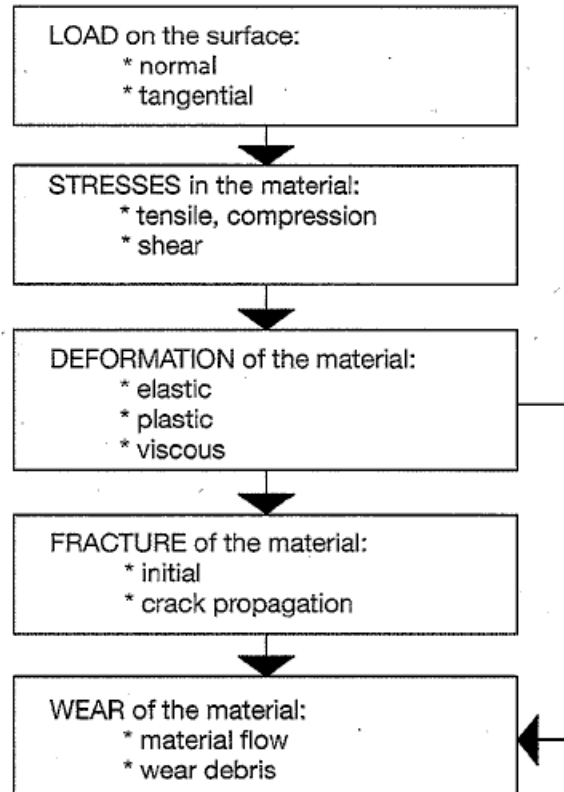
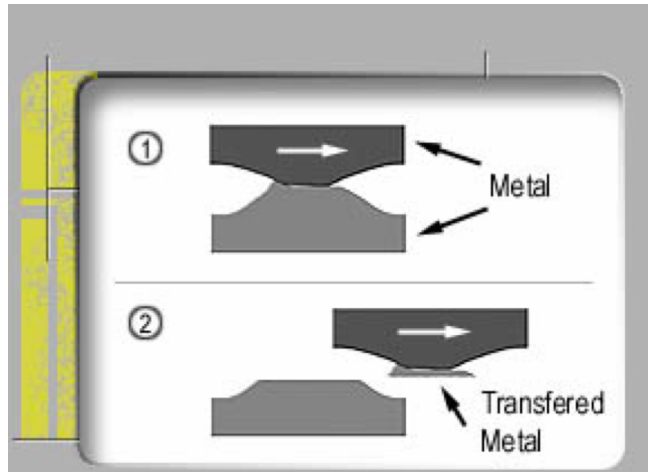
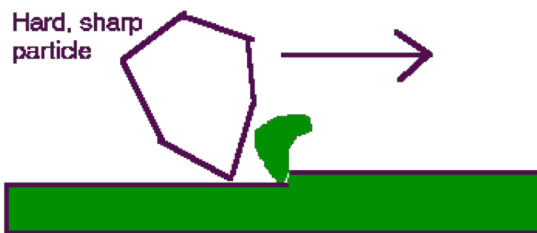

Fig. 3.25. Schematic diagram of the process from loading of the surface to wear.



Adhesive



Abrasive

Plastic deformation in wear - example of Au films

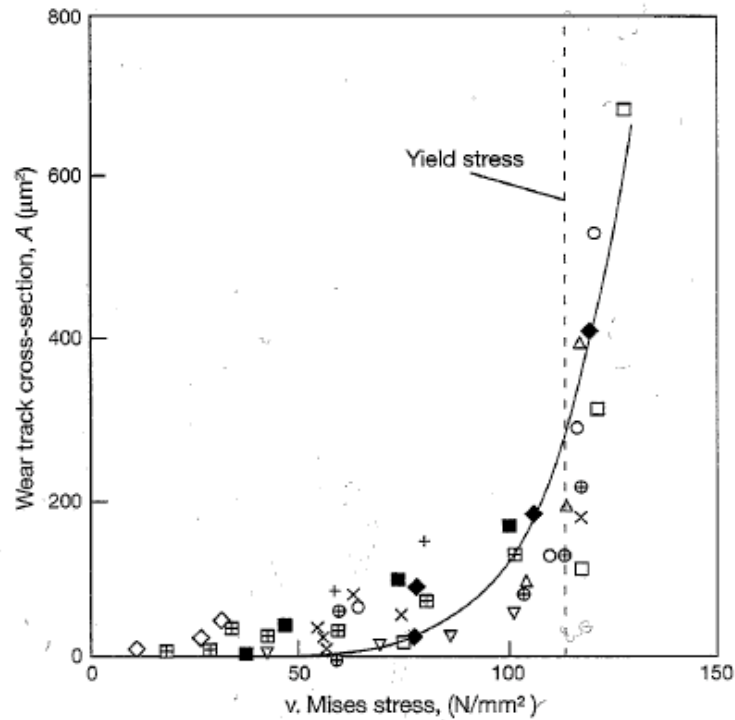

85. Cross-section of the wear track for both evaporated and electrodeposited gold layers as a function of the von Mises stress averaged over the depth and the contact radius for 56 different contact conditions. The solid line is obtained from a wear model (data from Tangena, 1989).

Wear

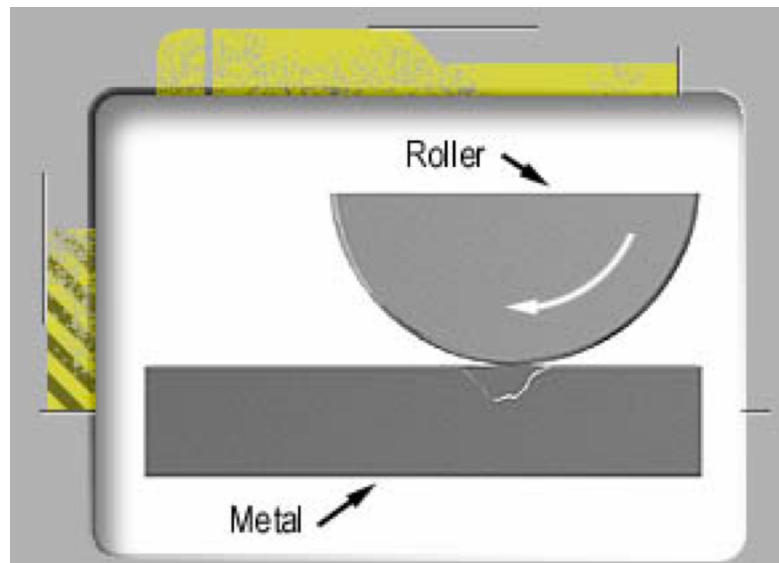

fatigue

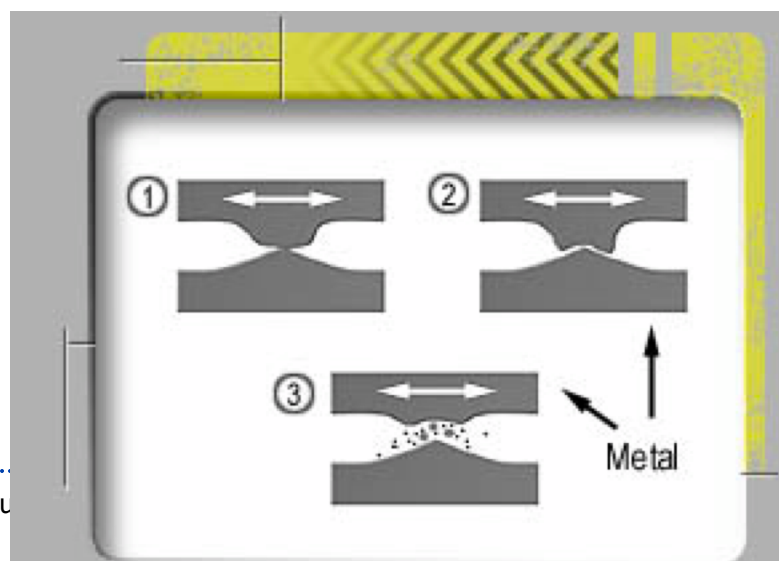

Fretting

Some coating wear modes

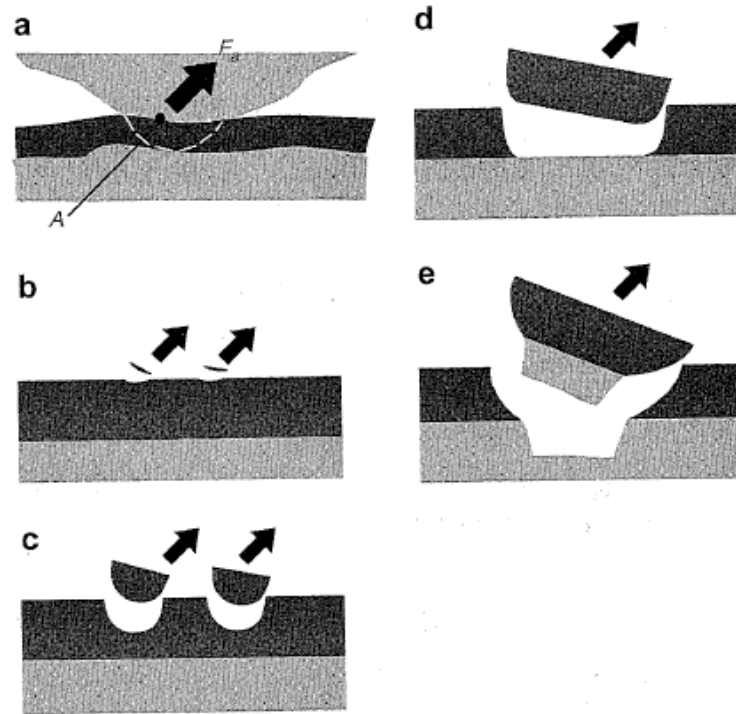

Fig. 3.97. Two surfaces attach to each other by adhesion (a) and the movement of the top surface results in an adhesive force, F_a , that tries to detach material over an area, A , from one of the surfaces. The detachment may take place (b) at the top surface, (c) within the coating, (d) at the coating/substrate interface and (e) in the substrate.

Coating interface at indentation

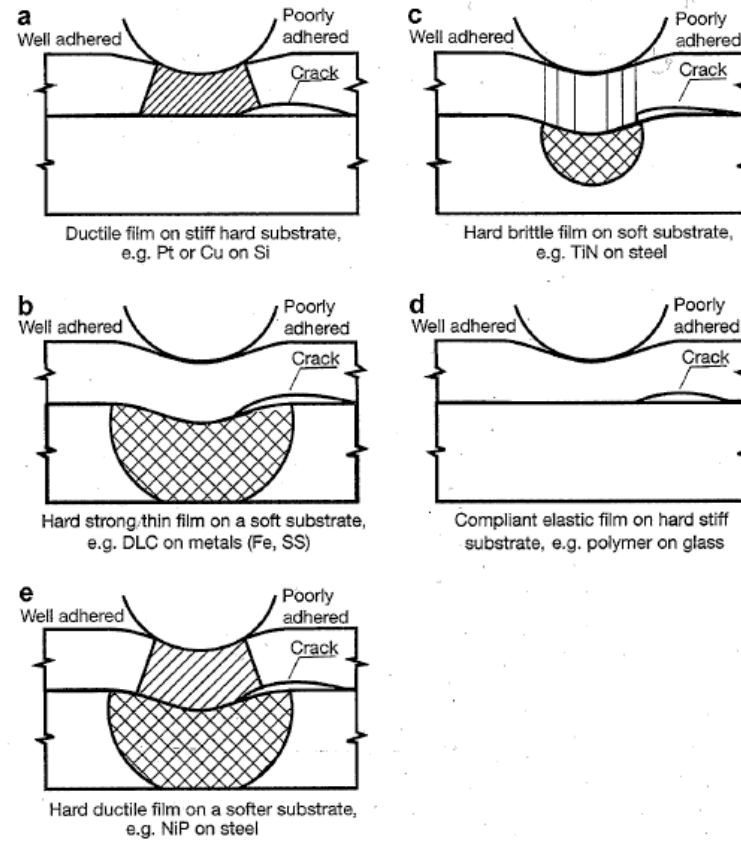
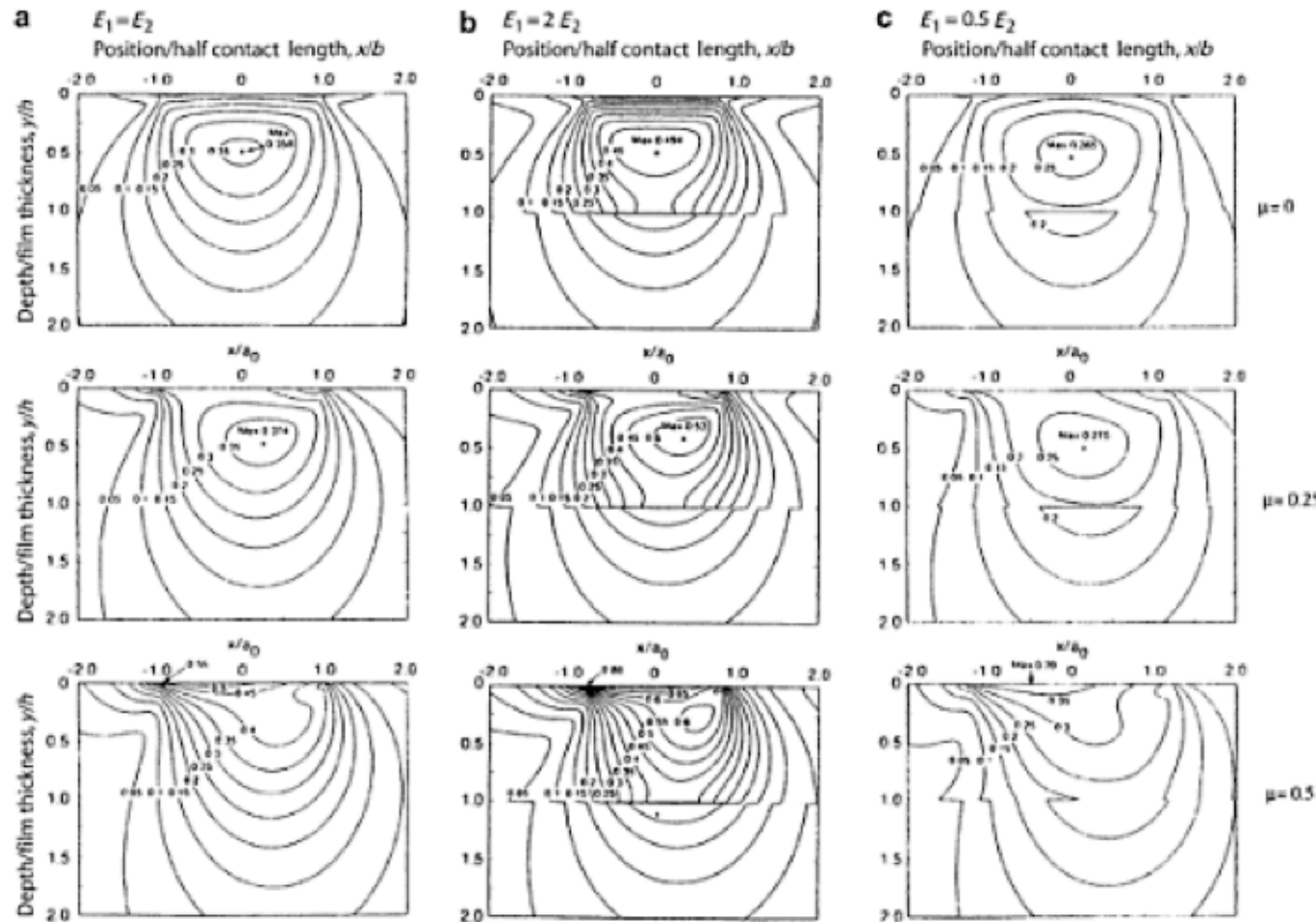

Fig. 3.62. Schematic cross-sections of various coating-substrate materials combinations and the influence of interfacial adhesion on cracking in indentation (after Swain and Mencik, 1994).

Stress countours, normarized to von Mises stresses ($\approx \sigma_y$)



90

Coatings Tribology

Fig. 3.33. Contour plots of normalized von Mises stresses, σ^2/ρ_{max} , in the surface layer (E_1) and the substrate (E_2) with (a) no surface layer, $E_1 = E_2$, (b) a stiff layer, $E_1 = 2E_2$, and (c) an elastic layer, $E_1 = 0.5E_2$, when loaded by a sliding rigid spherical countersurface with coefficients of friction of $\mu = 0, 0.25$ and 0.5 (after O'Sullivan and King, 1988).

Multilayer with gradient

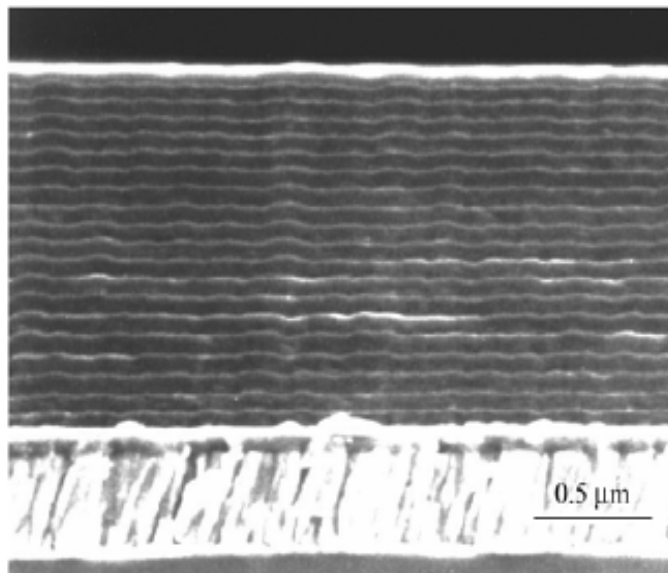

(b)

Fig. 6 A multilayer coating with multiple Ti/DLC pairs on top of a functionally gradient layer for an optimum combination of cohesive and adhesive toughness: (a) design schematic; (b) cross sectional photograph of the coating produced with 20 Ti/DLC pairs^[18].

Material	Hardness	Elastic modulus	Thickness
DLC at 10^{-5} Pa	70 GPa	650 GPa	400 nm
DLC at 2×10^{-1} Pa	43 GPa	450 GPa	100 nm
$\text{Ti}_{0.10}\text{C}_{0.90}$	25 GPa	290 GPa	25 nm
$\text{Ti}_{0.25}\text{C}_{0.75}$	27 GPa	350 GPa	25 nm
$\text{Ti}_{0.30}\text{C}_{0.70}$	29 GPa	370 GPa	100 nm
$\text{Ti}_{0.50}\text{C}_{0.50}$	20 GPa	290 GPa	100 nm
$\text{Ti}_{0.70}\text{C}_{0.30}$	14 GPa	230 GPa	100 nm
$\text{Ti}_{0.90}\text{C}_{0.10}$	6 GPa	150 GPa	50 nm
$\alpha\text{-Ti}$	4 GPa	140 GPa	50 nm
440C steel	11 GPa	220 GPa	

Tribological properties



■ Friction and wear performance evaluated:

- pin-on-disc
- reciprocative test
- unlubricated in normal atmosphere
- unlubricated in dry air
- lubricated with water and lubricating oil

Improved tribological properties of components by surface coatings

Reduced friction

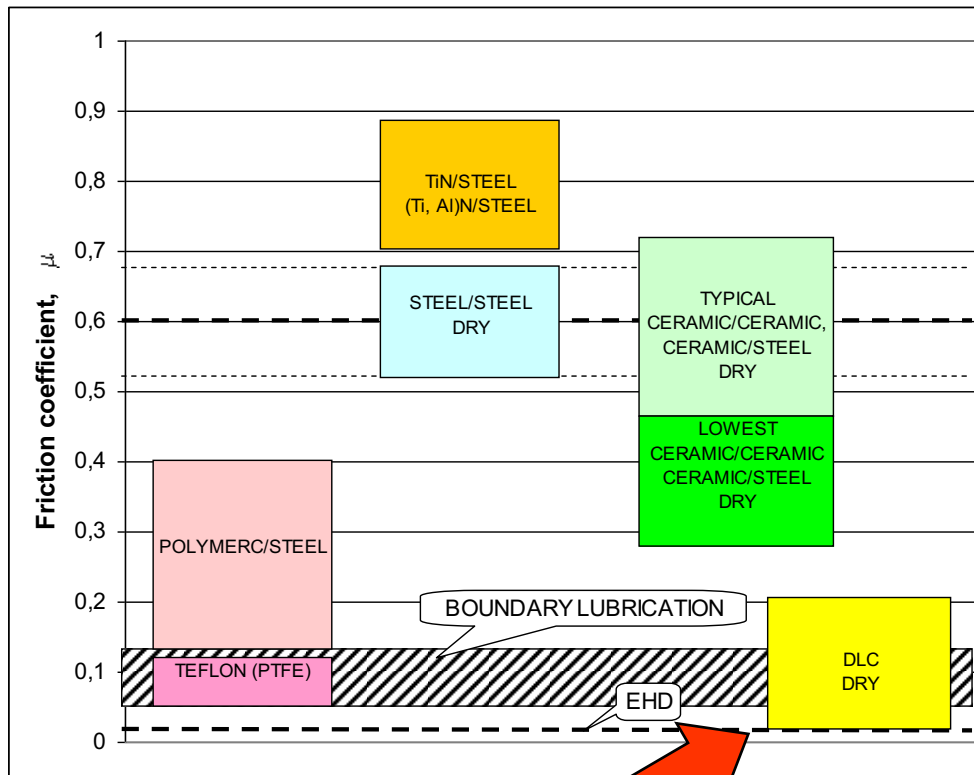

Increased wear resistance



Cutting tool coatings

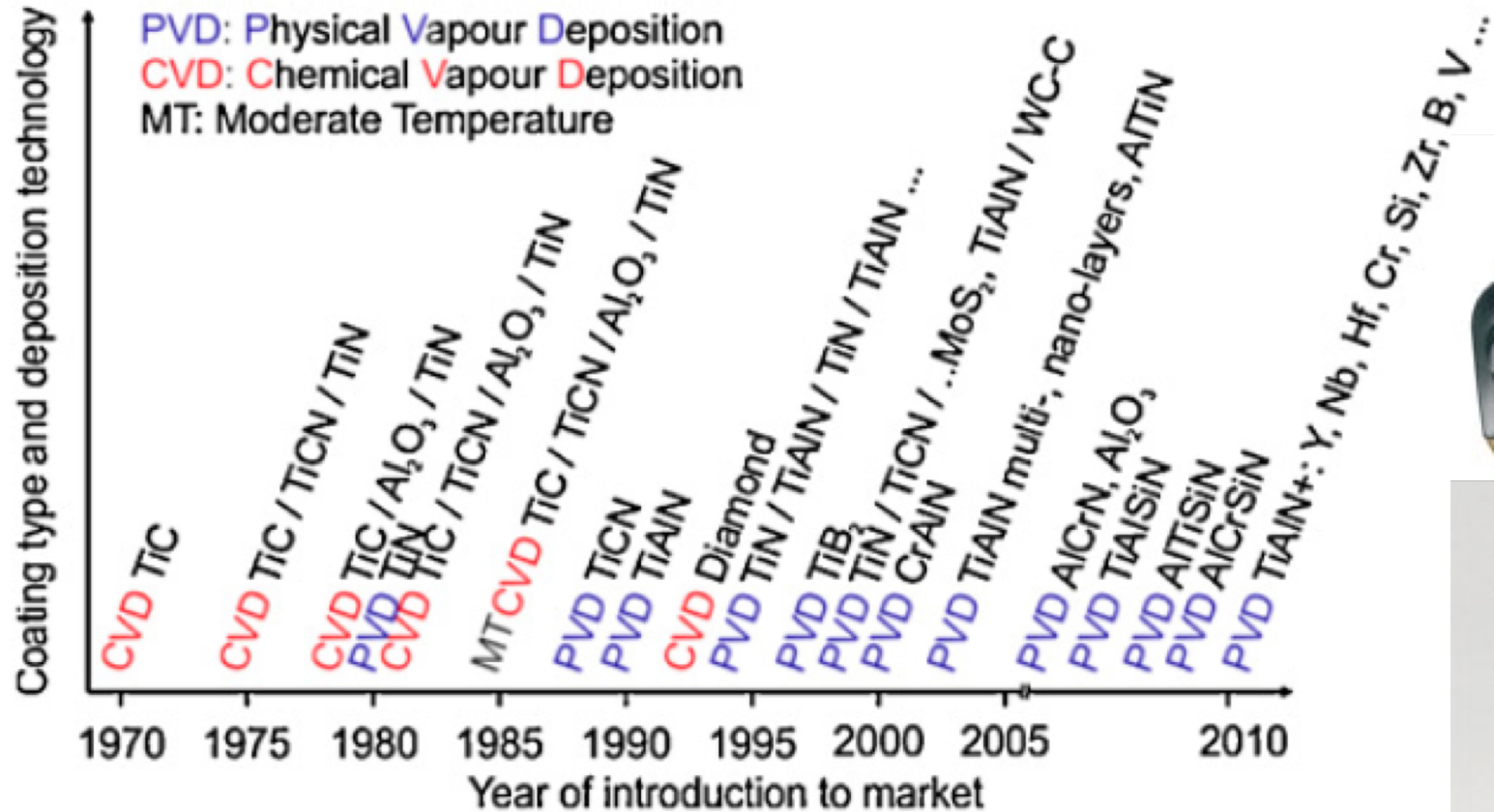

Fig. 7. Evolution of coating materials for cutting tools

K.-D. Bouzakis et al. / CIRP Annals - Manufacturing Technology 61 (2012) 703–723

- **Titanium aluminium nitride (TiAlN) or aluminium titanium nitride (AlTiN; for aluminium contents higher 50 at.%) stands for a group of metastable hard coatings consisting of the metallic elements aluminium and titanium, and nitrogen.**
- **Why TiAlN coatings outperform pure Titanium nitride (TiN):**
- **Increased oxidation resistance at elevated temperatures due to the formation of a protective aluminium-oxide layer at the surface**
- **Increased hardness in the freshly deposited films due to micro-structure changes and solid solution hardening**
- **Age hardening of the coatings at temperatures typical for cutting tools operation due to spinodal decomposition of TiAlN into TiN and cubic AlN [\[3\]](#)**

From WIKI

Tool coating process



Metal turning tool

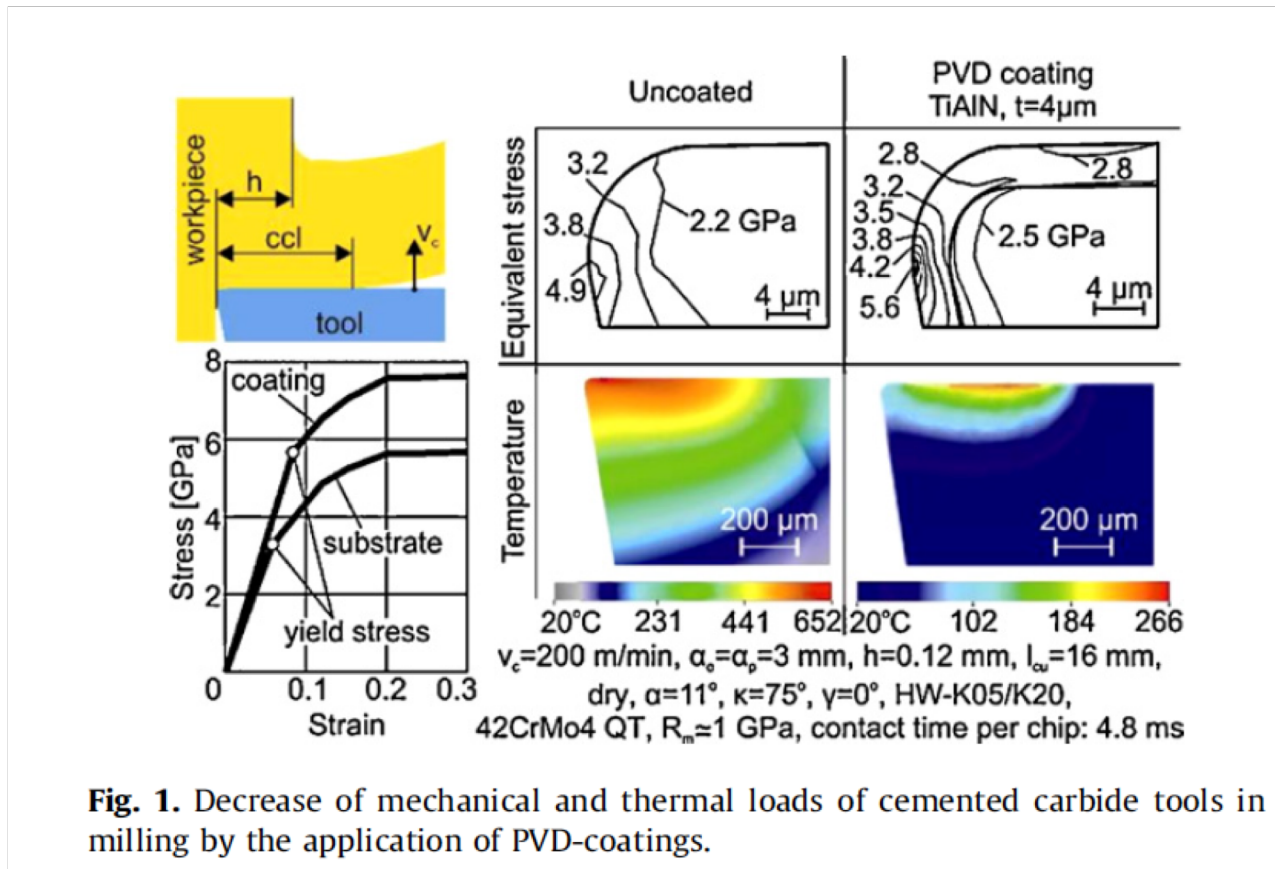

HIPIMS TiAlN

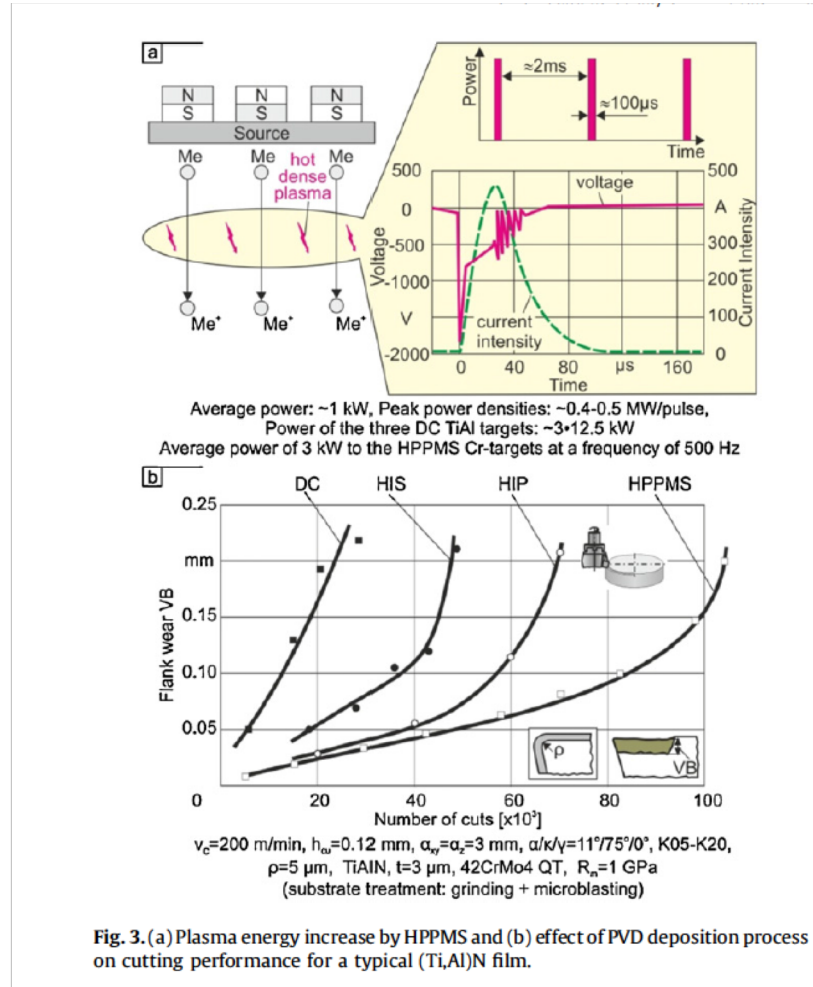

CrAlSiN coating

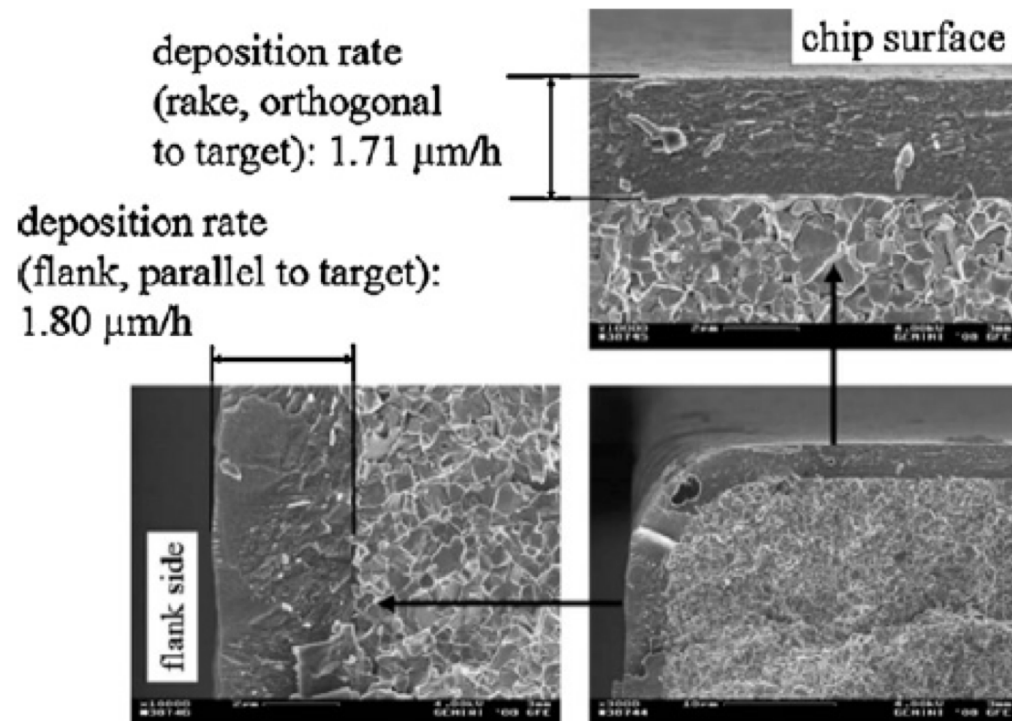

Fig. 4. SEM micrographs of cross sections from $(\text{Cr}_{0.5}\text{Al}_{0.45}\text{Si}_{0.05})\text{N}$ grown by HPPMS showing a high thickness uniformity around the cutting edge [14].

Coated Tool Information



AITiN

TiN

TiCN

nACo

nACRo

ZrN

CVD
Diamond

PVD
Diamond

1st Digit of Coated EDP

Hardness

Thermal Stability

TiN	Titanium Nitride	2	24GPa	1112F (600C)
TiCN	Titanium Carbonitride	4	37GPa	752F (400C)
AITiN	Aluminum Titanium Nitride	5	38GPa	1472F (800C)
nACo	Aluminum Titanium Nitride + Silicon Nitride	8	45GPa	2192F (1200C)
nACRo	Aluminum Chrome Nitride + Silicon Nitride	-	40GPa	2012F (1100C)
ZrN	Zirconium Nitride	6	25GPa	1049F (565C)
DIA	CVD Diamond	-	80-100GPa	1094F (590C)
DLC	PVD Diamond	-	70-90GPa	932F (500C)

Coating selection

Material	Hardness	TiN	TiCN	AlTiN	nAlCo	nAlCrO	ZrN	DIA
Austenitic Stainless Steel	< 35 HRe	*	X		*			
Martensitic Stainless Steel	< 35 HRe	*	*	*	X			
Martensitic Stainless Steel	≥ 35 HRe			*	X			
PH Stainless Steel	< 35 HRe	*		*	X			
PH Stainless Steel	≥ 35 HRe			*	X			
Ni, Co, Fe Based Super Alloys				*	X	X ₁		
Titanium				*	X	X ₁		
Alloy Steel	16-23 HRe	*	*	X				
Alloy Steel	23-38 HRe	*	*	X	*			
Alloy Steel	> 38 HRe			*	X			
Carbon Steel	16-23 HRe	*	*	X				
Carbon Steel	23-38 HRe	*	*	X	*			
Carbon Steel	> 38 HRe			*	X			
Low Carbon Steel	13-23 HRe	*	*	X				
Low Carbon Steel	23-38 HRe	*	*	X	*			
Low Carbon Steel	> 38 HRe			*	X			
Gray Cast Iron	18-22 HRe		*	*	X			
Nodular Cast Iron	22-32 HRe	*	X		*			
Aluminium <10% Si			*				X	
Aluminium >10% Si						*		X
Graphite								X
Composits								X
Hardened Steel	>45 HRe				X			

X = For BEST performance

X₁ = For SPECIFIC applications

* = Additional recommended coating options

Coating selection Hauzer

<i>Tool Coatings</i>	<i>Deposition Temperature Range °C</i>	<i>Maximum Operating Temperature °C</i>
TiN	<600	600
AlTiN	<600	900
AlTiN + W: C-H	150-450	450
AlTiN + Al ₂ O ₃	450-600	1100
AlCrN	<600	1100
TiSiN	<600	1500
TiCN	<600	600
TiAlN	<600	800
TiN + TiAlN multilayer	<600	800
CrCN	450	600
ta-C	80-200	>500

Table 1. An overview of tool coatings and their maximum temperatures.

continued on page 44

Friction - Lubricated low friction coating

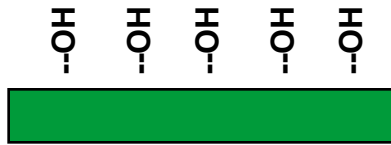

- Hydrogen free DLC
- PAO (polyalphaolefin)
oil lubricant+ 1w% glyserol
- OH-groups on surface
- Friction as low as 0,006
- Application in automotive parts
 - Valve lifters
 - About 25 % motor friction

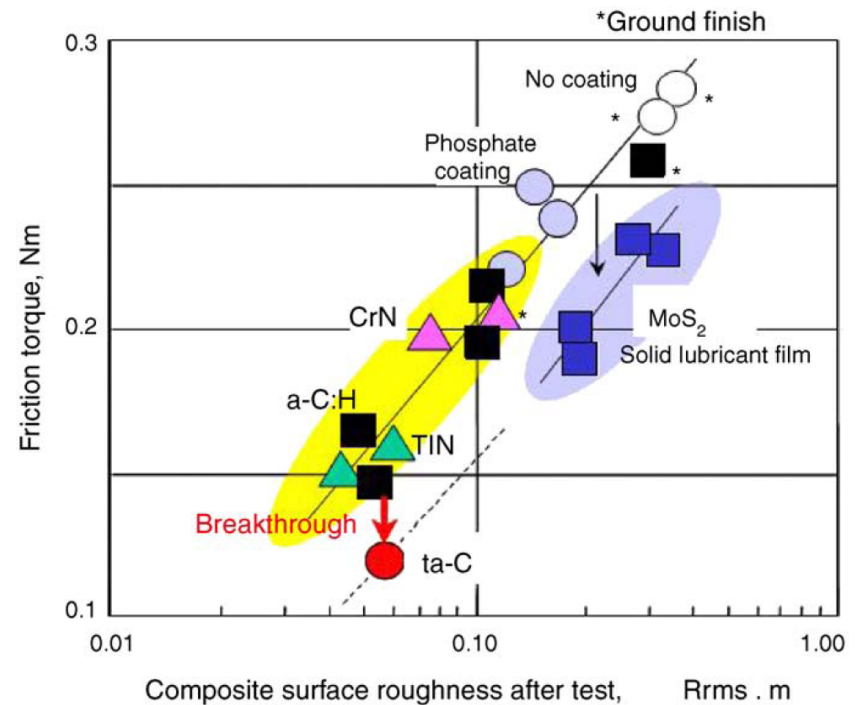

Friction

Super Hydrophobic Nano Carbon (SHNC)

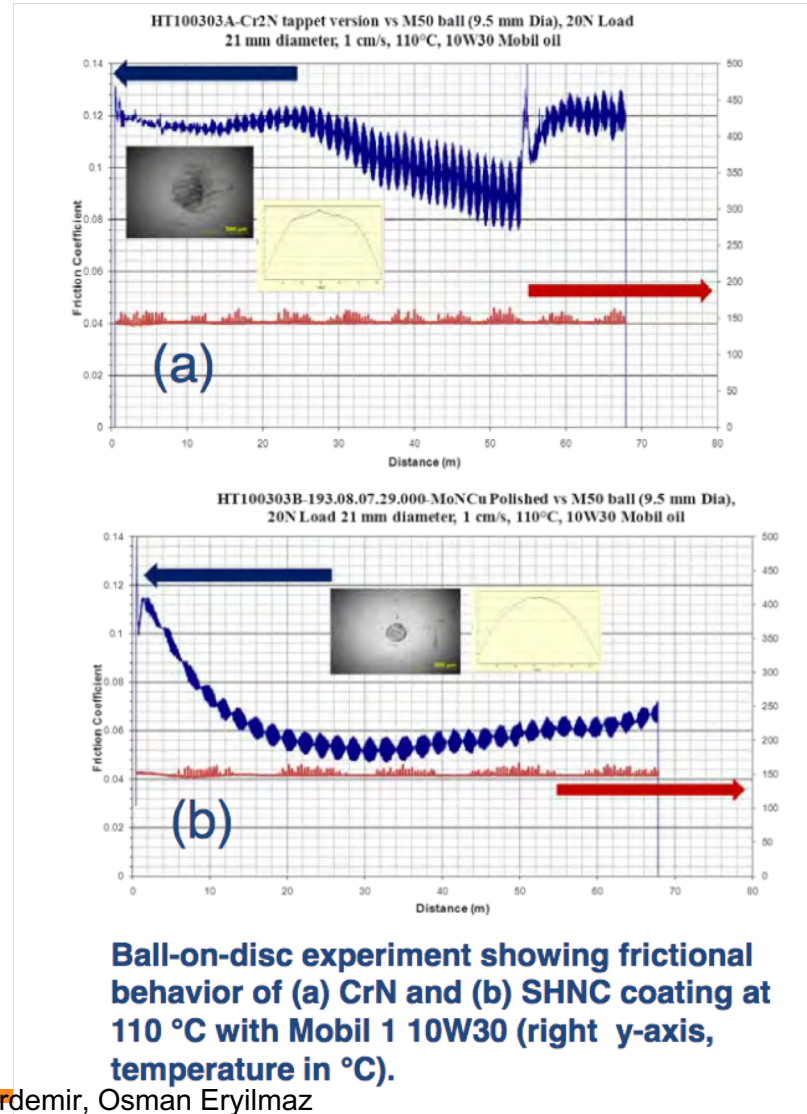

Ali Erdemir, Osman Eryilmaz
Argonne National Laboratory 2011

Coated components for wear and friction - automotive

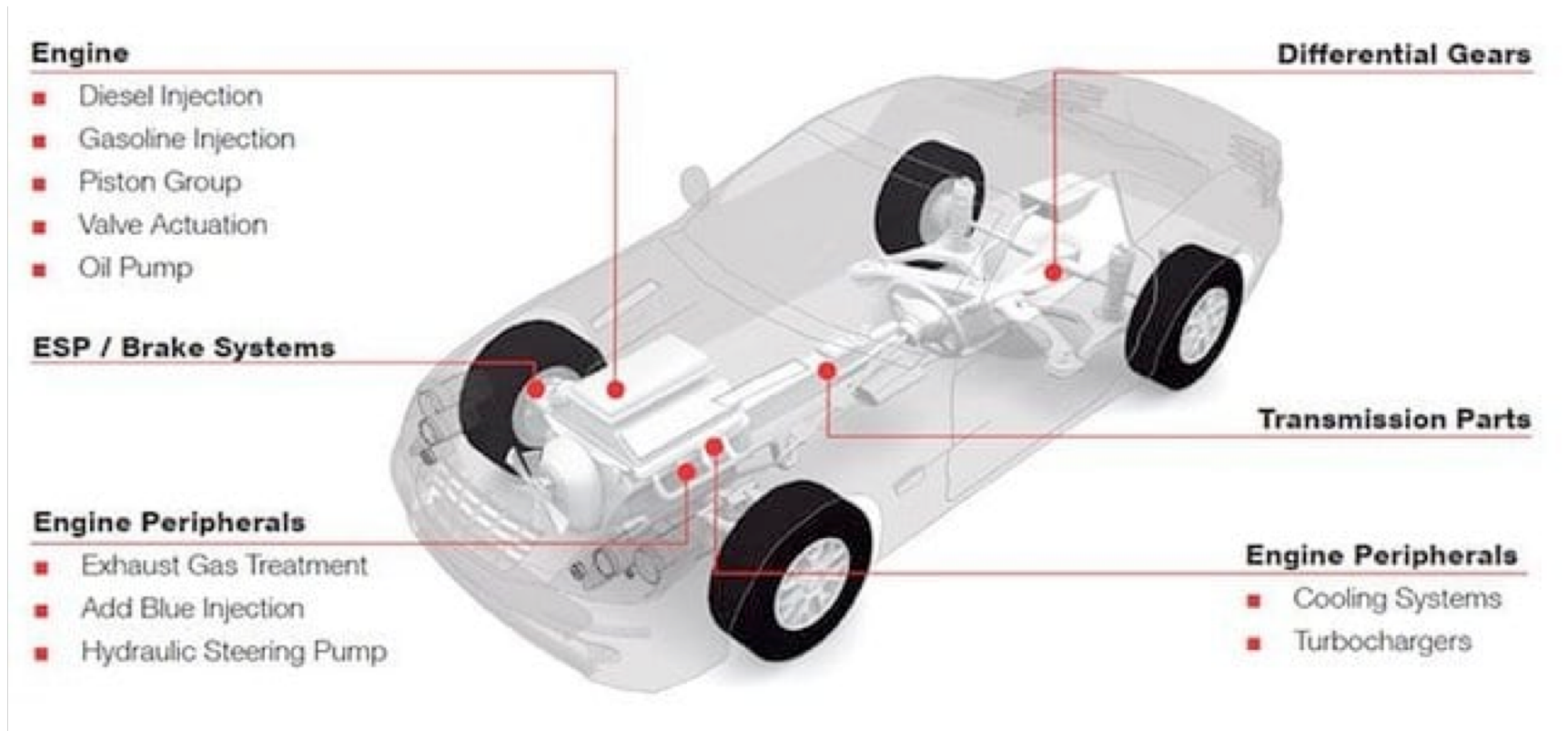

<https://www.oerlikon.com/balzers/sg/en/markets/automotive-and-transportation/automotive/automotive-components/>

Coated components for wear and friction – automotive Hauzer

<i>Technology</i>	<i>Arc Evaporation (PVD)</i>	<i>Sputtering (PVD)</i>	<i>High Voltage Discharge (PACVD)</i>
<i>Typical Coatings</i>	CrN, ta-C	CrN, metal DLC, ASIN	DLC, Silicon DLC
<i>Surface</i>	Rough (polish)	Smooth	Smooth
<i>Typical Applications</i>	Valve train components, diesel high pressure pump, diesel injector parts, piston rings	Valve train components, journal bearings	Piston parts, valve train components, diesel injector parts, diesel high pressure and oil pump parts, piston pins, gears

Table 2. *Technology, coatings and the engine components for which they are mainly used.*

Motor

DLC



Energy consumption of a car

K. Holmberg et al. / Tribology International 47 (2012) 221–234

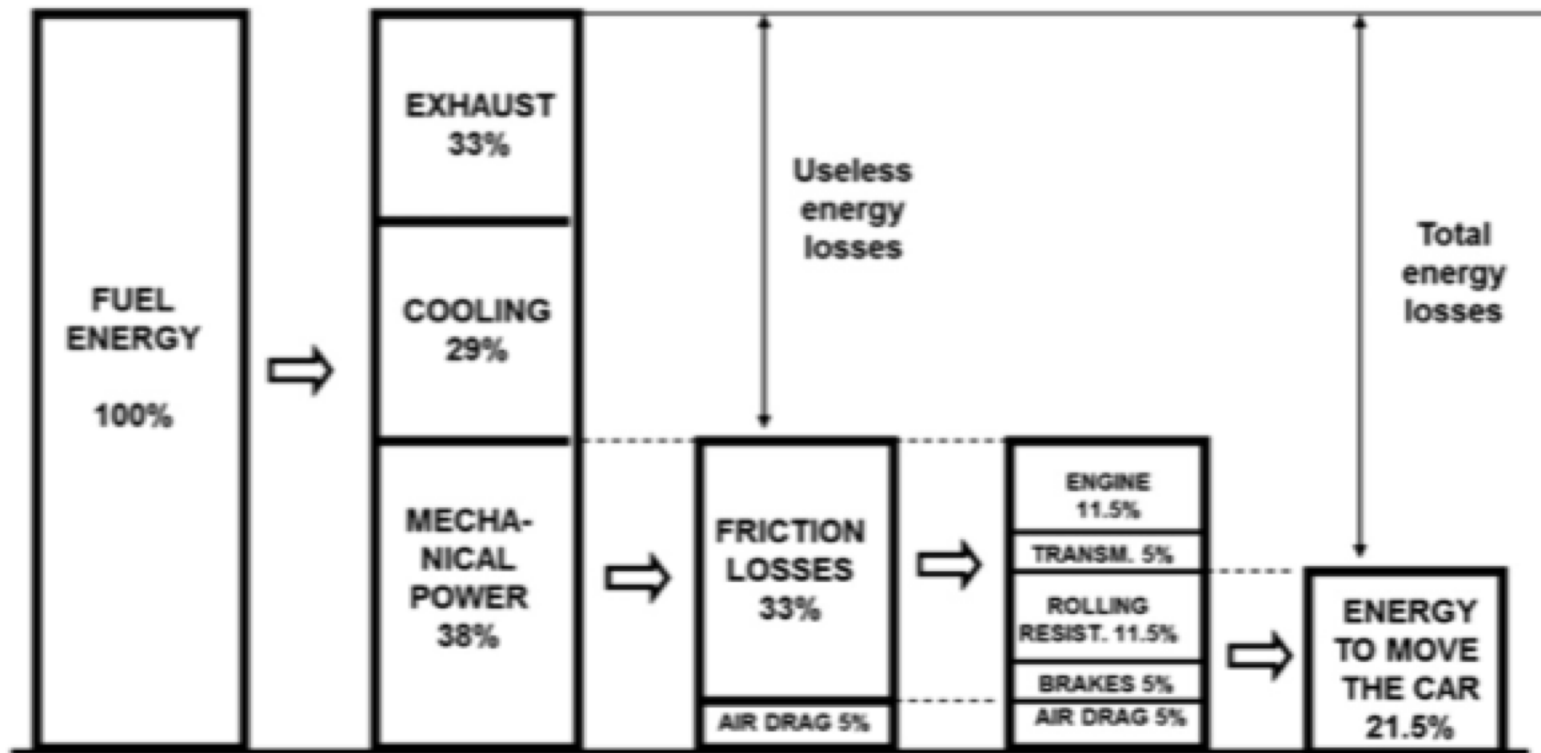

Fig. 4. Breakdown of passenger car energy consumption.

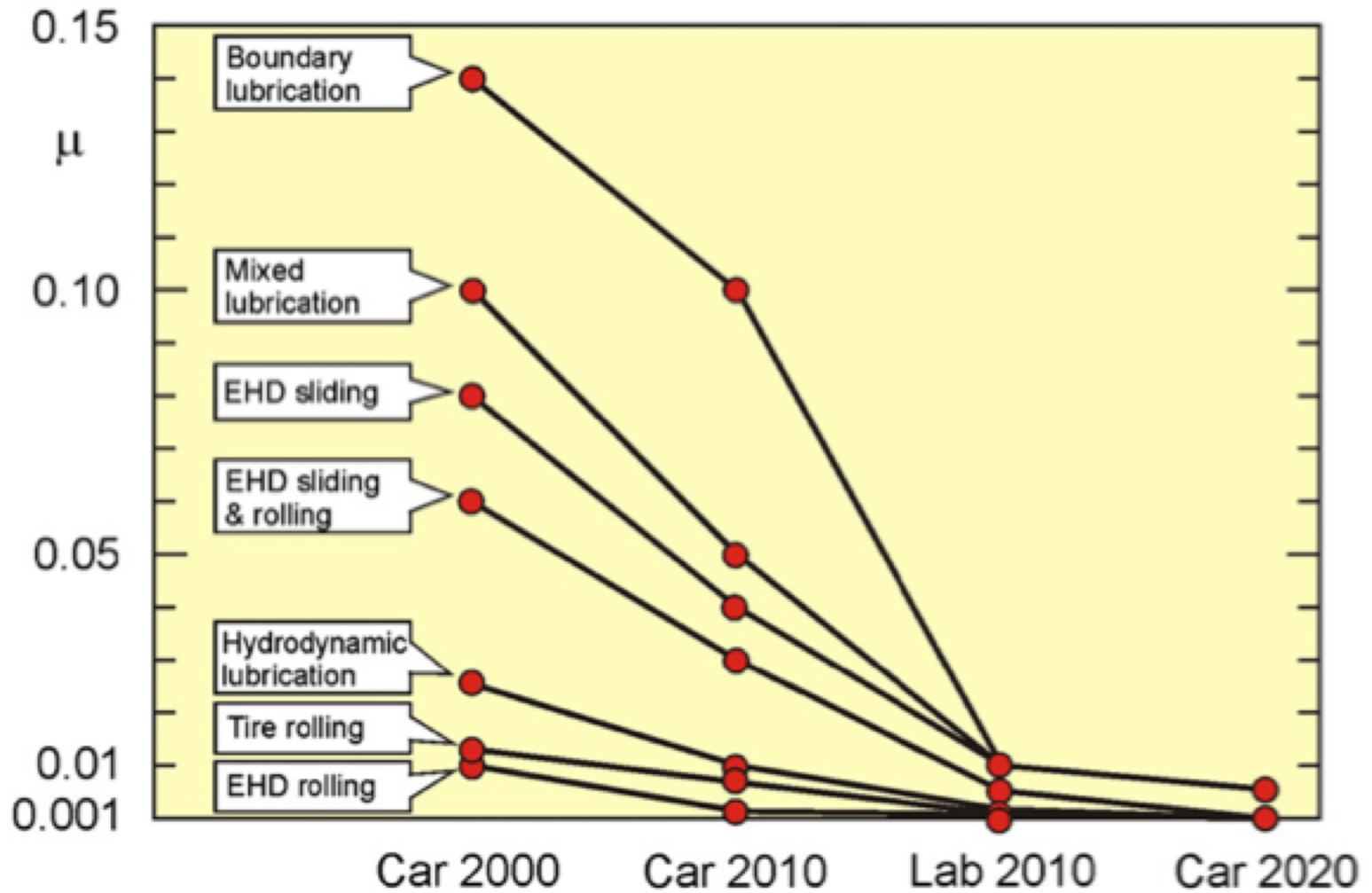

Fig. 5. Trends in the reductions in coefficients of friction in the four passenger car categories for different lubrication mechanisms and for rolling friction.

Decorative coatings PACVD on plastic



<https://www.oerlikon.com/balzers/com>

Title



<https://www.oerlikon.com/balzers/com>

Decorative DLC and other PVD from DIARC Ltd



Architectural, Automotive Glass & WEB Coating



<http://www.testbourne.com/architectural-automotive-glass-web-coating>

Roll to Roll for decorative and gas barrier

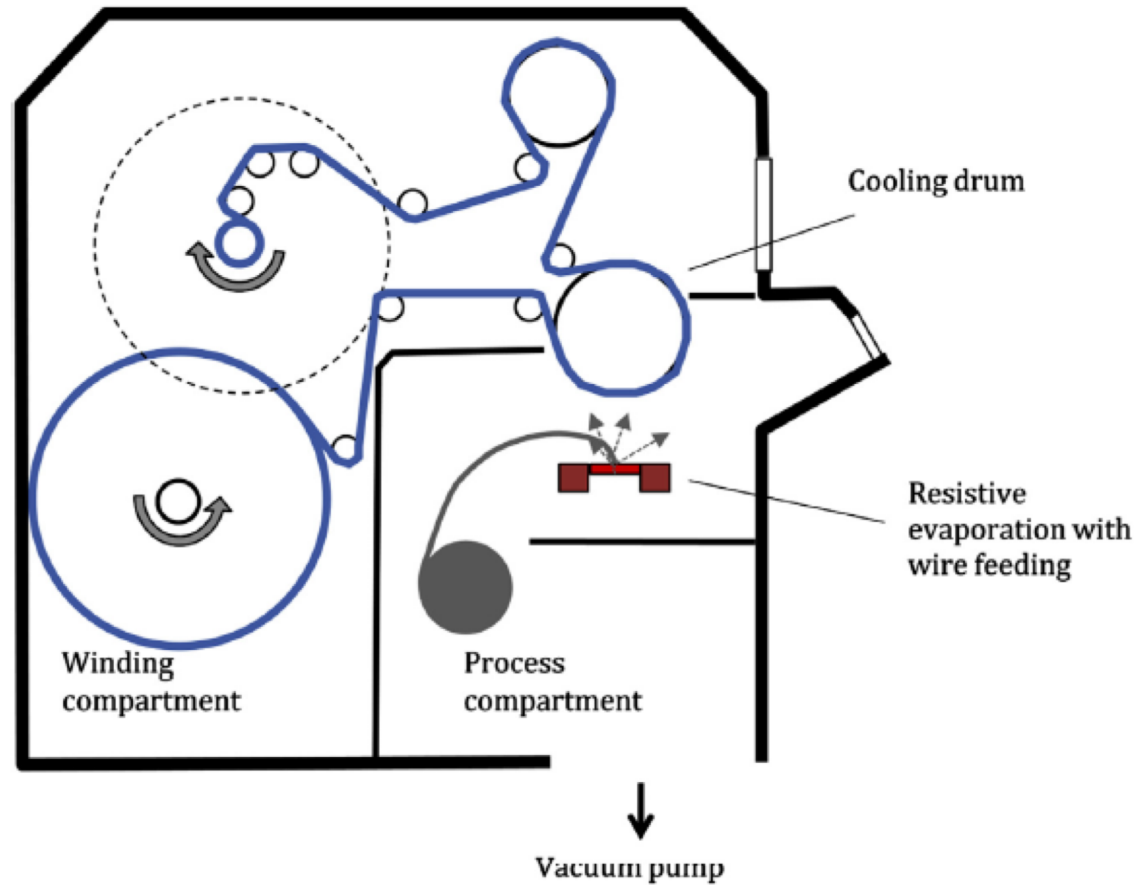
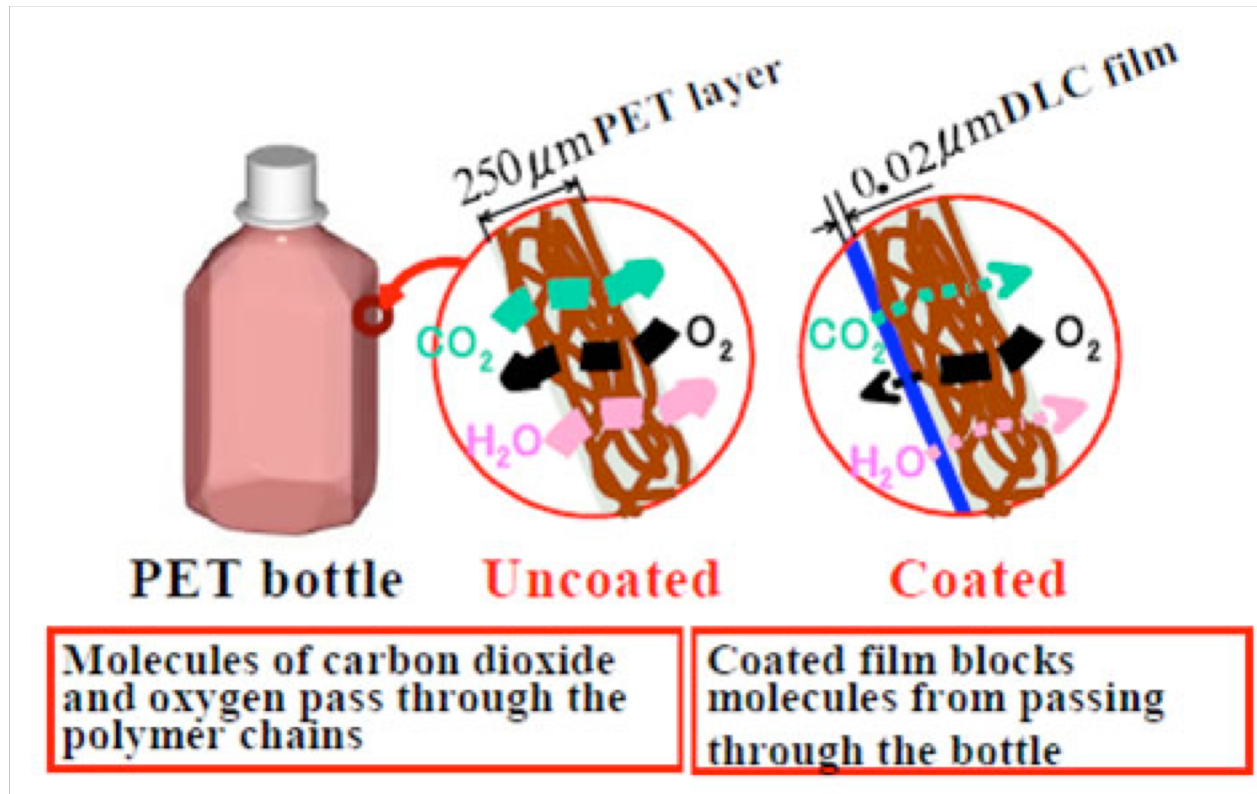

Figure 6 Schematic illustration of a web-coating device with thermal evaporation. After Ludwig, R.; Kukla, R.; & Josephson, E. Vacuum Web Coating – State of the Art and Potential for Electronics. *Proc. IEEE* 2005, 93 (8), 1483–1490.

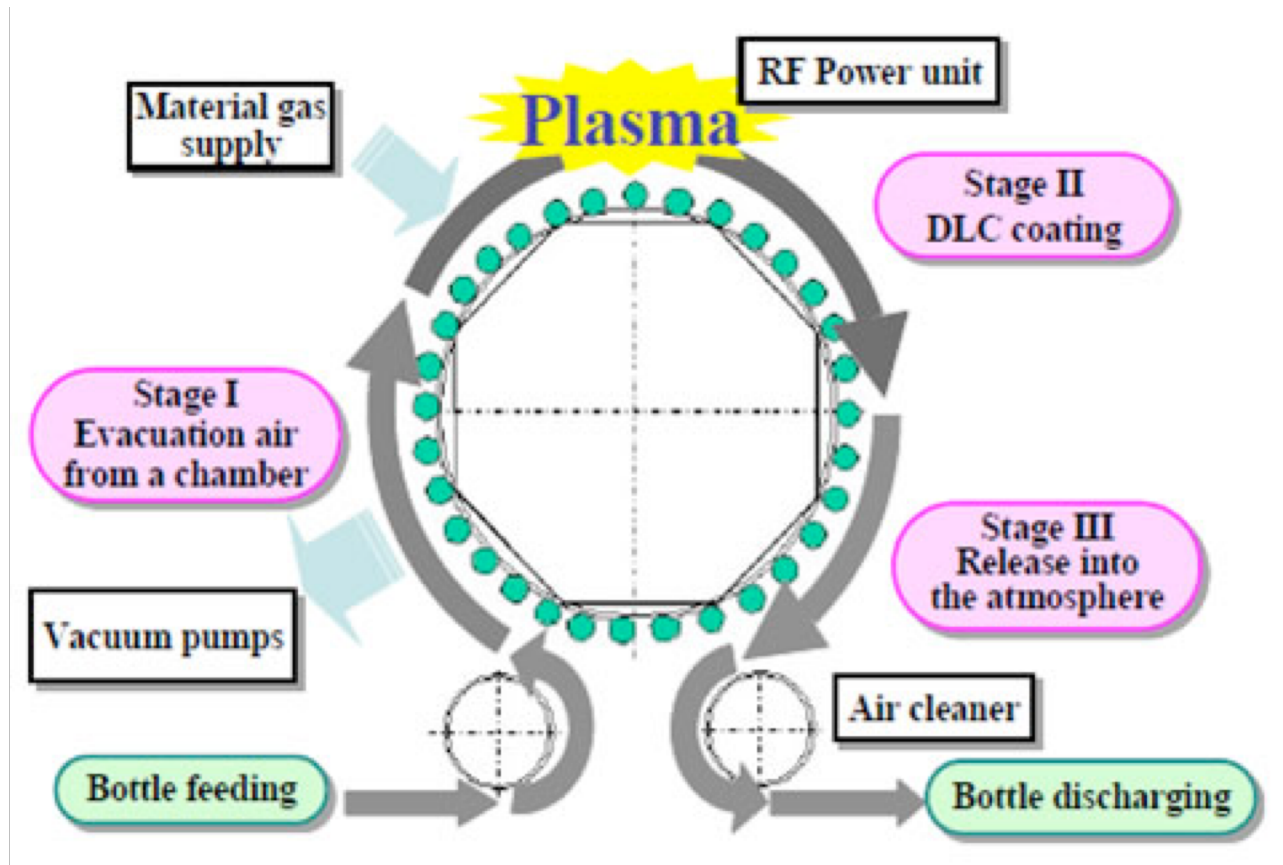

Figure 7 Array of aluminum evaporation. With permission of Leybold Optics GmbH.

Permeation



Title



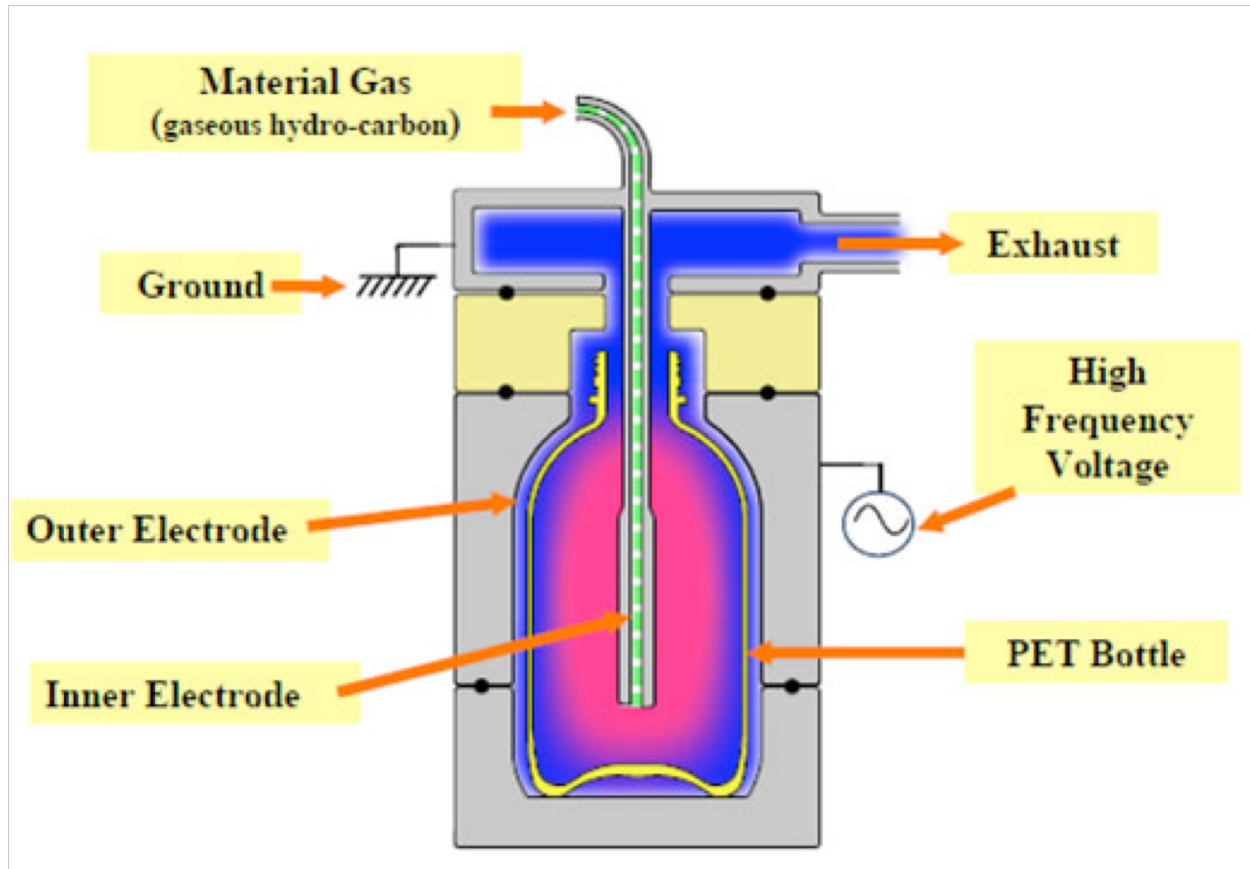

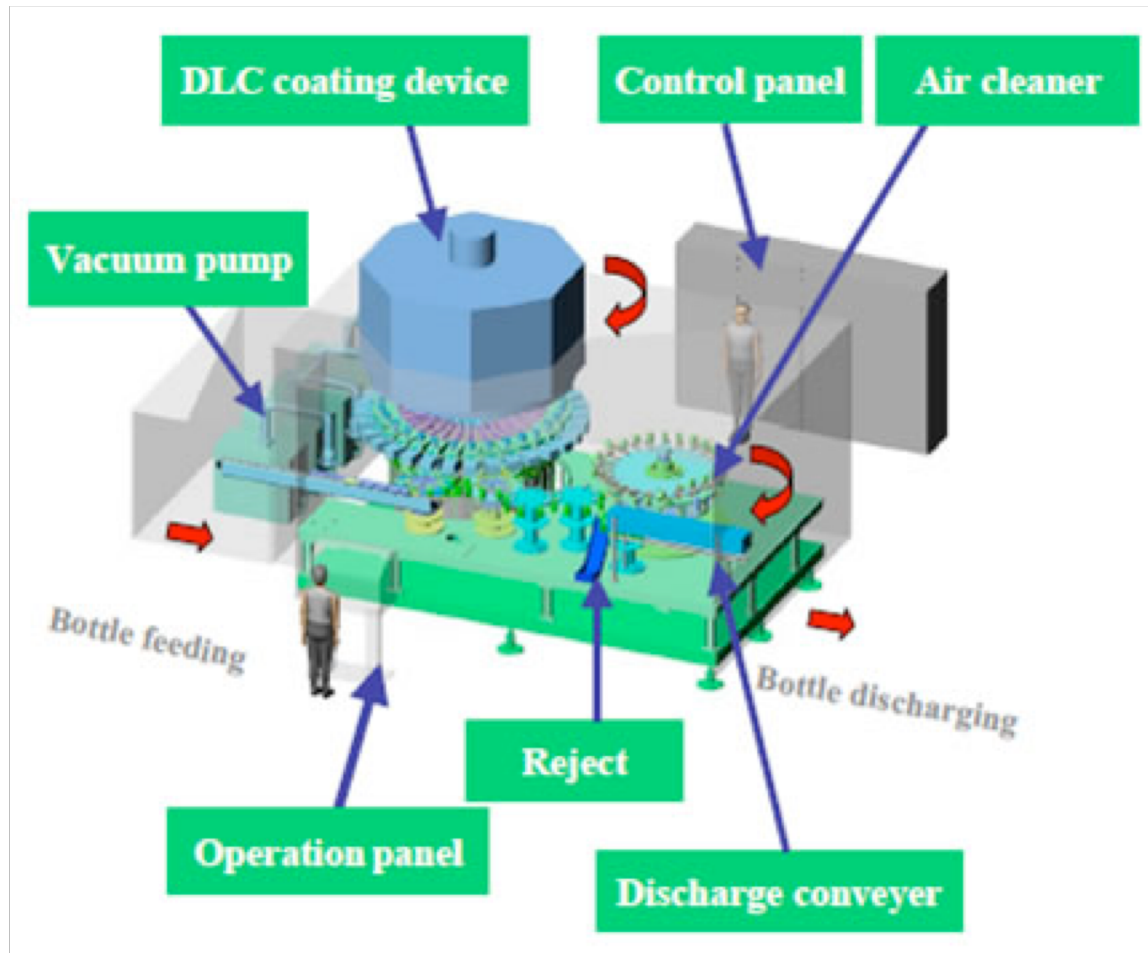

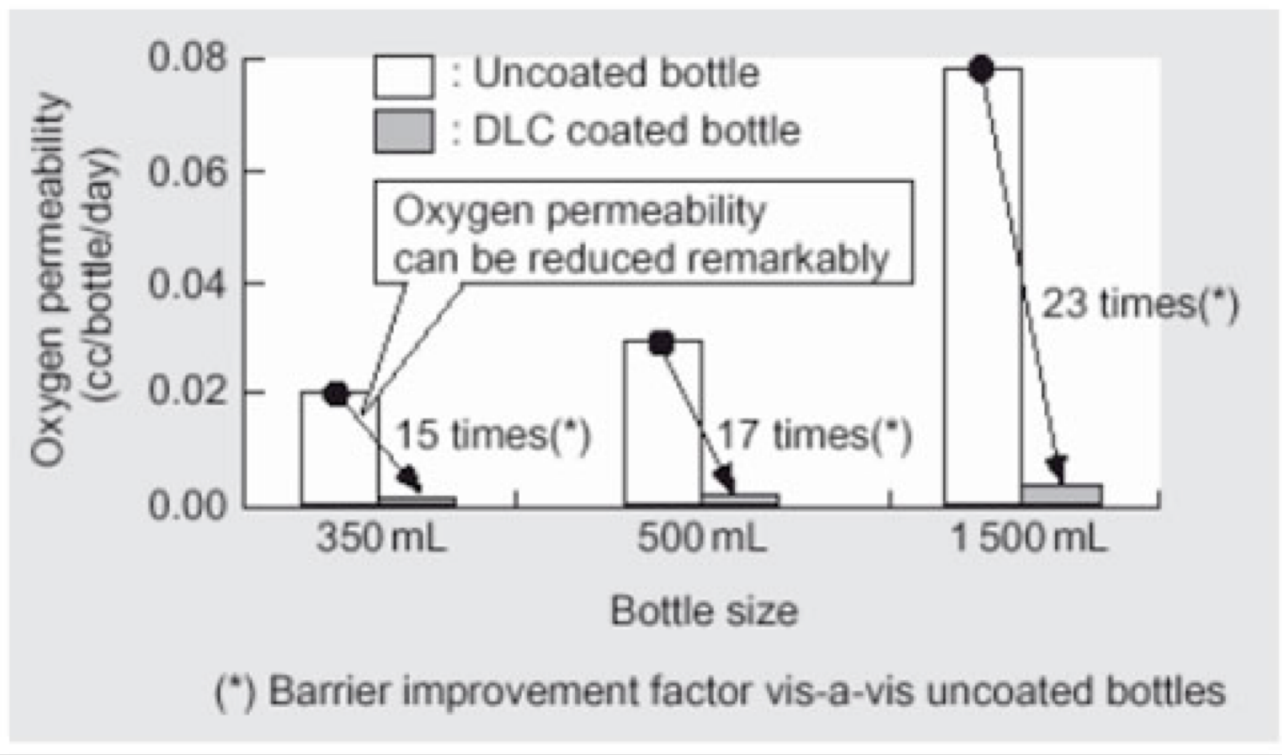

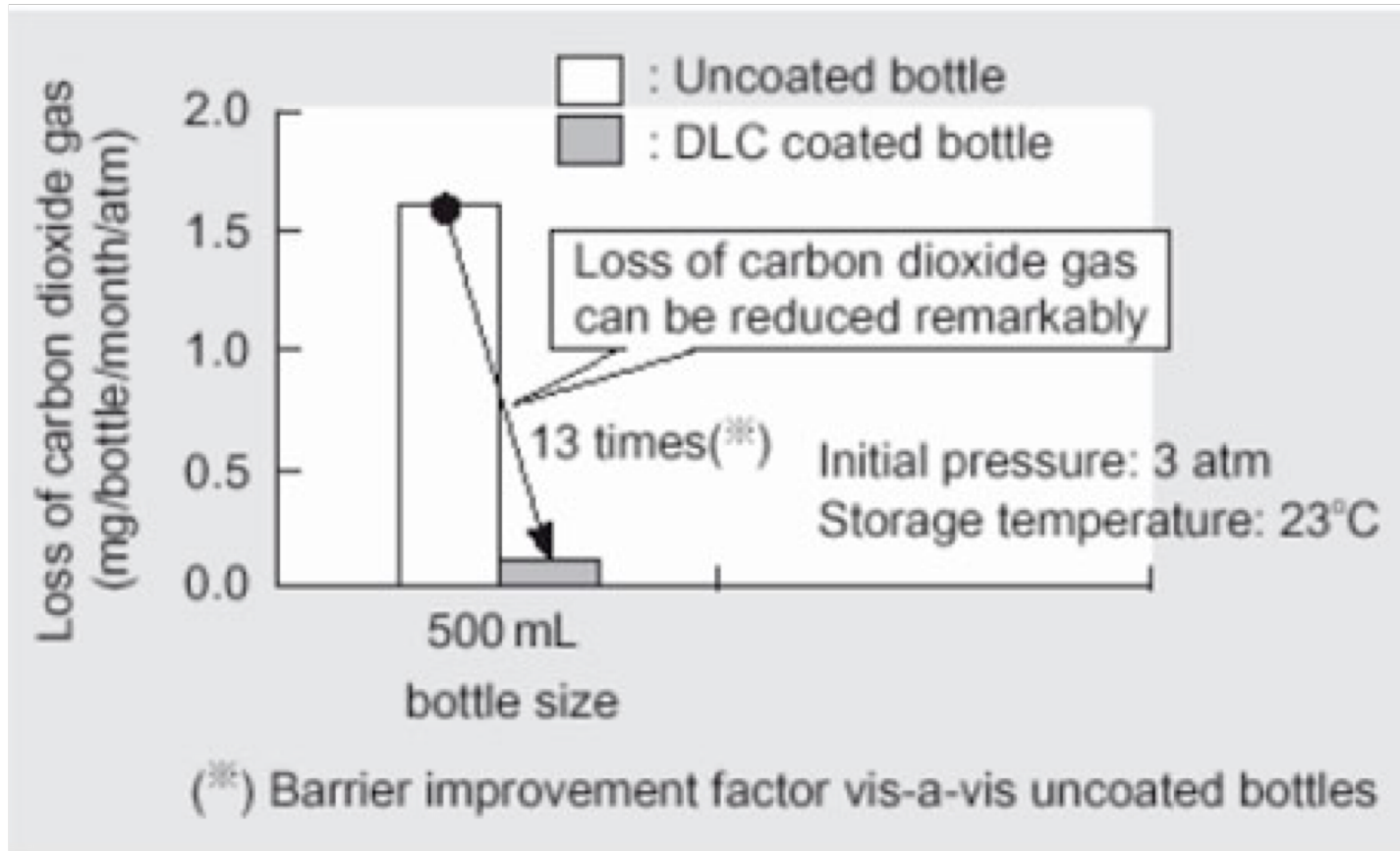

ALD barrier for OLED on polymer web

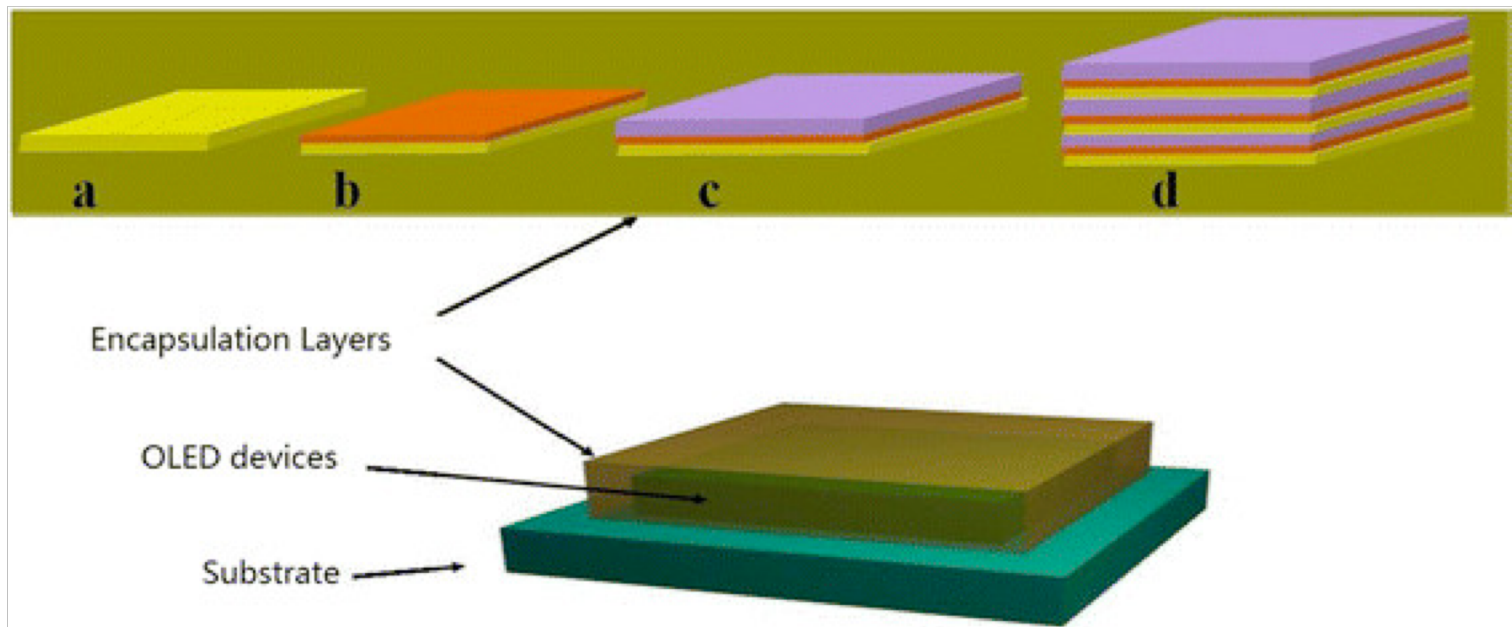

WVTR:

- $8.5 \times 10^{-5} \text{ g/m}^2/\text{day}$ at 25°C , 85% RH
- half lifetime 380 h luminance $1,500 \text{ cd/m}^2$ for a green organic light-emitting diode

ALD for encapsulation

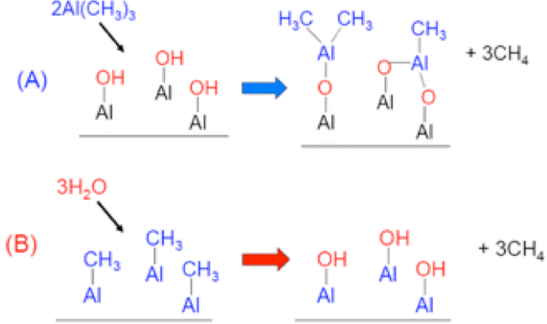

(a) The reaction of ALD processes for Al₂O₃ film

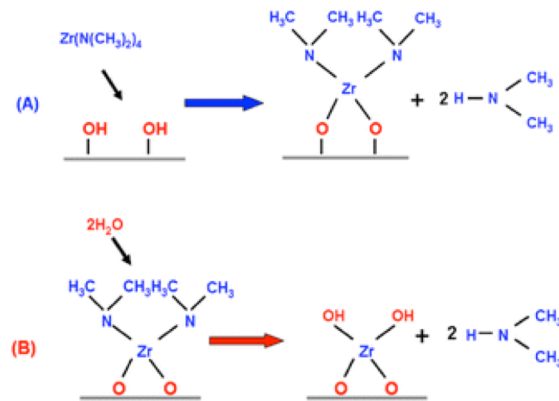

(b) The reaction of ALD processes for ZrO₂ film

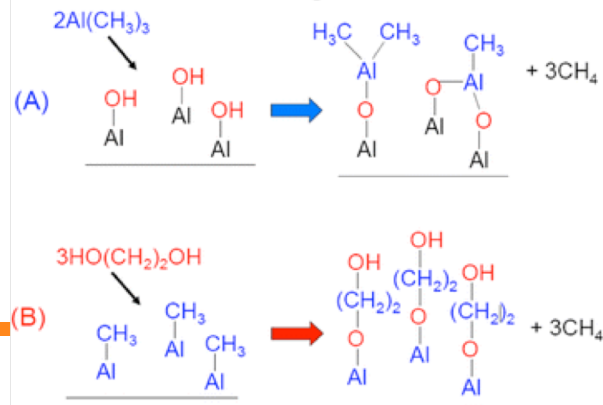

(c) The reaction of MLD processes for alucone film

Corrosion resistance

AlZ31 (Mg + Al 3wt%, Zn 1wt%) with MS Al 250nm

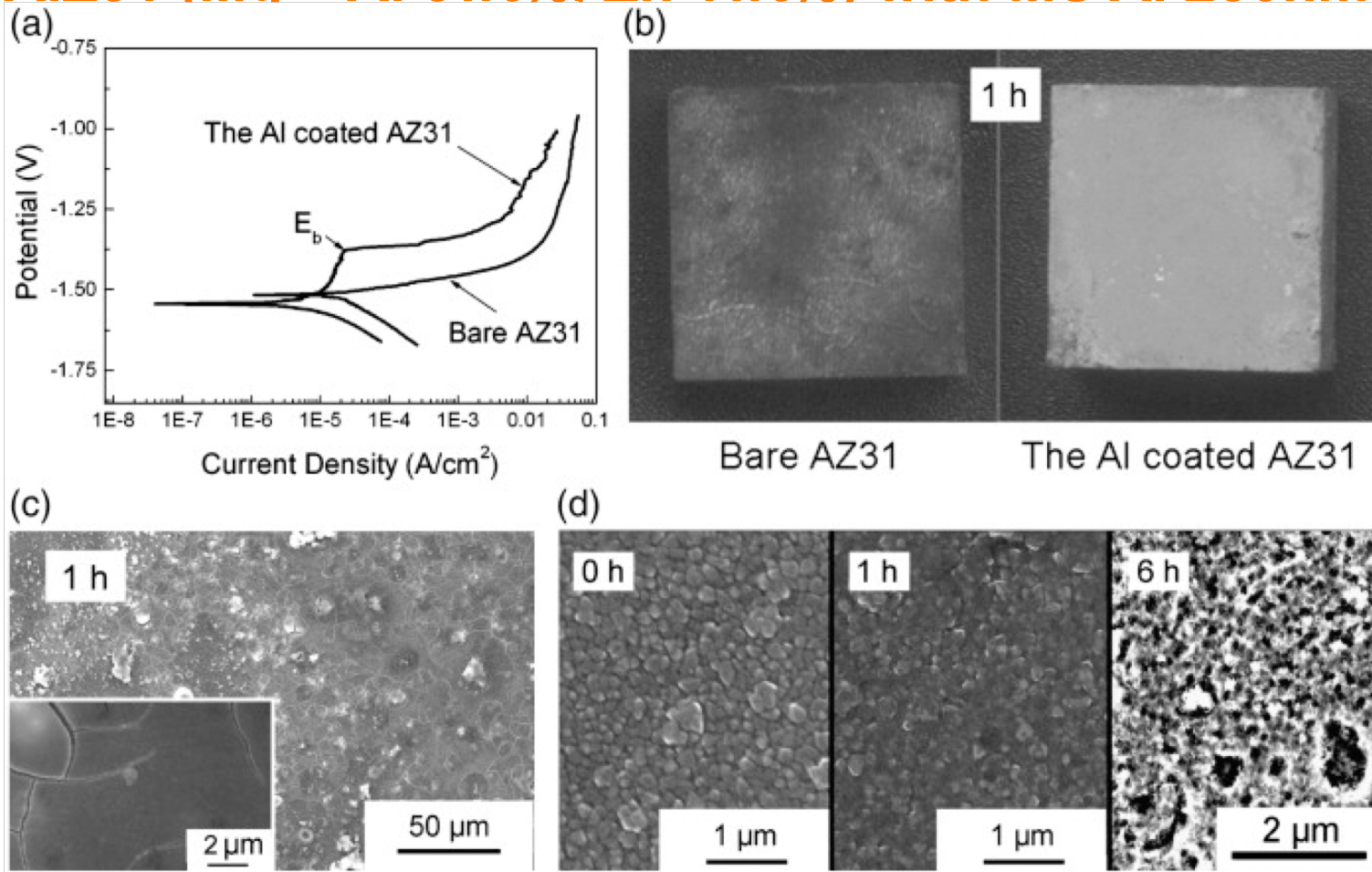
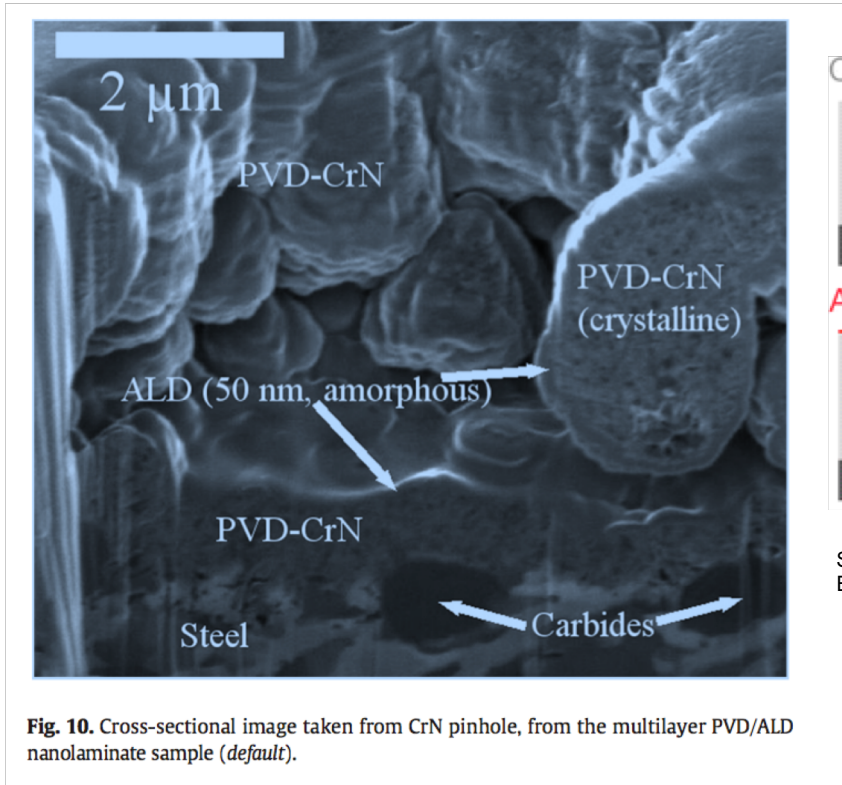

Fig. 2.

(a) Polarization curves of the coated AZ31 and bare AZ31. (b) Appearance of the samples after 1 h of immersion. (c) Surface morphology of the Al coated AZ31 observed by SEM after 1 h of immersion. The insert shows the morphology of the cracks. (d) Surface morphologies of the Al coated AZ31 observed by FESEM at a higher magnification after different immersion time (0 h, 1 h and 6 h).

Multilayer PVD MS CrN + ALD nanolaminate

- MS of Cr (Commercial Balinit CNI) 3 μm + ALD $\text{Al}_2\text{O}_3/\text{TiO}_2$ nanolaminate 50 nm



CrN coating on low alloy steel

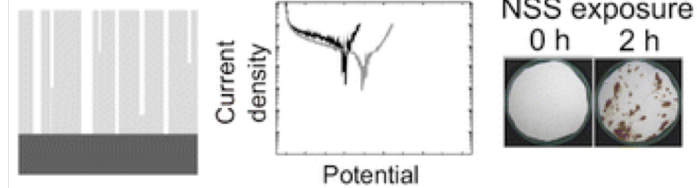

ALD Al_2O_3 - Ta_2O_5 nanolaminate sealed CrN coating on low alloy steel

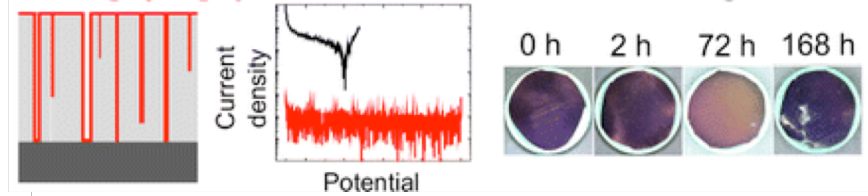

Sealing of hard CrN and DLC coatings with atomic layer deposition
E Härkönen, I Kolev, B Díaz... - ... applied materials & ..., 2014 - ACS Publications

Fig. 10. Cross-sectional image taken from CrN pinhole, from the multilayer PVD/ALD nanolaminate sample (default).

Leppäniemi, J. et al., 2017. Thin Solid Films. *Thin Solid Films*, 627, pp.59–68.

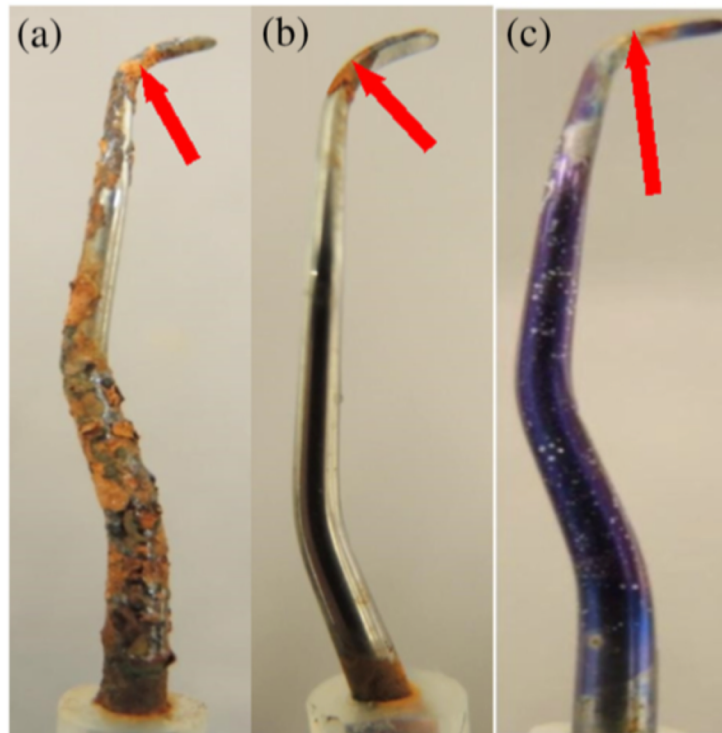
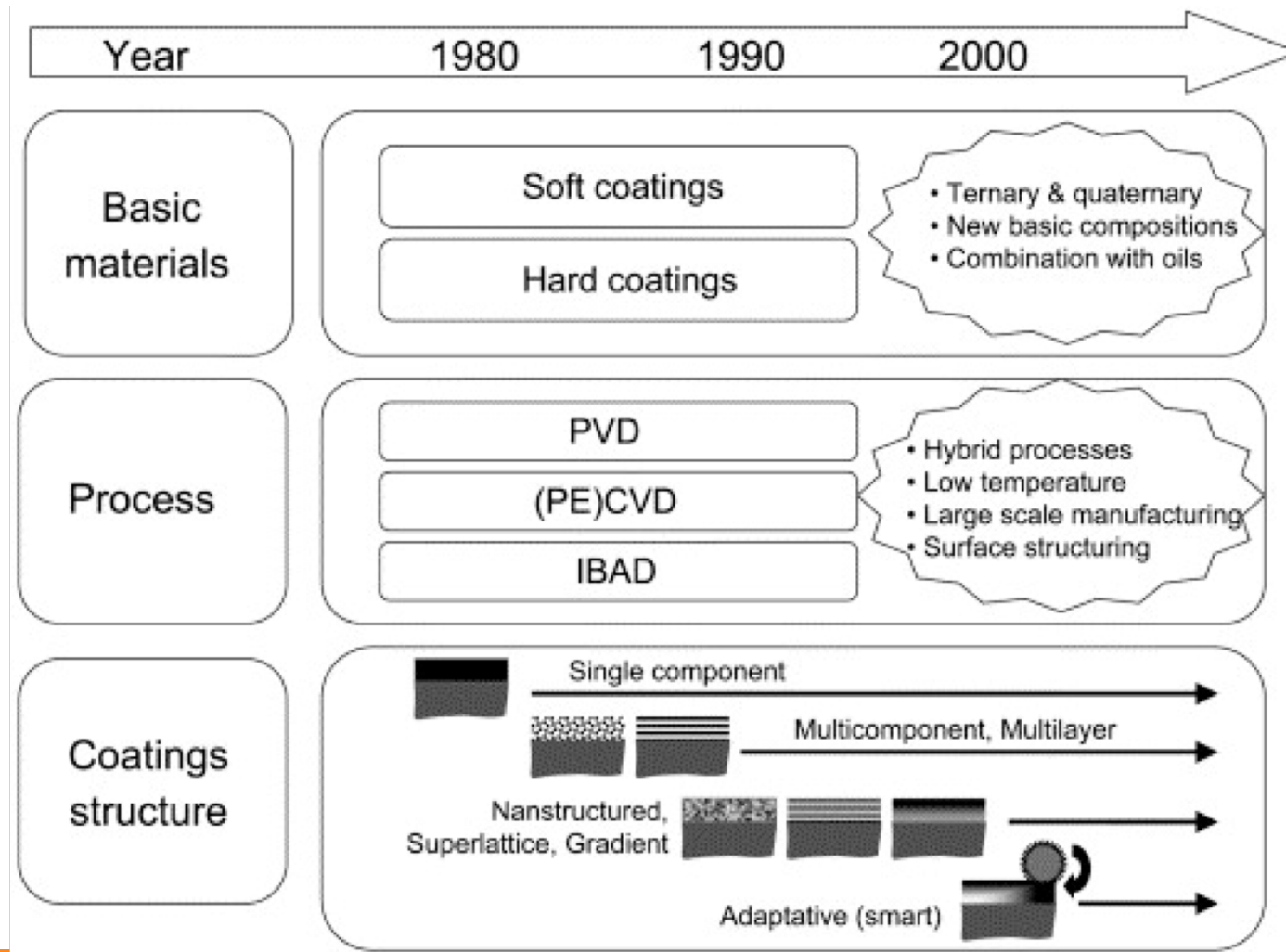

Fig. 9. HSS dental curettes after 48 h in NSS testing: a) non-coated b) CrN coated c) CrN/ALD-nanolaminate (default). Arrow denotes lateral surface of the curette, where the surface roughness of the tool is higher.

Solid lubricant thin films



Hard coatings Hardness higher than ≈ 10 GPa	Soft coatings Hardness lower than ≈ 10 GPa
<p>Nitrides TiN, CrN, ZrN, BN, BaSO₄</p> <p>Carbides TiC, WC, CrC</p> <p>Oxides Al₂O₃, Cr₂O₃, TiO₂, ZnO, CdO, Cs₂O, PbO, Re₂O₇</p> <p>Borides TiB₂</p> <p>DLC & Diamond a-C, ta-C, a-C:H, ta-C:H, CN_x a-C:X(:H), (nc-)diamond</p>	<p>Soft metals Ag, Pb, Au, In, Sn, Cr, Ni, Cu</p> <p>Lamellar solids MoS₂, WS₂, Graphite H₃BO₃, HBN, GaS, GaSe</p> <p>Halides sulfates, sulfur CaF₂, BaF₂, PbS, CaSO₄, BaSO₄</p> <p>Polymers PTFE, PE, Polyimide Polymerlike DLC</p>

DLC = diamondlike carbon

a= amorphous

ta = tetrahedral amorphous

X = a metal

nc = nanocrystalline

PTFE = polytetrafluoroethylene

PE = polyethylene

Figure 2. Classification of tribological coatings, depending on the nature of the constituting material.