

Advanced application of Thin Films part 1

Jari Koskinen

Function and utility

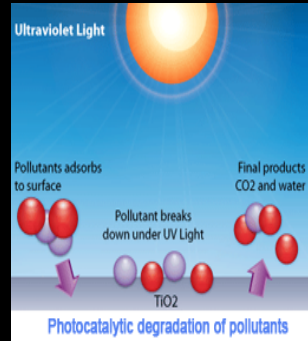

Titanium Dioxide: Photocatalytic activity

Optical systems, optical MEMS

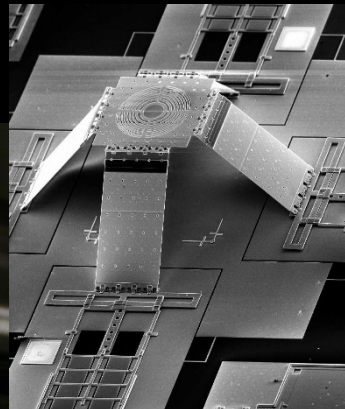
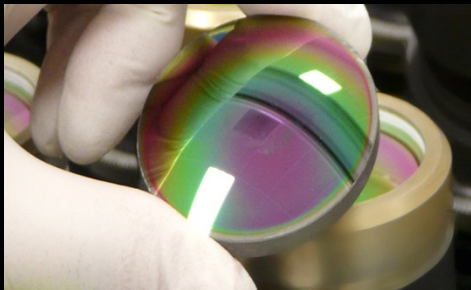

Indium Tin Oxide, ITO:
Defrosting coating

Microelectromechanical systems, MEMS

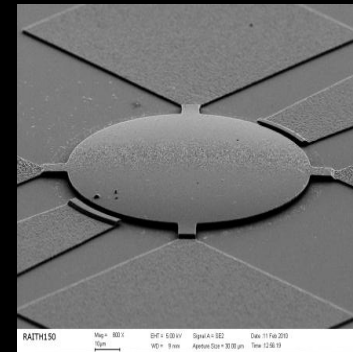

Applications of thin films

- **Photo voltaic**
- **Energy harvesting (piezo)**
- **Optical coatings**
 - Tunable transmission
- **Magnetic Films for Data Storage**
 - Magnetic discs
- **Sensors**
 - Gas sensors
 - Electro chemical sensors
- **Photocatalytic thin films**

Solar PV large area, decorative



Solar Cell Technologies

- Crystalline Silicon solar cells
 - Single, Multi, Ribbon
- • Thin Film solar cells
 - Silicon, Cu_2S , a-Si, m-Si, n-Si, CdTe, CIGS, CNTS
- • Concentrating solar cells
 - Si, GaAs
- • Dye, Organic, Hybrid & other emerging solar cells
- • New Ideas

Spectral response of solar cells

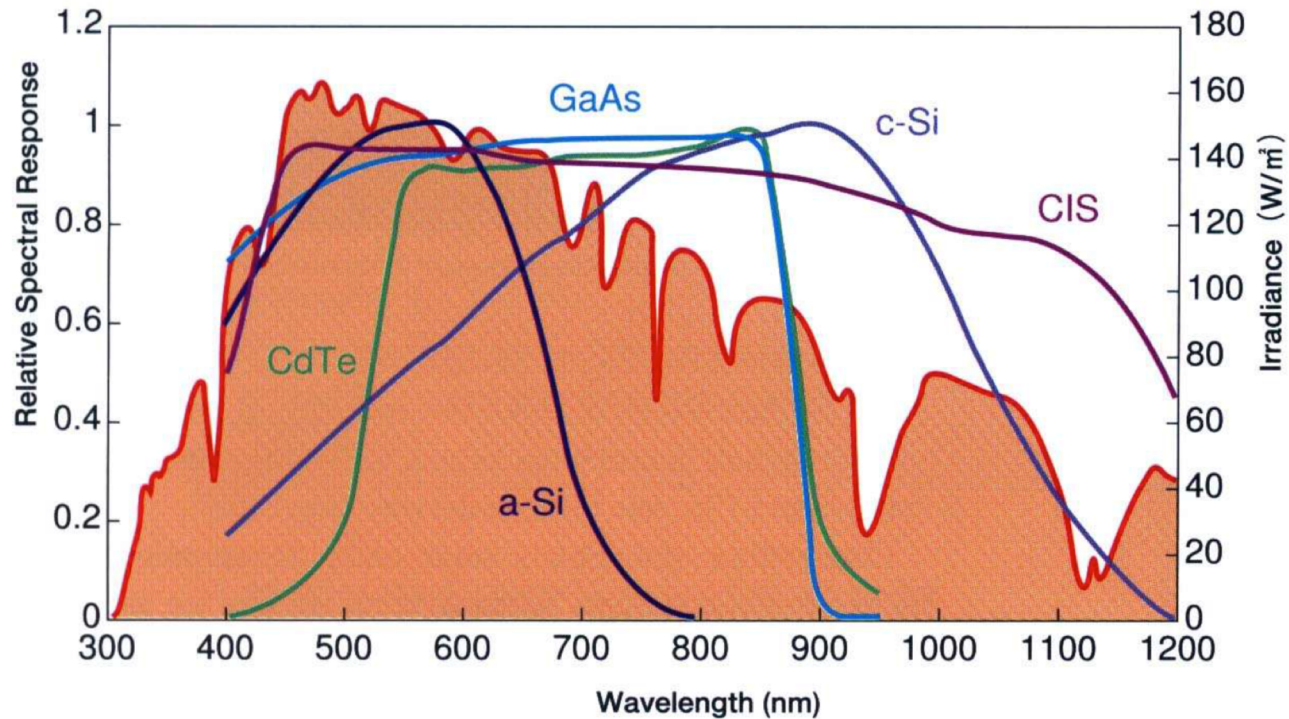

Source: unknown

Laboratory for Thin Films and Photovoltaics:
Courtesy: Avodhya Tiwari



Swiss Federal Laboratories for Material Testing and Research

Best Research-Cell Efficiencies

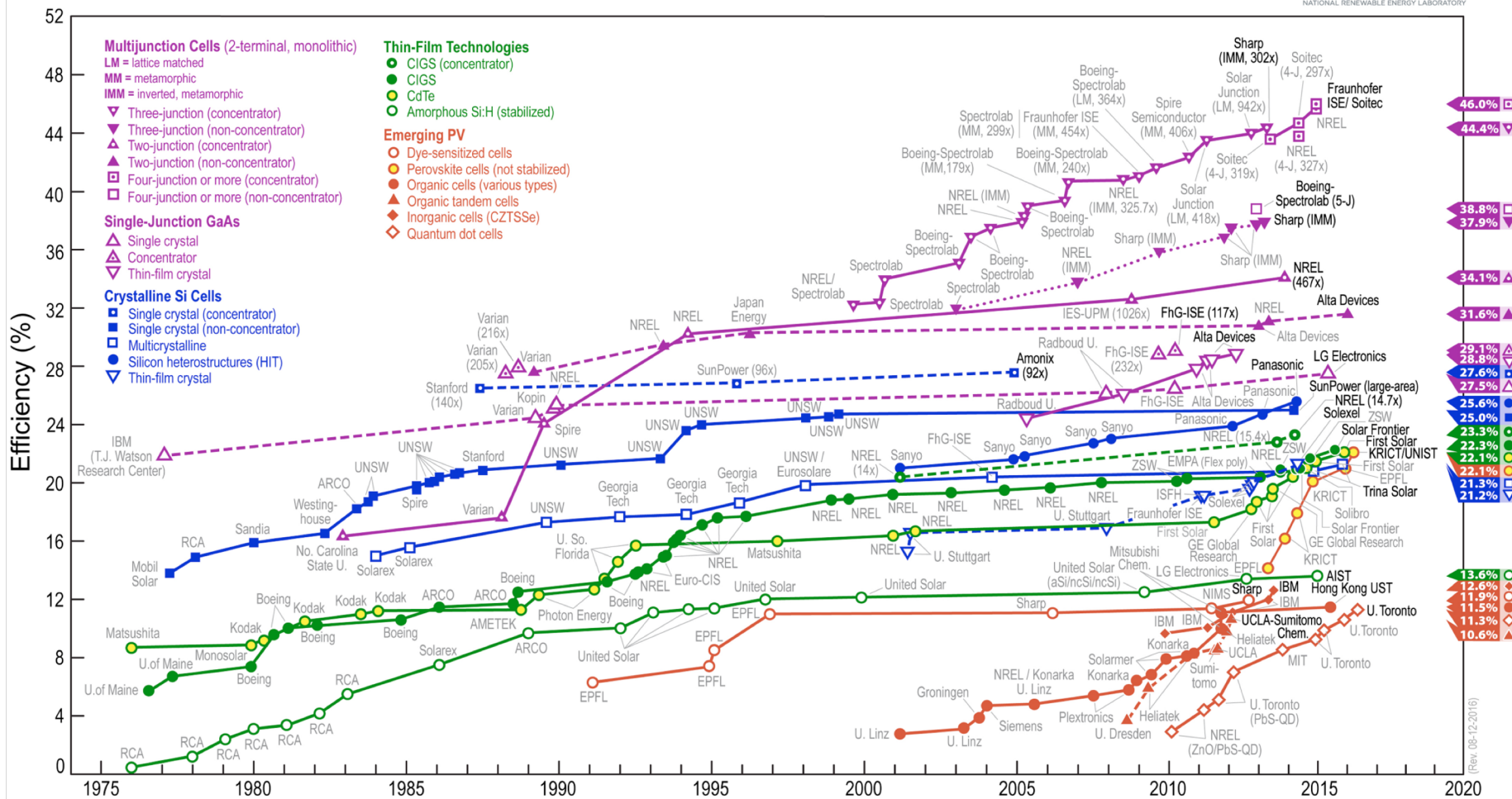

wiki

Solar module production for different technologies

CIGS is emerging with about 1% share

CdTe is leading with over 6% share

a-Si:H: About 5% share

C-Si dominates with ~ 90% share

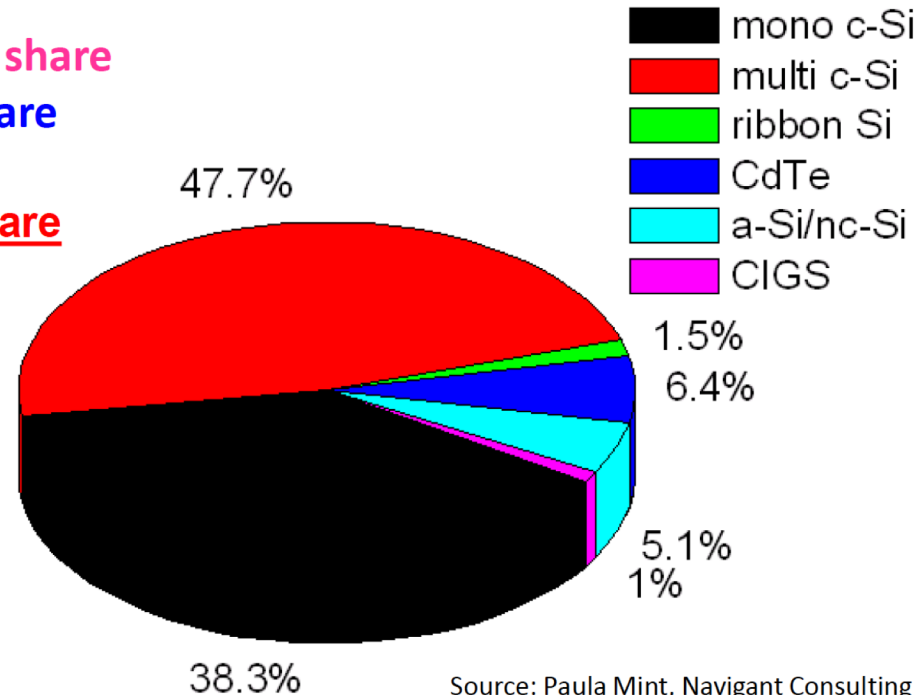

EPIA expects thin film shares will grow:

20% in 2010 with about 4 GW

25% in 2013 with about 9 GW

Why thin film solar cells?

- **SMALL THICKNESS REQUIRED DUE TO HIGH ABSORPTION, SMALL DIFFUSION LENGTH & HIGH RECOMBINATION VELOCITY**
- **MATERIALS ECONOMY, VERY LOW WEIGHT PER UNIT POWER**
- **VARIOUS SIMPLE & SOPHISTICATED DEPOSITION TECHNIQUES**
- **A VARIETY OF STRUCTURES AVAILABLE : AMORPHOUS, POLYCRYSTALLINE, EPITAXIAL**
- **TOPOGRAPHY RANGING FROM VERY ROUGH TO ATOMICALLY SMOOTH**
- **DIFFERENT TYPES OF JUNCTIONS POSSIBLE –HOMO, HETERO, SCHOTTKY, PEC**
- **TANDEM AND MULTI JUNCTION CELLS POSSIBLE**
- **IN-SITU CELL INTEGRATION TO FORM MODULES**
- **COMPATIBILITY WITH SOLAR THERMAL DEVICES**

Thin Film CIGS, CdTe, a-Si Solar Cells

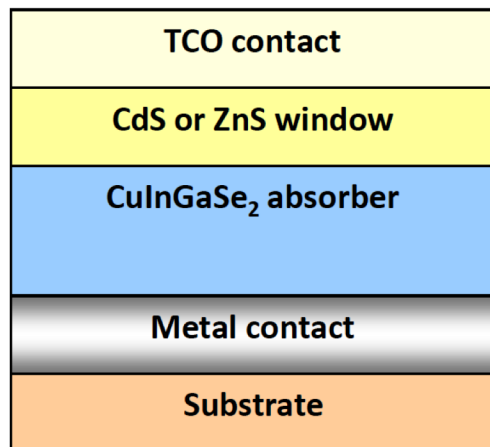

Highest: 20.3%

Cell area: ~0.5 cm²

Typical range:

Cells: 12% - 20%

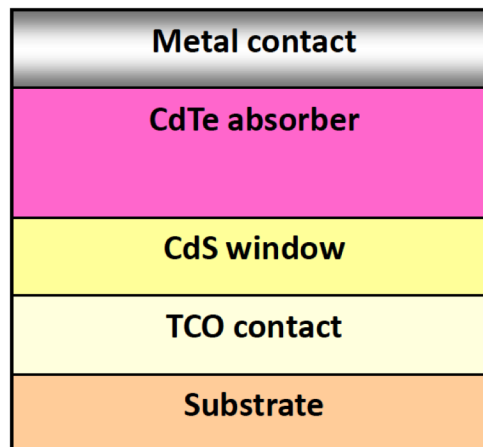

Highest: 16.5%

Cell area: ~1 cm²

Typical range:

Cell: 10% - 16.5%

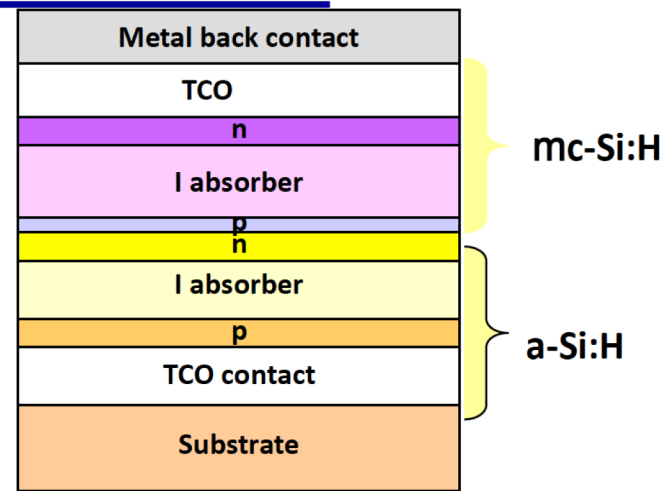

Highest: 13.3%

Cell area: ~0.25 cm²

Typical range:

Cell: 8% - 13.3%

Lower efficiency of large area solar modules

Module: 8% - 13.5%

Module: 9% - 11%

Module: 4% - 9%

Highest: 15% - 16%

Highest: 11.5%

Highest: 10.3%

Roll-to-roll CIGS solar module production concept

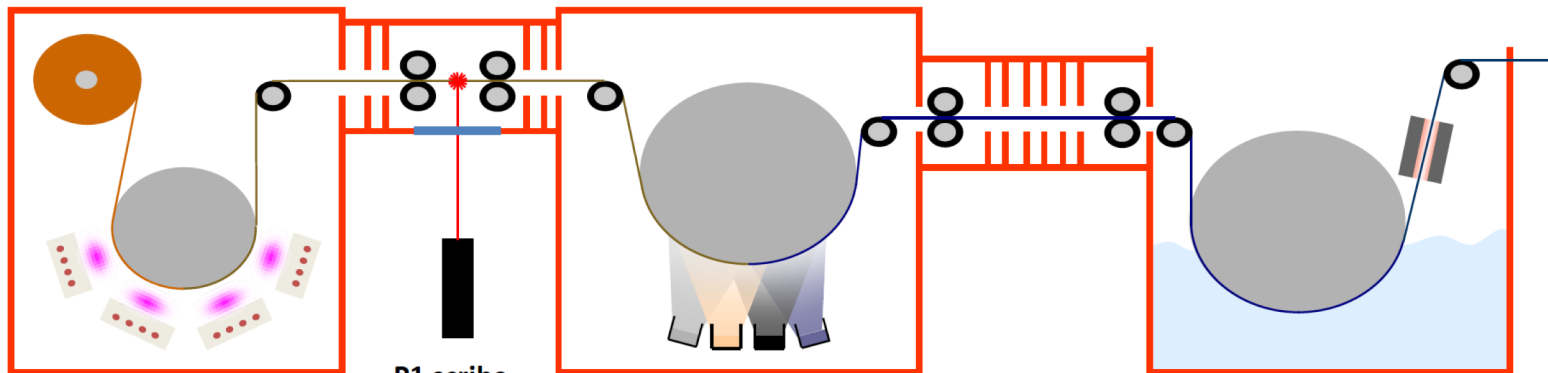

Mo sputter deposition for back contact

P1 scribe pressure reduction

CIGS absorber layer

pressure adjustment

Chemical bath deposition for buffer layer

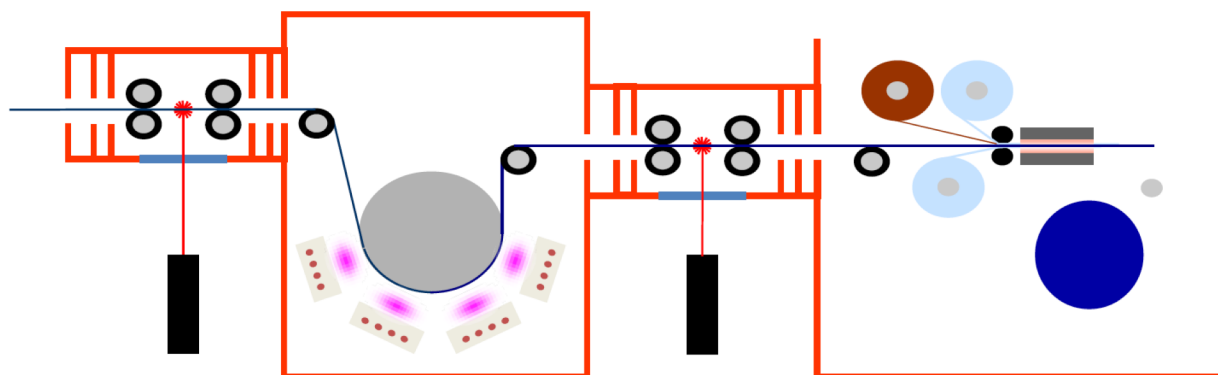

P2 scribe pressure reduction

ZnO/ZnO:Al sputter deposition for front contact & anti reflection layer

P3 scribe pressure adjustment

electrical contacts lamination & protection

Challenge:

Transfer of static deposition processes to dynamic deposition on moving foils

Thermal mismatch induced stress



NANOSOLAR

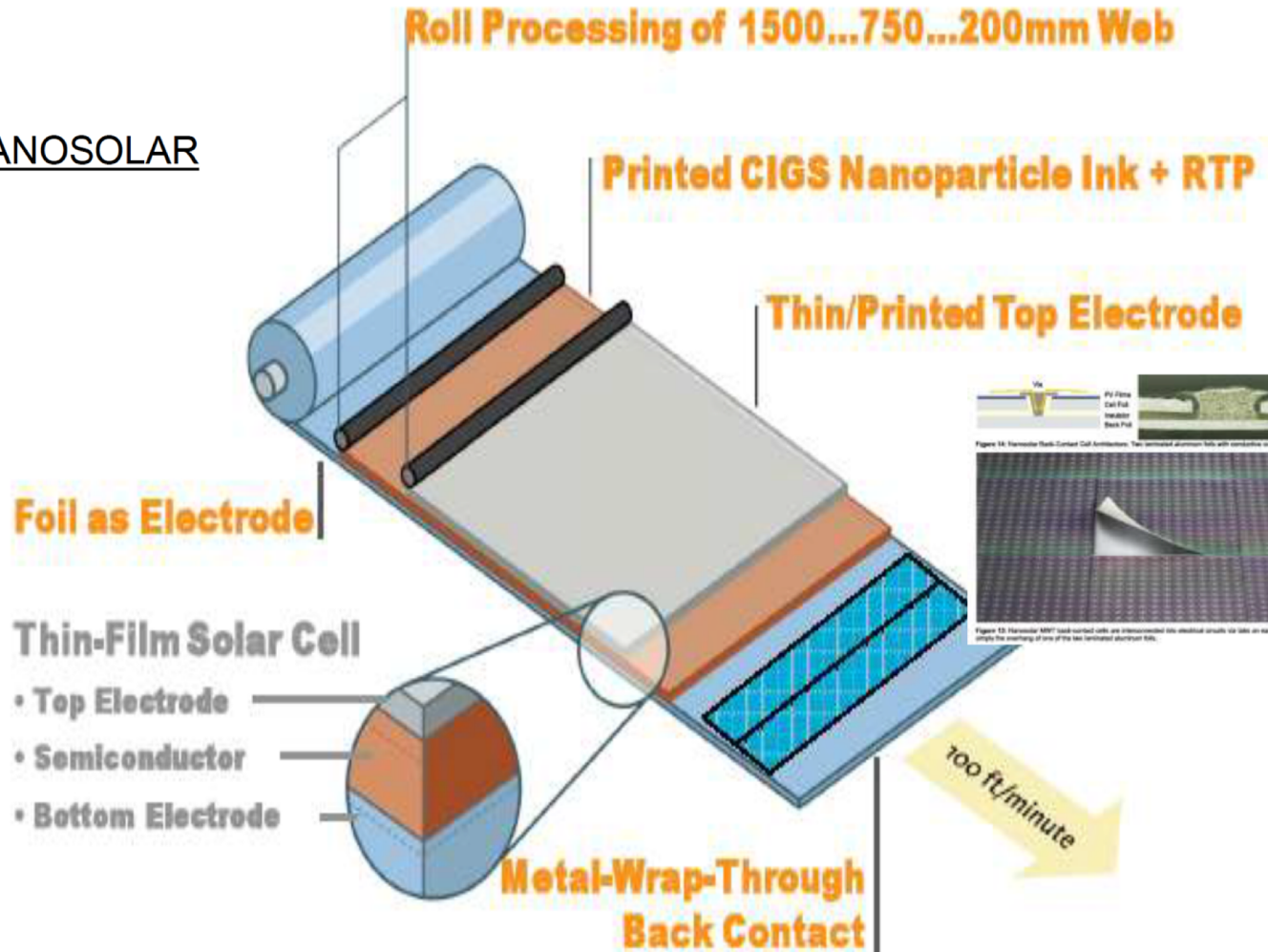
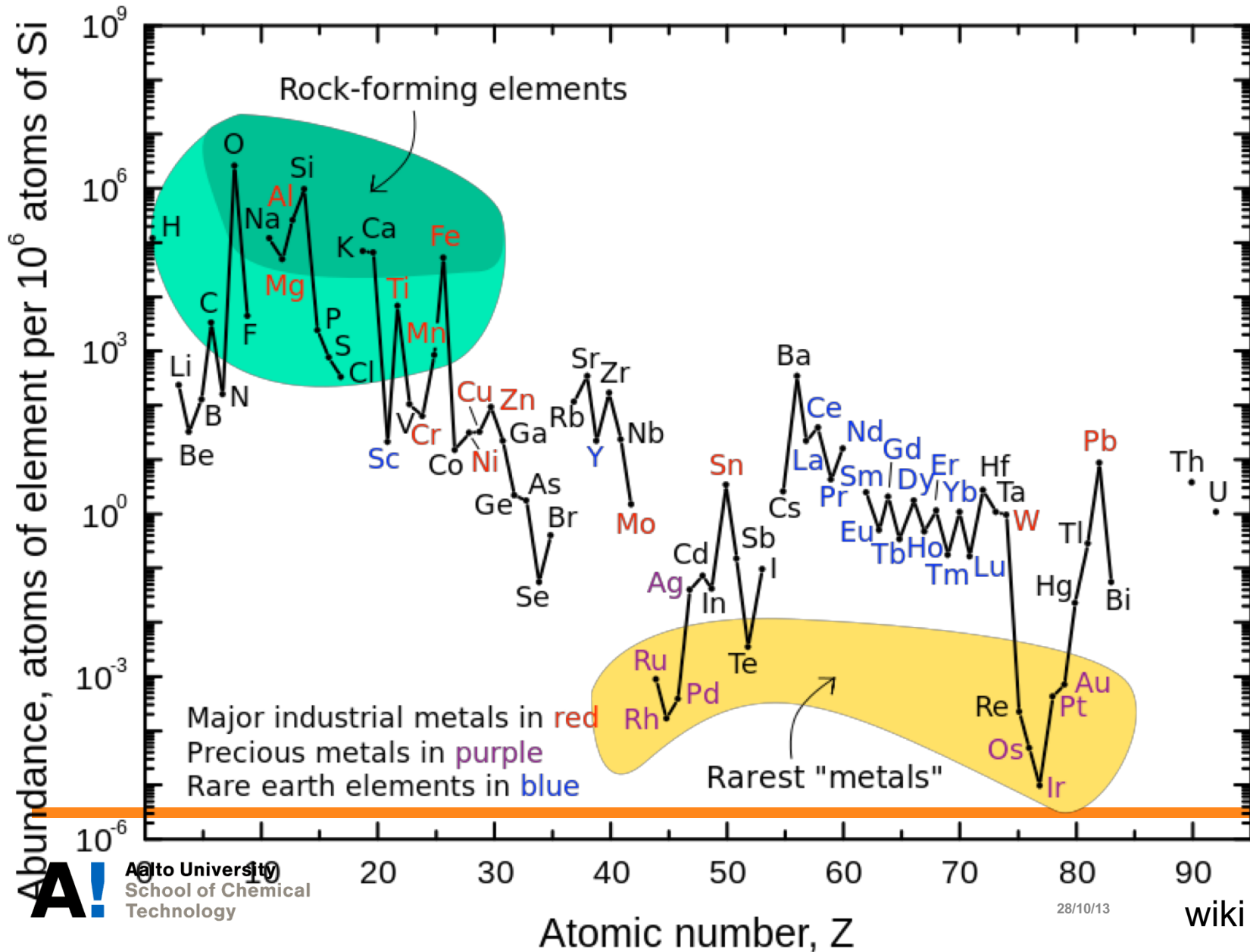
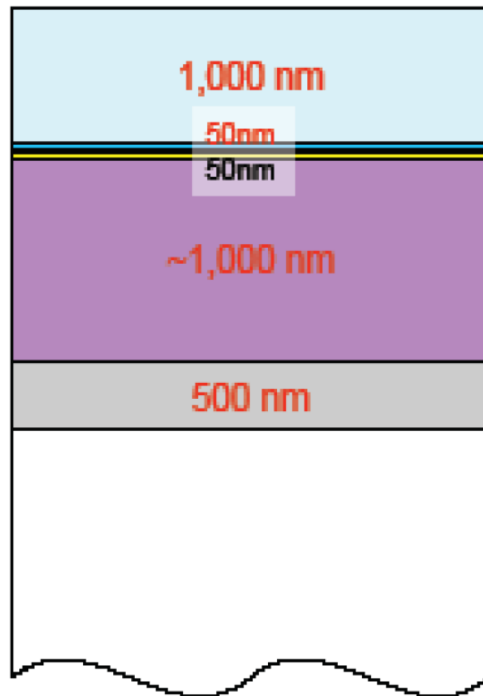

Figure 1: Nanosolar combines a host of innovations to deliver a distinct overall cost reduction.

Rare earth elements



State-of-the-Art CIGS-on-Glass



Nanosolar CIGS-on-Al

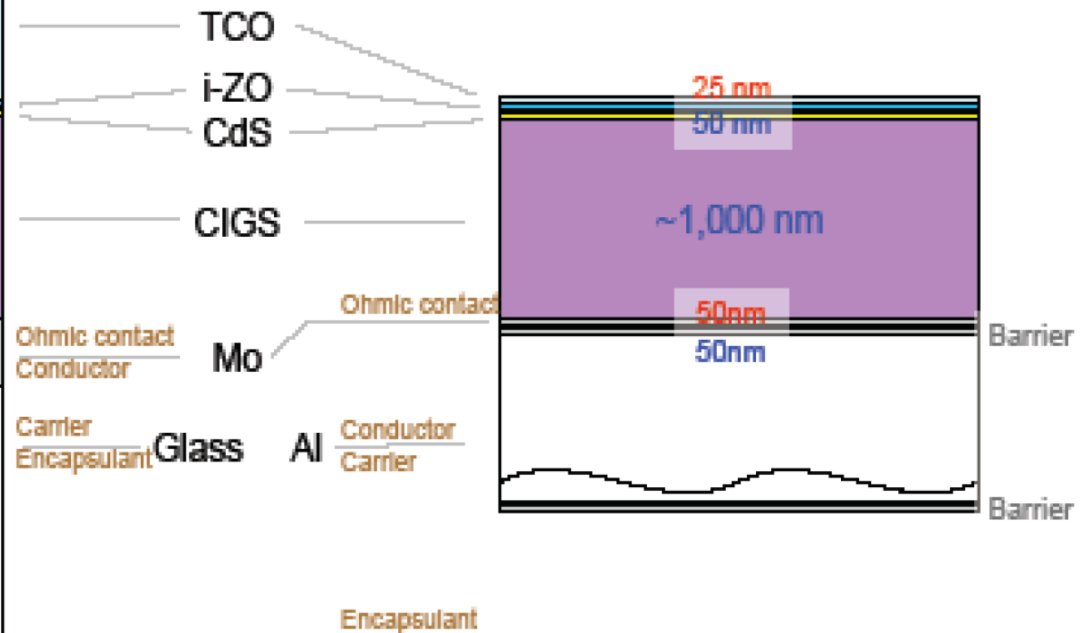

Thin Films: High-Vacuum / Non-Vacuum

Figure 4: Comparison of State-of-the-Art CIGS versus Nanosolar's CIGS-on-Aluminum. Thickness numbers in red indicate depositions using a high-vacuum deposition technique. The state-of-the-art stack requires close to 3000nm of high-vacuum processing whereas Nanosolar's stack requires less than a tenth of that.