

Nonlinear dynamics & chaos

Chaos in 3D:
Lorenz Equations

Lecture VIII

Recap

Bifurcations in 2D

Ones that have corresponding bifurcations in 1D:

- saddle-node
- transcritical
- supercritical and subcritical pitchfork

These all are zero-eigenvalue bifurcations: They occur at $\Delta = 0$, which means that one of the eigenvalues must be zero ($\Delta = \lambda_1 \lambda_2$).

Recap

New kind of bifurcation occurring only in $D \geq 2$:

Hopf bifurcation. Complex conjugate eigenvalue pair passes through $Re(\lambda) = 0$.

In 3D there's something weird lurking here.

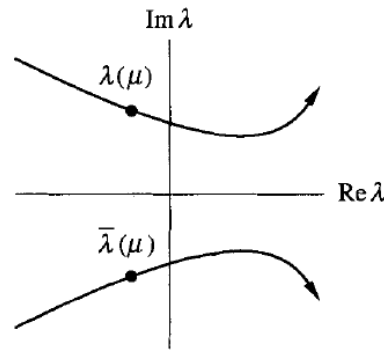

Supercritical

Subcritical (hysteresis)

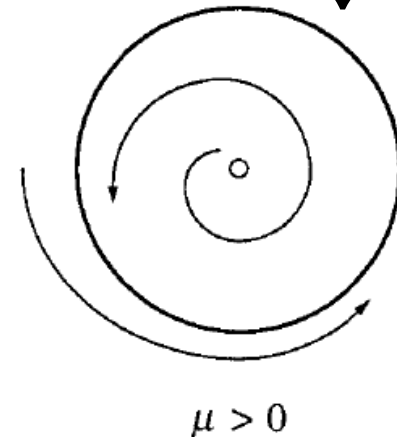
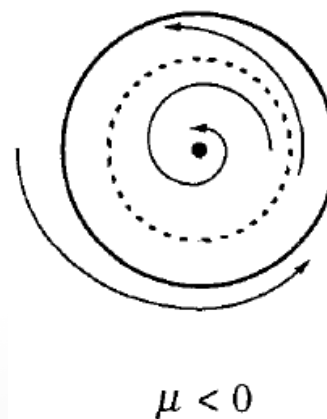
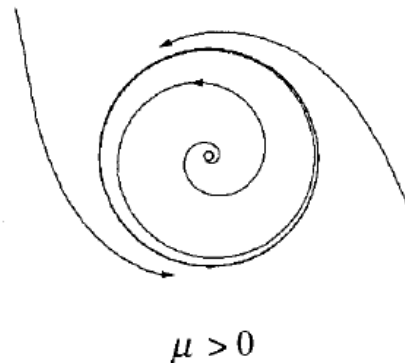
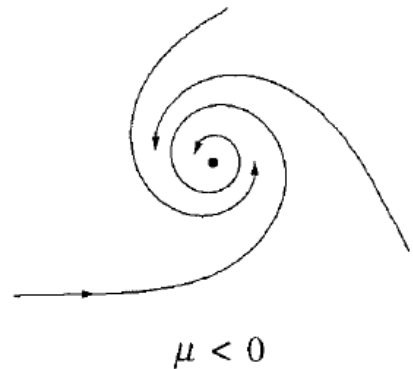

Part III: Chaos



In 3D

Lorenz Equations

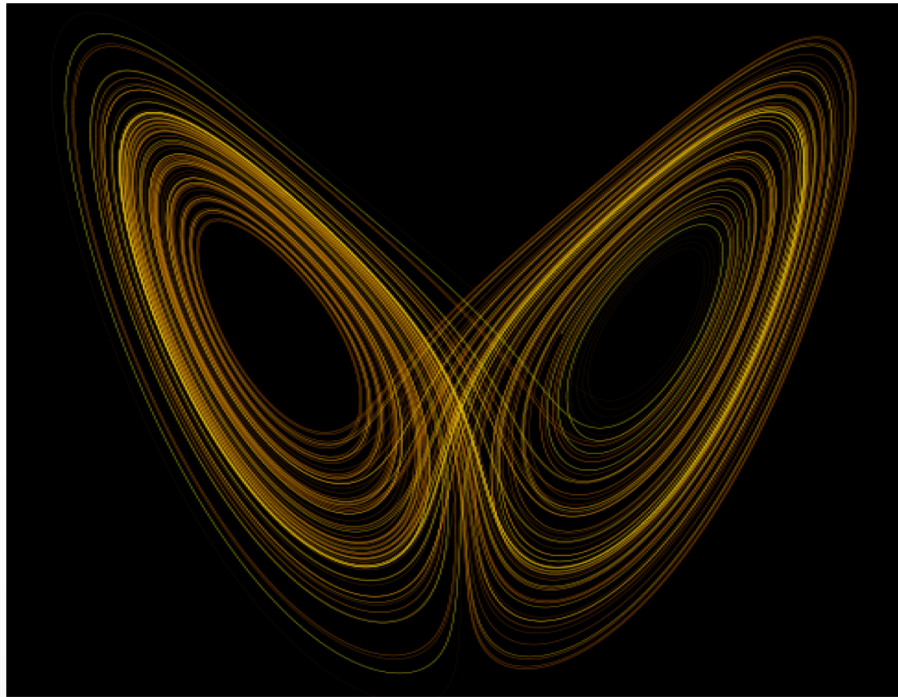

Introduction

Lorenz equations

$$\begin{aligned}\dot{x} &= \sigma(y - x) \\ \dot{y} &= rx - y - xz \\ \dot{z} &= xy - bz \quad \sigma, r, b > 0\end{aligned}$$

Ed Lorenz (1963) derived these equations from a simplified model of **convection rolls** in the atmosphere.

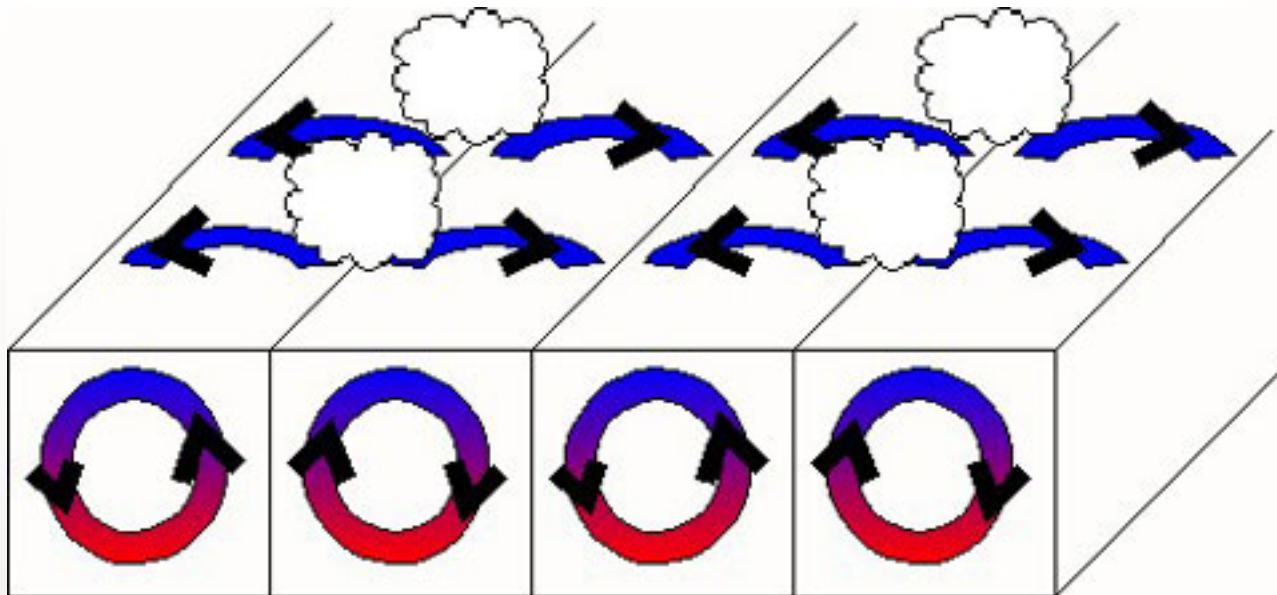

Introduction

Lorenz equations

$$\begin{aligned}\dot{x} &= \sigma(y - x) \\ \dot{y} &= rx - y - xz \\ \dot{z} &= xy - bz \quad \sigma, r, b > 0\end{aligned}$$

In his numerical solutions Lorenz discovered **erratic dynamics**: over a wide range of parameters, the solutions oscillate irregularly, never exactly repeating but always remaining in a bounded region of phase space.

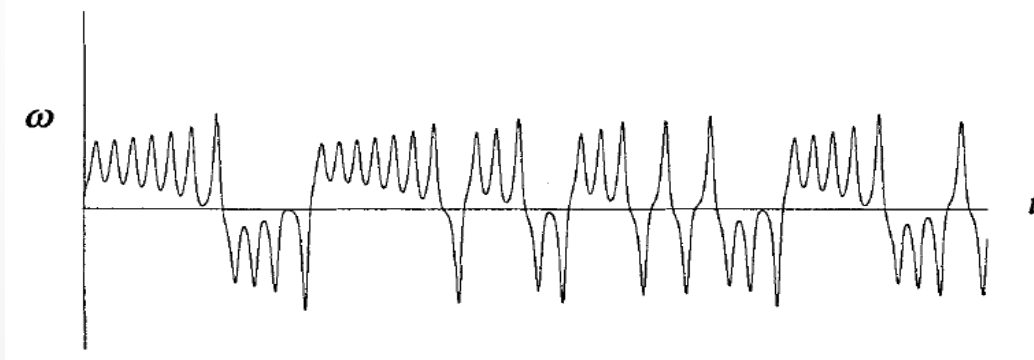

Trajectories settle onto a complicated set, a **strange attractor**, whose *fractal dimension* is between 2 and 3.

Fractal Dimension d

Completely space-filling objects, $d = D = 1, 2,$ or 3 . d is an integer.

Partly space-filling objects, $d < D$. d is a non-integer.

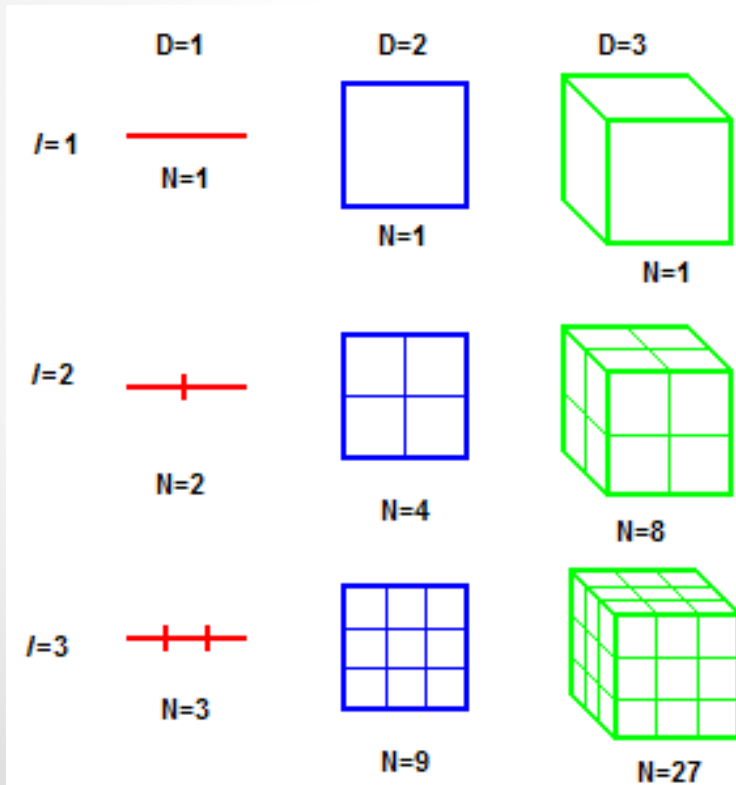
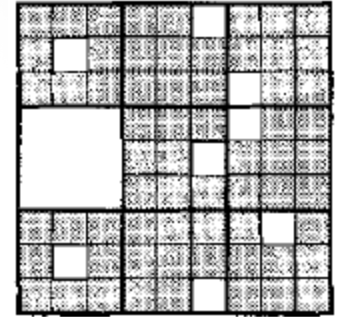

Strange Attractor

... is not a point or a curve or even a surface.

It is a fractal, whose dimension is $2 < d < 3$.

No wonder that Lorenz in the year of the Beatles , 1963, was puzzled by what he was witnessing when solving his equations numerically.

But the gate was about to be opened...



The Butterfly

Lorenz's finding turned the realm of dynamics from a caterpillar...
...into a butterfly.

Many people have seen the plot. Not that many know what it means.

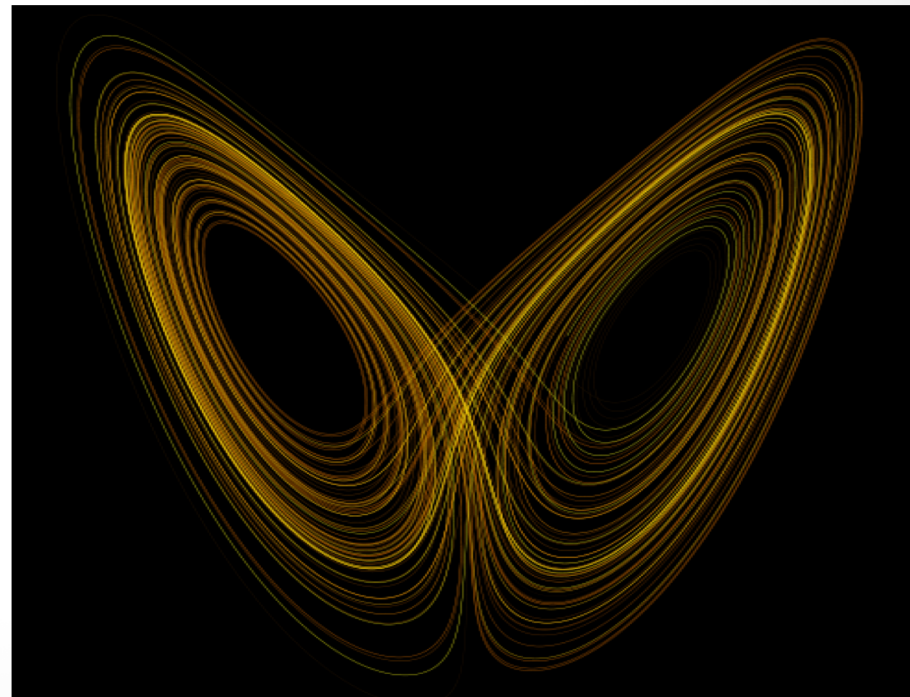

The Butterfly

The hippie era was about to begin. Lorenz picked a timely emblem for chaotic dynamics.

Soon butterflies were in everyone's face.



The Butterfly

Lorenz himself mystified the stuff...

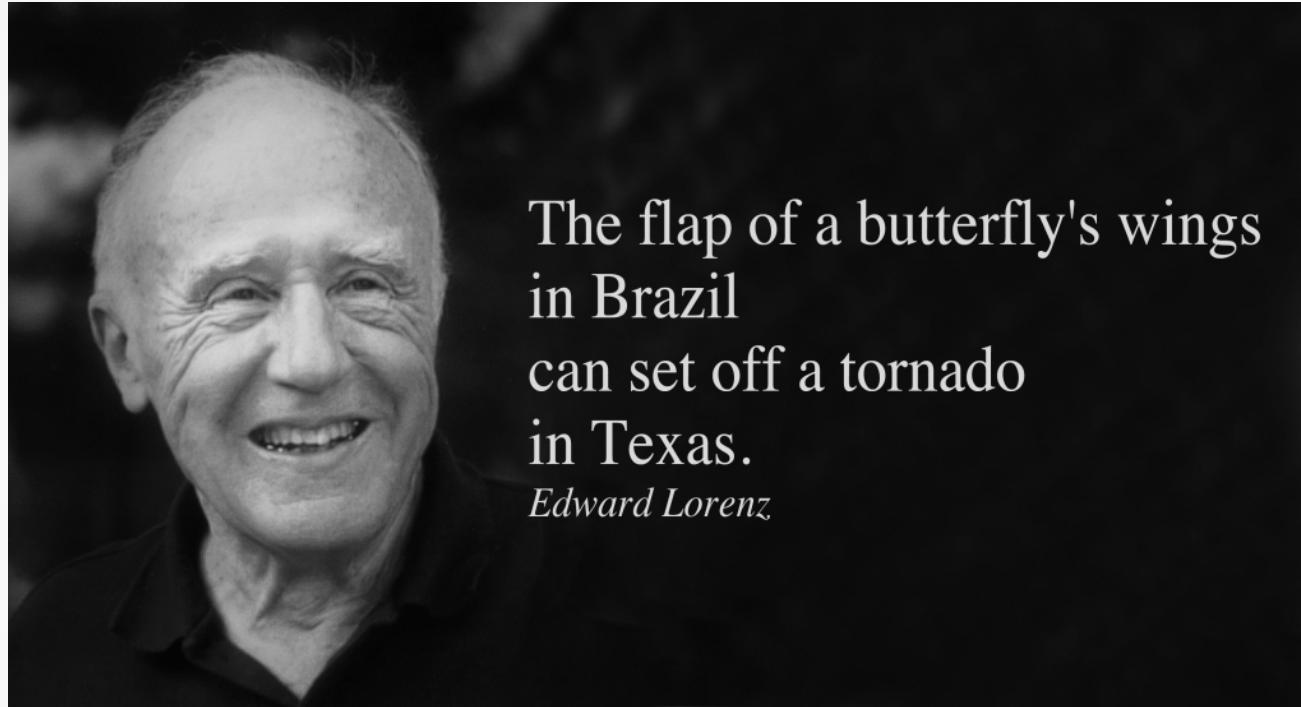

Let's try and understand the Lorenz' attractor in a more down-to-earth manner.

Chaotic Waterwheel

In the 1970s Willem Malkus and Lou Howard constructed a mechanical model exhibiting chaotic dynamics, a waterwheel with leaky cups. Steady water flow is applied from above.

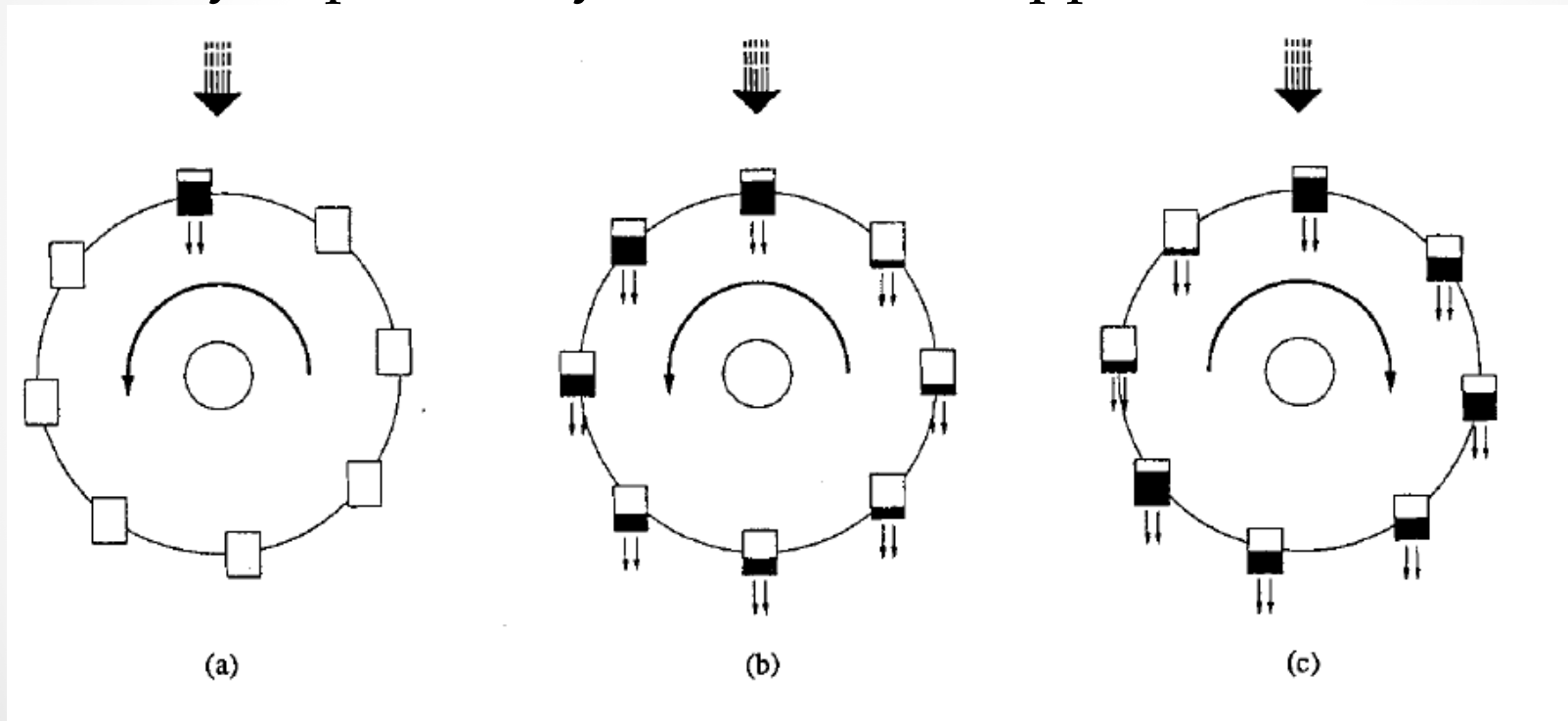

Slow flow: nothing happens. Increasing flow: steady rotation.
Fast flow: chaotic motion.

Chaotic Waterwheel

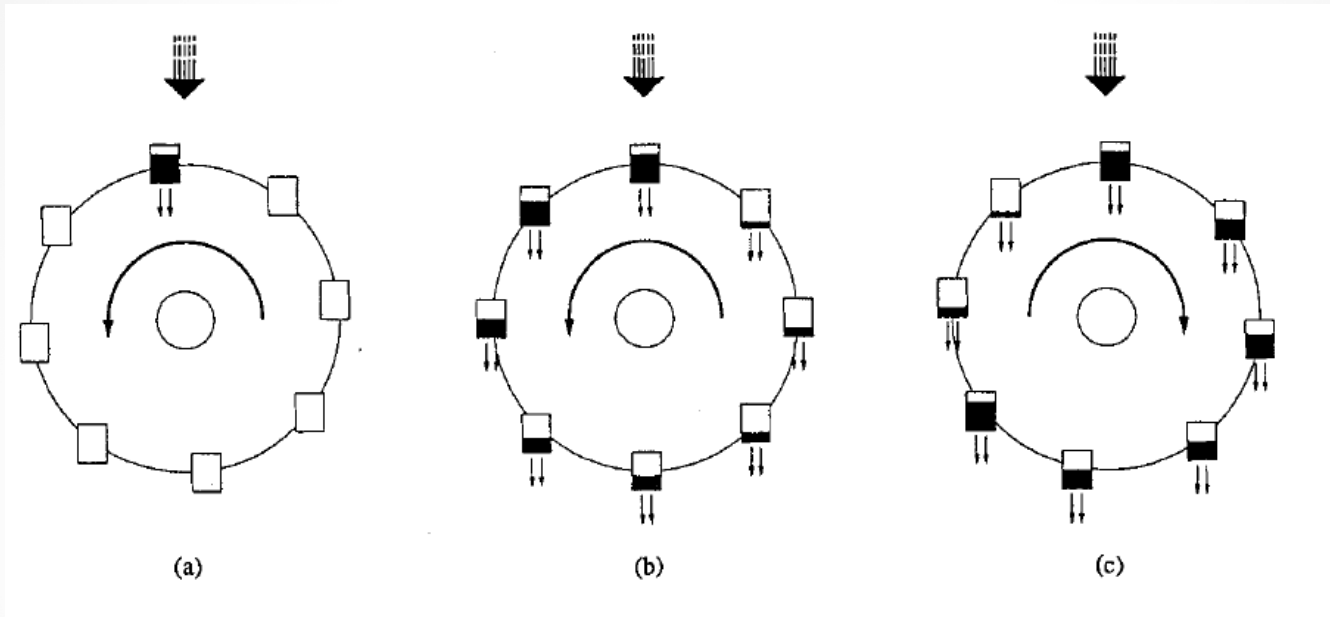

Chaotic rotation shows in the angular frequency $\omega(t)$.

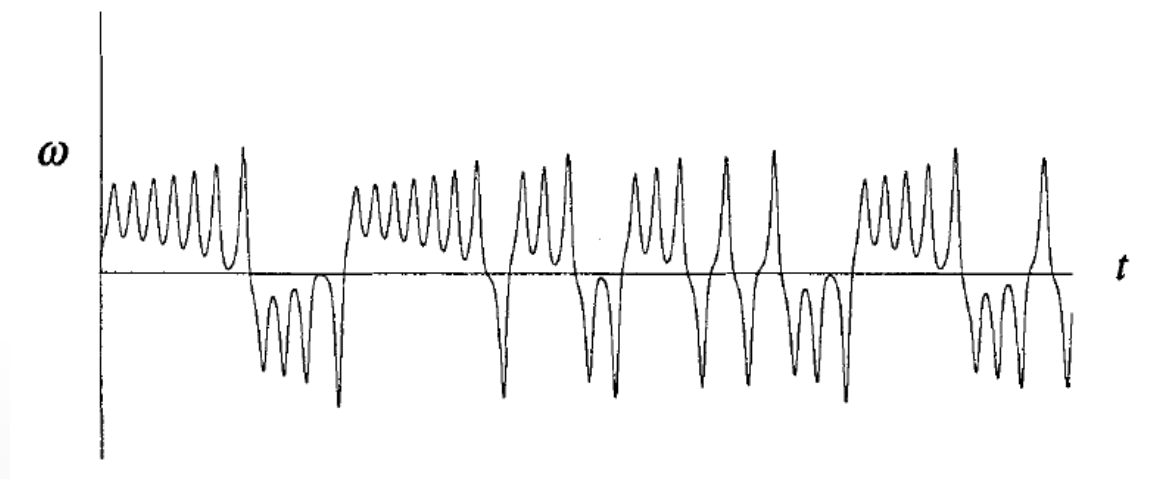

Chaotic Waterwheel

The coordinate system

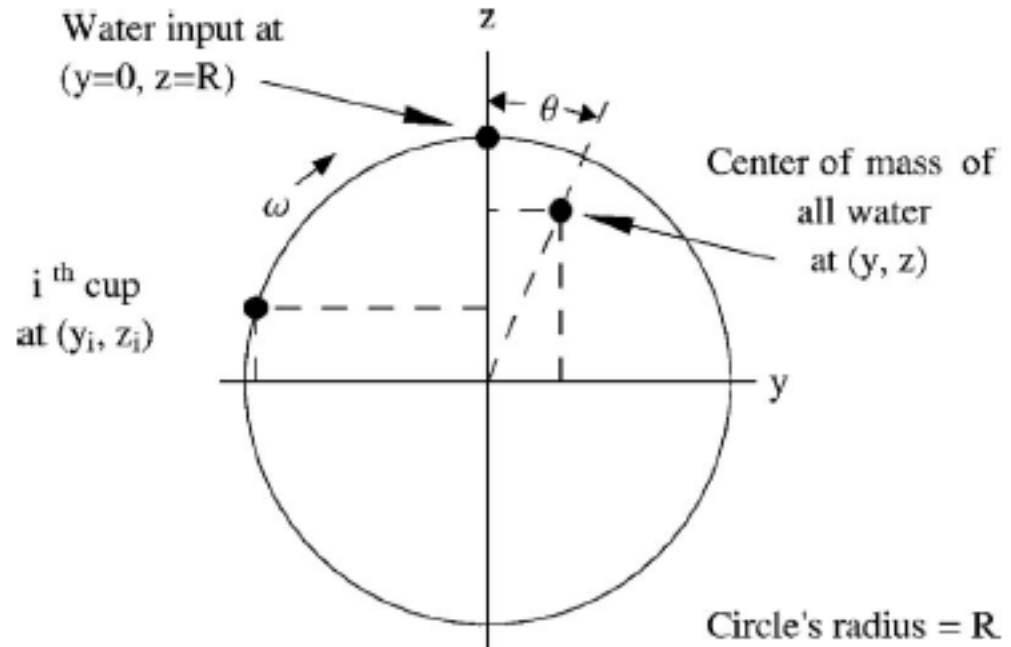
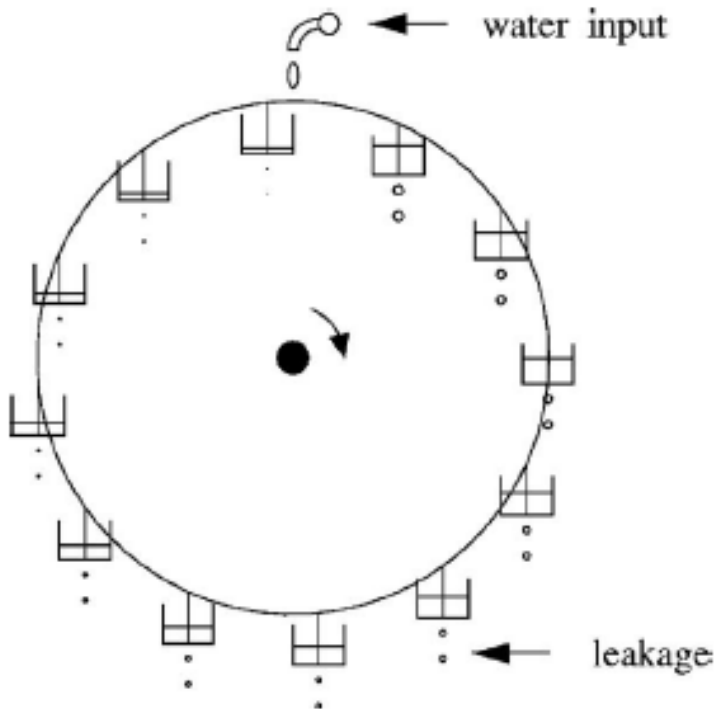

We measure the position of the center of mass $(x(t), y(t), z(t))$. Plotting $(\omega(t), y(t), z(t))$ we get the **butterfly**, the **Lorenz map**. See <https://www.youtube.com/watch?v=SlwEt5QhAGY>

Strange Attractor

Lorenz' butterfly is the **strange attractor**. Trajectories (solutions to Lorenz equations) remain within this peculiar space. Next, we'll learn what Lorenz did with his equations to understand this object and chaotic dynamics.

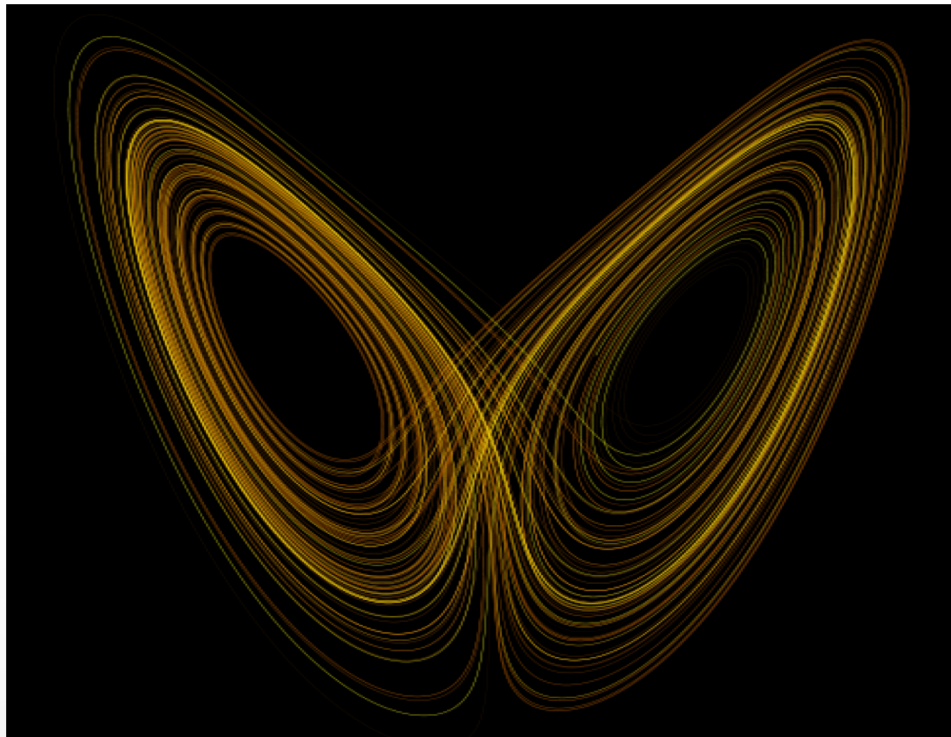

Lorenz Equations

$$\begin{aligned}\dot{x} &= \sigma(y - x) \\ \dot{y} &= rx - y - xz \\ \dot{z} &= xy - bz\end{aligned}$$

Lorenz proved that

- in a certain range of parameters σ , r , and b there could be **no stable fixed points** and **no stable limit cycles**
- yet, all **trajectories** remain **confined to a bounded region**
- moreover, all **trajectories** are eventually **attracted to a set of zero volume**

What is this set?

How do trajectories move on it?

→ Analyse Lorenz equations.

Lorenz Equations

$$\begin{aligned}\dot{x} &= \sigma(y - x) \\ \dot{y} &= rx - y - xz \\ \dot{z} &= xy - bz\end{aligned}$$

Parameters $\sigma, r, b > 0$. (σ is the Prandtl number – ratio of viscous to thermal diffusion -, r is the Rayleigh number – ratio of driving to dissipation -, and b has no name; in the convection problem b is related to the aspect ratio of the rolls.)

Basic properties:

Only **two nonlinearities**, xz and xy .

Symmetry: under $(x, y) \rightarrow (-x, -y)$ equations stay the same \rightarrow if $[x(t), y(t), z(t)]$ is a solution, so is $[-x(t), -y(t), z(t)] \rightarrow$ solutions are either **symmetric themselves** or they have a **symmetric partner**.

Lorenz Equations

Volume contraction

$$\text{3D-system: } \dot{\mathbf{x}} = \mathbf{f}(\mathbf{x})$$

The Lorenz system is **dissipative**: volumes in phase space contract under the flow.

An arbitrary closed surface $S(t)$ of a volume $V(t)$ in phase space.

Think of points on $S(t)$ as initial conditions for the motion: what happens after a time dt ?

$S(t) \rightarrow S(t+dt)$: what is the volume $V(t+dt)$ of the new surface?

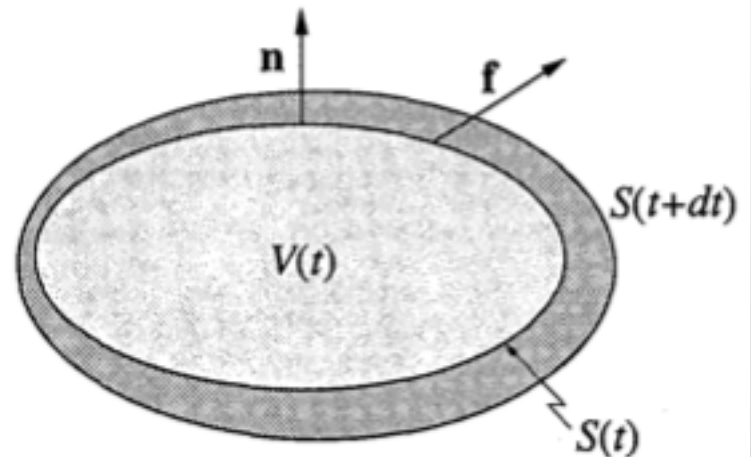

Lorenz Equations

Volume contraction

3D-system: $\dot{\mathbf{x}} = \mathbf{f}(\mathbf{x})$

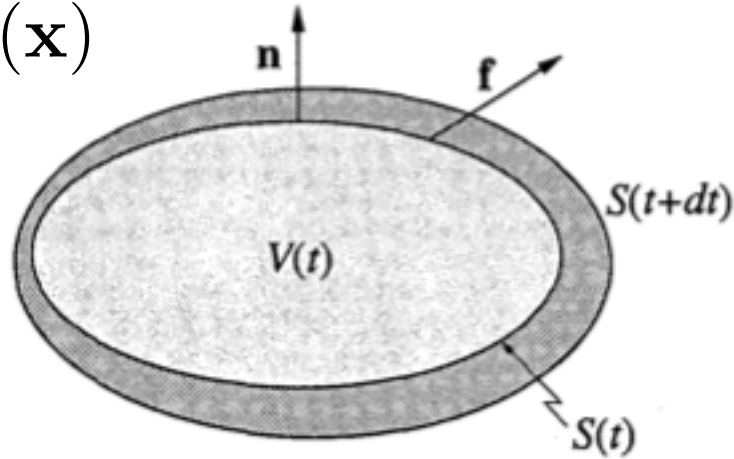

A patch of area dA sweeps out a volume $(\mathbf{f} \cdot \mathbf{n} dt) dA$, where \mathbf{f} is the instantaneous velocity of the points on S and \mathbf{n} is the outward normal on S .

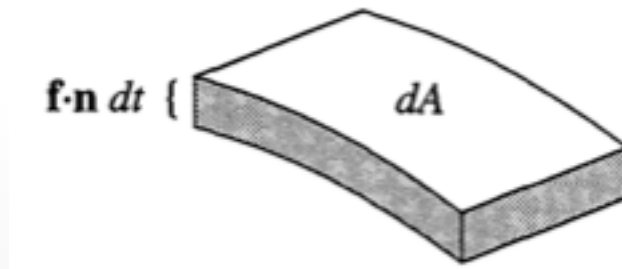

Lorenz Equations

Volume contraction

$$V(t + dt) = V(t) + \int_S (\mathbf{f} \cdot \mathbf{n} dt) dA$$

$$\Rightarrow \frac{V(t + dt) - V(t)}{dt} = \int_S (\mathbf{f} \cdot \mathbf{n}) dA$$

Divergence theorem $\rightarrow \dot{V} = \int_V \nabla \cdot \mathbf{f} dV.$

Lorenz Equations

Volume contraction

Using Lorenz equations:

$$\dot{\mathbf{x}} = \mathbf{f}(\mathbf{x}) \Rightarrow$$

$$\begin{aligned}\dot{x} &= \sigma(y - x) \\ \dot{y} &= rx - y - xz \\ \dot{z} &= xy - bz\end{aligned}$$

$$\nabla \cdot \mathbf{f} = \frac{\partial}{\partial x}[\sigma(y - x)] + \frac{\partial}{\partial y}[rx - y - xz] + \frac{\partial}{\partial z}[xy - bz] = -\sigma - 1 - b < 0$$

$$\dot{V} = -(\sigma + 1 + b)V \quad \rightarrow \quad V(t) = V(0)e^{-(\sigma+1+b)t}$$

Volumes in phase space **shrink exponentially fast**: If we start from a huge blob of initial conditions, it eventually shrinks to a set of zero volume.

All trajectories starting in the blob end up somewhere in this limiting set: fixed points, limit cycles, strange attractor.

Example

The Lorenz system **cannot have repellers** (unstable nodes or unstable closed orbits)!

Reason: repellers are *sources of volume*.

Proof by contradiction

- 1) Suppose there were a repeller. Let us take a small volume enclosing it (sphere for a point, tube for a closed orbit).
- 2) A short time later this volume must have expanded, since the repeller drives neighbouring trajectories away → contradiction!

Consequence: fixed points must be sinks or saddles, and closed orbits (if there are any) must be stable or saddle-like.

Fixed points

$$\begin{aligned}\dot{x} &= \sigma(y - x) \\ \dot{y} &= rx - y - xz \\ \dot{z} &= xy - bz\end{aligned}$$

The **origin** $(x^*, y^*, z^*) = (0, 0, 0)$ is a fixed point for **all values** of the parameters.

For $r > 1$ there is also **a symmetric pair of fixed points**. In Lorenz equations they represent left- or right-turning convection rolls and were called C^+ and C^- by Lorenz. They are also analogous to the steady rotations of the waterwheel.

$$x^* = y^* = \pm \sqrt{b(r - 1)}, \quad z^* = r - 1$$

As $r \rightarrow 1^+$ C^+ and C^- coalesce with the origin in a **pitchfork bifurcation**.

Linear Stability of the Origin

Linearization at the origin

$$\begin{array}{lcl} \dot{x} & = & \sigma(y - x) \\ \dot{y} & = & rx - y - xz \\ \dot{z} & = & xy - bz \end{array} \quad \rightarrow \quad \begin{array}{lcl} \dot{x} & = & \sigma(y - x) \\ \dot{y} & = & rx - y \\ \dot{z} & = & -bz \end{array}$$

In the linearized system motion on the z -axis is decoupled and decays exponentially fast towards $z = 0$.

The other two directions, x and y , are governed by the system

$$\begin{pmatrix} \dot{x} \\ \dot{y} \end{pmatrix} = \begin{pmatrix} -\sigma & \sigma \\ r & -1 \end{pmatrix} \begin{pmatrix} x \\ y \end{pmatrix}$$

$$\tau = -\sigma - 1 < 0, \Delta = \sigma(1 - r).$$

If $r > 1$, the origin is a **saddle point** ($\Delta < 0$): a new type of saddle (3D) with one outgoing and two incoming directions.

Linear Stability of the Origin

Reminder about linearization:

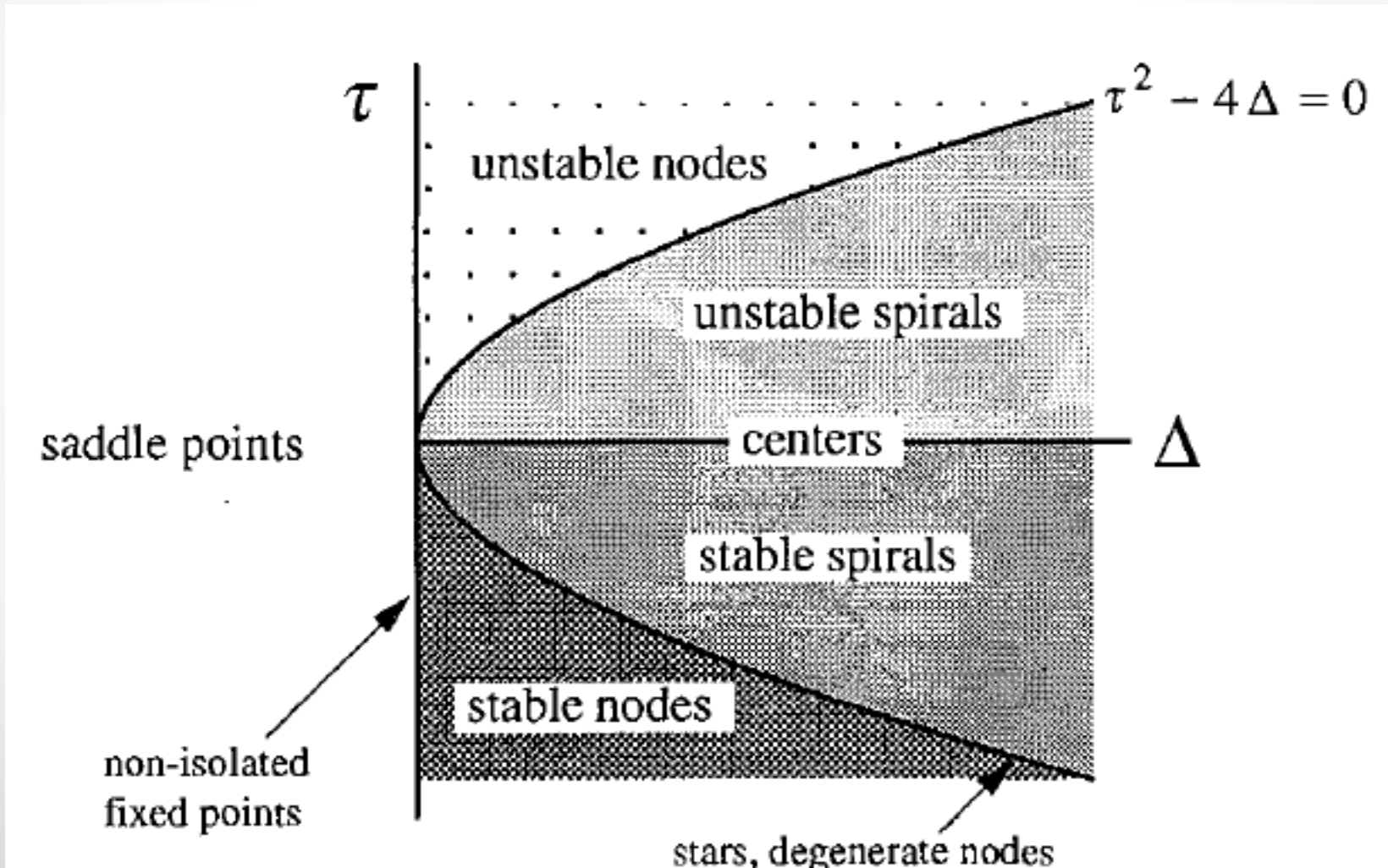

Linear Stability of the Origin

$$\tau = -\sigma - 1 < 0, \Delta = \sigma(1 - r)$$

If $r < 1$, the origin is a **stable node** (sink: all directions are incoming), because

$$\tau^2 - 4\Delta = (\sigma + 1)^2 - 4\sigma(1 - r) = (\sigma - 1)^2 + 4\sigma r > 0$$

In fact, **for** $r < 1$ the origin is **globally stable**: every trajectory approaches $(0,0) \rightarrow$ no limit cycles or chaos!

Prove this by constructing a Liapunov function

Global Stability of the Origin

Claim: For $r < 1$ the origin is **globally stable**

Proof: Construction of a Liapunov function, that is, a smooth positive definite function that decreases along trajectories.

(A generalization of an energy function for a classical dissipative mechanical system.)

Consider

$$V(x, y, z) = \frac{1}{\sigma} x^2 + y^2 + z^2$$

Global Stability of the Origin

$$V(x, y, z) = \frac{1}{\sigma} x^2 + y^2 + z^2$$

The surfaces of constant V are **concentric ellipsoids** about the origin.

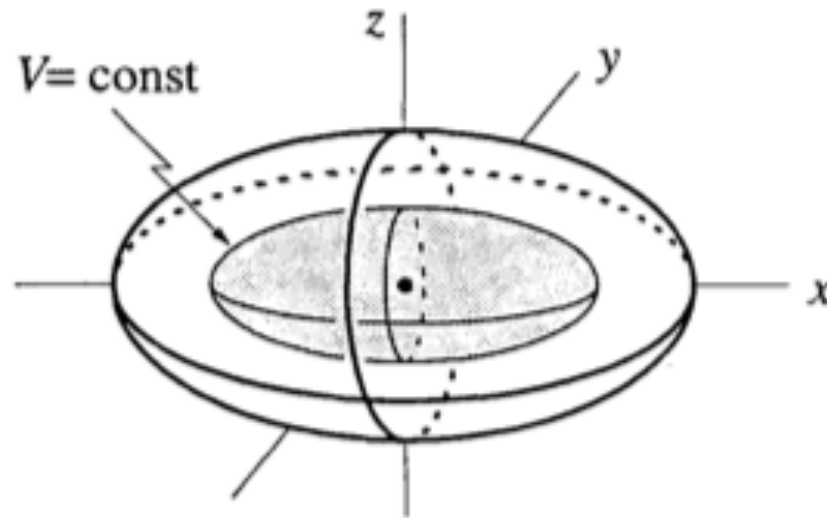

The idea of the proof: Show that, if $r < 1$ and $(x, y, z) \neq (0,0,0)$, then $\dot{V} < 0$ along trajectories.

Global Stability of the Origin

$$\underline{r < 1} \quad V(x, y, z) = \frac{1}{\sigma} x^2 + y^2 + z^2$$

$$\begin{aligned}\dot{x} &= \sigma(y - x) \\ \dot{y} &= rx - y - xz \\ \dot{z} &= xy - bz\end{aligned}$$

Calculate:

$$\begin{aligned}\frac{1}{2}\dot{V} &= \frac{1}{\sigma} x\dot{x} + y\dot{y} + z\dot{z} \\ &= (yx - x^2) + (ryx - y^2 - xyz) + (zxy - bz^2) \\ &= (r + 1)xy - x^2 - y^2 - bz^2 \\ &= - \left[x - \frac{r + 1}{2}y \right]^2 - \left[1 - \left(\frac{r + 1}{2} \right)^2 \right] y^2 - bz^2\end{aligned}$$

$\dot{V} < 0$ for any $(x, y, z) \neq (0, 0, 0)$ and zero only at the origin \rightarrow trajectories move to smaller V , penetrating smaller and smaller ellipsoids as $t \rightarrow \infty$. \rightarrow **(0, 0, 0) is globally stable for $r < 1$.**

Note: The origin is **globally** stable, because above we included also the nonlinear terms in the Lorenz equations.

Stability of C^+ and C^-

$r > 1$ (Remember that as $r \rightarrow 1^+$, C^+ and C^- coalesce with the origin in a pitchfork bifurcation.)

C^+ and C^- are **linearly stable** for

$$1 < r < r_H = \frac{\sigma(\sigma + b + 3)}{\sigma - b - 1} \quad (\text{assuming } \sigma - b - 1 > 0)$$

A straightforward but lengthy calculation, you'll wrestle with it as an **exercise**.

Stability of C^+ and C^-

Hopf bifurcation occurs at $r = r_H$.

After the bifurcation, for $r < r_H$ there is an **unstable limit cycle** about either point C^+ or C^- . → **Subcritical** Hopf bifurcation. (Hard! Ref. Marsden , McCracken, *The Hopf Bifurcation and Its Applications* (Springer, 1976).

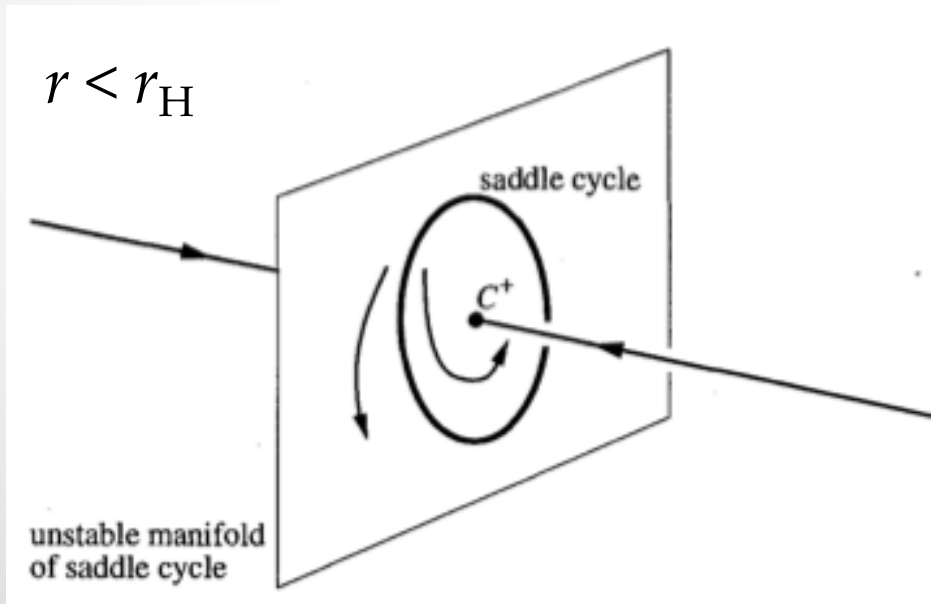

The stable fixed point is encircled by a **saddle cycle**, a new type of unstable limit cycle (only in $D \geq 3$), which has a two-dimensional unstable manifold (the sheet) and a two-dimensional stable manifold (not shown).

Stability of C^+ and C^-

As $r \rightarrow r_H$ from below the cycle shrinks down around the fixed point. At the Hopf bifurcation, $r = r_H$, the cycle is absorbed by the fixed point, which turns into a saddle point.

For $r > r_H$ there are **no attractors** in the neighbourhood!

For $r > r_H$ trajectories must **fly away** to a **distant attractor**! What can that be?

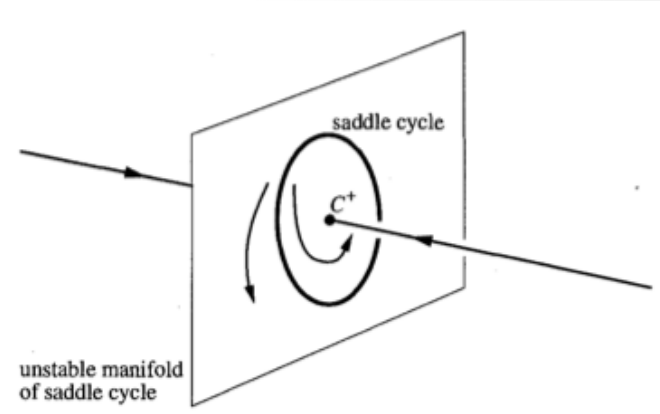

Partial bifurcation diagram

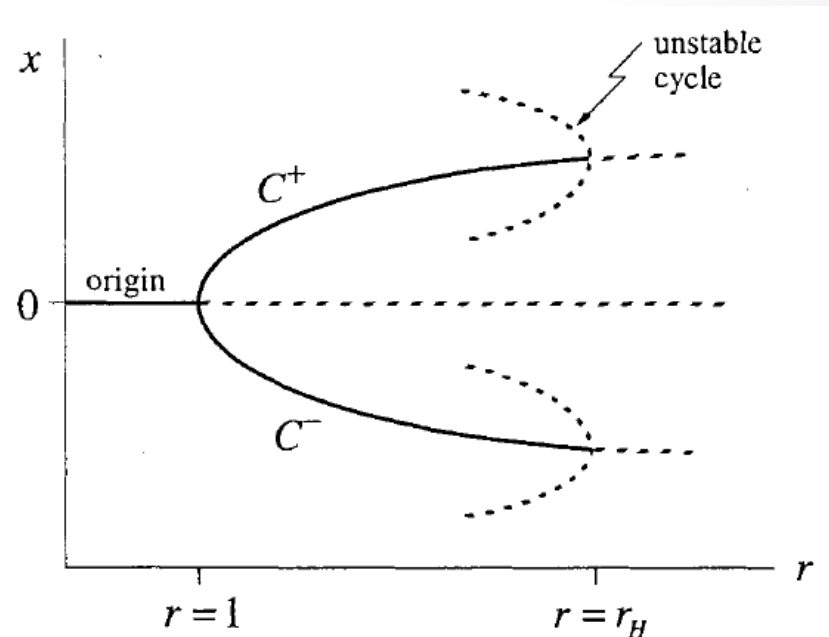

Stability of C^+ and C^-

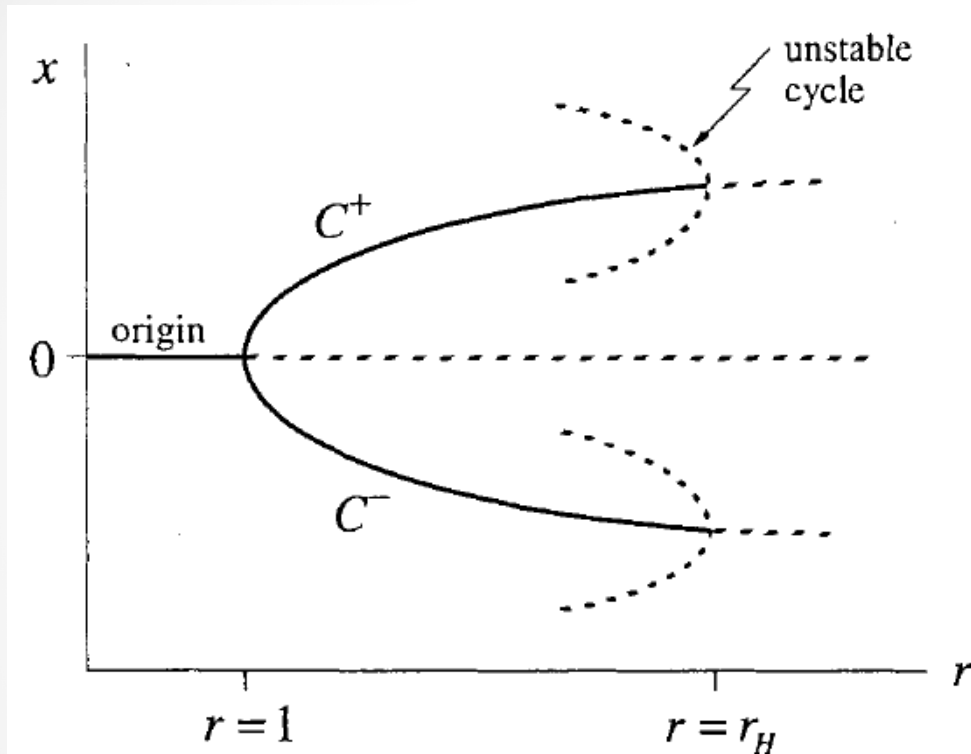

For $r > r_H$ there do not seem to be stable objects!

Can it be that trajectories *fly away to infinity*? No, it can be proven that all trajectories enter and remain in a certain large ellipsoid.

Stability of C^+ and C^-

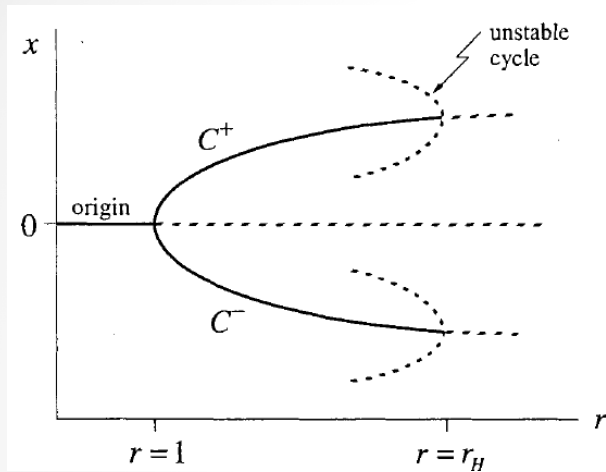

Could there exist a stable limit cycle? Possibly, but Lorenz gave convincing arguments that for r slightly greater than r_H any limit cycle would have to be unstable.

The trajectories are repelled from one unstable object after another, yet they are confined to a bounded set of zero volume and move on this forever without intersecting themselves or others. → **Chaos on a strange attractor.**

Chaos on a strange attractor

Numerical integration to see what happens in the long run:
Lorenz studied the case $\sigma=10$, $b=5/3$, $r=28$.

$$r = 28 > r_H = \frac{\sigma(\sigma + b + 3)}{\sigma - b - 1} = 24.74$$

r is just past Hopf bifurcation: the unknown territory.

Numerical integration from the initial condition $(0,1,0)$:

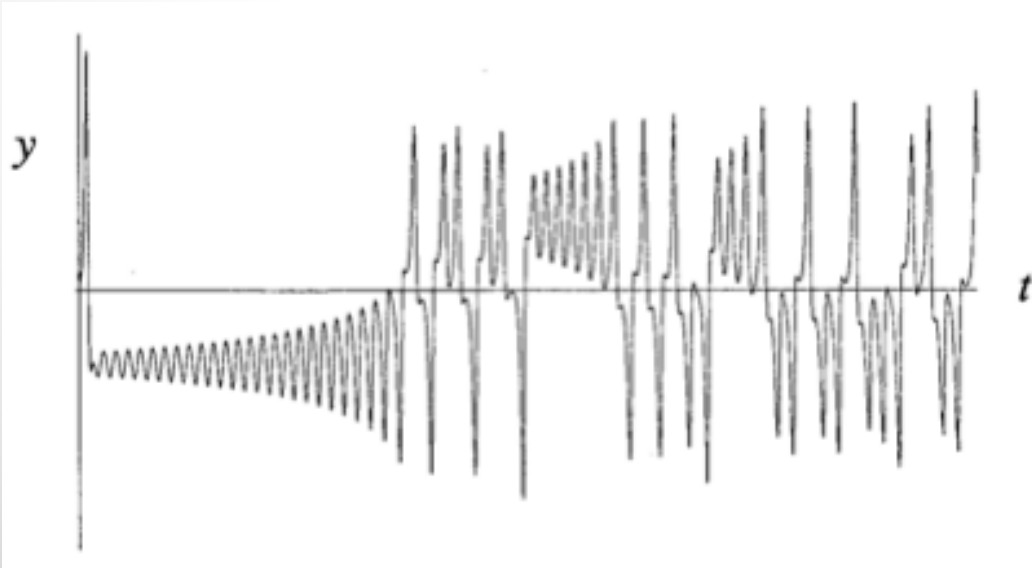

Initial transient, then irregular oscillation that persists as $t \rightarrow \infty$, but never repeats exactly. → **Aperiodic motion!**

Chaos on a strange attractor

Visualising as a trajectory in the phase plane, Lorenz discovered the butterfly. For example, $x(t)$ plotted against $z(t)$.

- 1) Trajectory starts near the origin $(0,1,0)$.
- 2) It swings to the right and then dives into the center of a spiral on the left.
- 3) After a very slow spiral outward, the trajectory shoots back over to the right, where it spirals a few times, shoots over to the left, etc.

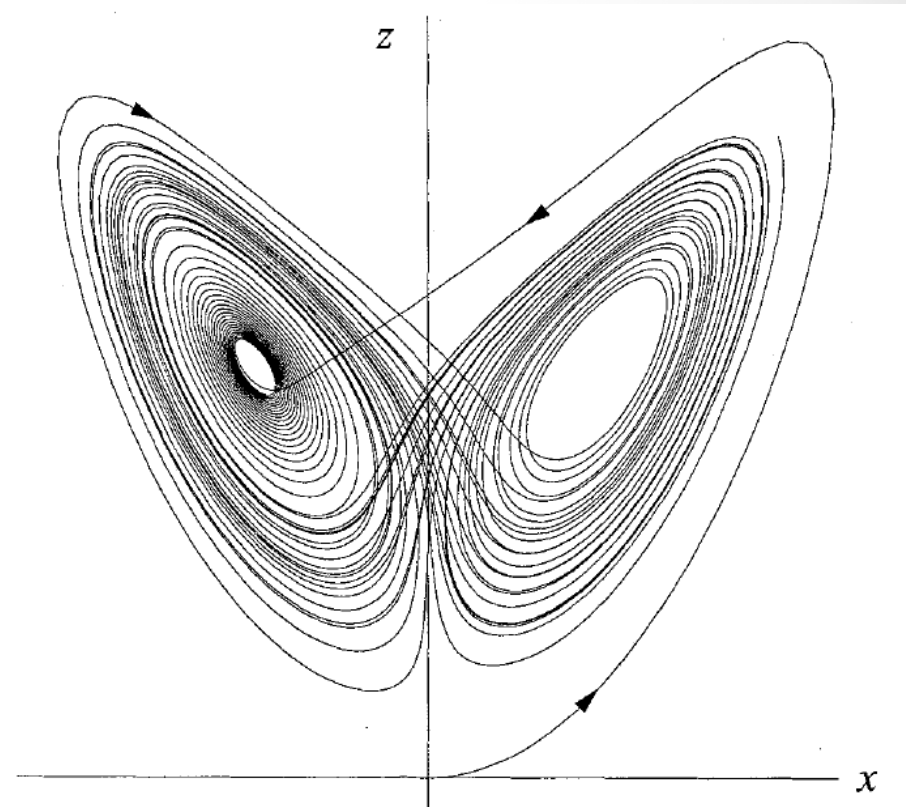

- 4) The number of circuits made on either side is **unpredictable** (random sequence characteristics).

Chaos on a strange attractor

3D

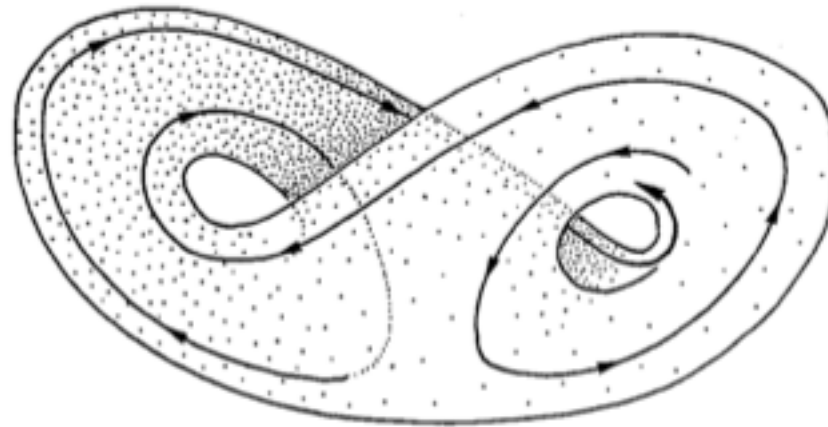

- 1) Impression: a pair of surfaces that merge into one. But this cannot be, because of existence and uniqueness theorem (orbits cannot intersect!) Lorenz: "... surfaces only appear to merge."
- 2) In fact: **infinite complex of surfaces** → **fractal**. This particular fractal is a set of points with zero volume but infinite surface area that has a dimension of about 2.05!

Fractals were defined by Mandelbrot only in 1975.

Exponential divergence of nearby trajectories

Motion on the attractor exhibits **sensitive dependence on initial conditions**: two trajectories starting very close to each other will rapidly diverge from each other.

Consequence: long-term predictions become impossible!

Consider two nearby points on the attractor: $x(t)$ and $x(t) + \delta(t)$.

Initially,

$$\|\delta(t_0)\| = \|\delta_0\| = 10^{-15}$$

Numerically, one finds that

$$\|\delta(t)\| \sim \|\delta_0\| e^{\lambda t}, \quad \lambda \sim 0.9$$

Neighboring trajectories separate exponentially fast!

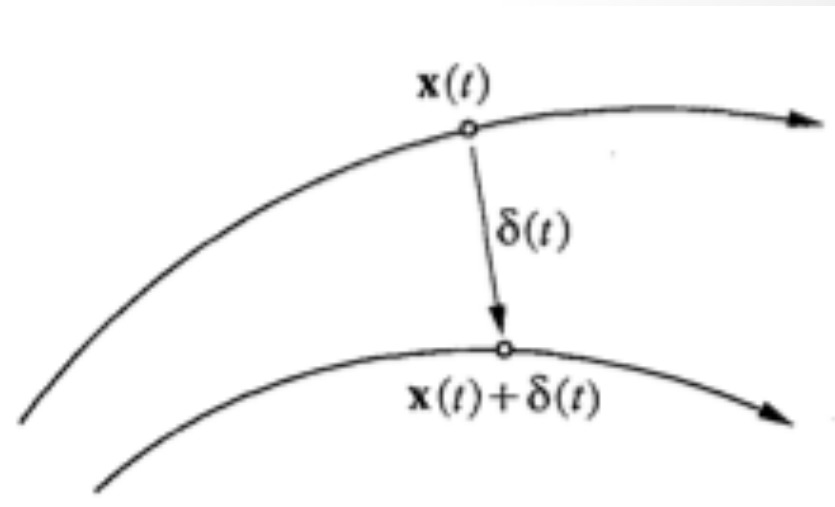

Exponential divergence of nearby trajectories

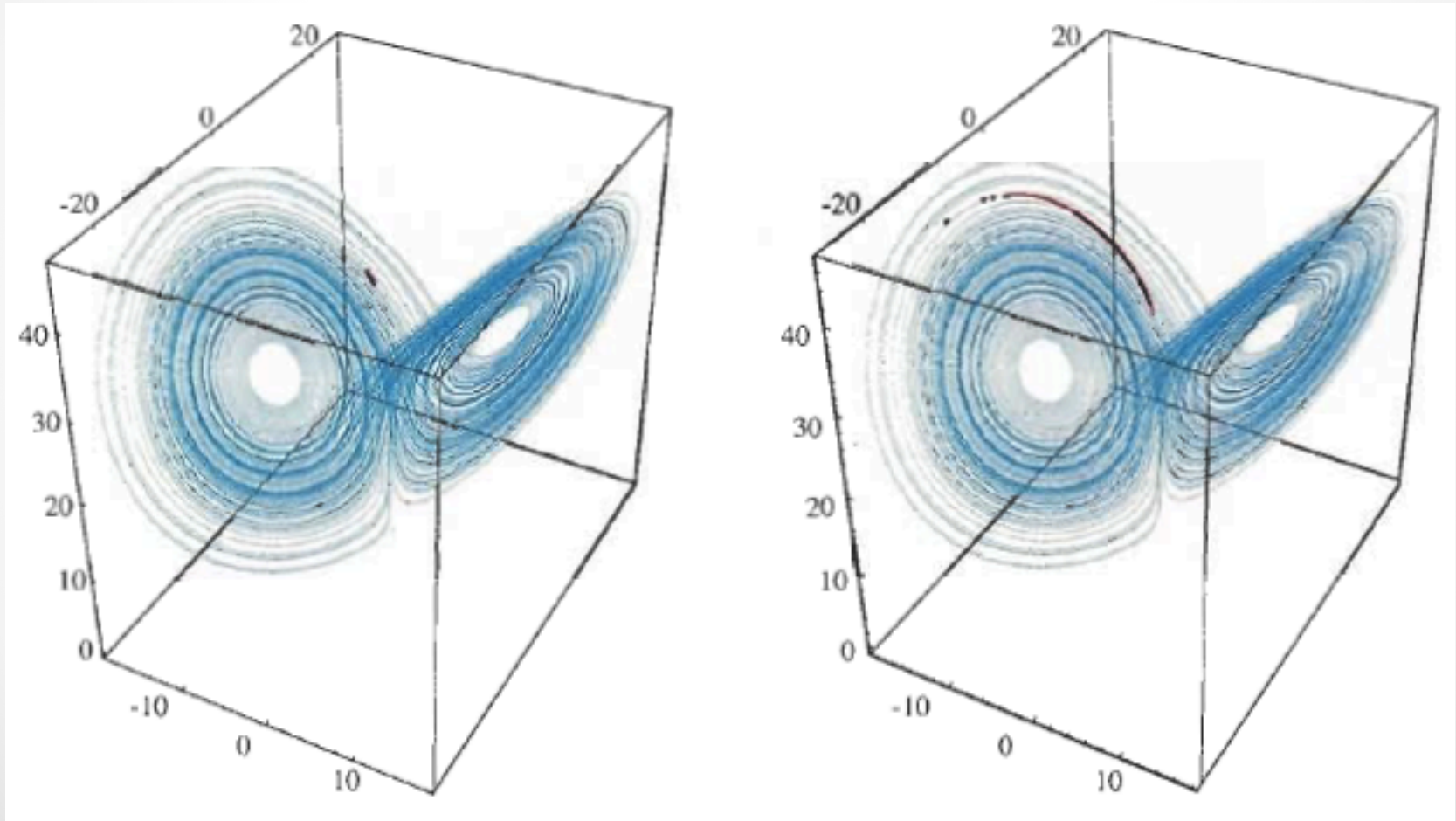

Spreading of nearby initial conditions in time.

Exponential divergence of nearby trajectories

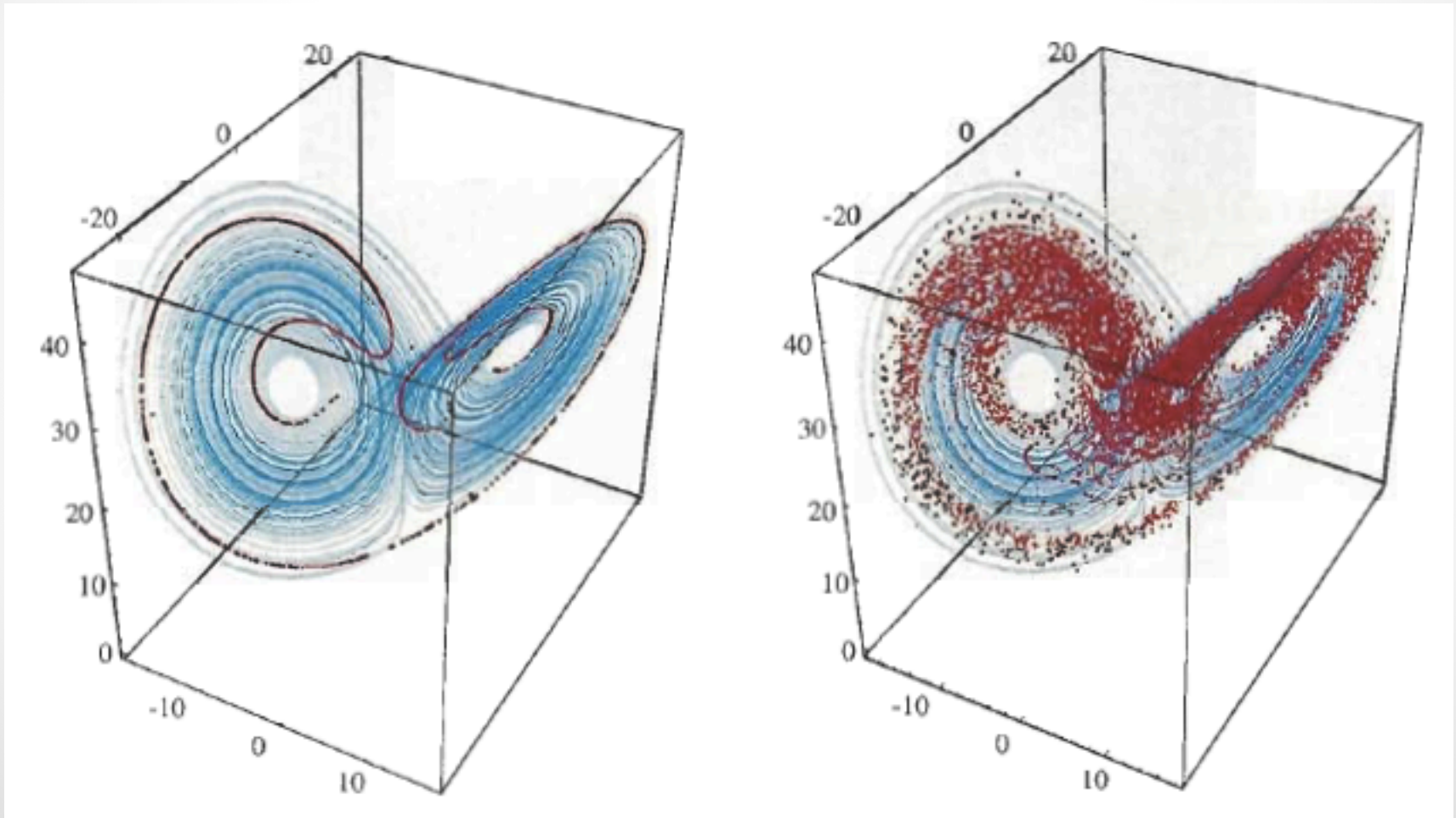

Spreading of nearby initial conditions in time.

Exponential divergence of nearby trajectories

Straight line of $\ln|\delta|$ versus $t \rightarrow$ exponential behaviour.

Caveats:

- 1) Curve is never exactly straight: wiggles due to variations of exponential divergence λ .
- 2) Divergence cannot exceed the “diameter” of the attractor, so exponential behavior ends with a saturation.

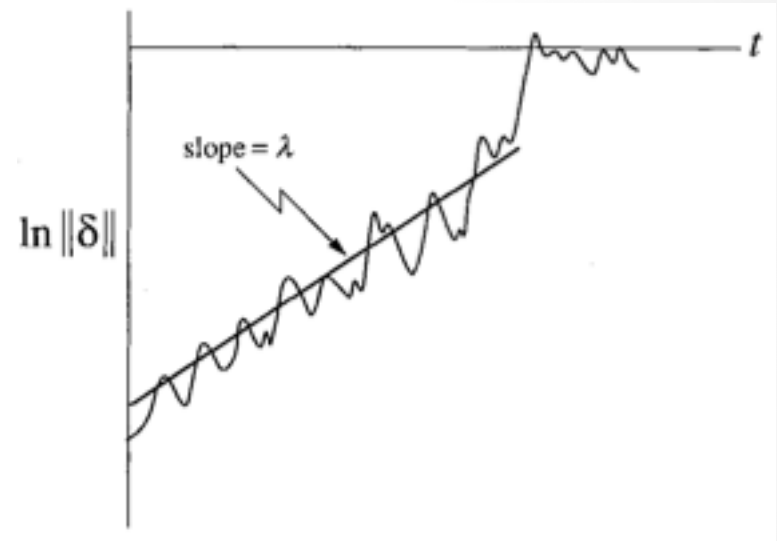

Exponential divergence of nearby trajectories

λ is called **Lyapunov exponent**. Sloppy terminology, because:

- 1) There are actually n different exponents, one for each space dimension; λ is the **largest** of them.
- 2) λ depends on which trajectory one considers, so the true value is given by averaging over many different points on the same trajectory.

When λ is positive, there is a **time horizon** beyond which prediction breaks down.

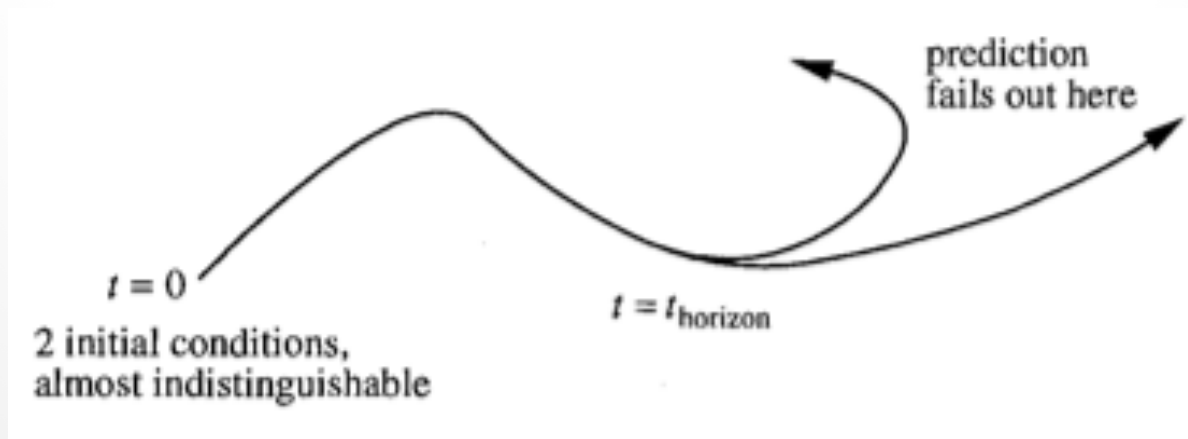

Exponential divergence of nearby trajectories

Let $\|\delta_0\|$ be the error in the measurement or estimate of the initial state. The discrepancy between the estimate and the true state will grow exponentially, $\|\delta\| \sim e^{\lambda t}$.

If a is a measure of **tolerance**, the prediction is acceptable when it is within a of the true state. The unacceptably large error $\|\delta(t)\| \geq a$ will occur after a time

$$t_{\text{horizon}} \sim O\left(\frac{1}{\lambda} \ln \frac{a}{\|\delta_0\|}\right)$$

Consequence: The behavior of the system cannot be predicted longer than a few multiples of $1/\lambda$.

Example

Tolerance $a = 10^{-3}$, uncertainty of the estimate of the initial state $\|\delta_0\| = 10^{-7}$. For how long can we predict?

$$t_{\text{horizon}} \sim \frac{1}{\lambda} \ln \frac{a}{\|\delta_0\|} = \frac{1}{\lambda} \ln \frac{10^{-3}}{10^{-7}} = \frac{1}{\lambda} \ln(10^4) = \frac{4 \ln 10}{\lambda}$$

If there's a **huge improvement** in the uncertainty: $\|\delta_0\| = 10^{-13}$, the time to which we can predict with tolerance a becomes

$$t_{\text{horizon}} \sim \frac{1}{\lambda} \ln \frac{a}{\|\delta_0\|} = \frac{1}{\lambda} \ln \frac{10^{-3}}{10^{-13}} = \frac{1}{\lambda} \ln(10^{10}) = \frac{10 \ln 10}{\lambda}$$

The time horizon has increased **only by a factor 2.5**.

Conclusion: trying to predict long-term behavior of a chaotic system is pointless!

Defining chaos

There is no universally accepted definition of the term *chaos*, but a general agreement on the following three ingredients

Chaos: *aperiodic long-term behavior in a deterministic system that exhibits sensitive dependence on initial conditions*

- 1) **Aperiodic long-term behavior:** trajectories do not settle down to fixed points, periodic orbits, quasiperiodic orbits as $t \rightarrow \infty$
- 2) **Deterministic:** the system has no random or noisy inputs or parameters \rightarrow the irregular behavior arises from nonlinearity
- 3) **Sensitive dependence on initial conditions:** nearby trajectories separate exponentially fast \rightarrow positive Liapunov exponent

Counter example

The system

$$\dot{x} = x$$

is *deterministic* and shows *exponential separation* of nearby trajectories: is it **chaotic**?

No! Trajectories diverge to infinity, never to return. Infinity is a sort of an attracting fixed point, so this is not aperiodic behaviour.

Defining attractor and strange attractor

Definition: an **attractor** is a closed set A with the following properties:

- 1) A is an **invariant set**: any trajectory $\mathbf{x}(t)$ that starts in A stays in A for all time.
- 2) A **attracts an open set** of initial conditions: there is an open set U containing A such that if $\mathbf{x}(0) \in U$, then the distance from $\mathbf{x}(t)$ to A tends to zero as $t \rightarrow \infty$. So, A attracts all trajectories that start sufficiently close to it. The largest such U is called the **basin of attraction** of A .
- 3) A is **minimal**: there is no proper subset of A that satisfies conditions 1 and 2.

Example

$$\begin{aligned}\dot{x} &= x - x^3 \\ \dot{y} &= -y\end{aligned}$$

Interval I : $x \in [-1, 1]$ and $y = 0$. Is I an attractor?

Stable fixed points at $(\pm 1, 0)$, endpoints of I and a saddle point at $(0, 0)$.

- 1) I is an **invariant set**: any trajectory starting in I it will stay in I .
- 2) I **attracts an open set of initial conditions**, i.e. all trajectories in the whole xy plane.
- 3) I is **not minimal**: the stable fixed points $(\pm 1, 0)$ are proper subsets of I satisfying 1) and 2).

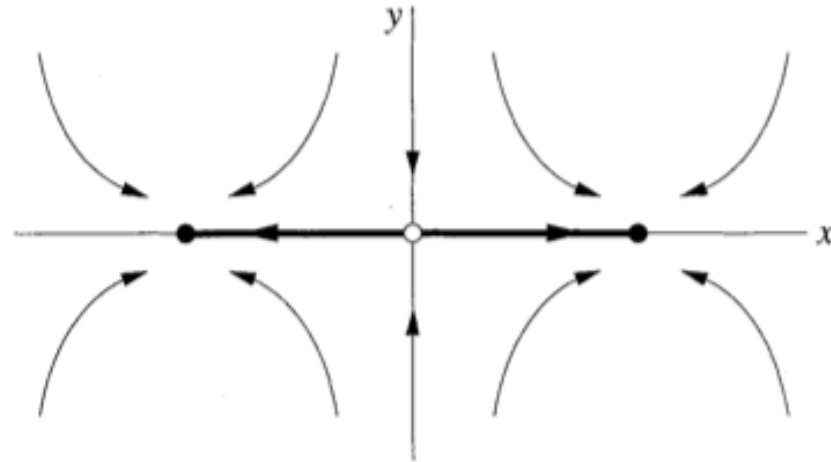

Conclusion: I is **not** an **attractor**; the stable fixed points are the only attractors.

Strange attractors

A **strange attractor** is an attractor that **exhibits sensitive dependence on initial conditions**.

“Strange”: These attractors are often **fractals**.

Depending on the property one wants to emphasize the terms used are **chaotic attractor** and **fractal attractor**.

Remember: Fractal and self-similarity they exhibit were not in the vocabulary when Lorenz made his discovery. But he had some intuition →

Lorenz map

Lorenz's observation:

the trajectory apparently leaves one spiral only after exceeding some critical distance from the center. Moreover, the extent to which this distance is exceeded appears to determine the point at which the next spiral is entered; this in turn seems to determine the number of circuits to be executed before changing spirals again. It therefore seems that some single feature of a given circuit should predict the same feature of the following circuit.

“ ... It therefore seems that some single feature of a given circuit should predict the same feature of the following circuit.”

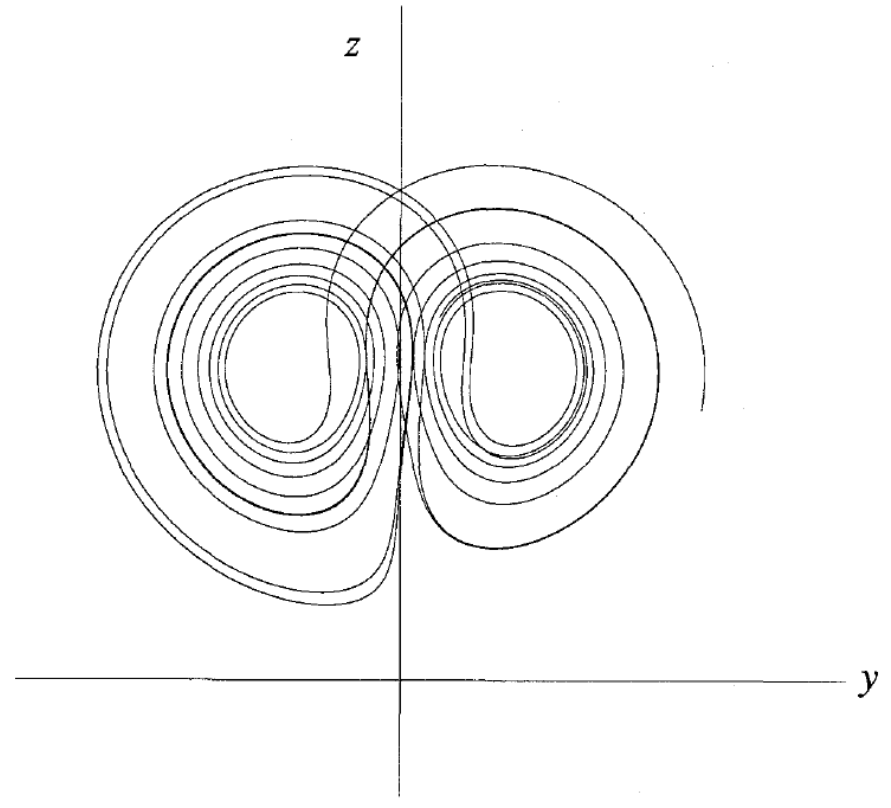

Lorenz map

“The single feature”: z_n , the n th local maximum of $z(t)$.

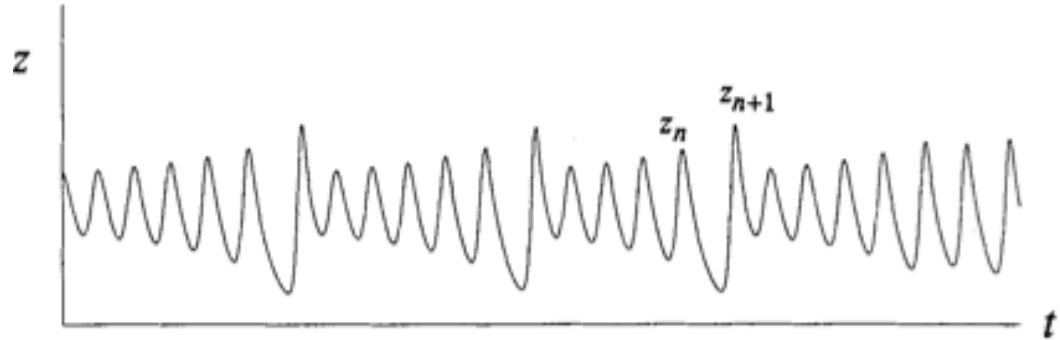
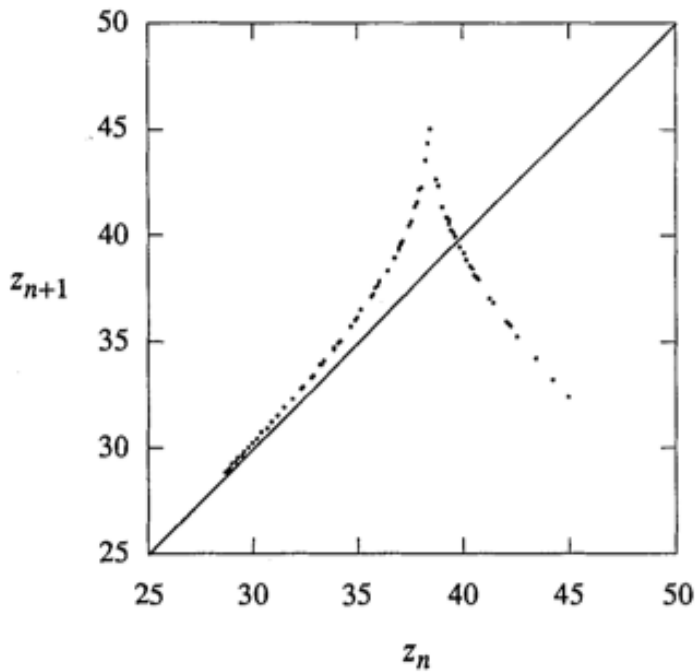

Lorenz's idea: z_n should predict z_{n+1} .
Numerical integration: z_{n+1} vs. z_n appear to fall on a single curve.

The function $z_{n+1} = f(z_n)$ is called **the Lorenz map**.

Caveat: the graph is not strictly a curve, it has a thickness:
 $z_{n+1} = f(z_n)$ is not a well-defined function. However, the thickness of the plot is infinitely small, so we make the approximation of a well-defined function.

Lorenz map

Lorenz map extracts order from chaos: It tells a lot about dynamics of the attractor; predict z_1 by $z_1 = f(z_0)$, then z_2 by $z_2 = f(z_1)$ etc.

Notice the difference to Poincaré map: In three-dimensional space a Poincaré map takes a point on a surface, specified by *two* coordinates, and tells how these two coordinates change after the first return to the surface. The Lorenz map characterises the trajectory by *one* number, which requires that the space – the attractor - is very flat, that is, close to two-dimensional. The Lorenz attractor has this characteristic.

Ruling out stable limit cycles

How do know that the Lorenz attractor **is not just a transient** which settles down to a (stable) limit cycle after a very long time?

Lorenz's counter argument

From Lorenz map: $|f'(z)| > 1$ for any value of z .

Consequence: if there is a limit cycle, it must be **unstable!**

A **fixed point** $f(z^*) = z^*$ of the Lorenz map $z_n = z_{n+1} = z_{n+2} = \dots$ would correspond to an intersection of f and the diagonal and represent a closed orbit.

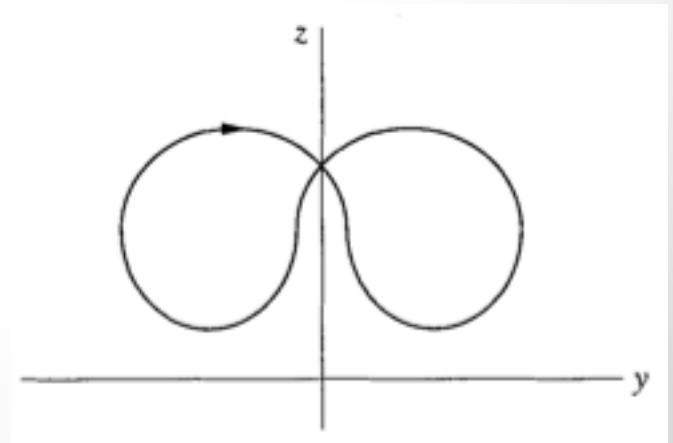
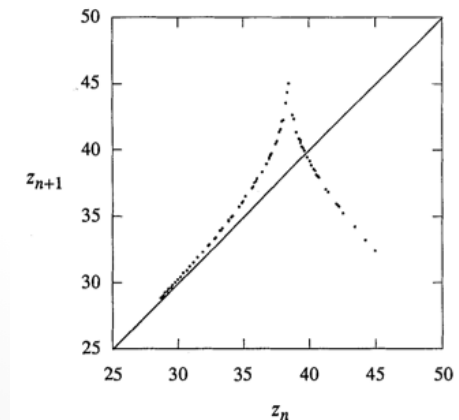

Ruling out stable limit cycles

This orbit is **unstable**.

Slightly perturbed trajectory: $z_n = z^* + \eta_n$, where η_n is small

$$\eta_{n+1} \sim f'(z^*)\eta_n \quad \rightarrow \quad |\eta_{n+1}| \sim |f'(z^*)||\eta_n|$$

$$|f'(z)| > 1 \quad \rightarrow \quad |\eta_{n+1}| > |\eta_n|$$

The perturbation **grows in time** \rightarrow the orbit is unstable!

How about the **other** closed orbits?

Ruling out stable limit cycles

Focus: sequence $\{z_n\}$ of maxima along a **presumed** closed orbit.

For the closed orbit sequence must eventually (period p) repeat:

$$z_{n+p} = z_n, \quad \forall n, \text{ some } p.$$

How does the perturbation change after a cycle?

$$\eta_{n+1} \sim f'(z_n)\eta_n$$

$$\eta_{n+2} \sim f'(z_{n+1})\eta_{n+1}$$

$$\sim f'(z_{n+1})[f'(z_n)\eta_n]$$

$$= [f'(z_{n+1})f'(z_n)]\eta_n$$

$$\eta_{n+p} \sim \left[\prod_{k=0}^{p-1} f'(z_{n+k}) \right] \eta_n \rightarrow |\eta_{n+p}| > |\eta_n| \rightarrow \text{Unstable orbit!}$$

$$|f'(z)| > 1, \quad \forall z$$

Complete proof of the strange attractor: Tucker (1999) *C. R. Acad Sci.* **328**, 1197.

Exploring parameter space

Many different scenarios can be obtained by changing parameters from the values $\sigma = 10$, $b = 8/3$ used by Lorenz and varying r .

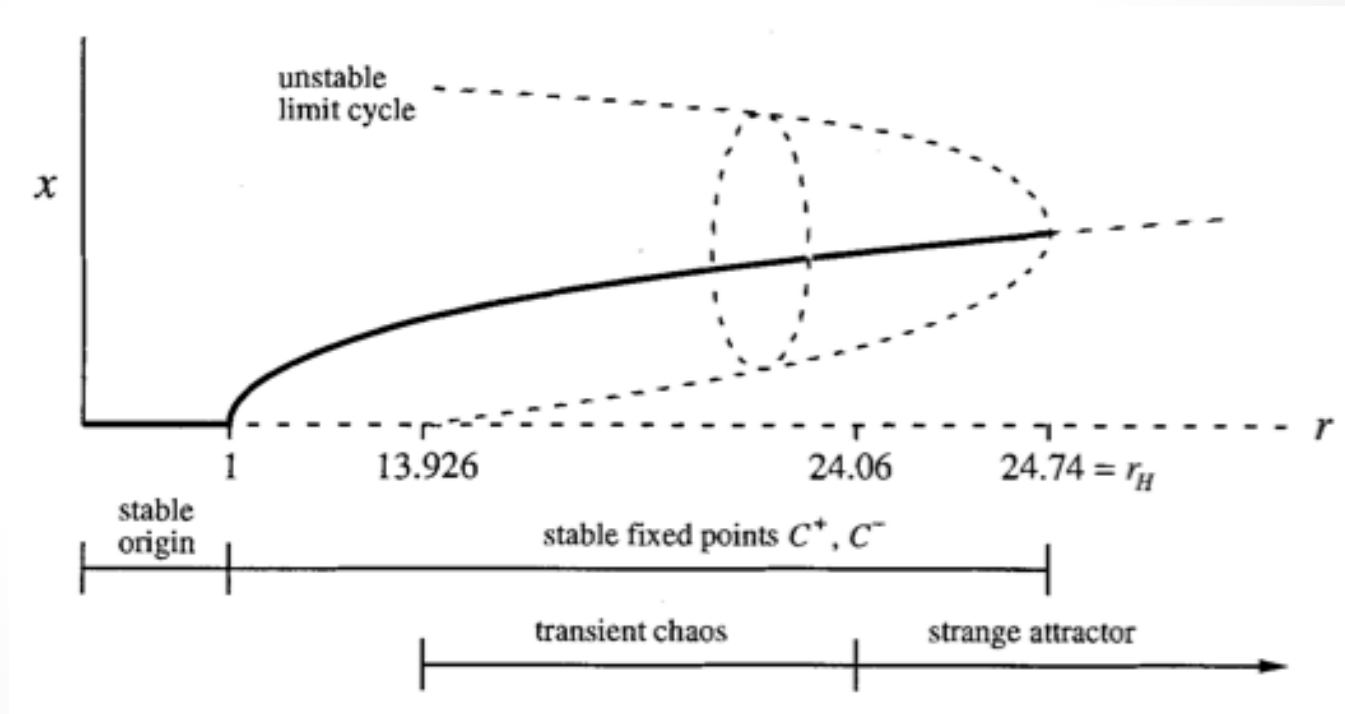

The origin is **globally stable** for $r < 1$; for $r > 1$ it **loses stability** due to a pitchfork bifurcation, which generates the **two symmetric stable fixed points** C^+ and C^- .

Exploring parameter space

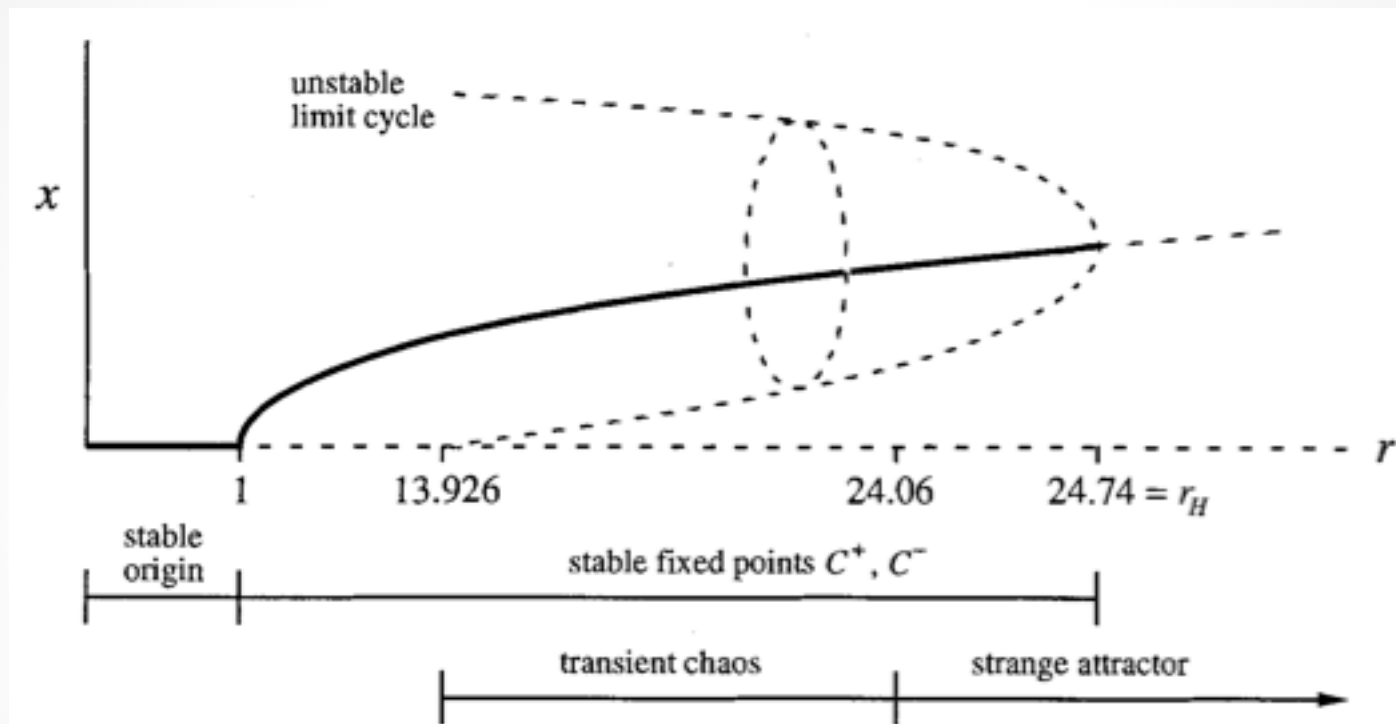

At $r_H = 24.74$ C^+ and C^- lose stability by **absorbing an unstable limit cycle in a subcritical Hopf bifurcation**.

Decreasing r from r_H , at $r = 13.926$ the cycles touch the saddle point (the origin) and become homoclinic orbits \rightarrow **homoclinic bifurcation**.

Below $r = 13.926$ there are **no limit cycles**.

Exploring parameter space

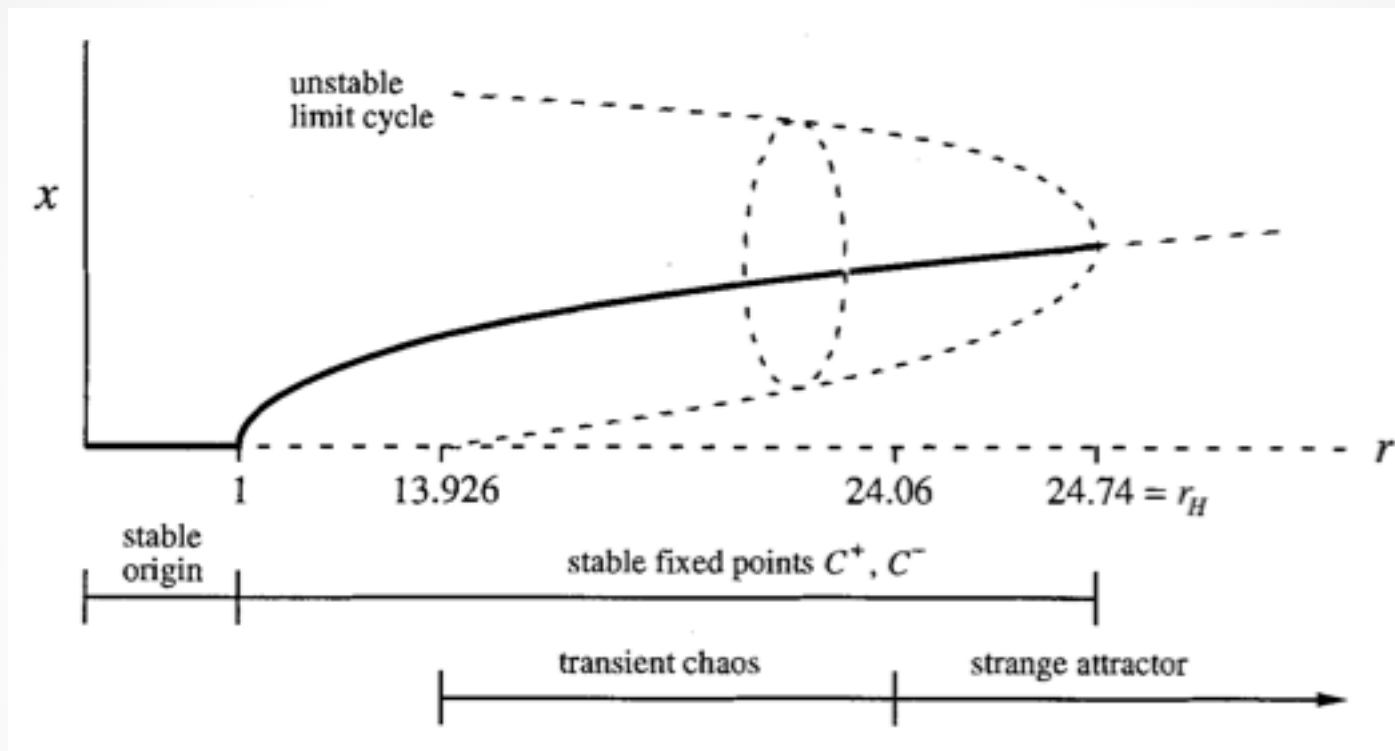

At $r = 13.926$ an **amazingly complicated invariant set** is born, along with the limit cycles, containing infinitely many saddle cycles and aperiodic orbits: but it is **not an attractor**, the system wanders chaotically in it for a while and eventually escapes towards C^+ or $C^- \rightarrow$ **transient chaos**.

Exploring parameter space

Transient chaos for $r = 21$: eventually the trajectory stays on the right and spirals down to equilibrium. Transient chaos is unpredictable: slight change in the initial conditions changes the outcome. However, there's no long-term aperiodicity, so the dynamics is not chaotic.

At $r = 24.06$ the time spent on this invariant set becomes **infinite** and the set becomes an **attractor**.

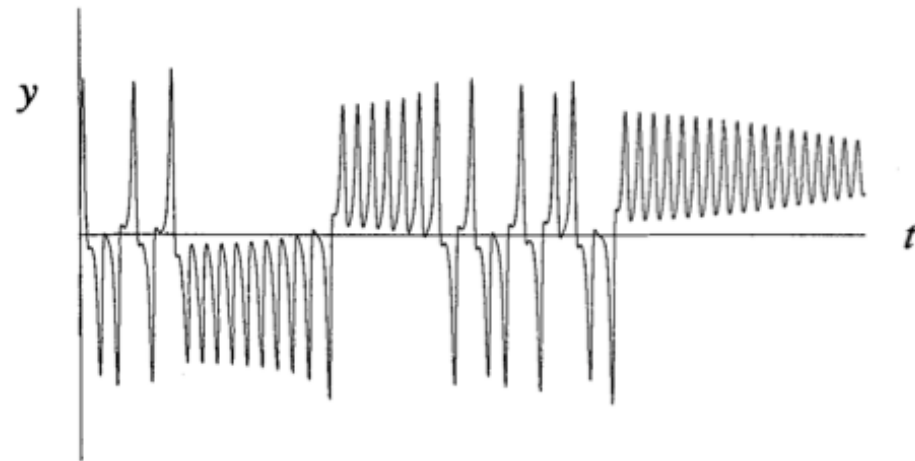
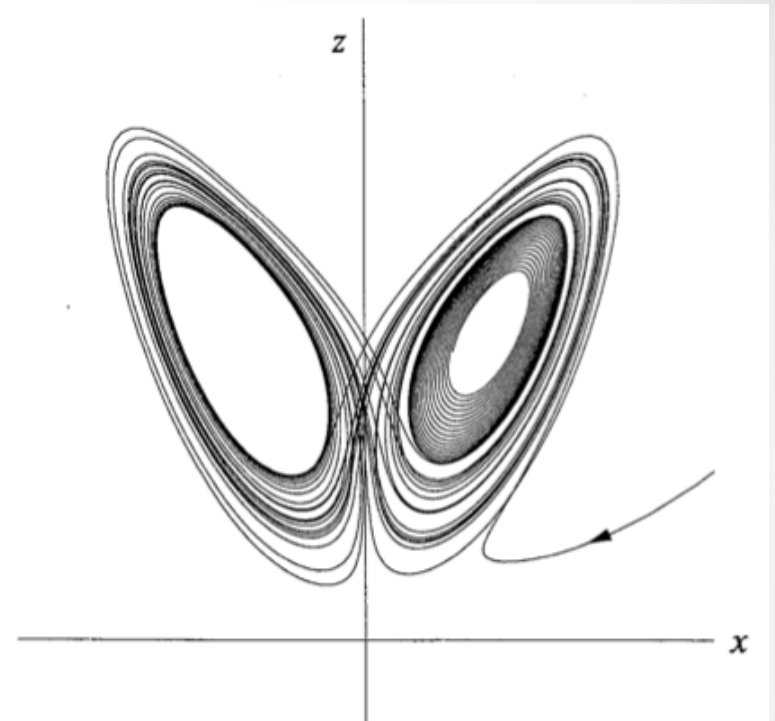

Exploring parameter space

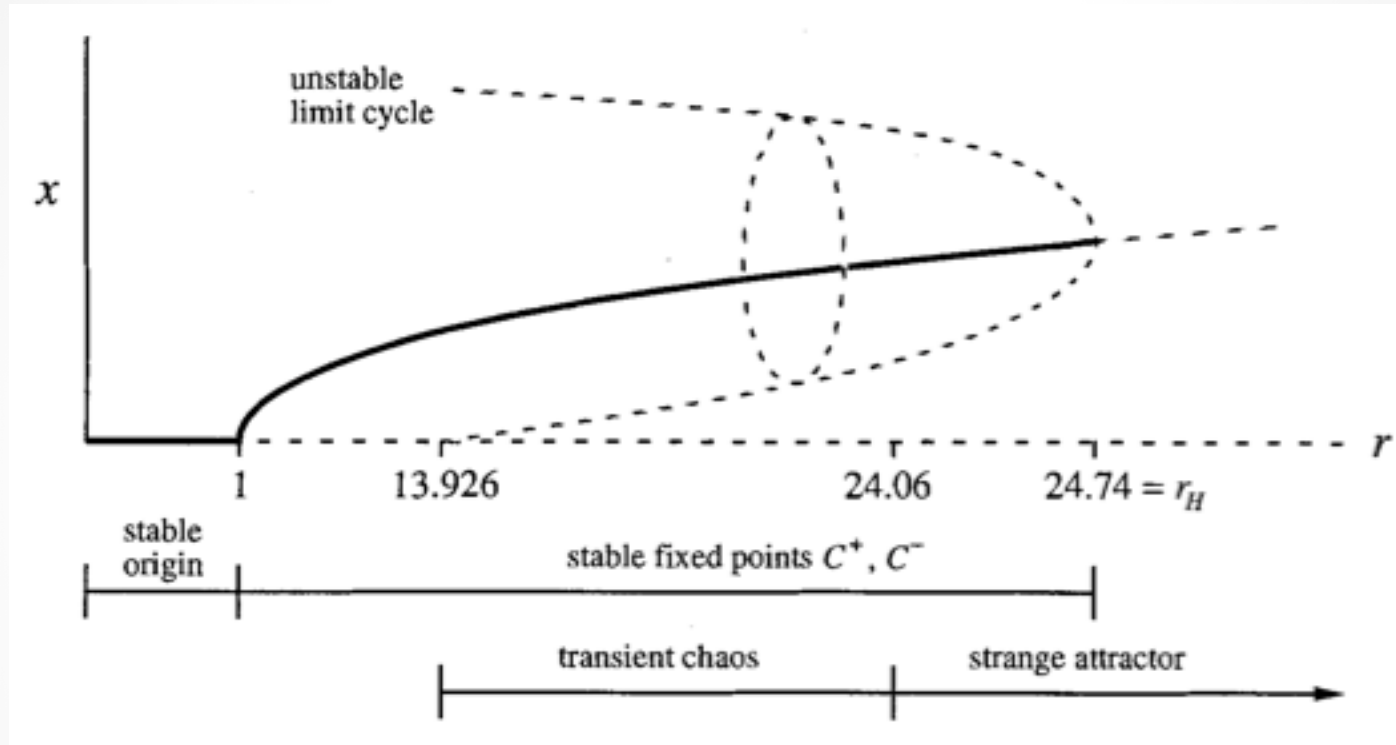

For $24.06 < r < 24.74$ there are **two types of attractors**: stable points and a strange attractor, the coexistence of which means that there's hysteresis between chaos and equilibrium when varying r back and forth past these endpoints.

Exploring parameter space

Question: What happens for large r ?

Answer: There's a globally attracting limit cycle for all $r > 313$.

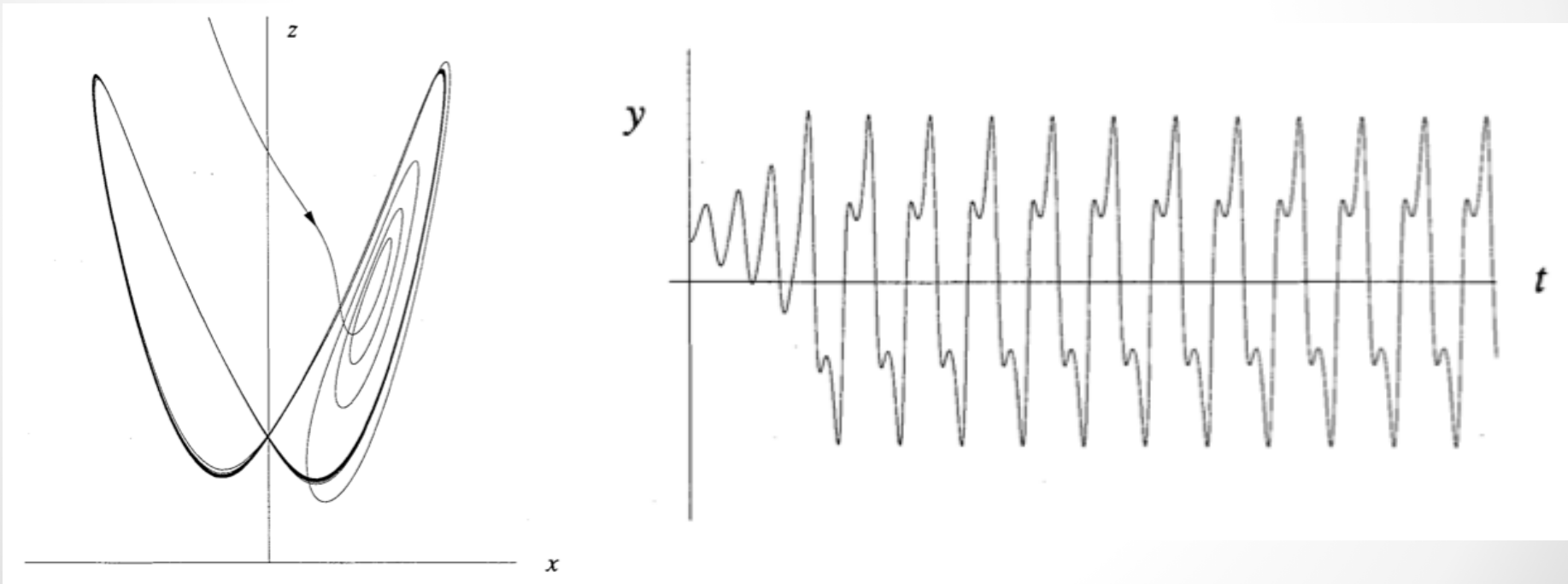

$$r = 350$$

Exploring parameter space

What happens for $28 < r < 313$?

- 1) For most r -values there's **chaos**.
- 2) Small **windows of periodic behavior**: the two largest windows are $99.524... < r < 100.795...$; $145 < r < 166$.
- 3) The alternating pattern of chaos and periodic motion is similar to that seen in the **logistic map**.